

SONY®

4-078-836-42(1)



**GRAND
WEGA**

Instruction Manual

GB

KF-50SX100U
KF-50SX100HK
KF-50SX100MN

©2001 by Sony Corporation

NOTICE FOR CUSTOMERS IN THE UNITED KINGDOM

A moulded plug complying with BS1363 is fitted to this equipment for your safety and convenience.

Should the fuse in the plug supplied need to be replaced, a 5 AMP fuse approved by ASTA or BSI to BS 1362 (i.e. marked with ⚡ or ⚡) must be used.

When an alternative type of plug is used it should be fitted with a 5 AMP FUSE, otherwise the circuit should be protected by a 5 AMP FUSE at the distribution board.

If the plug supplied with this equipment has a detachable fuse cover, be sure to attach the fuse cover after you change the fuse. Never use the plug without the fuse cover. If you should lose the fuse cover, please contact your nearest Sony service station.

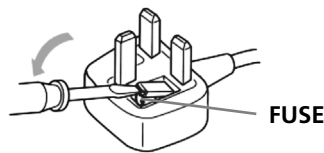

How to replace the fuse

Open the fuse compartment with a blade screwdriver, and replace the fuse.

• **IMPORTANT**

If the plug supplied is not suitable for the socket outlets in your home, it should be cut off and an appropriate plug fitted in accordance with the following instructions:

The wires in this mains lead are coloured in accordance with the following code:

Blue Neutral

Brown Live

As the colours of the wires in the mains lead of this apparatus may not correspond with the coloured markings identifying the terminals in your plug, proceed as follows:

The wire which is coloured blue must be connected to the terminal which is marked with the letter N or coloured black. The wire which is coloured brown must be connected to the terminal which is marked with the letter L or coloured red. Do not connect either wire to the earth terminal in the plug which is marked by the letter E or by the safety earth symbol \perp or coloured green or green and yellow.



WARNING



- To prevent shock hazard, do not insert the plug cut off from the mains lead into a socket outlet. This plug cannot be used and should be destroyed.
- To prevent fire or shock hazard, do not expose the unit to rain or moisture.
- Dangerously high voltages are present inside the set. Do not open the cabinet. Refer servicing to qualified personnel only.

Introduction

Thank you for choosing this Sony "Grand Wega" model.
Before operating the set, please read this manual thoroughly and retain it for future reference.

• Symbols used in the manual:

-  Informs you of possible hazards.
-  Important information.
-  Information on a feature.
- 1,2... Sequence of instructions.

-  Shaded buttons on the remote control show the buttons you have to press to follow the sequence of instructions.
-  Informs you of the result of the instructions.

Safety Information

 All TV's operate on extremely high voltages. To prevent fire or electric shock, please follow the safety guidelines indicated in the blue sheet supplied.

-  When moving the set two persons are needed. DO NOT push speaker nets placed on the both side of the screen to prevent these parts from deformation and do not grasp the front panels to prevent these parts from breaking off. Support screen bottom with one hand while grasping the top part with the other hand.
- Do not block or cover the ventilation opening placed on the left bottom rear side of the set. For ventilation, leave a space of at least 10 cm from the wall.
- After transporting the set directly from a cold to a warm location, or if the room temperature has changed suddenly, pictures may be blurred or show poor colour over portions of the picture. This is because moisture has condensed on the mirrors or lenses inside the set. Let the moisture evaporate before using the set.
- To obtain a clear picture, do not expose the screen to direct illumination or direct sunlight. If possible, use spot lighting directed down from the ceiling.
- This set incorporates the latest high-precision LCD technology. Even though the highest standards are applied in manufacture it is still possible that a few black dots or bright points (red, green or blue) may be visible on the screen under certain picture conditions. It is not possible to remove them and this is not a fault condition.
- The screen of this set has an anti-reflection screen coating. To avoid screen degradation, follow the mentioned below:
 - To remove dust from the screen surface, wipe with the supplied cleaning cloth or a soft cloth.
 - Clean the screen and cabinet with a soft dampened cloth. Do not use any abrasive cleaners. As a safety precaution, unplug the set before cleaning it.
 - Avoid touching the screen, and take care not to scratch the surface with hard objects.

Table of Contents

Notice for Customers in the United Kingdom.....	2
Introduction	3
Safety Information.....	3
Overview	
Checking the Accessories Supplied.....	4
Overview of TV Buttons	4
Overview of Remote Control Buttons.....	5
Installation	
Inserting Batteries into the Remote Control.....	6
Connecting the Aerial and VCR	6
Stabilizing the set	6
First Time Operation	
Switching on the set and Automatically Tuning.....	7
Menu System	
Changing the Screen Format	9
Introducing the Menu System.....	9
On Screen display Menus Guide	10
Using the Menu System:	
Adjusting the Picture	11
Adjusting the Sound	12
Using the Features menu.....	14
Manually Tuning the TV	15
Labelling a channel	16
Skipping programme positions.....	17
Using the "Further Programme Preset" function.....	18
Inputting your personal ID.....	19
Using the Demo Mode.....	20
Adjusting the H Centre picture for an RGB source.....	21
Labelling and Selecting the screen format of Input Sources	22
Using Multi PIP (Picture In Picture).....	23
Using PAP (Picture And Picture).....	23
Teletext	24
NexTVView	26
Optional Connections	
Connecting Optional Equipment.....	28
Using Optional Equipment.....	29
Smartlink	30
Remote Control of other Sony Equipment	30
Additional Information	
Optimum Viewing Area	31
Replacing the Lamp.....	32
Specifications	33
Troubleshooting	34
Television Channel Number Guide for United Kingdom	35

Overview

Checking the Accessories Supplied



One Remote Control (RM-903)



Two batteries (R6 type)



2 Brackets



1 Wrench

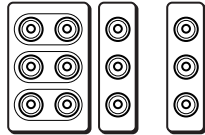

Scart connector adapters (only for KF-50SX100HK and KF-50SX100MN)



2 Screws



1 Cleaning cloth

Overview of TV Buttons

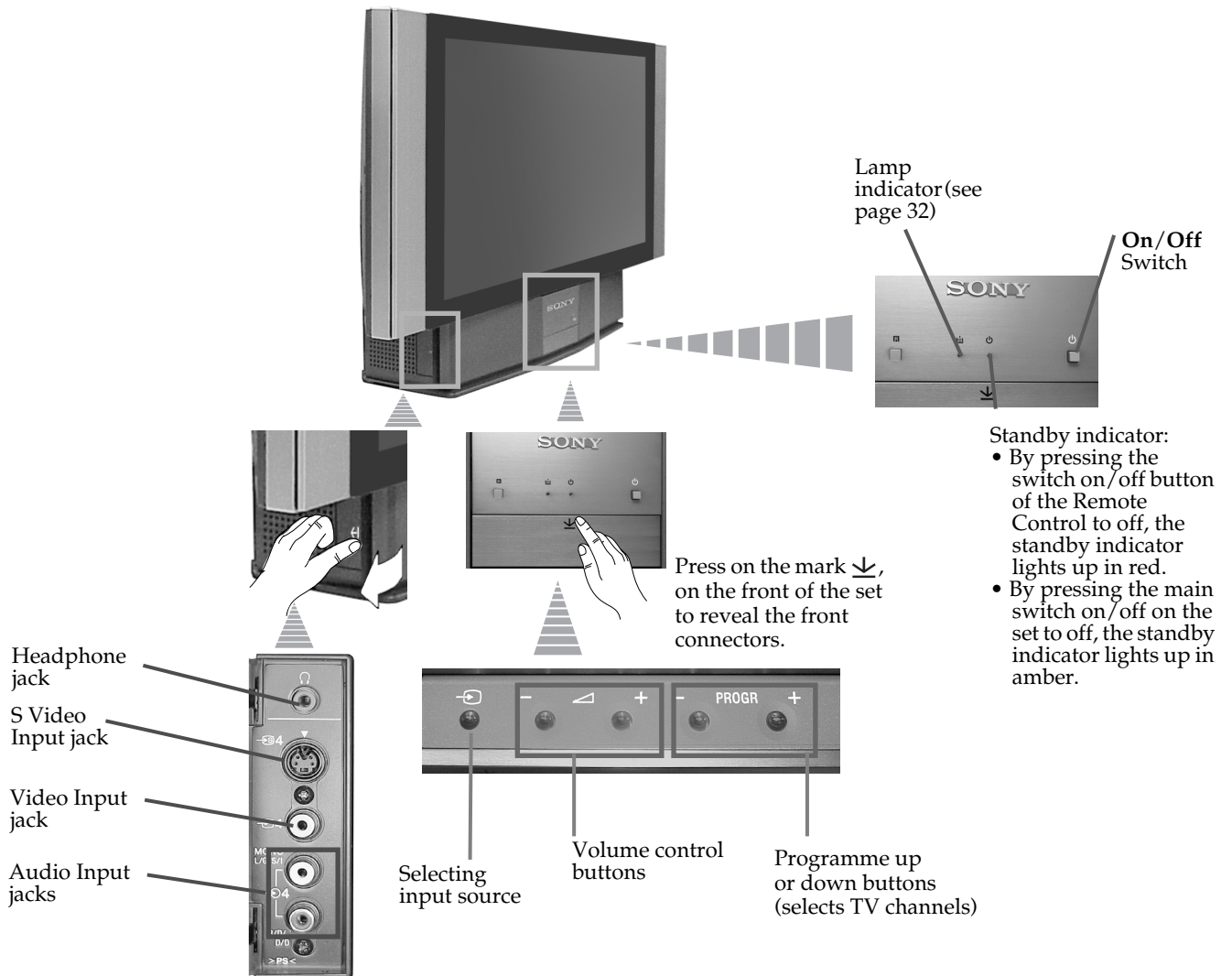

Overview of Remote Control Buttons

Resetting to factory set levels

Press to return the picture and sound settings to the factory set levels. This will also return the set to the install condition, the "Auto Tuning" menu will appear on the screen, refer to the section "Switching on the set and automatically Tuning" (step 4) of this manual.

Displaying the time

Press to switch the time on or off (available only when teletext is broadcast).

VCR operation

For more details, please refer to the section "Remote Control of other Sony Equipment".

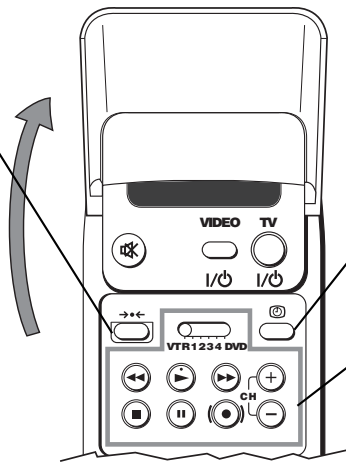

VCR on/off

Press to switch your VCR on or off.

Muting the Sound

Press to mute TV sound.
Press again to restore the sound.

Selecting TV mode

Press to switch off Teletext or video input.

PAP (Picture And Picture)

For more details, please refer to the section "Using PAP (Picture And Picture)".

Selecting Teletext

Press to switch on Teletext.

Displaying EPG

Press to display the Electronic Programme Guide (EPG). Press again to switch off EPG.

Freezing the picture

Press to freeze the picture. Press again to return to the normal picture.

Selecting channels

Press to select channels.

For double-digit programme numbers, e.g. 23, press -/-- first, then the buttons 2 and 3. If you enter an incorrect first digit, this should be corrected by entering another digit (0-9) and then selecting -/-- button again to enter the programme number of your choice.

Selecting Sound mode

Press repeatedly to change the sound mode.

Selecting Picture mode

Press repeatedly to change the picture mode.

Adjusting TV Volume

Press to adjust the volume of the TV.

To Temporarily Switch Off

Press to temporarily switch off TV (the standby indicator  on the set lights up in red). Press again to switch on TV from standby mode.

 After 15-30 minutes without a signal and without any button being pressed, the set switches automatically into standby mode.

Displaying On Screen Information

Press to display all on-screen indications. Press again to cancel.

Selecting Input source

Press repeatedly until the desired input symbol of the source appears on the screen.

Back to the channel last watched

Press to watch the last channel selected (watched for at least 5 seconds).

Selecting Screen format

Press repeatedly to change the format of the screen (for more details, please refer to the section "Changing the Screen format").

Displaying Multi PIP (Picture In Picture)

Press to display Multi PIP mode. Press again to cancel.

Joystick for menu selection

- When MENU is switched on:
 - ▲ Scroll Up
 - ▼ Scroll Down
 - ◀ Previous menu or selection
 - ▶ Next menu or selection
 - OK Confirms your selection
- When MENU is switched off:
 - ◀ Return to the last menu screen.
 - OK Shows a channel overview

Selecting channels

Press to select the next or previous channel.

Displaying the menu system

Press to display the menu on the screen. Press again to remove the menu display from the screen.

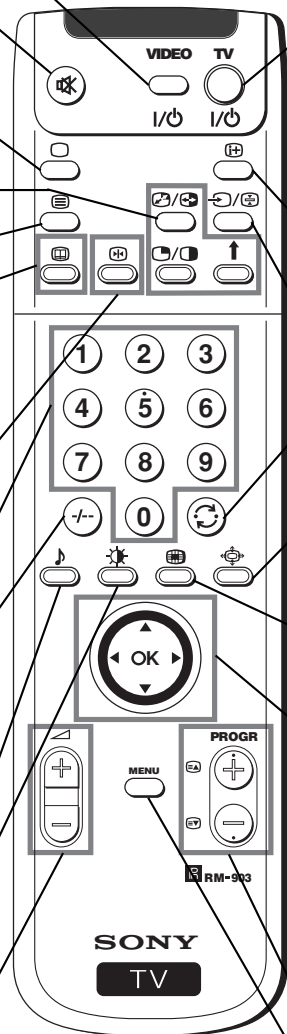

GB

 Besides TV functions, all coloured buttons as well as green symbols are also used for Teletext operation. For more details, please refer to the "Teletext" section of this instruction manual.

Installation

Inserting Batteries into the Remote Control

- ⚠ Make sure you insert the batteries using the correct polarities. Always remember to dispose of used batteries in an environmental friendly way.

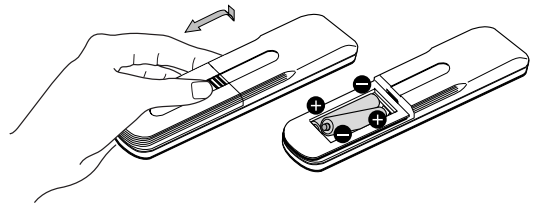

Connecting the Aerial and VCR

- ⓘ Connecting cables are not supplied.

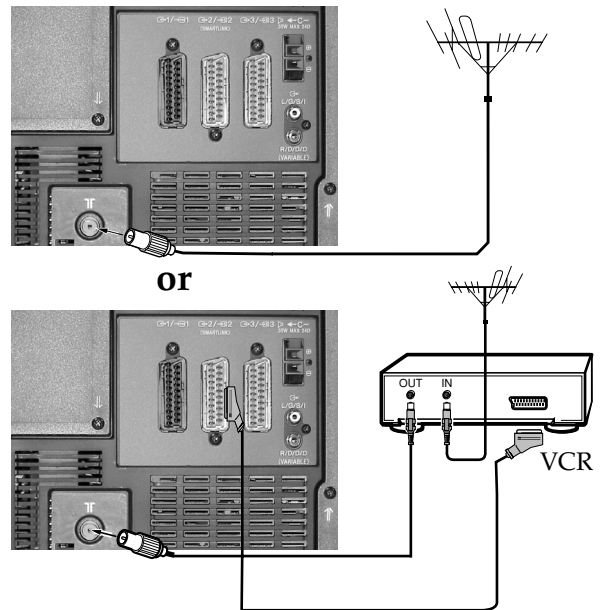
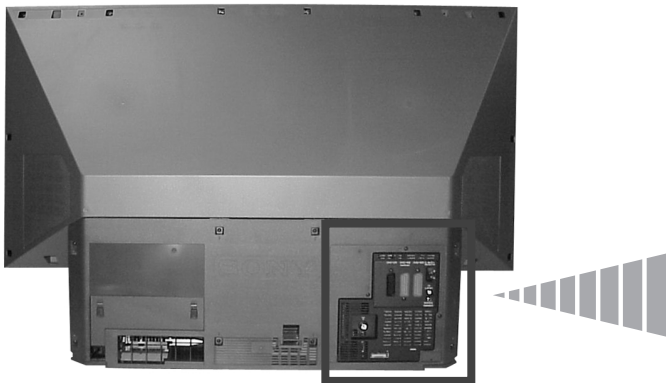

- ⓘ The Scart lead is optional. If you use this optional connection it can improve picture and sound quality when using a VCR.
- ⚠ If you do not use a SCART lead, after automatically tuning the set refer to the "Manually Tuning the TV" section of this instruction manual, to tune in the set to the output of your VCR. Also refer to your VCR instruction manual to find out how to find the output channel of your VCR.

Stabilizing the set

- ⓘ After setting up, secure the set to a wall, etc., with the supplied brackets, for safety purposes.

1 Mount the two supplied brackets with the screws to the upper rear side of the set.

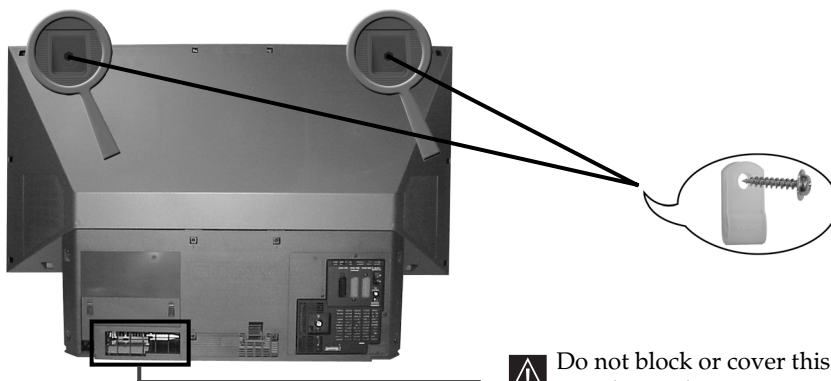

- ⚠ Do not block or cover this ventilation opening. For ventilation, leave a space of at least 10 cm from the wall.

2 Pass a strong cord or a chain through each bracket mounted in 1, and then secure to a wall or a pillar, etc.

First Time Operation

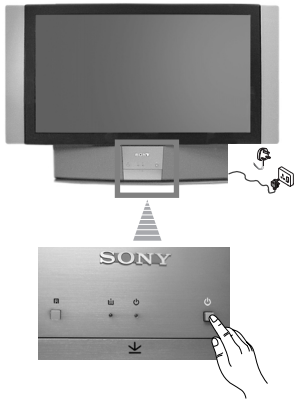

Switching on the set and Automatically Tuning

i The first time you switch on your TV, a sequence of menu screens appear on the TV enabling you to 1) choose the language of the menu screen, 2) choose the country in which you wish to operate the set, 3) search and store all available channels (TV Broadcast) and 4) change the order in which the channels (TV Broadcast) appear on the screen. However, if you need to change the language menu, change the country, change or repeat the tuning (e.g. when you move house) or rearrange the order of the channels, you can do that by selecting the appropriate menu in the  (Set Up).



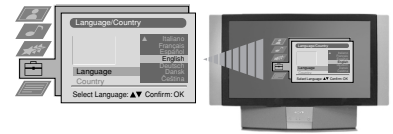

1 Connect the set plug to the mains socket (220-240V AC, 50 Hz). Press the  on/off button on your set to switch on. The first time you press this button the **Language/Country** menu displays automatically on the screen.

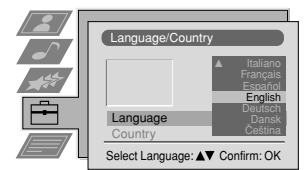

2 Push the joystick on the remote control  or  to select the language, then press **OK** to confirm your selection. From now on all the menus will appear in the selected language.



3 Push the joystick  or  to select the country in which you will operate the set, then press **OK** to confirm your selection.

i Select "Off" instead of a country if you do not want your channels (TV Broadcasts) stored in a given channel sequence starting from programme position 1.

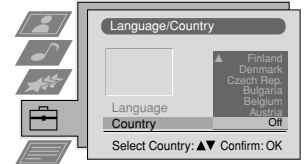

GB

4 The Auto Tuning menu appears on the screen in the selected language, then press the **OK** button on the remote control to select **Yes**.

Do you want to start automatic tuning?

Yes: **OK** No: 

5 A new menu appears automatically on the screen asking you to check that the aerial is connected. Confirm that the aerial is connected and then press the **OK** button to start the automatic tuning.

Please confirm that aerial is connected!

Yes: **OK** No: 

- i** The TV starts to automatically search and store all available channels (TV Broadcast) for you.
- If you have selected the "Off" option in the Country menu and you activate autotuning again, the TV Broadcasts will be stored from the programme number selected at that time.

⚠ This procedure could take some minutes. Please, be patient and do not press any button. Otherwise the automatic tuning will not be completed.

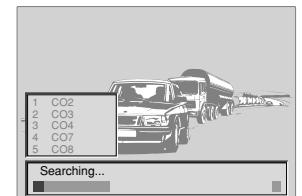

continued...

First Time Operation



6  After all available channels are captured and stored, the Programme Sorting menu appears automatically on the screen enabling you to change the order in which the channels appear on the screen.

a) If you do not wish to change the channel order, go to step 7.

b) If you wish to change the channel order:

1 Push the joystick on the remote control **▼** or **▲** to select the programme number with the channel (TV Broadcast) you wish to rearrange, then push **▶** to enter.

2 Push the joystick **▼** or **▲** to select the new programme number position for your selected channel (TV Broadcast), then press **OK**.

 The selected channel now moves to its new programme position and the other channels move accordingly.

3 Repeat steps b1) and b2) if you wish to change the order of the other channels.

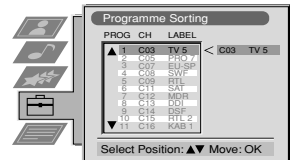
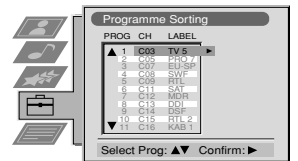

7 Press the **MENU** button to exit and return to the normal TV screen.

 The set is now ready for use.

Menu System

Changing the Screen Format

i This feature allows you to change the size of the TV picture.



1 Press the  button on the remote control repeatedly to select one of the following formats.

- Smart:** imitation of wide screen effect for 4:3 broadcast.
- 4:3:** conventional 4:3 picture size, full picture information.
- 14:9:** compromise between 4:3 and 16:9 picture size.
- Zoom:** widescreen format for letterbox movies.
- Wide:** for 16:9 broadcast.

In **Smart**, **Zoom** and **14:9** modes parts of the top and bottom of the screen are cut off. Press **▼** or **▲** to adjust the position of the image on screen (eg to read subtitles).

2 Press the **OK** button to confirm your selection.

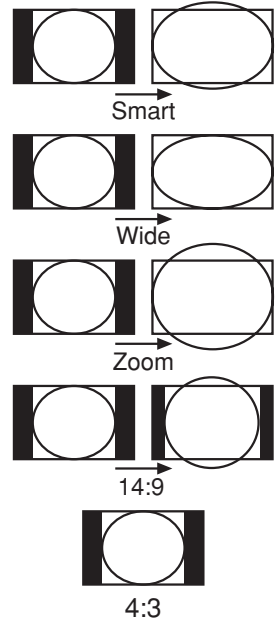

GB

Introducing the Menu system

i Your set uses an on-screen menu system to guide you through the operations. Use the following buttons on the Remote Control to operate the menu system:



1 Press the **MENU** button to switch the first level menu on.



- 2**
- To highlight the desired menu or option, push the joystick **▲** or **▼**.
 - To enter to the selected menu or option, push **▶**
 - To return to the last menu or option, push **◀**.
 - To alter settings of your selected option, push **▼/▲/◀** or **▶**.
 - To confirm and store your selection, press **OK**.

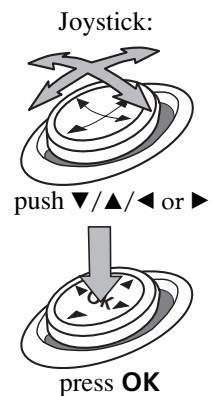

3 Press the **MENU** button to remove the menu from the screen.

On Screen display Menu Guide

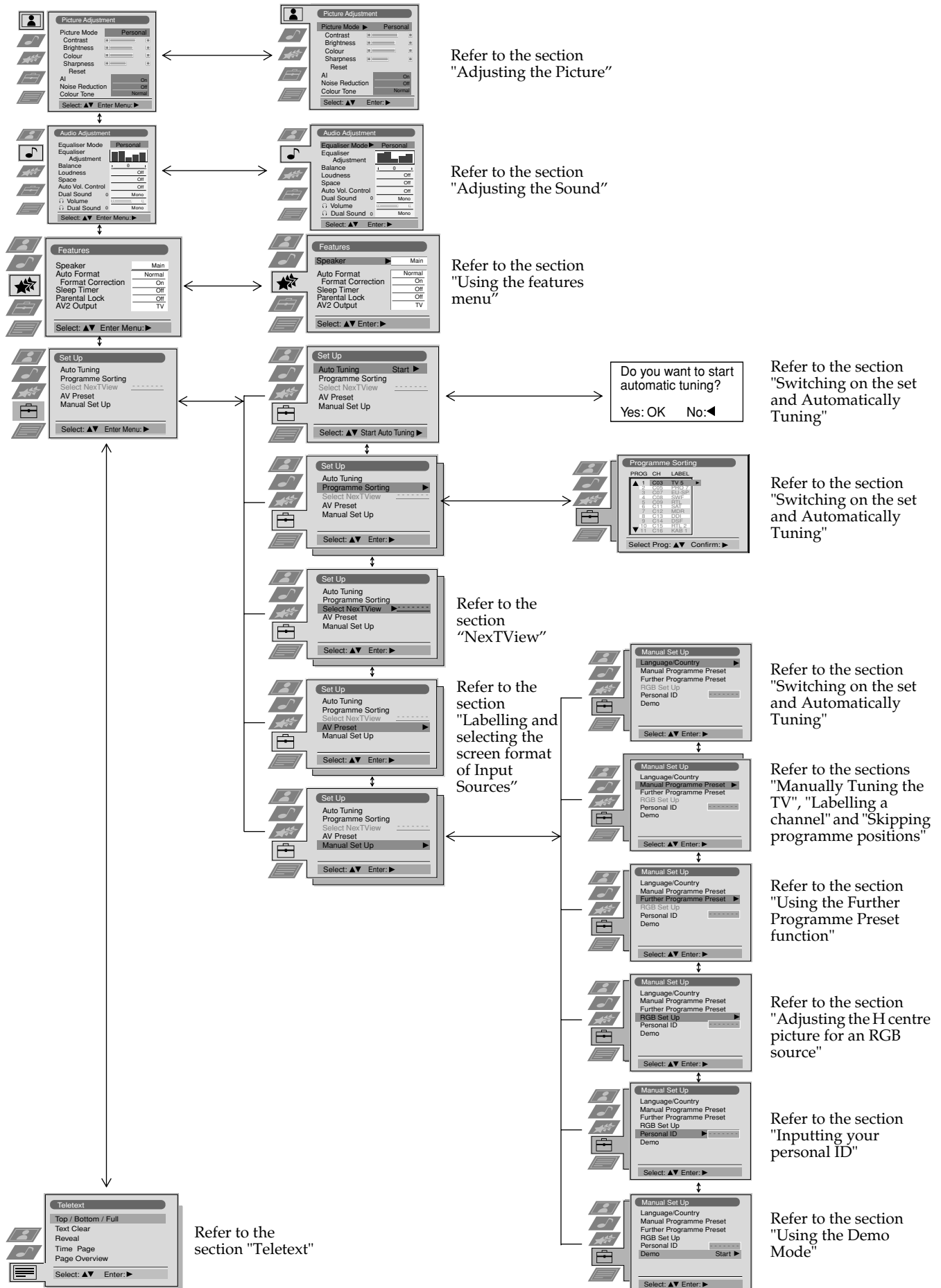

Adjusting the Picture

i Although the picture is adjusted at the factory, you can modify it to suit your own taste.



1 Press the **MENU** button on the remote control to display the menu on the screen.

2 Push the joystick **▶** to enter the **Picture Adjustment** menu.

3 Push the joystick **▼** or **▲** to select the item you wish to change, then push **▶** to enter. Refer to the table below to choose the item and for the effect of each control:

Picture Mode	<ul style="list-style-type: none"> ▼ Live (for live broadcast programmes) Personal (for individual settings) Movie (for films) ▲ Game (for computer games)
Contrast	◀ Less ▶ More
Brightness*	◀ Darker ▶ Brighter
Colour*	◀ Less ▶ More
Sharpness*	◀ Softer ▶ Sharper
Hue**	◀ Reddish ▶ Greenish
Reset	Ⓞ Resets picture to the factory preset levels.
AI (Artificial Intelligence)	<ul style="list-style-type: none"> ▲ Off: Normal ▼ On: Automatic optimization of contrast level according to the TV signal
Noise Reduction	<ul style="list-style-type: none"> ▼ High: High noise reduction. Mid: Medium noise reduction. Low: Low noise reduction. Auto: Optimum noise reduction automatically selected. ▲ Off: No noise reduction.
Colour Tone	<ul style="list-style-type: none"> ▼ Warm: Gives a warm tint to the picture. Normal: Normal. ▲ Cool: Gives a cool tint to the picture.

* Can only be altered if Personal Picture Mode is selected.
 ** Only available for NTSC colour signal (e.g: USA video tapes).

4 Push the joystick **▲**, **▼**, **◀** or **▶** to alter the selected item, then press the **OK** button to store the new adjustment.

5 Repeat steps 3 and 4 to alter the other items.

6 Press the **MENU** button to exit and return to the normal TV screen.

Changing the Picture Mode Quickly

i You can quickly change the Picture Mode without entering the Picture Control menu screen.

1 Press the **Picture Mode** button on the remote control repeatedly to directly access and select your desired picture mode (**Live**, **Personal**, **Movie**, or **Game**).

2 Press the **OK** button to remove the display from the screen.

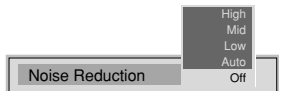
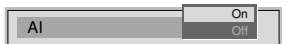
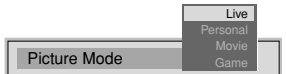
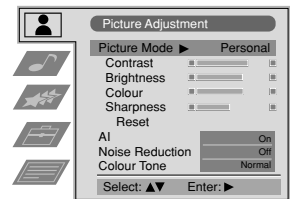
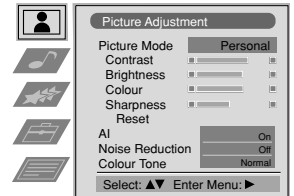

GB

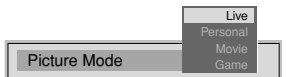

Adjusting the Sound

i Although the sound is adjusted at the factory, you can modify it to suit your own taste.



1 Press the **MENU** button on the remote control to display the menu on the screen.

2 Push the joystick **▼** to select the **♪** symbol, then push **▶** to enter to the **Audio Adjustment** menu.

3 Push the joystick **▼** or **▲** to select the item you wish to change, then push **▶** to enter. Refer to the table below to choose the item and for the effect of each control:

Equaliser Mode ▼ **Personal** (for individual settings)
Vocal
Jazz
Rock
Pop
▲ Flat (fixed setting, cannot be adjusted)

***Equaliser Adjustment** Push to **▶** or **◀** to select the frequency band you want to alter and push to **▼** or **▲** to adjust. Finally, press the **OK** button to store the new adjustment.

Balance ◀ Left ▶ Right

Loudness ▼ **Off**: normal
▲ On: for music broadcasts

Space ▼ **Off**: normal
▲ On: acoustic sound effect

Auto Vol. Control ▼ **Off**: volume level changes according to the broadcast signal
▲ On: volume level of the channels will stay the same independent of the broadcast signal (e.g. in case of advertisement)

Dual Sound

- For a stereo broadcast:
 ▼ **Mono**
 ▲ **Stereo**
- For a bilingual broadcast:
 ▼ **Mono** (for mono channel if available)
 ▲ **A** (for channel 1)
 ▲ **B** (for channel 2)

Headphones:
Volume ◀ Less ▶ More

Dual Sound

- For a stereo broadcast:
 ▼ **Mono**
 ▲ **Stereo**
- For a bilingual broadcast:
 ▼ **Mono** (for mono channel if available)
 ▲ **A** (for channel 1)
 ▲ **B** (for channel 2)
 ▲ **PAP** (only when PAP is switched on)

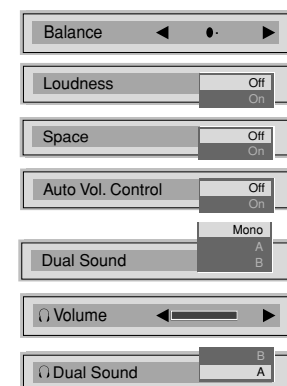
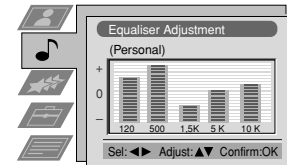
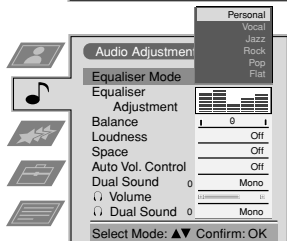
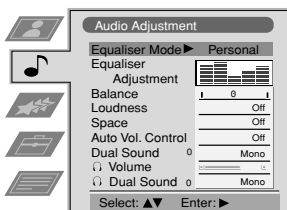
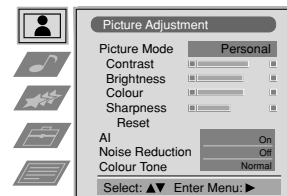

* Can only be permanently stored if Personal Equaliser Mode is selected, the other modes (Vocal, Jazz, Rock or Pop) store until the next mode change.

continued...



- 4 Push the joystick **▼**, **▲**, **◀** or **▶** to alter the selected item, then press the **OK** button to store the new adjustment.
- 5 Repeat steps 3 and 4 to alter the other items.
- 6 Press the **MENU** button to exit and return to the normal TV screen.

Changing Sound Mode Quickly

i You can quickly change Sound mode without entering the Sound Control menu screen.

- 1 Press the **♪** button on the remote control repeatedly to directly access and select your desired sound mode (**Personal**, **Vocal**, **Jazz**, **Rock**, **Pop** or **Flat**).
- 2 Press the **OK** button to remove the display from the screen.

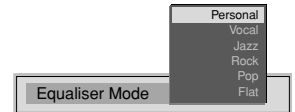

Using the Features Menu

- i** Using the Features menu you can:
- Select if you want to listen to the sound from the set directly or through an external amplifier.
 - Adjust automatically the size of picture.
 - Select a time period after which the set switches itself into standby mode.
 - Lock the buttons on the set. In this way, the set only works by using the remote control buttons.
 - Select the source to be output from the Scart connector $\text{C} \rightarrow 2 / \text{C} \rightarrow 2$ (SMARTLINK). In this way you can record from this scart connector while watching another source. If your VCR supports Smartlink, this procedure is not necessary.



- Press the **MENU** button on the remote control to display the menu on the screen.
- Push the joystick \blacktriangledown to select the \star symbol, then push \blacktriangleright to enter to the **Features** menu.
- Push the joystick \blacktriangledown or \blacktriangle to select the desired menu item, then push \blacktriangleright to enter (see the table below for the effect of each menu item).
- Push \blacktriangledown or \blacktriangle to select the desired setting and press the **OK** button to store.
- Press the **MENU** button to exit and return to the normal TV screen.

Features	Effect / Operation
Speaker	<ul style="list-style-type: none"> \blacktriangledown Main (sound from the set) \blacktriangle Centre In (sound from external amplifier)
Auto Format (only for aerial signal)	<ul style="list-style-type: none"> \blacktriangledown Off: Size of picture is not automatically adjusted. Normal: Size of picture is automatically adjusted according to the broadcaster information. \blacktriangle Full: The set automatically adjusts the picture size to eliminate any dark areas on the TV picture (as shown on the section "Changing the Screen Format").
Format Correction (only if Auto Format is set to "Normal" or "Full")	<ul style="list-style-type: none"> \blacktriangledown Off: 4:3/14:9 is selected. \blacktriangle On: Smart mode is selected automatically for 4:3/14:9 broadcast.
Sleep Timer	<ul style="list-style-type: none"> \blacktriangle Off 10 min. 20 min. ... 90 min.
	<ul style="list-style-type: none"> i One minute before the set switches into standby mode, the time remaining is displayed on the screen automatically. When watching the TV, press the + button on the remote control to display the time remaining. To return to normal operation from standby mode, press the TV I/O button on the remote control.
Parental lock	<ul style="list-style-type: none"> \blacktriangledown Off (Normal mode) \blacktriangle On (The set can only be switched on using the remote control, the buttons on the TV do not work)
AV2 Output	<ul style="list-style-type: none"> \blacktriangledown TV (audio/video signal from the aerial) AV1 (audio/video signal from the Scart connector $\text{C} \rightarrow 1 / \text{C} \rightarrow 1$). AV2 (audio/video signal from the Scart connector $\text{C} \rightarrow 2 / \text{C} \rightarrow 2$ (SMARTLINK)). AV3 (audio/video signal from the Scart connector $\text{C} \rightarrow 3 / \text{C} \rightarrow 3$). \blacktriangle AV4 (audio/video signal from the connector $\text{C} \rightarrow 4$ placed in the front of the set).

A If you have connected a decoder, please remember to change back the AV2 Output to "TV" for correct unscrambling.

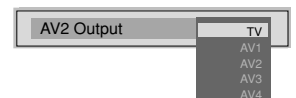
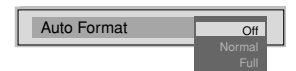
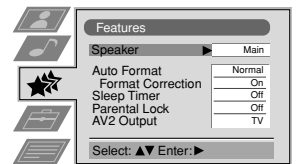
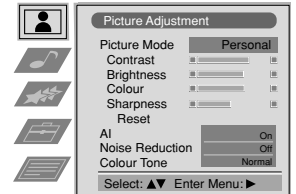

Manually Tuning the TV

i Use this function to preset channels (TV Broadcast) or a video input source one by one to the programme order of your choice.



- 1** Press the **MENU** button on the remote control to display the menu on the screen.
- 2** Push the joystick **▼** to select the symbol, then push **▶** to enter the **Set Up** menu.
- 3** Push the joystick **▼** or **▲** to select **Manual Set Up**, then push **▶** to enter.
- 4** Push the joystick to **▼** or **▲** to select **Manual Programme Preset**, then push **▶** to enter.
- 5** Push the joystick **▼** or **▲** to select on which programme number you want to preset a channel (for VCR select programme number "0"), then push twice **▶**. The column **SYS** is highlighted.
- 6** Push the joystick **▼** or **▲** to select the system for TV Broadcast and VCR channel (**B/G** for western european countries, **L** for France, **I** for Great Britain or **D/K** for eastern european countries) or a external input source (**EXT**), then push **▶**. The column **CH** is highlighted.
- 7** Push the joystick **▼** or **▲** to select the channel tuning, "**C**" for terrestrial channels (for TV Broadcast or VCR channel), "**S**" for cable channels or **F** for, direct frequency input then push **▶**.
- 8**
 - a) If you know the channel number of the TV Broadcast, the VCR test signal channel or the frequency, press the number buttons to enter directly the channel number. Then press the **OK** button to store.
 - b) If you do not know the channel number, push the joystick **▼** to select **SEARCH** and the set starts automatically to search for the next available TV Broadcast channel or the channel of the VCR signal. Then press the **OK** button to store or push **▼** to continue searching the desired channel.
 - c) For external input sources (**EXT**), push **▼** to select the input source where you have connected your equipment (**AV1**, **AV2**, **AV3** or **AV4**). Then press the **OK** button to store.
- 9** Repeat steps 4 to 8 a), b) or c) if you wish to store more channels.
- 10** Press the **MENU** button to exit and return to the normal TV screen.

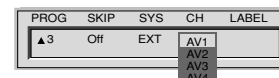
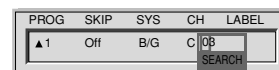
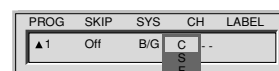
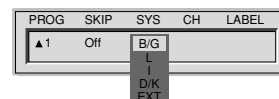
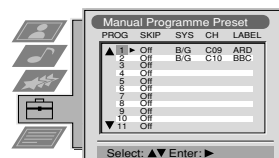
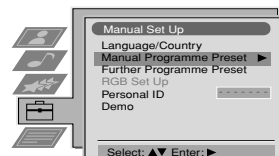
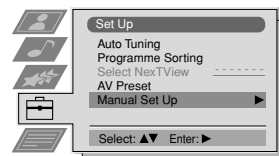
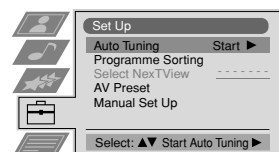
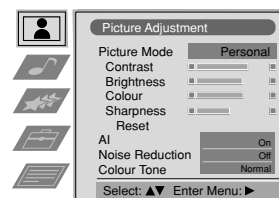

GB

The set is now ready for use.

Labelling a channel

1 Names for channels (TV Broadcasts) are usually taken automatically from Teletext if available. You can however name a channel or an input video source using up to five characters (letters or numbers). Using this function, you can easily identify which channel (TV Broadcasts) or video source you are watching.



- 1** Press the **MENU** button on the remote control to display the menu on the screen.
- 2** Push the joystick **▼** to select the  symbol, then push **▶** to enter the **Set Up** menu.
- 3** Push the joystick **▼** or **▲** to select **Manual Set Up**, then push **▶** to enter.
- 4** Push the joystick **▼** or **▲** to select **Manual Programme Preset**, then push **▶** to enter.
- 5** Push the joystick **▼** or **▲** to select the programme number with the channel you wish to name.
- 6** Push the joystick **▶** repeatedly until the first element of the **LABEL** column is highlighted.
- 7** Push the joystick **▼** or **▲** to select a letter, number, "+" or a blank, then push **▶** to confirm this character. Select the other four characters in the same way.
- 8** After selecting all the characters, press the **OK** button.
- 9** Repeat steps 5 to 8 if you wish to label other channels.
- 10** Press the **MENU** button to exit and return to the normal TV screen.

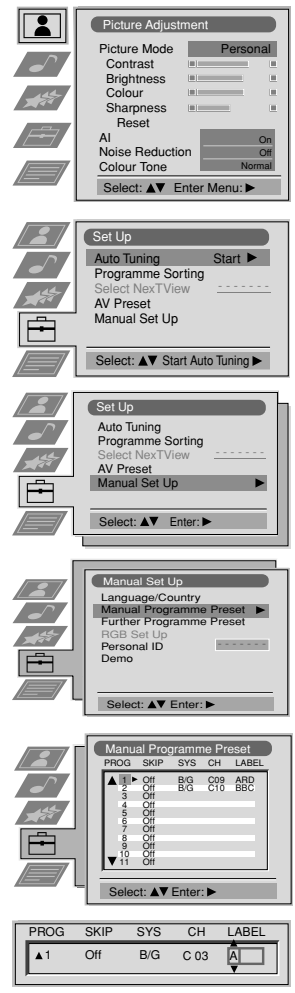

 When you select a named channel, the name appears for a few seconds on the screen.

Skipping Programme positions

i You can programme this set to skip any unwanted programme numbers when they are selected with the **PROGR +/-** buttons. To cancel this function afterwards, proceed in the same way as described below by selecting **Off** instead of **On** in step 6.



1 Press the **MENU** button on the remote control to display the menu on the screen.

2 Push the joystick **▼** to select the  symbol, then push **▶** to enter the **Set Up** menu.

3 Push the joystick **▼** or **▲** to select **Manual Set Up**, then push **▶** to enter.

4 Push the joystick **▼** or **▲** to select **Manual Programme Preset**, then push **▶** to enter.

5 Push the joystick **▼** or **▲** to select the programme position you want to skip, then push **▶** to enter the **SKIP** column.

6 Push the joystick **▼** to select **On**, then press the **OK** button to store.

7 Repeat steps 5 and 6 to skip other unused programme positions.

8 Press the **MENU** button to exit and return to the normal TV screen.

 When changing channels (TV Broadcasts) with the **PROGR +/-** buttons, the skipped programme positions do not appear. You can, however, still select them using the number buttons.

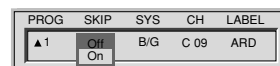
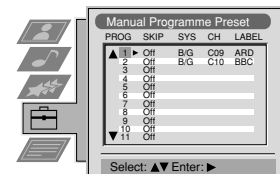
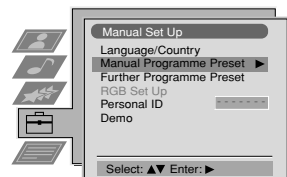
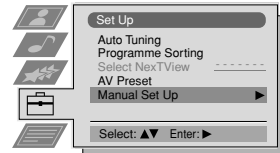
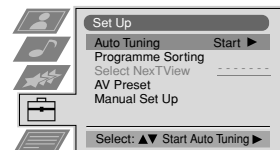
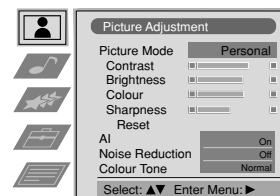

GB

Using the "Further Programme Preset" function

- 1** With this feature you can:
- a) Individually attenuate the strength of a channel signal in case of a strong local aerial signal (striped picture).
 - b) Individually adjust the volume level of each channel.
 - c) Normally the automatic fine tuning (AFT) is operating, however you can manually fine-tune the TV to obtain better reception if the picture is distorted.
 - d) Preset the AV output for the programme positions of channels with scrambled signals (eg from a pay TV decoder). In this way a connected VCR records the unscrambled signal.



- 1** Press the **MENU** button on the remote control to display the menu on the screen.
 - 2** Push the joystick **▼** to select the symbol, then push **▶** to enter the **Set Up** menu.
 - 3** Push the joystick **▼** or **▲** to select **Manual Set Up** then push to **▶** to enter.
 - 4** Push the joystick **▼** or **▲** to select **Further Programme Preset**, then push to **▶** to enter.
 - 5** Push the joystick **▼** or **▲** to select the relevant programme number, then push **▶** repeatedly to select:
 - a) **ATT** (RF attenuator)
 - b) **VOL** (Volume Offset)
 - c) **AFT** (Automatic Fine Tuning) or
 - d) **DECODER**

The selected item changes colour.
 - 6**
 - a) **ATT**
Push the joystick **▼** to select **On**, then press the **OK** button. Repeat steps 5 and 6 a) to attenuate other channels.
 - b) **VOL**
Push the joystick **▼** or **▲** to adjust the volume level of the channel over a range of -7 to +7, then press the **OK** button. Repeat steps 5 and 6b) to adjust the volume level of the other channels.
 - c) **AFT**
Push the joystick **▼** or **▲** to fine tune the channel frequency over a range of -15 to +15, then press the **OK** button. Repeat steps 5 and 6c) if you wish to fine tune other channels.
 - d) **DECODER**
Push the joystick **▼** or **▲** to select **AV1** (for a decoder connected to the Scart or **AV2** (for a decoder connected to the Scart (SMARTLINK)), then press the **OK** button. Repeat steps 5 and 6d) to select the AV1 or AV2 output for other programme positions.
- i** The picture from the decoder connected to the Scart connector or (SMARTLINK) on the back of the set will appear on this programme number.
- 7** Press the **MENU** button to exit and return to the normal TV screen.

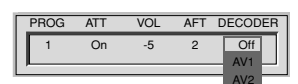
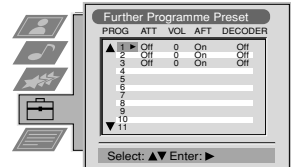
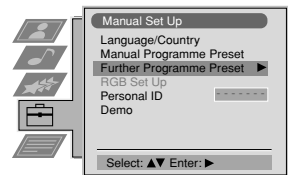
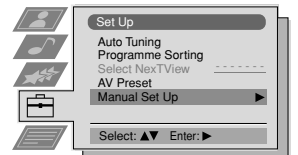
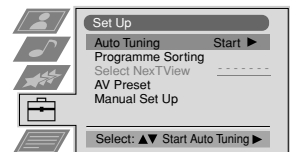
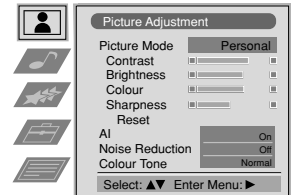

The set is now ready for use.

Menu System

Inputting Your Personal ID

i You can programme this set with a personal code, using up to eleven characters (letters and numbers). Then using this function it will be possible to identify your set if it was ever stolen.

A This code can only be input once!
Make sure to write it down in this instruction manual.



1 Press the **MENU** button on the remote control to display the menu on the screen.

2 Push the joystick **▼** to select the  symbol, then push **▶** to enter the **Set Up** menu.

3 Push the joystick **▼** or **▲** to select **Manual Set Up**, then push **▶** to enter.

4 Push **▼** or **▲** to select **Personal ID**, then push **▶** to enter.

5 Push the joystick to **▼** or **▲** to select a letter, number, + or a blank; then push **▶** to confirm this character. Select the other ten characters in the same way.

6 After selecting all the characters, press the **OK** button. A new menu appears automatically on the screen asking you to be sure that you want to save this ID.

7 a) If you do not wish to store this ID, push the joystick **◀** and repeat steps 4 to 6 to enter a new ID.

b) If you wish to store this ID, press the **OK** button.

A Remember that this code can only be input once.

8 Press the **MENU** button to return to the normal TV screen.

 When you enter the **Manual Set Up** menu, in the "Personal ID" option the code you entered above will be displayed. You will not be able to select and change this option.

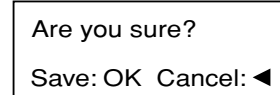
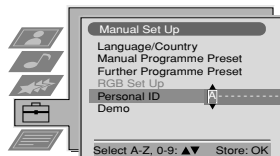
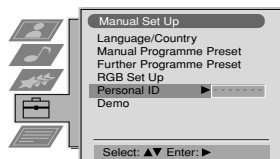
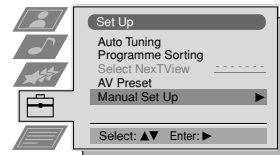
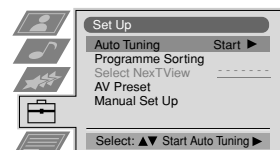
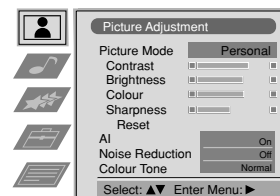

GB

Using the Demo Mode

i This function provides an overview of some of the features available on this set.





1 Press the **MENU** button on the remote control to display the menu on the screen.

2 Push the joystick **▼** to select the  symbol, then push **▶** to enter the **Set Up** menu.

3 Push the joystick **▼** or **▲** to select **Manual Set Up**, then push **▶** to enter.

4 Push **▼** or **▲** to select **Demo**, then push **▶** to enter and start the demonstration.

 *The set starts the demonstration and shows most of the available picture functions.*

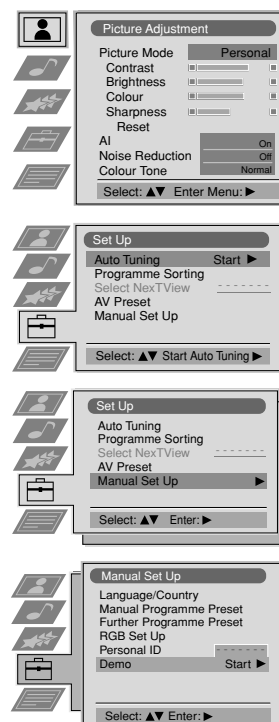

Note:
Press the  button on the remote control to stop the Demo mode and return to the normal TV screen.



Adjusting the H Centre picture for an RGB source

i When connecting an RGB source, such as a DVD player, to the Scart connector  you may need to readjust the H Centre of the picture.





1 Press the  button repeatedly on the remote control until the symbol  appears on the screen.



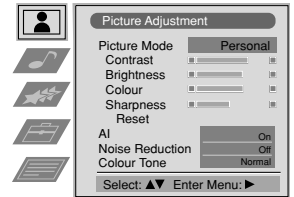

2 Push the **MENU** button to display the menu on the screen.

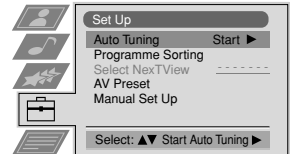

3 Push the joystick  to select the  symbol, then push  to enter the **Set Up** menu.



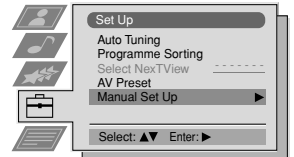

4 Push  or  to select **Manual Set Up** then push  to enter.

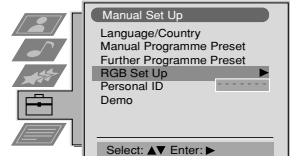

5 Push the joystick  or  to select **RGB Set Up** then push  to enter.



6 Push the joystick  to enter **H Centre**, then push  or  to adjust the centre of the picture over a range of -10 to +10. Press the **OK** button to store.

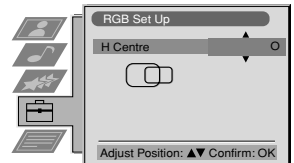

7 Press the **MENU** button to exit and return to the normal TV screen.

GB

Labelling and Selecting the screen format of Input Sources

1 This function enables you to select the size of the picture coming from the input source as well as designate a name to the optional equipment you have connected to the sockets of this set. This name can contain up to 5 characters (letters or numbers).

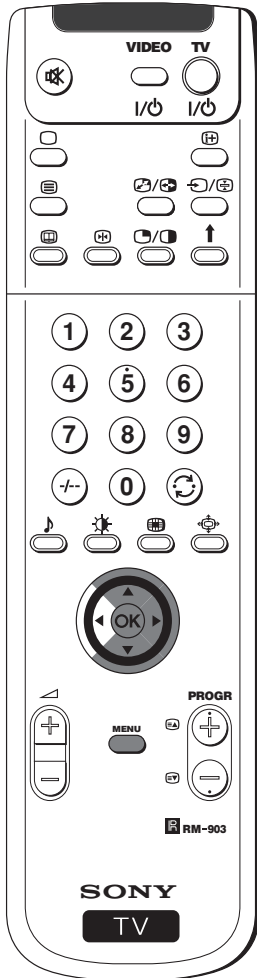

1 Press the **MENU** button on the remote control to display the menu on the screen.

2 Push the joystick **▼** to select the  symbol, then push **▶** to enter the **Set Up** menu.

3 Push the joystick **▼** or **▲** to select **AV Preset**, then push **▶** to enter.

4 Push the joystick **▼** or **▲** to select the input source. Then push **▶** to enter.

5 Push the joystick **▼** or **▲** to select:

- ▼ Off** (size of picture is not automatically adjusted).
- Normal** (size of picture is automatically adjusted according to the broadcaster information).
- ▲ Full** (The set automatically adjusts the picture size to eliminate any dark areas on the TV picture (as shown on the section "Changing the Screen Format").

Next push **▶**.

6 With the first element of the **LABEL** column highlighted, push the joystick **▼** or **▲** to select a letter, number, "+" or blank; then push **▶** to confirm this character. Select the other four characters in the same way.

7 After selecting all the characters, press the **OK** button.

8 Repeat steps 4 to 7 if you wish to select the picture size or label other input sources.

9 Press the **MENU** button to exit and return to the normal TV screen.



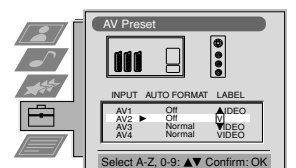
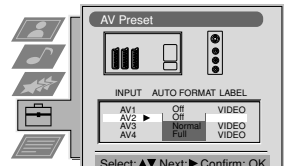
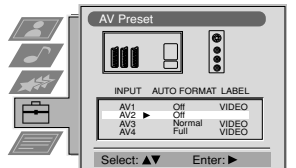
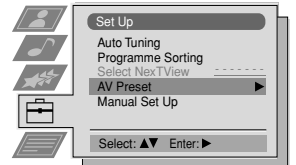
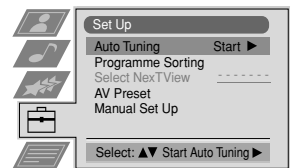
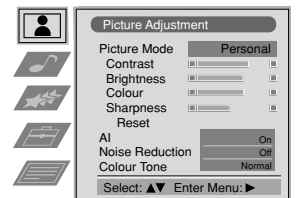



 Whenever the equipment with the labelled input is selected for use, the name appears for a few seconds on the screen



Using Multi PIP (Picture In Picture)

i Multi PIP (Picture in Picture) mode displays a succession of 12 still pictures and a 13th that is live. You can manually select which channel you wish to watch, either full-screen or in the PIP.



- 1** Press the  button on the remote control to select the PIP mode. Now 13 programme positions appear on the screen, with the current channel in the centre.
- 2** Push the joystick , ,  or  to move within the 13 displayed channels.
- 3** Press the OK button to select the framed channel. The selected channel moves to the centre.
- 4** Press  to return to the normal TV mode.

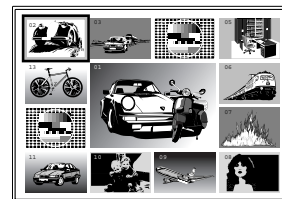



GB

Using PAP (Picture And Picture)

i PAP divides the screen into two for watching two channels simultaneously. One of the pictures can be selected to come from a video source. The sound of the left screen comes through the set loudspeakers, the sound of the right screen is selectable via headphones.





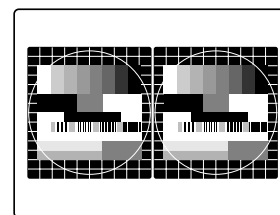

Switching PAP on and off

Press the button  on the remote control to display the two screens in format 4:3. Press  again to switch PAP off.





Selecting PAP source

- 1** To change the source of the left screen:
With PAP switched on, press the number buttons (to select a TV channel) or press  (to select a video source).
- 2** To change the source of the right screen:
With PAP switched on, press the button  on the remote control. When the symbol  appears at the bottom of the right screen, press the number buttons (to select a TV channel) or press  (to select a video source).

Swapping screens

With PAP switched on, press the  button on the remote control to swap the two screens.

Zooming the screens

With PAP switched on, push the joystick repeatedly  or  to change the size of the two screens.

Selecting the sound of the right screen

You can select the sound of the right screen via headphones. With PAP switched on, refer to the "Adjusting the Sound" section of this instruction manual and set the option "Dual Sound" to "PAP".

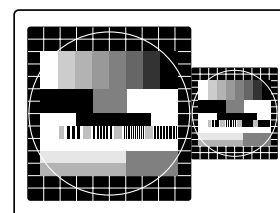

Teletext

Teletext

i Most TV channels broadcast information via Teletext. The index page of the teletext service (usually page 100) gives you information on how to use the service.

A Please use a TV channel with a strong signal, otherwise there may be Teletext errors.



Switching Teletext on and off

- 1 Select the TV channel which carries the teletext service you want to view.
- 2 Press the button once for Picture and Teletext (P&T). The screen is divided in two, with the TV channel in the right corner and the Teletext display on the left.
i P&T mode: Press then press **PROGR +/-** to change the channel of the TV screen. Push the joystick or to change the size of the TV screen then press again to resume normal teletext reception.
- 3 Press twice to get Teletext only.
- 4 Press three times for Mix mode.
- 5 Press a fourth time or press to switch off Teletext.

Selecting a Teletext page

Input three digits for the page number using the numbered buttons on the control. If you make a mistake, type in any three digits then re-enter the correct page number.

Using Other Teletext Functions

Selecting the next or preceding page

Press the (**PROG+**) or (**PROG-**) buttons on the remote control to select the previous or next page.

Selecting a sub page

A teletext page may consist of several sub pages. In this case, after a few seconds, an information line is displayed showing the number of subpages.

Select the sub page by pressing or .

To freeze a Teletext page

Press the button to freeze the page. Press again to cancel the freeze.

Revealing the index page

Press the button to reveal the index page (normally page 100).

Fastext

(only available if the TV station broadcasts Fastext signals)

When the colour coded menu appears at the bottom of a teletext page, press a coloured button on the remote control (red, green, yellow or blue) to access the corresponding page.

Using the feature "Page Catching"

- 1 Press the numbered buttons on the remote control to select a teletext page which has several page numbers on it (eg the index page).
- 2 Press the **OK** button.
- 3 Push the joystick or to select the desired page number then press the **OK** buttons. The requested page is displayed after some seconds.

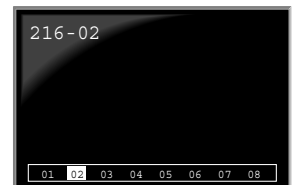
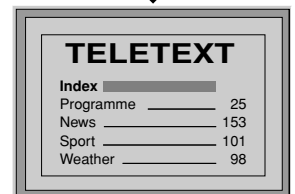
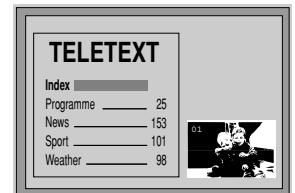

continued...



Using the Teletext menu

- 1 With Teletext switched on, press the **MENU** button on the remote control to display the teletext menu on the TV screen.
- 2 Push the joystick **▲** or **▼** to select your chosen item, then push to **▶** to display the relevant sub menu.
- 3 To remove the teletext menu from the screen, press the **MENU** button.



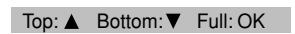

Top / Bottom / Full

The Top/Bottom/Full sub menu allows you to enlarge different sections of the Teletext page. Push the joystick **▲** to enlarge the upper half of the screen, push **▼** to enlarge the lower half. Press the **OK** button to restore the page to normal size.



Text Clear

After having selected this function, you can watch a TV channel while waiting for a requested Teletext page. As soon as the page is available, the symbol  changes colour. To view the page, press .

Reveal

Some teletext pages contain hidden information (eg for a quiz), which you can reveal. The hidden information appears on screen.

Time Page

(depending on availability of teletext service)

You can call up a time-coded page such as an alarm page at a time specified by you. After you have displayed the Time Page sub menu:

- 1 Press the numbered buttons on the remote control to enter the three digits of the desired page.
- 2 Press the numbered buttons again to enter the four digits of the desired time.
- 3 Press the **OK** button to store the desired time. The time is displayed in the top left corner of the screen. At the requested time the page is displayed.

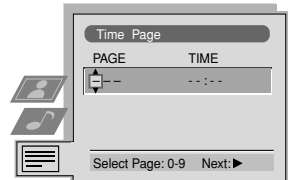

Page Overview

(depending on availability of teletext service)

In the Page Overview menu the block and group pages of TOP- Text are sorted into two columns, so that the customer can easily select this page. For each block page in the first column, the corresponding group pages are shown in the second column. Push the joystick **▲** or **▼** to select the desired block page, then push **▶** to enter to the group pages column. Push **▲** or **▼** to select the desired group page. Finally, press the **OK** button to display the page.

NexTVView *

* (depending on availability of service)

i NexTVView is an on-screen electronic programme guide (EPG), providing you with programme information for different broadcasters.



Selecting your NexTVView provider

i The set automatically selects the best NexTVView provider for you. This provider is available about 30 minutes after the channel tuning. You can however change this selection of provider if you wish.



- 1 Press the **MENU** button on the remote control to display the menu on the screen.
- 2 Push the joystick **▲** or **▼** to select the  symbol, then push **▶** to enter the **Set Up** menu.
- 3 Push **▲** or **▼** to highlight **Select NexTVView** then push **▶** to enter. A list is displayed containing all available NexTVView providers.
- 4 Push **▲** or **▼** to select the desired provider then press the **OK** button to store.
- 5 Press the **MENU** button to remove the menu from the screen.

Displaying NexTVView

- 1 Press the  button repeatedly on the remote control to switch NexTVView on and off.
 - * In some cases, you may also need to push the joystick **◀** to display the Sony electronic programme guide.
- 2 Push the joystick **▲**, **▼**, **◀** or **▶** to move the cursor around the screen.
- 3 Press the **OK** button to confirm a selection.
 - a) If you press the **OK** button in the date, time or icon (themes) columns, you change the programme list according to the selection.
 - b) If you press the **OK** button in the programme list, you directly display the channel if the broadcast is currently running, or, you display the "Long Info" menu if the broadcast is running at some future time.

Using the "Individual Setting" menu

i You can make a personal list of the types of programmes you wish to view on the programme guide.

- 1 Push the joystick **▲** or **▼** to select the  icon then push **▶** to display the "Individual Setting" menu.
- 2 Push the joystick **▲** or **▼** to select your chosen item on the screen then press the **OK** button to confirm your choice.
- 3 Repeat step 2 for all the items you wish to have in your list.
- 4 When you have finished the list, push **▶** to select the  icon.
- 5 Press the **OK** button to return to the previous menu.
- 6 Push the joystick **▲** or **▼** to select the  icon then press the **OK** button again to activate your "Individual Setting" filter.

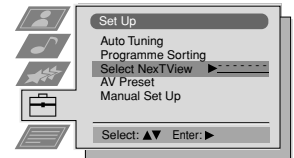
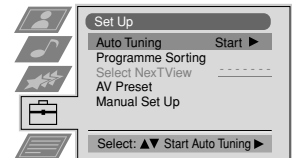
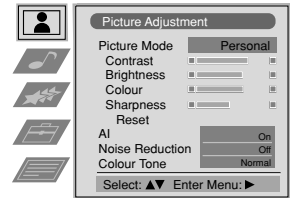

Index

-  full selection list
-  personal selection
-  news broadcasts
-  movies
-  sports
-  entertainment
-  children
-  return to last menu

continued...



Using the Long Info menu

i With this menu screen, you can set timers or record selected programmes.

- 1 Push **▲** or **▼** to select a future programme in the programme list column.
- 2 Press the **OK** button to display the **Long Info** menu on the TV screen.

To set the timer

Push the joystick **▲** or **▼** to highlight the icon then press the **OK** button repeatedly to "set the timer" or "cancel the timer". If you choose to set the timer, the programme is marked with a clock symbol and a message appears on the screen shortly before the programme is due to start asking whether you wish to still view this programme.

To view the timer table

Push the joystick **◀** or **▶** to highlight the icon then press the **OK** button repeatedly to switch on/off the timer table. This table shows the programmes on which you have already set a timer. (You can set a timer on up to 5 programmes).

To record programmes

(only with Smartlink VCRs)

- 1 Connect your Smartlink VCR.
- 2 Push the joystick **◀** or **▶** to select then press the **OK** button to download the information to your VCR.
- 3 To set up the VCR:

VPS/PDC

Push the joystick **◀** or **▶** to select **VPS/PDC** then press the **OK** button repeatedly to select **On** or **Off**. With this setting on you have the guaranteed recording of the whole broadcast should there be a change in the TV programme. This only works if the selected channel broadcasts a VPS/PDC signal.

Speed

Push the joystick **▼** to select **Speed** then press the **OK** button repeatedly to select between **SP** for standardplay or **LP** for longplay. With longplay you can record twice as much on a videotape. The picture quality however may suffer.

VCR Setup

Push the joystick **▼** to select **VCR Setup** then press the **OK** button repeatedly to select which **VCR** you wish to programme, namely **VCR1** or **VCR2**.

- 4 Finally, push the joystick **▶** to select the icon then press the **OK** button to remove the menu from the TV screen.

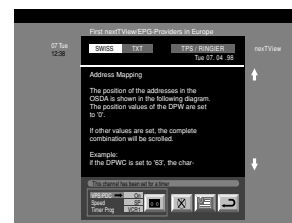

GB

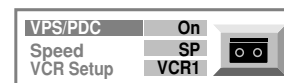

Optional Connections

Connecting Optional Equipment

1 Using the following instructions, you can connect a wide range of optional equipment to this set.

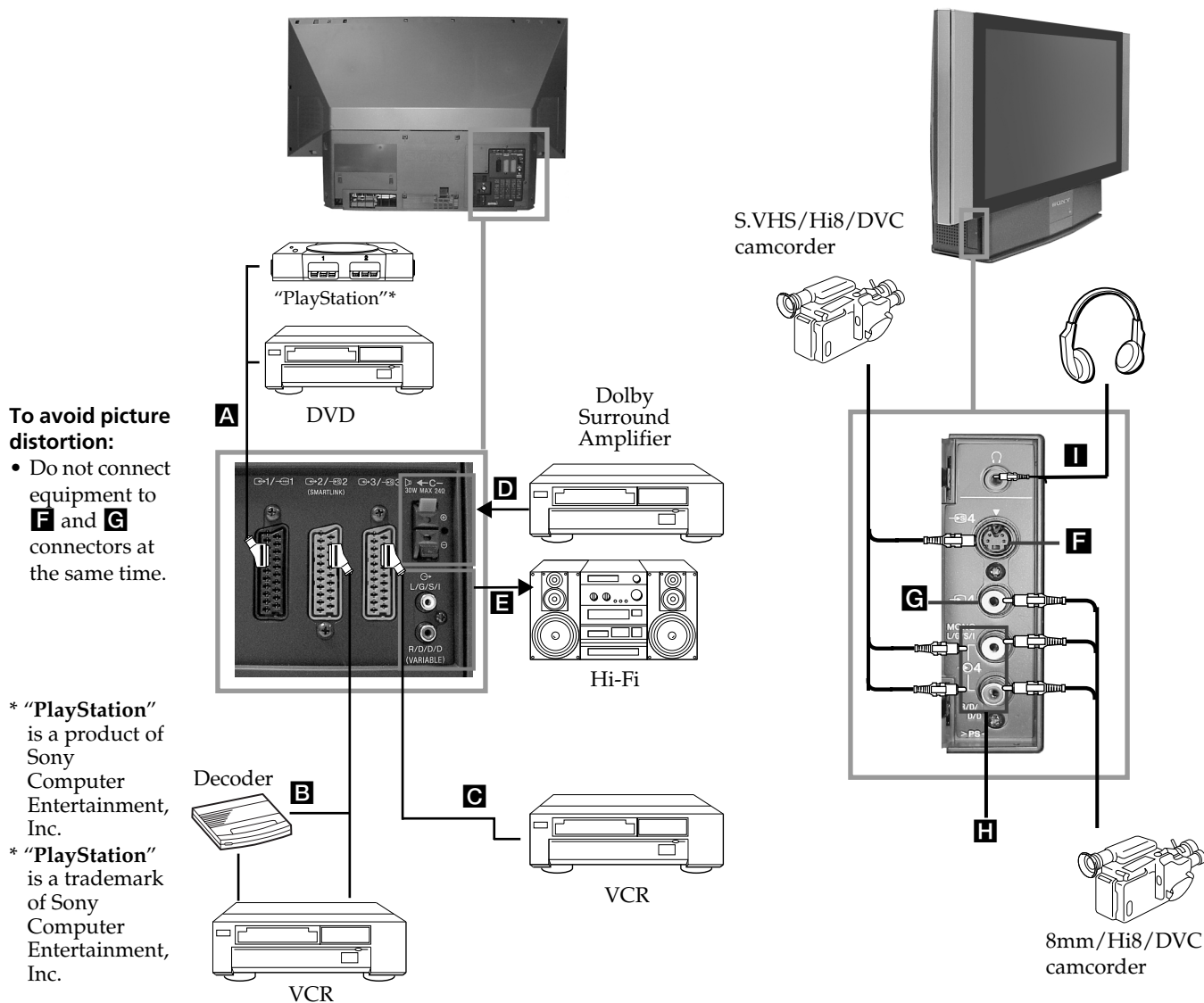

Acceptable input signal

- A** Audio/video and RGB signal
- B** Audio/video and S video signal
- C** Audio/video and S video signal
- D** Centre speaker input Set "Speaker" on the Features menu to "Centre in".
- E** No inputs
- F** S Video signal
- G** Video signal
- H** Audio signal
- I** No input

Available output signal

- Video/audio from TV tuner.
- Video/audio from selected source.
- Video/audio displayed on TV screen (monitor out).
- No outputs.
- Audio signal.
- No output.
- No output.
- No output.
- Audio signal to headphones.

Using Optional Equipment

Additional Information when connecting equipment

Connecting a VCR

We recommend you connect your VCR to the **B** or **C** socket using a scart lead. If you do not have a scart lead, use the "Manually Tuning the TV" section of this instruction manual to tune in the channel of the VCR test signal to TV programme number "0". Also refer to your VCR instruction manual to get the VCR test signal. If your video supports Smartlink please refer to the "Smartlink" section of this instruction manual.

Connecting to External Audio Equipment

1 To listen to the audio of the set on the Hi-Fi equipment:

Plug in your Hi-Fi equipment to the **E** sockets on the rear of the set if you wish to amplify the audio output from the TV.

The output level from **E** sockets can be varied by adjusting the volume of the headphones. Refer to the "Adjusting the sound" section of this instruction manual to adjust the volume of the headphones.

2 To listen to the Dolby Prologic system sound on the set speakers:





Plug in your Dolby Prologic system decoder amplifier to the **D** socket on the rear of the set if you wish to listen to the audio output from your equipment on the TV speaker. If you have a Dolby amplifier, connect the centre output from your amplifier to the **D** socket to use the set as a centre speaker. Refer to the "Using the Features menu" section of this instruction manual and set the option "Speaker" to "Centre in".

 Remember that the maximum input level of this input is 30 W. Be careful never to over this limit.

For mono equipment

Connect the phono plug to the L/G/S/I socket on the front of the TV and select the  4 input signal using the instructions on this page below.

Select and View the Input Signal



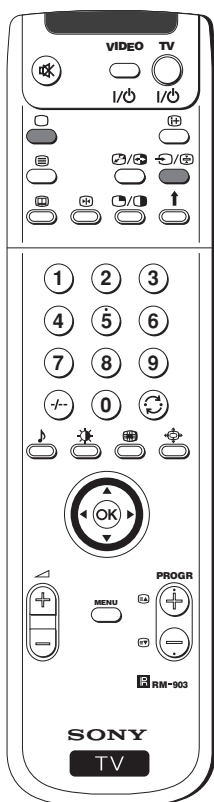

 In order to get the input signal of a connected equipment onto the TV screen, you need to select the symbol of the connector to which you have connected the device.
e. g. : Your VCR is connected to the connector with the symbol  1. Press the button  on the remote control repeatedly until you see the symbol  1 on the screen.



1 Connect your equipment to the designated socket, as it is indicated on the previous page.

2 Press the  button repeatedly on your remote control until the correct input symbol appears on the screen.

Symbol Input signals

-  1 • Audio/video input signal through the Scart connector **A** or * RGB through Scart connector **A**.
 -  2 • Audio/Video input signal through the Scart connector **B** or * S Video through Scart connector **B**.
 -  3 • Audio/Video input signal through the Scart connector **C** or * S Video through Scart connector **C**.
 -  4 • S Video input signal through the 4-pin DIN connector **F** or * video input signal through phono jack **G** and audio input signal through phono jacks **H**.
- * (automatic detection of the signal according to the connected equipment)

3 Switch on the connected equipment.

4 To return to the normal TV picture, press the  button on the remote control.

Optional Connections

Smartlink

i Smartlink is a direct link between the set and a VCR.

For Smartlink you need:

- A VCR which supports Smartlink, NextView Link, Easy Link or Megalagic.
- **i** Megalagic is a trademark of Grundig Corporation.
EasyLink is a trademark of Philips Corporation.
- A fully-wired 21 pin SCART cable to connect your VCR to the Scart connector $\text{G}2/\text{S}2$ (SMARTLINK) on the rear of the set.

The features of Smartlink are:

- Tuning information such as the channel overview are downloaded from the set to the VCR.
- Direct recording: While watching TV you need to press just one button on the VCR to record this programme.
- Automatically switching on: With the set in standby mode, pressing the "Play ►" button on your VCR automatically switches the TV on.

A If you have connected a decoder to a VCR which supports Smartlink feature, select the menu "Further Programme Preset" in the M (Manual Set Up) menu and select **DECODER AV2** to each coded channel. For more details, please refer to the section "Using the Further Programme Preset function" of this instruction manual.

A For more information on Smartlink, please refer to the Instruction Manual of your VCR.

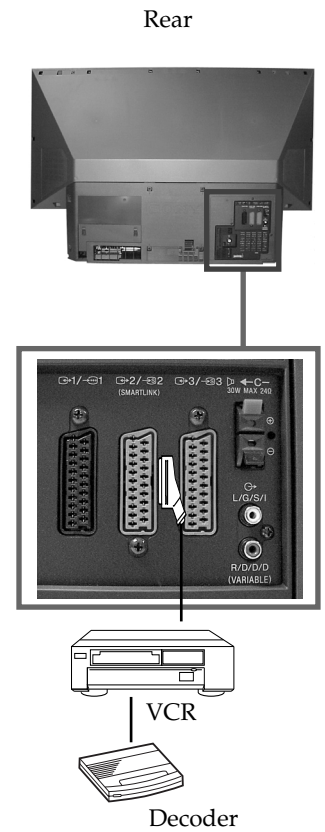

Remote Control of other Sony Equipment

i Using the buttons underneath the cover of the remote control you can control other Sony equipment.

- 1** Open the cover of the Remote Control.
- 2** Set the selector VTR 1234 DVD according to the equipment you want to control:

VTR 1	Beta VCR
VTR 2	8 mm VCR
VTR 3	VHS VCR
VTR 4	Digital Video (DCR-VX 1000/9000 E, VHR-1000)
DVD	Digital Video Disk
- 3** Use the buttons underneath the cover on the remote control to operate the equipment.

- **A** If your equipment has a COMMAND MODE selector, set this selector to the same position as the VTR 1234 DVD selector on this set Remote Control.
- If the equipment does not have a certain function, the corresponding button on the remote control will not work.

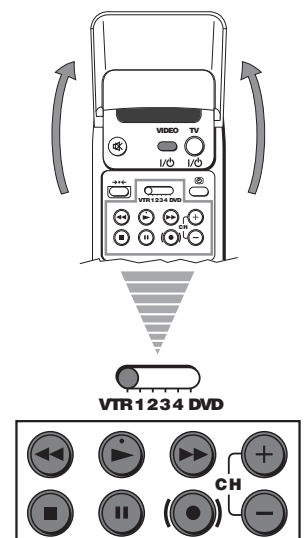

Additional Information

Optimum Viewing Area

i For the best picture quality, try to position the set so that you can view the screen from within the areas shown below.

Horizontal viewing area

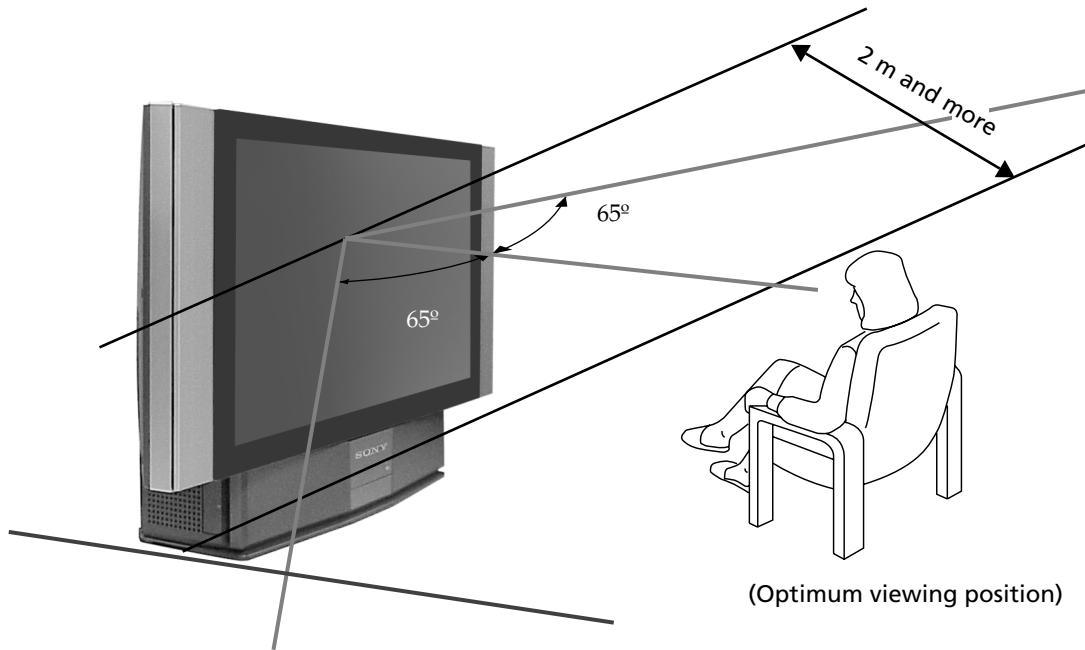

GB

Vertical viewing area

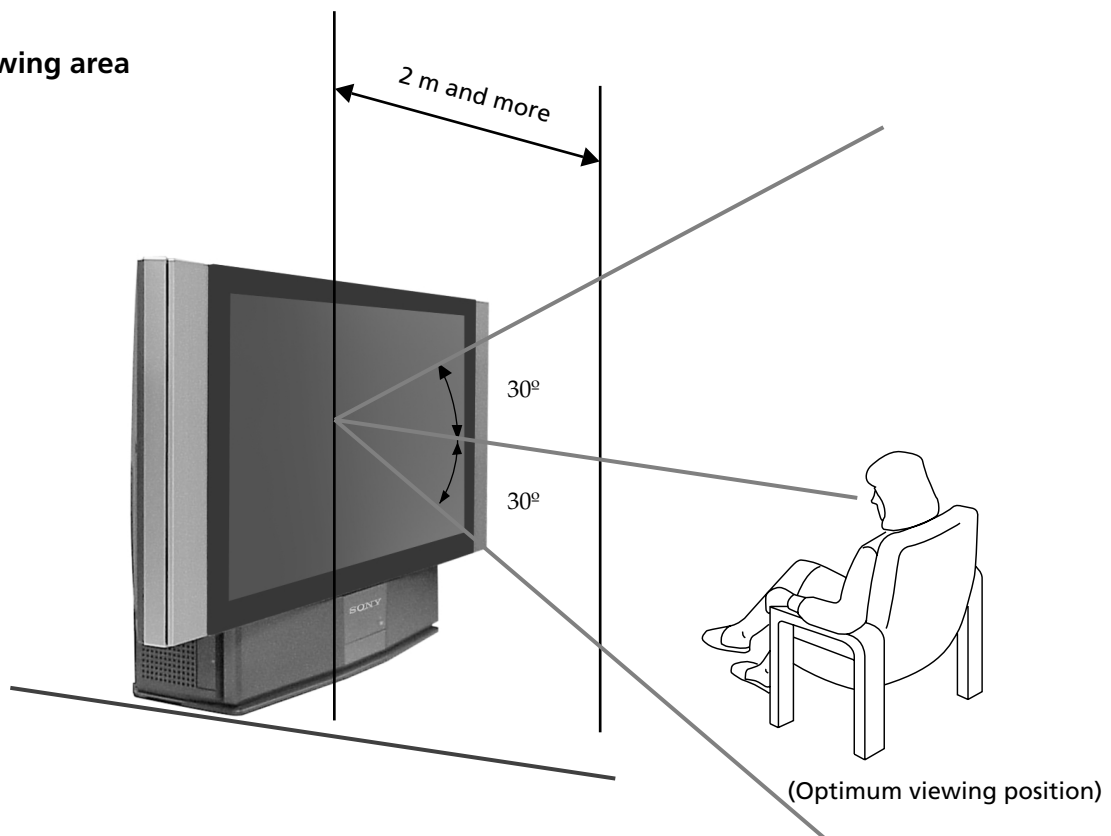

Replacing the Lamp

i When the lamp becomes dark or the picture colour is not normal or the lamp indicator  on the set flashes, replace with a new lamp.

- ⚠** • Use the lamp XL-2000E for replacement. If you use another lamp, it may cause damage to the set.
- Do not remove the lamp except when replacing it.
- Before replacing the lamp, turn off the power and disconnect the power cord.
- Replace the lamp after it becomes cool. The front glass of the lamp remains 100 °C (212 °F) and more even 30 minutes after the power is turned off.
- Do not place the removed lamp in proximity to children or flammable material.
- Do not get the removed lamp wet, or insert objects inside the lamp. It may cause the lamp to explode.
- Do not place near metal or easily flammable objects, as this may cause fire. Also, do not put your hand inside the lamp compartment, as you may be burned.
- Attach the new lamp firmly. If it is not firmly attached, the picture may become dark.

1 Turn off the power and disconnect the power cord.

- ⚠** • If you start changing the lamp without disconnecting the power cord, the standby indicator  on the set flashes. To continue changing the lamp, disconnect the power cord.
- Replace the lamp 30 minutes or more after the power is turned off. Prepare the new lamp.

2 Remove the front panel.

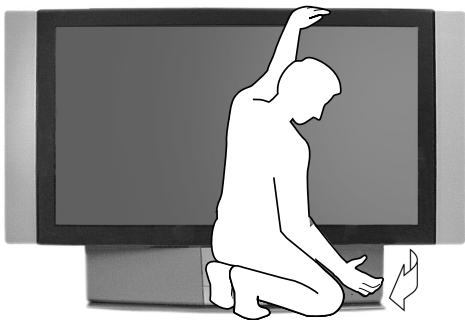

Remove the front panel without moving the set.



Grasping the right side of the front panel with your fingers, pull it forward. Be careful not to catch your fingernails.

3 Loosen the screw with the object such as a coin and remove the lamp cover.

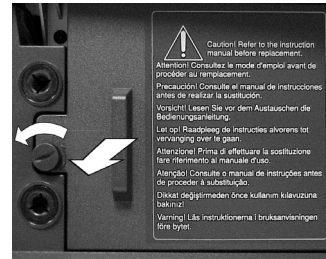

4 Loosen two screws and pull out the lamp.

Loosen two screws with the supplied wrench.

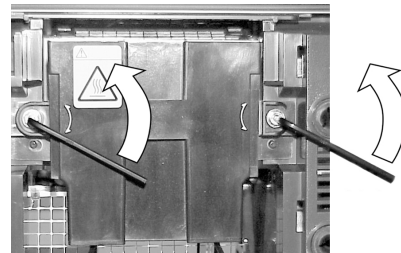

Pull out the lamp by the handle.

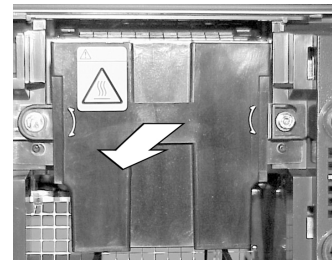

⚠ The lamp is still too hot just after the power is turned off. Be careful that you don't touch the front glass or surrounding area of the lamp or the glass of the lamp compartment.

5 Attach the new lamp.

Replace the new lamp securely in the lamp receptacle and fasten the screws tightly.

6 Attach the lamp cover.

Fasten the screw tightly with the object such as a coin.

7 Attach the front panel.

Attach the front panel as it was.

Notes

- Do not touch or stain the front glass of the new lamp or the glass of the lamp compartment. If the glass become dirty, the picture quality may deteriorate or the lamp life may shorten.
- Attach the lamp cover firmly. If it is not firmly attached, the power will not turn on.
- When the lamp burns out, a noise is audible. This does not represent a damage.
- Consult your nearest Sony service center to obtain a new lamp.
- Always remember to dispose of used lamps in an environmental friendly way.

Specifications

TV system

B/G/H, D/K, I, L

Colour system

PAL, SECAM

NTSC 3.58, 4.43 (only Video In)

Channel coverage

VHF: E2-E12

UHF: E21-E69

CATV: S1-S20

HYPER: S21-S41

D/K: R1-R12, R21-R69





I: UHF B21-B69

L: F2-F10, B-Q, F21-F69





Projected picture size

50 inches (approx. 127 cm measured diagonally).

Rear Terminals

-  Centre speaker input terminals (2 terminals)
-  (L, R) audio outputs (phono jacks)
-  21-pin Euro connector (CENELEC standard) including audio/video input, RGB input, TV audio/video output.
-  2 (SMARTLINK) 21-pin Euro connector (CENELEC standard) including audio/video input, S video input, selectable audio/video output.
-  3 21-pin Euro connector (CENELEC standard) including audio/video input, S video input, audio/video output (monitor out).

Front Terminals

-  4 S video input - 4 pin DIN
-  4 video input - phono jack
-  4 audio inputs - phono jacks
-  Headphones jack - minijack stereo

Sound output

2 x 20 W (music power)

2 x 15 W (RMS)

Centre SP input

30 W (RMS) (using as the centre speaker)

Power consumption

210 W

Standby Power consumption

≤ 1 W

Dimensions (w x h x d)

Approx. 1376 x 898 x 384 mm

Weight

Approx. 43 kg

Accessories supplied

- 1 Remote Control (RM-903)
- 2 Batteries (IEC designated)
- 1 Wrench
- 2 Brackets
- 2 Screws
- 1 Cleaning Cloth

Other features

- Digital Comb filter (High resolution)
- TELETEXT, Fasttext, TOPtext (2000 page TEXT memory)
- NexTVView
- NICAM
- Sleep Timer
- Smartlink
- Noise Reduction
- Graphic Equaliser
- Personal ID

Design and specifications are subject to change without notice.

Ecological Paper - Totally Chlorine Free 

Additional Information

Troubleshooting



Here are some simple solutions to the problems which may affect the picture and sound.

Problem	Solution
No picture (screen is dark), no sound.	<ul style="list-style-type: none">• Plug the set in.• Press the button on the front of the set.• If the indicator is on in red colour, press TV I/ button on the remote control.• Check the aerial connection.• Check that the selected video source is on.• Turn the set off for 3 or 4 seconds and then turn it on again using the button on the front of the set.
Poor or no picture (screen is dark), but good sound.	<ul style="list-style-type: none">• Using the MENU system, select the Picture Adjustment menu. Adjust the brightness, contrast and colour balance levels.
Poor picture quality when watching a RGB video source.	<ul style="list-style-type: none">• Press the button repeatedly on the remote control until the RGB symbol 1 is displayed on the screen.
Good picture, no sound	<ul style="list-style-type: none">• Press the +/- button on the remote control.• Check that "Main" speaker is selected in the "Features" menu.
No colour on colour programmes	<ul style="list-style-type: none">• Using the MENU system, select the Picture Adjustment menu. Adjust the colour balance.
Distorted picture when changing programmes or selecting teletext	<ul style="list-style-type: none">• Turn off any equipment connected to the Scart connectors on the rear of the set.
Striped picture	<ul style="list-style-type: none">• Adjust the RF Attenuator (ATT). For details, please refer to the section "Using the Further Programme Preset function".
Noisy picture when viewing TV channel	<ul style="list-style-type: none">• Adjust Fine Tuning (AFT) to obtain better picture reception. For details, please refer to the section "Using the Further Programme Preset function"
Remote control does not function	<ul style="list-style-type: none">• Replace the batteries.
The lamp indicator on the set flashes.	<ul style="list-style-type: none">• Replace the lamp. For details please refer to the section "Replace the Lamp"
The standby indicator on the set flashes.	<ul style="list-style-type: none">• If you are changing the lamp without disconnecting the power cord, the standby indicator flashes. To continue changing the lamp, disconnect the power cord and wait for about 30 minutes.• Check that the lamp cover is tightly attached.• If you are not changing the lamp but the standby indicator flashes, contact your nearest Sony service centre.



- If you continue to have these problems, have your TV serviced by qualified personnel.
- NEVER open the casing yourself.

Television Channel Number Guide for United Kingdom

i Only the main transmitters are listed. Information regarding the regional sub-relay channel numbers can be obtained by contacting The BBC Engineering Information Dept., Telephone Number 020 7852 5040.

MAIN TRANSMITTERS	BBC1	BBC2	ITV	CH4	CH5
London & South East					
① Bluebell Hill	40	46	43	65	-
② Crystal Palace	26	33	23	30	-
③ Dover	50	56	66	53	-
④ Heathfield	49	52	64	67	-
⑤ Oxford	57	63	60	53	49
South-West					
⑥ Beacon Hill	57	63	60	53	-
⑦ Caradon Hill	22	28	25	32	-
⑧ Huntshaw Cross	55	62	59	65	67
⑨ Redruth	51	44	41	47	37
⑩ Stockland Hill	33	26	23	29	-
Channel Islands					
⑪ Fremont Point	51	44	41	47	-
South					
⑫ Hannington	39	45	42	66	-
⑬ Midhurst	61	55	58	68	-
⑭ Rowridge	31	24	27	21	-
West					
⑮ Mendip	58	64	61	54	37
East					
⑯ Sandy Heath	31	27	24	21	39
⑰ Sudbury	51	44	41	47	-
⑱ Tacolneston	62	55	59	65	52
Midlands (West)					
⑲ Ridge Hill	22	28	25	32	-
⑳ Sutton Coldfield	46	40	43	50	-
㉑ The Wrekin	26	33	23	29	-
Midlands (East)					
㉒ Waltham	58	64	61	54	-
Northern Ireland					
㉓ Brougher Mountain	22	28	25	32	-
㉔ Divis	31	27	24	21	-
㉕ Limavady	55	62	59	65	-
North					
㉖ Belmont	22	28	25	32	56
㉗ Emley Moor	44	51	47	41	37
North-West					
㉘ Winter Hill	55	62	59	65	48
North-East					
㉙ Bilsdale West Moor	33	26	29	23	-
㉚ Caldbeck	30	34	28	32	56
㉛ Chatton	39	45	49	42	-
㉜ Pontop Pike	58	64	61	54	-
Scotland					
㉝ Angus	57	63	60	53	-
㉞ Black Hill	40	46	43	50	37
㉟ Sandale	22	67	-	-	-
㊱ Caldbeck	-	-	28	32	56
㊲ Craigkelly	31	27	24	21	48
㊳ Darvel	33	26	23	29	-
㊴ Durris	22	28	25	32	67
㊵ Eitshal (Lewis)	33	26	23	29	-
㊶ Keelylang Hill	40	46	43	50	-
㊷ Knock More	33	26	23	29	-
㊸ Rosemarkie	39	45	49	42	-
㊹ Rumster Forest	31	27	24	21	-
㊺ Selkirk	55	62	59	65	52
Wales					
㊻ Blaenplwyf	31	27	24	21	56
㊼ Carmel	57	63	60	53	-
㊽ Llandona	57	63	60	53	-
㊾ Moel-y-Parc	52	45	49	42	-
㊿ Presely	46	40	43	50	37
㊽ Wenvoe	44	51	41	47	-

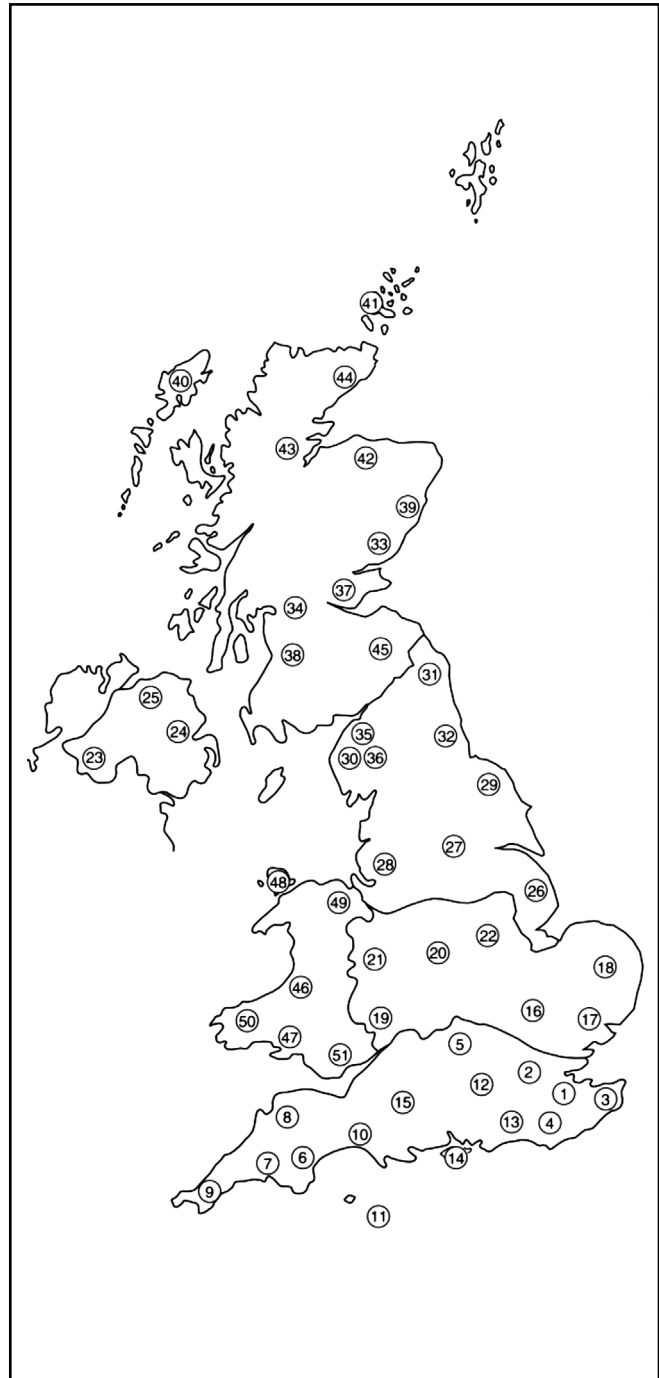

GB

