

SXRD Projection TV



Operating Instructions

- ⚠ Before operating the TV, please read the "Safety information" section of this manual.
Retain this manual for future reference.

KDS-70R2000
KDS-55A2000

SXRD
Silicon X-tal Reflective Display

BRAVIA



B
BRAVIA ENGINE
PRO



For useful information about Sony products
<http://www.sony-europe.com/myproduct>

NOTICE FOR CUSTOMERS IN THE UNITED KINGDOM

A moulded plug complying with BS1363 is fitted to this equipment for your safety and convenience.

Should the fuse in the plug supplied need to be replaced with the same rating of fuse approved by ASTA or BSI to BS 1362 (i.e., marked with  or ) must be used.

When an alternative type of plug is used it should be fitted with the same rating of fuse, otherwise the circuit should be protected by a 13 AMP FUSE at the distribution board.

If the plug supplied with this equipment has a detachable fuse cover, be sure to attach the fuse cover after you change the fuse. Never use the plug without the fuse cover. If you should lose the fuse cover, please contact your nearest Sony service station.

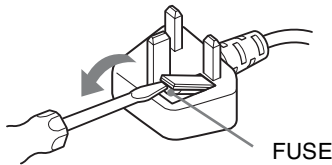

How to replace the fuse

Open the fuse compartment with a blade screwdriver, and replace the fuse.

Introduction

Thank you for choosing this Sony product. Before operating the TV, please read this manual thoroughly and retain it for future reference.

Notice for Digital TV function

- Any functions related to Digital TV (with **DVB** logo) will only work in countries or areas where DVB-T (MPEG2) digital terrestrial signals are broadcasted. Please confirm with your local dealer if you can receive a DVB-T signal where you live.
- Although this TV set follows DVB-T specifications, compatibility with future DVB-T digital terrestrial broadcasts cannot be guaranteed.
- Some Digital TV functions may not be available in some countries.

Trademark information

- **DVB** is a registered trademark of the DVB Project
 - Manufactured under license from BBE Sound, Inc. Licensed by BBE Sound, Inc. under one or more of the following US patents: 5510752, 5736897. BBE and BBE symbol are registered trademarks of BBE Sound, Inc.
 - “Dolby”, “Pro Logic”, and the double-D symbol are trademarks of Dolby Laboratories.
 - Manufactured under license from Dolby Laboratories.
 - TruSurround technology is used as a virtualizer for Virtual Dolby Surround.
 - TruSurround, SRS and  symbol are trademarks of SRS Labs, Inc. TruSurround technology is incorporated under license from SRS Labs, Inc.
 - HDMI, the HDMI logo and High-Definition Multimedia Interface are trademarks or registered trademarks of HDMI Licensing LLC.
- The illustrations used in this manual are of the KDS-55A2000 unless otherwise stated.



Table of Contents

Start-up Guide

4

Safety information	10
Precautions	12
Overview of the remote	13
Overview of the TV buttons and indicators	15

Watching TV

Watching TV	17
Checking the Digital Electronic Programme Guide (EPG) DVB	20
Using the Digital Favourite list DVB	22
Viewing pictures from connected equipment	23

Using MENU Functions

Navigating through menus	24
Picture menu	25
Sound menu	28
Screen menu	30
Set-up menu	31
AV Set-up menu	34
Analogue Set-up menu	36
Digital Set-up menu DVB	39
PC Settings menu	41

Using Optional Equipment

Connecting optional equipment	43
Programming the remote	45

Additional Information

Replacing the lamp	48
Specifications	51
Troubleshooting	53
Index	56

DVB : for digital channels only

Start-up Guide

1: Checking the accessories

Remote RM-ED006 (1)

Size AA batteries (R6 type) (2)

Mains lead (Type BF) (1)



Coaxial cable (1)



Do not remove these ferrite cores.

Side cover (2) (only for KDS-70R2000)

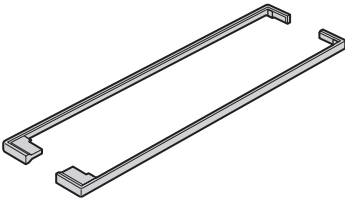

Spare projection lamp (1) (only for KDS-70R2000)

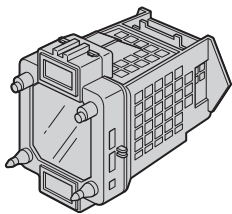

To insert batteries into the remote

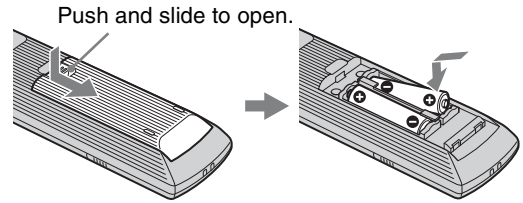

Notes

- Observe the correct polarity when inserting batteries.
- Do not use different types of batteries together or mix old and new batteries.
- Dispose of batteries in an environmentally friendly way. Certain regions may regulate disposal of the battery. Please consult your local authority.
- Handle the remote control with care. Do not drop or step on it, or spill liquid of any kind onto it.
- Do not place the remote control in a location near a heat source, or in a place subject to direct sunlight, or in a damp room.

2: Installing the TV

Recommended viewing area

Your viewing position may affect the picture quality. For the best picture quality, install your TV within the areas shown below.

Model	Viewing distance
KDS-70R2000	min. 2.4 m
KDS-55A2000	min. 2.1 m

Horizontal Viewing Area

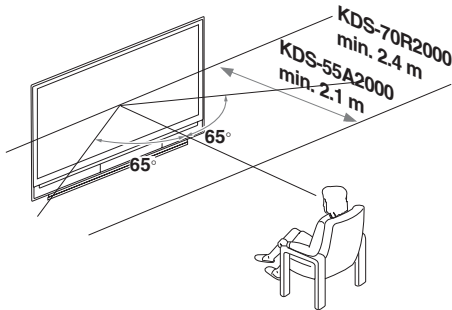

Vertical Viewing Area

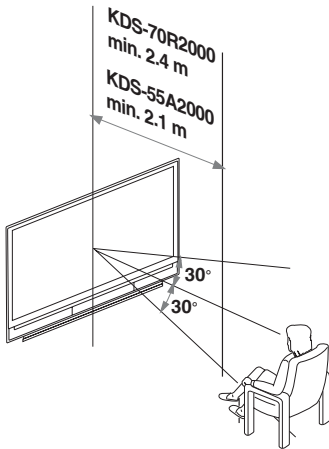

Carrying your TV

KDS-55A2000

Carrying the TV requires at least two people. When moving the TV, place one hand in the hole on the lower portion of the TV while supporting the top with the other hand, as shown in the illustration below.

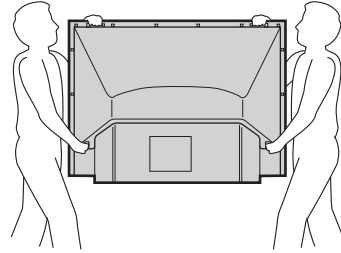

KDS-70R2000

Carrying the TV requires at least three people. Do not hold by the pedestal or the speakers of the TV. Doing so may cause these parts to break off. When moving the TV, one person should lift the back, and the other two people should lift the front and sides. Support the TV by placing your hands in the holes on the lower part of the TV set, and then lift carefully.

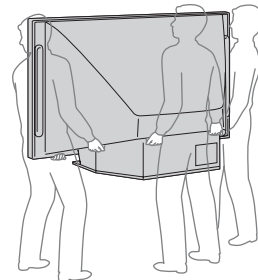

Notes

- Do not hold by the pedestal or the front panel of the TV. Doing so may cause these parts to break off.

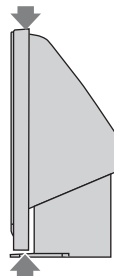

Do not grasp the pedestal or the front panel of the TV.

- To ensure the safety of children and the TV, keep children away from the TV during installation. Climbing on or pushing the TV or its stand may cause it to fall and damage the TV.
- When installing your TV against a wall, keep your TV at least 10 cm away from the wall to provide proper ventilation.

Continued

Preventing the TV from toppling over

KDS-55A2000

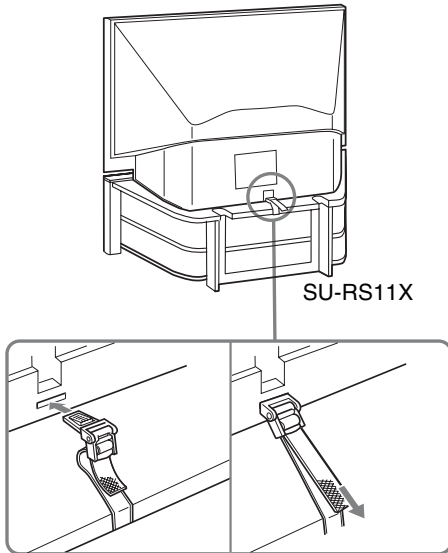

KDS-70R2000

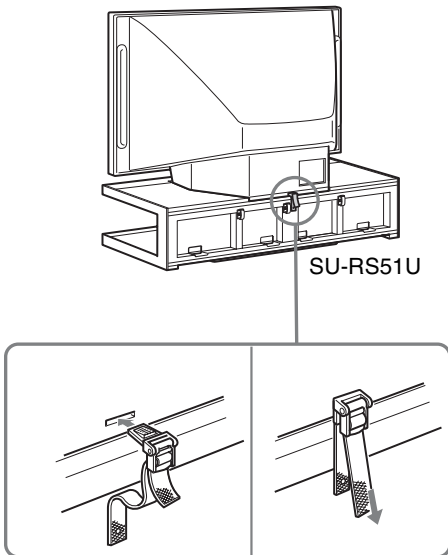

Note

When using the TV stand SU-RS11X (for KDS-55A2000, not supplied) or SU-RS51U (for KDS-70R2000, not supplied) for your TV, you must use the support belt.

Installing the TV against a wall

Keep the TV at least 10 cm away from the wall to provide proper ventilation.
Blocking the ventilation opening of the cooling fan may damage the TV.

Allow this much space

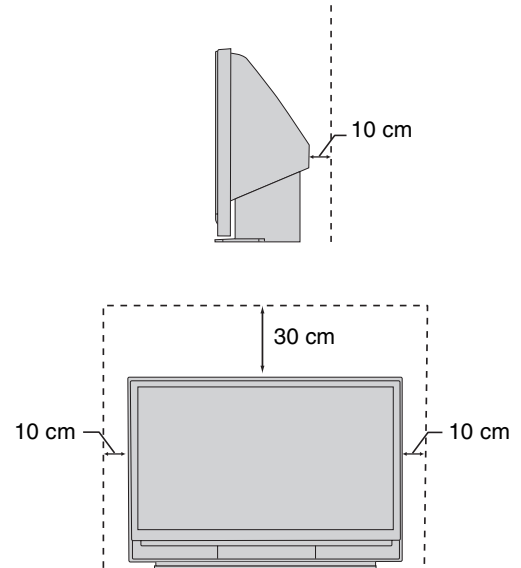

Never install the TV as follows

Air circulation is blocked.

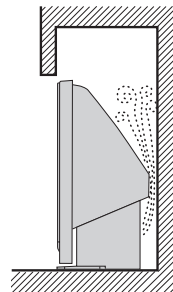

Warm air is blown to ventilation openings.

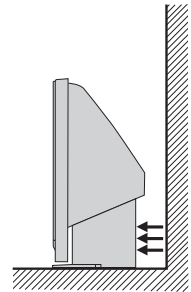

Note

Do not install the TV near any ventilation, as it may affect the normal TV operating temperature.

3: Connecting an aerial/ VCR

Connecting an aerial only

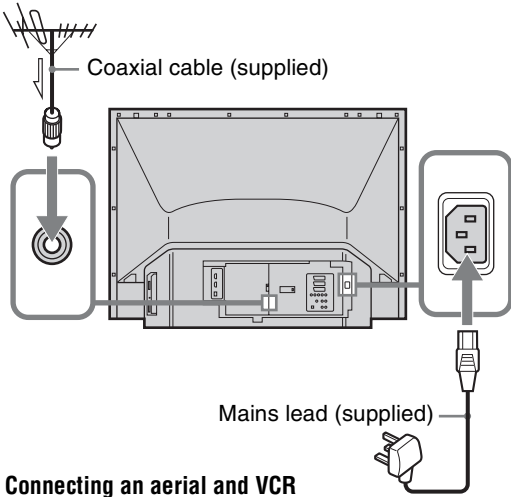

Connecting an aerial and VCR

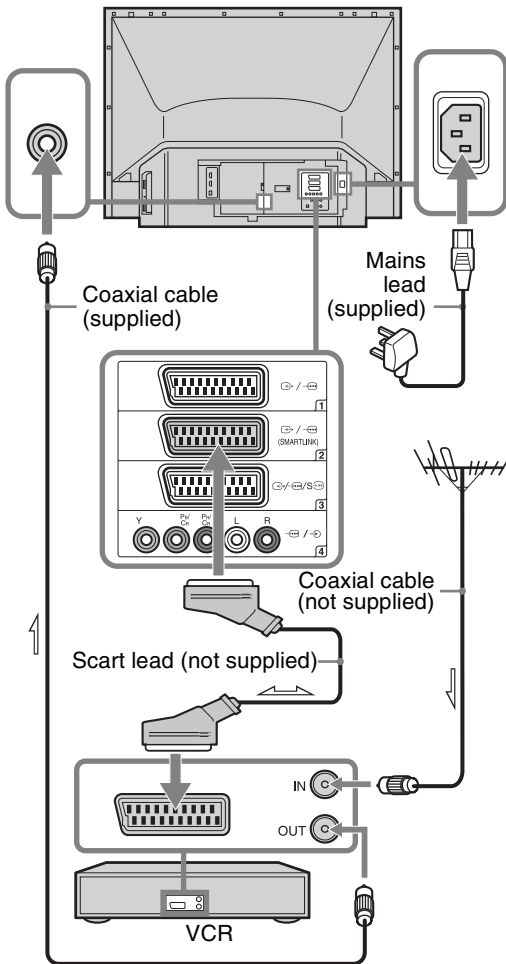

4: Selecting the language and country/ region

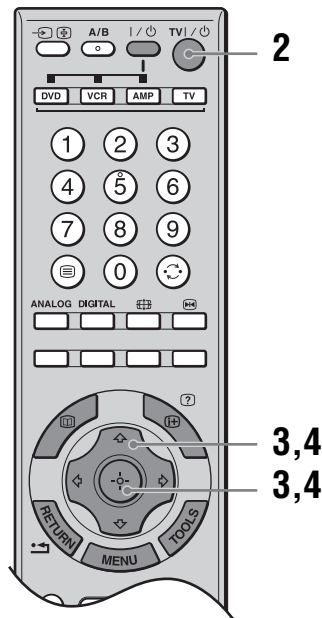
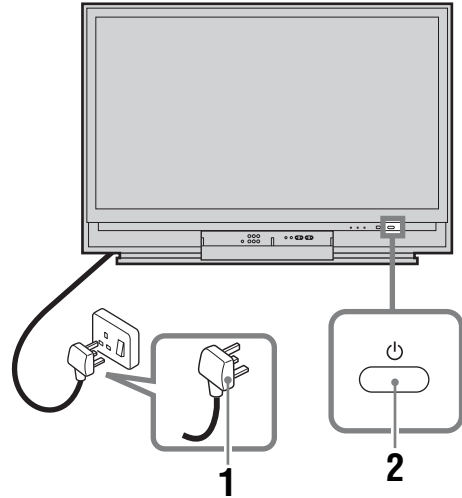



- 1 Connect the TV to your mains socket (220-240 V AC, 50 Hz).

Continued

2 Press on the TV (front).

When you switch on the TV for the first time, the Language menu appears on the screen.

When the TV is in standby mode (the  (on/standby) indicator on the TV (front) is red), press TV  on the remote to switch on the TV.

3 Press , , , to select the language displayed on the menu screens, then press .



4 Press , , , to select the country/region in which you will operate the TV, then press .

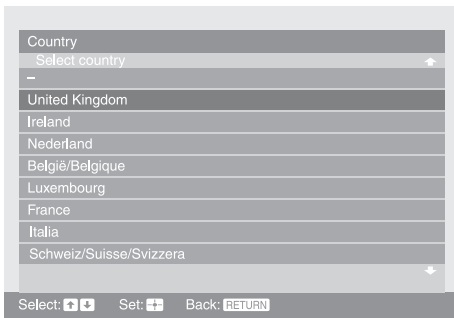

If the country/region in which you want to use the TV does not appear in the list, select “-” instead of a country/region.

The message confirming the TV start auto-tuning appears on the screen, then go to “5: Auto-tuning the TV”.

5: Auto-tuning the TV

The TV will search for and store all available TV channels.

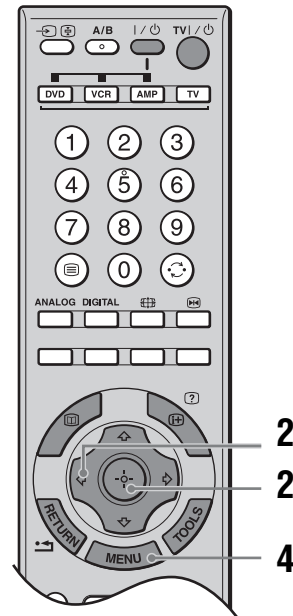

1 Before you start auto-tuning the TV, insert a pre-recorded tape into the VCR connected to the TV (page 7) and start play back.

The video channel will be located and stored on the TV during auto-tuning.

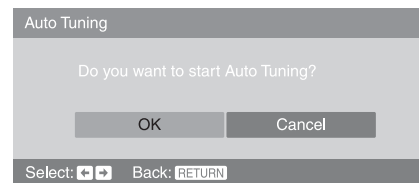

If no VCR is connected to the TV, skip this step.

2 Press , to select “OK”, then press .



The TV starts searching for all available digital channels, followed by all available analogue channels. This may take some time, please be patient and do not press any buttons on the TV or remote.

If a message appears for you to confirm the aerial connection

No digital or analogue channels were found. Check the aerial connection and press ,  to select “Yes”, then press  to start auto-tuning again.

- 3** When the Programme Sorting menu appears on the screen, follow the steps of “Programme Sorting” (page 36).

If you do not change the order in which the analogue channels are stored on the TV, go to step 4.

- 4** Press MENU to exit.

The TV has now tuned in all the available channels.

Note

When a digital broadcast channel cannot be received, or when selecting a region in which there are no digital broadcasts in step 4 (page 8) under “4: Selecting the language and country/region”, the time must be set after performing step 3.

Safety information

Mains lead

- Observe the followings to prevent the mains lead being damaged. If the mains lead is damaged, it may result in a fire or an electric shock.
 - Unplug the mains lead when moving the TV set.
 - When you disconnect the mains lead, disconnect it from the mains socket first.
 - Be sure to grasp the plug when disconnecting the mains lead. Do not pull on the mains lead itself.
 - Do not pinch, bend, or twist the mains lead excessively. The core conductors may be exposed or broken.
 - Do not modify the mains lead.
 - Do not put anything heavy on the mains lead.
 - Keep the mains lead away from heat sources.
- If you damage the mains lead, stop using it and ask your dealer or Sony service centre to exchange it.
- Do not use the supplied mains lead on any other equipment.
- Use only an original Sony mains lead, not other brands.

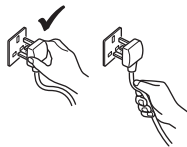

Mains socket

- The TV set with a three-wire grounding type mains plug must be connected to a mains socket with a protective earthing connection.
- Do not use a poor fitting mains socket. Insert the plug fully into the mains socket. A poor fit may cause arcing and result in a fire. Contact your electrician to have the mains socket changed.



Cleaning the mains plug

Unplug the mains plug and clean it regularly. If the plug is covered with dust and it picks up moisture, its insulation may deteriorate and result in a fire.



Overloading

This TV set is designed to operate on a 220–240 V AC supply only. Take care not to connect too many appliances to the same mains socket as this could result in a fire or an electric shock.

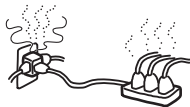

When not in use

- If you will not be using the TV set for several days, the TV set should be disconnected from the mains for environmental and safety reasons.



- The TV set is not disconnected from the mains when the TV set is switched off. To disconnect the TV set completely, pull the plug from the mains. However, some TV sets may have features which need the TV set to be left in standby to work correctly.

Carrying

- Before carrying the TV set, disconnect all the cables from the TV set.
- Carrying the large size TV set requires two or more people.
- When you carry the TV set by hand, hold the TV set as illustrated on the right. When lifting the TV set or moving the panel of the TV set, hold it firmly from the bottom. If you do not do so, the TV set may fall and be damaged or cause serious injury.
- When transporting it, do not subject the TV set to jolts or excessive vibration. The TV set may fall and be damaged or cause serious injury.
- If the TV set has been dropped or damaged, have it checked immediately by qualified service personnel.
- When you carry the TV set in for repair or when you move it, pack it using the original carton and packing material.

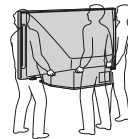

Placement

- The TV set should be installed near an easily accessible mains socket.
- Place the TV set on a stable, level surface. Do not hang anything on the TV set. If you do, the TV set may fall from the stand, causing damage or serious injury.
- Do not install the TV set in places subject to extreme temperature, for example in direct sunlight, or near a radiator, or heating vent. If the TV set is exposed to extreme temperature, the TV set may overheat and cause deformation of the casing or cause the TV set to malfunction.
- Do not install the TV set in a place exposed to direct air conditioning. If the TV set is installed in such a location, moisture may condense inside and may cause a malfunction.
- Never place the TV set in hot, oily, humid or excessively dusty places.
- Do not install the TV set where insects may enter.
- Do not install the TV set where it may be exposed to mechanical vibration.
- Do not install the TV set in a location where it may protrude, such as on or behind a pillar, or where you might bump your head on it. Otherwise, it may result in injury.
- Do not allow children to climb on the TV set.
- If you use the TV set near the seashore, salt may corrode metal parts of the TV set and cause internal damage or fire.
- Do not install the appliance in a confined space, such as a bookcase or built-in cabinet.
- Use the TV at temperatures between 5°C and 35°C.
- Do not use the TV at altitudes higher than 3,000 m, as doing so might cause malfunctions.



Ventilation

- Never cover the ventilation holes or insert anything in the cabinet. It may cause overheating and result in a fire.
- Unless proper ventilation is provided, the TV set may gather dust and get dirty. For proper ventilation, observe the following:
 - Do not install the TV set turned backwards or sideways.
 - Do not install the TV set turned over or upside down.
 - Do not install the TV set on a shelf or in a closet.
 - Do not place the TV set on a rug or bed.
 - Do not cover the TV set with cloth, such as curtains, or items such as newspapers, etc.
- Leave some space around the TV set (see “Installing the TV against a wall” on page 6). Otherwise, air-circulation may be inadequate and cause overheating, which may cause a fire or damage to the TV set.



Optional accessories

Observe the following when installing the TV set using a stand. If you do not do so, the TV set may fall and cause serious injury.

- It is strongly recommended that you use Sony accessories for safety reasons:
 - KDS-55A2000:
TV stand SU-RS11X
 - KDS-70R2000:
TV stand SU-RS51U
- Secure the TV set properly, following the instructions supplied with your stand when installing the TV set.
- Be sure to attach the brackets supplied with your stand.

Wiring

- When wiring cables, be sure to unplug the mains lead for your safety.
- Take care not to catch your feet on the cables. It may damage the TV set.

Medical institutions

Do not place this TV set in a place where medical equipment is in use. It may cause a malfunction of medical instruments.

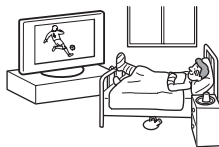

Outdoor use

- Do not install this TV set outdoors. If the TV set is exposed to rain, it may result in a fire or an electric shock.
- If this TV set is exposed to direct sunlight, the TV set may heat up and it may damage the TV set.

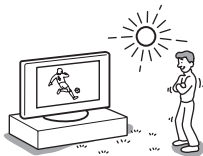

Vehicle, Ships and other vessels

- Do not install this TV set in a vehicle. The motion of the vehicle may cause the TV set to fall down and cause injury.



- Do not install this TV set on a ship or other vessel. If the TV set is exposed to seawater, it may cause a fire or damage the TV set.

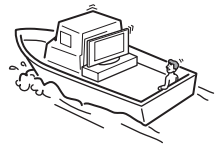

Water and moisture

- Do not use this TV set near water – for example, near a bathtub or shower room. Also do not expose to rain, moisture or smoke. This may result in a fire or an electric shock.
- Do not touch the mains lead and the TV set with wet hands. Doing so may cause an electric shock or damage to the TV set.



Moisture and flammable objects

- Do not place any objects on the TV set. The TV set shall not be exposed to dripping or splashing and that no objects filled with liquid, such as vases, shall be placed on the TV set.
- To prevent fire, keep flammable objects or naked lights (e.g. candles) away from the TV set.
- If any liquid or solid object does fall through openings in the cabinet, do not operate the TV set. It may result in an electric shock or damage to the TV set. Have it checked immediately by qualified service personnel.

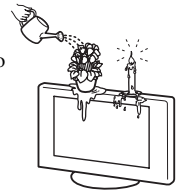

Lightning storms

For your own safety, do not touch any part of the TV set, mains lead, or aerial lead during lightning storms.



Broken pieces

- Do not throw anything at the TV set. The screen glass may break by the impact and cause serious injury.
- If the surface of the TV set cracks, do not touch it until you have unplugged the mains lead. Otherwise electric shock may result.



Servicing

Dangerously high voltages are present inside the TV set. Do not open the cabinet. Entrust the TV set to qualified service personnel only.



Small accessories removal and fittable

Keep small accessories out of children's reach.

Attachments

Do not use attachments not recommended by the manufacturer, as they may cause hazards.

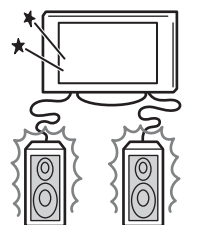

Precautions

Viewing the TV

- To view the TV comfortably, the recommended viewing position is from four to seven times the screen's vertical length away from the TV set.
- To obtain a clear picture, do not expose the screen to direct illumination or direct sunlight. If possible, use spot lighting directed down from the ceiling.
- View the TV in moderate light, as viewing the TV in poor light or during long period of time, strains your eyes.

Volume adjustment

- Adjust the volume so as not to trouble your neighbours. Sound carries very easily at night time. Therefore, closing the windows or using headphones is suggested.
- When using headphones, adjust the volume so as to avoid excessive levels, as hearing damage may result.

About the TV

- Although the TV is made with high-precision technology, black dots may appear or bright points of light (red, blue, or green) may appear constantly on the screen. This is a structural property of the panel and is not a malfunction.
- When High contrast non-moving images such as station logos and channel numbers are displayed for a long period of time, there may be some image retention on the screen. This is only a temporary condition. Turning off the power for a while or letting the TV run on another channel will eliminate the retained image.
- If direct sunlight or other strong illumination shines on the screen, part of the screen may appear white due to reflections from behind the screen. This is a structural property of the TV.
Do not expose the screen to direct illumination or sunlight.

Projection lamp

- Your TV uses a projection lamp as its light source. It is time to replace the lamp with a new one when:
 - the message, "Projection lamp is nearing end of life. Please replace the lamp." appeared on the screen,
 - the lamp indicator on the front blinks in red,
 - screen images become dark,
 - no image appears on the display after prolonged use.
- In rare instances, the bulb may pop inside the lamp unit, but the lamp unit is designed to contain all of broken glass pieces inside the lamp unit. (See "Replacing the lamp" on page 48.)
- When the lamp eventually burns out, you may hear a noticeable pop sound. This is normal and is inherent in this type of lamp.
- The projection lamp contains mercury and should be disposed of properly. Consult your local authorities regarding safe disposal. If the lamp is broken during use, a small amount of mercury may be released. In this situation, move away from the product and ventilate the area. In case of accidental contact or inhalation, or if you feel unwell, consult a physician promptly.

Cooling fan

This TV uses a cooling fan. You may hear some fan noise (depending on the placement of the TV), which may be more noticeable during the night, or when ambient noise is particularly low.

Handling and cleaning the screen surface/cabinet of the TV set

Be sure to unplug the mains lead connected to the TV set from mains socket before cleaning.

To avoid material degradation or screen coating degradation, observe the following precautions.

- Do not push on the screen, scratch it with a hard object, or throw anything at it. The screen may be damaged.
- Do not touch the display panel after operating the TV set continuously for a long period as the display panel becomes hot.
- We recommend that the screen surface be touched as little as possible.
- To remove dust from the screen surface/cabinet, wipe gently with a soft cloth. If dust is persistent, wipe with a soft cloth slightly moistened with a diluted mild detergent solution.
- Never use any type of abrasive pad, alkaline/acid cleaner, scouring powder, or volatile solvent, such as alcohol, benzene, thinner or insecticide. Using such materials or maintaining prolonged contact with rubber or vinyl materials may result in damage to the screen surface and cabinet material.
- The ventilation holes can accumulate dust over time. To ensure proper ventilation, we recommend removing the dust periodically (once a month) using a vacuum cleaner.
- If the angle of the TV set is to be adjusted, steady the base of the stand with your hand to prevent the TV set from becoming separated from the stand. Be careful not to get your fingers caught between the TV set and the stand.

Optional Equipments

- Do not install optional components too close to the TV set. Keep optional components at least 30 cm away from the TV set. If a VCR is installed in front of the TV set or beside the TV set, the picture may become distorted.
- Picture distortion and/or noisy sound may occur if the TV set is positioned in close proximity to any equipment emitting electromagnetic radiation.

Disposal of the TV set



Disposal of Old Electrical & Electronic Equipment (Applicable in the European Union and other European countries with separate collection systems)

This symbol on the product or on its packaging indicates that this product shall not be treated as household waste. Instead it shall be handed over to the applicable collection point for the recycling of electrical and electronic equipment. By ensuring this product is disposed of correctly, you will help prevent potential negative consequences for the environment and human health, which could otherwise be caused by inappropriate waste handling of this product. The recycling of materials will help to conserve natural resources. For more detailed information about recycling of this product, please contact your local Civic Office, your household waste disposal service or the shop where you purchased the product.

Overview of the remote

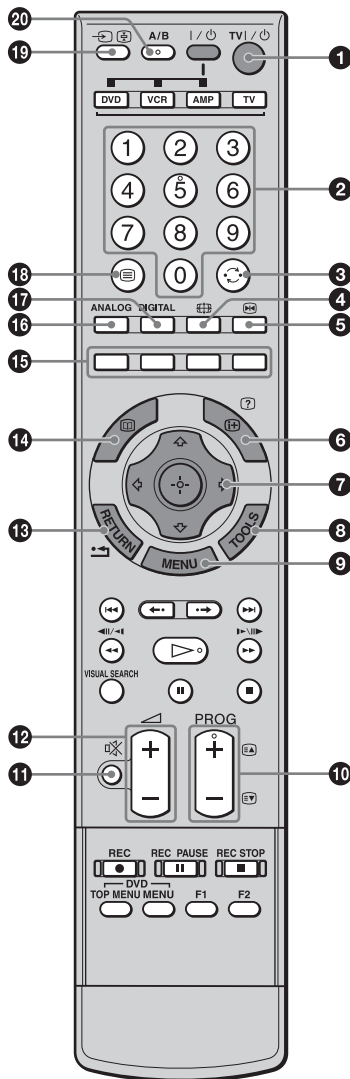

- 1 TV I/⏻ – TV standby**
Switches the TV on and off from standby mode.
- 2 Number buttons**
 - In TV mode: Selects channels. For channel numbers 10 and above, enter the second and third digit quickly.
 - In Analogue Text mode: Enters the three digit page number to select the page.
- 3 ↻ – Previous channel**
Returns to the previous channel watched (for more than five seconds).
- 4 🌐 – Screen format (page 18)**
- 5 ⏸ – Picture freeze (page 18)**
Freezes the TV picture.
- 6 ⓘ/? – Info / Text reveal**
 - In digital mode: Displays brief details of the programme currently being watched.
 - In analogue mode: Displays information such as current channel number and screen format.
 - In Analogue Text mode (page 18): Reveals hidden information (e.g. answers to a quiz).
- 7 ⏮/⏪/⏩/⏭/⏯ (page 18, 24)**
- 8 TOOLS (page 19, 23)**
Enables you to access various viewing options and change/make adjustments according to the source and screen format.
- 9 MENU (page 24)**
- 10 PROG +/-/⏮/⏭ (page 17, 18)**
 - In TV mode: Selects the next (+) or previous (-) channel.
 - In Analogue Text mode: Selects the next (⏮) or previous (⏭) page.
- 11 🔇 – Mute (page 18)**
- 12 🔊 +/- – Volume**
- 13 RETURN / ⏪**
Returns to the previous screen of any displayed menu.
- 14 📖 – EPG (Digital Electronic Programme Guide) (page 20)**
- 15 Coloured buttons (page 18, 20, 22)**
- 16 ANALOG – Analogue mode (page 17)**
- 17 DIGITAL – Digital mode (page 17)**
- 18 ☰ – Text (page 18)**
- 19 →/⏮ – Input select / Text hold**
 - In TV mode (page 23): Selects the input source from equipment connected to the TV sockets.
 - In Analogue Text mode (page 18): Holds the current page.
- 20 A/B – Dual Sound (page 29)**

Continued

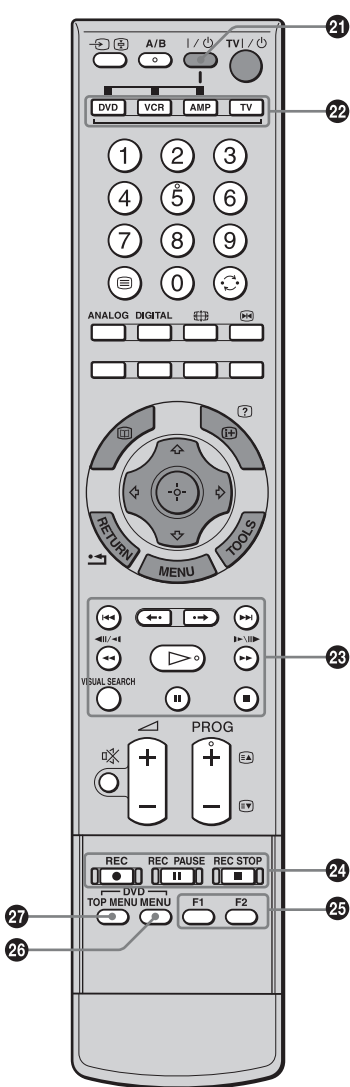

21 I/Power
Switches on or off the optional equipment selected from the function buttons.

22 Function buttons
Enables you to operate the corresponding equipment. For details, see “Programming the remote” on page 45.

23 DVD/VCR operating buttons

- ◀◀ : Replays the current programme from the previous chapter mark (if any).
- ▶▶ : Advances forward to the next chapter mark (if any).
- ◀• : Replays the current programme for a set period of time.
- ▶ : Advances forward a set period of time.
- ◀◀◀ : Plays a programme in fast reverse mode.
- ▶▶▶ : Plays a programme in fast forward mode.
- ▷ : Plays a programme at a normal speed.
- ⏸ : Pauses playback.
- : Stops the playback.
- VISUAL SEARCH : Only for Sony DVD recorders with the visual search function. For details, see the operating instructions supplied with the DVD recorder.

24 DVD/VCR record buttons

- REC: Starts recording.
- ⏸ REC PAUSE: Pauses the recording.
- REC STOP: Stops the recording.

⏸ REC PAUSE and ■ REC STOP are available only on DVD recorders.

25 F1/F2

- Selects a disc when using a DVD changer.
- Selects a function when using a combination unit (e.g. a DVD/VCR).

For details, see the operating instructions supplied with the DVD changer or combination unit.

26 DVD MENU
Displays the DVD disc menu.

27 DVD TOP MENU
Displays the top menu of the DVD disc.

Tips

- The number 5, ▷, PROG + and A/B buttons have tactile dots. Use the tactile dots as references when operating the TV.
- When using the remote, aim it at the remote control sensor on the TV. See page 15 for the location of the sensor.

Overview of the TV buttons and indicators

KDS-55A2000

Be careful not to pinch your fingers when opening the cover.

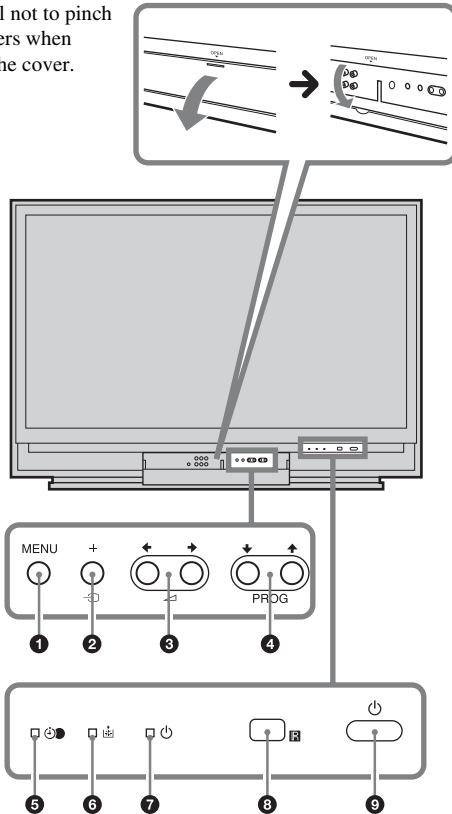

KDS-70R2000

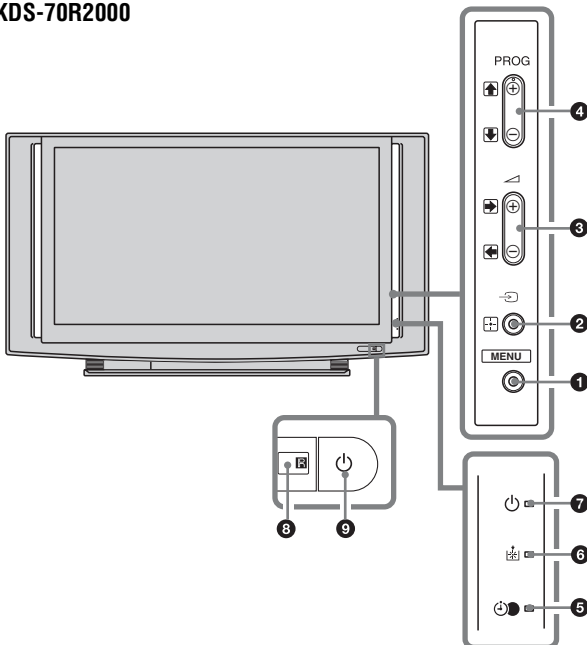

1 MENU (page 24)

2 →/+/+ – Input select/OK

- In TV mode (page 23): Selects the input source from equipment connected to the TV sockets.
- In TV menu: Selects the menu or option, and confirms the setting.

3 ▲ +/-/▶/◀

- In TV mode: Increases (+) or decreases (-) the volume.
- In TV menu: Moves through the options right (▶) or left (◀).

4 PROG +/-/▲/▼

- In TV mode: Selects the next (+) or previous (-) channel.
- In TV menu: Moves through the options up (▲) or down (▼).

5 ⏻ – Timer REC programme/Timer indicator

- Lights up in orange when the Timer recording is set (page 20, 21). Lights up in red when the recording starts.
- Lights up in orange when the timer is set (page 31).

6 📶 – Lamp indicator

Flashes in red when the lamp for the light source has burned out.

7 ⏻ – On/standby indicator

Flashes in green when the light source is preparing to turn on. Lights up in green when the TV is switched on.

Lights up in red when the TV is in standby mode. If the lamp cover or the lamp itself is not securely attached, the red indicator will continue to flash in intervals of three blinks at a time (page 49).

8 Remote control sensor

- Receives IR signals from the remote.
- Do not put anything over the sensor, as its function may be affected.

9 ⏻ – Power

Switches the TV on or off.

Note

Make sure that the TV is completely switched off before unplugging the mains lead. Unplugging the mains lead while the TV is turned on may cause the indicator to remain lit or may cause the TV to malfunction.

Continued

Projection lamp

Your TV uses a projection lamp as its light source. As with any lamp, it has lifespan and needs to be replaced when the lamp indicator flashes or the screen becomes darker.

Notes

- After switching on your TV, it may take a while (1 minute or less) before the picture appears.
- When the projection lamp wears out, the screen goes dark. Replace the lamp with a new Sony XL-5200 (for KDS-55A2000, not supplied) or XL-5300 (for KDS-70R2000, supplied) replacement lamp. How to replace the lamp, see page 48.

Warning

The light emitted from the lamp is quite bright when your TV is in use. To avoid eye discomfort or injury, do not look into the light housing when the power is on.

To detach the speakers

(KDS-70R2000 only)

The speakers on the KDS-70R2000 can be detached if required. If you use a multi-channel surround speaker system and there is insufficient space to install the display unit, we recommend using the speakers detached.

- 1** Remove the three screws that are located on the rear of the speaker, and pull the speaker straight out to detach it from the panel.

When removing the screws, use a coin to turn them counterclockwise.

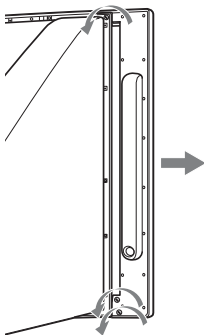

- 2** Attach the side cover that came in the box.

Press the cover at the top, middle, and bottom to make sure that it is attached securely (see illustration).

Note

Facing the TV, make sure that the side covers marked "R" (right) and "L" (left) are attached to the corresponding sides of the TV.

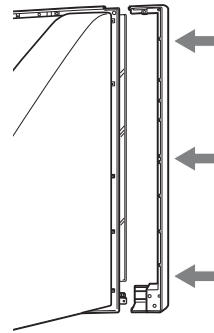

- 3** Tighten the side cover with the three screws that you removed in step 1.

When attaching the screws, use a coin to turn them clockwise.

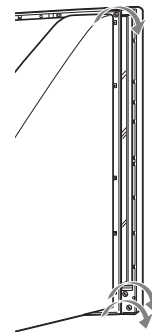



- 4** Repeat steps 1 through 3 with the speaker on the other side.

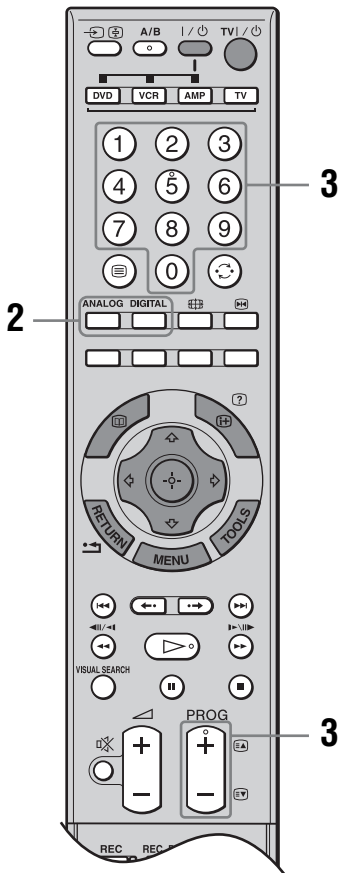
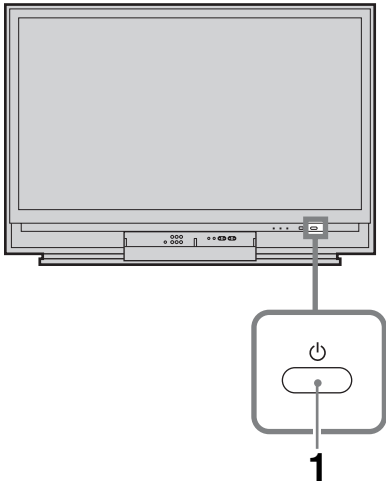

Note

After you remove the speakers, place them in the box that originally contained the side cover.

Watching TV



- 1 Press  on the TV (front) to switch on the TV.

When the TV is in standby mode (the  (on/standby) indicator on the TV (front) is red), press TV  on the remote to switch on the TV.

- 2 Press DIGITAL to switch to digital mode or ANALOG to switch to analogue mode.

The channels available vary depending on the mode.









- 3 Press the number buttons or PROG +/- to select a TV channel.

To select channel numbers 10 and above using the number buttons, enter the second and third digits quickly.

To select a digital channel using the Digital Electronic Programme Guide (EPG), see page 20.

In digital mode

An information banner appears briefly. The following icons may be indicated on the banner.

- : Interactive service is available (Digital Text)
- : Radio service
- : Scrambled/Subscription service
- : Multiple audio languages available
- : Subtitles available
- : Subtitles available for the hearing impaired
- : Recommended minimum age for current programme (from 4 to 18 years)
- : Parental Lock
- : Current programme is being recorded

Additional operations

To	Do this
Switch off the TV temporarily (standby mode)	Press TV I/⏻.
Switch off the TV	Press ⏻ on the TV (front). Note To disconnect the TV completely, pull the plug from the mains.
Switch on the TV without sound from standby mode	Press ⏻. Press ⏴ +/- to adjust the volume.
Adjust the volume	Press ⏴ + (increase)/ - (decrease).
Mute the sound	Press ⏻. Press again to restore.
Access the Programme index table (in analogue mode only)	Press ⊕. To select an analogue channel, press ⏶/⏷, then press ⊕. To access the Input signal index table, see page 23.

To access Digital Text

Many broadcasters provide a Digital Text service. Digital Text offers graphically rich contents, compared to Analogue Text.

Select a digital channel which provides Digital Text, then press ≡.

When a broadcaster provides a dedicated Digital Text channel, select this channel to access Digital Text.

To navigate through Digital Text, follow the instructions on the screen.

To exit Digital Text, press RETURN.

To move around, press ⏶/⏷/⏵/⏴.

To select items, press ⊕ and the number buttons.

To access shortcuts, press the coloured buttons.

To access Analogue Text

In analogue mode, press ≡. Each time you press ≡, the display changes cyclically as follows:

Text and TV picture → Text → No Text (exit the Text service)

To select a page, press the number buttons or ⏴/⏷.

To hold a page, press ⏴/⏷.

To reveal hidden information, press ⊕/?.

To jump a page, press ⊕ and ⏶/⏷, then press ⊕ (for three digit pages).

Tips

- Ensure that the TV is receiving a good signal, or some text errors may occur.
- Most TV channels broadcast a Text service. For information on the use of the service, select the index page.
- When four coloured items appear at the bottom of the Text page, Fastext is available. Fastext allows you to access pages quickly and easily. Press the corresponding coloured button to access the page.

To freeze the picture – Picture freeze

You can freeze the current picture to make a note of a telephone number or recipe.

1 Press ⏴.

The frozen picture is displayed on the right of the screen. You can watch a moving picture on the left.

2 Press ⏴ again to return to normal TV mode.

To change the screen format manually to suit the broadcast

Press ≡ repeatedly to select Smart, 4:3, Wide, Zoom, or 14:9.

Smart*

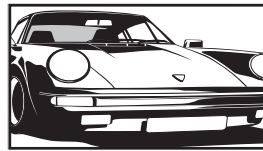

Displays conventional 4:3 broadcasts with an imitation wide screen effect. The 4:3 picture is stretched to fill the screen.

4:3

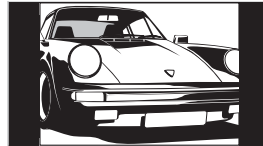

Displays conventional 4:3 broadcasts (e.g. non-wide screen TV) in the correct proportions.

Wide

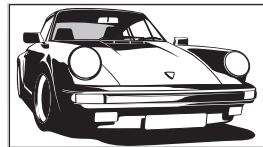

Displays wide screen (16:9) broadcasts in the correct proportions.

Zoom*

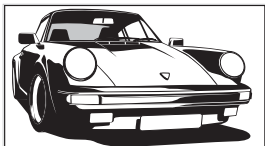

Displays cinemascopic (letter box format) broadcasts in the correct proportions.

14:9*

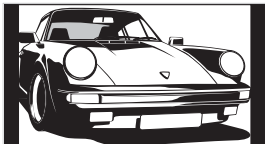

Displays 14:9 broadcasts in the correct proportions. As a result, black border areas are visible on the screen.

* Parts of the top and bottom of the picture may be cut off.

Tips

- Alternatively, you can set “Auto Format” to “On”. The TV will automatically select the best mode to suit the broadcast (page 30).
- You can adjust the position of the picture when selecting Smart, 14:9 or Zoom. Press \uparrow/\downarrow to move up or down (e.g. to read subtitles).

To use the Tools menu

Press TOOLS to display the following options when viewing a TV programme.

Options	Description
Close	Closes the Tools menu.
PAP (or Single Picture)	See page 19.
Picture Mode	See page 25.
Sound Mode	See page 28.
Subtitle Setting (in digital mode only)	See page 39.
Digital Favourites (in digital mode only)	See page 22.
Power Saving	See page 31.
Sleep Timer	See page 31.
\cup Volume*	See page 32.
Auto Clock Set (in analogue mode only)	Allows you to switch to digital mode and obtain the time.

* This option appears only if “ \cup Speaker Link” is set to “Off” (page 32).

To view two pictures simultaneously – PAP (Picture and Picture)

You can view two pictures (external input and TV programme) on the screen simultaneously. Connect the optional equipment (page 43), and make sure that images from the equipment appear on the screen (page 23).

Note

This function is not available for a PC input source.

- 1 Press TOOLS to display the Tools menu.
- 2 Press \uparrow/\downarrow to select “PAP”, then press \oplus .
The picture from connected equipment is displayed on the left and the TV programme is displayed on the right.
- 3 Press number buttons or PROG +/- to select the TV channel.
To return to normal TV mode
Press \oplus or RETURN.

Tips

- You can also return to normal TV mode by selecting “Single Picture” from the Tools menu.
- The picture framed in green is audible. You can switch the audible picture by pressing \leftarrow/\rightarrow .
- You can change the size of the picture by pressing and holding \leftarrow/\rightarrow .

Checking the Digital Electronic Programme Guide (EPG) DV3*



Digital Electronic Programme Guide (EPG)

* This function may not be available in some countries.

- 1 In digital mode, press to display the Digital Electronic Programme Guide (EPG).
- 2 Perform the desired operation, as shown in the following table.

Notes

Programme information will only be displayed if the TV station is transmitting it.

To	Do this
Turn off the EPG	Press .
Move through the EPG	Press .
Watch a current programme	Press while the current programme is selected.
Sort the programme information by category – Category list	<ol style="list-style-type: none"> 1 Press the blue button. 2 Press to select a category. The category name is displayed on the side. The categories available include: “All Categories”: Contains all available channels. Category name (e.g. “News”): Contains all channels corresponding to the selected category. 3 Press . <p>The Digital Electronic Programme Guide (EPG) now only displays the current programmes from the category selected.</p>
Set a programme to be recorded – Timer REC	<ol style="list-style-type: none"> 1 Press to select the future programme you want to record. 2 Press . 3 Press to select “Timer REC”. 4 Press to set the TV and your VCR timers. A symbol appears by that programme’s information. The indicator on the TV (front) lights up in orange.

Notes

- You can set VCR timer recording on the TV only for Smartlink compatible VCRs. If your VCR is not Smartlink compatible, a message will be displayed to remind you to set your VCR timer.
- Once a recording has begun, you can switch the TV to standby mode, but do not switch off the TV completely or the recording may be cancelled.
- If an age restriction for programmes has been selected, a message asking for a PIN code will appear on the screen. For more details refer to “Parental Lock” on page 39.

To	Do this
Set a programme to be displayed automatically on the screen when it starts – Reminder	<ol style="list-style-type: none"> 1 Press to select the future programme you want to display. 2 Press . 3 Press to select “Reminder”. 4 Press to automatically display the selected programme when the programme starts. A symbol appears by that programme’s information. <p>Note If you switch the TV to standby mode, it will automatically turn itself on when the programme is about to start.</p>
Set the time and date of a programme you want to record – Manual timer REC	<ol style="list-style-type: none"> 1 Press . 2 Press to select “Manual timer REC”, then press . 3 Press to select the date, then press . 4 Set the start and stop time in the same way as in step 3. 5 Press to select the programme, then press . 6 Press to set the TV and your VCR timers. A symbol appears by that programme’s information. The indicator on the TV (front) lights up in orange. <p>Notes</p> <ul style="list-style-type: none"> • You can set VCR timer recording on the TV only for Smartlink compatible VCRs. If your VCR is not Smartlink compatible, a message will be displayed to remind you to set your VCR timer. • Once a recording has begun, you can switch the TV to standby mode, but do not switch off the TV completely or the recording may be cancelled. • If an age restriction for programmes has been selected, a message asking for a PIN code will appear on the screen. For more details refer to “Parental Lock” on page 39.
Cancel a recording/reminder – Timer list	<ol style="list-style-type: none"> 1 Press . 2 Press to select “Timer list”. 3 Press to select the programme you want to cancel, then press . 4 Press to select “Cancel Timer”, then press . <p>A display appears to confirm that you want to cancel the programme.</p> <ol style="list-style-type: none"> 5 Press to select “Yes”, then press to confirm.

Tip

You can also display the Digital Electronic Programme Guide (EPG) by selecting “Digital EPG” in the “MENU” (page 24).

Using the Digital Favourite list DV3*



Digital Favourite list

The Favourite feature allows you to select programmes from a list of up to 20 channels you specify. To display the Favourite list, see “Navigating through menus” (page 24).

* This function may not be available in some countries.

To	Do this
Create your Favourite list for the first time	<p>A message appears asking if you want to add channels to the Favourite list when you select “Digital Favourites” in the “MENU” for the first time.</p> <ol style="list-style-type: none">1 Press + to select “Yes”.2 Press ↑/↓ to select the channel you want to add. If you know the channel number, you can use the number buttons to directly select a channel.3 Press +. Channels that are stored in the Favourite list are indicated by a ♥ symbol.
Turn off the Favourite list	Press RETURN.
Watch a channel	Press + while selecting a channel.
Add or remove channels in the Favourite list	<ol style="list-style-type: none">1 Press the blue button. Channels that are stored in the Favourite list are indicated by a ♥ symbol.2 Press ↑/↓ to select the channel you want to add or remove. If you know the channel number, you can use the number buttons to directly select a channel.3 Press +.4 Press the blue button to return to the Favourite list.
Remove all channels from the Favourite list	<ol style="list-style-type: none">1 Press the blue button.2 Press the yellow button. A display appears to confirm that you want to delete all channels from the Favourite list.3 Press ↔ to select “Yes”, then press + to confirm.

Viewing pictures from connected equipment

Switch on the connected equipment, then perform one of the following operation.

For equipment connected to the scart sockets using a fully-wired 21-pin scart lead (page 44)

Start playback on the connected equipment. The picture from the connected equipment appears on the screen.

For an auto-tuned VCR (page 8)

In analogue mode, press PROG +/-, or the number buttons, to select the video channel.

For other connected equipment (page 43)

Press / repeatedly until the correct input symbol (see below) appears on the screen.

On screen display	Labels of input jacks
AV1/2 or AV1/2	1 or 2 /
AV3, AV3 or AV3	3 / / /
AV4	4 (Y, Pb/Cb, Pr/Cr) and (L, R)
AV5	5 HDMI IN
AV6	6 HDMI IN 6 HDMI IN and 6 HDMI IN (L, R)
AV7 or AV7	7 or (Y, Pb/Cb, Pr/Cr) and (L (MONO), R)
PC	PC IN RGB and PC IN

Additional operations

To	Do this
Return to normal TV mode	Press DIGITAL or ANALOG.
Access the Input signal index table (except for PC video input signal)	Press to access the Input signal index table. (Then, only in analogue mode, press .) To select an input source, press / , then press .

To use the Tools menu

Press TOOLS to display the following options when viewing pictures from connected equipment other than a PC.

Options	Description
Close	Closes the Tools menu.
PAP (or Single Picture)	See page 19.
Picture Mode	See page 25.
Sound Mode	See page 28.
Power Saving	See page 31.
Sleep Timer	See page 31.
Volume*	See page 32.
Auto Clock Set	Allows you to switch to digital mode and obtain the time.

* This option appears only if “ Speaker Link” is set to “Off” (page 32).

Using MENU Functions

Navigating through menus

“MENU” allows you to enjoy various convenient features of this TV. You can easily select channels or inputs sources and change the settings for your TV.

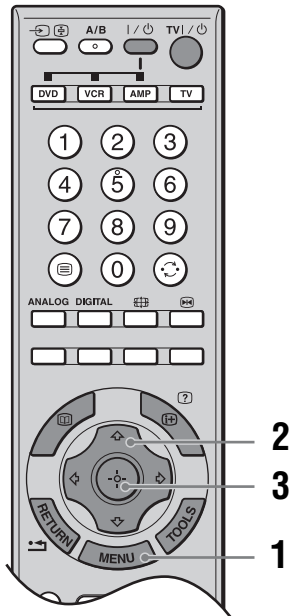

1 Press MENU to display the menu.

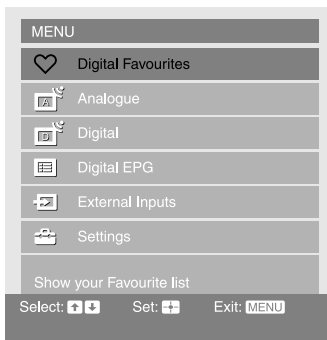

Icon	Description
	Digital Favourites* Displays the Favourite list. For details about settings, see page 22.
	Analogue Returns to the last viewed analogue channel.

Icon	Description
	Digital* Returns to the last viewed digital channel.
	Digital EPG* Displays the Digital Electronic Programme Guide (EPG). For details about settings, see page 20.
	External Inputs Selects equipment connected to your TV. <ul style="list-style-type: none"> To watch the desired external input, select the input source, then press (+). To assign a label to an external input, select “Edit AV Labels”, then see page 34.
	Settings Displays the Settings menu where most of the advanced settings and adjustments are performed. For details about settings, see page 25 to 40. Note The options you can adjust vary depending on the situation. Unavailable options are greyed out or not displayed.

* This function may not be available in some countries.

2 Press ↑/↓ to select an option.

3 Press (+) to confirm a selected option.

To exit the menu, press MENU.

Picture menu

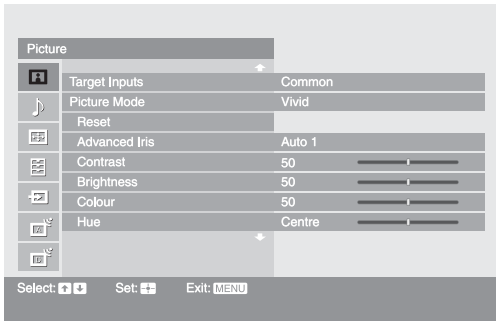

You can select the options listed below on the Picture menu.

- 1 Press \uparrow/\downarrow to select “Settings” on MENU, then press \oplus .
- 2 Press \uparrow/\downarrow to select a menu icon, then press \oplus .
- 3 Press $\uparrow/\downarrow/\leftarrow/\rightarrow$ to select an option.

Target Inputs

For the input currently being viewed, select whether to use the common setting or to set each item separately.

“Common”: Applies common settings whose adjustments are shared with other inputs in which “Target Inputs” is set to “Common”.

Current input name (e.g. AV1): Allows you to set each option separately for the current input.

Tip

Set each input to “Common” if you require the same settings to apply to each input.

Picture Mode

Selects the picture mode.

“Vivid”: For enhanced picture contrast and sharpness.

“Standard”: For standard picture. Recommended for home entertainment.

“Custom”: Allows you to store your preferred settings.

Reset

Resets all the “Picture” settings except “Target Inputs” and “Picture Mode” to the factory settings.

Tip

“Advanced Settings” (page 27) is also not reset. Select “Reset” in “Advanced Settings” to reset items in “Advanced Settings”.

Advanced Iris

By selecting the iris option, you can obtain the best brightness and contrast suited for your TV viewing.

“Auto 1”*: Recommended option for viewing programmes that have larger variation in brightness from scene to scene.

“Auto 2”*: Recommended option for viewing programmes that have less variation in brightness from scene to scene.

“Max”*: With this option, the screen has maximum level of brightness. It is suitable for TV viewing in a brightly lit room.

“High”*: With this option, the screen becomes bright. It is suitable for TV viewing in a brightly lit room.

“Medium”*: With this option, the brightness is about the standard level.

“Low”*: With this option, the screen brightness dims and increases in contrast. It is suitable for TV viewing in a room with low lighting.

“Min”*: With this option, the screen is dimmed but contrast is at a maximum. It is suitable for TV viewing in a room with low lighting.

* Automatically detects the brightness of the screen. These options are best suited for programmes such as movies that often change between bright scenes and low light setting scenes.

Note

“Advanced Iris” is not available when using Freeze or PAP features.

Contrast

Increases or decreases picture contrast.

Brightness

Brightens or darkens the picture.

Colour

Increases or decreases colour intensity.

Hue

Increases or decreases the green tones and red tones.

Tip

“Hue” can only be adjusted for an NTSC colour signal (e.g. U.S.A. video tapes).

Colour Temperature

Adjusts the whiteness of the picture.

“Cool”*: Gives the white colours a blue tint.

“Neutral”*: Gives the white colours a neutral tint.

“Warm 1”/“Warm 2”*: Gives the white colours a red tint. “Warm 2” gives a redder tint than “Warm 1”.

Tip

“Warm 1” and “Warm 2” can only be selected when you set “Picture Mode” to “Custom”.

Sharpness

Sharpens or softens the picture.

Noise Reduction

Reduces the picture noise (snowy picture).

“Auto”*: Automatically reduces the picture noise.

“High”/“Medium”/“Low”*: Modifies the effect of the noise reduction.

“Off”*: Turns off the Noise Reduction feature.

“BNR”*: Reduces the block picture noise. This is effective for digital channels, or a connected DVD player/digital receiver with MPEG playback.

Tips

- “Auto” is not available when watching component, HDMI or digital RF inputs.
 - “Noise Reduction” is not available when using Freeze or PAP features.
-

DRC Mode

Creates a high-resolution for high density source (i.e. DVD player, digital receiver).
 “Mode 1”: Recommended mode
 “Mode 2”: Only available when input signal format is 1080i. Mode 2 is suitable setting if original signal content is based on standard definition signal.
 “Off”: Turns off the DRC Mode.

Tip

“DRC Mode” is not available when “Game Mode” is set to “On” or when using Freeze or PAP features; also not available when watching PC or 1080p sources.

DRC Palette

Customizes the level of detail (“Reality”) and smoothness (“Clarity”) for each input signal. For example, you can create a custom setting for your cable input’s picture, and create another for your DVD player’s pictures.

The DRC palette appears.

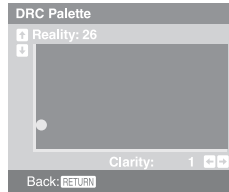

Press $\uparrow/\downarrow/\leftarrow/\rightarrow$ to adjust the position of the marker (●).

As you move the ● higher along the “Reality” axis, the picture becomes more detailed. As you move the ● to the right along the “Clarity” axis, the picture becomes smoother.

Tip

“DRC Palette” is not available when “Game Mode” is set to “On”, “DRC Mode” is set to “Off” or when using Freeze or PAP features; also not available when watching PC or 1080p sources.

Advanced Settings

Customizes the Picture function in more detail. When you set “Picture Mode” to “Custom”, you can set/change these settings.

“Reset”: Resets all the advanced settings to the factory settings.

“Black Corrector”: Enhances black areas of the picture for stronger contrast.

“Gamma”: Adjusts the balance between bright and dark areas of the picture.

“Clear White”: Emphasizes white colours.

“Live Colour”: Makes colours more vivid.

“White Balance”: Adjusts the colour temperature colour by colour.

“Detail Enhancer”: Enhances the details of the picture.

“Edge Enhancer”: Enhances the outline of the picture.

Tip

“Detail Enhancer” is not available when using Freeze or PAP features.

Sound menu

You can select the options listed below on the Sound menu. To select options in “Settings”, refer to “Picture menu” (page 25).

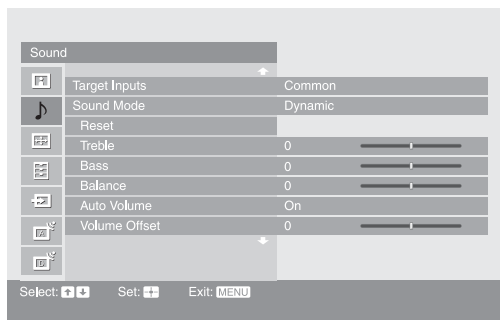

Target Inputs

For the input currently being viewed, select whether to use the common setting or to set each item separately.

“Common”: Applies common settings whose adjustments are shared with other inputs in which “Target Inputs” is set to “Common”.

Current input name (e.g. AV1): Allows you to set each option separately for the current input.

Tip

Set each input to “Common” if you require the same settings to apply to each input.

Sound Mode

Selects the sound mode.

“Dynamic”: Enhances treble and bass.

“Standard”: For standard sound. Recommended for home entertainment.

“Custom”: Flat response. Also allows you to store your preferred settings.

Reset

Resets all the “Sound” settings except “Target Inputs”, “Sound Mode” and “Dual Sound” to the factory settings.

Treble

Adjusts higher-pitched sounds.

Bass

Adjusts lower-pitched sounds.

Balance

Emphasizes left or right speaker balance.

Auto Volume

Keeps a constant volume level even when volume level gaps occur (e.g. adverts tend to be louder than programmes).

Volume Offset

Adjusts the volume level of the current input relative to other inputs, when “Target Inputs” is set to the current input name (e.g. AV1).

Surround

Selects the surround mode.

“Dolby Virtual”: Uses the TV speakers to simulate the surround effect produced by a multi channel system.

“Off”: For normal stereo or mono reception.

BBE

Gives sound more impact by compensating for phase effects in speakers using the “BBE High Definition Sound System”, when “Sound Mode” is set to “Custom”.

Dual Sound

Selects the sound from the speaker for a stereo or bilingual broadcast.

“Stereo”, “Mono”: For a stereo broadcast.

“A”/“B”/“Mono”: For a bilingual broadcast, select “A” for sound channel 1, “B” for sound channel 2, or “Mono” for a mono channel, if available.

Tip

If you select other equipment connected to the TV, set “Dual Sound” to “Stereo”, “A” or “B”.

Tip

Sound menu options other than “Dual Sound” cannot be used for headphones and audio output sockets.

Screen menu

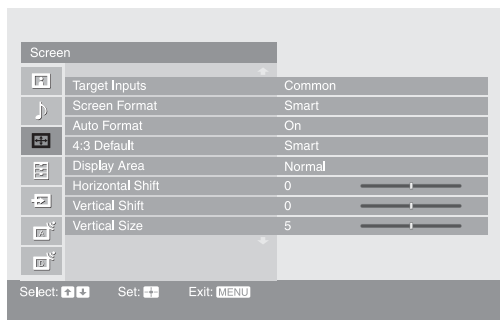

You can select the options listed below on the Screen menu. To select options in “Settings”, refer to “Picture menu” (page 25).

Target Inputs

For the input currently being viewed, select whether to use the common setting or to set each item separately.

“Common”: Applies common settings whose adjustments are shared with other inputs in which “Target Inputs” is set to “Common”.

Current input name (e.g. AV1): Allows you to set each option separately for the current input.

Tip

Set each input to “Common” if you require the same settings to apply to each input.

Screen Format

For details about the screen format, see “To change the screen format manually to suit the broadcast” (page 18).

Auto Format

Automatically changes the screen format according to the broadcast signal. To keep your setting, select “Off”.

Tip

Even if “Auto Format” is set to “On” or “Off”, you can always modify the format of the screen by pressing **ASPECT** repeatedly.

4:3 Default

Selects the default screen format for use with 4:3 broadcasts.

“Smart”: Displays conventional 4:3 broadcasts with an imitation wide screen effect.

“4:3”: Displays conventional 4:3 broadcasts in the correct proportions.

“Off”: Keeps the current “Screen Format” setting when the channel or input is changed.

Tip

This option is available only if “Auto Format” is set to “On”.

Display Area

Adjusts the screen area displaying the picture.

“Normal”: Displays the picture in the original size.

“-1”/“-2”: Enlarges the picture to hide the edge of the picture.

Horizontal Shift

Adjusts the horizontal position of the picture.

Vertical Shift

Adjusts the vertical position of the picture when the screen format is set to “Smart”, “Zoom” or “14:9”.

Vertical Size

Adjusts the vertical size of the picture when the screen format is set to “Smart”.

Set-up menu

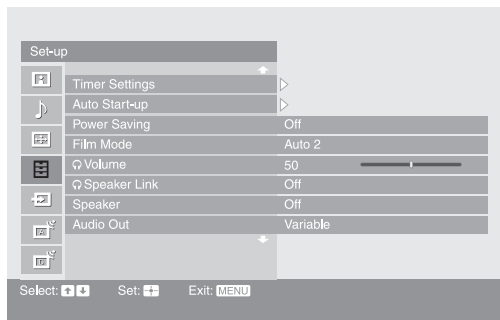

You can select the options listed below on the Set-up menu. To select options in “Settings”, refer to “Picture menu” (page 25).

Timer Settings

Sets the timer to switch on/off the TV.

Sleep Timer

Sets a period of time after which the TV automatically switches itself into standby mode.

When the Sleep Timer is activated, the  (Timer) indicator on the TV (front) lights up in orange.

Tips

- If you switch off the TV and switch it on again, “Sleep Timer” is reset to “Off”.
- “TV will soon turn off by Sleep Timer” appears on the screen one minute before the TV switches to standby mode.

On Timer

Sets the timer to switch on the TV from standby mode.

“Day”: Selects the day on which you want to activate the On Timer.

“Time”: Sets the time to switch on the TV.

“Duration”: Selects the time period after which the TV automatically switches to standby mode again.

“Volume Set-up”: Sets the volume for when the timer switches on the TV.

Clock Set

Allows you to adjust the clock manually. When the TV is receiving digital channels, the clock cannot be adjusted manually since it is set to the time code of the broadcasted signal.



Auto Start-up

Starts the “first time operation menu” to select the language and country/region, tune in all available digital and analogue channels, and set the time (only when no digital channels are received). Usually, you do not need to do this operation because the language and country/region will have been selected and channels already tuned when the TV was first installed (page 7, 8). However, this option allows you to repeat the process (e.g. to retune the TV after moving house, or to search for new channels that have been launched by broadcasters).

Power Saving

Reduces the power consumption by adjusting the lamp brightness. This also enhances the black level. Select “Auto” (only for KDS-70R2000), “On” or “Off”.

Continued

Film Mode	<p>Provides smoother picture movement when playing DVD or VCR images taken on film, reducing picture blur and graininess.</p> <p>“Auto 1”: For a stable picture with minimal noise. Set to “Auto 2” if the screen is partially degraded.</p> <p>“Auto 2”: Use this setting for standard use.</p> <p>“Off”: Turns off the Film mode.</p> <p>Notes</p> <ul style="list-style-type: none"> • Even if “Auto 1” or “Auto 2” is selected, “Film Mode” will be automatically turned off and a moving image will not be played smoothly if the image contains irregular signals or too much noise. • Film Mode is not available when using Freeze or PAP features, or when watching 480p, 576p, 720p, 1080i or 1080p sources.
 Volume (headphone volume)	Adjusts the volume of the headphones when “  Speaker Link” is set to “Off”.
 Speaker Link (headphone speaker link)	<p>Switches the TV’s internal speakers on/off when headphones are connected.</p> <p>“On”: Sound is output only from headphones.</p> <p>“Off”: Sound is output from both the TV and headphones.</p>
Speaker	<p>Switches on/off the TV’s internal speakers.</p> <p>“On”: The TV speakers are turned on in order to listen to the TV’s sound through the TV speakers.</p> <p>“Off”: The TV speakers are turned off in order to listen to the TV’s sound only through your external audio equipment connected to the audio output sockets.</p>
Audio Out	<p>“Variable”: The audio output from your audio system can be controlled by the TV’s remote.</p> <p>“Fixed”: The audio output of the TV is fixed. Use your audio receiver’s volume control to adjust the volume (and other audio settings) through your audio system.</p>
Cooling Mode	Select “High” to use the TV at an altitude of 1,500 m or higher, or to use the TV in certain circumstances where there is a considerable rise in temperature inside the TV. Select “Normal” to use the TV at normal altitudes.
Lamp Replacement	<p>When the lamp nears the end of its life, a message appears every time you switch on the TV. After you replace the lamp, select this option and follow the on-screen procedure.</p> <p>Notes</p> <ul style="list-style-type: none"> • Select this option after you replace the lamp. • Depending on environmental and other conditions, such as frequency of use, some lamps may burn out before the lamp replacement message appears on the screen. • Until you set the Lamp Replacement option, a message announcing that the lamp is at the end of its life will appear every time you switch on the TV.
Display Position	Adjust the horizontal/vertical position of the picture including menu displays and messages, etc. on the TV screen.
Language	Selects the language in which the menus are displayed.
Information	Displays your TV’s product information.

All Reset

Resets all settings to the factory settings and then displays the Auto Start-up screen.

Notes

- All settings, including Digital Favourite list, country, language, auto tuned channels, etc. will be reset.
 - The On/standby indicator flashes in green while the settings are being reset.
-

AV Set-up menu

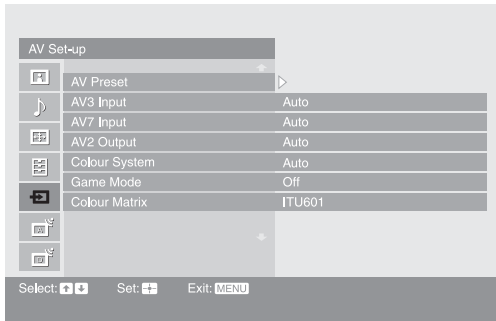

You can select the options listed below on the AV Set-up menu. To select options in "Settings", refer to "Picture menu" (page 25).

AV Preset

Assigns a name to any equipment connected to the side and rear sockets. The name will be displayed briefly on the screen when the equipment is selected. You can skip input signals from connected equipment that you do not want displayed on the screen.

- 1 Press \uparrow/\downarrow to select the desired input source, then press \oplus .
- 2 Press \uparrow/\downarrow to select the desired option below, then press \oplus .

Equipment labels: Uses one of the preset labels to assign a name to connected equipment.

"Edit": Creates your own label. Follow steps 2 to 4 of "Programme Labels" (page 36).

"Skip": Skips an unnecessary input source.

AV3 Input

Sets a signal to be input through the socket labelled $\leftrightarrow/\rightarrow/\rightarrow$ 3 on the rear of the TV.

"Auto": Switches automatically among the signals of RGB input, S video input, Composite video input depending on the input signal.

"RGB": Inputs the RGB signal.

"S Video": Inputs the S Video signal.

"Composite": Inputs the Composite video signal.

AV7 Input

Sets a signal to be input through the sockets labeled $\rightarrow/\rightarrow/\rightarrow$ 7 on the front of the TV.

"Auto": Switches automatically between the component video sockets and the composite video sockets depending on the cable connection.

"Component": Activates the component video sockets.

"Composite": Activates the composite video sockets.

Tip

When multiple cables are connected and "Auto" is selected, "Component", "Composite" will be activated in that order.

AV2 Output

Sets a signal to be output through the socket labelled $\leftrightarrow/\rightarrow/\rightarrow$ 2 on the rear of the TV. If you connect a VCR or other recording equipment to the $\leftrightarrow/\rightarrow/\rightarrow$ 2 socket, you can then record from the equipment connected to other sockets of the TV.

"TV": Outputs a broadcast.

"AV1": Outputs signals from equipment connected to the $\leftrightarrow/\rightarrow/\rightarrow$ 1 socket.

"AV3": Outputs signals from equipment connected to the $\leftrightarrow/\rightarrow/\rightarrow/S\rightarrow$ 3 socket.

"AV7": Outputs signals from equipment connected to the $\rightarrow/\rightarrow/\rightarrow$ 7 socket.

"Auto": Outputs whatever is being viewed on the screen (except signals from the $\rightarrow/\rightarrow/\rightarrow$ 4, HDMI IN 5, HDMI IN 6 and PC IN \rightarrow/\rightarrow RGB/ \rightarrow sockets).

Colour System

Selects the colour system (“Auto”, “PAL”, “SECAM”, “NTSC3.58” or “NTSC4.43”) according to the input signal from the input source.

Game Mode

Depending on the game software, reaction times may slow during fast-moving scenes, etc. Select “On” to improve the reaction times.

Colour Matrix

Usually used in the factory setting (AV1/2/3/7 (Composite and S video input signal) is set to “ITU601”, and AV4/5/6/7 (Component input signal) is set to “Auto”). If the tone of the picture from the input source is unnatural, select either “ITU601” or “ITU709”, which normalizes the tone.

Analogue Set-up menu



You can select the options listed below on the Analogue Set-up menu. To select options in “Settings”, refer to “Picture menu” (page 25).

1 Digit Direct

When “1 Digit Direct” is set to “On”, you can select an analogue channel using one preset number button (0 - 9) on the remote.

Note

When “1 Digit Direct” is set to “On”, you cannot select channel numbers 10 and above entering two digits using the remote.

Auto Tuning

Tunes in all the available analogue channels.

Usually you do not need to do this operation because the channels are already tuned when the TV was first installed (page 8). However, this option allows you to repeat the process (e.g. to retune the TV after moving house, or to search for new channels that have been launched by broadcasters).

Programme Sorting

Changes the order in which the analogue channels are stored on the TV.

- 1 Press \uparrow/\downarrow to select the channel you want to move to a new position, then press \oplus .
- 2 Press \uparrow/\downarrow to select the new position for your channel, then press \oplus .

Programme Labels

Assigns a channel name of your choice up to five letters or numbers. The name will be displayed briefly on the screen when the channel is selected. (Names for channels are usually taken automatically from Analogue Text (if available).)

- 1 Press \uparrow/\downarrow to select the channel you want to name, then press \oplus .
- 2 Press \uparrow/\downarrow to select the desired letter or number (“_” for a blank space), then press \Rightarrow .

If you input a wrong character

Press \Leftarrow/\Rightarrow to select the wrong character. Then, press \uparrow/\downarrow to select the correct character.

To delete all the characters

Select “Reset”, then press \oplus .

- 3 Repeat the procedure in step 2 until the name is complete.
 - 4 Select “OK”, then press \oplus .
-

Manual Programme Preset

Before selecting “Label”/“AFT”/“Audio Filter”/“Skip”/“Decoder”, press PROG +/- to select the programme number with the channel. You cannot select a programme number that is set to skip (page 38).

Programme/System/Channel

Presets programme channels manually.

- 1 Press \uparrow/\downarrow to select “Programme”, then press \oplus .
- 2 Press \uparrow/\downarrow to select the programme number you want to manually tune (if tuning a VCR, select channel 00), then press RETURN.
- 3 Press \uparrow/\downarrow to select “System”, then press \oplus .
- 4 Press \uparrow/\downarrow to select one of the following TV broadcast systems, then press RETURN.

B/G: For western European countries/regions

I: For the United Kingdom

D/K: For eastern European countries/regions

L: For France

- 5 Press \uparrow/\downarrow to select “Channel”, then press \oplus .
- 6 Press \uparrow/\downarrow to select “S” (for cable channels) or “C” (for terrestrial channels), then press \rightleftarrows .

Note

“S” is not available when “United Kingdom” is selected for “Country” (page 8).

- 7 Tune the channels as follows:

If you do not know the channel number (frequency)

Press \uparrow/\downarrow to search for the next available channel. When a channel has been found, the search will stop. To continue searching, press \uparrow/\downarrow .

If you know the channel number (frequency)

Press the number buttons to enter the channel number of the broadcast you want or your VCR channel number.

- 8 Press \oplus to jump to “Confirm”, then press \oplus .
- 9 Press \downarrow to select “OK”, then press \oplus .

Repeat the procedure above to preset other channels manually.

Label

Assigns a name of your choice, up to five letters or numbers, to the selected channel. This name will be displayed briefly on the screen when the channel is selected. To input characters, follow steps 2 to 4 of “Programme Labels” (page 36).

AFT

Allows you to fine-tune the selected programme number manually if you feel that a slight tuning adjustment will improve the picture quality.

You can adjust the fine tuning over a range of -15 to +15. When “On” is selected, the fine tuning is performed automatically.

Audio Filter

Improves the sound for individual channels in the case of distortion in mono broadcasts. Sometimes a non-standard broadcast signal can cause sound distortion or intermittent sound muting when watching mono programmes.

If you do not experience any sound distortion, we recommend that you leave this option set to the factory setting “Off”.



Notes

- You cannot receive stereo or dual sound when “Low” or “High” is selected.
- “Audio Filter” is not available when “System” is set to “L”.

Skip

Skips unused analogue channels when you press PROG +/- to select channels. (You can still select a skipped channel using the number buttons.)

Decoder

Views and records the scrambled channel selected when using a decoder connected directly to scart connector  1, or to scart connector  2 via a VCR.

Note

This option is not available when “United Kingdom” is selected for “Country” (page 8).

Confirm

Saves changes made to the “Manual Programme Preset” settings.

Digital Set-up menu DV3



You can select the options listed below on the Digital Set-up menu. To select options in “Settings”, refer to “Picture menu” (page 25).

Note

Some functions may not be available in some countries.

Digital Settings

Displays the “Digital Settings” menu.

Subtitle Setting

Displays digital subtitles on the screen.

When “For Hard Of Hearing” is selected, some visual aids may also be displayed with the subtitles (if TV channels broadcast such information).

Subtitle Language

Selects which language subtitles are displayed in.

Audio Language

Selects the language used for a programme. Some digital channels may broadcast several audio languages for a programme.

Audio Type

Increases the sound level when “For Hard Of Hearing” is selected.

Parental Lock

Sets an age restriction for programmes. Any programme that exceeds the age restriction can only be watched after a PIN Code is entered correctly.

1 Press the number buttons to enter your existing PIN code.

If you have not previously set a PIN, a PIN code entry screen appears. Follow the instructions of “PIN Code” below.

2 Press \uparrow/\downarrow to select the age restriction or “None” (for unrestricted watching), then press \oplus .

3 Press RETURN.

PIN Code

Sets a PIN code for the first time, or allows you to change your PIN code.

1 Enter a PIN as follows:

If you have previously set a PIN

Press the number buttons to enter your existing PIN.

If you have not set a PIN

Press the number buttons to enter the factory setting PIN of 9999.

2 Press the number buttons to enter the new PIN code.

A message appears to inform you that the new PIN has been accepted.

3 Press RETURN.

Tip

PIN code 9999 is always accepted.

Technical Set-up

Displays the Technical Set-up menu.

“Auto Service Update”: Enables the TV to detect and store new digital services as they become available.

“Software Download”: Enables the TV to automatically receive software updates free through your existing aerial (when issued). It is recommended that this option be set to “On” at all times. If you do not want your software to be updated, set this option to “Off”.

“System Information”: Displays the current software version and the signal level.

“Time Zone”: Allows you to manually select the time zone you are in, if it is not the same as the default time zone setting for your country.

CA Module Set-up

Allows you to access a Pay Per View service once you obtain a Conditional Access Module (CAM) and a view card. See page 43 for the location of the  (PCMCIA) socket.

Notes

- CAM is not supported in all countries. Check with your authorized dealer.
- “CA Module Set-up” is available only when a CAM is inserted.

Digital Tuning

Displays the “Digital Tuning” menu.

Digital Auto Tuning

Tunes in all the available digital channels.

Usually you do not need to do this operation because the channels were already tuned when the TV was first installed (page 8). However, this option allows you to repeat the process (e.g. to retune the TV after moving house, or to search for new channels that have been launched by broadcasters).

Programme List Edit

Removes any unwanted digital channels stored on the TV, and changes the order of the digital channels stored on the TV.



- 1 Press  to select the channel you want to remove or move to a new position.

If you know the programme number



Press the number buttons to enter the three-digit programme number of the broadcast you want.

- 2 Remove or change the order of the digital channels as follows:

To remove the digital channel

Press . A message that confirms whether the selected digital channel is to be deleted appears. Press  to select “Yes”, then press .





To change the order of the digital channels

Press , then press  to select the new position for the channel and press . Repeat the procedure in steps 1 and 2 to move other channels if required.

- 3 Press RETURN.

Digital Manual Tuning

Tunes the digital channels manually.

- 1 Press the number button to select the channel number you want to manually tune, then press  to tune the channel.
- 2 When the available channels are found, press  to select the channel you want to store, then press .
- 3 Press  to select the programme number where you want to store the new channel, then press .

Repeat the above procedure to manually tune other channels.

PC Settings menu

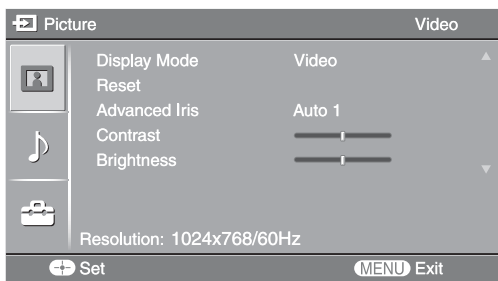

You can select the options listed below on the PC Settings menu when the TV is connected to a PC.

- 1 Press \rightarrow / \leftarrow repeatedly until \rightarrow PC appears on the screen.
- 2 Press MENU to display the PC settings menu.

Note

When you connect a PC to your TV for the first time, you may need to adjust the screen display. In such cases, perform “Auto Adjustment” or adjust the “Phase”, “Pitch”, “Horizontal Shift”, or “Vertical Shift” in “Others” (page 42).

Picture

Display Mode	Selects the display mode. “Video”: Select to view video images. “Text”: Select to view text, charts or tables.
Reset	Resets all the “Picture” settings except “Display Mode” to the factory settings.
Advanced Iris	By selecting the iris option, you can obtain the best brightness and contrast suited for your TV viewing. “Auto 1”*: Recommended option for viewing programmes that have larger variation in brightness from scene to scene. “Auto 2”*: Recommended option for viewing programmes that have less variation in brightness from scene to scene. “Max”: With this option, the screen has maximum level of brightness. It is suitable for TV viewing in a brightly lit room. “High”: With this option, the screen becomes bright. It is suitable for TV viewing in a brightly lit room. “Medium”: With this option, the brightness is about the standard level. “Low”: With this option, the screen brightness dims and increases in contrast. It is suitable for TV viewing in a room with low lighting. “Min”: With this option, the screen is dimmed but contrast is at a maximum. It is suitable for TV viewing in a room with low lighting. * Automatically detects the brightness of the screen. These options are best suited for programmes such as movies that often change between bright scenes and low light setting scenes.
	Note You cannot select “Auto 1” or “Auto 2” when “Display Mode” is set to “Text”.
Contrast	Increases or decreases picture contrast.
Brightness	Brightens or darkens the picture.

Continued

Colour Temperature

Adjusts the whiteness of the picture.

“Cool”: Gives the white colours a blue tint.

“Neutral”: Gives the white colours a neutral tint.

“Warm 1”/“Warm 2”: Gives the white colours a red tint. “Warm 2” gives a redder tint than “Warm 1”.

Sound

Sound Mode

Selects the sound mode.

“Dynamic”: Enhances treble and bass.

“Standard”: For standard sound. Recommended for home entertainment.

“Custom”: Provides a flat response. Sound quality as customized on the connected PC is maintained in the TV sound.

Others

Auto Adjustment

Automatically adjusts the display position, phase and pitch of the picture when the TV receives an input signal from a connected PC.

Tip

Auto Adjustment may not work well with some input signals. In such cases, manually adjust “Phase”, “Pitch”, “Horizontal Shift” and “Vertical Shift”.

Reset

Resets all the “Others” settings to the factory settings.

Phase

Adjusts the phase when the screen flickers.

Pitch

Adjusts the pitch when the picture has unwanted vertical stripes.

Horizontal Shift

Adjusts the horizontal position of the picture.

Vertical Shift

Adjusts the vertical position of the picture.

Screen Format

Selects the screen format for signals with a 60 Hz vertical frequency.

“Normal”: Displays the picture in its original size.

“Full1”: Enlarges the picture to fill the display area, keeping its original horizontal-to-vertical aspect ratio.

“Full2”: Enlarges the picture to fill the display area.

Connecting optional equipment

You can connect a wide range of optional equipment to your TV. Connecting cables are not supplied.

Connecting to the TV (front)

KDS-55A2000

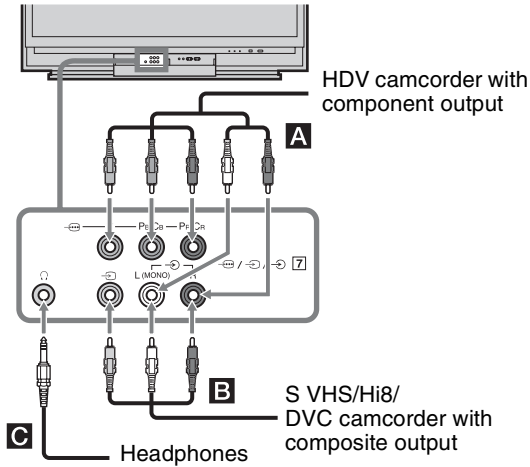

KDS-70R2000

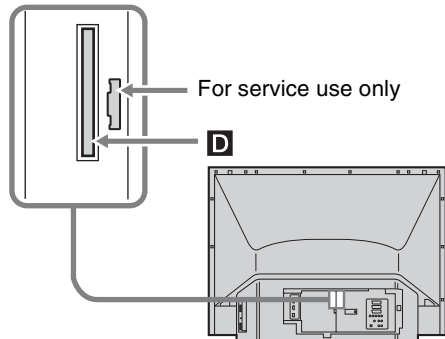
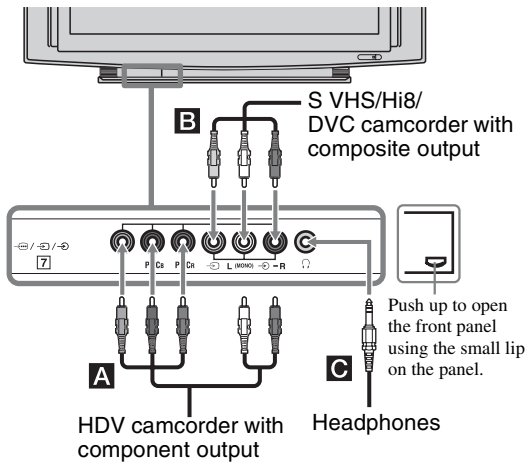

To connect	Do this
HDV camcorder with component output A	Connect to the component video Y, Pb/Cb, Pr/Cr sockets → 7 and audio L (MONO), R sockets → 7.
S VHS/Hi8/DVC camcorder with composite output B	Connect to the composite video socket → 7, and the audio sockets → 7. If you connect mono equipment, connect to the L socket → 7.
Headphones C	Connect to the 7 socket to listen to sound from the TV on headphones.
Conditional Access Module (CAM) D	To use Pay Per View services. For details, refer to the instruction manual supplied with your CAM. To use the CAM, press the eject button and remove the "dummy" card. Switch off the TV when inserting your CAM into the CAM slot. When you do not use the CAM, we recommend that the "dummy" card be inserted and kept in the CAM slot. Note CAM is not supported in all countries. Check with your authorized dealer.

Tip
You can select the front socket input signals by setting "AV7 Input" in the "AV Set-up" menu (page 34).

Continued

Connecting to the TV (rear)

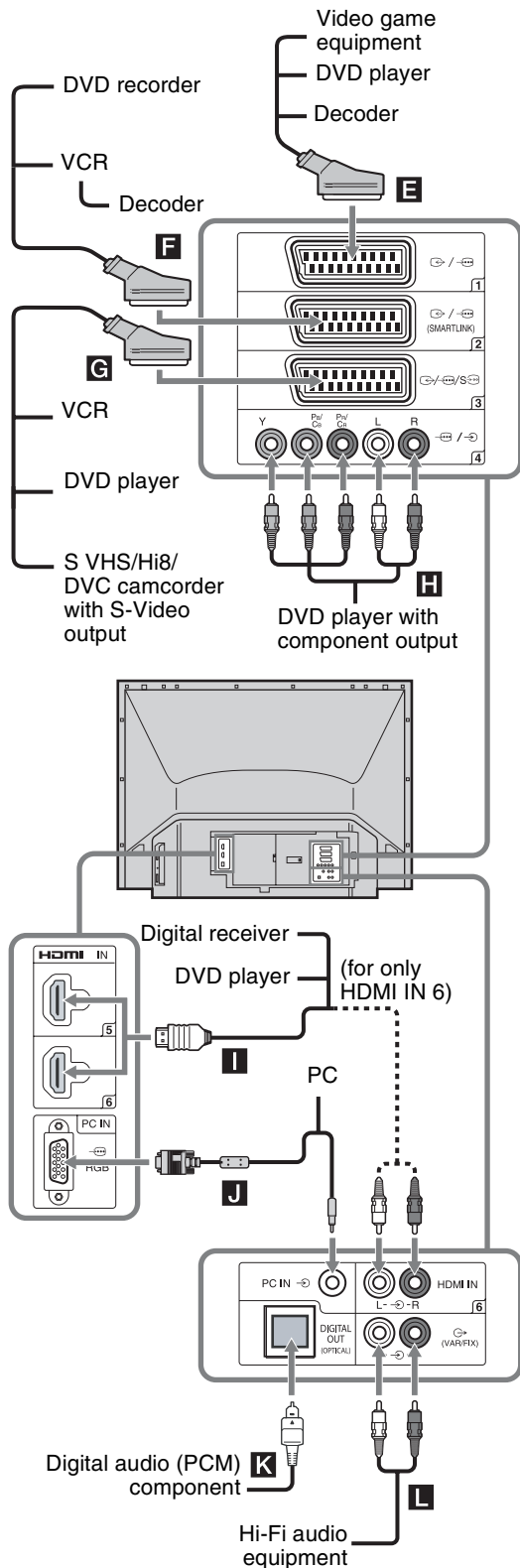

To connect

Do this

Video game equipment, DVD player or decoder **E**

Connect to the scart socket 1. When you connect the decoder, the scrambled signal from the TV tuner is output to the decoder, then the unscrambled signal is output from the decoder.

DVD recorder or VCR that supports SmartLink **F**

Connect to the scart socket 2. SmartLink is a direct link between the TV and a VCR/DVD recorder.

VCR, DVD player or S VHS/Hi8/DVC camcorder with S-Video output **G**

Connect to the scart socket 3. You can select the input signals by setting "AV3 Input" in the "AV Set-up" menu (page 34). If the equipment has an S Video socket, connect it through an S Video - scart adaptor interface (not supplied).

DVD player with component output **H**

Connect to the component sockets and the audio sockets 4.

Digital receiver or DVD player **I**

Connect to the HDMI IN 5 or 6 socket if the equipment has a HDMI socket. The digital video and audio signals are input from the equipment. If the equipment has a DVI socket, connect the DVI socket to the HDMI IN 6 socket through a DVI - HDMI adaptor interface (not supplied), and connect the equipment's audio out sockets to the audio in the HDMI IN 6 sockets.

Notes

- The HDMI sockets only support the following video inputs: 480i, 480p, 576i, 576p, 720p, 1080i and 1080p. To connect a PC, use the PC IN RGB/ sockets.
- Be sure to use only an HDMI cable that bears the HDMI logo.

PC **J**

Connect to the PC IN RGB/ sockets. It is recommended to use a PC cable with ferrites.

To connect	Do this
Digital audio (PCM) component K	Connect to the DIGITAL OUT (OPTICAL) socket using the Optical audio cable. Note The DIGITAL OUT (OPTICAL) socket only supports digital terrestrial signals.
Hi-Fi audio equipment L	Connect to the audio output sockets  to listen to the sound from the TV on Hi-Fi audio equipment.



Programming the remote

This remote is preset to operate Sony TVs, most Sony DVDs, VCRs and AMPs (Home Theatre, etc.). To control VCRs and DVDs of other manufacturers (and some other Sony VCR, DVD and AMP models), do the following procedure to programme the remote.

Note

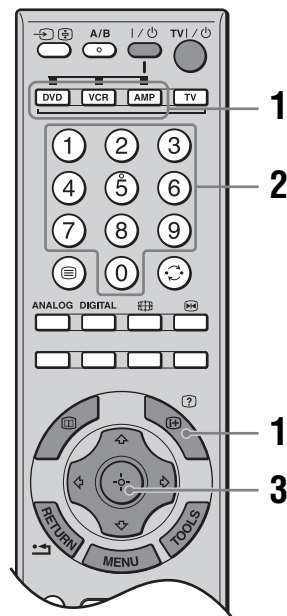
Before you start, look up the three-digit code for your brand of DVD, VCR or AMP from the “Manufacturer’s codes” on page 46.



- 1** Press and hold the DVD, VCR or AMP function button you want to programme on the remote, then press , keeping the function button pressed down.
The selected function button (DVD, VCR or AMP) will flash.
 - 2** Press the number buttons to enter the three-digit manufacturer’s code number while the button is lit. If code is not entered within 10 seconds, you must perform the step 1 again.
 - 3** Press .
- When the programming is correct, the selected function button will flash twice, and when not, it will flash five times.

Continued

4 Switch on your equipment and check that the following main functions work.

▷ (playback), ■ (stop), ◀◀ (rewind), ▶▶ (fast forward), channel selection for both VCR and DVDs, TOP MENU/MENU and ↕/↔/↔/↔ only for DVDs.

If your equipment is not working, or some of the functions do not work

Enter the correct code or try the next code listed for the brand. However, not all models of every brand may be covered.

To return to normal TV operation

Press the TV function button.

Manufacturer's codes

VCR brand list

Brand	Code
SONY	301, 302, 303, 304, 305, 306, 307, 308, 309, 310, 362
AIWA	325, 331, 351
AKAI	326, 329, 330
DAEWOO	342, 343
GRUNDIG	358, 355, 360, 361, 320, 351, 366
HITACHI	327, 333, 334
JVC	314, 315, 322, 344, 352, 353, 354, 348, 349
LG	332, 338
LOEWE	358, 355, 360, 361, 320, 351
MATSUI	356, 357
ORION	328
PANASONIC	321, 323
PHILIPS	311, 312, 313, 316, 317, 318, 358, 359, 363, 364
SAMSUNG	339, 340, 341, 345
SANYO	335, 336
SHARP	324
THOMSON	319, 350, 365
TOSHIBA	337

DVD brand list

DVD Player

Brand	Code
SONY	001, 029, 030, 036, 037, 038, 039, 040, 041, 042, 043, 044, 053, 054, 055
AIWA	021
AKAI	032
DENON	018, 027, 020, 002
GRUNDIG	009, 028, 023, 024, 016, 003
HITACHI	025, 026, 015, 004, 035
JVC	006, 017
KENWOOD	008
LG	015, 014, 034
LOEWE	009, 028, 023, 024, 016, 003
MATSUI	013, 016
ONKYO	022, 033
PANASONIC	018, 027, 020, 002, 045, 046, 047
PHILIPS	009, 028, 023, 024, 016, 003, 031
PIONEER	004, 050, 051, 052
SAMSUNG	011, 014
SANYO	007
SHARP	019, 027
THOMSON	012
TOSHIBA	003, 048, 049
YAMAHA	018, 027, 020, 002

DVD/VCR Player

Brand	Code
SONY	101

DVD recorder

Brand	Code
SONY	201, 202, 203

AUX Sony systems brand list

DAV Home Theatre System

Brand	Code
SONY (DAV)	401, 402, 403, 404

AV receiver

Brand	Code
SONY	451, 452, 453, 454

Digital terrestrial receiver

Brand	Code
SONY	501, 502, 503

Replacing the lamp

The Projection lamp, like all lamps, will eventually lose brightness and functionality which affects the overall performance of your TV. How long the Lamp maintains its brightness will vary depending upon your usage and environmental conditions. To maintain the quality of your viewing experience, Sony recommends that you replace the Lamp (1) when the screen becomes dark or the colour looks unusual; (2) when  on the front of the TV flashes; (3) after approximately 8,000 hours of use (for KDS-55A2000) or 4,000 hours of use (for KDS-70R2000); or (4) when the lamp replacement message appears on the TV screen.

WARNING

Electric appliances can cause fire or high temperature, resulting in injury or death. Be sure to follow the instructions below.

- Use only a Sony XL-5200 (for KDS-55A2000, not supplied) or XL-5300 (for KDS-70R2000, supplied) replacement lamp for replacement. Use of any other lamp may damage the TV.
- Do not remove the lamp for any purpose other than replacement. Doing so may cause injury or fire.
- Do not put flammable materials and metal objects inside the lamp receptacle of the TV after removing the lamp. Doing so may cause fire or electrical shock. Do not touch the lamp receptacle once the lamp has been removed.
- When the lamp eventually burns out, you may hear a noticeable “pop” sound. This is normal and it is inherent to this type of lamp.
- In rare instances, the bulb may pop inside the lamp unit, but the lamp unit is designed to contain all of the broken glass pieces inside the lamp unit.
- This TV’s lamp contains mercury and should be disposed of properly. Consult your local authorities regarding safe disposal. The material contained in this lamp are similar to those of a fluorescent lamp, so you should dispose of it in the same way.

1 Switch off the TV. Wait several minutes, then unplug the mains lead.
(The cooling fan will continue to operate for about two minutes after switching the TV off.)

2 Wait at least 30 minutes after unplugging the mains lead to allow the lamp to cool down before replacing it. To avoid being burned, do not touch the lamp receptacle once the lamp has been removed.

3 Take the new lamp out of its package. Do not touch the glass portion of the new lamp.

Notes

- Do not shake the lamp. Vibration can damage the lamp or shorten its life.
- Avoid touching the front glass of a new lamp or the glass of the lamp receptacle. This may reduce picture quality or lamp life.

4 Remove the outside lamp cover.

KDS-55A2000

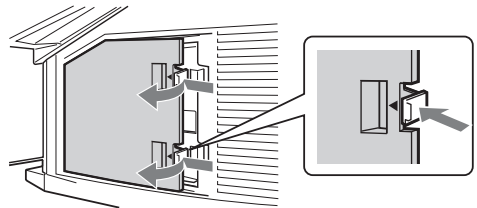

KDS-70R2000

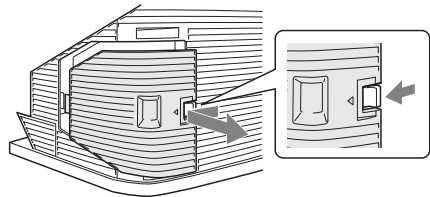

5 Remove the lamp door.
Turn the screw counterclockwise. Then slide the lever to the left (KDS-55A2000) or turn the knob to the left until the marks on the lid and the case line up (KDS-70R2000). Remove the door.

KDS-55A2000

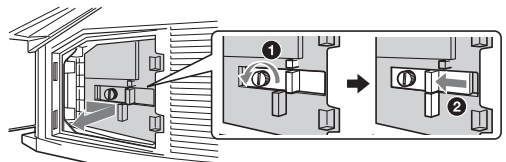

KDS-70R2000

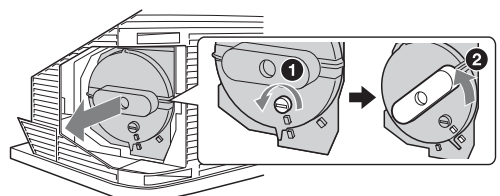

- 6** Pull out the lamp.
Hold the indented grooves of the lamp as shown, and pull the lamp straight out. If the lamp is hard to remove, pull the right side of the lamp for additional traction (KDS-55A2000).

KDS-55A2000

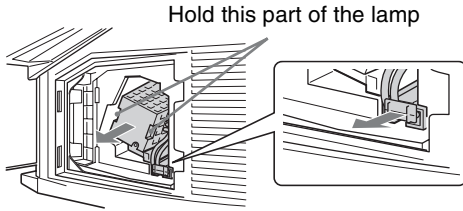

KDS-70R2000

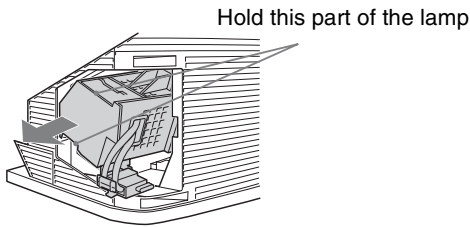

Notes

- Do not touch the inside of the lamp compartment.
- The lamp is very hot immediately after use. Never touch the glass portion of the lamp or the surrounding parts.
- After the used lamp has cooled, place it into the empty box of the replacement lamp. Never put the used lamp into a plastic bag.

- 7** Put the new lamp into its place.
Make sure the lamp is securely mounted into the compartment. Failure to do so may cause a fire or the screen to go dark.

KDS-55A2000

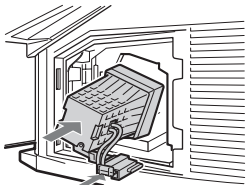

KDS-70R2000

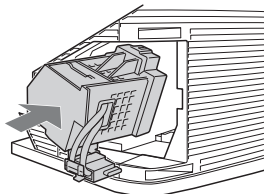

Notes

- The lamp compartment is tilted.
- If the lamp is not securely reattached, the self-diagnostic function may be triggered and  flashes in red three times (page 15).

KDS-55A2000

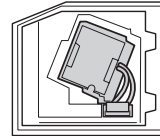

KDS-70R2000

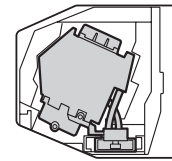

- 8** Reattach the lamp door.
For KDS-55A2000, replace the door by inserting the two tabs in the slot from the left side. Slide the lever to the right and then turn the screw clockwise to secure the door.
For KDS-70R2000, turn the knob to the right while pushing the door in, until the marks on the lid and the case line up. Then turn the screw clockwise to secure the door.

KDS-55A2000

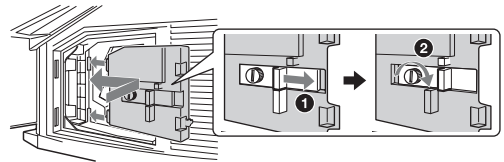

KDS-70R2000

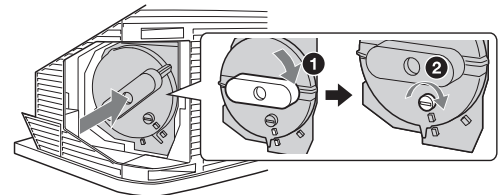

- 9** Put the outside lamp cover back in its place.
Replace the cover, inserting it from the left side. Press the two tabs on the right side (KDS-55A2000) or press the clamp on the right side (KDS-70R2000) to secure the cover.

KDS-55A2000

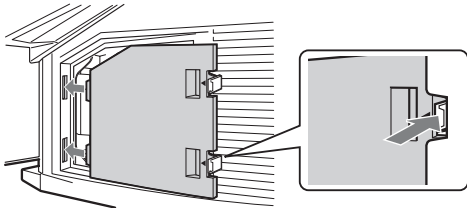

KDS-70R2000

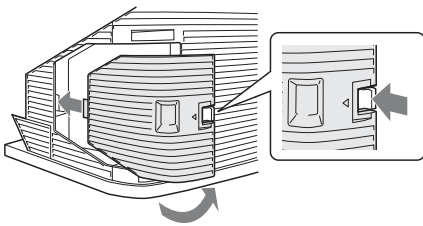

- 10** Turn on the TV and set the Lamp Replacement option in the Set-up menu (page 32). This setting is necessary to inform you when the next lamp replacement is needed.

Notes

- Until you set the Lamp Replacement option, a message announcing that the lamp is at the end of its life will appear every time you switch on the TV.
- Consult your Sony dealer for a Sony XL-5200 (for KDS-55A2000) or XL-5300 (for KDS-70R2000) replacement lamp.
- Take great care when replacing the lamp or plugging in/unplugging the connecting cords. Rough handling may cause the TV to fall, damaging the TV, the TV stand and the floor.

Specifications

Display Unit

Power Requirements:

220–240 V AC, 50 Hz

Projection System:

3 SXRD Panel, 1 lens projection system

SXRD Panel:

Size 0.61 inch SXRD panel

Resolution 1920 × 1080 pixels

Projection Lenses:

High performance, large-diameter hybrid lens F2.5

Lamp:

KDS-70R2000:

Ultra high pressure lamp, 180 W, XL-5300

KDS-55A2000:

Ultra high pressure lamp, 120 W, XL-5200

Screen Size:

KDS-70R2000:

70 inches (Approx. 177.8 cm measured diagonally)

KDS-55A2000:

55 inches (Approx. 139.7 cm measured diagonally)

Power Consumption:

KDS-70R2000: 285 W

KDS-55A2000: 210 W

Standby Power Consumption*:

0.5 W

* Specified standby power is reached after the TV finishes necessary internal processes.

Dimensions (w × h × d):

KDS-70R2000:

Approx. 1,885 × 1,154 × 611 mm (with speakers)

Approx. 1,714 × 1,154 × 611 mm (without speakers)

KDS-55A2000:

Approx. 1,292 × 913 × 480 mm

Mass:

KDS-70R2000:

Approx. 74 kg

KDS-55A2000:

Approx. 39 kg

TV System

Analogue: Depending on your country/region selection:

B/G/H, D/K, L, I

Digital: DVB-T

Colour/Video System

Analogue: PAL, SECAM

NTSC 3.58, 4.43 (only Video In)

Digital: MPEG-2 MP@ML

Aerial

75 ohm external terminal for VHF/UHF

Channel Coverage

Analogue: VHF: E2–E12

UHF: E21–E69

CATV: S1–S20

HYPERS: S21–S41

D/K: R1–R12, R21–R69

L: F2–F10, B–Q, F21–F69

I: UHF B21–B69

Digital: VHF/UHF

Terminals

 1

21-pin scart connector (CENELEC standard) including audio/video input, RGB input, and TV audio/video output.

 2 (SmartLink)

21-pin scart connector (CENELEC standard) including audio/video input, RGB input, selectable audio/video output, and SmartLink interface.

 /  /  3

21-pin scart connector (CENELEC standard) including audio/video input, RGB input, S video input, and audio/video output which currently appears on the screen.

 4

Supported formats: 1080i, 720p, 576p, 576i, 480p, 480i

Y: 1 V_{p-p}, 75 ohms, 0.3V negative sync

P_B/C_B: 0.7 V_{p-p}, 75 ohms

P_R/C_R: 0.7 V_{p-p}, 75 ohms

 4

Audio input (phono jacks)

500 mVrms

Impedance: 47 kilohms

HDMI IN 5, 6

Video: 1080p, 1080i, 720p, 576p, 576i, 480p, 480i

Audio: Two channel linear PCM

32, 44.1 and 48 kHz, 16, 20 and 24 bits

Analogue audio (phono jacks):

500 mVrms, Impedance 47 kilohms

(HDMI IN 6 only)

 7

Supported formats: 1080i, 720p, 576p, 576i, 480p, 480i

Y: 1 V_{p-p}, 75 ohms, 0.3V negative sync

P_B/C_B: 0.7 V_{p-p}, 75 ohms

P_R/C_R: 0.7 V_{p-p}, 75 ohms

 7 Video input (phono jack)

 7 Audio input (phono jacks)

 DIGITAL OUT (OPTICAL OUT jack)

 Audio output (phono jacks)

PC IN  RGB PC Input (D-sub 15-pin) (see page 52)

G: 0.7 V_{p-p}, 75 ohms, non Sync on Green

B: 0.7 V_{p-p}, 75 ohms

R: 0.7 V_{p-p}, 75 ohms

HD: 1-5 V_{p-p}

VD: 1-5 V_{p-p}

PC IN  PC audio input (minijack)

 Headphones jack

 CAM (Conditional Access Module) slot

Sound Output

KDS-70R2000: 15 W + 15 W

KDS-55A2000: 12 W + 12 W

Supplied Accessories

Refer to “1: Checking the accessories” on page 4.

Optional Accessories

TV stand:

SU-RS51U (for KDS-70R2000)

SU-RS11X (for KDS-55A2000)

Design and specifications are subject to change without notice.

Continued

PC Input Signal Reference Chart

Signals	Horizontal (Pixel)	Vertical (Line)	Horizontal frequency (kHz)	Vertical frequency (Hz)	Standard
VGA	640	480	31.5	60	VGA
	640	480	37.5	75	VESA
	720	400	31.5	79	VGA-T
SVGA	800	600	37.9	60	VESA Guidelines
	800	600	46.9	75	VESA
XGA	1024	768	48.4	60	VESA Guidelines
	1024	768	56.5	70	VESA
	1024	768	60	75	VESA
	1280	720	44.7	60	VESA CVT
WXGA	1280	768	47.4	60	VESA
	1280	768	47.8	60	VESA
	1280	768	60.3	75	VESA
	1360	768	47.7	60	VESA
SXGA	1280	1024	64	60	VESA
	1280	1024	80	75	VESA
HDTV	1920	1080	67.5	60	EIA



- This TV's PC input does not support Sync on Green or Composite Sync.
- The PC input signal displays on-screen in a smaller size than the actual TV screen size and does not support interlaced signals.
- For the best picture quality, it is recommended to use the signals (boldfaced) in the above chart with a 60 Hz vertical frequency from a personal computer. In plug and play, signals with a 60 Hz vertical frequency will be selected automatically.

Troubleshooting

Check whether the  (on/standby) indicator is flashing in red.

When it is flashing









The self-diagnosis function is activated. (When the indicator flashes in two- or three-blink intervals, see page 55.)

- 1 Count how many  (on/standby) indicator flashes between each two second break.
For example, the indicator flashes three times, then there is a two second break, followed by another three flashes, etc.
- 2 Press  on the TV (front) to switch it off, disconnect the mains lead, and inform your dealer or Sony service centre of how the indicator flashes (number of flashes).

When it is not flashing

- 1 Check the items in the tables below.
- 2 If the problem still persists, have your TV serviced by qualified service personnel.

Picture

Problem	Cause/Remedy
No picture (screen is dark) and no sound	<ul style="list-style-type: none"> • Check the aerial connection. • Connect the TV to the mains, and press  on the TV (front). • If the  (on/standby) indicator lights up in red, press TV .
No picture or no menu information from equipment connected to the scart connector	<ul style="list-style-type: none"> • Check that the optional equipment is on and press / repeatedly until the correct input symbol is displayed on the screen. • Check the connection between the optional equipment and the TV.
Double images or ghosting	<ul style="list-style-type: none"> • Check aerial/cable connections. • Check the aerial location and direction.
Only snow and noise appear on the screen	<ul style="list-style-type: none"> • Check if the aerial is broken or bent. • Check if the aerial has reached the end of its serviceable life (three to five years in normal use, one to two years at the seaside).
Distorted picture (dotted lines or stripes)	<ul style="list-style-type: none"> • Keep the TV away from electrical noise sources such as cars, motorcycles, hair-dryers or optical equipment. • When installing optional equipment, leave some space between the optional equipment and the TV. • Make sure that the aerial is connected using the supplied coaxial cable. • Keep the aerial cable away from other connecting cables.
Picture noise when viewing a TV channel	<ul style="list-style-type: none"> • Select “Manual Programme Preset” in the “Analogue Set-up” menu and adjust “AFT” (Automatic Fine Tuning) to obtain better picture reception (page 37).
Some tiny black points and/or bright points appear on the screen	<ul style="list-style-type: none"> • The picture of a display unit is composed of pixels. Tiny black points and/or bright points (pixels) on the screen do not indicate a malfunction.
No colour on programmes	<ul style="list-style-type: none"> • Select “Reset” in the “Picture” menu to return to the factory settings (page 25).
No colour or irregular colour when viewing a signal from the Y, Pb/Cb, Pr/Cr sockets  4 or 7	<ul style="list-style-type: none"> • Check the connection of the Y, Pb/Cb, Pr/Cr sockets 4 or 7. • Make sure that the Y, Pb/Cb, Pr/Cr sockets 4 or 7 are firmly seated in their respective sockets.

Continued

Problem	Cause/Remedy
Picture flashes initially when changing to HDMI mode or when switching on the TV in HDMI mode	<ul style="list-style-type: none"> • This is probably caused by the authentication process between HDMI equipment and the TV. It does not indicate a malfunction.
A white oval image appears on the screen	<ul style="list-style-type: none"> • This is due to strong light reflecting off both the TV screen and reflections coming from behind the screens. • Position your TV away from strong ambient light or sunlight, or lower any ambient lights.

Sound

Problem	Cause/Remedy
No sound, but good picture	<ul style="list-style-type: none"> • Press \triangle +/- or M (Mute). • Check that “Speaker” is set to “On” in the “Set-up” menu (page 32).
Noisy sound	<ul style="list-style-type: none"> • See “Picture noise” causes/remedies on page 53.

Channels

Problem	Cause/Remedy
The desired channel cannot be selected	<ul style="list-style-type: none"> • Switch between digital and analogue mode and select the desired digital/analogue channel.
Some channels are blank	<ul style="list-style-type: none"> • Scrambled/Subscription only channel. Subscribe to the Pay Per View service. • Channel is used only for data (no picture or sound). • Contact the broadcaster for transmission details.
Digital channels are not displayed	<ul style="list-style-type: none"> • Contact a local installer to find out if digital transmissions are provided in your area. • Upgrade to a higher gain aerial.

General

Problem	Cause/Remedy
The TV turns off automatically (the TV enters standby mode)	<ul style="list-style-type: none"> • Check if the “Sleep Timer” is activated, or confirm the “Duration” setting of “On Timer” (page 31). • If the inside of the TV grows warm while Cooling Mode is set to “High”, the TV automatically switches to standby mode. (When Cooling Mode is set to “Normal” under the same conditions, the mode switches to “High”, the cooling fan starts, and a loud whirring noise may be heard.) • If no signal is received and no operation is performed in the TV mode for 10 minutes, the TV automatically switches to standby mode.
The TV turns on automatically	<ul style="list-style-type: none"> • Check if the “On Timer” is activated (page 31).
Some input sources cannot be selected	<ul style="list-style-type: none"> • Select “AV Preset” in the “AV Set-up” menu and cancel “Skip” of the input source (page 34).

Problem	Cause/Remedy
Uneven colour uniformity appears on the screen when the TV is powered on	<ul style="list-style-type: none"> • After turning on the TV, you may notice a slight colour (tint) variation in certain areas of the picture. This will last only a few minutes each time you turn on the TV. This is a normal temperature characteristic of the components and not a malfunction.
The remote does not function	<ul style="list-style-type: none"> • Check that the remote is set correctly for the equipment you are using. • Check whether the equipment you want to use corresponds to the function button being pressed (page 14). • If the remote does not operate the equipment even when the remote has been set correctly to the equipment, enter the necessary code as explained in “Programming the remote” (page 45). • Replace the batteries.
 indicator flashes in red	<ul style="list-style-type: none"> • Replace the lamp (page 48).
The TV does not switch on	<ul style="list-style-type: none"> • The TV cools down its projection lamp after being switched off. It takes up to two minutes for the picture to come back after the TV is switched on again. Wait for a while until the picture returns.
Cannot play shooting games	<ul style="list-style-type: none"> • Some shooting games that involve pointing a light beam at the TV screen with an electronic gun or rifle cannot be used with your TV. For details, see the instruction manual supplied with the video game software.
On/standby indicator flashes in intervals of some blinks at a time	<ul style="list-style-type: none"> • Three blinks: The lamp cover or the lamp itself is not securely attached. • Two blinks: If there is a considerable rise in temperature inside the TV such as when any ventilation openings are blocked. • Other: Consult your dealer or service.
A slight creaking noise occurs from the bottom part of the TV	<ul style="list-style-type: none"> • Advanced Iris applies a mechanical iris system. When Advanced Iris is turned On/Off, a natural creaking noise occurs due to the basic structure of the optical unit. The creaking sound is an inherent nature of this system and is not a defect.
High Temperature Warning message appears	<ul style="list-style-type: none"> • This message will appear when there is a rise in temperature inside the TV. Make sure to remove dust from the ventilation slots on the rear and both sides of the TV. In addition, make sure that there are no obstacles in front of the ventilation slots. If no blockage is found, you may need to set Cooling Mode to “High”, otherwise the TV will turn off. With Cooling Mode set to “High”, if the message reappears and the TV turns off again, the TV may need servicing. Call your local Sony service centre.

Index

Numerics

- 1 Digit Direct 36
- 14:9 19
- 2 5
- 4:3 Default 30
- 4:3 18

A

- Advanced Iris 26, 41
- Advanced Settings 27
- Aerial, connecting 7
- AFT 37
- All Reset 33
- Analogue Set-up menu 36
- Analogue Text 18
- Audio Filter 37
- Audio Language 39
- Audio Out 32
- Audio Type 39
- Auto Adjustment 42
- Auto Clock Set 19, 23
- Auto Format 30
- Auto Start-up 31
- Auto Tuning
 - analogue and digital channels 8
 - analogue channels only 36
 - digital channels only 40
- Auto Volume 28
- AV Preset 34
- AV Set-up menu 34
- AV2 Output 34
- AV3 Input 34
- AV7 Input 34

B

- Balance 28
- Bass 28
- Batteries, inserting into the remote 4
- BBE 28
- Black Corrector 27
- Brightness 26, 41

C

- CA Module Set-up 40
- Category list 20
- Channels
 - auto-tuning 8
 - selecting 17
 - Skip 38
- Clear White 27
- Clock Set 31
- Colour 26
- Colour Matrix 35
- Colour System 35
- Colour Temperature 26, 42
- Confirm 38

Connecting

- an aerial/VCR 7
 - optional equipment 43
- Contrast 26, 41
 - Cooling Mode 32
 - Country 7

D

- Digital Auto Tuning 40
- Digital Manual Tuning 40
- Digital Settings 39
- Digital Set-up 39
- Digital Set-up menu 39
- Digital Text 18
- Digital Tuning 40
- Display Area 30
- Display Mode 41
- Display Position 32
- DRC Mode 27
- DRC Palette 27
- Dual Sound 29

E

- EPG (Digital Electronic Programme Guide) 20
- Equipment labels 34

F

- Fastext 18
- Favourite list 22
- Film mode 32

G

- Game Mode 35
- Gamma 27

H

- Headphones
 - connecting 43
 - Speaker Link 32
 - Volume 32
- Horizontal Shift 30, 42
- Hue 26

I

- Information 32
- Input signal index table 23
- Interactive service 17

L

- Label 37
- Lamp (Lamp) indicator 15
- Lamp Replacement 32
- Language 7, 32
- Live Colour 27

M

- Manual Programme Preset 37
- Manual timer REC 21
- MENU 24

N

- Noise Reduction 26

O

- On Timer 31
- On/standby (⏻) indicator 15

P

- PAP 19
- Parental Lock 39
- PC Settings menu 41
- Phase 42
- Picture Freeze 18
- Picture menu 25
- Picture Mode 25
- PIN Code 39
- Pitch 42
- Power (⏻) switch 15
- Power Saving 31
- Programme index table 18
- Programme Labels 36
- Programme List Edit 40
- Programme Sorting 36

R

- Reminder 21
- Remote control
 - inserting batteries 4
 - overview 13
 - programming 45
 - sensor 15
- Reset
 - PC settings 42
 - picture 25, 41
 - sound 28

S

- Screen format 18
- Screen Format 30, 42
- Screen menu 30
- Set-up menu 31
- Sharpness 26
- Skip 34, 38
- Sleep Timer 31
- Smart 18
- Sound menu 28
- Sound Mode 28, 42
- Speaker 32
- Specifications 51
- Subtitle Language 39
- Subtitle Setting 39
- Surround 28

T

Target Inputs

 picture 25

 screen 30

 sound 28

Technical Set-up 40

Timer 15

Timer (⏰) indicator 15

Timer list 21

Timer REC 20

Timer Settings 31

Tools 19, 23

Treble 28

V

VCR

 connecting 7

 recording 20

Vertical Shift 30, 42

Vertical Size 30

Volume Offset 28

W

Wide 18

Z

Zoom 19

HDMI

KDS-70R2000
KDS-55A2000

<http://www.sony.net/>

Printed in Spain



269827013

2-698-270-13(1)