

# LCD Digital Colour TV



## Operating Instructions

- ⚠ Before operating the TV, please read the "Safety information" section of this manual.  
Retain this manual for future reference.

**DVB<sup>®</sup> HD**  
Digital Video Broadcasting  
**ready**

**KDL-20S2030**  
**KDL-20S2020**  
**KDL-20S2000**

# BRAVIA





For useful information about Sony products

<http://www.sony-europe.com/myproduct>

# NOTICE FOR CUSTOMERS IN THE UNITED KINGDOM

A moulded plug complying with BS1363 is fitted to this equipment for your safety and convenience.

Should the fuse in the plug supplied need to be replaced, a 10 AMP fuse approved by ASTA or BSI to BS 1362 (i.e., marked with  or ) must be used.

When an alternative type of plug is used it should be fitted with a 10 AMP FUSE, otherwise the circuit should be protected by a 10 AMP FUSE at the distribution board. If the plug supplied with this equipment has a detachable fuse cover, be sure to attach the fuse cover after you change the fuse. Never use the plug without the fuse cover. If you should lose the fuse cover, please contact your nearest Sony service station.

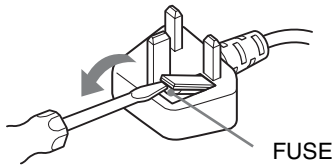

## How to replace the fuse

Open the fuse compartment with a blade screwdriver, and replace the fuse.

## Introduction

Thank you for choosing this Sony product. Before operating the TV, please read this manual thoroughly and retain it for future reference.

## Notice for Digital TV function

- Any functions related to Digital TV (**DVB**) will only work in countries or areas where DVB-T (MPEG2) digital terrestrial signals are broadcasted. Please confirm with your local dealer if you can receive a DVB-T signal where you live.
- Although this TV set follows DVB-T specifications, compatibility with future DVB-T digital terrestrial broadcasts cannot be guaranteed.
- Some Digital TV functions may not be available in some countries.

## Trademark information

- **DVB** is a registered trademark of the DVB Project
- Manufactured under license from BBE Sound, Inc. Licensed by BBE Sound, Inc. under one or more of the following US patents: 5510752, 5736897. BBE and BBE symbol are registered trademarks of BBE Sound, Inc.
- Manufactured under license from Dolby Laboratories. "Dolby" and the double-D symbol  are trademarks of Dolby Laboratories.
- **HDMI** This TV incorporates High-Definition Multimedia Interface (HDMI™) technology. HDMI, the HDMI logo and High-Definition Multimedia Interface are trademarks or registered trademarks of HDMI Licensing, LLC.

# Table of Contents

## Start-up Guide

4

Safety information .....	7
Precautions .....	10
Overview of the remote .....	11
<b>Overview of the TV buttons and indicators .....</b>	<b>12</b>

## Watching TV

Watching TV .....	13
Checking the Digital Electronic Programme Guide (EPG) <b>DVB</b> .....	15
Using the Favourite list <b>DVB</b> .....	17
Viewing pictures from connected equipment .....	18

## Using MENU Functions

Navigating through menus .....	19
Picture Adjustment menu .....	20
Sound Adjustment menu .....	21
Features menu .....	23
Set-up menu .....	25
Digital Set-up menu <b>DVB</b> .....	28

## Using Optional Equipment

Connecting optional equipment .....	30
-------------------------------------	----

## Additional Information

Specifications .....	32
Troubleshooting .....	33
Index .....	35

**DVB** : for digital channels only

# Start-up Guide

## 1: Checking the accessories

Remote RM-ED007 (1)

Size AA batteries (R6 type) (2)

Cable holder (1)

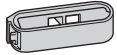

Support belt (1) and screws (2)

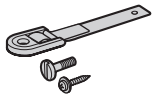

To insert batteries into the remote

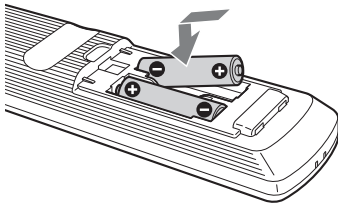

### Notes

- Observe the correct polarity when inserting batteries.
- Dispose of batteries in an environmentally friendly way. Certain regions may regulate disposal of the battery. Please consult your local authority.
- Do not use different types of batteries together or mix old and new batteries.
- Handle the remote with care. Do not drop or step on it, or spill liquid of any kind onto it.
- Do not place the remote in a location near a heat source, or in a place subject to direct sunlight, or in a damp room.

## 2: Connecting an aerial/VCR

Connecting an aerial only

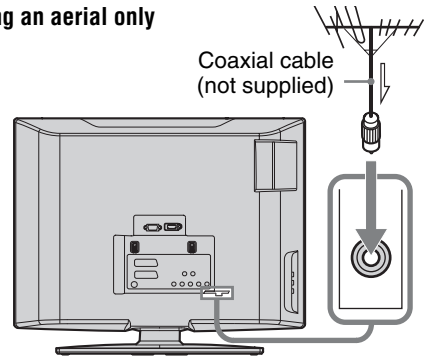

Connecting an aerial and VCR

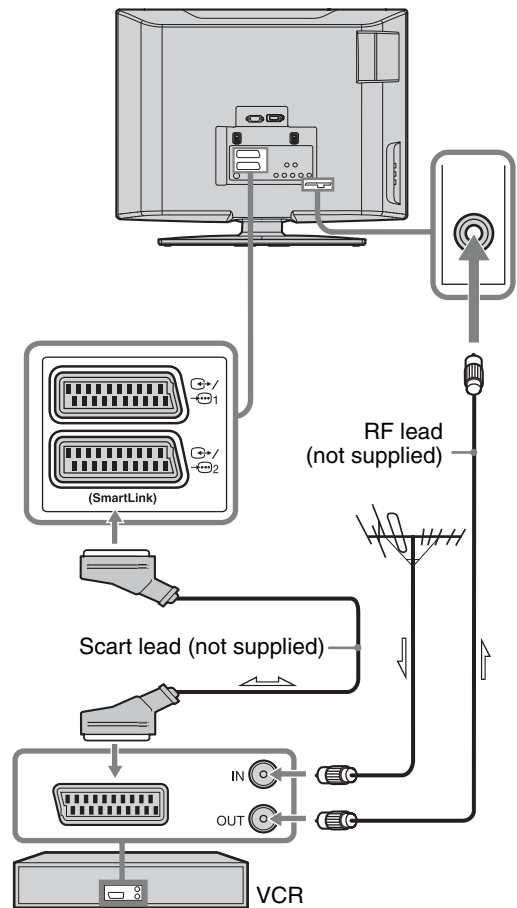

### 3: Bundling the cables

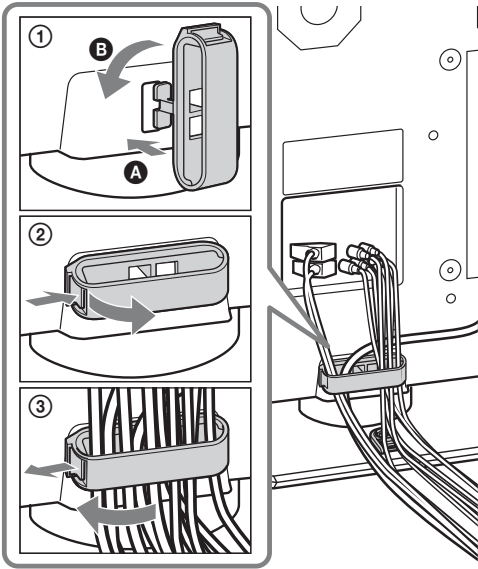



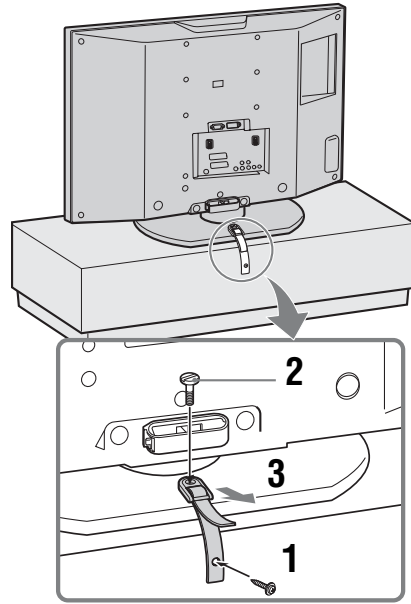

### 4: Preventing the TV from toppling over

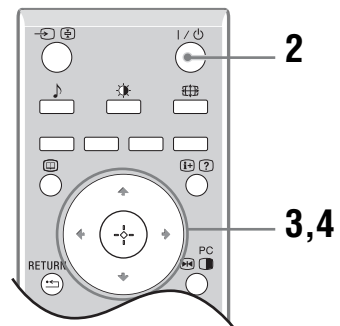
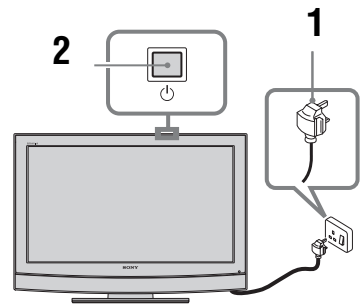



### 5: Selecting the language and country/region



Continued

- 1 Connect the TV to your mains socket (220-240V AC, 50Hz).
- 2 Press  on the TV (top side).  
When you switch on the TV for the first time, the Language menu appears on the screen. When the TV is in standby mode (the  (standby) indicator on the TV (front) is red), press  on the remote to switch on the TV.
- 3 Press  to select the language displayed on the menu screens, then press .



- 4 Press  to select the country/region in which you will operate the TV, then press .

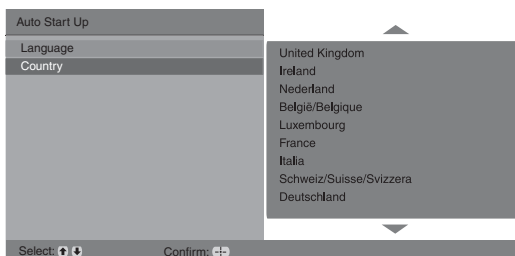

If the country/region in which you want to use the TV does not appear in the list, select “-” instead of a country/region.

The message confirming the TV start auto-tuning appears on the screen, then go to “6: Auto-tuning the TV”.

## 6: Auto-tuning the TV

After selecting the language and country/region, a message confirming the TV start auto-tuning appears on the screen.

The TV will now search for and store all available TV channels.

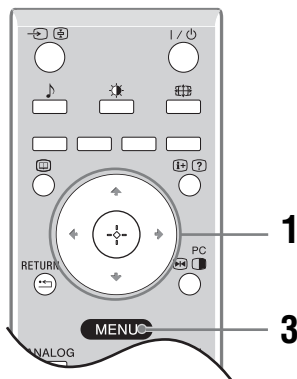

- 1 Press .

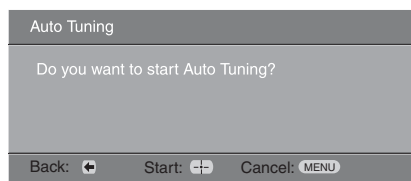

The TV starts searching for all available digital channels, followed by all available analogue channels. This may take some time, please be patient and do not press any buttons on the TV or remote.

### If a message appears for you to confirm the aerial connections

No digital or analogue channels were found. Check all the aerial connections and press  to start auto-tuning again.

- 2 When the Programme Sorting menu appears on the screen, follow the steps of “Programme Sorting” (page 25).  
If you do not wish to change the order in which the analogue channels are stored on the TV, go to step 3.
- 3 Press MENU to exit.  
The TV has now tuned in all the available channels.

# Safety information

## Mains lead

- Observe the followings to prevent the mains lead being damaged. If the mains lead is damaged, it may result in a fire or an electric shock.
  - When you disconnect the mains lead, disconnect it from the mains socket first.
  - Be sure to grasp the plug when disconnecting the mains lead. Do not pull on the mains lead itself.
  - Do not pinch, bend, or twist the mains lead excessively. The core conductors may be exposed or broken.
  - Do not modify the mains lead.
  - Do not put anything heavy on the mains lead.
  - Keep the mains lead away from heat sources.
- If you damage the mains lead, stop using it and ask your dealer or Sony service centre to exchange it.
- Do not use the supplied mains lead on any other equipment.
- Use only an original Sony mains lead, not other brands.

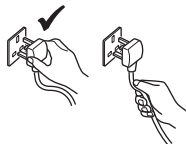
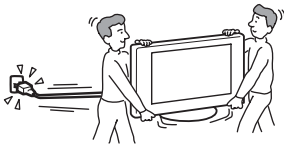

## Mains socket

Do not use a poor fitting mains socket. Insert the plug fully into the mains socket. A poor fit may cause arcing and result in a fire. Contact your electrician to have the mains socket changed.



## Cleaning the mains plug

Unplug the mains plug and clean it regularly. If the plug is covered with dust and it picks up moisture, its insulation may deteriorate and result in a fire.



## Overloading

This TV set is designed to operate on a 220–240 V AC supply only. Take care not to connect too many appliances to the same mains socket as this could result in fire or electric shock.

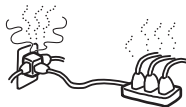

## When not in use

- If you will not be using the TV set for several days, the TV set should be disconnected from the mains for environmental and safety reasons.



- The TV set is not disconnected from the mains when the TV set is switched off. To disconnect the TV set completely, pull the plug from the mains. However, some TV sets may have features which need the TV set to be left in standby to work correctly. The instructions in this manual will inform you if this applies.

## Carrying

- Before carrying the TV set, disconnect all the cables from the TV set.
- When you carry the TV set by hand, hold the TV set as illustrated on the right. When lifting the TV set or moving the panel of the TV set, hold it firmly from the bottom. If you do not do so, the TV set may fall and be damaged or cause serious injury.
- When transporting it, do not subject the TV set to jolts or excessive vibration. The TV set may fall and be damaged or cause serious injury.
- If the TV set has been dropped or damaged, have it checked immediately by qualified service personnel.
- When you carry the TV set in for repair or when you move it, pack it using the original carton and packing material.

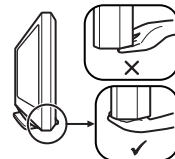

## Placement

- The TV set should be installed near an easily accessible mains socket.
- Place the TV set on a stable, level surface. Do not hang anything on the TV set. If you do, the TV set may fall from the stand, causing damage or serious injury.
- Do not install the TV set in places subject to extreme temperature, for example in direct sunlight, or near a radiator, or heating vent. If the TV set is exposed to extreme temperature, the TV set may overheat and cause deformation of the casing or cause the TV set to malfunction.
- Do not install the TV set in a place exposed to direct air conditioning. If the TV set is installed in such a location, moisture may condense inside and may cause a malfunction.
- Never place the TV set in hot, oily, humid or excessively dusty places.
- Do not install the TV set where insects may enter.
- Do not install the TV set where it may be exposed to mechanical vibration.
- Do not install the TV set in a location where it may protrude, such as on or behind a pillar, or where you might bump your head on it. Otherwise, it may result in injury.
- Do not allow children to climb on the TV set.
- If you use the TV set near the seashore, salt may corrode metal parts of the TV set and cause internal damage or fire.



*Continued*

## Ventilation

- Never cover the ventilation holes or insert anything in the cabinet. It may cause overheating and result in a fire.
- Unless proper ventilation is provided, the TV set may gather dust and get dirty. For proper ventilation, observe the following:
  - Do not install the TV set turned backwards or sideways.
  - Do not install the TV set turned over or upside down.
  - Do not install the TV set on a shelf or in a closet.
  - Do not place the TV set on a rug or bed.
  - Do not cover the TV set with cloth, such as curtains, or items such as newspapers, etc.
- Leave some space around the TV set as shown below. Otherwise, air-circulation may be inadequate and cause overheating, which may cause a fire or damage to the TV set.

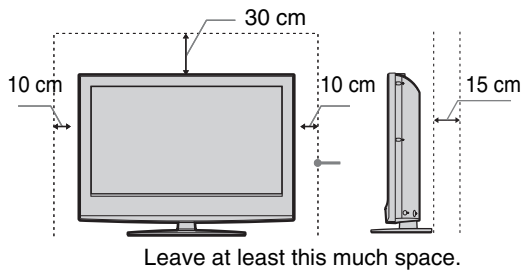

- Never install the TV set as follows:

Air circulation is blocked.

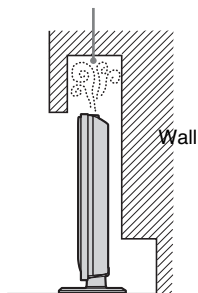

Air circulation is blocked.

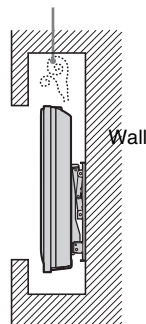

## Optional accessories

Observe the following when installing the TV set using a stand or wall-mount bracket. If you do not do so, the TV set may fall and cause serious injury.

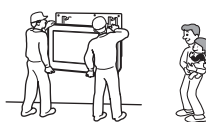

- If the TV set is to be installed on a wall, have the installation carried out by qualified service personnel. Improper installation may render the TV set unsafe.
- Secure the TV set properly, following the instructions supplied with your stand when installing the TV set.
- Be sure to attach the brackets supplied with your stand.

## Wiring

- When wiring cables, be sure to unplug the mains lead for your safety.
- Take care not to catch your feet on the cables. It may damage the TV set.

## Medical institutions

Do not place this TV set in a place where medical equipment is in use. It may cause a malfunction of medical instruments.



## Outdoor use

- Do not install this TV set outdoors. If the TV set is exposed to rain, it may result in a fire or an electrical shock.
- If this TV set is exposed to direct sunlight, the TV set may heat up and it may damage the TV set.

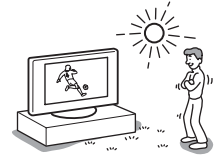

## Vehicle, Ships and other vessels

- Do not install this TV set in a vehicle. The motion of the vehicle may cause the TV set to fall down and cause injury.
- Do not install this TV set on a ship or other vessel. If the TV set is exposed to seawater, it may cause a fire or damage the TV set.

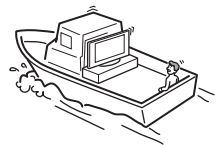
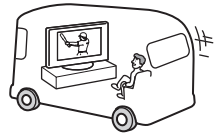

## Water and moisture

- Do not use this TV set near water – for example, near a bathtub or shower room. Also do not expose to rain, moisture or smoke. This may result in a fire or an electric shock.
- Do not touch the mains lead and the TV set with wet hands. Doing so may cause an electric shock or damage to the TV set.



## Moisture and flammable objects

- Do not place any objects on the TV set. The TV set shall not be exposed to dripping or splashing and that no objects filled with liquid, such as vases, shall be placed on the TV set.
- To prevent fire, keep flammable objects or naked lights (e.g. candles) away from the TV set.
- If any liquid or solid object does fall through openings in the cabinet, do not operate the TV set. It may result in an electric shock or damage to the TV set. Have it checked immediately by qualified service personnel.

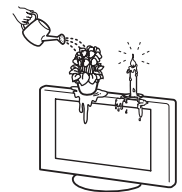

## Lightning storms

For your own safety, do not touch any part of the TV set, mains lead, or aerial lead during lightning storms.





### **Broken pieces**

- Do not throw anything at the TV set. The screen glass may break by the impact and cause serious injury.
- If the surface of the TV set cracks, do not touch it until you have unplugged the mains lead. Otherwise electric shock may result.

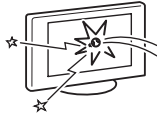

### **Servicing**

Dangerously high Voltage are present inside the TV set. Do not open the cabinet. Entrust the TV set to qualified service personnel only.



### **Small accessories removal and fittable**

Keep small accessories out of children's reach.

# Precautions

## Viewing the TV

- To view the TV comfortably, the recommended viewing position is from four to seven times the screen's vertical length away from the TV set.
- To obtain a clear picture, do not expose the screen to direct illumination or direct sunlight. If possible, use spot lighting directed down from the ceiling.
- View the TV in moderate light, as viewing the TV in poor light or during long period of time, strains your eyes.

## Volume adjustment

- Adjust the volume so as not to trouble your neighbours. Sound carries very easily at night time. Therefore, closing the windows or using headphones is suggested.
- When using headphones, adjust the volume so as to avoid excessive levels, as hearing damage may result.

## LCD Screen

- Although the LCD screen is made with high-precision technology and 99.99% or more of the pixels are effective, black dots may appear or bright points of light (red, blue, or green) may appear constantly on the LCD screen. This is a structural property of the LCD screen and is not a malfunction.
- Do not push or scratch the front filter, or place objects on top of this TV set. The image may be uneven or the LCD screen may be damaged.
- If this TV set is used in a cold place, a smear may occur in the picture or the picture may become dark. This does not indicate a failure. These phenomena disappear as the temperature rises.
- Ghosting may occur when still pictures are displayed continuously. It may disappear after a few moments.
- The screen and cabinet get warm when this TV set is in use. This is not a malfunction.
- The LCD screen contains a small amount of liquid crystal and mercury. The fluorescent tube used in this TV set also contains mercury. Follow your local ordinances and regulations for disposal.

## Handling and cleaning the screen surface/cabinet of the TV set

Be sure to unplug the mains lead connected to the TV set from mains socket before cleaning.

To avoid material degradation or screen coating degradation, observe the following precautions.

- Do not push on the screen, scratch it with a hard object, or throw anything at it. The screen may be damaged.
- Do not touch the display panel after operating the TV set continuously for a long period as the display panel becomes hot.
- We recommend that the screen surface be touched as little as possible.
- To remove dust from the screen surface/cabinet, wipe gently with a soft cloth. If dust is persistent, wipe with a soft cloth slightly moistened with a diluted mild detergent solution.
- Never use any type of abrasive pad, alkaline/acid cleaner, scouring powder, or volatile solvent, such as alcohol, benzene, thinner or insecticide. Using such materials or maintaining prolonged contact with rubber or vinyl

materials may result in damage to the screen surface and cabinet material.

- The ventilation holes can accumulate dust over time. To ensure proper ventilation, we recommend removing the dust periodically (once a month) using a vacuum cleaner.
- If the angle of the TV set is to be adjusted, steady the base of the stand with your hand to prevent the TV set from becoming separated from the stand. Be careful not to get your fingers caught between the TV set and the stand.

## Optional Equipments

- Do not install optional components too close to the TV set. Keep optional components at least 30 cm away from the TV set. If a VCR is installed in front of the TV set or beside the TV set, the picture may become distorted.
- Picture distortion and/or noisy sound may occur if the TV set is positioned in close proximity to any equipment emitting electromagnetic radiation.

## Disposal of the TV set

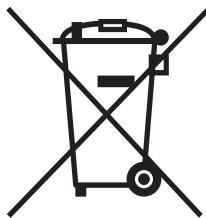

### Disposal of Old Electrical & Electronic Equipment (Applicable in the European Union and other European countries with separate collection systems)

This symbol on the product or on its packaging indicates that this product shall not be treated as household waste. Instead it shall be handed over to the applicable collection point for the recycling

of electrical and electronic equipment. By ensuring this product is disposed of correctly, you will help prevent potential negative consequences for the environment and human health, which could otherwise be caused by inappropriate waste handling of this product. The recycling of materials will help to conserve natural resources. For more detailed information about recycling of this product, please contact your local Civic Office, your household waste disposal service or the shop where you purchased the product.

# Overview of the remote

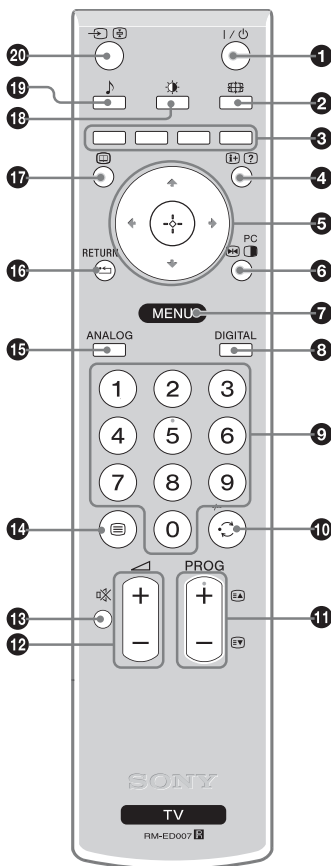

- 1** I/⏻ – TV standby  
Switches off the TV temporarily and on from standby mode.
- 2** [Screen Mode Icon] – Screen mode (page 14)
- 3** Coloured buttons
  - In digital mode (page 15, 17): Selects the options at the bottom of the Favourite and EPG digital menus.
  - In Text mode (page 14): Used for Fastext.
- 4** [Info/Text Reveal Icon] – Info / Text reveal
  - In digital mode: Displays brief details of the programme currently being watched.
  - In analogue mode: Displays information such as current channel number and screen mode.
  - In Text mode (page 14): Reveals hidden information (e.g., answers to a quiz).
- 5** [Channel Navigation Icons] (page 19)
- 6** [Picture Freeze Icon] Picture Freeze (page 14) / [PIP Icon] PIP in PC Mode (page 14)
  - In TV mode: Freezes the TV picture.
  - In PC mode: Displays a small picture (PIP).
- 7** MENU (page 19)
- 8** DIGITAL – Digital mode (page 13)
- 9** Number buttons
  - In TV mode: Selects channels. For channel numbers 10 and above, enter the second digit within two seconds.
  - In Text mode: Enters the three digit page number to select the page.
- 10** [Previous Channel Icon] – Previous channel  
Returns to the previous channel watched (for more than five seconds).
- 11** PROG +/- (page 13)
  - In TV mode: Selects the next (+) or previous (-) channel.
  - In Text mode: Selects the next (+) or previous (-) page.
- 12** [Volume Icon] +/- – Volume
- 13** [Mute Icon] – Mute (page 13)
- 14** [Text Icon] – Text (page 14)
- 15** ANALOG – Analogue mode (page 13)
- 16** [Return Icon] / RETURN  
Returns to the previous screen of any displayed menu.
- 17** [EPG Icon] – EPG (Digital Electronic Programme Guide) (page 15)
- 18** [Picture Mode Icon] – Picture mode (page 20)
- 19** [Sound Effect Icon] – Sound effect (page 21)
- 20** [Input Select/Text Hold Icon] – Input select / Text hold
  - In TV mode (page 18): Selects the input source from equipment connected to the TV sockets.
  - In Text mode (page 14): Holds the current page.

## Tip

The PROG + and number 5 buttons have tactile dots. Use the tactile dots as references when operating the TV.

# Overview of the TV buttons and indicators

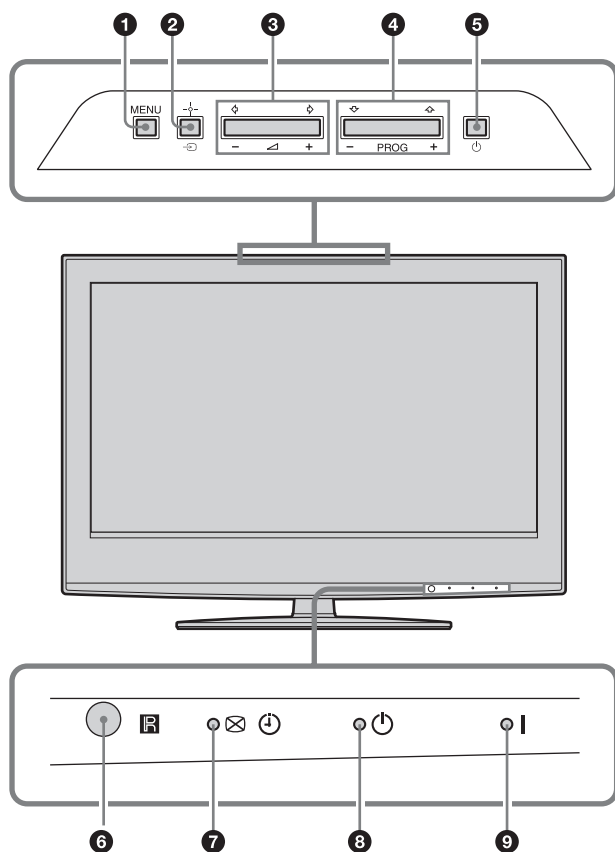



## 1 MENU (page 19)



## 2 / – Input select/OK

- In TV mode (page 18): Selects the input source from equipment connected to the TV sockets.
- In TV menu: Selects the menu or option, and confirm the setting.

## 3 +/- /

- Increases (+) or decreases (-) the volume.
- In TV menu: Moves through the options left () or right ()

## 4 PROG +/- /

- In TV mode: Selects the next (+) or previous (-) channel.
- In TV menu: Moves through the options up () or down ()

## 5 – Power

Switches the TV on or off.

### Note:

To disconnect the TV completely, pull the plug from the mains.

## 6 Remote control sensor

## 7 – Picture Off/Timer indicator

- Lights up in green when the picture is switched off (page 23).
- Lights up in orange when the timer is set (page 24).
- Lights up in red when digital REC starts in standby mode.

## 8 – Standby indicator

Lights up in red when the TV is in standby mode.

## 9 – Power indicator

Lights up in green when the TV is switched on.

# Watching TV

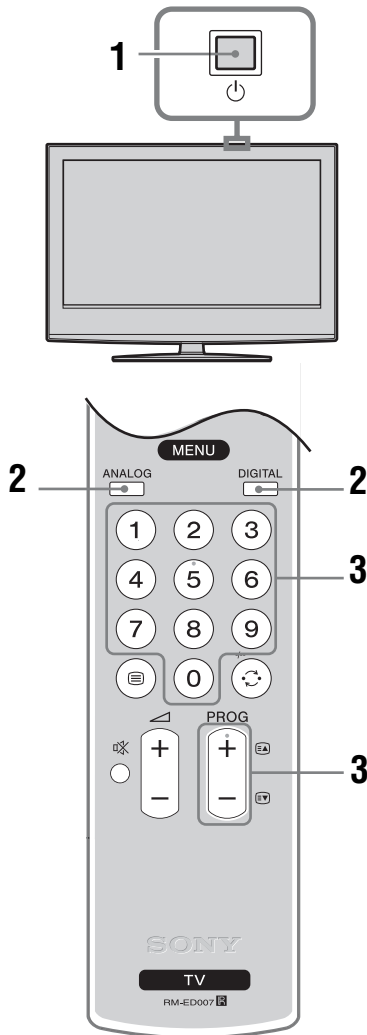

**1** Press on the TV (top side) to switch on the TV.

When the TV is in standby mode (the (standby) indicator on the TV (front) is red), press on the remote to switch on the TV.

**2** Press DIGITAL to switch to digital mode or ANALOG to switch to analogue mode.

The channels available vary depending on the mode.

**3** Press the number buttons or PROG +/- to select a TV channel.

To select channel numbers 10 and above using the number buttons, enter the second and third digits within two seconds.

To select a digital channel using the Digital Electronic Programme Guide (EPG), see page 15.

### In digital mode

An information banner appears briefly. The following icons may be indicated on the banner.

: Interactive service is available (MHEG Digital Text)

: Interactive service (MHEG Digital Text) is currently disabled

: Radio service

: Scrambled/Subscription service

: Multiple audio languages available

: Subtitles available

: Subtitles available for the hearing impaired

: Recommended minimum age for current programme (from 4 to 18 years)

: Parental Lock

: Current programme is being recorded

### Additional operations

To	Do this
Turn off the TV temporarily (Standby mode)	Press .
Turn on the TV from Standby mode without sound	Press . Press  +/- to set the volume level.
Switch off the TV.	Press  on the TV (top side).

### Note

To disconnect the TV completely, pull the plug from the mains.

Adjust the volume	Press  + (increase)/ - (decrease).
Mute the sound	Press . Press again to restore.
Access the Programme index table (in analogue mode only)	Press . To select an analogue channel, press , then press . To access the Input signal index table, see page 18.

## To access Text

Press . Each time you press , the display changes cyclically as follows:

Text → Text over the TV picture (mix mode) → No Text (exit the Text service)

To select a page, press the number buttons or PROG +/-.

To hold a page, press / .

To reveal hidden information, press / .

### Tips

- Ensure that the TV is receiving a good signal, or some text errors may occur.
- Most TV channels broadcast a Text service. For information on the use of the service, select the index page (usually page 100).
- When four coloured items appear at the bottom of the Text page, Fastext is available. Fastext allows you to access pages quickly and easily. Press the corresponding coloured button to access the page.

## Picture Freeze

Freezes the TV picture (e.g. to make a note of a telephone number or recipe).

- 1 Press on the remote control.
- 2 Press / / / to adjust the position of the window.
- 3 Press to remove the window.
- 4 Press again to return to normal TV mode.

### Tip

Not available for AV3, AV5 and AV6.

## PIP in PC Mode (Picture in Picture)

In PC mode, displays a small picture of the last channel selected.

- 1 Press on the remote control.
- 2 Press / / / to adjust the position of the window.
- 3 Press to cancel.

### Tip

The sound is output from the small picture.

## To change the screen mode manually to suit the broadcast

Press repeatedly to select Smart, 4:3, Wide, Zoom, or 14:9.

### Smart\*

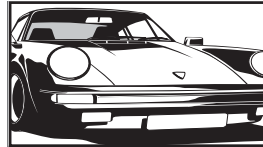

Displays conventional 4:3 broadcasts with an imitation wide screen effect. The 4:3 picture is stretched to fill the screen.

### 4:3

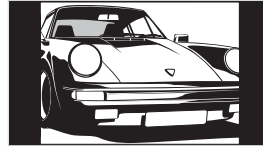

Displays conventional 4:3 broadcasts (e.g., non-wide screen TV) in the correct proportions.

### Wide

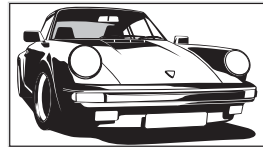

Displays wide screen (16:9) broadcasts in the correct proportions.

### Zoom\*

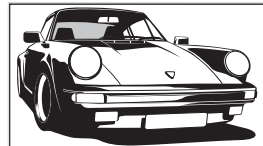

Displays cinemascopic (letter box format) broadcasts in the correct proportions.

### 14:9\*

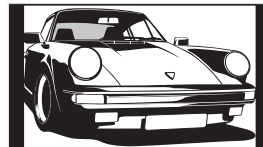

Displays 14:9 broadcasts in the correct proportions. As a result, black border areas are visible on the screen.

\* Parts of the top and bottom of the picture may be cut off.

### Tips

- Alternatively, you can set “Auto Format” to “On”. The TV will automatically select the best mode to suit the broadcast (page 23).
- You can adjust the position of the picture when selecting Smart, 14:9, or Zoom. Press / to move up or down (e.g., to read subtitles).

# Checking the Digital Electronic Programme Guide (EPG) DV3

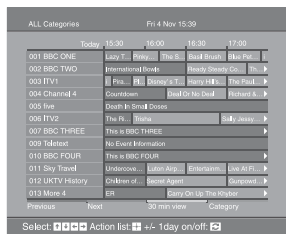

Digital Electronic Programme Guide (EPG)

- 1 In digital mode, press to display the Digital Electronic Programme Guide (EPG).
- 2 Perform the desired operation, as shown in the following table.

### Note

Programme information will only be displayed if the TV station is transmitting it.

To	Do this
Turn off the EPG	Press .
Move through the EPG	Press , , , .
Watch a current programme	Press  while the current programme is selected.
Sort the programme information by category – Category list	<ol style="list-style-type: none"> <li>1 Press the blue button.</li> <li>2 Press , , ,  to select a category. The category name is displayed on the side. The categories available include: “All Categories”: Contains all available channels. “News”: Contains all news channels.</li> <li>3 Press .</li> </ol> <p>The Digital Electronic Programme Guide (EPG) now only displays the current programmes from the category selected.</p>
Set a programme to be recorded – Timer REC	<ol style="list-style-type: none"> <li>1 Press , , ,  to select the future programme you want to record.</li> <li>2 Press .</li> <li>3 Press ,  to select “Timer REC”.</li> <li>4 Press  to set the TV and your VCR timers. A  symbol appears by that programme’s information. The  indicator on the TV (front) lights up.</li> </ol>

### Notes

- You can set VCR timer recording on the TV only for Smartlink compatible VCRs. If your VCR is not Smartlink compatible, a message will be displayed to remind you to set your VCR timer.
- Once a recording has begun, you can switch the TV to standby mode, but do not switch off the TV completely or the recording may be cancelled.
- If an age restriction for programmes has been selected, a message asking for pin code will appear on the screen. For more details refer to “Parental Lock” on page 29.

*Continued*

To	Do this
Set a programme to be displayed automatically on the screen when it starts – Reminder	<ol style="list-style-type: none"> <li>1 Press /// to select the future programme you want to display.</li> <li>2 Press .</li> <li>3 Press / to select “Reminder”.</li> <li>4 Press  to automatically display the selected programme when the programme starts. A  symbol appears by that programme’s information.</li> </ol>
<p><b>Note</b> If you switch the TV to standby mode, it will automatically turn itself on when the programme is about to start.</p>	
Set the time and date of a programme you want to record – Manual timer REC	<ol style="list-style-type: none"> <li>1 Press .</li> <li>2 Press / to select “Manual timer REC”, then press .</li> <li>3 Press / to select the date, then press .</li> <li>4 Set the start and stop time in the same way as in step 3.</li> <li>5 Press / to select the programme, then press  to set the TV and your VCR timers. A  symbol appears by that programme’s information. The  indicator on the TV (front) lights up.</li> </ol>
<p><b>Notes</b></p> <ul style="list-style-type: none"> <li>• You can set VCR timer recording on the TV only for Smartlink compatible VCRs. If your VCR is not Smartlink compatible, a message will be displayed to remind you to set your VCR timer.</li> <li>• Once a recording has begun, you can switch the TV to standby mode, but do not switch off the TV completely or the recording may be cancelled.</li> <li>• If an age restriction for programmes has been selected, a message asking for pin code will appear on the screen. For more details refer to “Parental Lock” on page 29.</li> </ul>	
Cancel a recording/reminder – Timer list	<ol style="list-style-type: none"> <li>1 Press .</li> <li>2 Press / to select “Timer list”.</li> <li>3 Press / to select the programme you want to cancel, then press .</li> </ol> <p>A display appears to confirm that you want to cancel the programme.</p> <ol style="list-style-type: none"> <li>4 Press  to select “Yes”, then press  to confirm.</li> </ol>

**Tip**

You can also display the Digital Electronic Programme Guide (EPG) by selecting “Digital EPG” in the “MENU”.



# Using the Favourite list DV3

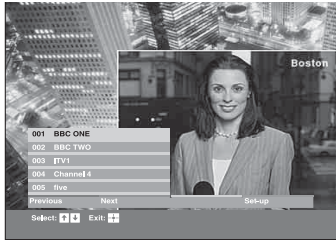

Favourite list

The Favourite feature allows you to select programs from a list of up to 8 channels you specify. To display the Favourite list, see “Navigating through menus” (page 19).

To	Do this
Create your Favourite list for the first time	<p>A message appears asking if you want to add channels to the Favourite list when you select “Digital Favourites” in the “MENU” for the first time.</p> <ol style="list-style-type: none"> <li>1 Press <b>+</b> to select “Yes”.</li> <li>2 Press <b>↑/↓</b> to select the channel you want to add. If you know the channel number, you can use the number buttons to directly select a channel.</li> <li>3 Press <b>+</b>. Channels that are stored in the Favourite list are indicated by a <b>♥</b> symbol.</li> </ol>
Turn off the Favourite list	Press RETURN.
Watch a channel	Press <b>+</b> while selecting a channel.
Add or remove channels in the Favourite list	<ol style="list-style-type: none"> <li>1 Press the blue button. Channels that are stored in the Favourite list are indicated by a <b>♥</b> symbol.</li> <li>2 Press <b>↑/↓</b> to select the channel you want to add or remove. If you know the channel number, you can use the number buttons to directly select a channel.</li> <li>3 Press <b>+</b>.</li> <li>4 Press the blue button to return to the Favourite list.</li> </ol>
Remove all channels from the Favourite list	<ol style="list-style-type: none"> <li>1 Press the blue button.</li> <li>2 Press the yellow button. A display appears to confirm that you want to delete all channels from the Favourite list.</li> <li>3 Press <b>↵</b> to select “Yes”, then press <b>+</b> to confirm.</li> </ol>

*Continued*

# Viewing pictures from connected equipment

Switch on the connected equipment, then perform one of the following operation.

## For equipment connected to the scart sockets using a fully-wired 21-pin scart lead

Start playback on the connected equipment. The picture from the connected equipment appears on the screen.

## For an auto-tuned VCR (page 4)

In analogue mode, press PROG +/-, or the number buttons, to select the video channel.

## For other connected equipment

Press / repeatedly until the correct input symbol (see below) appears on the screen.

---

AV1/ AV1, AV2/ AV2:

Audio/video or RGB input signal through the scart socket 1 or 2. appears only if an RGB source has been connected.

---

AV3:

Component input signal through the Y, Pb/Cb, Pr/Cr sockets / 3, and audio input signal through the L, R sockets / 3.

---

AV4/S/ AV4:

Video input signal through the video socket 4, and audio input signal through the L (MONO), R audio sockets 4. appears only if the equipment is connected to the S video socket S- 4 instead of the video socket 4, and S video input signal is input through the S video socket S- 4.

---

5:

RGB input signal through the PC connectors 5, and audio input signal through the socket .

---

AV6:

Digital audio/video signal is input through the HDMI IN 6 socket. Audio input signal is analogue only if the equipment has been connected using the DVI and audio out socket.

## Additional operations

To	Do this
Return to the normal TV operation	Press DIGITAL or ANALOG.

To	Do this
Access the Input signal index table	Press  to access the Input signal index table. (Then, only in analogue mode, press .) To select an input source, press /, then press .

## Navigating through menus

“MENU” allows you to enjoy various convenient features of this TV. You can easily select channels or external inputs with the remote. Also, settings for your TV can be changed easily using “MENU”.

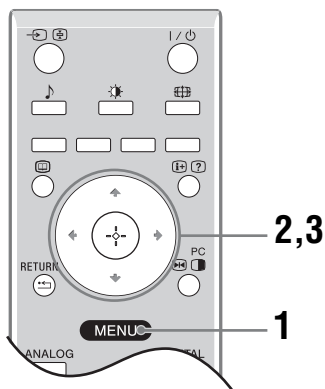



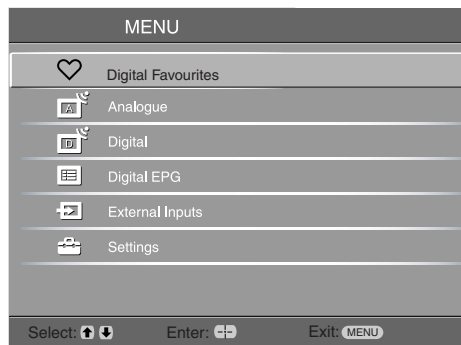



**1** Press MENU to display the menu.



**2** Press  $\uparrow/\downarrow$  to select an option.

**3** Press  $\oplus$  to confirm a selected option.  
To exit the menu, press MENU.

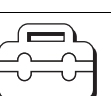
Menu	Description
 Digital Favourites (in digital mode only)	Launches the Favourite list. For details about settings, see page 17.
 Programme List (in analogue mode only)	Allows you to select TV programs from a list of channel labels. <ul style="list-style-type: none"> <li>To watch the desired channel, select the channel, then press <math>\oplus</math>.</li> <li>To assign a label to a program, see page 26.</li> </ul>
 Analogue (in digital mode only)	Returns to the last viewed analogue channel.
 Digital (in digital mode only)	Returns to the last viewed digital channel.
 Digital EPG (in digital mode only)	Launches the Digital Electronic Programme Guide (EPG). For details about settings, see page 15.
 External Inputs	Selects equipment connected to your TV. <ul style="list-style-type: none"> <li>To watch the desired external input, select the input source, then press <math>\oplus</math>.</li> <li>To assign a label to an external input, see page 25.</li> </ul>
 Settings	Opens the Settings menu screen where most of advanced settings and adjustments are performed. Select a menu icon, select an option and make the desired change or adjustment using $\uparrow/\downarrow/\leftarrow/\rightarrow$ . For details about settings, see page 20 to 29.

# Picture Adjustment menu

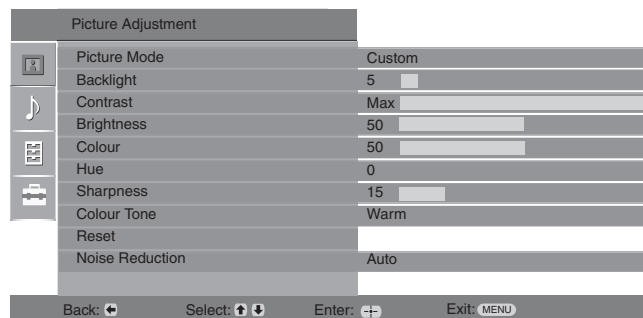

You can select the options listed below on the Picture menu. To select options in “Settings”, see “Navigating through menus” (page 19).

---

## Picture Mode

Selects the picture mode.

- “Vivid”: For enhanced picture contrast and sharpness.
- “Standard”: For standard picture. Recommended for home entertainment.
- “Custom”: Allows you to store your preferred settings.

---

## Backlight

Adjusts the brightness of the backlight.

---

## Contrast

Increases or decreases picture contrast.

---

## Brightness

Brightens or darkens the picture.

---

## Colour

Increases or decreases colour intensity.

---

## Hue

Increases or decreases the green tones.

### Tip

“Hue” can only be adjusted for an NTSC colour signal (e.g., U.S.A. video tapes).

---

## Sharpness

Sharpens or softens the picture.

---

## Colour Tone

Adjusts the whiteness of the picture.

- “Cool”: Gives the white colours a blue tint.
- “Neutral”: Gives the white colours a neutral tint.
- “Warm”: Gives the white colours a red tint.

### Tip

“Warm” can only be selected when you set “Picture Mode” to “Custom”.

---

## Reset

Resets all picture settings except “Picture Mode” to the factory settings.

---

## Noise Reduction

Reduces the picture noise (snowy picture) in a weak broadcast signal.

- “Auto”: Automatically reduces the picture noise.
- “High/Mid/Low”: Modifies the effect of the noise reduction.

# Sound Adjustment menu



You can select the options listed below on the Sound menu. To select options in “Settings”, see “Navigating through menus” (page 19).

## Sound Effect

Selects the sound mode.

- “Standard”: Enhances clarity, detail, and sound presence by using “BBE High definition Sound System.”
- “Dynamic”: Intensifies clarity and sound presence for better intelligibility and musical realism by using the “BBE High definition Sound System.”
- “BBE ViVA”: BBE ViVA Sound provides musically accurate natural 3D image with Hi-Fi sound. The clarity of the sound is improved by BBE while the width depth and height of sound image are expanded by BBE’s proprietary 3D sound process. BBE ViVA Sound is compatible with all TV programs including news, music, dramas, movies, sports and electronic games.
- “Dolby Virtual”: Uses the TV speakers to simulate the surround effect produced by a multi channel system.
- “Off”: Flat response.

### Tips

- You can change sound effect by pressing repeatedly.
- If you set “Auto Volume” to “On”, “Dolby Virtual” changes to “Standard”.

## Treble

Adjusts higher-pitched sounds.

## Bass

Adjusts lower-pitched sounds.

## Balance

Emphasizes left or right speaker balance.

## Reset

Resets all the sound settings to the factory settings.

## Dual Sound

Selects the sound from the speaker for a stereo or bilingual broadcast.

- “Stereo”, “Mono”: For a stereo broadcast.
- “A”/“B”/“Mono”: For a bilingual broadcast, select “A” for sound channel 1, “B” for sound channel 2, or “Mono” for a mono channel, if available.

### Tip

If you select other equipment connected to the TV, set “Dual Sound” to “Stereo”, “A” or “B”.

## Auto Volume

Keeps a constant volume level even when volume level gaps occur (e.g., adverts tend to be louder than programmes).

---

## TV Speakers

Turns off the TV speakers e.g. to listen to the sound through external audio equipment connected to the TV.

- “On”: the sound is output from the TV speakers.
- “One Time Off”: the TV speakers are temporarily turned off allowing you to listen to the sound from external audio equipment.
- “Permanent Off”: the TV speakers are permanently turned off allowing you to listen to the sound from external audio equipment.

### Tips

- To turn on the TV speakers again, change to on.
  - The “One Time Off” option automatically returns to “On” when the TV set is switched off.
  - “Sound Adjustment” options are not available if “One Time Off” or “Permanent Off” have been selected.
-

# Features menu

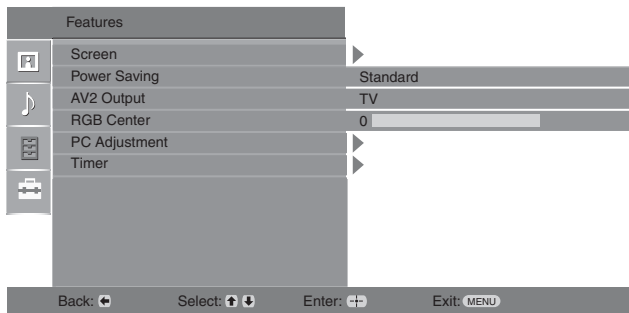

You can select the options listed below on the Features menu. To select options in “Settings”, see “Navigating through menus” (page 19).

## Screen

Changes the screen format.

- “Auto Format”: Automatically changes the screen format according to the broadcast signal.
- “Screen Format”: For details about the screen format, see page 14
- “Vertical Size”: Adjusts the vertical size of the picture when the screen format is set to Smart.

### Tips



- Even if you have selected “On” or “Off” in “Auto Format”, you can always modify the format of the screen by pressing  repeatedly.
- “Auto Format” is available for PAL and SECAM signals only.



## Power Saving

Selects the power saving mode to reduce the power consumption of the TV.

- “Standard”: Default settings.
- “Reduce”: Reduces the power consumption of the TV.
- “Picture Off”: Switches off the picture. You can listen to the sound with the picture off.

## AV2 Output



Sets a signal to be output through the socket labelled  on the rear of the TV. If you connect a VCR to the  socket, you can then record from the equipment connected to other sockets of the TV.

- “TV”: Outputs a broadcast.
- “Auto”: Outputs whatever is being viewed on the screen. Not available for  AV3,  AV5 and  AV6.

## RGB Center

Adjusts the horizontal picture position so that the picture is in the middle of the screen.

### Tip

This option is only available if an RGB source has been connected to the Scarts connectors  1 or  2 on the rear of the TV.

---

## PC Adjustment

Customizes the TV screen as a PC monitor.

### Tip

This option is only available if you are in PC Mode.

- “Phase”: Adjust the screen when a part of a displayed text or image is not clear.
- “Pitch”: Enlarges or shrinks the screen size horizontally.
- “H Center”: Moves the screen to the left or to the right.
- “V Lines”: Corrects the picture lines while viewing an RGB input signal from the PC  connector.
- “Power saving”: Turns to standby mode if no PC signal is received.
- “Reset”: Resets to the factory settings.

---

## Timer

Sets the timer to turn on/off the TV.

### • Sleep Timer

Sets a period of time after which the TV automatically switches itself into standby mode.

When the Sleep Timer is activated, the  (Timer) indicator on the TV (front) lights up in orange.

### Tips

- If you switch off the TV and switch it on again, “Sleep Timer” is reset to “Off”.
- “Sleep timer will end soon. Power will be turned off” appears on the screen one minute before the TV switches to standby mode.

### • Clock Set

Allows you to adjust the clock manually. When the TV is receiving digital channels, the clock cannot be adjusted manually since it is set to the time code of the broadcasted signal.

### • Timer

Sets the timer to turn on/off the TV.

“Timer Mode”: Selects the desired period.

“On Time”: Sets the time to turn on the TV.

“Off Time”: Sets the time to turn off the TV.

---



# Set-up menu

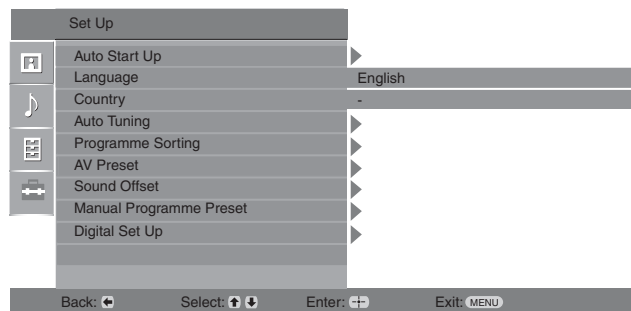

You can select the options listed below on the Set-up menu. To select options in “Settings”, see “Navigating through menus” (page 19).

## Auto Start-up

Starts the “first time operation menu” to select the language and country/region, and tune in all available digital and analogue channels. Usually, you do not need to do this operation because the language and country/region will have been selected and channels already tuned when the TV was first installed (page 5, 6). However, this option allows you to repeat the process (e.g., to retune the TV after moving house, or to search for new channels that have been launched by broadcasters).

## Language

Selects the language in which the menus are displayed.

## Country

Selects the country/region where you operate the TV.

### Tip

The country/region in which you want to use the TV does not appear in the list, select “-” instead of a country/region.

## Auto Tuning

Tunes in all the available analogue channels.

Usually you do not need to do this operation because the channels are already tuned when the TV was first installed (page 5, 6). However, this option allows you to repeat the process (e.g., to retune the TV after moving house, or to search for new channels that have been launched by broadcasters).

## Programme Sorting

Changes the order in which the analogue channels are stored on the TV.

- 1 Press  $\uparrow/\downarrow$  to select the channel you want to move to a new position, then press  $\rightarrow$ .
- 2 Press  $\uparrow/\downarrow$  to select the new position for your channel, then press  $\oplus$ .

## AV Preset

Assigns a name to any equipment connected to the side and rear sockets. The name will be displayed briefly on the screen when the equipment is selected. You can skip an input source that is not connected to any equipment.

- 1 Press  $\uparrow/\downarrow$  to select the desired input source, then press  $\oplus$ .
- 2 Press  $\uparrow/\downarrow$  to select the desired option below, then press  $\oplus$ .
  - AV1 (or AV2/ AV3/ AV4/ PC/ HDMI), VIDEO, DVD, CABLE, GAME, CAM, SAT: Uses one of the preset labels to assign a name to connected equipment.
  - “Edit”: Creates your own label.
  - “Skip”: Skips an input source that is not connected to any equipment when you press  $\uparrow/\downarrow$  to select the input source.

## Sound Offset

Sets an independent volume level to each equipment connected to the TV.

---

## Manual Programme Preset

Before selecting “Label”/“AFT”/“Audio Filter”/“Skip”/“Decoder”, press  $\uparrow/\downarrow$  to select the programme number you want to modify. Then, press  $\oplus$ .

### System/Channel

Presets programme channels manually.

- 1 Press  $\uparrow/\downarrow$  to select “System”, then press  $\oplus$ .
- 2 Press  $\uparrow/\downarrow$  to select one of the following TV broadcast systems, then press  $\leftarrow$ .
  - B/G: For western European countries/regions
  - D/K: For eastern European countries/regions
  - L: For France
  - I: For the United Kingdom

### Note

Depending on the country/region selected for “Country” (page 5), this option may not be available.

- 3 Press  $\uparrow/\downarrow$  to select “Channel”, then press  $\oplus$ .
- 4 Press  $\uparrow/\downarrow$  to select “S” (for cable channels) or “C” (for terrestrial channels), then press  $\Rightarrow$ .
- 5 Tune the channels as follows:

#### If you do not know the channel number (frequency)

Press  $\uparrow/\downarrow$  to search for the next available channel. When a channel has been found, the search will stop. To continue searching, press  $\uparrow/\downarrow$ .

#### If you know the channel number (frequency)

Press the number buttons to enter the channel number of the broadcast you want or your VCR channel number.

- 6 Press  $\oplus$  to jump to “Confirm”, then press  $\oplus$ .
- 7 Press  $\downarrow$  to select “OK”, then press  $\oplus$ .

Repeat the procedure above to preset other channels manually.

### Label

Assigns a name of your choice, up to five letters or numbers, to the selected channel. This name will be displayed briefly on the screen when the channel is selected.

### AFT

Allows you to fine-tune the selected programme number manually if you feel that a slight tuning adjustment will improve the picture quality.

You can adjust the fine tuning over a range of -15 to +15. When “On” is selected, the fine tuning is performed automatically.

### Audio Filter

Improves the sound for individual channels in the case of distortion in mono broadcasts. Sometimes a non-standard broadcast signal can cause sound distortion or intermittent sound muting when watching mono programmes.

If you do not experience any sound distortion, we recommend that you leave this option set to the factory setting “Off”.

### Notes



- You cannot receive stereo or dual sound when “Low” or “High” is selected.
- “Audio Filter” is not available when “System” is set to “L”.

---

**Skip**

Skips unused analogue channels when you press PROG +/- to select channels. (You can still select a skipped channel using the number buttons.)

**Decoder**

Views and records the scrambled channel selected when using a decoder connected directly to scart connector  1, or to scart connector  2 via a VCR.

**Note**

Depending on the country/region selected for “Country” (page 5), this option may not be available.

**Confirm**

Saves changes made to the “Manual Programme Preset” settings.

---

# Digital Set-up menu DV3

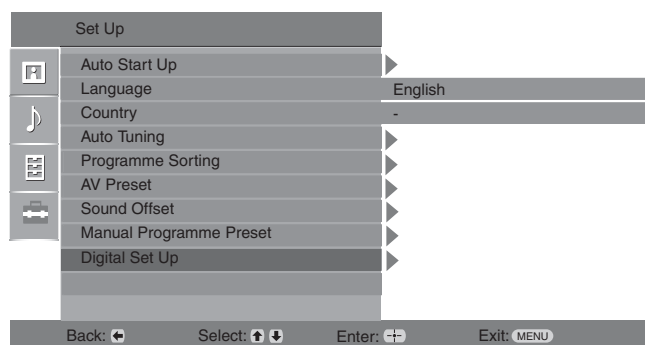

You can change/set the digital settings using the Digital Set-up menu. To select options in “Settings”, see “Navigating through menus” (page 19).

## Digital Tuning

Displays the “Digital Tuning” menu.

### Digital Auto Tuning

Tunes in all the available digital channels.

Usually you do not need to do this operation because the channels are already tuned when the TV was first installed (page 5). However, this option allows you to repeat the process (e.g., to retune the TV after moving house, or to search for new channels that have been launched by broadcasters).

### Programme List Edit

Removes any unwanted digital channels stored on the TV, and changes the order of the digital channels stored on the TV.

- 1 Press  $\uparrow/\downarrow$  to select the channel you want to remove or move to a new position.

#### If you know the programme number (frequency)

Press the number buttons to enter the three-digit programme number of the broadcast you want.

- 2 Remove or change the order of the digital channels as follows:

#### To remove the digital channel

Press  $\oplus$ . A message that confirms whether the selected digital channel is to be deleted appears. Press  $\leftarrow$  to select “Yes”, then press  $\oplus$ .

#### To change the order of the digital channels

Press  $\Rightarrow$ , then press  $\uparrow/\downarrow$  to select the new position for the channel and press  $\leftarrow$ . Repeat the procedure in steps 1 and 2 to move other channels if required.

- 3 Press RETURN.

### Digital Manual Tuning

Tunes the digital channels manually.

- 1 Press the number button to select the channel number you want to manually tune, then press  $\uparrow/\downarrow$  to tune the channel.
- 2 When the available channels are found, press  $\uparrow/\downarrow$  to select the channel you want to store, then press  $\oplus$ .
- 3 Press  $\uparrow/\downarrow$  to select the programme number where you want to store the new channel, then press  $\oplus$ .

Repeat the procedure above to tune other channels manually.

---

## Digital Set-up

Displays the “Digital Set-up” menu.

### Subtitle Setting

Displays digital subtitles on the screen.

When “For Hard Of Hearing” is selected, some visual aids may also be displayed with the subtitles (if TV channels broadcast such information).

### Subtitle Language

Selects which language subtitles are displayed in.

### Audio Language

Selects the language used for a programme. Some digital channels may broadcast several audio languages for a programme.

### Audio Type

Increases the sound level when “For Hard Of Hearing” is selected.

### Parental Lock

Sets an age restriction for programmes. Any programme that exceeds the age restriction can only be watched after a PIN Code is entered correctly.

- 1 Press the number buttons to enter your existing PIN code.  
If you have not previously set a PIN, a PIN code entry screen appears. Follow the instruction of “PIN Code” below.
- 2 Press  $\uparrow/\downarrow$  to select the age restriction or “None” (for unrestricted watching), then press  $\oplus$ .
- 3 Press RETURN.

### PIN Code

Sets a PIN code for the first time, or allows you to change your PIN code.

- 1 Enter a PIN as follows:

#### If you have previously set a PIN

Press the number buttons to enter your existing PIN.

#### If you have not set a PIN

Press the number buttons to enter the factory setting PIN of 9999.

- 2 Press the number buttons to enter the new PIN code.  
A message appears to inform you that the new PIN has been accepted.
- 3 Press RETURN.

### Tip

PIN code 9999 is always accepted.

### Technical Set-up

Displays the Technical Set-up menu.

“Auto Service Update”: Enables the TV to detect and store new digital services as they become available.

“Software Download”: Enables the TV to automatically receive software updates, free through your existing aerial (when issued). Sony recommends that this option is set to “On” at all times. If you do not want your software to be updated, set this option to “Off”.

“System Information”: Displays the current software version and the signal level.

“Time Zone”: Allows you to select the correct time zone for your country.

### CA Module Set-up

Allows you to access a Pay Per View service once you obtain a Conditional Access Module (CAM) and a view card. See page 30 for the location of the  (PCMCIA) socket.

# Connecting optional equipment

You can connect a wide range of optional equipment to your TV. Connecting cables are not supplied.

## Connecting to the TV (side)

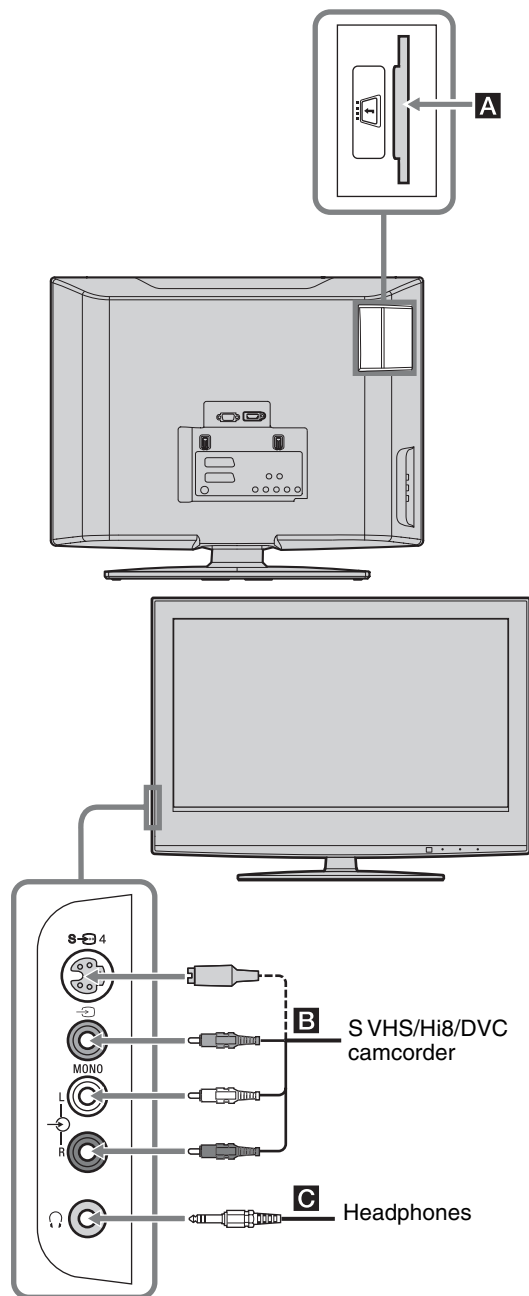

To connect	Do this
Conditional Access Module (CAM) <b>A</b>	To use Pay Per View services. For details, refer to the instruction manual supplied with your CAM. To use the CAM, remove the rubber cover from the CAM slot. Switch off the TV when inserting your CAM into the CAM slot. When you do not use the CAM, we recommend that you replace the cover on the CAM slot.
S VHS/Hi8/DVC camcorder <b>B</b>	Connect to the S video socket S-4 or the video socket 4, and the audio sockets 4. To avoid picture noise, do not connect the camcorder to the video socket 4 and the S video socket S-4 at the same time. If you connect mono equipment, connect to the L socket 4, and set "Dual Sound" to "A" (page 21).
Headphones <b>C</b>	Connect to the H socket to listen to sound from the TV on headphones.

## Connecting to the TV (rear)

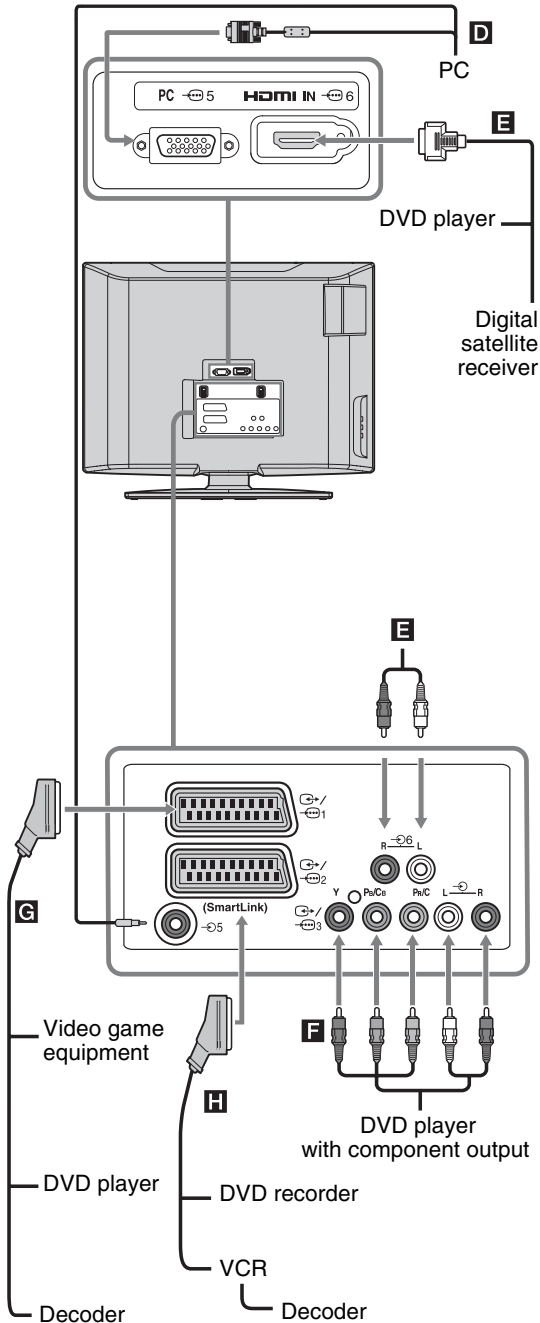

### To connect

### Do this

#### PC **D**

Connect to the PC sockets. It is recommended to use a PC cable with ferrites.

#### Digital satellite receiver or DVD player **E**

Connect to the HDMI IN 6 socket if the equipment has a HDMI socket. The digital video and audio signals are input from the equipment. If the equipment has a DVI socket, connect the DVI socket to the HDMI IN 6 socket through a DVI - HDMI adaptor interface (not supplied), and connect the equipment's audio out sockets to the audio in HDMI IN 6 sockets.

#### Notes

- The HDMI sockets only support the following Video inputs: 480i, 480p, 576i, 576p, 720p and 1080i. To connect a PC, please use the PC input socket.
- Use HDMI certified cable with HDMI logo.

#### DVD player with component output **F**

Connect to the component sockets and the audio sockets 3.

#### Video game equipment, DVD player or decoder **G**

Connect to the scart socket 1. When you connect the decoder, the scrambled signal from the TV tuner is output to the decoder, then the unscrambled signal is output from the decoder.

#### DVD recorder or VCR that supports SmartLink **H**

Connect to the scart socket 2. SmartLink is a direct link between the TV and a VCR/DVD recorder.

# Specifications

## Display Unit

Power Requirements:  
220–240 V AC, 50 Hz  
Screen Size:  
20 inches

Display Resolution:  
1,366 dots (horizontal) × 768 lines (vertical)

Power Consumption:  
65 W or less

Standby Power Consumption\* :  
1 W or less  
\* Specified standby power is reached after the TV finishes necessary internal processes.

Dimensions (w × h × d):  
Approx. 500 × 406 × 209 mm (with stand)  
Approx. 500 × 370 × 100 mm (without stand)

Mass:  
Approx. 8 kg (with stand)  
Approx. 7 kg (without stand)

## Panel System

LCD (Liquid Crystal Display) Panel

## TV System

Analogue: Depending on your country/region selection:  
B/G/H, D/K, L, I  
Digital: DVB-T

## Colour/Video System

Analogue: PAL, SECAM  
NTSC 3.58, 4.43 (only Video In)  
Digital: MPEG-2 MP@ML

## Aerial

75 ohm external terminal for VHF/UHF

## Channel Coverage

Analogue: VHF: E2–E12  
UHF: E21–E69  
CATV: S1–S20  
HYPER: S21–S41  
D/K: R1–R12, R21–R69  
L: F2–F10, B–Q, F21–F69  
I: UHF B21–B69

## PC Input Signal Reference Chart

Signals	Horizontal (Pixel)	Vertical (Line)	Horizontal frequency (kHz)	Vertical frequency (Hz)	Standard
VGA	640	480	31.5	60	VGA
SVGA	800	600	37.9	60	VESA Guidelines
XGA	1024	768	48.4	60	VESA Guidelines
WXGA	1280	768	47.4	60	VESA
	1280	768	47.8	60	VESA

- This TV's PC input does not support Sync on Green or Composite Sync.
- This TV's PC input does not support interlaced signals.
- This TV's PC input supports signals in the above chart with a 60 Hz vertical frequency. For other signals, you will see the message "NO SYNC".

Digital: VHF/UHF

## Terminals

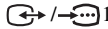
 1  
21-pin Scart connector (CENELEC standard) including audio/video input, RGB input, and TV audio/video output.

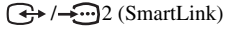
 2 (SmartLink)  
21-pin Scart connector (CENELEC standard) including audio/video input, RGB input, selectable audio/video output, and SmartLink interface.



 3  
Supported formats: 1080i, 720p, 576p, 576i, 480p, 480i  
Y: 1 Vp-p, 75 ohms, 0.3V negative sync  
P<sub>B</sub>/C<sub>B</sub>: 0.7 Vp-p, 75 ohms  
P<sub>R</sub>/C<sub>R</sub>: 0.7 Vp-p, 75 ohms

 3  
Audio input (phono jacks)  
500 mVrms  
Impedance: 47 kilo ohms

 4 S video input (4-pin mini DIN)

 4 Video input (phono jack)

 4 Audio input (phono jacks)

PC  PC Input (15 Dsub) (see page 31)  
G: 0.7 Vp-p, 75 ohms, non Sync on Green  
B: 0.7 Vp-p, 75 ohms, non Sync on Green  
R: 0.7 Vp-p, 75 ohms, non Sync on Green  
HD: 1-5 Vp-p  
VD: 1-5 Vp-p  
 5 PC audio input (minijack)

## HDMI IN 6

Video: 1080i, 720p, 576p, 576i, 480p, 480i  
Audio: Two channel linear PCM  
32, 44.1 and 48 kHz, 16, 20 and 24 bits,  
or analogue audio input (phono jacks)

 Headphones jack

 CAM (Conditional Access Module) slot

## Sound Output

5 W + 5 W (RMS)

## Supplied Accessories

Refer to "1: Checking the accessories" on page 4.

Design and specifications are subject to change without notice.





# Troubleshooting

Check whether the  (standby) indicator is flashing in red.

## When it is flashing







The self-diagnosis function is activated.

- 1 Measure how long the  (standby) indicator flashes and stops flashing.  
For example, the indicator flashes for two seconds, stops flashing for one second, and flashes for two seconds.
- 2 Press  on the TV (top side) to switch it off, disconnect the mains lead, and inform your dealer or Sony service centre of how the indicator flashes (duration and interval).

## When it is not flashing

- 1 Check the items in the tables below.
- 2 If the problem still persists, have your TV serviced by qualified service personnel.

## Picture

Problem	Cause/Remedy
No picture (screen is dark) and no sound	<ul style="list-style-type: none"> <li>• Check the aerial connection.</li> <li>• Connect the TV to the mains, and press  on the TV (top side).</li> <li>• If the  (standby) indicator lights up in red, press .</li> </ul>
No picture or no menu information from equipment connected to the scarts or HDMI IN socket	<ul style="list-style-type: none"> <li>• Check that the optional equipment is on and press  repeatedly until the correct input symbol is displayed on the screen.</li> <li>• Check the connection between the optional equipment and the TV.</li> <li>• When connecting any equipment to the HDMI IN 6 socket or when changing the resolution, some dots can appear blinking on the screen for a few seconds. HDMI signal decoding is in progress and it does not indicate a malfunction.</li> </ul>
Double images or ghosting	<ul style="list-style-type: none"> <li>• Check aerial/cable connections.</li> <li>• Check the aerial location and direction.</li> </ul>
Only snow and noise appear on the screen	<ul style="list-style-type: none"> <li>• Check if the aerial is broken or bent.</li> <li>• Check if the aerial has reached the end of its serviceable life (three to five years in normal use, one to two years at the seaside).</li> </ul>
Distorted picture (dotted lines or stripes)	<ul style="list-style-type: none"> <li>• Keep the TV away from electrical noise sources such as cars, motorcycles, hair-dryers or optical equipment.</li> <li>• When installing optional equipment, leave some space between the optional equipment and the TV.</li> <li>• Make sure that the aerial is connected using the supplied coaxial cable.</li> <li>• Keep the aerial cable away from other connecting cables.</li> </ul>
Picture noise when viewing a TV channel	<ul style="list-style-type: none"> <li>• Select “Manual Programme Preset” in the “Set-Up” menu and adjust “AFT” (Automatic Fine Tuning) to obtain better picture reception (page 26).</li> </ul>
Some tiny black points and/or bright points on the screen	<ul style="list-style-type: none"> <li>• The picture of a display unit is composed of pixels. Tiny black points and/or bright points (pixels) on the screen do not indicate a malfunction.</li> </ul>
No colour on programmes	<ul style="list-style-type: none"> <li>• Select “Reset” in the “Picture Adjustment” menu to return to the factory settings (page 20).</li> </ul>
No colour or irregular colour when viewing a signal from the Y, Pb/Cb, Pr/Cr jacks of 	<ul style="list-style-type: none"> <li>• Check the connection of the Y, Pb/Cb, Pr/Cr jacks of .</li> <li>• Make sure that the Y, Pb/Cb, Pr/Cr jacks of  are firmly seated in their respective sockets.</li> </ul>

## Sound

Problem	Cause/Remedy
No sound, but good picture	<ul style="list-style-type: none"><li>• Press <math>\triangle</math> +/- or <math>\text{Mute}</math> (Mute).</li><li>• Check that “TV Speakers” is set to “On” in the “Sound Adjustment” menu (page 22).</li></ul>
Noisy sound	<ul style="list-style-type: none"><li>• See the “Picture noise” causes/remedies on page 33.</li></ul>

## Channels

Problem	Cause/Remedy
The desired channel cannot be selected	<ul style="list-style-type: none"><li>• Switch between digital and analogue mode and select the desired digital/analogue channel.</li></ul>
Some channels are blank	<ul style="list-style-type: none"><li>• Scrambled/Subscription only channel. Subscribe to the Pay Per View service.</li><li>• Channel is used only for data (no picture or sound).</li><li>• Contact the broadcaster for transmission details.</li></ul>
Digital channel is not displayed	<ul style="list-style-type: none"><li>• Check that the aerial is plugged directly into the TV (not through other equipment).</li><li>• Contact a local installer to find out if digital transmissions are provided in your area.</li><li>• Upgrade to a higher gain aerial.</li></ul>

## General

Problem	Cause/Remedy
The TV turns off automatically (the TV enters standby mode)	<ul style="list-style-type: none"><li>• Check if the “Sleep Timer” is activated, or confirm the setting of “Off Time” (page 24).</li><li>• If no signal is received and no operation is performed in the TV mode for 10 minutes, the TV automatically switches to standby mode.</li></ul>
The TV turns on automatically	<ul style="list-style-type: none"><li>• Check if the “On Time” is activated (page 24).</li></ul>
Some input sources cannot be selected	<ul style="list-style-type: none"><li>• Select “AV Preset” in the “Set-up” menu and cancel “Skip” of the input source (page 25).</li></ul>
The remote does not function	<ul style="list-style-type: none"><li>• Replace the batteries.</li></ul>

# Index

## Numerics

14:9 14  
4:3 14

## A

Aerial, connecting 4  
AFT 26  
Audio Filter 26  
Audio Language 29  
Audio Type 29  
Auto Start-up 25  
Auto Tuning  
    analogue and digital channels 6  
    analogue channels only 25  
    digital channels only 28  
Auto Volume 21  
AV Preset 25  
AV2 Output 23

## B

Backlight 20  
Balance 21  
Bass 21  
Batteries, inserting into the remote 4  
BBE 21  
Brightness 20

## C

CA Module Set-up 29  
Category list 15  
Channels  
    auto-tuning 6  
    selecting 13  
    Skip 27  
Clock Set 24  
Colour 20  
Colour Tone 20  
Confirm 27  
Connecting  
    an aerial/VCR 4  
    optional equipment 30  
Contrast 20  
Country 5, 25

## D

Digital Auto Tuning 28  
Digital Manual Tuning 28  
Digital Set-up 29  
Digital Set-up menu 28  
Digital Tuning 28  
Dolby Virtual 21  
Dual Sound 21

## E

EPG (Digital Electronic Programme Guide) 15

## F

Fastext 14  
Favourite list 17  
Features menu 23

## H

Headphones  
    connecting 30  
Hue 20

## I

Input signal index table 18

## L

Label 26  
Language 5, 25

## M

Manual Programme Preset 26  
Manual timer REC 16  
MENU 19

## N

Noise Reduction 20

## P

Parental Lock 29  
PC Adjustment 24  
Picture menu 20  
Picture Mode 20  
Picture Off (⊗) indicator 12  
PIN Code 29  
PIP (Picture in Picture) 14  
Power (⏻) indicator 12  
Power (⏻) switch 12  
Power Saving 23  
Programme index table 13  
Programme List Edit 28  
Programme Sorting 25

## R

Reminder 16  
Remote control  
    inserting batteries 4  
    overview 11  
    sensor 12  
Reset  
    picture 20  
    sound 21  
RGB Center 23

## S

Screen 23  
Screen mode 14  
Set-up menu 25  
Sharpness 20  
Skip 25, 27  
Smart 14  
Sound 11  
Sound Adjustment menu 21  
Sound Effect 21  
Sound Offset 25  
Specifications 32  
Standby (⏻) indicator 12  
Subtitle Language 29  
Subtitle Setting 29

## T

Technical Set-up 29  
Text 14  
Timer 24  
Timer (⌚) indicator 12  
Timer list 16  
Timer REC 15  
Treble 21  
TV Speakers 22

## V

VCR  
    connecting 4  
    recording 15

## W

Wide 14

## Z

Zoom 14

**VIRTUAL**  
**DOLBY**  
**SURROUND**

**VIM**  
**DIGITAL**  
*HD3D Sound* **BBE**

<http://www.sony.net/>

**KDL-20S2030**  
**KDL-20S2020**  
**KDL-20S2000**

2-685-333-14(1)

**U**

Printed in Slovak Republic