

# SONY®

3-210-375-11(1)

*Digital HD Video Camera Recorder*

## HANDYCAM®

# Handycam Handbook

### ***HDR-SR5E/SR7E/SR8E***

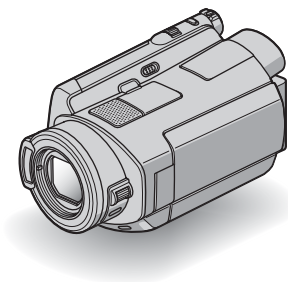

Enjoying your  
camcorder 9

Getting Started 15

Recording/Playback 23

Editing 46

Utilizing recording media 57

Customizing your  
camcorder 61

Troubleshooting 84

Additional  
Information 96

Quick  
Reference 107

**AVCHD**

  
MEMORY STICK™

 InfoLITHIUM™  
SERIES

**HDMI**

# Read this before operating your camcorder

Before operating the unit, please read this Handbook thoroughly, and retain it for future reference.

## Notes on use

### In “Handycam Handbook” (this Handbook)

The operations and handling of your camcorder are explained. Refer also to “Operating Guide” (the separate volume).

### Handling the images recorded on your camcorder on the computer

Refer to “Picture Motion Browser Guide” stored on the supplied CD-ROM.

### Types of “Memory Stick” you can use in your camcorder

You can use “Memory Stick Duo” marked with MEMORY STICK DUO or MEMORY STICK PRO DUO (p. 99).

“Memory Stick Duo”  
(This size can be used with your camcorder.)



“Memory Stick”  
(You cannot use it in your camcorder.)



- You cannot use any type of memory card except “Memory Stick Duo.”
- “Memory Stick PRO” and “Memory Stick PRO Duo” can be used only with “Memory Stick PRO” compatible equipment.
- Do not attach a label or the like on a “Memory Stick Duo” or a Memory Stick Duo adaptor.

### When using a “Memory Stick Duo” with “Memory Stick” compatible equipment

Be sure to insert the “Memory Stick Duo” into the Memory Stick Duo adaptor.

Memory Stick Duo adaptor



### Using the camcorder

- Do not hold the camcorder by the following parts.

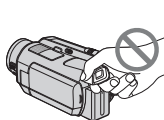

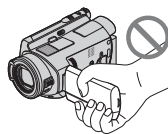

Viewfinder  
(HDR-SR7E/SR8E)

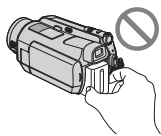

LCD screen



Battery pack

- The camcorder is not dustproofed, dripproofed or waterproofed. See “About handling of your camcorder” (p. 102).
- To prevent the hard disk from being broken or recorded images from being lost, do not do the following when either of the  (Movie) or  (Still) mode lamps (p. 20) or the ACCESS lamp (p. 27) is on:
  - to remove the battery pack or AC Adaptor from the camcorder.
  - to apply mechanical shock or vibration to the camcorder.
- When connecting your camcorder to another device with an HDMI cable, a component video cable, a USB cable, etc. be sure to insert the connector plug in the correct way. Pushing the plug forcibly

into the terminal will damage the terminal and may result in a malfunction of your camcorder.

- Connect an A/V connecting cable or component video cable to the Handycam Station when using your camcorder attached to the Handycam Station.
- Disconnect the AC Adaptor from the Handycam Station holding both the Handycam Station and the DC plug.
- Be sure to slide the POWER switch to OFF (CHG) when you insert the camcorder into the Handycam Station or remove the camcorder from it.

### About menu items, LCD panel, viewfinder (HDR-SR7E/SR8E), and lens

- A menu item that is grayed out is not available under the current recording or playback conditions.
- The viewfinder (HDR-SR7E/SR8E) and the LCD screen are manufactured using extremely high-precision technology, so over 99.99% of the pixels are operational for effective use. However, there may be some tiny black points and/or bright points (white, red, blue, or green in color) that appear constantly in the viewfinder (HDR-SR7E/SR8E) and on the LCD screen. These points are normal results of the manufacturing process and do not affect the recording in any way.

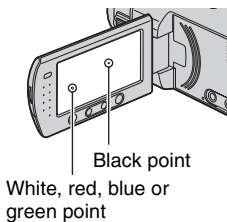

- Exposing the LCD screen, the viewfinder (HDR-SR7E/SR8E), or the lens to direct sunlight for long periods of time may cause malfunctions.

- Do not aim at the sun. Doing so might cause your camcorder to malfunction. Take images of the sun only in low light conditions, such as at dusk.

### About changing the language setting

- The on-screen displays in each local language are used for illustrating the operating procedures. Change the screen language before using your camcorder if necessary (p. 21).

### On recording

- Before starting to record, test the recording function to make sure the image and sound are recorded without any problems.
- Compensation for the contents of recordings cannot be provided, even if recording or playback is not possible due to a malfunction of the camcorder, storage media, etc.
- TV color systems differ depending on the country/region. To view your recordings on a TV, you need a PAL system-based TV.
- Television programs, films, video tapes, and other materials may be copyrighted. Unauthorized recording of such materials may be contrary to the copyright laws.

### About this Handbook

- The images of the viewfinder (HDR-SR7E/SR8E) and the LCD screen used in this Handbook for illustration purposes are captured using a digital still camera, and therefore may appear different.
- The illustrations used in this Handbook are based on the model HDR-SR7E. The model name is indicated on the bottom of your camcorder.
- Design and specifications of recording media and other accessories are subject to change without notice.

## **About the Carl Zeiss lens**

Your camcorder is equipped with a Carl Zeiss lens, which was developed jointly by Carl Zeiss, in Germany, and Sony Corporation, and produces superior images. It adopts the MTF measurement system for video cameras and offers a quality typical of a Carl Zeiss lens. Also, the lens for your camcorder is T\*<sup>\*</sup>-coated to suppress unwanted reflections and faithfully reproduce colors.

MTF= Modulation Transfer Function. The number value indicates the amount of light from a subject coming into the lens.

# Notes on using the Hard Disk Drive Handycam

## Save all your recorded image data

- To prevent your image data from being lost, save all your recorded images on external media. It is recommended that you save the image data on a disc such as DVD-R using your computer (p. 45). Also, you can save your image data using a VCR, or a DVD/HDD recorder (p. 53).
- It is recommended that you save your image data periodically, after recording.

## Do not apply shock or vibration to your camcorder

- The hard disk of the camcorder may not be recognized, or recording or playback may not be possible.
- Especially, during recording/playback, do not apply shock. After recording, do not apply vibration or shock to the camcorder, while the ACCESS lamp is lit.
- When using the shoulder belt (not supplied), do not crash the camcorder against an object.

## On the drop sensor

- To protect the internal hard disk from the shock by dropping, the camcorder has the drop sensor function (p. 75). When a drop occurs, or under a non-gravity condition, the block noise made when this function is activated by the camcorder may also be recorded. If the drop sensor catches a drop repeatedly, recording/playback may be stopped.

## Notes on battery pack/AC Adaptor

- While the ACCESS lamp is lit, be sure to avoid the following. They may cause malfunctions.
  - Removing the battery pack
  - Removing the AC Adaptor (while charging the battery pack using the AC Adaptor)
- Be sure to remove the battery pack or the AC Adaptor after turning off the POWER switch.

## Note on operating temperatures

- When the temperature of the camcorder becomes extremely high or extremely low, you may not be able to record or play back on the camcorder, due to the protection features of the camcorder being activated in such situations. In this case, an indicator appears in the viewfinder (HDR-SR7E/SR8E) or on the LCD screen (p. 92).

## When the camcorder is connected to a computer

- Do not try to format the hard disk of the camcorder using a computer. If you do so, your camcorder may not operate correctly.

## Note on using the camcorder at high altitudes

- Do not turn on the camcorder in a low-pressure area, where the altitude is more than 3,000 meters (9,800 feet). Doing so may damage the hard disk drive of your camcorder.

## Note on disposal/transfer

- Even if you perform [⊖] FORMAT (p. 57) or formatting the hard disk of the camcorder, you may not delete data from the hard disk completely. When you transfer the camcorder, it is recommended that you perform [⊖] EMPTY (p. 60) to prevent the recovery of your data.  
In addition to the above, when you dispose of the camcorder, it is recommended that you destroy the actual body of the camcorder.

## If you cannot record/play back images, perform [⊖] FORMAT

- If you repeat recording/deleting images for a long time, fragmentation of data occurs on the hard disk. Images cannot be saved or recorded. In such a case, save your images on some type of external media first, and then perform [⊖] FORMAT (p. 57).  
Fragmentation ⓘ Glossary (p. 114)

# Table of Contents

Read this before operating your camcorder .....	2
Notes on using the Hard Disk Drive Handycam .....	5
Subject examples and solutions .....	8

## Enjoying your camcorder

Operation flow .....	9
“HOME” and “OPTION” - Taking advantage of two types of menus .....	12

## Getting Started

Step 1: Checking supplied items .....	15
Step 2: Charging the battery pack .....	16
Step 3: Turning the power on and setting the date and time .....	20
Changing the language setting ...	21
Step 4: Making setting adjustments before recording .....	21

## Recording/Playback

Recording and playback with ease (Easy Handycam operation) .....	23
Recording .....	27
Zooming .....	29
Recording sound with more presence (5.1ch surround recording) .....	29
Using the flash .....	30
Recording high quality still images during movie recording (Dual Rec) .....	30
Recording still images on a “Memory Stick Duo” .....	31
Recording in dark places (NightShot) .....	31

Adjusting the exposure for backlit subjects .....	32
Recording in mirror mode .....	32
Recording the fast action in slow-motion (SMTH SLW REC) .....	32
Controlling the image settings manually with the CAM CTRL dial (HDR-SR7E/SR8E) .....	33

Playback .....	34
Playing back from a face image ([INDEX]) .....	37
Using PB zoom .....	37
Searching for desired images by date (Date Index) .....	37
Playing back a series of still images (Slide show) .....	38
Playing the image on a TV .....	39
Saving images .....	45

## Editing







(Others) category .....	46
Deleting images .....	46
Dividing a movie .....	48
Copying still images .....	49
Creating the Playlist .....	50
Dubbing to VCR or DVD/HDD recorders .....	53
Printing recorded images (PictBridge compliant printer) .....	54

## Utilizing recording media

(MANAGE HDD/MEMORY) category .....	57
Formatting the hard disk or the “Memory Stick Duo” .....	57
Checking the hard disk information .....	58
Repairing the image database file .....	59

Preventing data on the hard disk of the camcorder from being recovered .....	60
--	----

## Customizing your camcorder

What you can do with the  (SETTINGS) category of the	
 HOME MENU .....	61
Using the HOME MENU .....	61
List of the  (SETTINGS) category items .....	62
MOVIE SETTINGS .....	63
(Items for recording movies)	
PHOTO SETTINGS .....	67
(Items for recording still images)	
VIEW IMAGES SET .....	70
(Items to customize the display)	
SOUND/DISP SET .....	72
(Items to adjust the sound and the screen)	
OUTPUT SETTINGS .....	73
(Items for when connecting other devices)	
CLOCK/  LANG .....	74
(Items to set clock and language)	
GENERAL SET .....	75
(Other setup items)	
Activating functions using the	
 OPTION MENU .....	76
Using the OPTION MENU .....	76
Recording items on the OPTION MENU .....	77
Viewing items on the OPTION MENU .....	77
Functions set in the  OPTION MENU .....	78

## Troubleshooting

Troubleshooting .....	84
Warning indicators and messages .....	92

## Additional Information

Using your camcorder abroad .....	96
Files on the camcorder hard disk/ folder structure .....	98
Maintenance and precautions .....	99
About the AVCHD format .....	99
About the "Memory Stick" .....	99
About the "InfoLITHIUM" battery pack .....	101
About x.v.Color .....	102
About handling of your camcorder .....	102

## Quick Reference

Identifying parts and controls .....	107
Indicators displayed during recording/ playback .....	112
Glossary .....	114
Index .....	115

# Subject examples and solutions

## Checking your golf swing



▶ SMTH SLW REC ..... 32

## Getting a good shot of a ski slope or beach



▶ Backlight .....32  
▶ BEACH .....80  
▶ SNOW .....80

## Capturing still images during movie recording



▶ Dual Rec ..... 30

## A child on the stage under a spot light



▶ SPOTLIGHT .....80

## Flowers in close-up



▶ PORTRAIT ..... 80  
▶ FOCUS ..... 78  
▶ TELE MACRO ..... 79

## Fireworks with all its splendor



▶ FIREWORKS .....80  
▶ FOCUS .....78

## Focusing on the dog on the left side of the screen

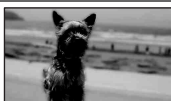

▶ FOCUS ..... 78  
▶ SPOT FOCUS ..... 79

## A sleeping child under dim light



▶ NightShot .....31  
▶ COLOR SLOW SHTR .....81



# Operation flow

▶ Get ready (p. 15).

▶ Record using your camcorder (p. 27).

- Movies are recorded on the hard disk, and still images are recorded on either the hard disk or a “Memory Stick Duo.”
- You can select the image quality: HD (high definition) image quality or SD (standard definition) image quality.



**HD (high definition) image quality**

**SD (standard definition) image quality**

**AVCHD format**

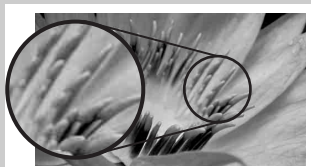

Image resolution: about 3.75 times of that of SD (standard definition) image quality

**MPEG2 format**



Records with SD (standard definition) image quality.

**⚡ Notes**

- Your camcorder is compatible with the “1440 × 1080/50i” standard of AVCHD format (p. 99). “AVCHD 1080i format” is abbreviated as “AVCHD” in this manual, except when it must be described in more detail.

### ► Play back the images.

#### ■ Viewing on the LCD screen of your camcorder (p. 34)

#### ■ Viewing on a high definition TV (p. 41)

You can enjoy movies with HD (high definition) image quality, with the same image quality as they were recorded.

#### ■ Viewing on a non-high-definition 16:9 (wide) TV (p. 42)

You can enjoy movies recorded with HD (high definition) image quality, but they will be converted to SD (standard definition) image quality.



#### 💡 Tips

- You can consult the [TV CONNECT Guide] (p. 39) displayed on the screen on connecting your TV and camcorder.



### ► Save recorded images.

#### ■ Saving images on a disc using a computer

#### ■ Importing images to a computer

#### ■ Dubbing images on VCR or DVD/HDD recorders (p. 53)

#### 💡 Tips

- See “Picture Motion Browser Guide” about handling images on a computer.



### ► Delete images.

If the hard disk of your camcorder is full, you cannot record new images. Delete the image data that has been saved on your camcorder or a disc. If you delete the images, you can record new images on the free hard disk space again.

#### ■ Deleting the selected images (p. 46)

#### ■ Deleting all the images ([FORMAT], p. 57)

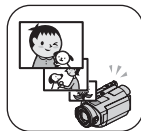

## Recording time of movies

HD (high definition) image quality

AVCHD format

Recording mode	Approximate recordable time (hour minute)		
	HDR-SR5E	HDR-SR7E	HDR-SR8E
AVC HD 15M (XP) (highest quality)	5 h 20 m	8 h	13 h 30 m
AVC HD 9M (HQ) (high quality)	9 h 40 m	14 h 40 m	24 h 40 m
AVC HD 7M (SP) (standard quality)	11 h 50 m	17 h 50 m	30 h
AVC HD 5M (LP) (long play)	15 h 10 m	22 h 50 m	38 h 10 m

SD (standard definition) image quality

MPEG2 format

Recording mode	Approximate recordable time (hour minute)		
	HDR-SR5E	HDR-SR7E	HDR-SR8E
SD 9M (HQ) (high quality)	9 h 40 m	14 h 40 m	24 h 40 m
SD 6M (SP) (standard quality)	14 h 30 m	21 h 50 m	36 h 30 m
SD 3M (LP) (long play)	27 h 50 m	41 h 50 m	70 h 10 m

### Tips

- Figures such as 15M and 9M in the table show the average bit rate. M stands for Mbps.
- You can record movies of a maximum of 3,999 scenes with HD (high definition) image quality, and 9,999 scenes with SD (standard definition) image quality.
- You can record the maximum 9,999 still images on the hard disk. For the “Memory Stick Duo,” see page 68.
- The maximum continuous recordable time is approximately 13 hours.

Your camcorder uses the VBR (Variable Bit Rate) format to automatically adjust image quality to suit the recording scene. This technology causes fluctuations in the recording time of the hard disk. Movies containing quickly moving and complex images are recorded at a higher bit rate, and this reduces the overall recording time.

# “HOME” and “OPTION”

## - Taking advantage of two types of menus

“HOME MENU” - the starting point for operations with your camcorder

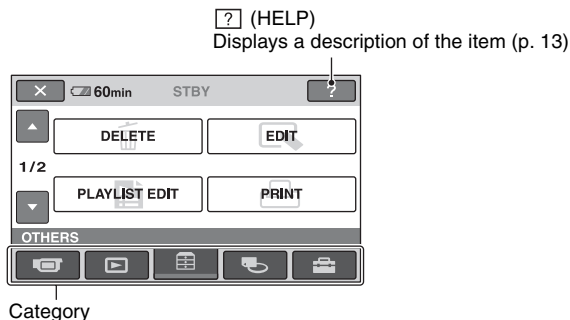

### ► Categories and items of the HOME MENU

#### (CAMERA) category

Item	Page
MOVIE*	28
PHOTO*	28
SMTH SLW REC	32

#### (VIEW IMAGES) category

Item	Page
VISUAL INDEX*	34
INDEX*	35
INDEX*	37
PLAYLIST	50

#### (OTHERS) category

Item	Page
DELETE*	46
EDIT	48, 49
PLAYLIST EDIT	50
PRINT	54
COMPUTER	46
TV CONNECT Guide*	40

#### (MANAGE HDD/MEMORY) category

Item	Page
FORMAT*	57
FORMAT*	58
INFO	58
REPAIR IMG.DB F.	59

#### (SETTINGS) category

To customize your camcorder (p. 61)\*.

\* You can also set these items during Easy Handycam operation (p. 23). For the items available in the (SETTINGS) category, see page 62.

## Using the HOME MENU

- 1 While pressing the green button in the center, slide the POWER switch in the direction of the arrow to turn on the power.

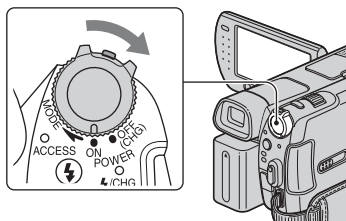

- 2 Press (HOME) [A] (or [B]).

(HOME) [B]

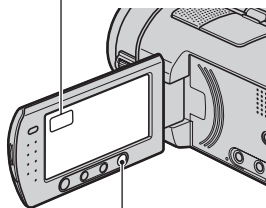

(HOME) [A]

- 3 Touch the desired category.

Example: (OTHERS) category



- 4 Touch the desired item.

Example: [EDIT]

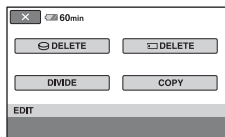

- 5 Follow the guide on the screen for further operation.

## To hide the HOME MENU screen

Touch .

- ▶ When you want to know something about the function of each item on the HOME MENU - HELP

- 1 Press (HOME).

The HOME MENU appears.



- 2 Touch (HELP).

The bottom of the (HELP) turns orange.



---

### 3 Touch the item you want to learn more about.

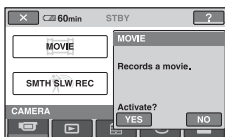

When you touch an item, its explanation appears on the screen.

To apply the option, touch [YES], otherwise, touch [NO].

---

### To deactivate the HELP

Touch [?] (HELP) again in step 2.

### Using the OPTION MENU

Just a touch on the screen during shooting or playback displays the functions available at that moment. You will find it easy to make various settings. See page 76 for further details.

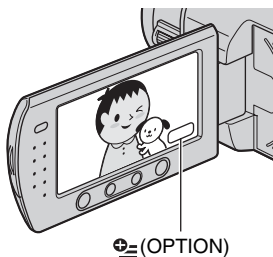

## Step 1: Checking supplied items

Make sure that you have the following items supplied with your camcorder. The number in the parentheses indicates the number of that item supplied.

AC Adaptor (1) (p. 16)

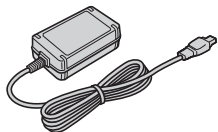

Mains lead (1) (p. 16)

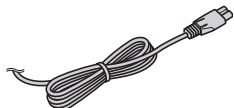

Handycam Station (1) (p. 16, 110)

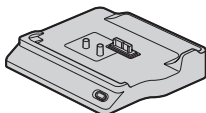

Component video cable (1) (p. 41)

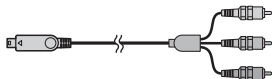

A/V connecting cable (1) (p. 41, 53)



USB cable (1) (p. 54)

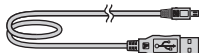

Wireless Remote Commander (1) (p. 111)



A button-type lithium battery is already installed.

Rechargeable battery pack NP-FH60 (1) (p. 16, 101)

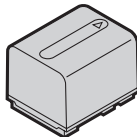

21-pin adaptor (p. 44)

For the model with the **CE** mark printed on their bottom surfaces only.

CD-ROM "Handycam Application Software" (1)

- Picture Motion Browser (Software)
- Picture Motion Browser Guide
- Handycam Handbook (This Handbook)

"Operating Guide" (1)

## Step 2: Charging the battery pack

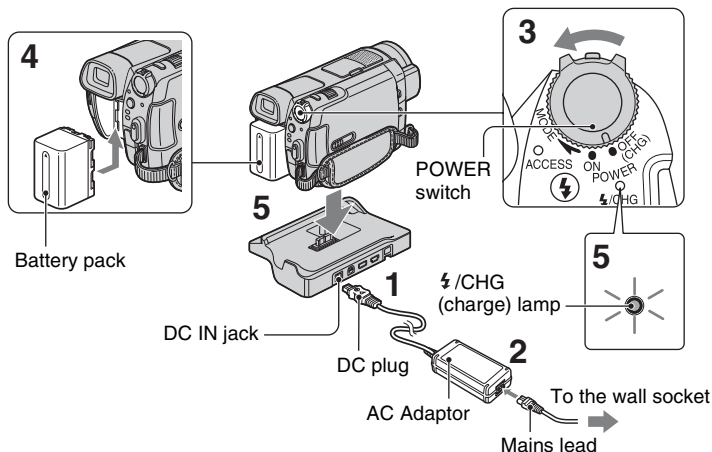

You can charge the “InfoLITHIUM” battery pack (H series) (p. 101) after attaching it to your camcorder.

### ⚡ Notes

- You cannot attach any “InfoLITHIUM” battery pack other than the H series to your camcorder.

### 1 Connect the AC Adaptor to the DC IN jack on the Handycam Station.

Be sure that the ▲ mark on the DC plug is facing up.

### 2 Connect the mains lead to the AC Adaptor and the wall socket.

### 3 Slide the POWER switch in the direction of the arrow to OFF (CHG) (the default setting).

### 4 Attach the battery pack by sliding it in the direction of the arrow until it clicks.

### 5 Insert the camcorder into the Handycam Station securely, all the way to the bottom.

The ⚡/CHG (charge) lamp lights up and charging starts. When the ⚡/CHG (charge) lamp turns off, the battery is fully charged.

### ⚡ Notes

- When inserting the camcorder into the Handycam Station, close the DC IN jack cover.



## To remove your camcorder from the Handycam Station

Turn off the power, then remove the camcorder from the Handycam Station holding both your camcorder and the Handycam Station.

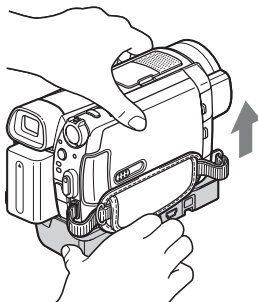

## To charge the battery pack using only the AC Adaptor

Turn off the power, then connect the AC Adaptor to the DC IN jack on your camcorder.

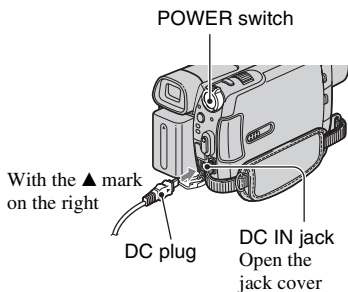

### Notes



- Disconnect the AC Adaptor from the DC IN jack holding both the camcorder and the DC plug.

## To remove the battery pack

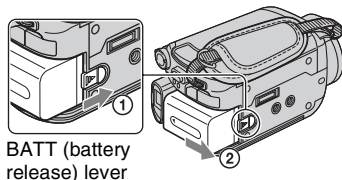
Slide the POWER switch to OFF (CHG). Slide the BATT (battery release) lever and remove the battery pack.



### Notes

- When you remove the battery pack or disconnect the AC Adaptor, make sure that the  (Movie) lamp/ (Still) lamp (p. 20) is turned off.

## When storing the battery pack

Fully discharge the battery pack before storing it for an extended period (see page 102 for the details of storage).

## To use a power source from a wall socket

Make the same connections as you do when charging the battery pack. The battery pack will not lose its charge in this case.

## To check the remaining battery (Battery Info)

Set the POWER switch to OFF (CHG), then press DISP/BATT INFO.

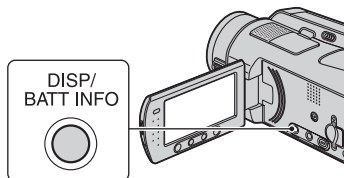

After a while, the approximate recordable time and battery information appear for about 7 seconds. You can view the battery information for up to 20 seconds by

pressing DISP/BATT INFO again while the information is displayed.

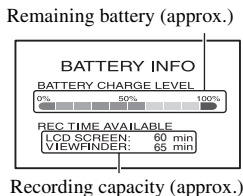

## Charging time

Approximate time (min.) required when you fully charge a fully discharged battery pack.

Battery pack	Charging time
NP-FH50	135
NP-FH60 (supplied)	135
NP-FH70	170
NP-FH100	390

## Recording time

Approximate time (min.) available when you use a fully charged battery pack. "HD" stands for high definition image quality, and "SD" stands for standard image quality.

### HDR-SR5E:

Battery pack	Continuous recording time		Typical recording time*	
Image quality	HD	SD	HD	SD
NP-FH50	80	90	40	45
	80	95	40	45
NP-FH60 (supplied)	105	120	50	60
	110	130	55	65
NP-FH70	170	195	85	95
	180	205	90	100
NP-FH100	385	440	190	220
	405	470	200	235

### HDR-SR7E/SR8E:

Battery pack	Continuous recording time		Typical recording time*	
Image quality	HD	SD	HD	SD
NP-FH50	65	75	30	35
	70	80	35	40
	70	80	35	40
NP-FH60 (supplied)	90	100	45	50
	95	105	45	50
	95	105	45	50
NP-FH70	145	165	70	80
	150	175	75	85
	150	175	75	85
NP-FH100	335	375	165	185
	350	395	175	195
	350	395	175	195

\* Typical recording time shows the time when you repeat recording start/stop, turning the power on/off and zooming.

## Notes

- All times measured with SP recording mode when [INDEX SET] is set to [OFF] under the following conditions:  
For HDR-SR5E:  
Top: When the LCD backlight turns on.  
Bottom: When the LCD backlight turns off.  
For HDR-SR7E/SR8E:  
Top: When the LCD backlight turns on.  
Middle: When the LCD backlight turns off.  
Bottom: When recording with the viewfinder while the LCD panel is closed.

## Playing time

Approximate time (min.) available when you use a fully charged battery pack. "HD" stands for high definition image quality, and "SD" stands for standard image quality.

### HDR-SR5E:



Battery pack	LCD panel opened*	
	HD	SD
Image quality		
NP-FH50	115	125
NP-FH60 (supplied)	150	165
NP-FH70	245	270
NP-FH100	555	600

### HDR-SR7E/SR8E:

Battery pack	LCD panel opened*		LCD panel closed	
	HD	SD	HD	SD
Image quality				
NP-FH50	105	120	115	130
NP-FH60 (supplied)	140	160	150	170
NP-FH70	230	255	245	280
NP-FH100	515	580	555	625

\* When the LCD backlight is on.

### On the battery pack

- Before changing the battery pack, slide the POWER switch to OFF (CHG) and turn off the  (Movie) lamp/ (Still) lamp.
- The /CHG (charge) lamp flashes during charging, or Battery Info (p. 17) will not be correctly displayed under the following conditions:
  - The battery pack is not attached correctly.
  - The battery pack is damaged.
  - The battery pack is worn-out (For Battery Info only).
- The power will not be supplied from the battery as long as the AC Adaptor is connected to the DC IN jack of your camcorder or the Handycam Station, even when the mains lead is disconnected from the wall socket.

- When attaching an optional video light, it is recommended that you use an NP-FH70 or NP-FH100 battery pack.
- We do not recommend using an NP-FH30, which only allows short recording and playback times, with your camcorder.

### On the charging/recording/playback time

- Times measured when using the camcorder at 25 °C (77 °F) (10 °C to 30 °C (50 °F to 86 °F) is recommended).
- The recording and playback time will be shorter when you use your camcorder in low temperatures.
- The recording and playback time will be shorter depending on the conditions under which you use your camcorder.

### On the AC Adaptor

- Use the nearby wall socket when using the AC Adaptor. Disconnect the AC Adaptor from the wall socket immediately if any malfunction occurs while using your camcorder.
- Do not use the AC Adaptor placed in a narrow space, such as between a wall and furniture.
- Do not short-circuit the DC plug of the AC Adaptor or battery terminal with any metallic objects. This may cause a malfunction.
- Even if your camcorder is turned off, AC power (mains) is still supplied to it while connected to the wall socket via the AC Adaptor.

# Step 3: Turning the power on and setting the date and time

Set the date and time when using this camcorder for the first time. If you do not set the date and time, the [CLOCK SET] screen appears every time you turn on your camcorder or change the POWER switch position.

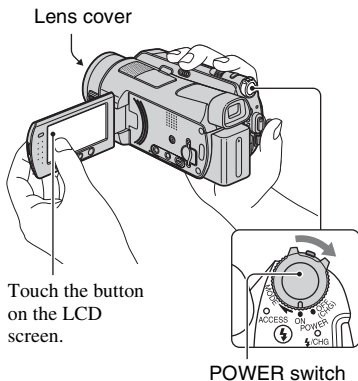

- 1 While pressing the green button, slide the POWER switch repeatedly in the direction of the arrow until the respective lamp lights up.

 (Movie): To record movies

 (Still): To record still images

The [CLOCK SET] screen appears.

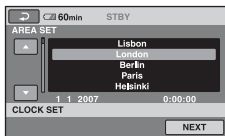

- 2 Select the desired geographical area with  $\blacktriangle/\blacktriangledown$ , then touch [NEXT].

- 3 Set [SUMMERTIME], then touch [NEXT].

- 4 Set [Y] (year) with  $\blacktriangle/\blacktriangledown$ .



- 5 Select [M] with  $\blacktriangle/\blacktriangledown$ , then set the month with  $\blacktriangle/\blacktriangledown$ .

- 6 Set [D] (day), hour and minute in the same way, then touch [NEXT].

- 7 Make sure that the clock is correctly set, then touch [OK].



The clock starts.

You can set any year up to the year 2037.

## To turn off the power

Slide the POWER switch to OFF (CHG).

## To reset the date and time

Touch  (HOME)  $\rightarrow$   (SETTINGS)  $\rightarrow$  [CLOCK/ LANG]  $\rightarrow$  [CLOCK SET], and set the date and time.

## Notes

- If you do not use your camcorder for **about 3 months**, the built-in rechargeable battery gets discharged and the date and time settings may be cleared from the memory. In that case, charge the built-in rechargeable battery and then set the date and time again (p. 104).

## Step 4: Making setting adjustments before recording

- It takes a few seconds for your camcorder to be ready to shoot after the power is turned on. You cannot operate your camcorder during this time.
- The lens cover opens automatically when the power is turned on. It closes when the playback screen is selected, or the power is turned off.
- In the setting at the time of purchase, the power turns off automatically if you leave your camcorder without any operation attempted for approximately 5 minutes, to save battery power ([A.SHUT OFF], p. 75).

### Tips

- The date and time does not appear during recording, but they are automatically recorded on the hard disk, and can be displayed during playback (see page 70 for [DATA CODE]).
- Refer to page 97 for information concerning "World time difference."
- If the buttons on the touch panel do not work correctly, adjust the touch panel (CALIBRATION) (p. 103).

## Changing the language setting

You can change the on-screen displays to show messages in a specified language. To select the screen language, touch

(HOME) → (SETTINGS) → [CLOCK/]  
[A] LANG] → [A] LANGUAGE SET] (p. 74).

## Adjusting the LCD panel

Open the LCD panel 90 degrees to the camcorder (①), then rotate it to the best angle to record or play (②).

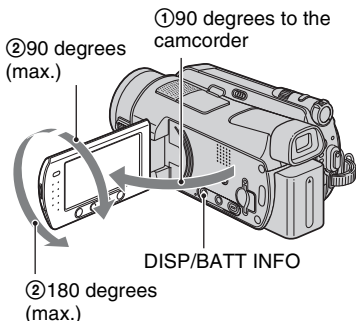

## To turn off the LCD backlight to make the battery last longer

Press and hold DISP/BATT INFO for a few seconds until appears.

This setting is practical when you use your camcorder in bright conditions or you want to save battery power. The recorded image will not be affected by the setting. To turn on the LCD backlight, press and hold DISP/BATT INFO for a few seconds until disappears.

### Notes

- Do not press the buttons below the LCD screen accidentally when you open or adjust the LCD panel.

### Tips

- If you open the LCD panel 90 degrees to the camcorder, then rotate it 180 degrees to the lens side, you can close the LCD panel with the LCD screen facing out. This is convenient during playback operations.
- Touch (HOME) → (SETTINGS) → [SOUND/DISP SET] → [LCD BRIGHT] (p. 72), and adjust the brightness of the LCD screen.

- The information is displayed or hidden (display ↔ no display) each time you press DISP/BATT INFO.

## Adjusting the Viewfinder (HDR-SR7E/SR8E)

You can view images using the viewfinder with the LCD panel closed to avoid wearing down the battery, or when the image seen on the LCD screen is poor.

### Viewfinder

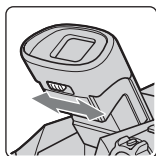

Viewfinder lens adjustment lever  
Move it until the image is clear.

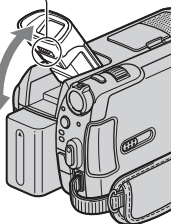

### 💡 Tips

- You can adjust the brightness of the viewfinder backlight by touching **HOME** → **SETTINGS** → [SOUND/DISP SET] → [VF B.LIGHT] (p. 72).

## Fastening the grip belt

Fasten the grip belt and hold your camcorder correctly.

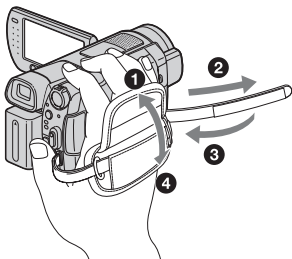



# Recording and playback with ease (Easy Handycam operation)

Easy Handycam operation makes nearly all settings automatic so that you can perform recording or playback operation without detailed settings. It also makes screen font size larger for easy viewing.

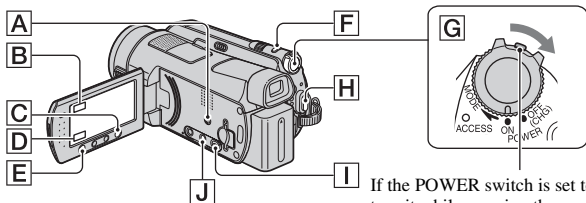

If the POWER switch is set to OFF (CHG), turn it while pressing the green button.

## Recording movies



- Slide the POWER switch **G** in the direction of the arrow until the  (Movie) lamp lights up.



- Press EASY **A**.



 EASY appears on the LCD screen.

- Press START/STOP **H** (or **E**) to start recording.\*

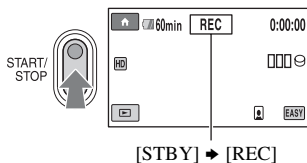

To stop recording, press START/STOP again.

## Recording still images



Still images are recorded on the hard disk in the default setting. You can change the recording media of still images to a "Memory Stick Duo" (p. 31).

- Slide the POWER switch **G** in the direction of the arrow until the  (Still) lamp lights up.



- Press EASY **A**.



 EASY appears on the LCD screen.

- Press PHOTO **F** lightly to adjust the focus **A** (a beep sounds), then press it fully **B** (a shutter click sounds).\*\*

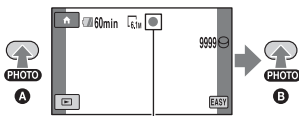

Flashing → Lights up

\* The recording mode is fixed to SP (p. 63).

\*\* The setting of [  QUALITY ] is fixed to [ FINE ] (p. 68).

## Playing back recorded movies/still images

**1** Slide the **POWER** switch **G** to turn on your camcorder.

**2** Press **▶** (**VIEW IMAGES**) **I** (or **D**).

The **VISUAL INDEX** screen appears on the LCD screen (It may take some time to display the thumbnails).

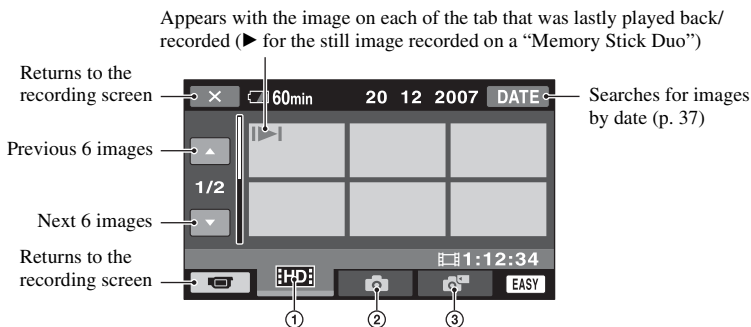

① **HD**: Displays movies with HD (high definition) image quality.\*

② **📷**: Displays still images on the hard disk.

③ **MS**: Displays still images on a “Memory Stick Duo.”

\* **SD** appears for movies with SD (standard definition) image quality.

### Playing back from **INDEX**

Press the **INDEX** (Film Roll Index) **J**, or touch **HOME** → **▶** (**VIEW IMAGES**) → **INDEX**.

#### **Tips**

- You can change the image quality by touching **HOME** → **SETTINGS** → [VIEW IMAGES SET] → [**HD**/**SD**] **INDEX SET**.



### 3 Start playback.

#### Movies:

Touch the **HD** or **HSD** tab and the movie to be played back.

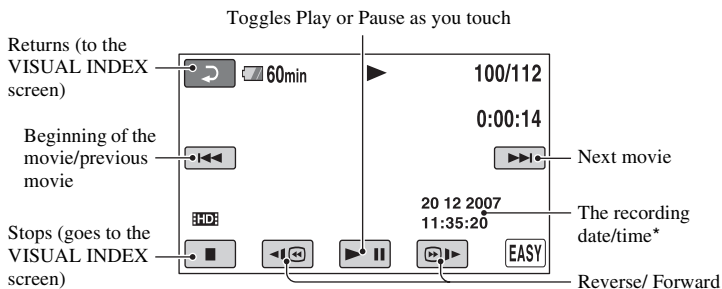

\* The setting of [DATA CODE] is fixed to [DATE/TIME] (p. 70).

#### Tips

- When playback from the selected movie reaches the last movie, the screen returns to the VISUAL INDEX screen.
- You can slow down the playback speed by touching **⏮**/**⏭** during pause.
- You can adjust volume by touching **🏠** (HOME) → **⚙️** (SETTINGS) → **[SOUND SETTINGS]** → **[VOLUME]**, then touch **⏪**/**⏩**.

#### Still images:

Touch the **📷** or **📺** tab, and then select the desired still image.

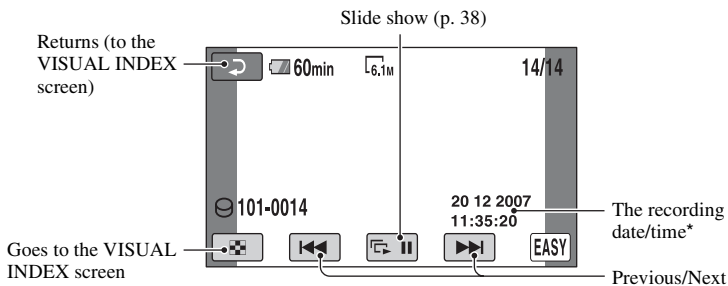

\* The setting of [DATA CODE] is fixed to [DATE/TIME] (p. 70).

## To cancel Easy Handycam operation

Press EASY [A] again. EASY disappears from the LCD screen.

## Menu settings during Easy Handycam operation

Press  (HOME) [C] (or [B]) to display the menu items available for setup changes (p. 12, 61).

### Notes

- Most of the menu items automatically return to the default settings. The settings of some menu items are fixed. For details, see page 85.
- You cannot use the  (OPTION) menu.
- Cancel Easy Handycam operation if you want to add effects to images or change settings.

## Invalid buttons during Easy Handycam operation

You cannot use some buttons/functions during Easy Handycam operation since they are automatically set (p. 85). If you set an invalid operation, [Invalid during Easy Handycam operation] may appear.

# Recording

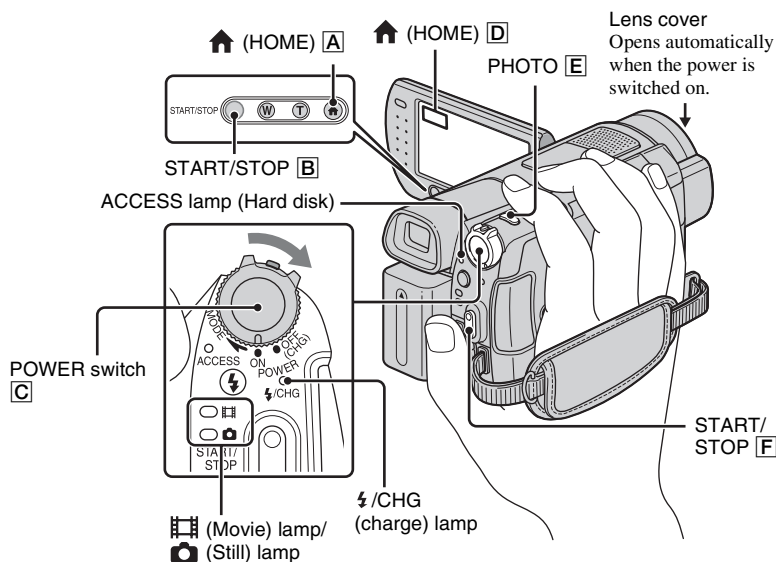

## Notes

- If the ACCESS lamp is lit or flashing after recording is finished, it means data is still being written onto the hard disk or "Memory Stick Duo." Do not apply shock or vibration to your camcorder, and do not remove the battery or AC Adaptor.
- The maximum continuous recordable time is approximately 13 hours.
- When a movie file exceeds 2 GB, the next movie file is created automatically.

## Tips

- You can check the free hard disk space by touching **HOME** → **(MANAGE HDD/MEMORY)** → **[INFO]** (p. 58).

## Recording movies



You can record movies on the hard disk of your camcorder. For the recordable time, see page 11.

**1** Slide the **POWER** switch **C** in the direction of the arrow to light up the (Movie) lamp.

**2** Press **START/STOP** **B** (or **F**).

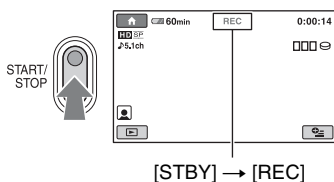

To stop recording, press **START/STOP** **B** (or **F**) again.

## Recording still images



Still images are recorded on the hard disk in the default setting. To record still images on a "Memory Stick Duo," change the recording media (p. 31). For the number of recordable still images, see page 68.

**1** Slide the **POWER** switch **C** until the (Still) lamp lights up.

**2** Press **PHOTO** **E** lightly to adjust the focus **A** (a beep sounds), then press it fully **B** (a shutter click sounds).

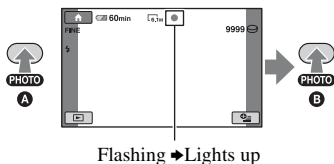

appears beside . When disappears, the image has been recorded.

## Notes

- You cannot record movies on a "Memory Stick Duo."

## Tips

- appears when [ INDEX SET] is set to [ON] (the default setting) during movie recording (p. 67).
- You can switch the shooting mode by touching (HOME) **D** (or **A**)  $\rightarrow$  (CAMERA)  $\rightarrow$  [MOVIE] or [PHOTO].
- See page 30 for recording high quality still images during movie recording.
- See page 31 for changing the recording media of still images.

## Zooming

You can magnify images up to 10 times the original size with the power zoom lever or the zoom buttons below the LCD screen.

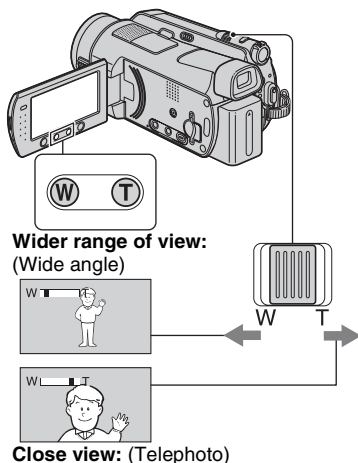

Move the power zoom lever slightly for a slower zoom. Move it further for a faster zoom.

### ⚡ Notes

- Be sure to keep your finger on the power zoom lever. If you move your finger off the power zoom lever, the operation sound of the power zoom lever may also be recorded.
- You cannot change the zoom speed with the zoom buttons below the LCD screen.
- The minimum possible distance between camcorder and subject while maintaining sharp focus is about 1 cm (about 13/32 in.) for wide angle and about 80 cm (about 2 5/8 feet) for telephoto.

### 💡 Tips

- You can set [DIGITAL ZOOM] (p. 65) if you want to zoom to a level greater than 10 × when recording movies.

## Recording sound with more presence (5.1ch surround recording)

Dolby Digital 5.1ch surround sound can be recorded with the internal microphone. You can enjoy realistic sound when playing the movie on devices that support 5.1ch surround sound.

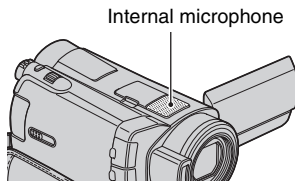

Dolby Digital 5.1 Creator, 5.1ch surround sound  
📖 Glossary (p. 114)

### ⚡ Notes

- 5.1ch sound is converted to 2ch when played back on your camcorder.
- To enjoy the 5.1ch surround sound recorded with HD (high definition) image quality, you need an AVCHD format device compatible with 5.1ch surround.
- You can create a disc, which contains the movies recorded on your camcorder, on a computer using the supplied software. If you play the disc on a 5.1ch surround system, you can enjoy realistic sound.
- 🎵5.1ch is displayed on the screen during 5.1ch recording/playback.

## Using the flash

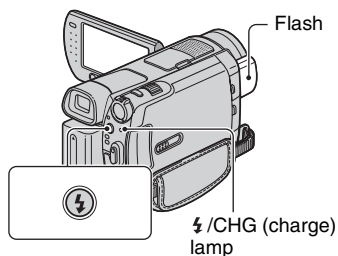

Press **⚡** (flash) repeatedly to select an appropriate setting.

No indication (Auto flash): Automatically flashes when there is insufficient ambient light.



**⚡** (Forced flash): Always uses the flash regardless of the surrounding brightness.



**⊕** (No flash): Records without flash.

### ⚡ Notes

- The recommended distance to the subject when using the built-in flash is approximately 0.3 to 2.5 m (1 to 8 feet).
- Remove any dust from the surface of the flash before using it. Flash effect may be impaired if heat discoloration or dust obscures the lamp.
- The **⚡ /CHG** (charge) lamp flickers while charging the flash, and remains lit when the battery charge is complete.
- If you use the flash in bright places such as when shooting a backlit subject, the flash may not be effective.
- When attaching a conversion lens (optional) or a filter (optional) to your camcorder, the flash does not emit light.

### 💡 Tips

- You can change the brightness of the flash by setting [FLASH LEVEL] (p. 66), or you can prevent the red-eye by setting [REDEYE REDUC] (p. 66).

## Recording high quality still images during movie recording (Dual Rec)

You can record high quality still images while recording a movie on the hard disk.

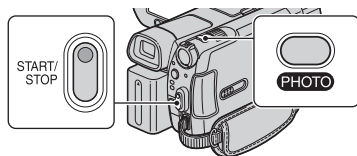

- ① Slide the POWER switch until the  (Movie) lamp lights up, then press START/STOP to start movie recording.

- ② Press PHOTO fully.

After you start recording, and before you finish, you can select up to 3 frames of still images from your movie.

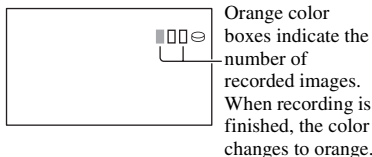



- ③ Press START/STOP to stop movie recording.

Stored still images appear one by one, and the images are stored. When  disappears, the image has been recorded.

### ⚡ Notes

- When you record still images on a "Memory Stick Duo," do not eject the "Memory Stick Duo" before movie recording is finished and the still images are stored on it.
- You cannot use the flash during Dual Rec.

### 💡 Tips

- When the POWER switch is set to  (Movie), the size of still images becomes:
  -  2.3M (16:9 wide) or 1.7M (4:3) (HDR-SR5E)
  -  4.6M (16:9 wide) or 3.4M (4:3) (HDR-SR7E/SR8E)

- You can record still images during recording standby in the same way as when the  (Still) lamp is turned on. You can also record with the flash.

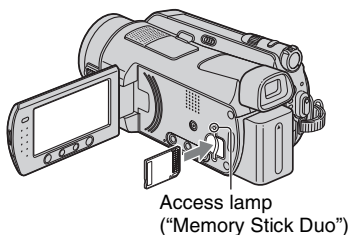

## Recording still images on a “Memory Stick Duo”

You can change the recording media of still images to a “Memory Stick Duo.” In the default setting, still images are recorded on the hard disk of the camcorder. You can use only a “Memory Stick Duo” marked with **MEMORY STICK DUO** or **MEMORY STICK PRO DUO** (p. 99).



Open the LCD panel. Insert the “Memory Stick Duo” into the Memory Stick Duo slot in the right direction until it clicks.

## To change the recording media of still images

- ① On the recording screen, touch  (OPTION) →  tab → [STILL MEDIA].
- ② Select the media in which you want to save still images, then touch [OK]. Your camcorder returns to recording standby mode. If you select [MEMORY STICK],  appears on the screen.

## To eject a “Memory Stick Duo”

Open the LCD panel, then lightly push the “Memory Stick Duo” in once.

## Notes

- When the ACCESS lamp is lit or flashing, your camcorder is reading/writing data. Do not shake or knock your camcorder, turn the power off, eject the “Memory Stick Duo,” or remove the battery pack. Otherwise, image data may be damaged.
- If you insert the “Memory Stick Duo” into the slot in the wrong direction, the “Memory Stick Duo,” the Memory Stick Duo slot, or image data may be damaged.

## Tips

- The number of recordable images varies depending on the image quality or the image size. For details, see page 68.

## Recording in dark places (NightShot)

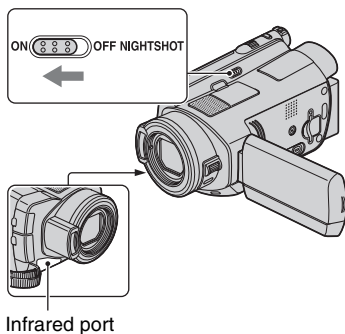

Set the NIGHTSHOT switch to ON ( appears).

## Notes

- The NightShot and Super NightShot functions use infrared light. Therefore, do not cover the infrared port with your fingers or other objects.
- Remove the conversion lens (optional).
- Adjust the focus manually ([FOCUS], p. 78) when it is hard to focus automatically.
- Do not use the NightShot and Super NightShot functions in bright places. This may cause a malfunction.

## 💡 Tips

- To record an image brighter, use Super NightShot function (p. 82). To record an image more faithfully to the original colors, use Color Slow Shutter function (p. 81).

## Adjusting the exposure for backlit subjects

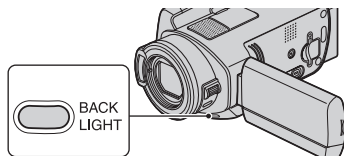

To adjust the exposure for backlit subjects, press BACK LIGHT to display . To cancel the back light function, press BACK LIGHT again.

## Recording in mirror mode

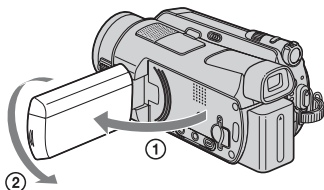



Open the LCD panel 90 degrees to the camcorder (①), then rotate it 180 degrees to the lens side (②).

## 💡 Tips

- A mirror-image of the subject appears on the LCD screen, but the image will be normal when recorded.

## Recording the fast action in slow-motion (SMTH SLW REC)

Fast moving subjects and actions, which cannot be captured under the ordinary shooting conditions, can be shot in smooth moving slow-motion for about 3 seconds. This is useful to shoot fast actions such as a golf or tennis swing.



- ① Slide the POWER switch to turn on the camcorder.
- ② Touch  (HOME) →  (CAMERA) → [SMTH SLW REC].



- ③ Press START/STOP.  
A 3 second-movie (approx.) is recorded as a 12 second-slow-motion-movie.  
[Recording...] disappears, when recording is finished.

Touch  to cancel the smooth slow recording.

## To change the setting

Touch  (OPTION) →  tab, then select the setting you want to change.

- [TIMING]  
Select the recording start point after START/STOP is pressed. The default setting is [3sec AFTER].

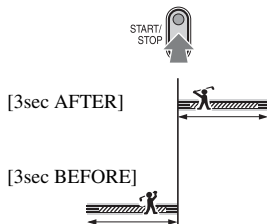



- [RECORD SOUND]  
Select [ON] (  ) to superimpose sounds such as conversation on the slow motion pictures (The default setting is [OFF]). Your camcorder records sounds for about 12 seconds while [Recording...] is displayed in step ③.

### Notes

- Sounds cannot be recorded while shooting a 3 second-movie (approx.).
- Image quality of [SMTH SLW REC] is not as good as that of normal recording.

## Controlling the image settings manually with the CAM CTRL dial (HDR-SR7E/SR8E)

You can assign one menu item you use often to the CAM CTRL dial. Since the focus adjustment is assigned to the CAM CTRL dial in the default settings, the operation below is described as adjusting the focus using the dial.

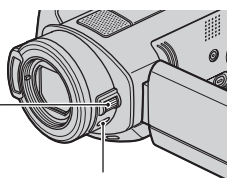

CAM CTRL dial

MANUAL

- ① Press MANUAL to activate the manual adjustment mode.  
Pressing MANUAL switches the setting mode between automatic and manual.
- ② Rotate the CAM CTRL dial to adjust the focus.

## Items you can assign to the CAM CTRL dial

- [FOCUS] (p. 78)
- [EXPOSURE] (p. 79)
- [AE SHIFT] (p. 64)
- [WB SHIFT] (p. 64)

## To assign the menu items to the CAM CTRL dial

- ① Press and hold MANUAL for a few seconds.

The [DIAL SETTING] screen appears.

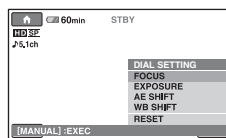



- ② Rotate the CAM CTRL dial and select the item to be assigned.
- ③ Press MANUAL.

### Notes

- Manual settings will be retained even if you change the assigned item of the CAM CTRL dial. However, if you set [EXPOSURE] after setting [AE SHIFT] manually, [EXPOSURE] will override [AE SHIFT].
- If you select [RESET] in step ②, all the items adjusted manually are reset to the default settings.

### Tips

- The functions of the items that can be assigned to the CAM CTRL dial are the same as those of menu operation.
- You can also assign menu items to the CAM CTRL dial by touching  (HOME) →  (SETTINGS) → [MOVIE SETTINGS]/[PHOTO SETTINGS] → [DIAL SETTING] (p. 67).

# Playback

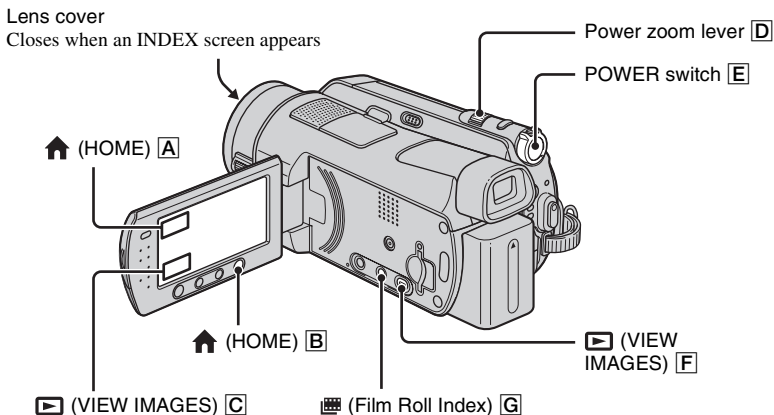

**1** Slide the POWER switch **E** to turn on your camcorder.

**2** Display the desired INDEX screen.

## Playing back from VISUAL INDEX

Press **VIEW IMAGES** **F** (or **C**).

The VISUAL INDEX screen appears on the LCD screen (It may take some time to display the thumbnails).

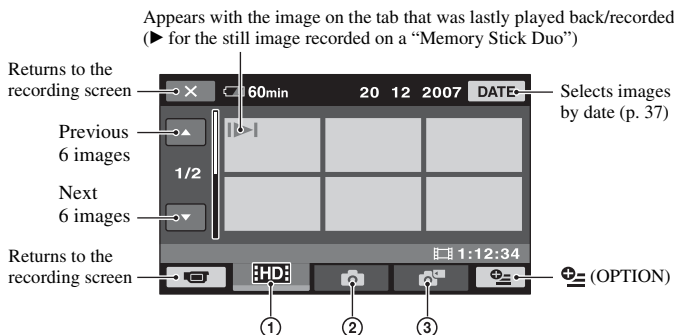

① **HD**: Displays movies with HD (high definition) image quality.\*

- ② : Displays still images on the hard disk.
- ③ : Displays still images on a “Memory Stick Duo.”

\* appears for movies with SD (standard definition) image quality.

### Tips

- You can change the image quality of a movie you want to play back by touching (OPTION) → tab → [ INDEX SET] on the INDEX screen of or .
- The number of the images on the VISUAL INDEX screen can be changed 6 ↔ 12 by moving the power zoom lever . To fix this number, touch (HOME) → (SETTINGS) → [VIEW IMAGES SET] → [ DISPLAY] (p. 71).

## Playing back from Film Roll Index

Press (Film Roll Index) .

The [ INDEX] screen appears after few seconds (It may take some time to display the thumbnails).

Movies can be divided by a set time and the first scene of each division is displayed on the INDEX screen. You can start playing back a movie from the selected thumbnail.

Displays the previous/next thumbnail.

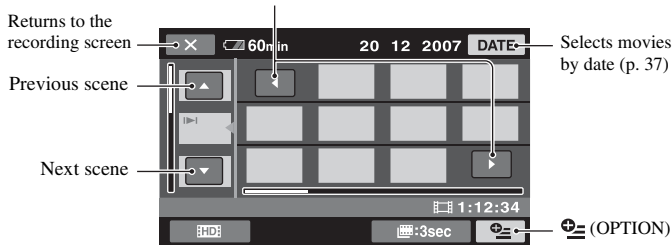

### Notes

- [ INDEX] is available only for movies.

### Tips

- You can change the image quality of a movie you want to play back by touching (OPTION) → [ INDEX SET] on the INDEX screen of or .
- Touch (OPTION) → [ INTERVAL SET] to select the duration.

### 3 Start playing back.

#### Playing movies



On the INDEX screen, touch the **MOV** or **HSD** tab to play back movies.

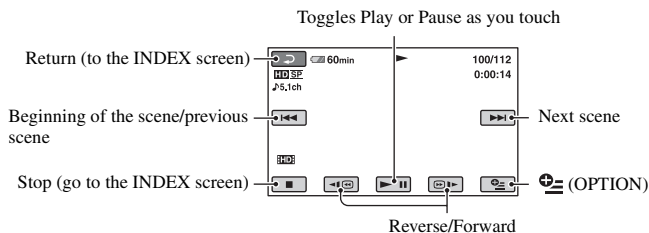

#### Tips

- When playback from the selected movie reaches the last movie, the screen returns to the INDEX screen.
- Touch **◀|⏸|▶** during pause to play back movie slowly.
- A touch of **◀|⏸|▶** makes the reverse/fast forward approximately 5 times faster, 2 touches makes it approximately 10 times faster, 3 touches makes it approximately 30 times faster, and 4 touches makes it approximately 60 times faster.

#### Viewing still images



On the VISUAL INDEX screen, touch the **📷** or **🖼️** tab to play back still images.

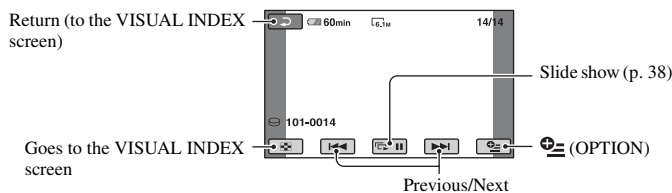

#### To adjust the sound volume

Touch **⊕** (OPTION) → **▶** tab → [VOLUME], then adjust the volume with **−**/**+**.

#### Tips

- You can switch the playback mode by touching **🏠** (HOME) → **📺** (VIEW IMAGES) → [VISUAL INDEX]/[INDEX].

## Playing back from a face image ([INDEX])

The detected face images are displayed on the index screen.

You can play back the movie from the selected face image.

- 1 Turn on your camcorder.
- 2 Touch **HOME** → **VIEW IMAGES** → **[INDEX]**.

Returns to the recording screen

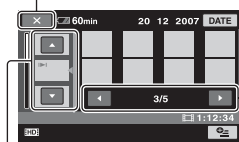

Previous/  
Next scene

Previous/  
Next display

- 3 Touch **▲/▼** to select the desired scene.
- 4 Touch **◀/▶** to search for the desired face image, then touch the face image you want to play back.  
Playback starts from the selected face image.

### Notes

- Faces may not be detected depending on recording conditions.  
Example: People wearing glasses or hats, or who do not face towards the camera.
- Set **[INDEX SET]** to **[ON]** before recording to play back from **[INDEX]** (the default setting) (p. 67).  
The face images do not appear if faces have not detected.

### Tips

- You can change the image quality of a movie you want to play back by touching **OPTION** → **[HDD]/[SD] INDEX SET** on the **[INDEX]** screen.

## Using PB zoom

You can magnify still images from about 1.1 to 5 times the original size.

Magnification can be adjusted with the power zoom lever or the zoom buttons below the LCD screen.

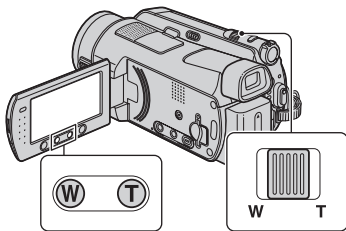

- 1 Play back the still images you want to magnify.
- 2 Magnify the still image with **T** (Telephoto).  
The screen is framed.
- 3 Touch the screen at the point you want to display in the center of the displayed frame.
- 4 Adjust the magnification with **W** (Wide angle)/**T** (Telephoto).

To cancel, touch **[RESET]**.

## Searching for desired images by date (Date Index)

You can search for desired images by date efficiently.

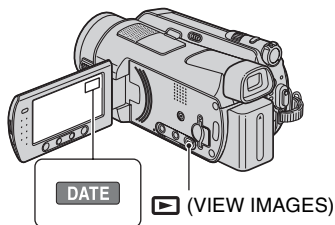

- 1 Slide the POWER switch to turn on the camcorder, and press (VIEW IMAGES).

The VISUAL INDEX screen appears on the LCD screen.

- 2 To search for movies, touch the or tab. To search for still images, touch the .

- 3 Touch [DATE].

The recording dates of images are displayed on the screen.

Return to the VISUAL INDEX screen

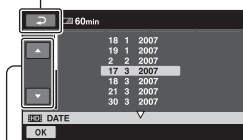

Previous/Next Date

- 4 Touch / to select the date of the desired image.
- 5 Touch while the selected date of the desired image is highlighted. The images of the selected date are displayed on the VISUAL INDEX screen.

#### Tips

- On the /[] screen, you can use the Date Index function by following the steps ③ to ⑤.

## Playing back a series of still images (Slide show)

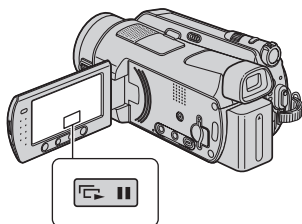

Touch on the still image playback screen.

The slide show begins from the selected image.

Touch to stop the slide show. To restart, touch again.

#### Notes

- You cannot operate playback zoom during slide show.

#### Tips

- You can also play back the slide show by touching → → [SLIDE SHOW] on the VISUAL INDEX screen.
- You can set continuous slide show playback by selecting → → [SLIDE SHOW SET]. The default setting is [ON] (continuous playback).

# Playing the image on a TV

Connection methods and quality of the image (HD (high definition)/SD (standard definition)) viewed on the TV screen differ depending on what type of TV is connected, and the connectors used.

Use the supplied AC Adaptor as the power source (p. 16).

Refer also to the instruction manuals supplied with the device to be connected.

## Notes

- When recording, set [X.V.COLOR] to [ON] to play back on an x.v.Color-compliant TV (p. 65). Some settings may need to be adjusted on the TV when playing back. Refer to the instruction manual of your TV for details.

## Operation flow

You can connect your camcorder to the TV easily following the instructions displayed on the LCD screen, [TV CONNECT Guide].

### Switch the input on the TV to the connected jack.

Refer to the instruction manuals of the TV.

↓  
Connect your camcorder and TV referring to [TV CONNECT Guide].

↓  
Make the required output settings on your camcorder (page 41).

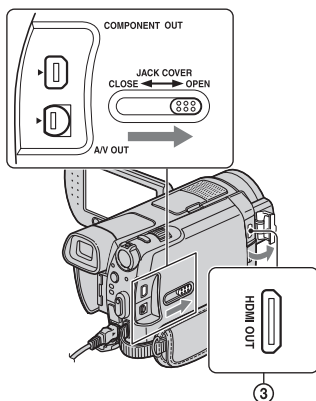
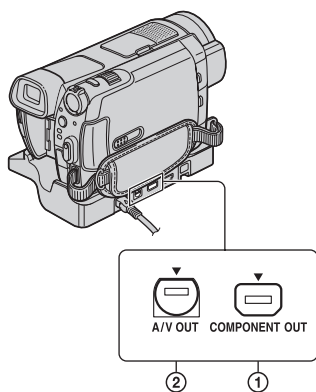

## Notes

- The Handycam Station and your camcorder are both equipped with A/V OUT jacks and COMPONENT OUT jacks (p. 107, 110). Connect the A/V connecting cable or component video cable either to the Handycam Station or to your camcorder. If you connect A/V connecting cables or component video cables to both the Handycam Station and your camcorder at the same time, image disturbance may occur.

## Selecting the most advantageous connection - TV CONNECT Guide

Your camcorder will advise you of the most advantageous way of connecting your TV.

---

**1** Turn on your camcorder, and press **↑** (HOME).

---

**2** Touch **☰** (OTHERS).

---

**3** Touch [TV CONNECT Guide].

If the item is not on the screen, touch **▲**/**▼** to change the page.

---

**4** Touch the answer to the question displayed on the screen.

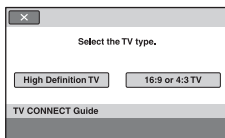

Meanwhile, you can make the relevant connection between your camcorder and the TV.

---



## Connecting to a high definition TV

Images recorded with HD (high definition) image quality are played back with HD (high definition) image quality. Images recorded with SD (standard definition) image quality are played back with SD (standard definition) image quality.

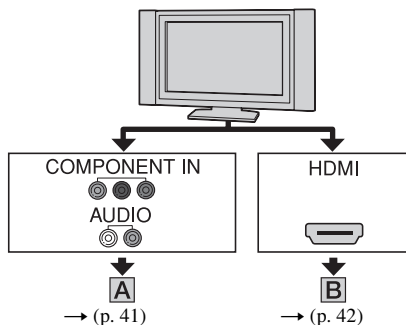

↗: Signal flow

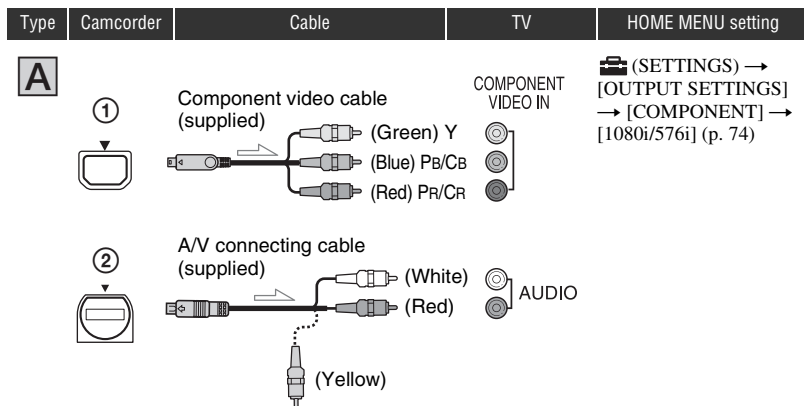

### Notes

- An A/V connecting cable is also needed to output audio signals. Connect the white and red plugs of the A/V connecting cable to the audio input jack of your TV.

Type	Camcorder	Cable	TV	HOME MENU setting
------	-----------	-------	----	-------------------

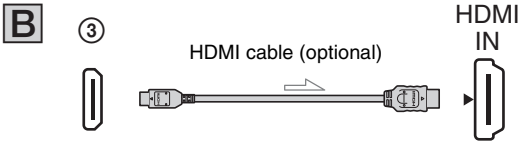

### Notes

- Use an HDMI cable with the HDMI logo.
- Use an HDMI mini connector on one end (for the camcorder), and a connector suitable for connection to your TV on the other end.
- Images are not output from the HDMI OUT jack, if copyright protection signals are recorded in the images.
- Some TVs may not function correctly (e.g., no sound or image) with this connection.
- Do not connect the HDMI OUT jack of your camcorder and HDMI OUT jack of the external device with the HDMI cable. This may cause a malfunction.

## Connecting to a non-high-definition 16:9 (wide) or 4:3 TV

Images recorded with HD (high definition) quality are converted to SD (standard definition) and played back. Images recorded with SD (standard definition) image quality are played back with SD (standard definition) image quality.

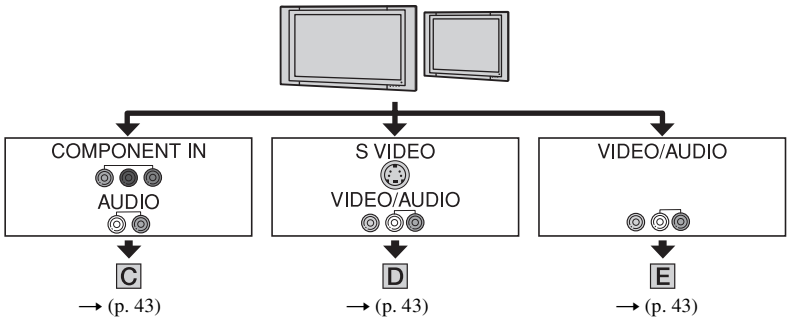

### To set the aspect ratio according to the connected TV (16:9/4:3)

Set [TV TYPE] to [16:9] or [4:3] according to your TV (p. 73).

### Notes

- When you play back a movie recorded with SD (standard definition) image quality on a 4:3 TV that is not compatible with the 16:9 signal, touch **HOME** → **SETTINGS** → [MOVIE SETTINGS] → [WIDE SELECT] → [4:3] on your camcorder when recording an image (p. 65).

Type	Camcorder	Cable	TV	HOME MENU setting
------	-----------	-------	----	-------------------

**C**

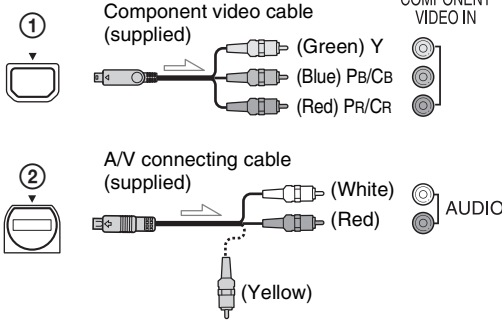

🗑️ (SETTINGS) → [OUTPUT SETTINGS] → [COMPONENT] → [576i] (p. 74)

🗑️ (SETTINGS) → [OUTPUT SETTINGS] → [TV TYPE] → [16:9]/[4:3] (p. 73)

**Notes**

- An A/V connecting cable is also needed to output audio signals. Connect the white and red plugs of the A/V connecting cable to the audio input jack of your TV.

**D**

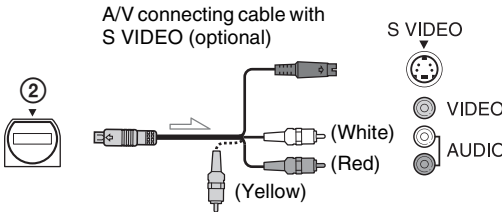

🗑️ (SETTINGS) → [OUTPUT SETTINGS] → [TV TYPE] → [16:9]/[4:3] (p. 73)

**Notes**

- When the S VIDEO plug (S VIDEO channel) is connected, audio signals are not output. To output audio signals, connect the white and red plugs of an A/V connecting cable with the S VIDEO cable to the audio input jack of your TV.
- This connection produces higher resolution images compared with the A/V connecting cable (Type **E**).

**E**

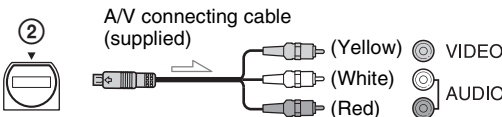

🗑️ (SETTINGS) → [OUTPUT SETTINGS] → [TV TYPE] → [16:9]/[4:3] (p. 73)

## When connecting to your TV via a VCR

Connect your camcorder to the LINE IN input on the VCR using the A/V connecting cable. Set the input selector on the VCR to LINE (VIDEO 1, VIDEO 2, etc.).

## When your TV is monaural (When your TV has only one audio input jack)

Connect the yellow plug of the A/V connecting cable to the video input jack and connect the white (left channel) or red (right channel) plug to the audio input jack of your TV or VCR.

## If your TV/VCR has a 21-pin adaptor (EUROCONNECTOR)

Use the 21-pin adaptor supplied with your camcorder (For models with the **CE** mark printed on their bottom surfaces only). This adaptor is designed for output use only.

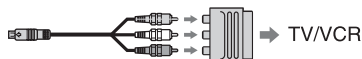

### 🔊 Notes

- When the A/V connecting cable is used to output images, images are output with SD (standard definition) image quality.

### 💡 Tips

- If you connect your camcorder to your TV using more than one type of cable to output images, the order of priority of the output signal is as follows:  
HDMI → component video → S VIDEO → audio/video.
- HDMI (High Definition Multimedia Interface) is an interface to send both video/audio signals. The HDMI OUT jack outputs high quality images and digital audio. You can switch to the appropriate image quality automatically if you connect to a Sony TV with Video-A mode. Refer to the instruction manual of your TV for details.

# Saving images

Recorded images are stored on the internal hard disk of your camcorder. Due to the limited capacity of the internal hard disk, make sure that you save the image data to some type of external media such as a DVD-R or a computer.

You can save the images recorded on the camcorder as described below.

## Saving images using a computer

By using “Picture Motion Browser” on the supplied CD-ROM, you can save the images recorded on your camcorder.

You can rewrite movies with HD (high definition) image quality from the computer to your camcorder, if necessary.

### Creating a disc with One Touch (One Touch Disc Burn)

You can save images recorded on the camcorder directly to a disc with ease.

### Saving images on a computer (Easy PC Back-up)

You can save images recorded on the camcorder on the hard disk of a computer.



### Creating a disc with selected images

You can save images copied to your computer on a disc. You can also edit those images.

Images can be saved in HD (high definition) image quality or SD (standard definition) image quality. See “Picture Motion Browser Guide” stored on the supplied CD-ROM.

## Saving images by connecting your camcorder to other devices

### Dubbing to VCR or DVD/HDD devices



When connecting with an A/V connecting cable, images can be saved in SD (standard definition) image quality. See “Dubbing to VCR or DVD/HDD recorders” (p. 53).

## (OTHERS) category

This category enables you to edit the images, to print still images and to connect your camcorder to a computer.



 (OTHERS) category

### Item list

#### DELETE

You can delete images on the hard disk or a “Memory Stick Duo” (p. 46).

#### EDIT

You can edit the images on the hard disk or a “Memory Stick Duo” (p. 46).

#### PLAYLIST EDIT

You can create and edit a Playlist (p. 50).

#### PRINT

You can print still images on a connected PictBridge printer (p. 54).

#### COMPUTER

You can connect your camcorder to a computer.  
See “Operating Guide” for connecting to the computer.

#### TV CONNECT Guide

Your camcorder helps you select the appropriate connection for your device (p. 39).



## Deleting images

You can delete images recorded on the hard disk or a “Memory Stick Duo” using your camcorder.

### Notes

- You cannot restore images once they are deleted.

### Tips

- You can select up to 100 images at one time.
- You can delete an image on the playback screen by selecting  (OPTION) →  tab → [DELETE].

### Deleting the images on the hard disk

You can free hard disk space by deleting image data from the camcorder.  
You can check the free hard disk space of the camcorder using [INFO] (p. 58).

### Notes

- Important data should be saved on external media (p. 45).
- Do not try to delete the files on the hard disk of the camcorder using a computer.



---

**1** Touch  (HOME) →  (OTHERS) → [DELETE].

---

**2** Touch [DELETE].

---

**3** Touch [ DELETED] or [ DELETED] to delete movies, or [ DELETED] to delete still images.

## 4 Touch the image to be deleted.



The selected image is marked with ✓. Press and hold the image on the LCD screen to confirm the image. Touch [↶] to return to the previous screen.

## 5 Touch [OK] → [YES] → [OK].

### To delete all images of the same type (on each tab) at one time

In step 3, touch [HDD] DELETE ALL/ [SSD] DELETE ALL/[MEM] DELETE ALL] → [YES] → [YES] → [OK].

### To delete all the movies or the still images recorded on the same day at one time

- 1 Touch [HOME] → [OTHERS] → [DELETE] → [DELETE].
- 2 Touch the type of image you want to delete ([HDD] DELETE by date/ [SSD] DELETE by date/[MEM] DELETE by date)].

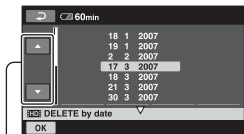

Previous/Next Date

- 3 Touch ▲/▼ to select the recording date of the desired image.

- 4 Touch [OK] while the selected recording date is highlighted.

The images recorded on the selected date are displayed on the screen.

Touch the image on the LCD screen to confirm the image. Touch [↶] to return to the previous screen.

- 5 Touch [OK] → [YES] → [OK].

### Notes

- Do not remove the battery pack or the AC Adaptor from your camcorder while deleting the images. It may damage the hard disk.
- If the deleted movie is included in the Playlist (p. 50), the movie is deleted also from the Playlist.

### Tips

- To delete all images recorded in the hard disk, and recover all the recordable space of the hard disk, format the hard disk (p. 57).

### Deleting the still images in the “Memory Stick Duo”

To delete images on a “Memory Stick Duo,” insert it in your camcorder before the operation.

- 1 Touch [HOME] → [OTHERS] → [DELETE].

- 2 Touch [DELETE].

- 3 Touch [DELETE].

# Dividing a movie

## 4 Touch the still image to be deleted.

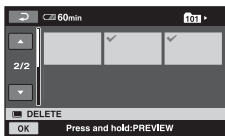

The selected still image is marked with ✓.

Press and hold the still image on the LCD screen to confirm the still image.

Touch to return to the previous screen.

## 5 Touch → [YES] → .

### To delete all still images on the “Memory Stick Duo”

In step 3, touch → [YES] → [YES] → .

#### Notes

- You cannot delete still images in the following cases:
  - “Memory Stick Duo” is write-protected (p. 99).
  - write-protection is set to the still images by another device.

#### Tips

- To delete all images recorded on the “Memory Stick Duo,” format the “Memory Stick Duo” (p. 58).

You can divide movies on the hard disk of your camcorder.

#### Notes

- During Easy Handycam operation, you cannot divide movies. Cancel Easy Handycam operation (p. 26).

## 1 Touch (HOME) → (OTHERS) → [EDIT].

## 2 Touch [DIVIDE] → [DIVIDE]/ [DIVIDE].

## 3 Touch the movie to be divided.

The selected movie starts playback.

## 4 Touch at the point where you want to divide the movie into scenes.

The movie pauses.

Adjusts the dividing point with more precision after the dividing point has been selected with .

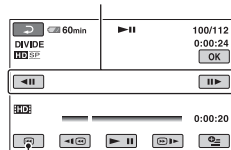

Returns to the beginning of the selected movie.

Play and pause toggles as you press



## 5 Touch → [YES] → .





# Copying still images

## Notes



- You cannot restore movies once they are divided.
- Do not remove the battery pack or the AC Adaptor from your camcorder while dividing the movie. It may damage the hard disk.
- If the divided original movie is included in the Playlist, the movie in the Playlist will also be divided.
- A slight difference may occur from the point where you touch  and the actual dividing point, as your camcorder selects the dividing point based on about half-second increments.
- The movies added to the Playlist may not be divided, if the number of movies in the Playlist exceeds the maximum. In this case, delete the movies from the Playlist, then divide them.

You can copy still images from the hard disk to a “Memory Stick Duo.” Insert a “Memory Stick Duo” in your camcorder before the operation.



## Tips

- You can select up to 100 still images at one time.
- You can copy a still image on the still image playback screen by touching  (OPTION) →  tab → [COPY → ].

---

**1** Touch  (HOME) →  (OTHERS) → [EDIT] → [COPY].

---

**2** Touch [ →  COPY].

---

**3** Touch the still image to be copied.

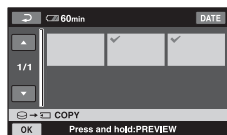

The selected still image is marked with ✓.

Press and hold the image on the LCD screen to confirm the image.

Touch  to return to the previous screen.

---

**4** Touch  → [YES].

Copying starts.

---

**5** When [Completed.] appears, touch .

---

# Creating the Playlist

## To copy all the still images recorded on the same day at one time

- 1 Touch **HOME** → **(OTHERS)** → **[EDIT]** → **[COPY]**.
- 2 Touch **[COPY by date]**.  
The recording dates of still images are displayed on the screen.

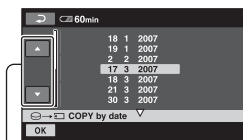

Previous/Next Date

- 3 Touch **▲/▼** to select the recording date of the desired still image.
- 4 Touch **[OK]** while the selected recording date is highlighted.  
The still images recorded on the selected date are displayed on the screen.  
Touch the image on the LCD screen to confirm the still image. Touch **[RETURN]** to return to the previous screen.
- 5 Touch **[OK]** → **[YES]** → **[OK]**.

### Notes

- Use the AC Adaptor as the power source to prevent your camcorder from running out of power during copying.
- Do not apply shock or vibration to your camcorder, and do not disconnect the AC Adaptor during copying.
- It may take awhile when there are many still images to be copied.
- You cannot copy still images on a "Memory Stick Duo" to the hard disk.

### Tips

- You can also copy all the still images recorded on the same day at one time on the VISUAL INDEX screen by touching **(OPTION)** → **[OPTION]** tab → **[COPY by date]**.

A Playlist is a list showing thumbnails of the movies that you have selected. The original scenes are not changed even if you edit or delete the scenes in the Playlist.

### Notes

- During Easy Handycam operation, you cannot add movies to the Playlist or edit the Playlist. Cancel Easy Handycam operation.
- Images with HD (high definition) image quality and SD (standard definition) image quality are added to an individual Playlist.

### Tips

- The images recorded by this camcorder and stored onto the hard disk are called "original."

- 
- 1 Touch **HOME** → **(OTHERS)** → **[PLAYLIST EDIT]**.

- 
- 2 Touch **[HD] ADD** or **[SD] ADD**.

- 
- 3 Touch the image to be added to the Playlist.

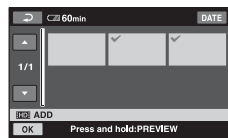

The selected image is marked with ✓. Press and hold the image on the LCD screen to confirm the image. Touch **[RETURN]** to return to the previous screen.

- 
- 4 Touch **[OK]** → **[YES]** → **[OK]**.
-

## To add all the movies recorded on the same day at one time

- 1 Touch **HOME** → **(OTHERS)** → **[PLAYLIST EDIT]**.
- 2 Touch **[HD] ADD by date** or **[SD] ADD by date**.  
The recording dates of movies are displayed on the screen.

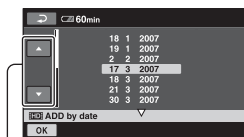

Previous/Next Date

- 3 Touch **▲/▼** to select the recording date of the desired movie.
- 4 Touch **[OK]** while the selected recording date is highlighted.  
The movies recorded on the selected date are displayed on the screen.  
Touch the image on the LCD screen to confirm the movie. Touch **[↶]** to return to the previous screen.
- 5 Touch **[OK]** → **[YES]** → **[OK]**.

### Notes

- Do not remove the battery pack or the AC Adaptor from your camcorder while editing the Playlist. It may damage the hard disk.
- You cannot add still images to a Playlist.

### Tips

- You can add a maximum of 999 scenes with HD (high definition) image quality, or 99 movies with SD (standard definition) image quality to the Playlist.
- You can add a movie on the playback screen by touching **[OPTION]** → **[tab]** → **[HD] ADD**/[SD] ADD/[HD] ADD by date/[SD] ADD by date.
- You can copy the Playlist to a disc as it is, by using the supplied software.

## Playing the Playlist

- 1 Touch **HOME** → **(VIEW IMAGES)** → **[PLAYLIST]**.

The Playlist screen appears.

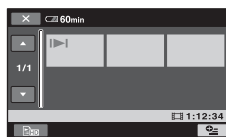

- 2 Touch the image from which you want to playback.

The Playlist is played back from the selected image to the end, then the screen returns to the Playlist screen.

### Tips

- You can change the image quality of a movie you want to play back by touching **[OPTION]** → **[tab]** → **[HD/SD] INDEX SET**.

## To erase unnecessary images from the Playlist

- 1 Touch **HOME** → **(OTHERS)** → **[PLAYLIST EDIT]**.
- 2 Touch **[HD] ERASE** or **[SD] ERASE**.  
To erase all the images from the Playlist, touch **[HD] ERASE ALL**/[SD] ERASE ALL → **[YES]** → **[YES]** → **[OK]**.

- ③ Select the scene to be deleted from the list.



The selected scene is marked with ✓. Press and hold the image on the LCD screen to confirm the image.

Touch to return to the previous screen.

- ④ Touch → [YES] → .

#### Tips

- The original scenes are not changed even if you erase the scenes from the Playlist.

### To change the order within the Playlist

- ① Touch (HOME) → (OTHERS) → [PLAYLIST EDIT].
- ② Touch [ MOVE] or [ MOVE].
- ③ Select the image to be moved.



The selected scene is marked with ✓. Press and hold the image on the LCD screen to confirm the image.

Touch to return to the previous screen.

- ④ Touch .

- ⑤ Select the destination with / .

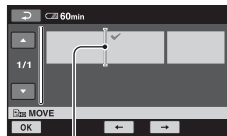

Destination bar

- ⑥ Touch → [YES] → .

#### Tips

- When you select multiple images, the images are moved following the order appearing in the Playlist.

# Dubbing to VCR or DVD/HDD recorders

You can dub images played back on your camcorder to other recording devices, such as VCRs or DVD/HDD recorders. Connect the device in either of the following ways.

Connect your camcorder to the wall socket using the supplied AC Adaptor for this operation (p. 16). Refer also to the instruction manuals supplied with the devices to be connected.

## Notes

- **Movies recorded with HD (high definition) image quality will be dubbed with SD (standard definition) image quality.**
- To copy a movie recorded with HD (high definition) image quality, install the application software (supplied) on your computer, and copy the images to a disc in the computer.
- Since dubbing is performed via analog data transfer, the image quality may deteriorate.

### A/V OUT jack

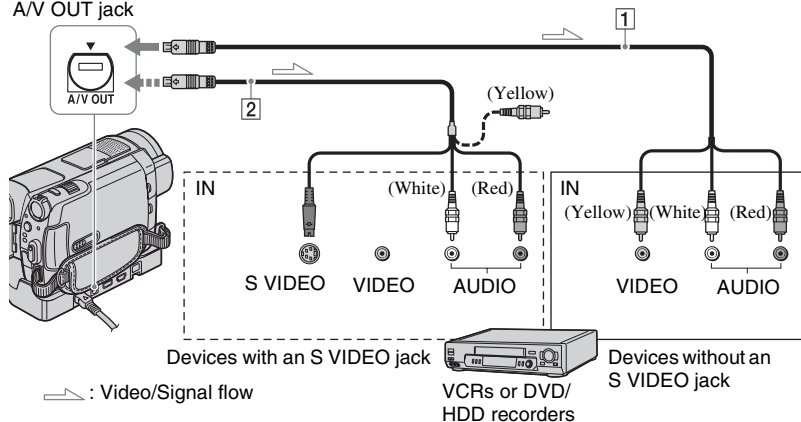

### 1 A/V connecting cable (supplied)

The Handycam Station and your camcorder are both equipped with A/V OUT jacks (p. 107, 110). Connect the A/V connecting cable either to the Handycam Station or to your camcorder, depending on your setup.

### 2 A/V connecting cable with S VIDEO (optional)

When connecting to another device via the S VIDEO jack, by using an A/V connecting cable with an S VIDEO cable (optional), higher quality images can be produced than with an A/V connecting cable. Connect the white and red plug (left/right audio) and the S VIDEO plug (S VIDEO channel) of the A/V connecting cable with an S VIDEO

cable (optional). The yellow plug connection is not necessary. S VIDEO connection only will not output audio.

## Notes

- You cannot dub to recorders connected with an HDMI cable.
- To hide the screen indicators (such as a counter, etc.) on the screen of the monitor device connected, touch (HOME) → (SETTINGS) → [OUTPUT SETTINGS] → [DISP OUTPUT] → [LCD PANEL] (the default setting) on the HOME MENU (p. 74).
- To record the date/time and camera settings data, display them on the screen (p. 70).
- When you are connecting your camcorder to a monaural device, connect the yellow plug of the A/V connecting cable to the video input jack, and the red (right channel) or the white (left

channel) plug to the audio input jack on the device.

---

**1 Turn on your camcorder, and press  (VIEW IMAGES).**



Set [TV TYPE] according to the display device (p. 73).

---

**2 Insert the recording media in the recording device.**

If your recording device has an input selector, set it to the input mode.

---

**3 Connect your camcorder to the recording device (VCR or DVD/HDD recorder) with the A/V connecting cable (supplied)  or an A/V connecting cable with S VIDEO (optional) .**

Connect your camcorder to the input jacks of the recording device.

---

**4 Start the playback on your camcorder, and record it on the recording device.**

Refer to the instruction manuals supplied with your recording device for details.

---

**5 When dubbing is finished, stop the recording device, and then your camcorder.**

---

## Printing recorded images (PictBridge compliant printer)

You can print out still images using a PictBridge compliant printer, without connecting the camcorder to a computer.

### PictBridge

Connect your camcorder to the AC Adaptor to obtain power from the wall socket (p. 16). Turn on the printer.

To print still images on a “Memory Stick Duo,” insert the “Memory Stick Duo” containing them into your camcorder.

---

**1 Connect the Handycam Station to the wall socket using the supplied AC Adaptor.**

---

**2 Set the camcorder onto the Handycam Station securely, then turn on your camcorder.**

---

**3 Connect the  (USB) jack of the Handycam Station to the printer using the USB cable (p. 110).**

[USB SELECT] appears on the screen automatically.

#### 4 Touch [PRINT] (hard disk) or [PRINT] (“Memory Stick Duo”) depending on the media of the image to be printed.

When connection is complete,  (PictBridge connecting) appears on the screen.

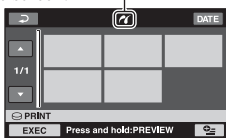

You can select a still image on the screen.

#### 5 Touch the still image to be printed.

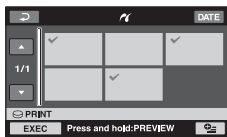

The selected image is marked with .

Press and hold the image on the LCD screen to confirm the image.

Touch  to return to the previous screen.

#### 6 Touch , set the following options, then touch .

[COPIES]: Set number of copies of a still image to be printed. You can set up to 20 copies.

[DATE/TIME]: Select [DATE], [DAY&TIME], or [OFF] (no date/time printed).

[SIZE]: Select the paper size.

If you do not change the setting, go to step 7.



#### 7 Touch [EXEC] → [YES] → .

The image selection screen appears again.

### To finish printing

Touch  on the image selection screen.



#### Notes

- We can guarantee the operation of only models that are PictBridge compatible.
- Refer also to the instruction manual of the printer to be used.
- Do not attempt the following operations when  is on the screen. The operations may not be performed properly.
  - Operate the POWER switch.
  - Press  (VIEW IMAGES).
  - Remove your camcorder from the Handycam Station.
  - Disconnect the USB cable from the Handycam Station or the printer.
  - Remove the “Memory Stick Duo” from your camcorder, in the case of [ PRINT].
- If the printer stops working, disconnect the USB cable, turn the printer off and on again, and restart the operation from the beginning.
- You can select only the paper sizes that the printer can print.
- On some printer models, the top, bottom, right, and left edges of images may be trimmed. If you print a still image recorded in a 16:9 (wide)

ratio, the left and right ends of the image may be trimmed widely.

- Some printer models may not support the date printing function. Refer to your printer's instruction manual for details.
- The images described below may not be printed out:
  - The image edited by a computer
  - The image recorded by other devices
  - The image file exceeding 3 MB
  - The image file larger than 2,848 × 2,136 pixels

### **Tips**

- PictBridge is an industry standard established by the Camera & Imaging Products Association (CIPA). You can print still images without using a computer by connecting a printer directly to a digital video camera or digital still camera, regardless of model or manufacturer.
- You can print a still image on the still image playback screen by touching  (OPTION) →  tab → [PRINT].



## (MANAGE HDD/MEMORY) category

This category enables you to use the hard disk or a “Memory Stick Duo” for various purposes.

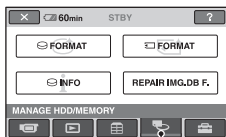

 (MANAGE HDD/MEMORY) category

### Item list

#### **FORMAT**

You can format the hard disk and recover recordable free space (p. 57).

#### **FORMAT**

You can format the “Memory Stick Duo” and recover the recordable free space (p. 58).

#### **INFO**

You can display the hard disk capacity (p. 58).

#### **REPAIR IMG.DB F.**

You can repair the management information in the hard disk (p. 59).

## Formatting the hard disk or the “Memory Stick Duo”

### Formatting the hard disk

You can delete all the images on the hard disk of the camcorder to recover recordable free space.

Connect your camcorder to the wall socket using the supplied AC Adaptor for this operation (p. 16).

#### **Notes**

- To avoid the loss of important images, you should save them (p. 45) before performing [ **FORMAT**].

### 1 Turn on your camcorder.

### 2 Touch (HOME) → (MANAGE HDD/MEMORY) → [ **FORMAT**].

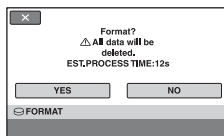

### 3 Touch [YES] → [YES].

### 4 When [Completed.] appears, touch .

#### **Notes**

- While [ **FORMAT**] is activated, do not disconnect the AC Adaptor.

## Formatting the “Memory Stick Duo”

Formatting deletes all images on a “Memory Stick Duo.”

**1** Turn on your camcorder.

**2** Insert the “Memory Stick Duo” to be formatted into your camcorder.

**3** Touch **HOME** → **(MANAGE HDD/MEMORY)** → **[FORMAT]**.

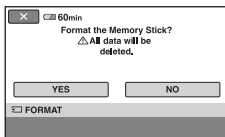

**4** Touch **[YES]** → **[YES]**.

**5** When **[Completed.]** appears, touch **[OK]**.

### Notes

- Even the still images protected with another device against accidental deletion are also deleted.
- Do not attempt the following operations when [Executing...] is on the screen:
  - Operate the POWER switch or buttons
  - Remove the “Memory Stick Duo”

## Checking the hard disk information

You can display the hard disk information, and check the approximate amount of free hard disk space.

Touch **HOME** → **(MANAGE HDD/MEMORY)** → **[INFO]**.

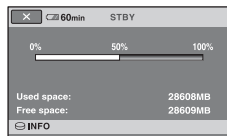

### To turn off the display

Touch **[X]**.

### Notes

- The calculation for hard disk space is 1MB = 1,048,576 bytes. The fractions less than MB are discarded when the hard disk space is displayed. The displayed size of the whole hard disk space will be slightly smaller than the size shown below despite displaying both free and used hard disk space.
  - HDR-SR5E: 40,000 MB
  - HDR-SR7E: 60,000 MB
  - HDR-SR8E: 100,000 MB
- Since there is a management file area, the used space is not displayed as 0 MB even if you perform **[FORMAT]** (p. 57).

# Repairing the image database file

This function checks the management information and the consistency of movies and still images in the hard disk, and repairs any inconsistencies found.

- Do not disconnect the AC Adaptor or remove the battery pack during this operation.

---

## 1 Turn on your camcorder.

---

## 2 Touch (HOME) → (MANAGE HDD/MEMORY) → [REPAIR IMG.DB F.].

The [REPAIR IMG.DB F.] screen appears.

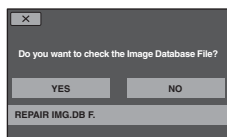

---

## 3 Touch [YES].

The management file check starts.  
Touch  and quit the management file check if no inconsistency is found.

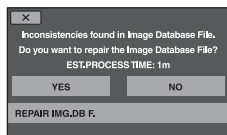

---

## 4 Touch [YES].

---



## 5 After [Completed.] appears, touch .

---





### Notes

- Do not apply mechanical shock or vibration to the camcorder during this operation.

# Preventing data on the hard disk of the camcorder from being recovered

[ EMPTY] allows you to write unintelligible data onto the hard disk of the camcorder. In this way, it may become more difficult to recover any original data. When you dispose of or transfer the camcorder to others, it is recommended that you perform [ EMPTY]. Connect your camcorder to the wall socket using the supplied AC Adaptor for this operation (p. 16).



## Notes

- If you perform [ EMPTY], all the images are deleted. To avoid the loss of important images, they should be saved (p. 45) before performing [ EMPTY].
- You cannot perform [ EMPTY] unless you connect the AC Adaptor to the wall socket.
- Disconnect all cables except the AC Adaptor. Do not disconnect the AC Adaptor during the operation.
- While performing [ EMPTY], do not apply any vibrations or shocks to your camcorder.

---

**1** Make sure the AC Adaptor is connected, then slide the POWER switch to turn on.

---

**2** Touch  (HOME) →  (MANAGE HDD/MEMORY) → [ FORMAT].

The [ FORMAT] screen appears.

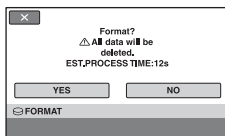

---

**3** Press and hold the BACK LIGHT button for a few seconds (p. 110).

The [ EMPTY] screen appears.

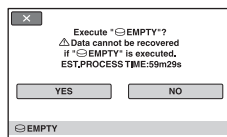

---





**4** Touch [YES] → [YES].

---

**5** When [Completed.] appears, touch [OK].

---

## Notes

- The actual performing time for [ EMPTY] is as follows;
  - HDR-SR5E: approx. 40 minutes
  - HDR-SR7E: approx. 60 minutes
  - HDR-SR8E: approx. 100 minutes
- If you stop performing [ EMPTY] while [Executing...] appears, be sure to complete the operation by performing [ FORMAT] or [ EMPTY] when you use the camcorder next time.

# What you can do with the (SETTINGS) category of the HOME MENU

You can change the recording functions and the operating settings for your convenience.

## Using the HOME MENU

- 1 Turn on your camcorder, then press  (HOME).

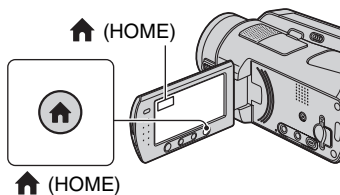

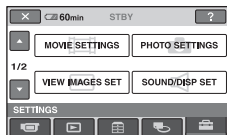

 (SETTINGS) category

- 2 Touch  (SETTINGS).



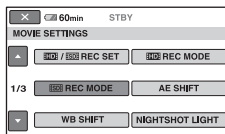

- 3 Touch the desired setup item.

If the item is not on the screen, touch  /  to change the page.



- 4 Touch the desired item.

If the item is not on the screen, touch  /  to change the page.

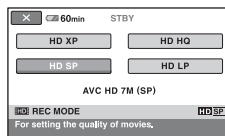

- 5 Change the setting, then touch .

## List of the (SETTINGS) category items

### MOVIE SETTINGS (p. 63)

Items	Page
REC SET* <sup>1</sup>	63
REC MODE	63
REC MODE	64
AE SHIFT* <sup>3</sup>	64
WB SHIFT* <sup>3</sup>	64
NIGHTSHOT LIGHT	64
WIDE SELECT	65
DIGITAL ZOOM	65
STEADYSHOT	65
AUTO SLW SHUTTR	65
X.V.COLOR	65
GUIDEFAME	65
ZEBRA	66
REMAINING	66
FLASH LEVEL	66
REDEYE REDUC	66
DIAL SETTING* <sup>3</sup>	67
INDEX SET* <sup>1</sup>	67

### PHOTO SETTINGS (p. 67)

Items	Page
IMAGE SIZE* <sup>1</sup>	67
QUALITY	68
FILE NO.	69
AE SHIFT* <sup>3</sup>	64
WB SHIFT* <sup>3</sup>	64
NIGHTSHOT LIGHT	64
STEADYSHOT* <sup>3</sup>	65
GUIDEFAME	65
ZEBRA	66
FLASH LEVEL	66

Items	Page
REDEYE REDUC	66
DIAL SETTING* <sup>3</sup>	67
STILL MEDIA* <sup>1</sup>	31

### VIEW IMAGES SET (p. 70)

Items	Page
INDEX SET* <sup>1</sup>	70
DATA CODE	70
DISPLAY	71
INTERVAL SET* <sup>1</sup>	71

### SOUND/DISP SET\*<sup>2</sup> (p. 72)

Items	Page
VOLUME* <sup>1</sup>	72
BEEP* <sup>1</sup>	72
LCD BRIGHT	72
LCD BL LEVEL	72
LCD COLOR	72
VF B.LIGHT* <sup>3</sup>	72

### OUTPUT SETTINGS (p. 73)

Items	Page
TV TYPE	73
DISP OUTPUT	74
COMPONENT	74

### CLOCK/ LANG (p. 74)

Items	Page
CLOCK SET* <sup>1</sup>	20
AREA SET	74
SUMMERTIME	74
LANGUAGE SET* <sup>1</sup>	74

# MOVIE SETTINGS

(Items for recording movies)

## GENERAL SET (p. 75)

Items	Page
<b>DEMO MODE</b>	75
<b>REC LAMP</b>	75
<b>CALIBRATION</b>	103
<b>A.SHUT OFF</b>	75
<b>REMOTE CTRL</b>	75
<b>DROP SENSOR</b>	75

\*1 You can set these items also during Easy Handycam operation (p. 23).

\*2 The menu name is changed to [SOUND SETTINGS] during Easy Handycam operation.

\*3 HDR-SR7E/SR8E



Touch ①, then ②.

If the item is not on the screen, touch ▲/▼ to change the page.

## How to set

🏠 (HOME MENU) → page 61

⊕ (OPTION MENU) → page 76

The default settings are marked with ▶.



You can select a recording quality to record a movie.

### ▶ HD QUALITY

Records with HD (high definition) image quality.

### SD QUALITY

Records with SD (standard definition) image quality.



You can select a recording mode to record a movie with HD (high definition) image quality from 4 levels.

### HD XP

Records in the highest quality mode (AVC HD 15M (XP)).

### HD HQ

Records in high quality mode (AVC HD 9M (HQ)).

### ▶ HD SP

Records in standard quality mode (AVC HD 7M (SP)).

## HD LP

Increases the recording time (Long Play) (AVC HD 5M (LP)).

### 🔊 Notes

- If you record in the LP mode, details in movies with quick movements may appear rough when you play the image back.

### 💡 Tips

- See page 11 for the expected recording time of each recording mode.

## SD REC MODE



You can select a recording mode to record a movie with SD (standard definition) image quality from 3 levels.

### SD HQ

Records in high quality mode (SD 9M (HQ)).

### ▶ SD SP

Records in standard quality mode (SD 6M (SP)).

### SD LP

Increases the recording time (Long Play) (SD 3M (LP)).

### 🔊 Notes

- If you record in the LP mode, the quality of movies may be degraded, or scenes with quick movements may appear with a block noise when you play back the image.

### 💡 Tips

- See page 11 for the expected recording time of each recording mode.

## AE SHIFT (HDR-SR7E/SR8E)



Select [ON] to adjust the exposure using (dark)/ (bright). **AS** and the setting value appear on the screen (The default setting is [OFF]).

### 💡 Tips

- Touch if the subject is white or the backlight is bright, or touch if the subject is black or the light is dim.
- You can adjust the automatic exposure level to brighter or darker when [EXPOSURE] is set to [AUTO].
- You can also adjust the setting manually using the CAM CTRL dial (p. 33).

## WB SHIFT (White Balance Shift) (HDR-SR7E/SR8E)



Select [ON] to adjust the white balance to the desired setting using /. **WS** and the setting value appear on the screen (The default setting is [OFF]).

### 💡 Tips

- When the white balance is set to a lower value, images appear bluish, and when set to a higher value, images appear reddish.
- You can also adjust the setting manually using the CAM CTRL dial (p. 33).

## NIGHTSHOT LIGHT



When using either the NightShot (p. 31) or [SUPER NIGHTSHOT] (p. 82) function to record, you can record clearer images by setting [NIGHTSHOT LIGHT], which emits infrared light (invisible), to [ON] (the default setting).

### 🔊 Notes

- Do not cover the infrared port with your fingers or other objects (p. 31).
- Remove the conversion lens (optional).
- The maximum shooting distance using [NIGHTSHOT LIGHT] is about 3 m (10 feet).



## WIDE SELECT



When recording with SD (standard definition) image quality, you can select the aspect ratio according to the TV connected. Refer also to the instruction manuals supplied with your TV.

### ► 16:9 WIDE

Records images to the full screen on a 16:9 (wide) TV screen.

### 4:3 (4:3)

Records images to the full screen on a 4:3 TV screen.

### 🔊 Notes

- Set [TV TYPE] correctly according to the TV connected for playback (p. 73).

## DIGITAL ZOOM



You can select the maximum zoom level in case you want to zoom to a level greater than 10 × (the default setting) during recording. Note that the image quality decreases when you use the digital zoom.

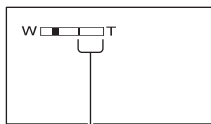

The right side of the bar shows the digital zooming factor. The zooming zone appears when you select the zooming level.

### ► OFF

Up to 10 × zoom is performed optically.

### 20 ×

Up to 10 × zoom is performed optically, and after that, up to 20 × zoom is performed digitally.

### 80 × (HDR-SR5E)

Up to 10 × zoom is performed optically, and after that, up to 80 × zoom is performed digitally.

## STEADYSHOT



You can compensate for camera shake (the default setting is [ON]). Set [STEADYSHOT] to [OFF] (🚫) when using a tripod (optional), then the image becomes natural.

## AUTO SLW SHUTTR (Auto Slow Shutter)



When recording in dark places, the shutter speed is automatically reduced to 1/25 second (The default setting is [ON]).

## X.V.COLOR



When recording, set to [ON] to capture wider range of colors. Various colors such as the brilliant color of flowers and turquoise blue of the sea can be more faithfully reproduced.

### 🔊 Notes

- Set [X.V.COLOR] to [ON] only when the recorded content will be played back on an x.v.Color-compliant TV. Otherwise, set to [OFF] (the default setting).
- If the movie recorded with this function [ON] is played back on a non-x.v.Color-compliant TV, the color may not be reproduced correctly.
- [X.V.COLOR] cannot be set to [ON]:
  - while recording with SD (standard definition) image quality
  - while recording a movie.

## GUIDEFAME



You can display the frame and check that the subject is horizontal or vertical by setting [GUIDEFAME] to [ON]. The frame is not recorded. Press DISP/BATT INFO to make the frame disappear (The default setting is [OFF]).

### 💡 Tips

- Positioning the subject at the cross point of the guide frame makes a balanced composition.

## ZEBRA



Diagonal stripes appear in portions of the screen where brightness is at a preset level. This is useful as a guide when adjusting the brightness. When you change the default setting,  is displayed. The zebra pattern is not recorded.

### ► OFF

The zebra pattern is not displayed.

### 70

The zebra pattern appears at a screen brightness level of about 70 IRE.

### 100

The zebra pattern appears at a screen brightness level of about 100 IRE or higher.

### 🔔 Notes

- Portions of the screen where brightness is about 100 IRE or above may appear overexposed.

### 💡 Tips



- IRE represents the screen brightness.

## REMAINING



### ► AUTO

Displays the remaining recording time of movies for about 8 seconds in situations such as those described below.

- When your camcorder recognizes the remaining hard disk capacity with the POWER switch set to  (Movie).
- When you press DISP/BATT INFO to switch the indicator from off to on with the POWER switch set to  (Movie).
- When you select the movie recording mode on the HOME MENU.

### ON

Always displays the remaining hard disk indicator.

### 🔔 Notes

- When the remaining recordable time for movies is less than 5 minutes, the indicator stays on the screen.

## FLASH LEVEL



You can set this function when you use the built-in flash, or an external flash (optional) that is compatible with your camcorder.

### HIGH(⚡+)

Makes the flash level higher.

### ► NORMAL(⚡)

### LOW(⚡-)

Makes the flash level lower.

## REDEYE REDUC



You can set this function when you use the built-in flash, or an external flash (optional) that is compatible with your camcorder. You can prevent redeye by activating the flash before recording. Set [REDEYE REDUC] to [ON], then press  (flash) (p. 30) repeatedly to select a setting.

 (Auto redeye reduction): Pre-flashes to reduce redeye before the flash automatically flashes when there is insufficient ambient light.



 (Forced redeye reduction): Always uses the flash and the redeye reducing pre-flash.



 (No flash): Records without flash.

### 🔔 Notes

- The redeye reduction may not produce the desired effect due to individual differences and other conditions.

## DIAL SETTING (HDR-SR7E/SR8E)



You can select an item you want to set to the CAM CTRL dial. For details, see page 33.

## INDEX SET



The default setting is [ON], allowing you to search for faces during movie recording.

### Face icons and their meanings

: When the setting is [ON].

: When the first face is detected.

: When face detection is completed (The icon flashes).

: If faces cannot be detected.\*

\* If the number of detected faces is too numerous (approximately 100 faces maximum), face searching stops.

For playing back from Face Index, see page 37.

# PHOTO SETTINGS

(Items for recording still images)



Touch ①, then ②.

If the item is not on the screen, touch ▲/▼ to change the page.

### How to set

(HOME MENU) → page 61

(OPTION MENU) → page 76

The default settings are marked with ►.

## IMAGE SIZE



### For HDR-SR5E:

► **4.0M** (4.0M)

Records still images clearly.

**3.0M** (3.0M)

Records still images clearly in the 16:9 (wide) ratio.

**1.9M** (1.9M)

Allows you to record more still images in relatively clear quality.

**VGA (0.3M)** (VGA)

Allows the maximum number of still images to be recorded.

### For HDR-SR7E/SR8E:

► **6.1M** (6.1M)

Records still images clearly.

**4.6M** (4.6M)

Records still images clearly in the 16:9 (wide) ratio.

**3.1M** (3.1M)

Allows you to record more still images in relatively clear quality.

## VGA (0.3M) (VGA)

Allows the maximum number of still images to be recorded.

### Notes

- [IMAGE SIZE] can be set only during recording standby.

## QUALITY



### FINE (FINE)

Records still images at the fine image quality level.

### STANDARD (STD)

Records still images at the standard image quality level.

## Capacity of the “Memory Stick Duo” (MB) and the number of recordable images

### Notes

- All numbers measured at the following setting:  
Top: [FINE] is selected for image quality.  
Bottom: [STANDARD] is selected for image quality.

## When the POWER switch is

### (Still)

#### HDR-SR5E

	4.0M 2304 × 1728 4.0M	3.0M 2304 × 1296 3.0M	1.9M 1600 × 1200 1.9M	VGA (0.3M) 640 × 480 VGA
64MB	32 81	42 105	65 160	390 980
128MB	64 160	85 215	130 325	780 1970
256MB	115 295	150 395	235 590	1400 3550
512MB	235 600	310 800	480 1200	2850 7200
1GB	480 1200	640 1600	980 2450	5900 14500

	4.0M 2304 × 1728 4.0M	3.0M 2304 × 1296 3.0M	1.9M 1600 × 1200 1.9M	VGA (0.3M) 640 × 480 VGA
2GB	990 2500	1300 3350	2000 5000	12000 30000
4GB	1950 4900	2600 6600	3950 9500	23500 59000
8GB	3900 9500	5200 13000	8000 20000	48000 115000

#### HDR-SR7E/SR8E



	6.1M 2848 × 2136 6.1M	4.6M 2848 × 1602 4.6M	3.1M 2048 × 1536 3.1M	VGA (0.3M) 640 × 480 VGA
64MB	21 53	28 70	40 100	390 980
128MB	42 105	56 135	80 205	780 1970
256MB	76 190	100 250	140 370	1400 3550
512MB	155 390	205 510	295 760	2850 7200
1GB	315 800	420 1050	600 1550	5900 14500
2GB	650 1600	860 2150	1200 3150	12000 30000
4GB	1250 3200	1700 4250	2400 6300	23500 59000
8GB	2550 6400	3400 8500	4900 12500	48000 115000



## When the POWER switch is

### (Movie)\*



#### HDR-SR5E



	2.3M 2016 × 1134 2.3M	1.7M 1512 × 1134 1.7M
64MB	56 135	72 175



	2.3M 2016 × 1134 	1.7M 1512 × 1134 
128MB	110 280	145 355
256MB	200 500	260 640
512MB	410 1000	530 1300
1GB	840 2100	1050 2650
2GB	1700 4300	2200 5500
4GB	3400 8500	4400 10500
8GB	6800 17000	8900 21500

- \* The image size is fixed depending on the aspect ratio of the image recorded:
-  [2.3M] with HD (high definition) image quality
  -  [2.3M] in the aspect ratio 16:9 with SD (standard definition) image quality
  - [1.7M] in the aspect ratio 4:3 with SD (standard definition) image quality

### HDR-SR7E/SR8E

	4.6M 2848 × 1602 	3.4M 2136 × 1602 
64MB	28 70	37 93
128MB	56 135	74 185
256MB	100 250	130 335
512MB	205 510	270 690
1GB	420 1050	550 1400
2GB	860 2150	1100 2850
4GB	1700 4250	2250 5700

	4.6M 2848 × 1602 	3.4M 2136 × 1602 
8GB	3400 8500	4500 11000

- \* The image size is fixed depending on the aspect ratio of the image recorded:
-  [4.6M] with HD (high definition) image quality
  -  [4.6M] in the aspect ratio 16:9 with SD (standard definition) image quality
  - [3.4M] in the aspect ratio 4:3 with SD (standard definition) image quality

### Notes

- All numbers measured when using a “Memory Stick Duo” made by Sony Corporation. The number of still images and the length of time for movies may vary depending on the shooting conditions and the recording mediums.
- You can record up to 9,999 still images on the hard disk.
- The unique pixel array of Sony’s ClearVid CMOS sensor and image processing system (new Enhanced Imaging Processor) allows for still image resolution equivalent to the sizes described.

### FILE NO.



#### ► SERIES

Assigns file numbers in sequence even if the “Memory Stick Duo” is replaced with another one. The file number is reset when a new folder is created or the recording folder is replaced with another.

#### RESET

Assigns file numbers in sequence, following the largest file number existing on the current recording medium.

### AE SHIFT (HDR-SR7E/SR8E)



See page 64.

**WB SHIFT (White Balance Shift)**  
(HDR-SR7E/SR8E)



See page 64.

**NIGHTSHOT LIGHT**



See page 64.

**STEADYSHOT**  
(HDR-SR7E/SR8E)



See page 65.

**GUIDEFAME**



See page 65.

**ZEBRA**



See page 66.

**FLASH LEVEL**



See page 66.

**REDEYE REDUC**



See page 66.

**DIAL SETTING**  
(HDR-SR7E/SR8E)



See page 67.

**STILL MEDIA**



See page 31.

## VIEW IMAGES SET

(Items to customize the display)

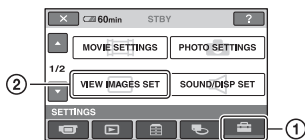

Touch ①, then ②.

If the item is not on the screen, touch ▲/▼ to change the page.

### How to set

🏠 (HOME MENU) → page 61

⊕ (OPTION MENU) → page 76

The default settings are marked with ▶.

**▶ HD/SD INDEX SET**



You can select the image quality of the movie you play back.

#### ▶ HD/SD HD QUALITY

Plays back movies recorded with HD (high definition) image quality.

#### ▶ HD/SD SD QUALITY

Plays back movies recorded with SD (standard definition) image quality.

**DATA CODE**



During playback, displays the information (data code) recorded automatically at the time of recording.

#### ▶ OFF

Data code is not displayed.

#### DATE/TIME

Displays the date and time.

#### CAMERA DATA (below)

Displays camera setting data.

## DATE/TIME

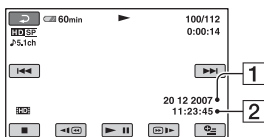

- 1 Date
- 2 Time

## CAMERA DATA

### Movie

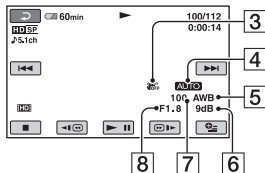

### Still image

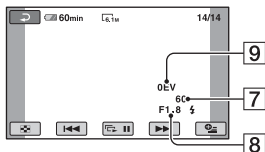

- 3 SteadyShot off
- 4 Brightness
- 5 White balance
- 6 Gain
- 7 Shutter speed
- 8 Aperture value
- 9 Exposure

## Tips

-  appears for an image recorded using a flash.
- The data code is displayed on the TV screen if you connect your camcorder to a TV.
- The indicator toggles through the following sequences as you press DATA CODE on the Remote Commander: [DATE/TIME] → [CAMERA DATA] → [OFF] (no indication).

- Depending on the hard disk condition, bars [---:--:--] appear.

## DISPLAY

You can select the number of thumbnails that appear on the VISUAL INDEX screen.

### ZOOM LINK

Change the number of thumbnails (6 or 12) with the power zoom lever on your camcorder.\*

### 6IMAGES

Displays thumbnails of 6 images.

### 12IMAGES

Displays thumbnails of 12 images.

\* You can also operate with the zoom buttons on the LCD frame or on the Remote Commander.

## INTERVAL SET

You can select the duration of each thumbnail from 3, 6, 12 seconds, 1 or 5 minutes. The default setting is [3 sec.].

# SOUND/DISP SET

(Items to adjust the sound and the screen)

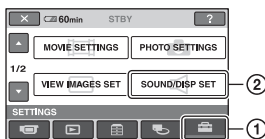

Touch ①, then ②.

If the item is not on the screen, touch ▲/▼ to change the page.

## How to set

🏠 (HOME MENU) → page 61

⊕☰ (OPTION MENU) → page 76

The default settings are marked with ▶.

## VOLUME



Touch / to adjust the volume (p. 36).

## BEEP



### ▶ ON

A melody sounds when you start/stop recording, or operate the touch panel.

### OFF

Cancels the melody.

## LCD BRIGHT



You can adjust the brightness of the LCD screen with / .

① Adjust the brightness with / .

② Touch .

### 💡 Tips

- This adjustment does not affect the recorded images in any way.

## LCD BL LEVEL



You can adjust the brightness of the LCD screen's backlight.

### ▶ NORMAL

Standard brightness.

### BRIGHT

Brightens the LCD screen.

### 💡 Notes

- When you connect your camcorder to outside power sources, [BRIGHT] is automatically selected for the setting.
- When you select [BRIGHT], battery life is slightly reduced during recording.
- If you open the LCD panel 180 degrees to face the screen outside and close the LCD panel to the camcorder body, the setting becomes [NORMAL] automatically.

### 💡 Tips

- This adjustment does not affect the recorded images in any way.

## LCD COLOR



You can adjust the color of the LCD screen with / .



Low intensity

High intensity

### 💡 Tips

- This adjustment does not affect the recorded images in any way.

## VF B.LIGHT (HDR-SR7E/SR8E)



You can adjust the brightness of the viewfinder.

### ▶ NORMAL

Standard brightness.

### BRIGHT

Brightens the viewfinder screen.



# OUTPUT SETTINGS

(Items for when connecting other devices)

## Notes

- When you connect your camcorder to outside power sources, [BRIGHT] is automatically selected for the setting.
- When you select [BRIGHT], battery life is slightly reduced during recording.

## Tips

- This adjustment does not affect the recorded images in any way.

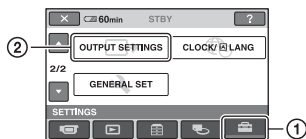

Touch ①, then ②.

If the item is not on the screen, touch ▲/▼ to change the page.

## How to set

🏠 (HOME MENU) → page 61

⊕ (OPTION MENU) → page 76

The default settings are marked with ►.

## TV TYPE



You need to convert the signal depending on the TV connected when playing back the image. The recorded images are played back as following illustrations.

### ► 16:9

Select this to view your images on a 16:9 (wide) TV.

16:9 (wide) images

4:3 images



### 4:3

Select this to view your images on a 4:3 standard TV.

16:9 (wide) images

4:3 images



## Notes

- Aspect ratio of the image recorded with HD (high definition) image quality is 16:9.

## DISP OUTPUT

### ▶ LCD PANEL

Shows displays such as the time code in the viewfinder (HDR-SR7E/SR8E) and on the LCD screen.

### V-OUT/PANEL

Shows displays such as the time code in the viewfinder (HDR-SR7E/SR8E), on the TV screen and LCD screen.

## COMPONENT

Select [COMPONENT] when connecting your camcorder to a TV with the component input jack.

### 576i

Select when connecting your camcorder to a TV with the component input jack.

### ▶ 1080i/576i

Select when connecting your camcorder to a TV that has the component input jack and is capable of displaying the 1080i signal.

# CLOCK/ LANG

(Items to set clock and language)

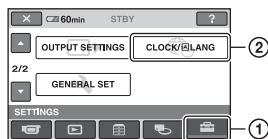

Touch ①, then ②.

If the item is not on the screen, touch ▲/▼ to change the page.

## How to set

 (HOME MENU) → page 61

 (OPTION MENU) → page 76

## CLOCK SET

See page 20.

## AREA SET

You can adjust a time difference without stopping the clock.

Set your local area using ▲/▼ when using your camcorder in other time zones.

Refer to the world time difference on page 97.

## SUMMERTIME

You can change this setting without stopping the clock.

Set to [ON] to move the time forward 1 hour.

## LANGUAGE SET

You can select the language to be used on the LCD screen.

## Tips

- Your camcorder offers [ENG[SIMP]] (simplified English) for when you cannot find your native tongue among the options.

# GENERAL SET

(Other setup items)

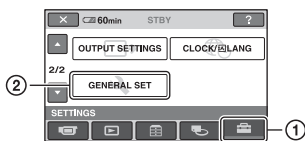

Touch ①, then ②.

If the item is not on the screen, touch ▲/▼ to change the page.

## How to set

🏠 (HOME MENU) → page 61



☰ (OPTION MENU) → page 76

The default settings are marked with ▶.

## DEMO MODE

The default setting is [ON], allowing you to view the demonstration in about 10 minutes, after you slide the POWER switch to  (Movie).

### Tips

- The demonstration will be suspended in situations such as those described below.
  - When you press START/STOP or PHOTO.
  - When you touch the screen during the demonstration (The demonstration starts again after about 10 minutes).
  - When you remove or insert a “Memory Stick Duo.”
  - When you set the POWER switch to  (Still).
  - When you press  (HOME) or  (VIEW IMAGES).

## REC LAMP (Recording lamp)

The camera recording lamp on the front of your camcorder lights up, as the default setting is [ON].

## CALIBRATION

See page 103.

## A.SHUT OFF (Auto shut off)

### ▶ 5 min

The camcorder is automatically turned off when you do not operate your camcorder for more than approximately 5 minutes.

### NEVER

The camcorder is not automatically turned off.

### Notes

- When you connect your camcorder to a wall socket, [A.SHUT OFF] is automatically set to [NEVER].

## REMOTE CTRL (Remote control)

The default setting is [ON], allowing you to use the supplied Remote Commander (p. 111).

### Tips

- Set to [OFF] to prevent your camcorder from responding to a command sent by another VCR remote control unit.

## DROP SENSOR

When the drop sensor has detected that the camcorder has been dropped, your camcorder may not allow you to record and play back correctly to protect the internal hard disk, as the default setting is [ON]. When dropping is detected,  appears.

### Notes

- Set the drop sensor to [ON] when you use the camcorder. Otherwise, if you drop the camcorder, you may damage the internal hard disk.
- In a non-gravity situation, the drop sensor activates. When you record images during an activity such as roller-coasting or skydiving, you can set [DROP SENSOR] to [OFF] () so as not to activate the drop sensor.

# Activating functions using the OPTION MENU

The  (OPTION) MENU appears just like the pop-up window that appears when you right-click the mouse on a computer. Various available functions are displayed.

## Using the OPTION MENU

- 1 While using your camcorder, touch  (OPTION) on the screen.

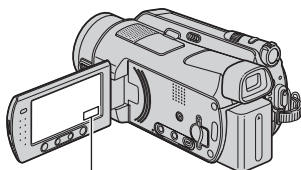

 (OPTION)

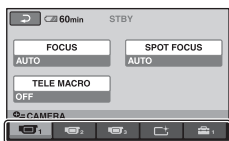

Tab

- 2 Touch the desired item.

If you cannot find the desired item, touch another tab to change the page.

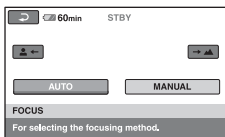

- 3 Change the setting, then touch .









## When the item you want is not on the screen

Touch another tab. If you cannot find the item anywhere, the function does not work under the current situation.

### Notes

- The tabs and items that appear on the screen depend on the recording/playback status of your camcorder at the time.
- Some items appear without a tab.
- The  (OPTION) MENU cannot be used during Easy Handycam operation.















## Recording items on the OPTION MENU



Items	 *	Page
 tab		
FOCUS	–	78
SPOT FOCUS	–	79
TELE MACRO	–	79
EXPOSURE	–	79
SPOT METER	–	79
AE SHIFT**	○	64
SCENE SELECTION	–	80
WHITE BAL.	–	81
WB SHIFT**	○	64
COLOR SLOW SHTR	–	81
SUPER NIGHTSHOT	–	82
 tab		
FADER	–	82
D.EFFECT	–	82
PICT.EFFECT	–	82
 tab		
 REC SET	○	63
 REC MODE	○	63
 REC MODE	○	64
MICREF LEVEL	–	82
 IMAGE SIZE	○	67
 QUALITY	○	68
SELF-TIMER	–	83
STILL MEDIA	○	31
TIMING	–	32
RECORD SOUND	–	32

\* Items that are included also in the HOME MENU.

\*\* HDR-SR7E/SR8E

## Viewing items on the OPTION MENU

Items	 *	Page
 tab		
DELETE	○	46
DELETE by date	○	47
DELETE ALL	○	47
 tab		
DIVIDE	○	48
ERASE	○	51
ERASE ALL	○	51
MOVE	○	52
-- (The tab depends on the situation/No tab)		
 ADD**	○	51
 ADD**	○	51
 ADD by date**	○	51
 ADD by date**	○	51
PRINT	○	54
SLIDE SHOW	–	38
VOLUME	○	72
DATA CODE	○	70
SLIDE SHOW SET	–	38
 ADD	○	50
 ADD	○	50
 ADD by date	○	51
 ADD by date	○	51
 INDEX SET	○	70
COPY →  **	○	49
 COPY by date**	○	50
COPIES	–	54

Items	 *	Page
DATE/TIME	–	54
SIZE	–	54
 INTERVAL SET	○	71

\* Items that are included also in the HOME MENU.

\*\* Items that are included also in the HOME MENU, but the item names are different.

## Functions set in the OPTION MENU

Items you can set only on the  (OPTION) MENU will be described below.

The default settings are marked with ►.

### FOCUS







You can adjust the focus manually. You can select this function also when you want to focus on a certain subject intentionally.



① Touch [MANUAL].

 appears.

② Touch  (focusing on close subjects)/  (focusing on distant subjects) to sharpen the focus.  appears when the focus cannot be adjusted any closer, and  appears when the focus cannot be adjusted farther away.

③ Touch [OK].

To adjust the focus automatically, touch [AUTO] → [OK] in step ①.

### Notes

- The minimum possible distance between camcorder and subject while maintaining sharp focus is about 1 cm (about 13/32 in.) for wide angle and about 80 cm (about 2 5/8 feet) for telephoto.

### Tips

- It is easier to focus on the subject by moving the power zoom lever towards T (telephoto) to adjust the focus, then towards W (wide angle) to adjust the zoom for recording. When you want to record a subject at close range, move the power zoom lever to W (wide angle), then adjust the focus.
- The focal distance information (distance at which the subject is focused on, if it is dark and focus adjustment is difficult) appears for a few seconds in the following cases (This information will not display correctly if an optional conversion lens is being used).
  - when the focus mode is switched from automatic to manual
  - when you set focus manually

- For HDR-SR7E/SR8E:

You can also adjust the focus manually using the CAM CTRL dial (p. 33).

## SPOT FOCUS



You can select and adjust the focal point to aim it at a subject not located at the center of the screen.

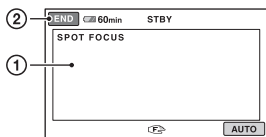

- 1 Touch the subject on the screen.

appears.

- 2 Touch [END].

To adjust the focus automatically, touch [AUTO] → [END] in step 1.

### Notes

- If you set [SPOT FOCUS], [FOCUS] is automatically set to [MANUAL].

## TELE MACRO



This is useful to shoot small subjects, such as flowers or insects. You can blur out backgrounds and the subject stands out clearer.

When you set [TELE MACRO] to [ON] (T ) , the zoom (p. 29) moves to the top of the T (telephoto) side automatically and allows recording subjects at a close distance as follows:

For HDR-SR5E: down to about 37 cm (14 5/8 in.).

For HDR-SR7E/SR8E: down to about 45 cm (17 3/4 in.).

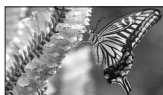

To cancel, touch [OFF], or zoom to wide-angle (W side).

### Notes

- When recording a distant subject, focusing may be difficult and can take some time.
- Adjust the focus manually ([FOCUS], p. 78) when it is hard to focus automatically.

## EXPOSURE



You can fix the brightness of a picture manually. Adjust the brightness when the subject is too bright or too dark.

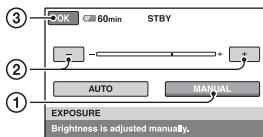

- 1 Touch [MANUAL].

appears.

- 2 Adjust the exposure by touching / .

- 3 Touch [OK].

To return the setting to automatic exposure, touch [AUTO] → [OK] in step 1.

### Tips

- For HDR-SR7E/SR8E:

You can also adjust the setting manually using the CAM CTRL dial (p. 33).

## SPOT METER (Flexible spot meter)



You can adjust and fix the exposure to the subject, so that it is recorded in suitable brightness even when there is strong contrast between the subject and the background, such as subjects in the spotlight on stage.

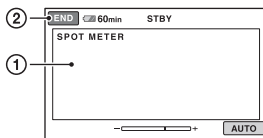





\*\* Adjusted not to focus on subjects a short distance away.

## 🔊 Notes

- If you set [SCENE SELECTION], [WHITE BAL.] setting is canceled.
- If you set [SCENE SELECTION] to [TWILIGHT PORT.] and switch from still image recording to movie recording, the setting changes to [AUTO].

## WHITE BAL. (White balance)



You can adjust the color balance to the brightness of the recording environment.

### ▶ AUTO

The white balance is adjusted automatically.

### OUTDOOR (☀️)

The white balance is adjusted to be appropriate for the following recording conditions:

- Outdoors
- Night views, neon signs and fireworks
- Sunrise or sunset
- Under daylight fluorescent lamps

### INDOOR (🏠)

The white balance is adjusted to be appropriate for the following recording conditions:

- Indoors
- At party scenes or studios where the lighting conditions change quickly
- Under video lamps in a studio, or under sodium lamps or incandescent-like color lamps

### ONE PUSH (📷)

The white balance will be adjusted according to the ambient light.

- ① Touch [ONE PUSH].
- ② Frame a white object such as a piece of paper, to fill the screen under the same lighting conditions as you will shoot the subject.

③ Touch [📷].

📷 flashes quickly. When the white balance has been adjusted and stored in the memory, the indicator stops flashing.

## 🔊 Notes

- Set [WHITE BAL.] to [AUTO] or adjust the color in [ONE PUSH] under white or cool white fluorescent lamps.
- When you select [ONE PUSH], keep framing white objects while 📷 is flashing quickly.
- 📷 flashes slowly if [ONE PUSH] could not be set.
- When [ONE PUSH] was selected, if 📷 keeps flashing after touching [OK], set [WHITE BAL.] to [AUTO].
- If you set [WHITE BAL.], [SCENE SELECTION] is set to [AUTO].

## 💡 Tips

- If you have changed the battery pack while [AUTO] was selected, or taken your camcorder outdoors after inside use (or vice versa), select [AUTO] and aim your camcorder at a nearby white object for about 10 seconds for better color balance adjustment.
- When the white balance has been set with [ONE PUSH], if you change the [SCENE SELECTION] settings, or bring your camcorder outdoors from inside the house, or vice versa, you need to redo the [ONE PUSH] procedure to readjust the white balance.

## COLOR SLOW SHTR (Color Slow Shutter)



When you set [COLOR SLOW SHTR] to [ON], 📷 appears, and you can record an image brighter in color even in dark places.

## 🔊 Notes

- Adjust the focus manually ([FOCUS], p. 78) when it is hard to focus automatically.
- The shutter speed of your camcorder changes depending on the brightness, which may result in a slowdown of the motion of the image.

## SUPER NIGHTSHOT



The image will be recorded at a maximum of 16 times the sensitivity of NightShot recording if you set [SUPER NIGHTSHOT] to [ON] while the NIGHTSHOT switch (p. 31) is also set to ON.

appears on the screen.

To return to the normal setting, set [SUPER NIGHTSHOT] to [OFF].

### Notes

- Do not use [SUPER NIGHTSHOT] in bright places. This may cause a malfunction.
- Do not cover the infrared port with your fingers or other objects (p. 31).
- Remove the conversion lens (optional).
- Adjust the focus manually ([FOCUS], p. 78) when it is hard to focus automatically.
- The shutter speed of your camcorder changes depending on the brightness, which may result in a slowdown of the motion of the image.

## FADER



You can record a transition with the following effects adding to the interval between scenes.

- ① Select the desired effect in [STBY] (to fading in) or [REC] (to fading out) mode, then touch .
- ② Press START/STOP.

The fader indicator stops flashing and disappears when the fade is complete.

To cancel the fader before starting the operation, touch [OFF] in step ①. If you press START/STOP, the setting is canceled.



## WHITE FADER



## BLACK FADER



## D.EFFECT (Digital effect)



When you select [OLD MOVIE], appears and you can add an old movie effect to images.

To cancel [D.EFFECT], touch [OFF].

## PICT.EFFECT (Picture effect)



You can add special effects to an image during recording or playback. appears.

### ▶ OFF

Does not use [PICT.EFFECT] setting.

### SEPIA

Images appear in sepia.

### B&W (Black and white)

Images appear in black and white.

### PASTEL



Images appear as a pale pastel drawing.

## MICREF LEVEL (Mic reference level)



You can select the microphone level for recording sound.

Select [LOW] when you want to record exciting and powerful sound in a concert hall, etc.

### ▶ NORMAL

Records various surround sounds, converting them into the appropriate level.

### LOW (↓)

Records surround sound faithfully. This setting is not suitable for recording conversations.

## SELF-TIMER



A still image is recorded after about 10 seconds.

Press PHOTO when [SELF-TIMER] is set to [ON], and  appears.

To cancel the count down, touch [RESET].

To cancel the self-timer, select [OFF].

### **Tips**

- You can also operate by pressing PHOTO on the Remote Commander (p. 111).

# Troubleshooting

If you run into any problems using your camcorder, use the following table to troubleshoot the problem. If the problem persists, disconnect the power source and contact your Sony dealer.

- Overall operations/Easy Handycam operation/Remote Commander .....84
- Batteries/Power sources .....85
- Viewfinder (HDR-SR7E/SR8E)/LCD screen.....86
- “Memory Stick Duo” .....86
- Recording .....87
- Playing back images on your camcorder .....89
- Editing images on your camcorder.....89
- Viewing on the TV .....90
- Dubbing/Connecting to other devices .....90
- Functions that cannot be used simultaneously .....90

## Notes before sending your camcorder for repair

- Your camcorder may be required to initialize or change the current hard disk of the camcorder, depending on the problem. In the event of this, the data stored on the hard disk will be deleted. Be sure to save the data on the internal hard disk (p. 45) onto other media (backup) before sending your camcorder for repair. We will not compensate you for any loss of hard disk data.
- During repair, we may check a minimum amount of data stored on the hard disk in order to investigate the problem. However, your Sony dealer will neither copy nor retain your data.

## Overall operations/Easy Handycam operation/Remote Commander

### The power does not turn on.

- Attach a charged battery pack to the camcorder (p. 16).
- The plug of the AC Adaptor has been disconnected from the wall socket. Connect it to the wall socket (p. 16).
- Set the camcorder onto the Handycam Station securely (p. 16).

### The camcorder does not operate even when the power is set to on.

- It takes a few seconds for your camcorder to be ready to shoot after the power is turned on. This is not a malfunction.
- Disconnect the AC Adaptor from the wall socket or remove the battery pack, then reconnect it after about 1 minute. If the functions still do not work, press the RESET button (p. 109) using a pointed object (If you press the RESET button, all settings, including the clock setting, are reset).
- The temperature of your camcorder is extremely high. Turn off your camcorder and leave it for a while in a cool place.
- The temperature of your camcorder is extremely low. Leave your camcorder with the power of your camcorder on. Turn off your camcorder and take it to a warm place. Leave the camcorder there for a while, then turn on your camcorder.

### Buttons do not work.

- During Easy Handycam operation, the following buttons/functions are not available.
  - BACK LIGHT button (p. 32)
  - CAM CTRL dial (HDR-SR7E/SR8E) (p. 33)
  - Playback zoom (p. 37)
  - To turn on and off the LCD backlight (Pressing and holding the DISP/BATT INFO button for a few seconds) (p. 21)

---

### The (OPTION) is not displayed.

- The OPTION MENU cannot be used during Easy Handycam operation.

---

### The menu settings have changed automatically.

- During Easy Handycam operation, nearly all the menu items will be automatically set to the default settings.
- During Easy Handycam operation, some menu items are fixed as follows.
  - [] REC MODE]: [HD SP]
  - [] REC MODE]: [SD SP]
  - [] QUALITY]: [FINE]
  - [DATA CODE]: [DATE/TIME]
- Following menu items return to the default settings when you set the POWER switch to OFF (CHG) for more than 12 hours.
  - [FOCUS]
  - [SPOT FOCUS]
  - [EXPOSURE]
  - [SPOT METER]
  - [SCENE SELECTION]
  - [WHITE BAL.]
  - [MICREF LEVEL]
  - [DROP SENSOR]

---

### Even if you press EASY, menu settings do not switch to their defaults automatically.

- During Easy Handycam operation, settings for the following menu items are maintained the ones before Easy Handycam operation.
  - [WIDE SELECT]
  - [X.V.COLOR]
  - [DIAL SETTING] (HDR-SR7E/SR8E)
  - [] INDEX SET]
  - [] IMAGE SIZE]
  - [FILE NO.]
  - [STILL MEDIA]
  - [] INDEX SET]
  - [] DISPLAY]
  - [] INTERVAL SET]
  - [VOLUME]
  - [BEEP]
  - [TV TYPE]
  - [COMPONENT]

- [CLOCK SET]
- [AREA SET]
- [SUMMERTIME]
- [] LANGUAGE SET]
- [DEMO MODE]
- [TIMING] and [RECORD SOUND] in [SMTH SLW REC]

---

### Your camcorder gets warm.

- This is because the power has been turned on for a long time. This is not a malfunction.

---

### The supplied Remote Commander does not function.

- Set [REMOTE CTRL] to [ON] (p. 75).
- Insert a battery into the battery holder with the +/- polarities correctly matching the +/- marks (p. 111).
- Remove any obstructions between the Remote Commander and the remote sensor.
- Point the remote sensor away from strong light sources such as direct sunlight or overhead lighting. Otherwise, the Remote Commander may not function properly.

---

### Another DVD device malfunctions when you use the supplied Remote Commander.

- Select a commander mode other than DVD 2 for your DVD device, or cover the sensor of your DVD device with black paper.

---

## Batteries/Power sources

### The power abruptly turns off.

- When approximately 5 minutes have elapsed while you do not operate your camcorder, the camcorder is automatically turned off (A.SHUT OFF). Change the setting of [A.SHUT OFF] (p. 75), or turn on the power again, or use the AC Adaptor.
- The battery pack is discharged or running low. Charge the battery pack (p. 16).

---

**The  $\frac{1}{2}$ /CHG (charge) lamp does not light while the battery pack is being charged.**

- Slide the POWER switch to OFF (CHG) (p. 16).
- Attach the battery pack to the camcorder correctly (p. 16).
- Connect the mains lead to the wall socket properly.
- The battery charge is completed (p. 16).
- Set the camcorder onto the Handycam Station securely (p. 16).

---

**The  $\frac{1}{2}$ /CHG (charge) lamp flashes while the battery pack is being charged.**

- Attach the battery pack to the camcorder correctly (p. 16). If the problem persists, disconnect the AC Adaptor from the wall socket and contact your Sony dealer. The battery pack may be damaged.

---

**The remaining battery time indicator does not indicate the correct time.**

- The temperature of the environment is too high or too low. This is not a malfunction.
- The battery pack has not been charged enough. Fully charge the battery again. If the problem persists, replace the battery pack with a new one (p. 16).
- The indicated time may not be correct depending on the environment of use.

---

**The battery pack is quickly discharged.**

- The temperature of the environment is too high or low. This is not a malfunction.
- The battery pack has not been charged enough. Fully charge the battery again. If the problem persists, replace the battery pack with a new one (p. 16).

---

**Viewfinder (HDR-SR7E/SR8E)/  
LCD screen**

**Menu items are grayed out.**

- You cannot select grayed items in the current recording/playback situation.
- There are some functions you cannot activate simultaneously (p. 90).

---

**The buttons do not appear on the touch panel.**

- Touch the LCD screen lightly.
- Press DISP/BATT INFO on your camcorder (or DISPLAY on the Remote Commander) (p. 21, 111).

---

**The buttons on the touch panel do not work correctly or do not work at all.**

- Adjust the touch panel ([CALIBRATION]) (p. 103).

---

**The image in the viewfinder is not clear (HDR-SR7E/SR8E).**

- Move the viewfinder lens adjustment lever until the image appears clearly (p. 22).

---

**The image in the viewfinder has disappeared (HDR-SR7E/SR8E).**

- Close the LCD panel. No image is displayed in the viewfinder when the LCD panel is open (p. 22).

---

**“Memory Stick Duo”**

**You cannot operate functions using the “Memory Stick Duo.”**

- If you use a “Memory Stick Duo” formatted on a computer, format it again on your camcorder (p. 58).

---

### You cannot delete images stored on or format the “Memory Stick Duo.”

- Release the lock on the write-protect tab of the “Memory Stick Duo” if there is one (p. 100).
- The maximum number of images that you can delete on the index screen at one time is 100.
- You cannot delete the images protected on another device.

---

### The data file name is not indicated correctly or flashes.



- The file is damaged.
- The file format is not supported by your camcorder (p. 99).

## Recording

Refer also to “Memory Stick Duo” (p. 86).

---

### Pressing START/STOP or PHOTO does not record images.

- The playback screen is displayed. Set the POWER switch to  (Movie) or  (Still) (p. 28).
- Your camcorder is recording the image you have just shot on the hard disk. You cannot make new recording during this period.
- The hard disk of the camcorder is full. Delete unnecessary images (p. 46).
- Total number of movie scenes or still images exceeds the recordable capacity of your camcorder (p. 11). Delete unnecessary images (p. 46).
- While [DROP SENSOR] activates (p. 75), you may not record movies/still images.
- The temperature of your camcorder is extremely high. Turn off your camcorder and leave it for a while in a cool place.
- The temperature of your camcorder is extremely low. Turn off your camcorder and take it to a warm place. Leave the camcorder there for a while, then turn on the camcorder.

---

### You cannot record a still image.

- The playback screen is displayed. Set your camcorder to recording standby (p. 28).
- You can capture up to 3 still images only during movie recording.
- The “Memory Stick Duo” has run out of space. Use a new “Memory Stick Duo” or format the “Memory Stick Duo” (p. 58). Or delete the unnecessary images (p. 47).
- You cannot record a still image together with:
  - [SMTH SLW REC]
  - [FADER]
  - [D.EFFECT]
  - [PICT.EFFECT]

---

### The ACCESS lamp remains lit or flashing even when you stop recording.

- Your camcorder is recording the scene you have just shot on the hard disk.

---

### The recording angle looks different.

- The recording angle may look different depending on the condition of your camcorder. This is not a malfunction.

---

### The flash does not work.

- You cannot record with the flash with:
  - Capturing still images while shooting a movie
  - If a conversion lens (optional) is attached
- Even if auto flash or  (Auto redefy reduction) is selected, you cannot use the internal flash with:
  - NightShot
  - [SUPER NIGHTSHOT]
  - [TWILIGHT], [CANDLE], [SUNRISE&SUNSET], [FIREWORKS], [LANDSCAPE], [SPOTLIGHT], [BEACH] or [SNOW] in [SCENE SELECTION]
  - [MANUAL] in [EXPOSURE]
  - [SPOT METER]

---

**The actual recording time for movie is less than the expected approximate recording time of the hard disk.**

- Depending on an object, such as a fast moving object, the time available for recording may shorten (p. 11, 63).

---

**The recording stops.**

- The temperature of your camcorder is extremely high. Turn off your camcorder and leave it for a while in a cool place.
- The temperature of your camcorder is extremely low. Turn off your camcorder and take it to a warm place. Leave the camcorder there for a while, then turn on the camcorder.
- If you keep applying vibration on the camcorder, recording may stop.

---

**There is a time difference between the point where you press START/STOP and the point that the recorded movie starts/stops.**

- On your camcorder, there may be a slight time difference between the point where you press START/STOP and the actual point that recording movie starts/stops. This is not a malfunction.

---

**The movie aspect ratio (16:9 (wide)/4:3) cannot be changed.**

- The aspect ratio of the movie recorded with HD (high definition) image quality is 16:9 (wide).

---

**The auto focus does not function.**

- Set [FOCUS] to [AUTO] (p. 78).
- The recording conditions are not suitable for auto focus. Adjust the focus manually (p. 78).

---

**[STEADYSHOT] does not function.**

- Set [STEADYSHOT] to [ON] (p. 65).
- [STEADYSHOT] may not be able to compensate for excessive vibrations.
- For HDR-SR5E: [STEADYSHOT] cannot be used while recording still images.

---

**The BACK LIGHT function does not function.**

- The BACK LIGHT function cannot be used during Easy Handycam operation.

---

**The subjects passing by the screen very fast appear crooked.**

- This is called the focal plane phenomenon. This is not a malfunction. Because of the way the image device (CMOS sensor) reads out image signals, the subjects passing by the lens rapidly might appear crooked depending on the recording conditions.

---

**Tiny spots in white, red, blue, or green appear on the screen.**

- The spots appear when you are recording with [SUPER NIGHTSHOT] or [COLOR SLOW SHTR]. This is not a malfunction.

---

**The color of the image is not correctly displayed.**

- Set the NIGHTSHOT switch to OFF (p. 31).

---

**The screen image is bright, and the subject does not appear on the screen.**

- Set the NIGHTSHOT switch to OFF (p. 31).

---

**The screen image is dark, and the subject does not appear on the screen.**

- Press and hold DISP/BATT INFO for a few seconds to turn on the backlight (p. 21).



---

### Horizontal stripes appear on the images.

- This occurs when recording images under a fluorescent lamp, sodium lamp, or mercury lamp. This is not a malfunction.

---

### Black bands appear when you record a TV screen or computer screen.

- Set [STEADYSHOT] to [OFF] (p. 65) (HDR-SR5E).

---

### [SUPER NIGHTSHOT] cannot be operated.

- Set the NIGHTSHOT switch to ON.

---

### [COLOR SLOW SHTR] does not operate correctly.

- [COLOR SLOW SHTR] may not operate correctly in total darkness. Use NightShot or [SUPER NIGHTSHOT].

---

### You cannot adjust [LCD BL LEVEL].

- You cannot adjust [LCD BL LEVEL] when:
  - The LCD panel is closed on your camcorder with the LCD screen facing out.
  - The power is supplied from the AC Adaptor.

### Playing back images on your camcorder

#### Still images stored on a “Memory Stick Duo” cannot be played back.

- Still images cannot be played back if you have modified files or folders, or have edited the data on a computer. (The file name flashes in that case.) This is not a malfunction (p. 101).
- Still images recorded on other devices may not be played back. This is not a malfunction (p. 101).

---

### “[?]” is indicated on an image in the VISUAL INDEX screen.

- This may appear on still images recorded on other devices, edited on a computer, etc.
- You removed the AC Adaptor or the battery pack before the ACCESS lamp is turned off after recording. This may damage your image data and [?] is displayed.

---

### “[REPAIR]” is indicated on an image in the VISUAL INDEX screen.

- Execute [REPAIR IMG.DB F.] (p. 59). If it still appears, delete the image with [REPAIR] (p. 46).

---

### No sound or only a quiet sound is heard during playback.

- Turn up the volume (p. 36).
- Sound is not output when the LCD screen is closed. Open the LCD screen.
- When you record sound with [MICREF LEVEL] (p. 82) set to [LOW], the recorded sound may be difficult to hear.
- Sounds cannot be recorded while shooting a 3 second-movie (approx.) using [SMTH SLW REC].

### Editing images on your camcorder

#### Unable to edit.

- Unable to edit because of the condition of the image.

---

#### Images cannot be added in the Playlist.

- There is no free space in the hard disk.
- You can add no more than 999 images with HD (high definition) image quality, or 99 images with SD (standard definition) image quality, to a Playlist. Erase unnecessary images from the Playlist (p. 51).
- You cannot add still images in the Playlist.

---

### A movie cannot be divided.

- A movie that is too short cannot be divided.
- A movie protected on another device cannot be divided.

---

### Unable to copy the images from the hard disk to a “Memory Stick Duo.”

- You cannot copy a movie from the hard disk to a “Memory Stick Duo” as a still image during playback on your camcorder.

### Viewing on the TV

#### You cannot view the image or hear the sound on the TV.

- When you are using the component video cable, set [COMPONENT] according to the requirements of the connected device (p. 74).
- When you are using the component video cable, make sure the red and white plugs of the A/V connecting cable are connected (p. 41, 42).
- Images are not output from the HDMI OUT jack, if copyright protection signals are recorded in the images.
- When you are using the S VIDEO plug, make sure the red and white plugs of the A/V connecting cable are connected (p. 42).

---

#### The image appears distorted on the 4:3 TV.

- This happens when viewing an image recorded in the 16:9 (wide) mode on a 4:3 TV. Set [TV TYPE] correctly (p. 73) and play back the image.

---

#### Black bands appear at the top and bottom of the screen of the 4:3 TV.

- This happens when viewing an image recorded in the 16:9 (wide) mode on a 4:3 TV. This is not a malfunction.

### Dubbing/Connecting to other devices

#### You cannot dub correctly.

- You cannot dub images using the HDMI cable.
- The A/V connecting cable is not connected properly. Make sure to connect to the input jack of another device (p. 39).

### Functions that cannot be used simultaneously

The following list shows examples of unworkable combinations of functions and menu items.

Cannot use	Because of following settings
BACK LIGHT	[SPOT METER], [FIREWORKS], [MANUAL] in [EXPOSURE]
[SCENE SELECTION]	NightShot, [SUPER NIGHTSHOT], [COLOR SLOW SHTR], [OLD MOVIE], [TELE MACRO], [FADER]
[SPOT METER]	NightShot, [SUPER NIGHTSHOT]
[EXPOSURE]	NightShot, [SUPER NIGHTSHOT]
[WHITE BAL.]	NightShot, [SUPER NIGHTSHOT]
[ONE PUSH] in [WHITE BAL.]	[SMTH SLW REC]
[SPOT FOCUS]	[SCENE SELECTION]
[SUPER NIGHTSHOT]	[FADER], [D.EFFECT]
[COLOR SLOW SHTR]	[FADER], [D.EFFECT], [SCENE SELECTION]

Cannot use	Because of following settings
[FADER]	[SUPER NIGHTSHOT], [COLOR SLOW SHTR], [D.EFFECT], [CANDLE], [FIREWORKS]
[D.EFFECT]	[SUPER NIGHTSHOT], [COLOR SLOW SHTR], [FADER]
[OLD MOVIE]	[SCENE SELECTION], [PICT.EFFECT]
[PICT.EFFECT]	[OLD MOVIE]
[STEADYSHOT]	[SMTH SLW REC] (HDR-SR5E)
[TELE MACRO]	[SCENE SELECTION]
[AUTO SLW SHUTTR]	[SMTH SLW REC], [D.EFFECT], [SCENE SELECTION], [COLOR SLOW SHTR], [SUPER NIGHTSHOT]
[AE SHIFT] (HDR-SR7E/ SR8E)	[FIREWORKS], [MANUAL] in [EXPOSURE]
[WIDE SELECT]	[OLD MOVIE]

# Warning indicators and messages

## Self-diagnosis display/Warning indicators

If indicators appear in the viewfinder (HDR-SR7E/SR8E) or on the LCD screen, check the following.

You can fix some symptoms by yourself. If the problem persists even after you have tried a couple of times, contact your Sony dealer or local authorized Sony service facility.

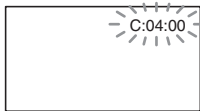

### C:(or E:) □□:□□ (Self-diagnosis display)

#### C:04:□□

- The battery pack is not an “InfoLITHIUM” battery pack (H series). Use an “InfoLITHIUM” battery pack (H series) (p.101).
- Connect the DC plug of the AC Adaptor to the DC IN jack of the Handycam Station or your camcorder securely (p.16).

#### C:13:□□ / C:32:□□

- Remove the power source. Reconnect it and operate your camcorder again.

#### E:20:□□ / E:31:□□ / E:61:□□ / E:62:□□ / E:91:□□ / E:94:□□

- A malfunction that you cannot service has occurred. Contact your Sony dealer or local authorized Sony service facility. Inform them of the 5-digit code, which starts from “E”.

### 101-0001 (Warning indicator pertaining to files)

#### Slow flashing

- The file is damaged.
- The file is unreadable.

### (Warning on the hard disk of the camcorder)\*

#### Fast flashing

- An error may have occurred with the hard disk drive in your camcorder.

### (Warning on the hard disk of the camcorder)\*

#### Fast flashing

- The hard disk of the camcorder is fully recorded.
- An error may have occurred with the hard disk drive in your camcorder.

### (Battery level warning)

#### Slow flashing

- The battery pack is nearly used up.
- Depending on the operating environment or battery conditions,  may flash, even if there are approximately 20 minutes remaining.

### (High temperature warning)

#### Slow flashing

- The temperature of your camcorder is getting higher. Turn off your camcorder and leave it for a while in a cool place.

#### Fast flashing\*

- The temperature of your camcorder is extremely high. Turn off your camcorder and leave it for a while in a cool place.

### (Low temperature warning)\*

#### Fast flashing

- The temperature of your camcorder is extremely low. Make the camcorder warm.

---

 (Warning indicator pertaining to “Memory Stick Duo”)

- No “Memory Stick Duo” is inserted (p. 31).

---

 (Warning indicators pertaining to “Memory Stick Duo” formatting)\*

- The “Memory Stick Duo” is damaged.
- The “Memory Stick Duo” is not formatted correctly (p. 58, 99).

---

 (Warning indicator pertaining to incompatible “Memory Stick Duo”)\*

- An incompatible “Memory Stick Duo” is inserted (p. 99).

---

 (Warning indicator pertaining to the write-protect of the “Memory Stick Duo”)\*

- The write-protect tab on the “Memory Stick Duo” is set to lock (p. 100).
- Access to the “Memory Stick Duo” was restricted on another device.

---

 (Warning indicator pertaining to the flash)

**Fast flashing\***

- There is something wrong with the flash.

---

 (Warning indicator pertaining to camera-shake warning)

- The amount of lights is not sufficient, so camera-shake easily occurs. Use the flash.
- The camcorder is unsteady, so camera-shake easily occurs. Hold the camcorder steady with both hands and record the image. However, note that the camera-shake warning indicator does not disappear.

---

 (Warning indicator pertaining to drop sensor)

- The drop sensor function (p. 75) is activated, and has detected that the camcorder has been dropped. Therefore, the camcorder is taking steps to protect the hard disk. Recording/playback may be disabled as a result.
- The drop sensor function does not guarantee the protection of the hard disk under all possible situations. Use the camcorder under stable conditions.

\* You hear a melody when the warning indicators appear on the screen (p. 72).

**Description of warning messages**

If messages appear on the screen, follow the instructions.

**■ Hard disk**

---

 **HDD format error.**

- The hard disk of the camcorder is set differently from the default format. Performing [ FORMAT] (p. 57) may enable you to use your camcorder. This will delete all data in the hard disk.

---

**Data error.**

- An error occurred during reading or writing the hard disk of the camcorder. This may occur when you keep applying shock on the camcorder.

---

**The Image Database File is damaged. Do you want to create a new file?**

**HD movie management information is damaged. Create new information?**

- The image management file is damaged. When you touch [YES], a new image management file is created. The old recorded images on the hard disk of the camcorder cannot be played back (Image files are not damaged). If you execute [REPAIR IMG.DB F.] after creating new information, playing back the old recorded images may become possible. If it does not work, copy the image using the supplied software.

---

**Inconsistencies found in Image Database File. Do you want to repair the Image Database File?**

**The Image Database File is damaged. Do you want to repair the Image Database File?**

**Inconsistencies found in Image Database File. Cannot record or play HD movies. Do you want to repair the Image Database File?**

- The Image Database File is damaged, and you cannot record movies or still images. Touch [YES] to repair.
- You can record still images on a “Memory Stick Duo.”

---

**Buffer overflow**

- You cannot record because the drop sensor senses a drop of the camcorder repeatedly. If you are at risk of dropping the camcorder constantly, set [DROP SENSOR] to [OFF], and you may be able to record the image again (p. 75).

---

**Recovering data**

- Your camcorder tries to recover data automatically if the data writing was not performed properly.

---

**Cannot recover data.**

- Writing data onto the hard disk of the camcorder has failed. Attempts were made to recover the data, but they were unsuccessful.

■ **“Memory Stick Duo”**

---

 **Reinsert the Memory Stick.**

- Reinsert the “Memory Stick Duo” a few times. If even then the indicator flashes, the “Memory Stick Duo” could be damaged. Try with another “Memory Stick Duo.”

---

 **This Memory Stick is not formatted correctly.**

- Check the format, then format the “Memory Stick Duo” with your camcorder if necessary (p. 58, 99).

---

**Memory Stick folders are full.**

- You cannot create folders exceeding 999MSDCF. You cannot create or delete created folders using your camcorder.
- Format the “Memory Stick Duo” (p. 58), or delete them using your computer.

---

**Cannot save still picture.**

- When using the Dual Rec function, do not remove the “Memory Stick Duo” from the camcorder until movie recording is finished and the still images are stored on it (p. 30).

## ■ PictBridge compliant printer

---

### **Not connected to PictBridge compatible printer.**

- Turn off the printer and on again, then remove the USB cable (supplied) and reconnect it.
- 

### **Cannot print. Check the printer.**

- Turn off the printer and on again, then remove the USB cable (supplied) and reconnect it.
- 

## ■ Other

---

### **No further selection is possible.**

- You can select only 100 images at one time for:
    - deleting images
    - copying still images
    - editing the playlist of HD (high definition) movies
    - printing still images
- 

### **Data protected.**

- You tried to delete data protected on another device. Release the protection of the data on the device used to protect the data.

## Using your camcorder abroad

### Power supply

You can use your camcorder in any countries/regions using the AC Adaptor supplied with your camcorder within the AC 100 V to 240 V, 50/60 Hz range.

### Viewing images recorded with HD (high definition) image quality

In countries/regions where 1080/50i is supported, you can view the images with the same HD (high definition) image quality as that of the recorded images. You need a PAL-system-based and 1080/50i compatible TV (or monitor) with component and AUDIO/VIDEO input jacks. Both a component video cable and an A/V connecting cable must be connected.

### Viewing images recorded with SD (standard definition) image quality

To view images recorded with SD (standard definition) image quality, you need a PAL-system-based TV with AUDIO/VIDEO input jacks. An A/V connecting cable must be connected.

### On TV color systems

Your camcorder is a PAL-system-based camcorder. If you want to view the playback image on a TV, it must be a PAL-system-based TV with an AUDIO/VIDEO input jack.

System	Used in
PAL	Australia, Austria, Belgium, China, Czech Republic, Denmark, Finland, Germany, Holland, Hong Kong, Hungary, Italy, Kuwait, Malaysia, New Zealand, Norway, Poland, Portugal, Singapore, Slovak Republic, Spain, Sweden, Switzerland, Thailand, United Kingdom, etc.
PAL - M	Brazil
PAL - N	Argentina, Paraguay, Uruguay.
NTSC	Bahama Islands, Bolivia, Canada, Central America, Chile, Colombia, Ecuador, Guyana, Jamaica, Japan, Korea, Mexico, Peru, Surinam, Taiwan, the Philippines, the U.S.A., Venezuela, etc.
SECAM	Bulgaria, France, Guiana, Iran, Iraq, Monaco, Russia, Ukraine, etc.



## Setting to the local time

You can easily set the clock to the local time by setting a time difference when using your camcorder abroad. Touch **HOME** → **SETTINGS** → **[CLOCK/** **LANG]** → **[AREA SET]** and **[SUMMERTIME]** (p. 74).

## World time difference

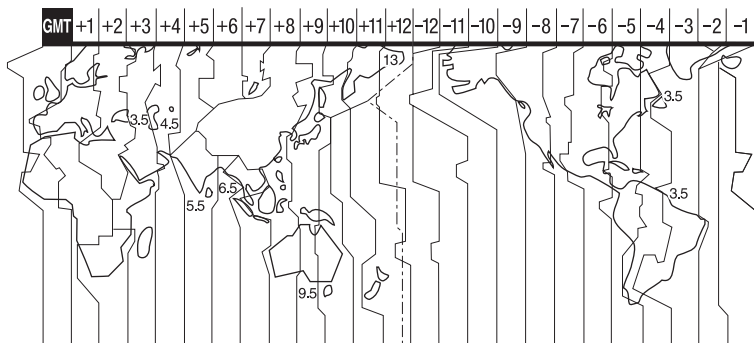

Time-zone differences	Area setting
GMT	Lisbon, London
+01:00	Berlin, Paris
+02:00	Helsinki, Cairo, Istanbul
+03:00	Moscow, Nairobi
+03:30	Tehran
+04:00	Abu Dhabi, Baku
+04:30	Kabul
+05:00	Karachi, Islamabad
+05:30	Calcutta, New Delhi
+06:00	Almaty, Dhaka
+06:30	Rangoon
+07:00	Bangkok, Jakarta
+08:00	HongKong, Singapore, Beijing
+09:00	Seoul, Tokyo
+09:30	Adelaide, Darwin
+10:00	Melbourne, Sydney

Time-zone differences	Area setting
+11:00	Solomon Is
+12:00	Fiji, Wellington
-12:00	Eniwetok, Kwajalein
-11:00	Midway Is., Samoa
-10:00	Hawaii
-09:00	Alaska
-08:00	Los Angeles, Tijuana
-07:00	Denver, Arizona
-06:00	Chicago, Mexico City
-05:00	New York, Bogota
-04:00	Santiago
-03:30	St. John's
-03:00	Brasilia, Montevideo
-02:00	Fernando de Noronha
-01:00	Azores, Cape Verde Is.

# Files on the camcorder hard disk/folder structure

The file/folder structure is shown below. You do not usually need to acknowledge the file/folder structure, when recording/playing back images on the camcorder. To enjoy still images or movies by connecting to a computer, see “Picture Motion Browser Guide,” then use the supplied application.

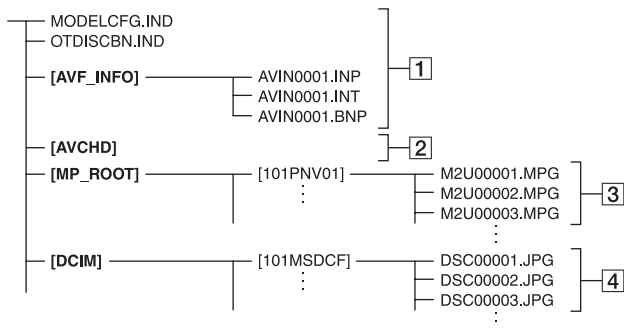

## 1 Image management files

When you delete the files, you cannot record/play back the images correctly. The files are defaulted as hidden files and not usually displayed.

## 2 HD movie management information folder

This folder contains recording data of movies with HD (high definition) image quality. Do not try to open this folder or access the contents of this folder from a computer. Doing so might damage image files, or prevent image files from being played back.

## 3 SD movie files (MPEG2 files)

The extension of the files is “.MPG”. The maximum size is 2 GB. When the capacity of a file exceeds 2 GB, the file becomes divided.

The file numbers go up automatically. When the capacity of a file number exceeds 9999, another folder is created to record new movie files.

The folder name goes up: [101PNV01] → [102PNV01]

## 4 Still image files (JPEG files)

The extension of the files is “.JPG”. The file numbers go up automatically. When the capacity of a file number exceeds 9999, another folder is created to store new image files.

The folder name goes up: [101MSDCF] → [102MSDCF]

- By selecting [COMPUTER] on [USB SELECT] (p. 54), you can access the hard disk of the camcorder from the computer through USB connection.
- Do not modify the files or folders on the camcorder through the computer. The image files may be destroyed or may not be played back.
- Operation is not guaranteed, if you perform the above operation.
- When you delete image files, follow the steps on page 46. Do not delete the image files on the camcorder directly from the computer.
- Do not format the hard disk of the camcorder using the computer. The camcorder may not operate correctly.
- Do not copy the files on the hard disk of the camcorder from the computer. Operation is not guaranteed.

# Maintenance and precautions

## About the AVCHD format

Your digital video camera recorder incorporates both the AVCHD format and the MPEG2 format for the recording function.

### What is the AVCHD format?

The AVCHD format is a high definition digital video camera format used to record an HD (high definition) signal of either the 1080i specification\*<sup>1</sup> or the 720p specification\*<sup>2</sup> on internal hard disk drive, using efficient data compression coding technology. The MPEG-4 AVC/H.264 format is adopted to compress video data, and the Dolby Digital or Linear PCM system is used to compress audio data.

The MPEG-4 AVC/H.264 format is capable of compressing images at higher efficiency than that of the conventional image compressing format. The MPEG-4 AVC/H.264 format enables a high definition video signal shot on a digital video camera recorder to be recorded on 8 cm DVD discs, internal hard disk drive, flash memory, etc.

### Recording and playback on your camcorder

Based on the AVCHD format, your camcorder records with the HD (high definition) image quality mentioned below. In addition to HD (high definition) image quality, your camcorder is capable of recording an SD (standard definition) signal in the conventional MPEG2 format.

#### Video signal:

AVCHD format 1440 × 1080/50i\*<sup>3</sup>

#### Audio signal:

Dolby Digital 5.1 ch

#### Recording media:

Internal hard disk drive

\*1: 1080i specification

A high definition specification which utilizes 1,080 effective scanning lines and the interlace system.

\*2: 720p specification

A high definition specification which utilizes 720 effective scanning lines and the progressive system.

\*3: Data recorded in AVCHD format other than the above mentioned cannot be played on your camcorder.

## About the “Memory Stick”

A “Memory Stick” is a compact, portable IC recording medium with a large data capacity.

You can use only a “Memory Stick Duo,” which is about the half size of a standard “Memory Stick,” with your camcorder. However, we do not guarantee the operation of all types of “Memory Stick Duo” on your camcorder. (See the list below for more details.)

Types of “Memory Stick”	Recording/ Playback
“Memory Stick Duo” <sup>*1</sup> (without MagicGate)	○
“Memory Stick Duo” <sup>*1</sup> (with MagicGate)	○ <sup>*2*</sup>
“MagicGate Memory Stick Duo” <sup>*1</sup>	○ <sup>*3</sup>
“Memory Stick PRO Duo” <sup>*1</sup>	○ <sup>*2*</sup>

\*1 A “Memory Stick Duo” is about half the size of a standard “Memory Stick.”

\*2 The types of “Memory Stick” that support high speed data transfer. The speed of data transfer varies depending on the device to be used.

\*3 “MagicGate” is a copyright protection technology that records and transfers the contents in an encrypted format. Note that data that uses “MagicGate” technology cannot be recorded or played on your camcorder.

- This product is compatible with “Memory Stick Micro” (“M2”). “M2” is the abbreviation for the “Memory Stick Micro.”
- Still image format: Your camcorder compresses and records image data in the JPEG (Joint

Photographic Experts Group) format. The file extension is “.JPG.”

- File names of still images:
  - 101- 0001: This file name appears on the screen of your camcorder.
  - DSC00001.JPG: This file name appears on the display of a computer.
- A “Memory Stick Duo” formatted by a computer (Windows OS/Mac OS) does not have guaranteed compatibility with your camcorder.
- Data read/write speed may vary depending on the combination of the “Memory Stick” and “Memory Stick” compliant product you use.

## On a “Memory Stick Duo” with a write-protect tab

You can prevent accidental erasure of images when you slide the write-protect tab on the “Memory Stick Duo” with a small tapered object, to the write-protect position.

## Notes on use

Damaged or lost data may occur in the following cases (the data will not be compensated for):

- If you eject the “Memory Stick Duo,” or remove the battery pack for replacement while your camcorder is reading or writing image files on the “Memory Stick Duo” (while the access lamp is lit or flashing).
- If you use the “Memory Stick Duo” near magnets or magnetic fields.

It is recommended you make a back-up of important data on the hard disk of a computer.

### ■ On handling a “Memory Stick”

Keep the following in mind when handling a “Memory Stick Duo.”

- Be careful not to apply excessive force when writing on a memo area on a “Memory Stick Duo.”
- Do not attach a label or the like on a “Memory Stick Duo” or a Memory Stick Duo adaptor.
- When you carry or store a “Memory Stick Duo,” put it in its case.
- Do not touch, or allow metallic objects to come into contact with the terminals.

- Do not bend, drop or apply strong force to the “Memory Stick Duo.”
- Do not disassemble or modify the “Memory Stick Duo.”
- Do not let the “Memory Stick Duo” get wet.
- Be careful to keep “Memory Stick Duo” media out of the reach of small children. There is danger that a child might swallow it.
- Do not insert anything other than a “Memory Stick Duo” into the Memory Stick Duo slot. Doing so may cause a malfunction.

### ■ On a location for use

Do not use or keep the “Memory Stick Duo” in the following locations:

- Places subject to extremely high temperature, such as a car parked outside in the summer.
- Places under direct sunlight.
- Places with extremely high humidity or subject to corrosive gases.

### ■ On the Memory Stick Duo adaptor

After inserting a “Memory Stick Duo” into the Memory Stick Duo adaptor, you can use it with a standard “Memory Stick” compliant device.

- When using a “Memory Stick Duo” with a “Memory Stick” compliant device, be sure to insert the “Memory Stick Duo” into a Memory Stick Duo adaptor.
- When inserting a “Memory Stick Duo” into a Memory Stick Duo adaptor, make sure the “Memory Stick Duo” is inserted facing in the correct direction, then insert it all the way in. Note that improper use may cause a malfunction. Also, if you force the “Memory Stick Duo” into the Memory Stick Duo adaptor in the wrong direction, it may be damaged.
- Do not insert a Memory Stick Duo adaptor without a “Memory Stick Duo” attached. Doing so may result in malfunctions of the unit.

### ■ On a “Memory Stick PRO Duo”

The maximum memory capacity of a “Memory Stick PRO Duo” that can be used on your camcorder is 8 GB.

## Notes on using “Memory Stick Micro” (optional)

- To use a “Memory Stick Micro” with this camcorder, you need a Duo-sized M2 Adaptor. Insert the “Memory Stick Micro” into the Duo-sized M2 Adaptor, and then insert the adaptor into the Memory Stick Duo slot. If you insert a “Memory Stick Micro” into this camcorder without using a Duo-sized M2 Adaptor, you might not be able to remove it from the camcorder.
- Do not leave the “Memory Stick Micro” within the reach of small children. They might accidentally swallow it.

## On image data compatibility

- Image data files recorded on a “Memory Stick Duo” by your camcorder conform to the “Design rule for Camera File system” universal standard established by the JEITA (Japan Electronics and Information Technology Industries Association).
- On your camcorder, you cannot play back still images recorded on other devices (DCR-TRV900E or DSC-D700/D770) that do not conform to the universal standard. (These models are not sold in some regions.)
- If you cannot use a “Memory Stick Duo” that has been used with another device, format it with your camcorder (p. 58). Note that formatting erases all information on the “Memory Stick Duo.”
- You may not be able to play back images with your camcorder:
  - When playing back image data modified on your computer.
  - When playing back image data recorded with other devices.

## About the “InfoLITHIUM” battery pack

Your camcorder operates only with an “InfoLITHIUM” battery pack (H series). “InfoLITHIUM” H series battery packs have the  mark.

## What is an “InfoLITHIUM” battery pack?

An “InfoLITHIUM” battery pack is a lithium-ion battery pack that has functions for communicating information related to operating conditions between your camcorder and an optional AC Adaptor/charger.

The “InfoLITHIUM” battery pack calculates the power consumption according to the operating conditions of your camcorder, and displays the remaining battery time in minutes.

With an AC Adaptor/charger, the remaining battery time and charging time appear.

## To charge the battery pack

- Be sure to charge the battery pack before you start using your camcorder.
- We recommend charging the battery pack in an ambient temperature of between 10 °C to 30 °C (50 °F to 86 °F) until the  /CHG (charge) lamp turns off. If you charge the battery pack outside of this temperature range, you may not be able to charge it efficiently.

## To use the battery pack effectively



- Battery pack performance decreases when the surrounding temperature is 10 °C (50 °F) or below, and the length of time you can use the battery pack becomes shorter. In that case, do one of the following to use the battery pack for a longer time.
  - Put the battery pack in a pocket to warm it up, and insert it in your camcorder right before you start taking shots.
  - Use a large capacity battery pack: NP-FH70/ FH100 (optional).
- Frequent use of the LCD screen or a frequent playback, fast forward or rewind operation wears out the battery pack faster. We recommend using a large capacity battery pack: NP-FH70/FH100 (optional).
- Be sure to set the POWER switch to OFF (CHG) when not recording or playing back on your camcorder. The battery pack is also consumed when your camcorder is in recording standby or playback pause.

- Have spare battery packs ready for two or three times the expected recording time, and make trial recordings before making the actual recording.
- Do not expose the battery pack to water. The battery pack is not water resistant.

## About the remaining battery time indicator

- When the power goes off even though the remaining battery time indicator indicates that the battery pack has enough power to operate, charge the battery pack fully again. Remaining battery time will be indicated correctly. Note, however, that the battery indication will not be restored if it is used in high temperatures for a long time, or if left in a fully charged state, or when the battery pack is frequently used. Use the remaining battery time indication as a rough guide only.
- The  mark that indicates low battery flashes even if there are still 5 to 10 minutes of battery time remaining, depending on the operating conditions or ambient temperature.

## About storage of the battery pack

- If the battery pack is not used for a long time, fully charge the battery pack and use it up on your camcorder once a year to maintain proper function. To store the battery pack, remove it from your camcorder and put it in a dry, cool place.
- To discharge the battery pack on your camcorder completely, touch  (HOME) →  (SETTINGS) → [GENERAL SET] → [A.SHUT OFF] → [NEVER] on the HOME MENU and leave your camcorder in recording standby until the power goes off (p. 75).

## About battery life

- Battery capacity decreases over time and through repeated use. If decreased usage time between charges becomes significant, it is probably time to replace it with a new one.
- Each battery's life is governed by storage, operating and environmental conditions.

## About x.v.Color

- x.v.Color is a more familiar term for the xvYCC standard proposed by Sony, and is a trademark of Sony.
- xvYCC is an international standard for color space in video. This standard can express a wider color range than the currently used broadcast standard.

## About handling of your camcorder

### On use and care

- Do not use or store the camcorder and accessories in the following locations:
  - Anywhere extremely hot, cold or humid. Never leave them exposed to temperatures above 60 °C (140 °F), such as under direct sunlight, near heaters or in a car parked in the sun. They may malfunction or become deformed.
  - Near strong magnetic fields or mechanical vibration. The camcorder may malfunction.
  - Near strong radio waves or radiation. The camcorder may not be able to record properly.
  - Near AM receivers and video equipment. Noise may occur.
  - On a sandy beach or anywhere dusty. If sand or dust gets in your camcorder, it may malfunction. Sometimes this malfunction cannot be repaired.
  - Near windows or outdoors, where the LCD screen, the viewfinder (HDR-SR7E/SR8E), or the lens may be exposed to direct sunlight. This damages the inside of the viewfinder (HDR-SR7E/SR8E) or the LCD screen.
- Operate your camcorder on DC 6.8 V/7.2 V (battery pack) or DC 8.4 V (AC Adaptor).
- For DC or AC operation, use the accessories recommended in these operating instructions.
- Do not let your camcorder get wet, for example, from rain or sea water. If your camcorder gets wet, it may malfunction. Sometimes this malfunction cannot be repaired.
- If any solid object or liquid gets inside the casing, unplug your camcorder and have it checked by a Sony dealer before operating it any further.

- Avoid rough handling, disassembling, modifying, physical shock, or impact such as hammering, dropping or stepping on the product. Be particularly careful of the lens.
- Keep the POWER switch setting to OFF (CHG) when you are not using your camcorder.
- Do not wrap your camcorder with a towel, for example, and operate it. Doing so might cause heat to build up inside.
- When disconnecting the mains lead, pull it by the plug and not the lead.
- Do not damage the mains lead such as by placing anything heavy on it.
- Keep metal contacts clean.
- Keep the Remote Commander and button-type battery out of children's reach. If the battery is accidentally swallowed, consult a doctor immediately.
- If the battery electrolytic liquid has leaked:
  - consult your local authorized Sony service facility.
  - wash off any liquid that may have contacted your skin.
  - if any liquid gets in your eyes, wash with plenty of water and consult a doctor.

### ■ When not using your camcorder for a long time

- Periodically turn it on and let it run such as by playing back or recording images for about 3 minutes.
- Use up the battery pack completely before storing it.

## Moisture condensation

If your camcorder is brought directly from a cold place to a warm place, moisture may condense inside your camcorder. This may cause a malfunction to your camcorder.

### ■ If moisture condensation has occurred

Leave your camcorder for about 1 hour without turning it on.

### ■ Note on moisture condensation

Moisture may condense when you bring your camcorder from a cold place into a warm place (or vice versa) or when you use your camcorder in a humid place as follows:

- You bring your camcorder from a ski slope into a place warmed up by a heating device.
- You bring your camcorder from an air conditioned car or room into a hot place outside.
- You use your camcorder after a squall or a shower.
- You use your camcorder in a hot and humid place.

### ■ How to prevent moisture condensation

When you bring your camcorder from a cold place into a warm place, put your camcorder in a plastic bag and seal it tightly. Remove the bag when the air temperature inside the plastic bag has reached the surrounding temperature (after about 1 hour).

## LCD screen

- Do not exert excessive pressure on the LCD screen, as it may cause damage.
- If your camcorder is used in a cold place, a residual image may appear on the LCD screen. This is not a malfunction.
- While using your camcorder, the back of the LCD screen may heat up. This is not a malfunction.



### ■ To clean the LCD screen

If fingerprints or dust make the LCD screen dirty, it is recommended you use a soft cloth to clean it. When you use the LCD Cleaning Kit (optional), do not apply the cleaning liquid directly to the LCD screen. Use cleaning paper moistened with the liquid.

### ■ On adjustment of the touch panel (CALIBRATION)

The buttons on the touch panel may not work correctly. If this happens, follow the procedure below. It is recommended that you connect your camcorder to the wall socket using the supplied AC Adaptor during the operation.

- ① Turn on your camcorder.

- ② Touch  (HOME) →  (SETTINGS)  
→ [GENERAL SET] →  
[CALIBRATION].

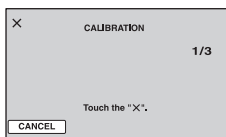

- ③ Touch “x” displayed on the screen with the corner of the “Memory Stick Duo” or the like 3 times.  
Touch [CANCEL] to cancel.

If you did not press the right spot, try the calibration again.

#### Notes

- Do not use a sharp-pointed object for calibration. Doing so may damage the LCD screen.
- You cannot calibrate the LCD screen if it is rotated, or closed with the screen facing out.

### On handling the casing

- If the casing is soiled, clean the camcorder body with a soft cloth lightly moistened with water, and then wipe the casing with a dry soft cloth.
- Avoid the following to avoid damage to the finish:
  - Using chemicals such as thinner, benzine, alcohol, chemical cloths, repellent, insecticide and sunscreen.
  - Handling the camcorder with above substances on your hands.
  - Leaving the casing in contact with rubber or vinyl objects for a long period of time.

### About care and storage of the lens

- Wipe the surface of the lens clean with a soft cloth in the following instances:
  - When there are fingerprints on the lens surface.
  - In hot or humid locations
  - When the lens is exposed to salty air such as at the seaside.
- Store in a well-ventilated location subject to little dirt or dust.

- To prevent mold, periodically clean the lens as described above. It is recommended that you operate your camcorder about once a month to keep it in optimum state for a long time.

### On charging the pre-installed rechargeable battery

Your camcorder has a pre-installed rechargeable battery to retain the date, time, and other settings even when the POWER switch is set to OFF (CHG). The pre-installed rechargeable battery is always charged while your camcorder is connected to the wall socket via the AC Adaptor or while the battery pack is attached. The rechargeable battery will be fully discharged in about **3 months** if you do not use your camcorder at all. Use your camcorder after charging the pre-installed rechargeable battery. However, even if the pre-installed rechargeable battery is not charged, the camcorder operation will not be affected as long as you are not recording the date.

#### Procedures

Connect your camcorder to a wall socket using the supplied AC Adaptor, and leave it with the POWER switch set to OFF (CHG) for more than 24 hours.



## On trademarks

- “Handycam” and **HANDYCAM** are registered trademarks of Sony Corporation.
- “AVCHD” and “AVCHD” logotype are trademarks of Matsushita Electric Industrial Co., Ltd. and Sony Corporation.
- “Memory Stick,”  “Memory Stick Duo,” “**MEMORY STICK DUO**,” “Memory Stick PRO Duo,” “**MEMORY STICK PRO DUO**,” “Memory Stick Micro,” “MagicGate,” “**MAGICGATE**,” “MagicGate Memory Stick” and “MagicGate Memory Stick Duo” are trademarks of Sony Corporation.
- “InfoLITHIUM” is a trademark of Sony Corporation.
- “x.v.Colour” is a trademark of Sony Corporation.
- Dolby and the double-D symbol are trademarks of Dolby Laboratories.
- Dolby Digital 5.1 Creator is a trademark of Dolby Laboratories.
- HDMI, the HDMI logo and High-Definition Multimedia Interface are trademarks or registered trademarks of HDMI Licensing LLC.
- Microsoft, Windows, Windows Media, Windows Vista, and DirectX are either registered trademarks or trademarks of Microsoft Corporation in the United States and/or other countries.
- Macintosh is a trademark of Apple Inc. in the U.S. and other countries.
- Intel, Intel Core, and Pentium are trademarks or registered trademarks of Intel Corporation or its subsidiaries in the United States and other countries.
- Adobe, the Adobe logo, and Adobe Acrobat are either registered trademarks or trademarks of Adobe Systems Incorporated in the United States and/or other countries.

All other product names mentioned herein may be the trademarks or registered trademarks of their respective companies. Furthermore, <sup>TM</sup> and <sup>®</sup> are not mentioned in each case in this Handbook.

## Notes on the License

ANY USE OF THIS PRODUCT OTHER THAN CONSUMER PERSONAL USE IN ANY MANNER THAT COMPLIES WITH THE MPEG-2 STANDARD FOR ENCODING VIDEO INFORMATION FOR PACKAGED MEDIA IS EXPRESSLY PROHIBITED WITHOUT A LICENSE UNDER APPLICABLE PATENTS IN THE MPEG-2 PATENT PORTFOLIO, WHICH LICENSE IS AVAILABLE FROM MPEG LA, L.L.C., 250 STEELE STREET, SUITE 300, DENVER, COLORADO 80206.

THIS PRODUCT IS LICENSED UNDER THE AVC PATENT PORTFOLIO LICENSE FOR THE PERSONAL AND NON-COMMERCIAL USE OF A CONSUMER TO

(i) ENCODE VIDEO IN COMPLIANCE WITH THE AVC STANDARD (“AVC VIDEO”) AND / OR

(ii) DECODE AVC VIDEO THAT WAS ENCODED BY A CONSUMER ENGAGED IN A PERSONAL AND NON-COMMERCIAL ACTIVITY AND/OR WAS OBTAINED FROM A VIDEO PROVIDER LICENSED TO PROVIDE AVC VIDEO. NO LICENSE IS GRANTED OR SHALL BE IMPLIED FOR ANY OTHER USE. ADDITIONAL INFORMATION MAY BE OBTAINED FROM MPEG LA, L.L.C. SEE <[HTTP://MPEGLA.COM](http://MPEGLA.COM)>

“C Library,” “Expat,” “zlib,” and “libjpeg” software are provided in your camcorder. We provide this software based on license agreements with their owners of copyright. Based on requests by the owners of copyright of these software applications, we have an obligation to inform you of the following. Please read the following sections.

Read “license1.pdf” in the “License” folder on the CD-ROM. You will find licenses (in English) of “C Library,” “Expat,” “zlib,” and “libjpeg” software.

## **On GNU GPL/LGPL applied software**

The software that is eligible for the following GNU General Public License (hereinafter referred to as “GPL”) or GNU Lesser General Public License (hereinafter referred to as “LGPL”) are included in the camcorder.

This informs you that you have a right to have access to, modify, and redistribute source code for these software programs under the conditions of the supplied GPL/LGPL.

Source code is provided on the web. Use the following URL to download it. When downloading the source code, select HDR-SR7 as the model for your camcorder.

<http://www.sony.net/Products/Linux/>

We would prefer you do not contact us about the contents of source code.

Read “license2.pdf” in the “License” folder on the CD-ROM. You will find licenses (in English) of “GPL,” and “LGPL” software.

To view the PDF, Adobe Reader is needed. If it is not installed on your computer, you can download it from the Adobe Systems web page:

<http://www.adobe.com/>

# Identifying parts and controls

The numbers in ( ) are reference pages.

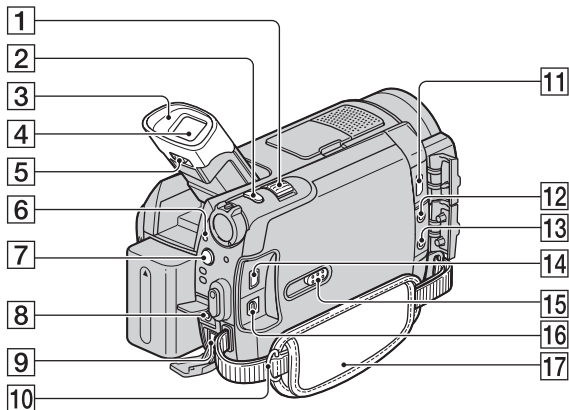

- 1** Power zoom lever (29, 37)
- 2** PHOTO button (28)
- 3** Eyecup (HDR-SR7E/SR8E)
- 4** Viewfinder (22)  
(HDR-SR7E/SR8E)
- 5** Viewfinder lens adjustment lever (22)  
(HDR-SR7E/SR8E)
- 6** ACCESS lamp (Hard disk) (27)
- 7** ⚡ (flash) button (30)
- 8** REMOTE jack
- 9** DC IN jack (16)
- 10** Hook for a shoulder belt  
Attach a shoulder belt (optional).
- 11** HDMI OUT (mini) jack (41)
- 12** MIC (PLUG IN POWER) jack (HDR-SR7E/SR8E)  
When an external microphone (optional) is connected, it takes precedence over the internal microphone (p. 110).
- 13** 🎧 (headphones) jack (HDR-SR7E/SR8E)
- 14** COMPONENT OUT jack (41)
- 15** JACK COVER OPEN/CLOSE knob (107)
- 16** A/V OUT jack (41)
- 17** Grip belt (22)

## To open the jack cover

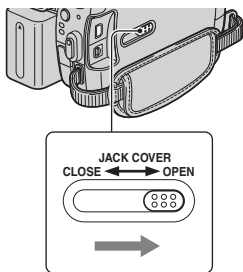

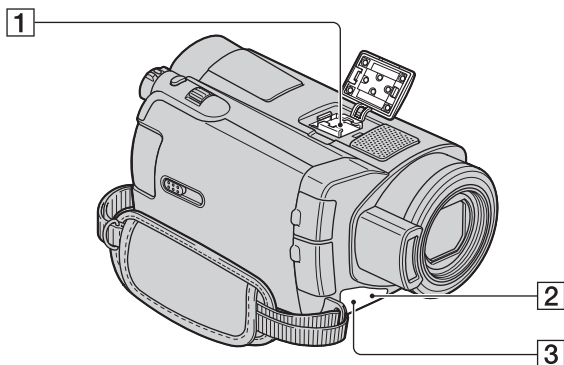

**1** Active Interface Shoe Active Interface Shoe

The Active Interface Shoe supplies power to optional accessories such as a video light, a flash, or a microphone. The accessory can be turned on or off as you operate the POWER switch on your camcorder. Refer to the operating instructions supplied with your accessory for details.





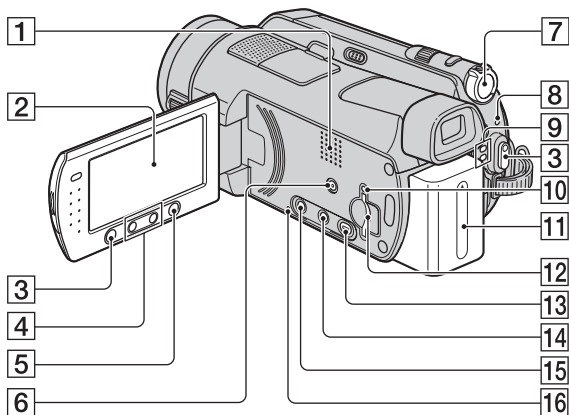

The Active Interface Shoe has a safety device for fixing the installed accessory securely. To connect an accessory, press down and push it to the end, and then tighten the screw. To remove an accessory, loosen the screw, and then press down and pull out the accessory.

- When you are recording movies with an external flash (optional) connected to the accessory shoe, turn off the power of the external flash to prevent charging noise being recorded.
- You cannot use an external flash (optional) and the built-in flash at the same time.
- When an external microphone (optional) is connected, it takes precedence over the internal microphone (p. 110).

**2** Remote sensor/Infrared port  
Point the Remote Commander (p. 111) towards the remote sensor to operate your camcorder.

**3** Camera recording lamp (75)  
Lights up in red during recording. Flashes when remaining hard disk space or battery power is low.



- 1** Speaker  
Playback sounds come out from the speaker. For how to adjust the volume, see page 36.
- 2** LCD screen/touch panel (21)
- 3** START/STOP button (28)
- 4** Zoom buttons (29, 37)
- 5**  (HOME) button (13, 61)
- 6** EASY button (23)
- 7** POWER switch (20)
- 8** /CHG (charge) lamp (16)
- 9**  (Movie)/ (Still) mode lamps (20)
- 10** Access lamp (“Memory Stick Duo”) (31)
- 11** Battery pack (16)
- 12** Memory Stick Duo slot (31)
- 13**  (VIEW IMAGES) button (34)
- 14**  (Film Roll Index) button (35)
- 15** DISP/BATT INFO button (17, 21)
- 16** RESET button  
Initializes all the settings, including the setting of the date and time.

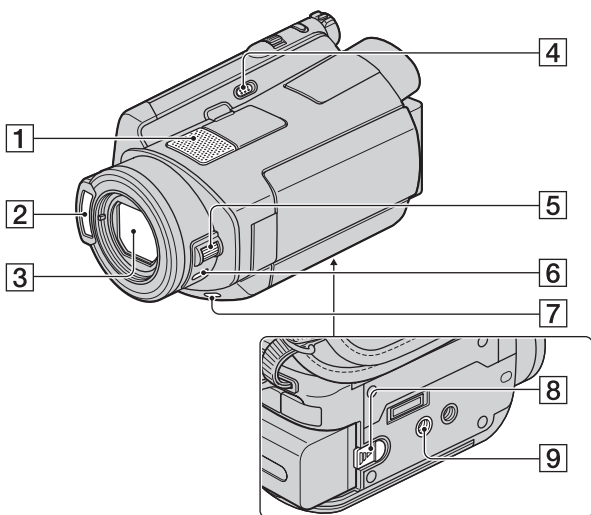

- 1** Internal microphone (29)  
An Active Interface Shoe compatible microphone (optional) will take precedence when connected.
- 2** Flash (30)
- 3** Lens (Carl Zeiss Lens) (4)
- 4** NIGHTSHOT switch (31)
- 5** CAM CTRL dial (33)  
(HDR-SR7E/SR8E)
- 6** MANUAL button (33)  
(HDR-SR7E/SR8E)
- 7** BACK LIGHT button (32)
- 8** BATT (battery release) lever (17)
- 9** Tripod receptacle  
Attach the tripod (optional: the length of the screw must be less than 5.5 mm (7/32 in.)) to the tripod receptacle using a tripod screw.

### Handycam Station

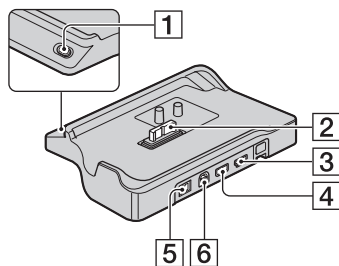

- 1** DISC BURN button (45)
- 2** Interface connector
- 3**  $\Psi$  (USB) jack (54)
- 4** COMPONENT OUT jack (41)
- 5** DC IN jack (16)
- 6** A/V OUT jack (41)

## Remote Commander

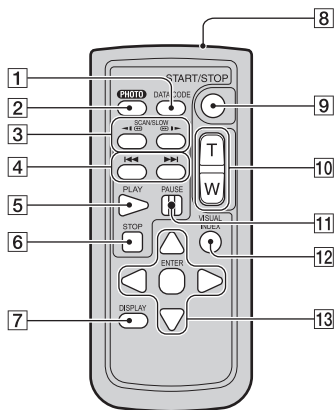

- 1 DATA CODE button (70)  
Displays the date and time or camera setting data of the recorded images when you press this during playback.
- 2 PHOTO button (28)  
The on-screen image when you press this button will be recorded as a still image.
- 3 SCAN/SLOW buttons (36)
- 4 ◀▶ (Previous/Next) buttons (36)
- 5 PLAY button (36)
- 6 STOP button (36)
- 7 DISPLAY button (17)
- 8 Transmitter
- 9 START/STOP button (28)
- 10 Power zoom buttons (29, 37)
- 11 PAUSE buttons (36)
- 12 VISUAL INDEX button (34)  
Displays a VISUAL INDEX screen during playback.
- 13 ◀/▶/▲/▼/ENTER buttons  
When you press any button on the [VISUAL INDEX]/[INDEX]/[INDEX]/Playlist screen, the orange frame appears on the LCD screen. Select a desired button or an item with ◀/▶/▲/▼, then press ENTER to enter.

## Notes

- Remove the insulation sheet before using the Remote Commander.

### Insulation sheet

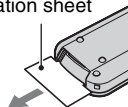

- Point the Remote Commander towards the remote sensor to operate your camcorder (p. 108).
- When no commands have been sent from the Remote Commander in a certain period, the orange frame disappears. When you press any of ◀/▶/▲/▼, or ENTER again, the frame appears at the position where it was displayed last.
- You cannot select some buttons on the LCD screen using ◀/▶/▲/▼.

## To change the battery of the Remote Commander

- ① While pressing on the tab, inset your fingernail into the slit to pull out the battery case.
- ② Place a new battery with the + side facing up.
- ③ Insert the battery case back into the Remote Commander until it clicks.

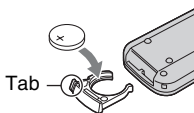

## WARNING

Battery may explode if mistreated. Do not recharge, disassemble or dispose of in fire.

- When the lithium battery becomes weak, the operating distance of the Remote Commander may shorten, or the Remote Commander may not function properly. In this case, replace the battery with a Sony CR2025 lithium battery. Use of another battery may present a risk of fire or explosion.

# Indicators displayed during recording/playback

## Recording movies

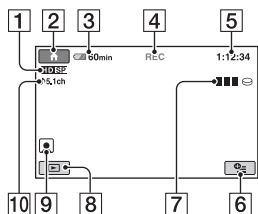

- 1 Recording quality (HD/SD) (63) and recording mode (XP/HQ/SP/LP) (63)
- 2 HOME button (13)
- 3 Remaining battery (approx.) (17)
- 4 Recording status ([STBY] (standby) or [REC] (recording))
- 5 Counter (hour/minute/second)
- 6 OPTION button (14)
- 7 Dual Rec (30)

## Recording still images

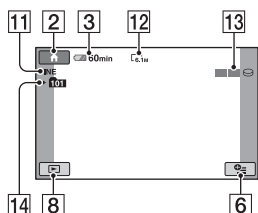

- 8 VIEW IMAGES button
- 9 Face Index set (67)
- 10 5.1ch surround recording (29)
- 11 Quality ([FINE] / [STD]) (68)
- 12 Image size (67)
- 13 Appears while a still image is being saved.
- 14 Recording folder ("Memory Stick Duo")

## Viewing movies

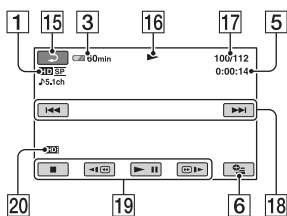

### 💡 Tips

- As the number of still images recorded on a "Memory Stick Duo" increases, new folders are automatically created to store them.
- During Dual Rec, indicators for both movie recording and still image recording appear at the same time. The place indicators appear slightly differs from during usual operations.

## Viewing still images

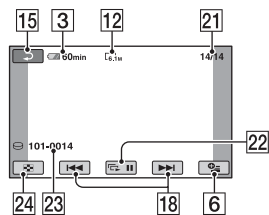

- 15 Return button
- 16 Playback mode
- 17 Current playing movie number/Number of total recorded movies
- 18 Previous/Next button (36)
- 19 Video operation buttons (36)
- 20 Playing back image quality
- 21 Current playing still image number/ Number of total recorded still images
- 22 Slide show button (38)
- 23 Data file name
- 24 VISUAL INDEX button (34)



## Indicators when you made changes

Following indicators appear during recording/playback to indicate the settings of your camcorder.

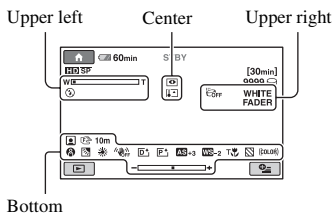

### Upper left

Indicator	Meaning
	5.1ch surround recording/playback (29)
	Self-timer recording (83)
	Flash light (30), REDEYE REDUC (66)
	MICREF LEVEL low (82)
	WIDE SELECT (65)

### Center

Indicator	Meaning
	Slide show set (38)
	NightShot (31)
	Super NightShot (82)
	Color Slow Shutter (81)
	PictBridge connecting (54)
	Warning (92)

### Upper right

Indicator	Meaning
WHITE FADER BLACK FADER	Fader (82)

Indicator	Meaning
	LCD backlight off (21)
	Drop sensor off (75)
	Drop sensor activated (75)

### Bottom

Indicator	Meaning
	Picture effect (82)
	Digital effect (82)
	Manual focus (78)
	SCENE SELECTION (80)
	Backlight (32)
	White balance (81)
	SteadyShot off (65)
	SPOT METER (79)/EXPOSURE (79)
	AE SHIFT* (64)
	WB SHIFT* (64)
	Tele macro (79)
	Zebra (66)
	X.V.COLOR (65)
	Face Index set (67)

\* HDR-SR7E/SR8E

## Data code during recording

The recording date and time is recorded automatically on the hard disk and "Memory Stick Duo." They are not displayed while recording. However, you can check them as [DATA CODE] during playback (p. 70).

# Glossary

## ■ 5.1ch surround sound

A system that plays back sound on 6 speakers, 3 at the front (left, right and center) and 2 at the rear (right and left) with an additional low-pass subwoofer counted as a 0.1 channel for frequencies of 120 Hz or lower.

## ■ AVCHD format

A high definition digital video camera format used to record an HD (high definition) signal using the MPEG-4 AVC/H.264 format.

## ■ JPEG

JPEG stands for Joint Photographic Experts Group, a still image data compression (data capacity reduction) standard. Your camcorder records still images in JPEG format.

## ■ MPEG

MPEG stands for Moving Picture Experts Group, the group of standards for the coding (image compression) of video (movie) and audio. There are MPEG1 and MPEG2 formats. Your camcorder records movies with SD (standard definition) image quality in MPEG2 format.



## ■ MPEG-4 AVC/H.264

The latest image coding format standardized jointly by two international standardization organizations, the ISO-IEC and the ITU-T, in 2003. Compared with the conventional MPEG2 format, MPEG-4 AVC/H.264 has more than twice the efficiency. Your camcorder employs MPEG-4 AVC/H.264 to encode high definition movies.

## ■ VBR

VBR stands for Variable Bit Rate, the recording format for automatically controlling the bit rate (the volume of recording data in a given time segment) according to the scene being recorded. For fast-moving video, a lot of hard disk space is used to produce a clear image, so the recording time to the hard disk shortens.

## ■ Thumbnail

Reduced-size images which enable you to view many images at the same time. [VISUAL INDEX]/[ INDEX]/[ INDEX] are thumbnail display system.

## ■ Dolby Digital

An audio encoding (compression) system developed by Dolby Laboratories Inc.

## ■ Dolby Digital 5.1 Creator

Sound compression technology developed by Dolby Laboratories Inc. which compresses audio efficiently while preserving high sound quality. Sounds are compressed effectively with high quality sound, and it enables producing 5.1ch surround sound.

## ■ Fragmentation

The condition of a hard disk in which files are divided into pieces scattered around the hard disk. You may not save your images correctly. You can solve the condition by performing [⊖FORMAT] (p. 57).

# Index

## Numeric

1080i/576i .....	74
16:9 .....	73
16:9 WIDE.....	65
21-pin adaptor.....	44
4:3 .....	65, 73
4:3 TV .....	42
576i .....	74
5.1ch surround recording.....	29

## A

AC Adaptor.....	16
ADD by date.....	51
Adjusting exposure for back light.....	32, 88
AE SHIFT .....	64, 91
AREA SET .....	74
AUTO SLW SHUTTR (Auto Slow Shutter).....	65, 91
AVCHD format .....	111, 99, 114
A.SHUT OFF (Auto shut off).....	75
A/V connecting cable .....	41, 53
A/V OUT jack.....	41, 53

## B

Backup .....	See Saving images
Battery pack .....	16
BEACH.....	80
BEEP .....	72
BLACK FADER.....	82
Button-type lithium battery .....	111
B&W (Black and white).....	82

## C

CALIBRATION .....	103
CAM CTRL dial .....	33
CAMERA DATA .....	70
CANDLE .....	80

Charging the battery.....	16
Battery pack .....	16
Pre-installed rechargeable battery .....	104
Charging time.....	18
CLOCK SET .....	20
CLOCK/LANG .....	74
COLOR SLOW SHTR (Color Slow Shutter).....	81, 90
COMPONENT.....	74
COMPONENT OUT jack.....	41
Component video cable.....	41
Computer.....	45
Connection	
4:3 TV .....	42
DVD/HDD recorders .....	53
High definition TV.....	41
Printer.....	54
VCR.....	53
Wide TV .....	42
COPY by date .....	50

## D

DATA CODE.....	70, 113
Date Index .....	37
DATE/TIME .....	70, 113
DC IN jack .....	16
DC plug.....	16
DELETE	
DELETE by date.....	47
Hard disk.....	46
“Memory Stick Duo”.....	47
DEMO MODE .....	75
DIAL SETTING .....	67
DIGITAL ZOOM.....	65
DISP OUTPUT .....	74
DISPLAY .....	71
Display indicators .....	112
DIVIDE.....	48
Dolby Digital 5.1 Creator.....	29
DROP SENSOR.....	75

Dual Rec .....	30
Dubbing .....	53
D.EFFECT (Digital effect) .....	82, 91

## E

Editing .....	46
EMPTY .....	60
EXPOSURE .....	79, 90

## F

Face Index .....	37
Face Index set.....	67
FADER .....	82, 91
File .....	98
FILE NO. (File number).....	69
Film Roll Index.....	35
Film roll INTERVAL SET .....	71
FINE .....	68
FIREWORKS .....	80
Flash .....	87
FLASH LEVEL.....	66
FOCUS .....	78, 88
Folder.....	98
FORMAT	
Hard disk .....	57
“Memory Stick Duo” .....	58
Fragmentation .....	114
Full charge .....	16

## G

GENERAL SET .....	75
Grip belt.....	22
GUIDEFRAAME.....	65

## H

Handycam Station .....	16
Hard disk .....	5, 98
HD movie management file .....	98

HD QUALITY .....	63
HD REC MODE.....	63
HD (high definition) image quality.....	9
HDD INFO.....	58
HDMI cable.....	42
HDMI OUT jack .....	41
Help .....	13
High altitudes .....	5
High Definition TV .....	41
Holding the camcorder .....	27
HOME MENU .....	12, 61
CLOCK/LANG .....	74
GENERAL SET .....	75
MOVIE SETTINGS.....	63
OUTPUT SETTINGS .....	73
PHOTO SETTINGS.....	67
SETTINGS category .....	61
SOUND/DISP SET .....	72
VIEW IMAGES SET .....	70
HQ .....	63, 64

## I

Icon.....	See Display indicators
Image management files.....	98
Image quality	
Movie .....	63
Still image .....	68
IMAGE SIZE .....	67
Index screen display button .....	112
INDEX SET .....	70
Indicators .....	113
INDOOR .....	81
“InfoLITHIUM” battery pack .....	101

## J

JPEG.....	98, 99, 114
-----------	-------------

## L

LANDSCAPE.....	80
LANGUAGE SET .....	74
LCD BL LEVEL (LCD back light level).....	72
LCD BRIGHT.....	72
LCD COLOR.....	72
LCD panel.....	21
LCD BL LEVEL .....	72
LCD BRIGHT .....	72
LCD COLOR.....	72
LCD screen .....	21
LP.....	64

## M

Mains lead.....	16
Maintenance.....	99
MANAGE HDD/MEMORY category.....	57
“Memory Stick”.....	99
“Memory Stick Duo”	
Number of recordable pictures .....	68
Write-protect tab.....	100
Memory Stick Duo adaptor .....	100
Memory Stick Duo slot.....	31
“Memory Stick PRO Duo” .....	100
MICREF LEVEL.....	82
Mirror mode.....	32
Moisture condensation.....	103
Movie	
Recording mode.....	63
Recording quality .....	63
Shooting.....	28
MOVIE SETTINGS .....	63
MPEG .....	114
MPEG2 .....	98
MPEG-4 AVC/H.264.....	114

## N

NightShot .....	31
NIGHTSHOT LIGHT .....	64
Number of recordable pictures .....	68

## O

OLD MOVIE.....	91
ONE PUSH .....	81, 90
Operation confirmation beep .....	See BEEP
OPTION MENU .....	76
Original.....	50
OTHERS category.....	46
OUTDOOR .....	81
OUTPUT SETTINGS .....	73

## P

PAL .....	96
PASTEL .....	82
PB zoom .....	37
PHOTO SETTINGS.....	67
PictBridge.....	54
Picture Motion Browser Guide .....	45
PICT.EFFECT (Picture effect).....	82, 91
Playback .....	24, 34
Playing time.....	19
Playlist .....	50
PORTRAIT (Soft portrait) .....	80
Pre-installed rechargeable battery.....	104
Print .....	54

## Q

QUALITY .....	68
---------------	----

## R

REC LAMP (Recording lamp).....	75
REC SET .....	63

Recording .....23, 27  
 Recording quality .....63  
 Recording time .....11, 18  
 REDEYE REDUC .....66  
 Remaining  
   Battery .....17  
   Hard disk .....58  
 Remaining battery .....17  
 REMAINING (movie).....66  
 Remote Commander .....85, 111  
 REMOTE CTRL  
 (Remote control).....75  
 REPAIR IMG.DB F. ....59  
 RESET .....109

**S**

S VIDEO cable .....43  
 S VIDEO jack .....53  
 SCENE SELECTION .....80, 90  
 SD movie files .....98  
 SD QUALITY .....63  
 SD REC MODE.....64  
 SD (standard definition) image  
 quality .....9  
 Self-diagnosis display .....92  
 SELF-TIMER .....83  
 SEPIA .....82  
 SETTINGS .....61  
 SETTINGS category.....61  
 Slide show.....38  
 SLIDE SHOW SET .....38  
 SMTH SLW REC .....32  
 SNOW .....80  
 SOUND/DISP SET.....72  
 SP .....63, 64  
 SPOT FOCUS.....79, 90  
 SPOT METER  
 (Flexible spot meter).....79, 90  
 SPOTLIGHT .....80  
 STANDARD .....68  
 STEADYSHOT .....65, 88, 91

Still image  
   Copying.....49  
   IMAGE SIZE.....67  
   QUALITY .....68  
   Shooting .....28  
   Still image files .....98  
   Still image format .....99  
 SUNRISE&SUNSET .....80  
 SUPER NIGHTSHOT  
 .....82, 90

## T

TELE MACRO .....79, 91  
 Telephoto .....29  
 Thumbnail .....114  
 Trademark .....105  
 Tripod .....110  
 TV color system .....96  
 TV CONNECT Guide.....40  
 TV TYPE .....73  
 TWILIGHT .....80  
 TWILIGHT PORT .....80

## U

USB cable .....15  
 USB jack .....110  
 Using abroad .....96

## V

VBR .....11, 114  
 VF B.LIGHT  
 (Viewfinder brightness) .....72  
 VIEW IMAGES SET .....70  
 Viewing pictures on a TV ....39  
 VISUAL INDEX.....34  
 VOLUME.....72  
 Volume adjustment .....36

## W

Wall socket.....16  
 Warning indicators .....92

Warning messages .....93  
 WB SHIFT  
 (White Balance Shift) .....64  
 WHITE BAL.  
 (White balance) .....81, 90  
 WHITE FADER .....82  
 Wide angle .....29  
 WIDE SELECT .....65, 91  
 Wide TV .....42  
 World time difference.....97  
 Write-protect tab .....100

## X

XP .....63  
 X.V.COLOR.....65, 102

## Z

ZEBRA .....66  
 Zoom.....29  
 ZOOM LINK .....71

Additional information on this product and answers to frequently asked questions can be found at our Customer Support Website.

<http://www.sony.net/>