

SONY

SONY®

HANDYCAM

Digital HD Video Camera Recorder  
**HANDYCAM®**

Operating Guide

**HDR-SR1E**

GB

Enjoying your  
camcorder 12

Getting Started 23

Shooting 32

Playback 40

Editing 51

Dubbing/printing 57

Utilizing recording media 61

Customizing your  
camcorder 64

Using a Computer 84

Troubleshooting 90

Additional  
Information 108

Quick  
Reference 122

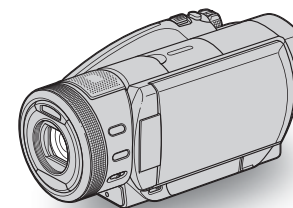

Additional information on this product and answers to frequently asked questions can be found at our Customer Support Website.

<http://www.sony.net/>



Printed on 70% or more recycled paper using VOC (Volatile Organic Compound)-free vegetable oil based ink.

Printed in Japan



AVCHD



InfoLITHIUM™ M SERIES

HDMI



# Read this before operating your camcorder

Before operating the unit, please read this manual thoroughly, and retain it for future reference.

## WARNING



To reduce fire or shock hazard, do not expose the unit to rain or moisture.

## CAUTION

Replace the battery with the specified type only. Otherwise, fire or injury may result.

## FOR CUSTOMERS IN THE UNITED KINGDOM

A moulded plug complying with BS1363 is fitted to this equipment for your safety and convenience.

Should the fuse in the plug supplied need to be replaced, a fuse of the same rating as the supplied one and approved by ASTA or BSI to BS1362 (i.e., marked with  or  mark) must be used.

If the plug supplied with this equipment has a detachable fuse cover, be sure to attach the fuse cover after you change the fuse. Never use the plug without the fuse cover. If you should lose the fuse cover, please contact your nearest Sony service station.

## FOR CUSTOMERS IN EUROPE

### ATTENTION

The electromagnetic fields at the specific frequencies may influence the picture and sound of this unit.

This product has been tested and found compliant with the limits set out in the EMC Directive for using connection cables shorter than 3 meters (9.8 feet).

### Notice

If static electricity or electromagnetism causes data transfer to discontinue midway (fail), restart the application or disconnect and connect the communication cable (USB, etc.) again.



**Disposal of Old Electrical & Electronic Equipment (Applicable in the European Union and other European countries with separate collection systems)**

This symbol on the product or on its packaging indicates that this product shall not be treated as household waste. Instead it shall be handed over to the applicable collection point for the recycling of electrical and electronic equipment. By ensuring this product is disposed of correctly, you will help prevent potential negative consequences for the environment and human health, which could otherwise be caused by inappropriate waste handling of this product. The recycling of materials will help to conserve natural resources.

For more detailed information about recycling of this product, please contact your local Civic Office, your household waste disposal service or the shop where you purchased the product.

Applicable Accessory: Remote Commander

## Notes on use

Your camcorder is supplied with two kinds of operations guides.

- "Operating Guide" (This manual)
- "First Step Guide" for using your camcorder with the computer connected (stored on the supplied CD-ROM)

## Types of "Memory Stick" you can use in your camcorder

There are two sizes of "Memory Stick." You can use "Memory Stick Duo" marked with **MEMORY STICK DUO** or **MEMORY STICK PRO DUO** (p. 112).

"Memory Stick Duo"  
(This size can be used with your camcorder.)



"Memory Stick"  
(You cannot use it in your camcorder.)



- You cannot use any type of memory card except "Memory Stick Duo."
- "Memory Stick PRO" and "Memory Stick PRO Duo" can be used only with "Memory Stick PRO" compatible equipment.

## When using a "Memory Stick Duo" with "Memory Stick" compatible equipment

Be sure to insert the "Memory Stick Duo" into the Memory Stick Duo Adaptor.

## Memory Stick Duo Adaptor



## Using the camcorder

- Do not hold the camcorder by the following parts.

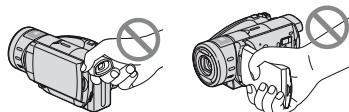

Viewfinder

LCD screen

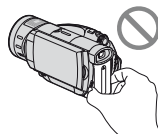

Battery

- The camcorder is not dustproofed, dripproofed or waterproofed. See "Maintenance and precautions" (p. 115).
- To prevent the hard disk from being broken or recorded images from being lost, do not do the following when either of the respective lamps of the **POWER** switch (p. 28) or the **ACCESS** lamp (p. 32) is on:
  - to remove the battery pack or AC Adaptor from the camcorder.
  - to apply mechanical shock or vibration to the camcorder.
- When connecting your camcorder to another device with an **HDMI** cable, a component video cable, or a **USB** cable, be sure to insert the connector plug in the correct way. Pushing the plug forcibly into the terminal will damage the terminal and may result in a malfunction of your camcorder.

## Read this before operating your camcorder (Continued)

### About menu items, LCD panel, viewfinder, and lens

- A menu item that is grayed out is not available under the current recording or playback conditions.
- The LCD screen and the viewfinder are manufactured using extremely high-precision technology, so over 99.99% of the pixels are operational for effective use. However, there may be some tiny black points and/or bright points (white, red, blue, or green in color) that appear constantly on the LCD screen and the viewfinder. These points are normal results of the manufacturing process and do not affect the recording in any way.

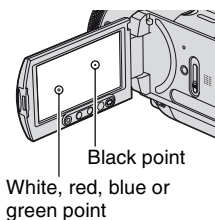

- Exposing the LCD screen, the viewfinder, or the lens to direct sunlight for long periods of time may cause malfunctions.
- Do not aim at the sun. Doing so might cause your camcorder to malfunction. Take images of the sun only in low light conditions, such as at dusk.

### On recording

- Before starting to record, test the recording function to make sure the image and sound are recorded without any problems.
- Compensation for the contents of recordings cannot be provided, even if recording or playback is not possible due to a malfunction of the camcorder, storage media, etc.
- TV color systems differ depending on the countries/regions. To view your

recordings on a TV, you need a PAL system-based TV.

- Television programs, films, video tapes, and other materials may be copyrighted. Unauthorized recording of such materials may be contrary to the copyright laws.

### About this manual

- The images of the LCD screen and the viewfinder used in this manual for illustration purposes are captured using a digital still camera, and therefore may appear different.
- Design and specifications of recording media and other accessories are subject to change without notice.
- The on-screen displays in each local language are used for illustrating the operating procedures. Change the screen language before using your camcorder if necessary (p. 18).

### About the Carl Zeiss lens

Your camcorder is equipped with a Carl Zeiss lens, which was developed jointly by Carl Zeiss, in Germany, and Sony Corporation, and produces superior images. It adopts the MTF measurement system for video cameras and offers a quality typical of a Carl Zeiss lens. Also, the lens for your camcorder is T\*-coated to suppress unwanted reflections and faithfully reproduce colors.

MTF= Modulation Transfer Function. The number value indicates the amount of light from a subject coming into the lens.



# Notes on using the Hard Disk Drive Handycam

## Save all your recorded image data

- To prevent your image data from being lost, save all your recorded images on external media. It is recommended that you save the image data on a disc using your computer. (For details, see the “First Step Guide” on the supplied CD-ROM.) Also, you can save your image data using a VCR, or a DVD/HDD recorder (p. 58).
- It is recommended that you save your image data periodically, after recording.

## Do not apply shock or vibration to your camcorder

- The hard disk of the camcorder may not be recognized, or recording or playback may not be possible.
- Especially, during recording/playback, do not apply shock. After recording, do not apply vibration or shock to the camcorder, while the ACCESS lamp is lit.
- When using the shoulder belt (not supplied), do not crash the camera against an object.

## On the drop sensor

- To protect the internal hard disk from the shock by dropping, the camcorder has the drop sensor function (p. 76). When a drop occurs, or under a non-gravity condition, the block noise to protect the camcorder may also be recorded. If the drop sensor catches a drop repeatedly, recording/playback may be stopped.

## Notes on battery pack/AC Adaptor

- While the ACCESS lamp is lit, be sure to avoid the following. They may cause malfunctions.
  - Removing the battery pack
  - Removing the AC Adaptor (while charging the battery pack using the AC Adaptor)
- Be sure to remove the battery pack or the AC Adaptor after turning off the POWER switch.

## Note on operating temperatures

- When the temperature of the camcorder becomes extremely high or extremely low, you may not be able to record or play back on the camcorder, due to the protection features of the camcorder being activated in such situations. In this case, a message appears on the LCD screen (p. 104).

## When the camcorder is connected to a computer

- Do not try to format the hard disk of the camcorder using a computer. If you do so, your camcorder may not operate correctly.

## Note on using the camcorder at high altitudes

- Do not turn on the camcorder in a low-pressure area, where the altitude is more than 3,000 meters (9,800 feet). Doing so may damage the hard disk drive of your camcorder.

## Note on disposal/transfer

- If you format the hard disk of the camcorder using [⊖FORMAT] (p. 62) on the camcorder, or on a computer, you may not delete data from the hard disk completely. When you sell or give the camcorder to somebody else, it is recommended that you make it difficult to recover your data using data erasing software, etc. on a computer, and then format the hard disk using [⊖FORMAT] on the camcorder. If you do not have a data erasing software, format the hard disk using [⊖FORMAT] first, record darkness on the entire hard disk by covering the camcorder with a box, or something similar, while the camcorder is recording, and then format the hard disk using [⊖FORMAT] again. This will make it difficult to recover any previously recorded data.

In addition to the above, when you dispose of the camcorder, it is recommended that you destroy the actual body of the camcorder. This may prevent data recovery from the hard disk of the camcorder.

## If you cannot record/play back images, perform [⊖FORMAT]

- If you repeat recording/deleting images for a long time, fragmentation of data occurs on the hard disk. Images cannot be saved or recorded. In such a case, save your images on some type of external media first, and then perform [⊖FORMAT] (p. 62).  
Fragmentation  Glossary (p. 130)

# Table of Contents

## Read This First (supplied)

Provides features and information about the camcorder you should know before using it.



Read this before operating your camcorder .....	2
Notes on using the Hard Disk Drive Handycam .....	5
Subject examples and solutions .....	10

## Enjoying your camcorder

Operation flow .....	12
Experience the beauty of HD (high definition) images .....	14
“HOME” and “OPTION” - Taking advantage of two types of menus.....	16

## Getting Started

Step 1: Checking supplied items .....	23
Step 2: Charging the battery pack .....	24
Step 3: Turning the power on .....	28
Step 4: Adjusting the LCD panel and viewfinder .....	29
Step 5: Setting the date and time .....	30

## Shooting

Recording the images .....	32
Zooming	
Recording sound with more presence (5.1ch surround recording)	
Using the flash	
Recording high quality still images during movie recording (Dual Rec)	
Recording in dark places (NightShot)	
Adjusting the exposure for backlit subjects	
Recording in mirror mode	
Recording the fast action in slow-motion (SMTH SLW REC)	
Controlling the image settings manually with the camera control ring	

## Playback

Viewing the images .....	40
Using PB zoom	
Playing back a series of still images (Slide show)	
Playing the image on a TV .....	44
Saving images .....	50

## Editing

 (OTHERS) category .....	51
Deleting images .....	51
Copying still images .....	53
Creating the Playlist .....	54





## Dubbing/printing

 (SELECT DEVICES) category .....	57
Dubbing images .....	57
Dubbing to VCR or DVD/HDD recorders .....	58
Printing recorded images (PictBridge compliant printer) .....	59

## Utilizing recording media

 (MANAGE HDD/MEMORY) category .....	61
Deleting all scenes on the recording media (Formatting) .....	62
Checking the HDD information .....	63

## Customizing your camcorder

What you can do with the  (SETTINGS) category of the HOME MENU .....	64
Using the HOME MENU	
List of the  (SETTINGS) category items	
<b>MOVIE SETTINGS</b> .....	66
(Items for recording movies)	
<b>PHOTO SETTINGS</b> .....	69
(Items for recording still images)	
<b>VIEW IMAGES SET</b> .....	72
(Items to customize the sound volume and display)	
<b>SOUND/DISP SET</b> .....	73
(Items to adjust beep and the screen)	
<b>OUTPUT SETTINGS</b> .....	74
(Items for when connecting other devices)	
<b>CLOCK/ LANG</b> .....	75
(Items to set clock and language)	
<b>GENERAL SET</b> .....	75
(Other setup items)	
<b>Activating functions using the  OPTION MENU</b> .....	77
Using the OPTION MENU	
<b>Recording items on the OPTION MENU</b> .....	78
PROGRAM AE, FADER, SPOT METER, etc.	
<b>Viewing items on the OPTION MENU</b> .....	83
VOLUME, SLIDE SHOW, SLIDE SHOW SET, etc.	

## Using a Computer

What you can do with Windows computer .....	84
Installing the “First Step Guide” and software .....	86
Viewing “First Step Guide” .....	89

## Troubleshooting

Troubleshooting .....	90
Warning indicators and messages .....	103

## Additional Information

Using your camcorder abroad .....	108
Files on the camcorder hard disk/folder structure .....	110
About the AVCHD format .....	111
About the “Memory Stick” .....	112
About the “InfoLITHIUM” battery pack .....	114
Maintenance and precautions .....	115
Specifications .....	118

## Quick Reference

Identifying parts and controls .....	122
Indicators displayed during recording/playback .....	127
Glossary .....	130
Index .....	132

# Subject examples and solutions

## Shooting

### Checking your golf swing

- ▶ Smooth slow recording.....38



### Flowers in close-up

- ▶ Soft portrait.....80
- ▶ Focus .....78
- ▶ Telemacro .....79



### Focusing on the dog on the left side of the screen

- ▶ Focus .....78
- ▶ Spot focus.....79



### Focusing more distant objects

- ▶ Landscape.....80
- ▶ Focus .....78



### Capturing still images during movie recording

- ▶ Dual Rec.....37



### Getting a good shot of a ski slope or beach

- ▶ Backlight .....38
- ▶ Beach&Ski.....80



## A child on the stage under a spot light

- ▶ Spotlight ..... 80



## Fireworks with all its splendor

- ▶ Sunset&Moon ..... 80
- ▶ Focus ..... 78



## A sleeping child under dim light

- ▶ NightShot ..... 37
- ▶ Color Slow Shutter ..... 81



## Playback

### Viewing on the TV screen .....44

## Editing, others

### Saving images on external media .....50

### Deleting the unnecessary images .....51

### Burning a disc for your friend .....57

### Using your camcorder on a trip .....108

# Operation flow

## ► Get ready.

- Read the supplied “Read This First” before you use your camcorder.
- Prepare for recording as described from page 23.



## ► Shoot using your camcorder (p. 32).

- Movies are recorded on the hard disk, and still images are recorded on either the hard disk or a “Memory Stick Duo.”
- You can select the image quality of movies, HD (high definition) or SD (standard definition).



## ► Play back the images.

- Viewing on the LCD screen of your camcorder (p. 40).
- Viewing on the TV connected to your camcorder (p. 44).

You can view the images recorded with HD (high definition) image quality on a high definition TV.



### 💡 Tips

- If your TV is not a high definition TV, movies with HD (high definition) image quality will be displayed with SD (standard definition) image quality.
- You can consult the [TV CONNECT Guide] (p. 44) displayed on the screen on connecting your TV and camcorder.
- Images recorded with the SD (standard definition) image quality cannot be converted to HD (high definition) image quality.



## Saving or deleting images you recorded with your camcorder

### ► Save recorded images.

- Saving images on a disc using a computer  
→ See First Step Guide on the supplied CD-ROM for details.
- Copying images to a computer  
→ See First Step Guide on the supplied CD-ROM for details.
- Dubbing images on VCR or DVD/HDD recorders (p. 58)

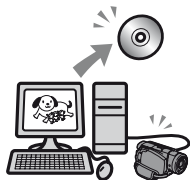

### ► Delete images.

If the hard disk of your camcorder is full, you cannot shoot new images. Delete the image data that have been saved in a computer or discs. You can record new images on the free hard disk space again.

- Deleting the selected images (p. 51)
- Deleting all the images (p. 62)

# Experience the beauty of HD (high definition) images

▶ Your camcorder offers both HD (high definition) and SD (standard definition) recording image qualities.

**The images recorded with SD (standard definition) image quality cannot be converted to HD (high definition) image quality.**

Select a recording format before you start shooting (p. 66).

▶ **HD (high definition) image quality**

AVCHD format

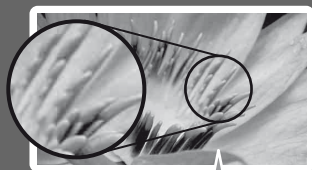
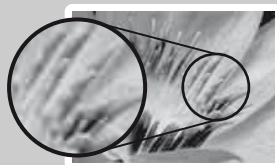

Image resolution:  
About **3.75** times of that of SD  
(standard definition)

Records high definition images.  
Recommended whether or not you have a high definition TV.

▶ **SD (standard definition) image quality**

MPEG2 format



Records standard definition images.  
Recommended if playback compatibility is important.

## **Tips**

- AVCHD images can be viewed even on non-high definition TVs. The image quality, however, is equivalent to SD (standard definition) image quality.

## Recording time of movies

HD (high definition) image quality

AVCHD format

Recording mode	Approximate recordable time (hour minute)
AVC HD 15M (XP) (highest quality)	4 h
AVC HD 9M (HQ) (high quality)	7 h
AVC HD 7M (SP) (standard quality)	8 h 30 m
AVC HD 5M (LP) (long play)	11 h

SD (standard definition) image quality

MPEG2 format

Recording mode	Approximate recordable time (hour minute)
SD 9M (HQ) (high quality)	7 h 20 m
SD 6M (SP) (standard quality)	10 h 50 m
SD 3M (LP) (long play)	20 h 50 m*

\* The maximum continuous recordable time is approximately 13 hours.

### Tips

- Figures such as 15M and 9M in the table show the average bit rate. M stands for Mbps.
- You can record movies of a maximum of 3,999 scenes with HD (high definition) image quality, and 9,999 scenes with SD (standard definition) image quality.
- You can record the maximum 9,999 still images on the hard disk. For the “Memory Stick Duo,” see page 70.

Your camcorder uses the VBR (Variable Bit Rate) format to automatically adjust image quality to suit the recording scene. This technology causes fluctuations in the recording time of the hard disk. Movies containing quickly moving and complex images are recorded at a higher bit rate, and this reduces the overall recording time.

# “HOME” and “OPTION”

## - Taking advantage of two types of menus

“HOME MENU” - the starting point for all operations with your camcorder

When you want to customize your camcorder, open the “HOME MENU.” This menu is the gateway to all the functions of your camcorder. See page 18 for further details.

When deleting movies with HD (high definition) image quality, for example

I don't want to keep these movies. What should I do?

Try [EDIT] on the HOME MENU. You can select and delete them all at once.

[?] (HELP)  
Displays a description of the item (p. 20).

HOME MENU

Category (p. 21)

DELETE

DATE				
1/2	✓			
			✓	

Press and hold: PREVIEW

## “OPTION MENU” enables you to access functions directly

Just a touch on the screen during shooting or playback displays the functions available at that moment. You will find it easy to make various settings. See page 22 for further details.

**When deleting a movie with HD (high definition) image quality, for example**

I want be sure which movie I am deleting. What should I do?

Turn on the OPTION MENU when you are viewing images, then try [DELETE]. You can delete the image on the screen.

60min 100/112

DELETE

OPTION MENU (PB)

Uh huh, the OPTION MENU items are different, depending on what I'm doing.

## ■ Notes on the menu operation

Place your fingers on the rear side of the LCD panel (touch panel) to support it. Then, touch the buttons displayed on the screen with your thumb.

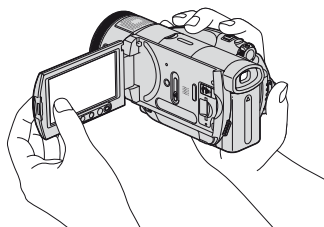

Perform the same actions as explained above when you press the buttons on the LCD panel.

- Be careful not to press the buttons below the LCD panel accidentally while using the touch panel.
- If the buttons on the touch panel do not work correctly, adjust the touch panel (CALIBRATION) (p. 116).

## Changing the language setting

You can change the on-screen displays to show messages in a specified language. To select the screen language, touch [SETTINGS] → [CLOCK/ [A] LANG] → [ [A] LANGUAGE SET] (p. 75).

## Using the HOME MENU

Selecting and deleting movies with HD (high definition) image quality on the edit screen is explained as an example.

- 1 While pressing the green button in the center, slide the POWER switch in the direction of the arrow to turn on the power.

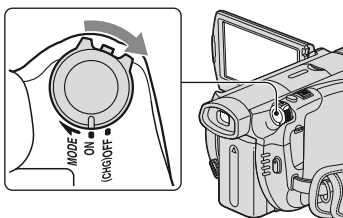

- 2 Press [HOME] [B] (or [A]).

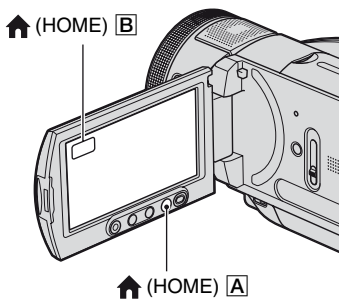

HOME MENU



Category (p. 21)

### 3 Touch (OTHERS).



### 4 Touch [EDIT].

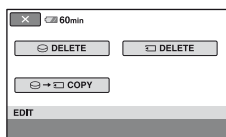

### 5 Touch [] DELETE].

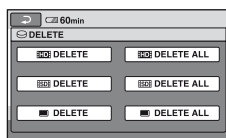

### 6 Touch [] DELETE].



### 7 Touch the image you want to delete.



### 8 Touch [OK] → [YES] → [OK].

► **When you want to know something about the function of each item on the HOME MENU - HELP**

---

**1** Press  (HOME).

The HOME MENU appears.



---

**2** Touch  (HELP).

The bottom of the  (HELP) button turns orange.



---

**3** Touch the item you want to know the content.



When you touch an item, its explanation appears on the screen.

To apply the option, touch [YES], otherwise, touch [NO].







---

**To deactivate the HELP**

Touch  (HELP) in step 2.



## ► Categories and items of the HOME MENU

Category	Item
CAMERA 	MOVIE (p. 33) PHOTO (p. 34) SMTH SLW REC (p. 38)
VIEW IMAGES 	VISUAL INDEX (p. 40) PLAYLIST (p. 54)
OTHERS 	EDIT (p. 51) PLAYLIST EDIT (p. 54) PRINT (p. 59)
SELECT DEVICES 	COMPUTER (p. 57) TV CONNECT Guide (p. 44) PRINTER (p. 59)
MANAGE HDD/MEMORY 	 FORMAT (p. 62) <input type="checkbox"/> FORMAT (p. 62) <input type="checkbox"/> INFO (p. 63)
SETTINGS 	To customize your camcorder (p. 64).

## Using the OPTION MENU

Deleting a movie during viewing is explained as an example.

- 1 While viewing the movie you want to delete, touch  (OPTION) on the screen.

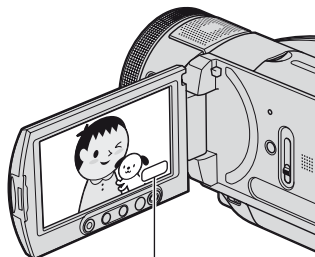

 (OPTION)

### OPTION MENU

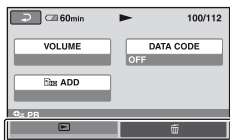

Tab

- 2 Touch .



- 3 Touch [DELETE] → [YES] → .

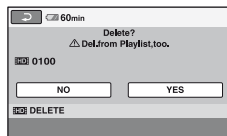

## Items on the OPTION MENU

See pages 78 and 83.

### When the item you want is not on the screen

Touch another tab. If you cannot find the item anywhere, the function does not work under the situation.

#### Notes

- The tabs and items that appear on the screen depend on the recording/playback status of your camcorder at the time.
- Some items appear without a tab.

## Step 1: Checking supplied items

Make sure that you have the following items supplied with your camcorder. The number in the parentheses indicates the number of that item supplied.

AC Adaptor (1) (p. 24)

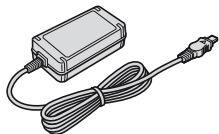

Mains lead (1) (p. 24)



Component video cable (1) (p. 45)

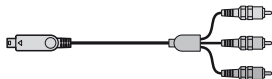

A/V connecting cable (1) (p. 45, 58)



USB cable (1) (p. 59)

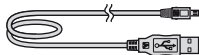

Wireless Remote Commander (1)  
(p. 126)



A button-type lithium battery is already installed.

Rechargeable battery pack NP-FM50 (1)  
(p. 24, 114)

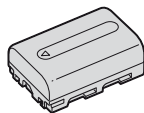

CD-ROM "Handycam Application  
Software" (1) (p. 84)

Read This First (1)

Operating Guide (This manual) (1)

### ⚠ Notes

- No "Memory Stick Duo" is included.

## Step 2: Charging the battery pack

You can charge the “InfoLITHIUM” battery pack (M series) (p. 114) after attaching it to your camcorder.

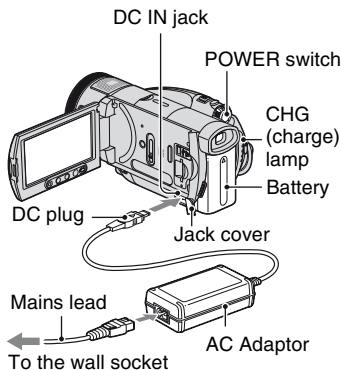

- 1** Slide the POWER switch in the direction of the arrow to OFF (CHG) (The default setting).

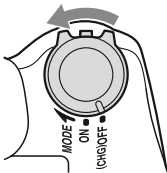

- 2** Attach the battery pack by sliding it in the direction of the arrow until it clicks.

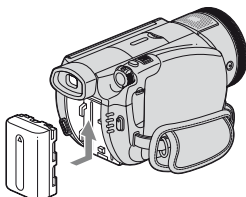

- 3** Connect the AC Adaptor to the DC IN jack of your camcorder.

Open the jack cover, and connect the DC plug of the AC Adaptor.

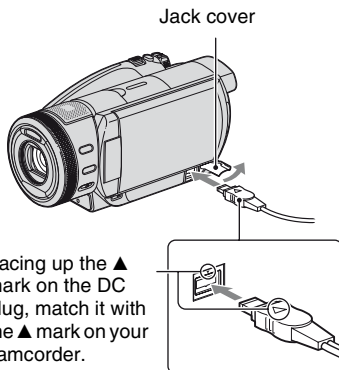

- 4** Connect the mains lead to the AC Adaptor and the wall socket.

The CHG (charge) lamp lights up and charging starts. The CHG (charge) lamp turns off when the battery is fully charged.

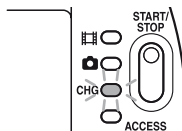

- 5** Disconnect the AC Adaptor from the DC IN jack on your camcorder.

## Notes

- Disconnect the AC Adaptor from the DC IN jack holding both the camcorder and the DC plug.

## Tips

- If you attach the battery pack or connect the AC Adaptor when the POWER switch is set to OFF (CHG), your camcorder turns on, then off again, after a few seconds.

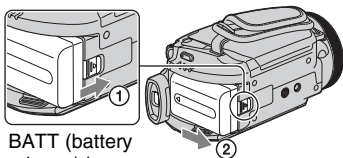

## To remove the battery pack

Slide the POWER switch to OFF (CHG). Slide the BATT (battery release) lever and remove the battery pack.



BATT (battery release) lever

## Notes

- When you remove the battery pack, make sure that the  (Movie) lamp/ (Still) lamp (p. 28) is turned off.

## When storing the battery pack

Fully discharge the battery before storing it for an extended period (see page 114 for the details of storage).

## To use an outside power source

Make the same connections as you do when charging the battery pack. The battery pack will not lose its charge in this case.

## To check the remaining battery (Battery Info)

Set the POWER switch to OFF (CHG), then press DISP/BATT INFO.

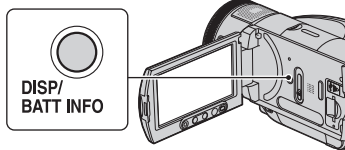

After a while, the approximate recordable time and battery information appear for about 7 seconds. You can view the battery information for up to 20 seconds by pressing DISP/BATT INFO again while the information is displayed.

Remaining battery (approx.)

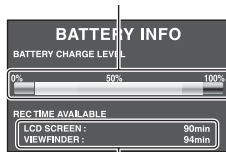

Recording capacity (approx.)

## Step 2: Charging the battery pack (Continued)

### Charging time

Approximate time (min.) required when you fully charge a fully discharged battery pack.

Battery pack	Charging time
NP-FM50 (supplied)	150
NP-QM71D	260
NP-QM91D	360

### Recording time

Approximate time (min.) available when you use a fully charged battery pack.

#### HD (high definition) image quality with recording mode [SP]

Battery pack	Continuous recording time	Typical recording time*
NP-FM50 (supplied)	100	55
	105	55
	105	55
NP-QM71D	250	135
	265	145
	265	145
NP-QM91D	380	205
	400	220
	400	220

#### SD (standard definition) image quality with recording mode [HQ]

Battery pack	Continuous recording time	Typical recording time*
NP-FM50 (supplied)	115	60
	120	65
	120	65
NP-QM71D	285	155
	300	165
	300	165

Battery pack	Continuous recording time	Typical recording time*
NP-QM91D	430	235
	455	250
	455	250

\* Typical recording time shows the time when you repeat recording start/stop, turning the power on/off and zooming.

### Notes

- All times measured under the following conditions:

Top: When the LCD backlight turns on.

Middle: When the LCD backlight turns off.

Bottom: When recording with the viewfinder while the LCD panel is closed.

### Playing time

Approximate time (min.) available when you use a fully charged battery pack.

#### HD (high definition) image quality



Battery pack	LCD panel opened*	LCD panel closed
NP-FM50 (supplied)	160	165
	390	400
	585	605

#### SD (standard definition) image quality

Battery pack	LCD panel opened*	LCD panel closed
NP-FM50 (supplied)	170	185
	415	445
	625	670

\* When the LCD backlight is on.

### On the battery pack

- Before changing the battery pack, slide the POWER switch to OFF (CHG) and turn off the  (Movie) lamp/  (Still) lamp.
- The CHG (charge) lamp flashes during charging, or Battery Info (p. 25) will not be correctly displayed under the following conditions:
  - The battery pack is not attached correctly.
  - The battery pack is damaged.
  - The battery pack is worn-out (For Battery Info only).
- When attaching an optional video light, it is recommended that you use an NP-QM71D or NP-QM91D battery pack.
- We do not recommend using an NP-FM30, which only allows short recording and playback times, with your camcorder.

### On the charging/recording/playback time

- Times measured when using the camcorder at 25 °C (77 °F) (10 °C to 30 °C (50 °F to 86 °F) is recommended).
- The recording and playback time will be shorter when you use your camcorder in low temperatures.
- The recording and playback time will be shorter depending on the conditions under which you use your camcorder.

### On the AC Adaptor

- Use the nearby wall socket when using the AC Adaptor. Disconnect the AC Adaptor from the wall socket immediately if any malfunction occurs while using your camcorder.
- Do not use the AC Adaptor placed in a narrow space, such as between a wall and furniture.
- Do not short-circuit the DC plug of the AC Adaptor or battery terminal with any metallic objects. This may cause a malfunction.

### PRECAUTION

- Even if your camcorder is turned off, AC power (mains) is still supplied to it while connected to the wall socket via the AC Adaptor.

## Step 3: Turning the power on

To record, slide the POWER switch repeatedly to turn on the respective lamp. When using it for the first time, the [CLOCK SET] screen appears (p. 30).

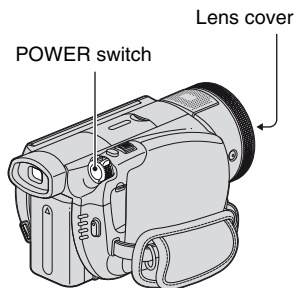

While pressing the green button in the center, slide the POWER switch repeatedly in the direction of the arrow to turn on the power.

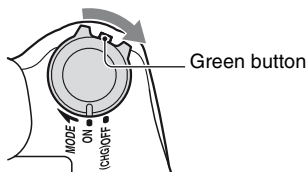

When you record, switch the power mode by sliding the POWER switch in the direction of the arrow until the respective lamp lights up.

 **(Movie):** To record movies

 **(Still):** To record still images

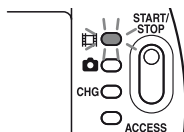

## To turn off the power

Slide the POWER switch to OFF (CHG).

### ⚡ Notes

- It takes a few seconds for your camcorder to be ready to shoot after the power is turned on. You cannot operate your camcorder during this time.
- The lens cover opens automatically when the power is turned on. It closes when the playback screen is selected, or the power is turned off.
- In the setting at the time of purchase, the power turns off automatically if you leave your camcorder without any operation attempted for approximately 5 minutes, to save battery power ([A.SHUT OFF], p. 76).

### 💡 Tips

- After you have set the date and time ([CLOCK SET], p. 30), the next time you change the POWER switch position, the current date and time will be displayed on the LCD screen for a few seconds.



## Step 4: Adjusting the LCD panel and viewfinder

### LCD panel

Open the LCD panel 90 degrees to the camcorder (①), then rotate it to the best angle to record or play (②).

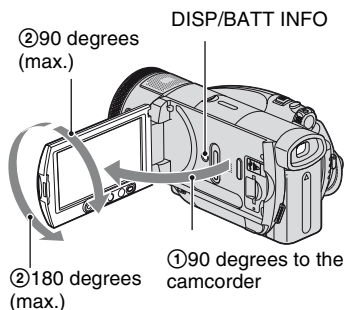

### To turn off the LCD backlight to make the battery last longer

Press and hold DISP/BATT INFO for a few seconds until  $\square_{OFF}$  appears. This setting is practical when you use your camcorder in bright conditions or you want to save battery power. The recorded image will not be affected by the setting. To turn on the LCD backlight, press and hold DISP/BATT INFO for a few seconds until  $\square_{OFF}$  disappears.

### To hide the screen indicators

Press DISP/BATT INFO to toggle the screen indicators (such as time code) on or off.

### Notes

- Do not press the buttons below the LCD screen accidentally when you open or adjust the LCD panel.

### Tips

- If you open the LCD panel 90 degrees to the camcorder, then rotate it 180 degrees to the lens side, you can close the LCD panel with the LCD screen facing out. This is convenient during playback operations.
- On the HOME MENU, touch  $\square$  (SETTINGS) → [SOUND/DISP SET] → [LCD BRIGHT] (p. 73) to adjust the brightness of the LCD screen.

### Viewfinder

You can view images using the viewfinder to avoid wearing down the battery, or when the image seen on the LCD screen is poor.

#### Viewfinder

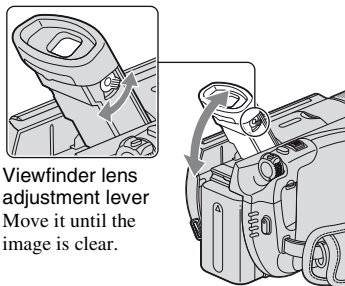

### Tips

- You can adjust the brightness of the viewfinder backlight by selecting  $\square$  (SETTINGS) → [SOUND/DISP SET] → [VF B.LIGHT] on the HOME MENU (p. 73).

# Step 5: Setting the date and time

Set the date and time when using this camcorder for the first time. If you do not set the date and time, the [CLOCK SET] screen appears every time you turn on your camcorder or change the POWER switch position.

## Notes

- If you do not use your camcorder for **about 4 months**, the built-in rechargeable battery gets discharged and the date and time settings may be cleared from the memory. In that case, charge the built-in rechargeable battery and then set the date and time again (p. 117).

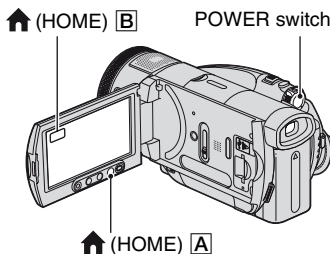

Skip to step 5 when you set the clock for the first time.

- Press **↑ (HOME) A** (or **B**) to display the HOME MENU.



- Touch **⚙️ (SETTINGS)**.

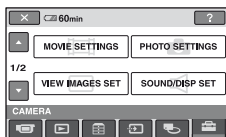

- Display **[CLOCK/⏰ LANG]** with **▲/▼**, then touch it.

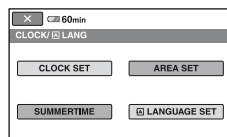

- Touch **[CLOCK SET]**.

- Select the desired geographical area with **▲/▼**, then touch **[NEXT]**.

- Set **[SUMMERTIME]**, then touch **[NEXT]**.

- Set **[Y]** (year) with **▲/▼**.



- Select **[M]** with **◀/▶**, then set the month.

- Set **[D]** (day), hour and minute in the same way, then touch **[NEXT]**.

---

## 10 Make sure that the clock is correctly set, then touch .

The clock starts.

You can set any year up to the year 2037.

---

### Tips

- The date and time does not appear during recording, but they are automatically recorded on the hard disk, and can be displayed during playback (see page 72 for [DATA CODE]).
- Refer to page 109 for information concerning “World time difference.”

# Recording the images

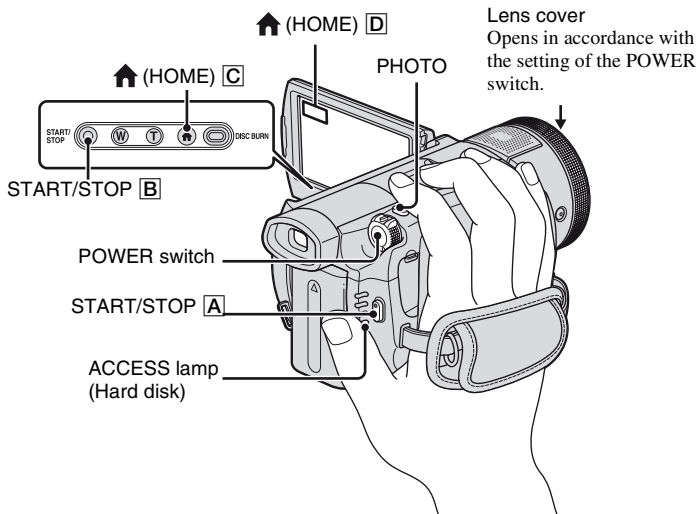

## Notes

- If the ACCESS lamp is lit or flashing after recording is finished, it means data is still being written onto the hard disk or "Memory Stick Duo." Do not apply shock or vibration to your camcorder, and do not disconnect the battery or AC Adaptor.

## Inserting a "Memory Stick Duo"

Open the LCD panel. Insert the "Memory Stick Duo" into the "Memory Stick Duo" slot in the right direction until it clicks.

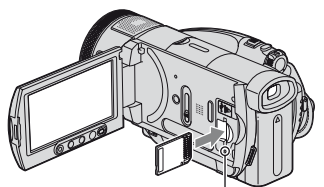

Access lamp  
("Memory Stick Duo")

## Fastening the grip belt

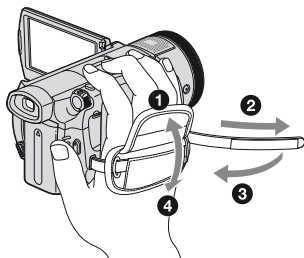

## Recording movies

- 1 Slide the **POWER** switch in the direction of the arrow to light up the  (Movie) lamp.

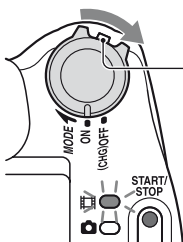

Slide the **POWER** switch in the direction of the arrow while pressing the green button only when the **POWER** switch is in the **OFF (CHG)** position.

- 2 Press **START/STOP**  (or .

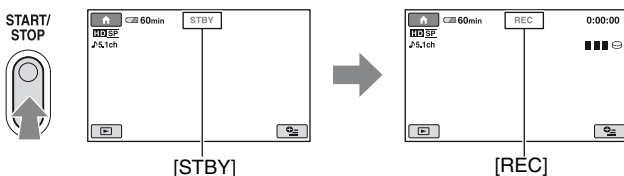

To stop recording, press **START/STOP** again.





### Notes

- You cannot record movies on a “Memory Stick Duo.”

#### To record high resolution still images during shooting a movie (Dual Rec)

→ See page 37.

#### To switch to the movie recording mode using the (HOME) button

- ① Press  (HOME)  (or ) when the power of the camcorder is on.
- ② Touch  (CAMERA) on the HOME MENU.
- ③ Touch [MOVIE].

### Recording still images

Still images are recorded on the hard disk in the default setting. To record still images on a "Memory Stick Duo," change the recording media (p. 35).

- 1** Slide the **POWER** switch repeatedly in the direction of the arrow to light up the  (**Still**) lamp.

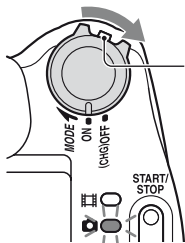

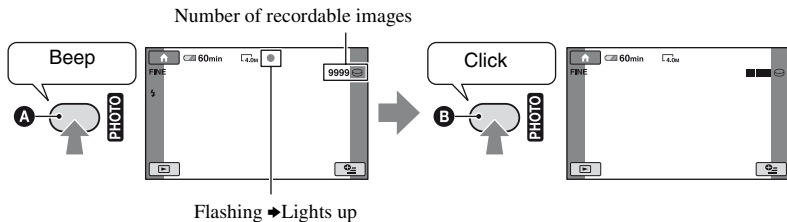

Slide the **POWER** switch in the direction of the arrow while pressing the green button only when the **POWER** switch is in the **OFF (CHG)** position.

- 2** Press **PHOTO** lightly to adjust the focus **A**, then press it fully **B**.



A shutter sound is heard. When  disappears, the image has been recorded.

**To switch to the still image recording mode using the  (HOME) button**

- ① Press  (HOME) **[C]** (or **[D]**) when the power of the camcorder is on.
- ② Touch  (CAMERA) on the HOME MENU.
- ③ Touch **[PHOTO]**.

## To change the recording media of still images

Before pressing PHOTO, select the media as follows:

- 1 Touch (OPTION) → tab → [STILL MEDIA].

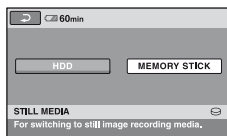

- 2 Select the media in which you want to save still images, then touch [OK]. Your camcorder returns to recording standby mode. If you select [MEMORY STICK], appears on the screen.

Number of recordable images

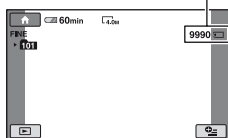

## To eject a “Memory Stick Duo”

Open the LCD panel, lightly push the “Memory Stick Duo” in once.

### Notes

- When inserting or ejecting the “Memory Stick Duo,” be careful so that the “Memory Stick Duo” does not pop out and drop.

### Tips

- The number of recordable images vary, depending on the image quality or the image size. For details, see page 70.

## Zooming

You can magnify images from about 1.1 to 10 times the original size with the power zoom lever or the zoom buttons below the LCD screen.

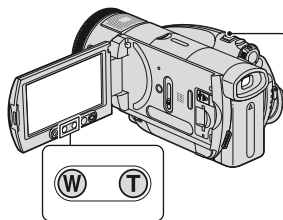

**Wider range of view:**  
(Wide angle)

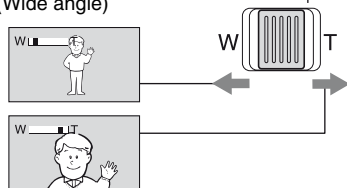

**Close view:** (Telephoto)

Move the power zoom lever slightly for a slower zoom. Move it further for a faster zoom.

### Notes

- Be sure to keep your finger on the power zoom lever. If you move your finger off the power zoom lever, the operation sound of the power zoom lever may also be recorded.
- You cannot change the zoom speed with the zoom buttons below the LCD screen.
- The minimum possible distance between camcorder and subject while maintaining sharp focus is about 1 cm (about 13/32 in.) for wide angle and about 80 cm (about 2 5/8 feet) for telephoto.

## Recording the images (Continued)

### 💡 Tips

- You can set [DIGITAL ZOOM] (p. 67) if you want to zoom to a level greater than 10 × when recording movies.

### Recording sound with more presence (5.1ch surround recording)

Sound picked up by the built-in 4ch microphone is converted to 5.1ch surround sound and recorded.

Active Interface Shoe

Built-in 4ch microphone

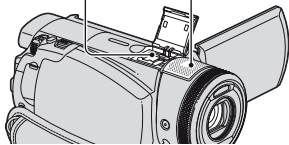

Your camcorder has Dolby Digital 5.1 Creator installed for recording 5.1ch surround sound. Enjoy realistic sound when playing the movie on devices that support 5.1ch surround sound.

Dolby Digital 5.1 Creator, 5.1ch surround sound  
 Glossary (p. 130)

### ⚡ Notes

- 5.1ch sound is converted to 2ch when played back on your camcorder.
- To enjoy the 5.1ch surround sound recorded with HD (high definition) image quality, you need an AVCHD format device compatible with 5.1ch surround.
- You can create a disc, which contains the movies recorded on your camcorder, on a computer using the supplied software. If you play the disc on a 5.1ch surround system, you can enjoy realistic sound.
- 5.1ch is displayed on the screen during 5.1ch recording/playback.

### To record with a wireless microphone

By attaching the wireless microphone (optional\*) to the Active Interface Shoe (p. 123), you can record distant sound. This distant sound is allotted to the front center part of the 5.1ch surround sound, mixed with the sound picked up by the built-in 4ch microphone, and recorded. You can enjoy more realistic sound by playing the movie on the device that supports 5.1ch surround sound.

For details, refer to the instruction manual of your wireless microphone.

\* Optional wireless microphone is not available in all countries/regions.

### Using the flash

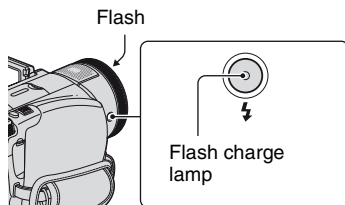

Press  (flash) repeatedly to select an appropriate setting.

**No indication (Auto flash):** Automatically flashes when there is insufficient ambient light.



** (Forced flash):** Always uses the flash regardless of the surrounding brightness.



** (No flash):** Records without flash.

### ⚡ Notes

- The recommended distance to the subject when using the built-in flash is approximately 0.5 to 2.5 m (1 5/8 to 8 feet).
- Remove any dust from the surface of the flash lamp before using it. Flash effect may be impaired if heat discoloration or dust obscures the lamp.
- The flash charge lamp flickers while charging the flash, and remains lit when the battery charge is complete.



- If you use the flash in bright places such as when shooting a backlit subject, the flash may not be effective.
- When attaching a conversion lens (optional) or a filter (optional) to your camcorder, the flash light does not emit light.

### 💡 Tips

- You can change the brightness of the flash by setting [FLASH LEVEL] (p. 71), or you can prevent the redeye by setting [REDEYE REDUC] (p. 71).

## Recording high quality still images during movie recording (Dual Rec)

You can record high quality still images while recording a movie on the hard disk.

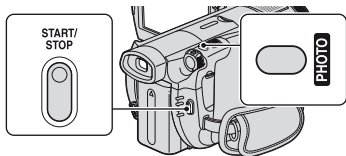

- 1 Press START/STOP to start movie recording.
- 2 Press PHOTO fully.  
After you start recording, and before you finish, you can select up to 3 frames of still images from your movie.







Orange color boxes indicate the number of recorded images. When recording is finished, the color changes to orange.

- 3 Press START/STOP to stop movie recording.  
Stored still images appear one by one, and the images are stored. When  disappears, the image has been recorded.

### ⚠️ Notes

- When you record still images on a “Memory Stick Duo,” do not eject the “Memory Stick Duo” before recording is finished and the still images are stored on it.
- You cannot use the flash during Dual Rec.

### 💡 Tips

- When the POWER switch is set to  (Movie), the size of still images becomes  2.3M (16:9 wide) or  1.7M (4:3).
- You can record still images during recording standby in the same way as when the POWER switch is set to  (Still). You can also record with the flash.

## Recording in dark places (NightShot)

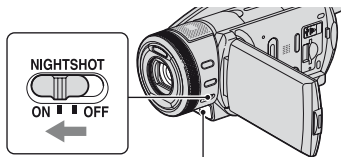

Infrared port

Set the NIGHTSHOT switch to ON. ( appears.)

### ⚠️ Notes

- The NightShot and Super NightShot functions use infrared light. Therefore, do not cover the infrared port with your fingers or other objects, and remove the conversion lens (optional).
- Adjust the focus manually ([FOCUS], p. 78) when it is hard to focus automatically.
- Do not use the NightShot and Super NightShot functions in bright places. This may cause a malfunction.

### 💡 Tips

- To record an image brighter, use Super NightShot function (p. 81). To record an image more faithfully to the original colors, use Color Slow Shutter function (p. 81).

## Recording the images (Continued)

### Adjusting the exposure for backlit subjects

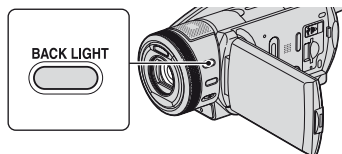

To adjust the exposure for backlit subjects, press BACK LIGHT to display . To cancel the back light function, press BACK LIGHT again.

### Recording in mirror mode

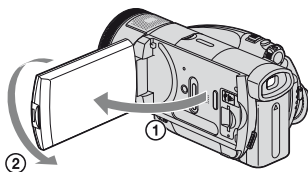

Open the LCD panel 90 degrees to the camcorder (1), then rotate it 180 degrees to the lens side (2).

#### Tips

- A mirror-image of the subject appears on the LCD screen, but the image will be normal when recorded.

### Recording the fast action in slow-motion (SMTH SLW REC)

Fast moving subjects and actions, which cannot be captured under the ordinary shooting conditions, can be shot in smooth moving slow-motion for about 3 seconds. This is useful to shoot fast actions such as a golf or tennis swing.

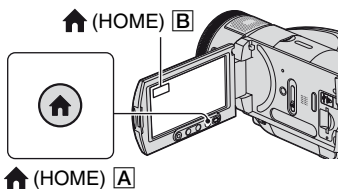

- 1 Slide the POWER switch to turn on the camcorder.
- 2 Press (HOME) [A] (or [B]) to display the HOME MENU.
- 3 Touch (CAMERA).
- 4 Touch [SMTH SLW REC].



- 5 Press START/STOP.  
An about 3 second-movie is recorded as a 12 second-slow-motion-movie.  
When [Recording---] disappears, recording is finished.

Touch to cancel the smooth slow recording.

### To select the start point

The default setting is [3sec AFTER].

- 1 Touch (OPTION) on the [SMTH SLW REC] screen.
- 2 Touch .
- 3 Touch [TIMING].  
Select one of the following start points for recording.

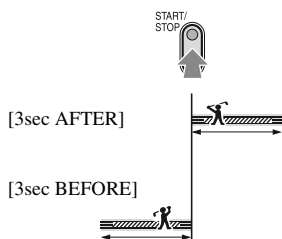

### Notes

- Sounds cannot be recorded.

## Controlling the image settings manually with the camera control ring

You can assign one menu item you use often to the camera control ring. Since the focus adjustment is assigned to the camera control ring in the default settings, the operation below is described as adjusting the focus using the ring.

### Camera control ring

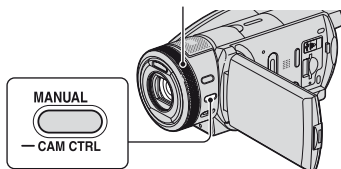

- ① Press **MANUAL** to activate the manual adjustment mode.  
Pressing **MANUAL** switches the setting mode between automatic and manual.
- ② Rotate the camera control ring to adjust the focus.

## Items you can assign to the camera control ring

- [FOCUS] (p. 78)
- [EXPOSURE] (p. 79)
- [AE SHIFT] (p. 66)
- [WB SHIFT] (p. 67)

## To assign the menu items to the camera control ring

- ① Press and hold **MANUAL** for a few seconds.  
The [RING SETTING] screen appears.

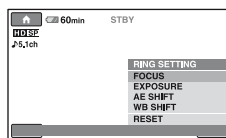

- ② Rotate the camera control ring and select the item to be assigned.
- ③ Press **MANUAL**.

### Tips

- The functions of the items that can be assigned to the camera control ring are the same as those of menu operation.
- If you select [RESET] while adjusting an item manually, all the items adjusted manually are reset to the default settings.
- You can assign the menu item to the camera control ring in the HOME MENU by selecting **SETTINGS** → [MOVIE SETTINGS]/[PHOTO SETTINGS] → [RING SETTING] (p. 68).

# Viewing the images

Lens cover

Closes in accordance with  (VIEW IMAGES).

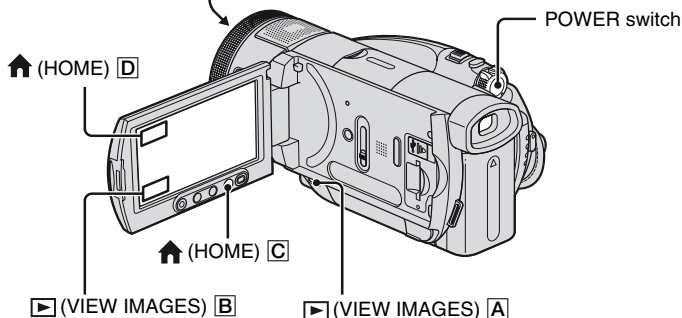

1

Slide the **POWER** switch to turn on your camcorder.

2

Press  (**VIEW IMAGES**) **A** (or **B**).

The **VISUAL INDEX** screen appears on the LCD screen. (It may take some time to display the thumbnails.)

Appears with the image on each of the tab that was lastly played back/recorded  for the still image recorded on a "Memory Stick Duo".

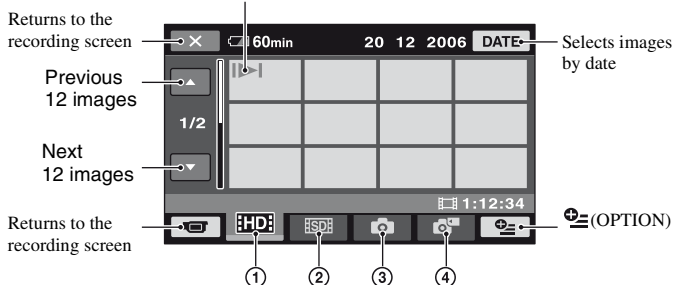

① **HD**: Displays movies with HD (high definition) image quality.

② **SD**: Displays movies with SD (standard definition) image quality.

③ : Displays still images on the hard disk.

④ : Displays still images on a "Memory Stick Duo."

## Playing movies

On the VISUAL INDEX screen, touch the **HD**, or **HSD** tab, and the movie to be played back.

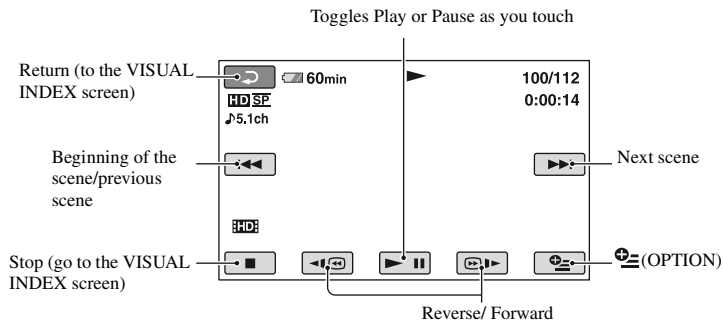

### To play back movies slowly

Touch **◀|Ⓜ|▶** / **Ⓜ|▶** during pause.



### To adjust the sound volume

Touch **⊕** (OPTION) → **▶** tab → [VOLUME], then adjust the volume with **−** / **+**.

### 💡 Tips



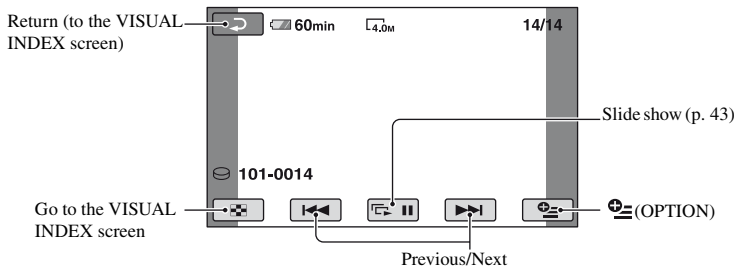

- A touch of **◀|Ⓜ|▶** / **Ⓜ|▶** makes the reverse/fast forward approximately 5 times faster, 2 touches makes it approximately 10 times faster, 3 touches makes it approximately 30 times faster, and 4 touches makes it approximately 60 times faster.
- There is **▶|** on the movie you played the last time. If you touch the movie, you can play it back from the point you have stopped.

### Viewing still images

On the VISUAL INDEX screen, touch the  , or  tab, and the still image to be played back.



#### To switch to the playback mode using the (HOME) button

- ① Press  (HOME)  (or ) when the power of the camcorder is on.
- ② Touch  (VIEW IMAGES) on the HOME MENU.
- ③ Touch [VISUAL INDEX].

## Using PB zoom

You can magnify still images from about 1.1 to 5 times the original size.

Magnification can be adjusted with the power zoom lever or the zoom buttons below the LCD screen.

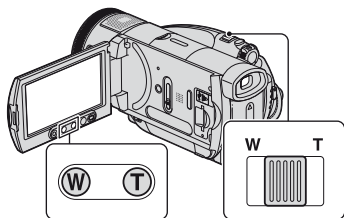

- 1 Play back the still images you want to magnify.
- 2 Magnify the still image with T (Telephoto).  
The screen is framed.
- 3 Touch the screen at the point you want to display in the center of the displayed frame.
- 4 Adjust the magnification with W (Wide angle)/T (Telephoto).

To cancel, touch .

### Notes

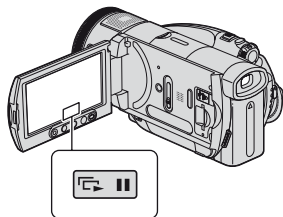

- You cannot change the zoom speed with the zoom buttons below the LCD screen.

## Playing back a series of still images (Slide show)



Touch  on the still image playback screen.

The slide show begins from the selected image.

Touch  to stop the slide show. To restart, touch  again.

### Tips

- You can set continuous slide show playback using [SLIDE SHOW SET] on  (OPTION). The default setting is [ON] (continuous playback).

### Notes

- You cannot operate playback zoom during slide show.

# Playing the image on a TV

Connection methods and quality of the image viewed on the TV screen differ depending on what type of TV is connected, and the connectors used.

Use the supplied AC Adaptor as the power source (p. 24).

Refer also to the instruction manuals supplied with the device to be connected.

## Operation flow

You can make sure that you are connecting the TV correctly using [TV CONNECT Guide] displayed on the LCD screen.

### Switch the input on the TV to the connected jack.

Refer to the instruction manuals of the TV.

↓  
**Connect your camcorder and TV referring to [TV CONNECT Guide].**

↓  
**Make the required output settings on your camcorder (page 45).**

## Jacks on your camcorder

Open the jack cover and connect the cable.

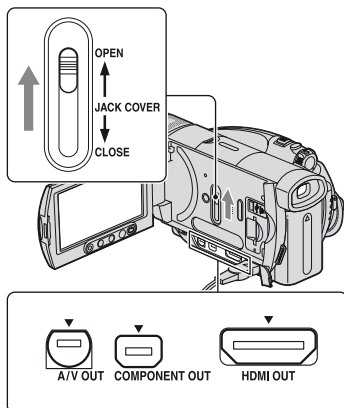

## Selecting the most advantageous connection - TV CONNECT Guide

Your camcorder will advise you of the most advantageous way of connecting your TV.

- 1 Turn on your camcorder, and press **↑** (HOME).
- 2 Touch **+** (SELECT DEVICES).
- 3 Touch [TV CONNECT Guide].
- 4 Touch the option that is right for you on the screen.

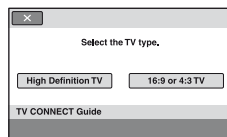

Meanwhile, you can make the relevant connection between your camcorder and the TV.



## Connecting to a high definition TV

Images recorded with HD (high definition) image quality are played back with HD (high definition) image quality. Images recorded with SD (standard definition) image quality are played back with SD (standard definition) image quality.

### Input jacks on the TV

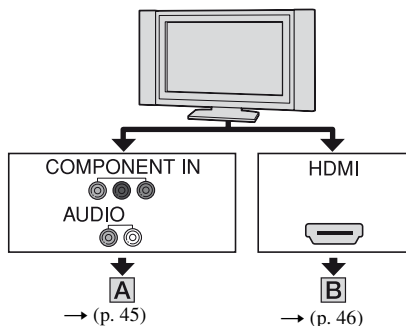

⇨: Signal flow

Type	Camcorder	Cable	TV	HOME MENU setting
------	-----------	-------	----	-------------------

**A**

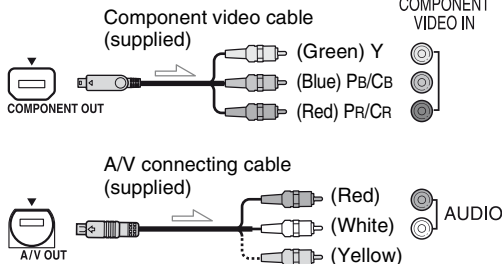

(SETTINGS) →  
[OUTPUT SETTINGS] →  
→ [COMPONENT] →  
[1080i/576i] (p. 74)

### Notes

- An A/V connecting cable is also needed to output audio signals. Connect the white and red plugs of the A/V connecting cable to the audio input jack of your TV.

## Playing the image on a TV (Continued)

 : Signal flow

Type	Camcorder	Cable	TV	HOME MENU setting
------	-----------	-------	----	-------------------

**B**

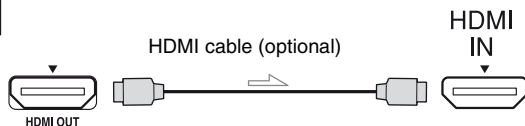

### Notes

- Use an HDMI cable with the HDMI logo.
  - Images are not output from the HDMI OUT jack, if copyright protection signals are recorded in the images.
  - Some TVs may not function correctly (e.g., no sound or image) with this connection.
  - Do not connect the HDMI OUT jack of your camcorder and HDMI OUT jack of the external device with the HDMI cable. This may cause a malfunction.
-

## Connecting to a non-high-definition 16:9 (wide) or 4:3 TV

Images recorded with HD (high definition) quality is converted to SD (standard definition) and played back. Images recorded with SD (standard definition) image quality are played back with SD (standard definition) image quality.

### Input jacks on the TV

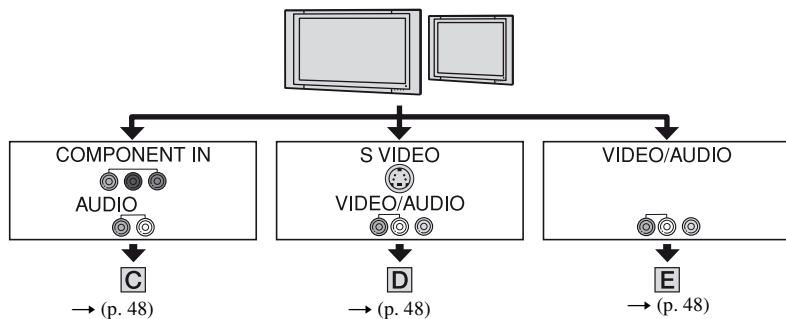

### To set the aspect ratio according to the connected TV (16:9/4:3)

Set [TV TYPE] to [16:9] or [4:3] according to your TV (p. 74).

#### Notes

- When you play back a movie recorded with SD (standard definition) image quality on a 4:3 TV that is not compatible with the 16:9 signal, display the HOME MENU, then select  (SETTINGS) → [MOVIE SETTINGS] → [WIDE SELECT] → [4:3] on your camcorder when recording an image (p. 67).

## Playing the image on a TV (Continued)

 : Signal flow

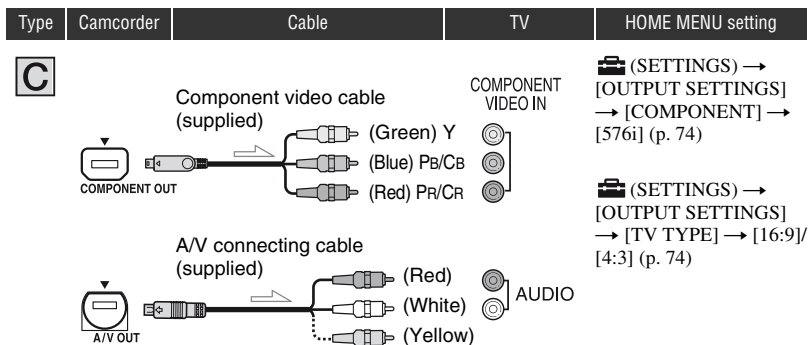

### Notes

- An A/V connecting cable is also needed to output audio signals. Connect the white and red plugs of the A/V connecting cable to the audio input jack of your TV.

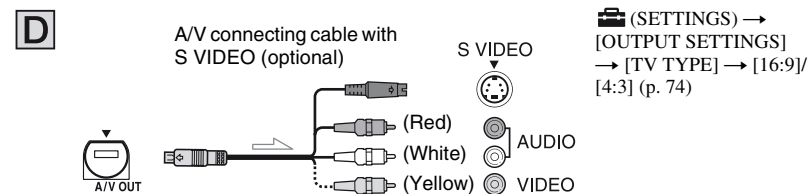

### Notes

- When the S VIDEO plug (S VIDEO channel) is connected, audio signals are not output. To output audio signals, connect the white and red plugs of an A/V connecting cable with the S VIDEO cable to the audio input jack of your TV.
- This connection produces higher resolution images compared with the A/V connecting cable (Type **E**).

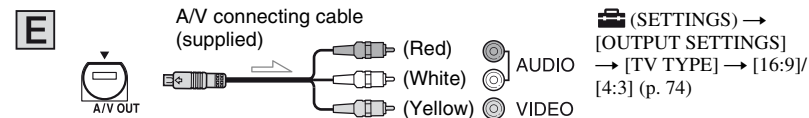

## When connecting to your TV via a VCR

Connect your camcorder to the LINE IN input on the VCR using the A/V connecting cable. Set the input selector on the VCR to LINE (VIDEO 1, VIDEO 2, etc.).

## When your TV is monaural (When your TV has only one audio input jack)

Connect the yellow plug of the A/V connecting cable to the video input jack and connect the white (left channel) or red (right channel) plug to the audio input jack of your TV or VCR. When you want to play the sound in monaural mode, use a connecting cable for that purpose.

## If your TV/VCR has a 21-pin adaptor (EUROCONNECTOR)

Use a 21-pin adaptor (optional) to view playback images.

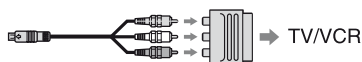

### 🔊 Notes

- When the A/V connecting cable is used to output images, images are output with SD (standard definition) image quality.

### 💡 Tips

- If you connect your camcorder to your TV using more than one type of cable to output images, the order of priority of the output signal is as follows:  
HDMI → component video → S VIDEO → audio/video.
- HDMI (High Definition Multimedia Interface) is an interface to send both video/audio signals. The HDMI OUT jack outputs high quality images and digital audio.

# Saving images

Recorded images are stored on the internal hard disk of your camcorder. Due to the limited capacity of the internal hard disk, make sure that you save the image data to some type of external media such as a DVD-R or a computer.

You can save the images recorded on the camcorder as described below.

## Saving images using a computer

By using the software on the supplied CD-ROM, the quality of your recorded images is maintained even when the image is saved on a disc.

You can rewrite movies with HD (high definition) image quality from the computer to your camcorder, if necessary.

### Creating a disc with One Touch (One Touch Disc Burn)

You can save images recorded on the camcorder directly to a disc with ease. You can select a data type to be saved on a disc on the HOME MENU (p. 76).

### Saving images on a computer (Easy PC Back-up)

You can save images recorded on the camcorder on the hard disk of a computer.



### Creating a disc with selected images

You can save images copied to your computer on a disc. You can also edit those images.



See “First Step Guide” on the supplied CD-ROM.



## Saving images by connecting your camcorder to other devices

### Dubbing to VCR or DVD/HDD devices



See “Dubbing to VCR or DVD/HDD recorders” on page 58.



## (OTHERS) category

This category enables you to edit the images on the hard disk or a “Memory Stick Duo.”

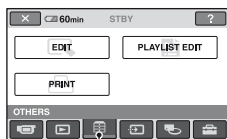

(OTHERS) category

### Item list

#### EDIT

You can edit the images on the hard disk or a “Memory Stick Duo” (p. 51, 52).

#### PLAYLIST EDIT

You can create and edit a Playlist (p. 54).

#### PRINT

You can print still images on a connected PictBridge printer (p. 59).

## Deleting images

### Deleting the images on the hard disk

You can free hard disk space by deleting image data from the camcorder. You can check the free hard disk space of the camcorder using [INFO] (p. 63).

#### Notes

- Important data should be saved on external media (p. 50).
- Do not try to delete the files on the hard disk of the camcorder using a computer.

**1** Turn on your camcorder, then press (HOME).

**2** Touch (OTHERS) → [EDIT].

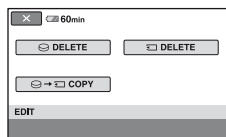

**3** Touch [DELETE].

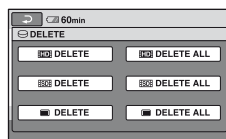

**4** Touch [ DELETE], [ DELETE], or [ DELETE], according to the type of image you want to delete.

## Deleting images (Continued)





### 5 Touch the image to be deleted.



The selected scene is marked with ✓. Press and hold the image on the LCD screen to confirm the image. Touch  to return to the previous screen.

### 6 Touch → [YES] → .

## To delete all images of the same type (on each tab) at one time

In step 4, touch [] DELETE ALL/ [] DELETE ALL/ [] DELETE ALL → [YES] → [YES] → .

### Notes

- Images cannot be restored once they are deleted.
- If the deleted movie is included in the Playlist (p. 54), the movie is deleted also from the Playlist.
- To delete all images recorded in the hard disk, and recover all the recordable space of hard disk, format the hard disk (p. 62).

### Tips

- You can select up to 100 images at one time.
- You can delete an image when viewing it using [DELETE] on .

## Deleting the still images in the “Memory Stick Duo”

### 1 Turn on your camcorder, then press .

### 2 Touch (OTHERS) → [EDIT].

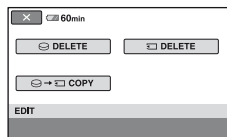

### 3 Touch [] DELETE].

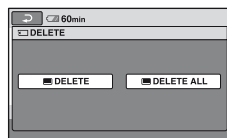

### 4 Touch [] DELETE].

### 5 Touch the still image to be deleted.



The selected still image is marked with ✓.

Press and hold the still image on the LCD screen to confirm the still image.

Touch  to return to the previous screen.



# Copying still images

---

**6** Touch **[OK]** → **[YES]** → **[OK]**.

---

## To delete all still images on the “Memory Stick Duo”

In step 4, touch **[DELETE ALL]** → **[YES]** → **[YES]** → **[OK]**.

### Notes

- You cannot restore still images once they are deleted.
- You cannot delete still images when a “Memory Stick Duo” with the write-protect tab is set to the write-protect position (p. 112), or when the selected image is protected.

### Tips

- You can select up to 100 still images at one time.
- You can delete a still image when viewing it using **[DELETE]** on **[OPTION]**.
- To delete all images recorded on the “Memory Stick Duo,” format the “Memory Stick Duo” (p. 62).

You can copy still images from the hard disk to a “Memory Stick Duo.” Insert a “Memory Stick Duo” in your camcorder before the operation.

---

**1** Turn on your camcorder, then press **⬆** (HOME).

---

**2** Touch **[OTHERS]** → **[EDIT]**.

---

**3** Touch **[COPY]**.

---

**4** Touch the still image to be copied.



The selected still image is marked with **✓**. Press and hold the image on the LCD screen to confirm the image. Touch **[RETURN]** to return to the previous screen.

---

**5** Touch **[OK]** → **[YES]**.  
Copying starts.

---

**6** When **[Completed.]** appears, touch **[OK]**.

---

### 🔊 Notes

- Use the AC Adaptor as the power source to prevent your camcorder from running out of power during copying.
- Do not apply shock or vibration to your camcorder, and do not disconnect the AC Adaptor during copying.
- It may take long when there are many still images to be copied.
- You cannot copy still images on a “Memory Stick Duo” to the hard disk.

### 💡 Tips

- You can select up to 100 still images at one time.
- You can copy a still image when viewing it using [COPY→] on [OPTION].

## Creating the Playlist

A Playlist is a list showing thumbnails of the movies that you have selected. The original scenes are not changed even though you edit or delete the scenes in the Playlist.

Playlist 📖 Glossary (p. 130)

### 🔊 Notes

- Images with HD (high definition) image quality and SD (standard definition) image quality are added to an individual Playlist.

---

**1** Turn on your camcorder, then press **🏠 (HOME)**.

---

**2** Touch **☰ (OTHERS)** → **[PLAYLIST EDIT]**.

---

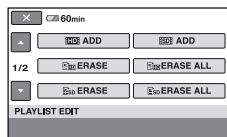

**3** Touch **[HD] ADD** or **[SD] ADD**.

---

**4** Touch the scene to be added to the Playlist.



The selected scene is marked with **✓**. Press and hold the image on the LCD screen to confirm the image.

Touch **⏪** to return to the previous screen.

---

**5** Touch **[OK]** → **[YES]** → **[OK]**.

---

#### Notes

- Do not remove the battery pack or the AC Adaptor from your camcorder while editing the Playlist. It may damage the hard disk.
- You cannot add still images to a Playlist.

#### Tips

- You can add a maximum of 999 movies with HD (high definition) image quality, or 99 movies with SD (standard definition) image quality to the Playlist.
- You can add a movie when viewing it using **[FHD ADD]** or **[FSD ADD]** on **[OPTION]**.
- You can copy the Playlist to a disc as it is, by using the supplied software (p. 84).

### Playing the Playlist

---

**1** Turn on your camcorder, then press **[HOME]**.

---

**2** Touch **[VIEW IMAGES]** → **[PLAYLIST]**.

The Playlist screen appears.



---

**3** Touch the **[FHD]** or **[FSD]** tab to select the image type to be played.

---

---

**4** Touch the scene from which you want to playback.

The Playlist is played back from the selected scene to the end, then the screen returns to the Playlist screen.

---

### Erasing unnecessary scenes from the Playlist

---

**1** Turn on your camcorder, then press **[HOME]**.

---

**2** Touch **[OTHERS]** → **[PLAYLIST EDIT]**.

---

**3** Touch **[FHD ERASE]** or **[FSD ERASE]**.

---

**4** Select the scene to be deleted from the list.



The selected scene is marked with **✓**.

Press and hold the image on the LCD screen to confirm the image.

Touch **[RETURN]** to return to the previous screen.

---

**5** Touch **[OK]** → **[YES]** → **[OK]**.

---

## Creating the Playlist (Continued)

### To erase all the scenes from the Playlist

In step 3, touch [ERASE ALL] or [ERASE ALL] → [YES] → [YES] → [OK].

#### 💡 Tips

- The original scenes are not changed even if you erase the scenes from the Playlist.

## Changing the order within the Playlist

**1** Turn on your camcorder, then press **HOME**.

**2** Touch **OTHERS** → **PLAYLIST EDIT**.

**3** Touch [MOVE] or [MOVE].

**4** Select the scene to be moved.



The selected scene is marked with ✓.

Press and hold the image on the LCD screen to confirm the image.

Touch [RETURN] to return to the previous screen.

**5** Touch [OK].

**6** Select the destination with [←]/ [→].

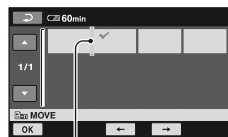

Destination bar

Press and hold the image on the LCD screen to confirm the image.

**7** Touch [OK] → [YES] → [OK].

#### 💡 Tips

- When you select multiple scenes, the scenes are moved following the order appeared in the Playlist.

## (SELECT DEVICES) category

This category enables you to utilize your camcorder connected to other devices.

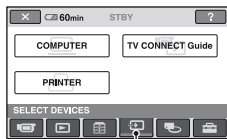

 (SELECT DEVICES) category

### Item list

#### COMPUTER

Your camcorder can be connected to your computer (p. 84).

#### TV CONNECT Guide

Your camcorder advises you of the most advantageous way of connecting your TV to view images on the TV (p. 44).

#### PRINTER

You can print still images on a connected PictBridge printer (p. 59).

## Dubbing images

By connecting your camcorder to a VCR, DVD/HDD recorder, or a computer, you can dub images.

The image quality, HD (high definition) or SD (standard definition), of the dubbed image depends on the device connected.

### Notes

- An image recorded with SD (standard definition) image quality cannot be converted to HD (high definition) image quality.

### Quality of dubbed images by connecting other devices

When dubbing the images to VCR or DVD/HDD recorder (p. 58).

Image quality of recorded images		Image quality of dubbed images
HD	→	SD
SD	→	SD

### Quality of dubbed images by copying in a computer

"Picture Motion Browser" on the CD-ROM (supplied) must be installed on the computer (p. 86).

### Disc creation with One Touch (One Touch Disc Burn)

Image quality of recorded images		Image quality of created discs
HD	→	HD
SD	→	SD

### Creating a disc with images edited on a computer

Image quality of recorded images		Image quality of created discs
HD	→	HD or SD
SD	→	SD

HD: High definition

SD: Standard definition

# Dubbing to VCR or DVD/HDD recorders

You can dub images played back on your camcorder to other recording devices, such as VCRs or DVD/HDD recorders. Connect the device in either of the following ways.

Connect your camcorder to the wall socket using the supplied AC Adaptor for this operation (p. 24). Refer also to the instruction manuals supplied with the devices to be connected.

## Notes

- **Movies recorded with HD (high definition) image quality will be dubbed with SD (standard definition) image quality.**
- To copy a movie recorded with HD (high definition) image quality, install the application software (supplied) on your computer (p. 86), and copy the images to a disc in the computer.
- Since dubbing is performed via analog data transfer, the image quality may deteriorate.

A/V OUT jack

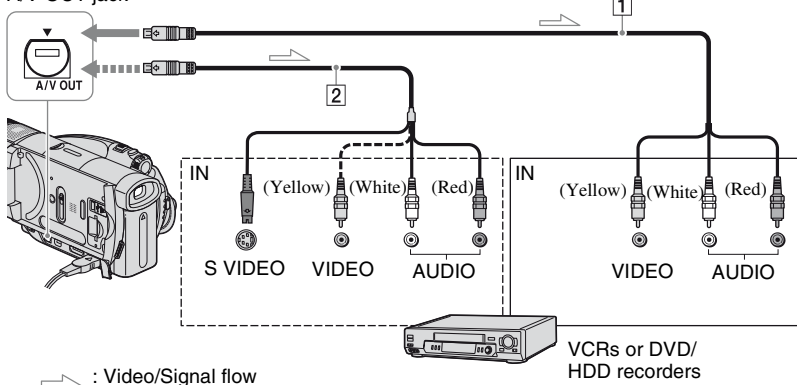

↗ : Video/Signal flow

### 1 A/V connecting cable (supplied)

Connect to the input jack of the other device.

### 2 A/V connecting cable with S VIDEO (optional)

When connecting to another device via the S VIDEO jack, by using an A/V connecting cable with an S VIDEO cable (optional), higher quality images can be produced than with an A/V connecting cable. Connect the white and red plug (left/right audio) and the S VIDEO plug (S VIDEO channel) of the A/V connecting cable with an S VIDEO cable (optional). The yellow plug connection is not necessary. S VIDEO connection only will not output audio.

## Notes

- You cannot dub to recorders connected with an HDMI cable.
- To hide the screen indicators (such as a counter, etc.) on the screen of the monitor device connected, set **(SETTINGS)** → **[OUTPUT SETTINGS]** → **[DISP OUTPUT]** → **[LCD PANEL]** (the default setting) on the HOME MENU (p. 74).
- To record the date/time and camera settings data, display them on the screen (p. 72).
- When you are connecting your camcorder to a monaural device, connect the yellow plug of the A/V connecting cable to the video input jack, and the red (right channel) or the white (left channel) plug to the audio input jack on the device.

---

## 1 Turn on your camcorder, and press (VIEW IMAGES).

Set [TV TYPE] according to the display device (p. 74).

---

## 2 Insert the recording media in the recording device.

If your recording device has an input selector, set it to the input mode.

---

## 3 Connect your camcorder to the recording device (VCR or DVD/HDD recorder) with the A/V connecting cable (supplied) or an A/V connecting cable with S VIDEO (optional) .

Connect your camcorder to the input jacks of the recording device.

---

## 4 Start the playback on your camcorder, and record it on the recording device.

Refer to the instruction manuals supplied with your recording device for details.

---

## 5 When dubbing is finished, stop the recording device, and then your camcorder.

---

# Printing recorded images (PictBridge compliant printer)

You can print out still images using a PictBridge compliant printer, without connecting the camcorder to a computer.

## PictBridge

Connect your camcorder to the AC Adaptor to obtain power from the wall socket (p. 24). Turn on the printer.

To print still images on a “Memory Stick Duo,” insert the “Memory Stick Duo” containing them into your camcorder.

## Connecting your camcorder to the printer

---

### 1 Turn on your camcorder.

---

### 2 Connect the (USB) jack of your camcorder to the printer using the USB cable.

[USB SELECT] appears on the screen automatically.

---

### 3 Touch → PRINT or → PRINT depending on the media of the image to be printed.

When connection is complete,  (PictBridge connecting) appears on the screen.

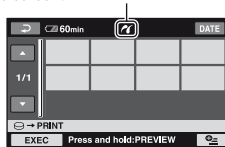

You can select a still image on the screen.

---

### Notes

- We can guarantee the operation of only models that are PictBridge compatible.

## Printing

### 1 Touch the still image to be printed.



The selected image is marked with ✓.

Press and hold the image on the LCD screen to confirm the image.

Touch [↶] to return to the previous screen.

### 2 Set the following options on the OPTION MENU, then touch [OK].

[COPIES]: Set number of copies of a still image to be printed. You can set up to 20 copies.

[DATE/TIME]: Select [DATE], [DAY&TIME], or [OFF] (no date/time printed).

[SIZE]: Select the paper size.

If you do not change the setting, go to step 3.

### 3 Touch [EXEC] → [YES] → [OK].

The image selection screen appears again.

### Notes

- Refer also to the instruction manual of the printer to be used.
- Do not attempt the following operations when [✓] is on the screen. The operations may not be performed properly.
  - To operate the POWER switch.
  - To press [VIEW IMAGES].
  - To disconnect the USB cable from your camcorder or the printer.
  - To remove the “Memory Stick Duo” from your camcorder, in the case of [PRINT].
- If the printer stops working, disconnect the USB cable, turn the printer off and on again, and restart the operation from the beginning.
- You can select only the paper sizes that the printer can print.
- On some printer models, the top, bottom, right, and left edges of images may be trimmed. If you print a still image recorded in a 16:9 (wide) ratio, the left and right ends of the image may be trimmed widely.
- Some printer models may not support the date printing function. Refer to your printer’s instruction manual for details.
- We cannot guarantee the printing of images recorded with a device other than your camcorder.
- You cannot print still images that have a file size larger than 2 MB or 2304 × 1728 pixels, recorded by other devices.

### Tips

- PictBridge is an industry standard established by the Camera & Imaging Products Association (CIPA). You can print still images without using a computer by connecting a printer directly to a digital video camera or digital still camera, regardless of model or manufacturer.
- You can print a still image when viewing it using [PRINT] on [OPTION].

## To finish printing

Touch [↶] on the image selection screen.



## (MANAGE HDD/MEMORY) category

This category enables you to use the hard disk or a “Memory Stick Duo” for various purposes.

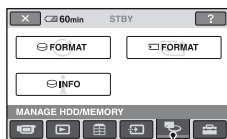

 (MANAGE HDD/MEMORY) category

### Item list

#### **FORMAT**

You can format the hard disk and recover recordable free space (p. 62).

#### **FORMAT**

You can format the “Memory Stick Duo” and recover the recordable free space (p. 62).

#### **INFO**

You can display the hard disk capacity (p. 63).

# Deleting all scenes on the recording media (Formatting)

## Formatting the hard disk

You can delete all the images on the hard disk of the camcorder to recover recordable free space to allow you to write in.

### Notes

- To avoid the loss of important images, you should save them (p. 50) before performing [FORMAT].

**1** Turn on your camcorder, then press **↑** (HOME).

**2** Touch **MANAGE HDD/MEMORY** → [FORMAT].

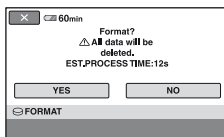

**3** Touch [YES] → [YES].

**4** When [Completed.] appears, touch [OK].

### Notes

- While [FORMAT] is activated, do not remove the AC Adaptor or the battery pack.

## Formatting the “Memory Stick Duo”

Formatting deletes all images on a “Memory Stick Duo.”

**1** Turn on your camcorder.

**2** Insert the “Memory Stick Duo” to be formatted into your camcorder.

**3** Press **↑** (HOME).

**4** Touch **MANAGE HDD/MEMORY** → [FORMAT].

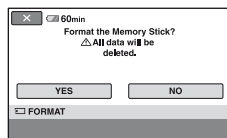

**5** Touch [YES] → [YES].

**6** When [Completed.] appears, touch [OK].

### Notes

- Even the still images protected with another device against accidental deletion are also deleted.
- Do not attempt the following operations when [Executing...] is on the screen:
  - To operate the POWER switch or buttons
  - To remove the “Memory Stick Duo”

# Checking the HDD information

You can display the hard disk information, and check the approximate amount of free hard disk space.

---

**1** Turn on your camcorder, then press **↑** (HOME).

---

**2** Touch **MANAGE HDD/MEMORY** → **INFO**.

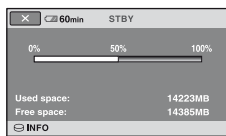

---

## To turn off the display

Touch **×**.

### Notes

- The calculation for hard disk space is 1MB = 1 048 576 bytes. The fractions less than MB are discarded when the hard disk space is displayed. Only the figures that are less than 30 000 MB for available and unavailable hard disk spaces appear.
- Since there is the management file area, the used space is not displayed as 0MB even if you perform **FORMAT** (p. 62).

# What you can do with the (SETTINGS) category of the HOME MENU

You can change the recording functions and the operating settings for your convenience.

## Using the HOME MENU

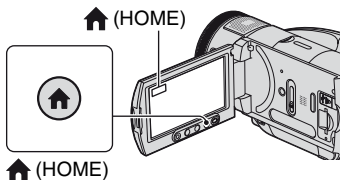

- 1 Turn on your camcorder, then press  (HOME).



- 2 Touch  (SETTINGS).



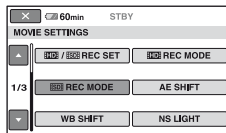

- 3 Touch the desired setup item.

If the item is not on the screen, touch  /  to change the page.



- 4 Touch the desired item.

If the item is not on the screen, touch  /  to change the page.

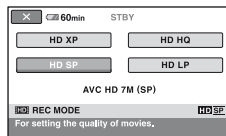

- 5 Change the setting, then touch .

## List of the (SETTINGS) category items

### MOVIE SETTINGS (p. 66)

Items	Page
REC SET	66
REC MODE	66
REC MODE	66
AE SHIFT	66
WB SHIFT	67
NS LIGHT	67
WIDE SELECT	67
DIGITAL ZOOM	67
STEADYSHOT	67
EXP.FOCUS	68
GUIDEFAME	68
ZEBRA	68
REMAINING	68
RING SETTING	68

### PHOTO SETTINGS (p. 69)

Items	Page
IMAGE SIZE	69
QUALITY	71
FILE NO.	71
AE SHIFT	66
WB SHIFT	67
NS LIGHT	67
EXP.FOCUS	68
GUIDEFAME	68
ZEBRA	68
FLASH LEVEL	71
REDEYE REDUC	71
RING SETTING	68
STILL MEDIA	35

### VIEW IMAGES SET (p. 72)

Items	Page
VOLUME	72
DATA CODE	72

### SOUND/DISP SET (p. 73)

Items	Page
BEEP	73
LCD BRIGHT	73
LCD BL LEVEL	73
LCD COLOR	73
VF B.LIGHT	73

### OUTPUT SETTINGS (p. 74)

Items	Page
TV TYPE	74
DISP OUTPUT	74
COMPONENT	74

### CLOCK/ LANG (p. 75)

Items	Page
CLOCK SET	30
AREA SET	75
SUMMERTIME	75
LANGUAGE SET	75

### GENERAL SET (p. 75)

Items	Page
DEMO MODE	75
REC LAMP	75
CALIBRATION	116
A.SHUT OFF	76
REMOTE CTRL	76
DISC BURN SET	76
DROP SENSOR	76

# MOVIE SETTINGS

(Items for recording movies)

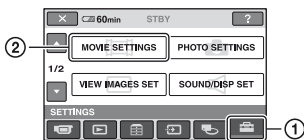

Touch ①, then ②.

If the item is not on the screen, touch ▲/▼ to change the page.

## How to set

⬆️ (HOME MENU) → page 64

⊕ (OPTION MENU) → page 77

The default settings are marked with ▶.

### HD/SD REC SET

You can select a recording format to record a movie.

#### ▶ HD QUALITY

Records with HD (high definition) image quality.

#### SD QUALITY

Records with SD (standard definition) image quality.

### REC MODE

You can select a recording mode to record a movie with HD (high definition) image quality from 4 levels.

#### HD XP

Records in the highest quality mode.  
(AVC HD 15M (XP))

#### HD HQ

Records in high quality mode.  
(AVC HD 9M (HQ))

#### ▶ HD SP

Records in standard quality mode.  
(AVC HD 7M (SP))

#### HD LP

Increases the recording time (Long Play).  
(AVC HD 5M (LP))

#### ⚙️ Notes

- If you record in the LP mode, details in scenes with quick movements may appear rough when you play the image back.

#### 💡 Tips

- See page 15 on the expected recording time of each recording mode.

### REC MODE

You can select a recording mode to record a movie with SD (standard definition) image quality from 3 levels.

#### ▶ SD HQ

Records in high quality mode.  
(SD 9M (HQ)).

#### SD SP

Records in standard quality mode.  
(SD 6M (SP)).

#### SD LP

Increases the recording time (Long Play).  
(SD 3M (LP))

#### ⚙️ Notes

- If you record in the LP mode, the quality of scenes may be degraded, or scenes with quick movements may appear with a block noise when you play back the image.



#### 💡 Tips

- See page 15 on the expected recording time of each recording mode.



### AE SHIFT

Select [ON] to adjust the exposure using (dark)/ (bright). [AS] and the setting value appear when [AE SHIFT] is anything other than the default setting.

## Tips

- Touch  if the subject is white or the backlight is bright, or touch  if the subject is black or the light is dim.
- You can adjust the automatic exposure level to brighter or darker when [EXPOSURE] is set to [AUTO].
- You can also adjust the setting manually using the camera control ring (p. 39).

## WB SHIFT (White Balance Shift)

Select [ON] to adjust the white balance to the desired setting using /[].

**WS** and the setting value appear when [WB SHIFT] is anything other than the default setting.

## Tips

- When the white balance is set to a lower value, images appear bluish, and when set to a higher value, images appear reddish.
- You can also adjust the setting manually using the camera control ring (p. 39).

## NS LIGHT (NightShot Light)

When using either the NightShot (p. 37) or [SUPER NS] (p. 81) function to record, you can record clearer images by setting [NS LIGHT], which emits infrared light (invisible), to [ON] (the default setting).

## Notes

- Do not cover the infrared port with your fingers or other objects (p. 37).
- Remove the conversion lens (optional).
- The maximum shooting distance using [NS LIGHT] is about 3 m (10 feet).

## WIDE SELECT

When recording with SD (standard definition) image quality, you can select the aspect ratio according to the TV connected. Refer also to the instruction manuals supplied with your TV.

## ▶ 16:9 WIDE

Records images to the full screen on a 16:9 (wide) TV screen.

## 4:3 ()

Records images to the full screen on a 4:3 TV screen.

## Notes

- Set [TV TYPE] correctly according to the TV connected for playback (p. 74).

## DIGITAL ZOOM

You can select the maximum zoom level in case you want to zoom to a level greater than 10 × (the default setting) during recording. Note that the image quality decreases when you use the digital zoom.

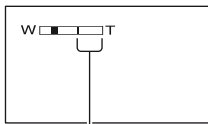

The right side of the bar shows the digital zooming factor. The zooming zone appears when you select the zooming level.

## ▶ OFF

Up to 10 × zoom is performed optically.

## 20 ×

Up to 10 × zoom is performed optically, and after that, up to 20 × zoom is performed digitally.

## 80 ×

Up to 10 × zoom is performed optically, and after that, up to 80 × zoom is performed digitally.

## STEADYSHOT

You can compensate for camera shake (the default setting is [ON]). Set [STEADYSHOT] to [OFF] () when using a tripod (optional), then the image becomes natural.

## MOVIE SETTINGS (Continued)

### EXP.FOCUS (Expanded focus)



Select [ON] so that the image on the screen is magnified by about 2 times when adjusting focus manually (p. 78). The screen returns to the original size automatically when the focusing is finished. Touch [OFF] to release this function.

#### Notes

- You cannot activate this function during recording.
- The function is released if you use the zoom function.

### GUIDEFAME



You can display the frame and check that the subject is horizontal or vertical by setting [GUIDEFAME] to [ON]. The frame is not recorded. Press DISP/BATT INFO to make the frame disappear.

#### Tips

- Positioning the subject at the cross point of the guide frame makes a balanced composition.

### ZEBRA



Diagonal stripes appear in portions of the screen where brightness is at a preset level. This is useful as a guide when adjusting the brightness. When you change the default setting,  is displayed. The zebra pattern is not recorded.

#### OFF

The zebra pattern is not displayed.

#### 70

The zebra pattern appears at a screen brightness level of about 70 IRE.

#### 100

The zebra pattern appears at a screen brightness level of about 100 IRE or higher.

#### Notes

- Portions of the screen where brightness is about 100 IRE or above may appear overexposed.

#### Tips



- IRE represents the screen brightness.

### REMAINING



#### AUTO

Displays the remaining recording time of movies for about 8 seconds in situations such as those described below.

- When your camcorder recognizes the remaining hard disk capacity with the POWER switch set to  (Movie).
- When you press DISP/BATT INFO to switch the indicator from off to on with the POWER switch set to  (Movie).
- When you select the movie recording mode on the HOME MENU.

#### ON

Always displays the remaining hard disk indicator.

#### Notes

- When the remaining recordable time for movies is less than 5 minutes, the indicator stays on the screen.

### RING SETTING



You can assign an item you want to set to the camera control ring and adjust it manually using the camera control ring.

#### FOCUS

Assigns [FOCUS] (p. 78) to the camera control ring.

#### EXPOSURE

Assigns [EXPOSURE] (p. 79) to the camera control ring.

#### AE SHIFT

Assigns [AE SHIFT] (p. 66) to the camera control ring.



# PHOTO SETTINGS

(Items for recording still images)

## WB SHIFT

Assigns [WB SHIFT] (p. 67) to the camera control ring.

### Tips

- You can make this setting also by keeping MANUAL pressed (p. 39).
- See page 39 on further details on the camera control ring.
- Manual settings will be retained even if you change the assigned item of the camera control ring. However, if you set [EXPOSURE] after setting [AE SHIFT] manually, [EXPOSURE] will override [AE SHIFT].



Touch ①, then ②.

If the item is not on the screen, touch ▲/▼ to change the page.

## How to set

🏠 (HOME MENU) → page 64

⊕ (OPTION MENU) → page 77

The default settings are marked with ►.

## IMAGE SIZE



### ► 4.0M (4.0M)

Records still images clearly.

### 3.0M (3.0M)

Records still images clearly in the 16:9 (wide) ratio.

### 1.9M (1.9M)

Allows you to record more still images in relatively clear quality.

### VGA (0.3M) (LVGA)

Allows the maximum number of still images to be recorded.





## Notes

- [IMAGE SIZE] can be set only during recording standby.



## PHOTO SETTINGS (Continued)



### Capacity of the “Memory Stick Duo” (MB) and the number of recordable images

When the POWER switch is  (Still)



	4.0M 2304 × 1728 	3.0M 2304 × 1296 	1.9M 1600 × 1200 	VGA 640 × 480 
16MB	7 18	10 24	16 37	96 240
32MB	15 37	20 48	32 75	190 485
64MB	31 75	41 98	65 150	390 980
128MB	63 150	83 195	130 300	780 1970
256MB	110 270	150 355	235 540	1400 3550
512MB	230 550	305 720	480 1100	2850 7200
1GB	475 1100	620 1450	980 2250	5900 14500
2GB	970 2300	1250 3000	2000 4650	12000 30000

When the POWER switch is  (Movie)\*

	2.3M 2016 × 1134 	1.7M 1512 × 1134 
16MB	13 32	17 40
32MB	27 65	36 85
64MB	54 130	72 170
128MB	105 260	145 340
256MB	195 470	260 590
512MB	400 960	530 1200

	2.3M 2016 × 1134 	1.7M 1512 × 1134 
1GB	820 1950	1050 2450
2GB	1650 4000	2200 5000

\* The image size is fixed as follows depending on the recording image quality:

-  2.3M] with HD (high definition) image quality
-  2.3M] in the aspect ratio 16:9 with SD (standard definition) image quality
- [1.7M] in the aspect ratio 4:3 with SD (standard definition) image quality

### Notes

- All numbers measured at the following setting: Top: [FINE] is selected for image quality. Bottom: [STANDARD] is selected for image quality.
- All numbers measured when using a “Memory Stick Duo” made by Sony Corporation. The number of recordable images varies depending on the recording environment.
- You can record up to 9 999 still images on the hard disk.

### Approximate data size of an image (kB)

#### 4:3 image

4.0M	1.9M	1.7M	VGA
1980	960	860	150
830	420	370	60

#### 16:9 image

3.0M	2.3M
1500	1150
640	480

- Data sizes measured at the following settings: Top: [FINE] is selected for image quality. Bottom: [STANDARD] is selected for image quality.

## QUALITY



### ► FINE (FINE)

Records still images at the fine image quality level.

### STANDARD (STD)

Records still images at the standard image quality level.

## FILE NO.



### ► SERIES

Assigns file numbers in sequence. If an image is deleted, its file number is skipped.

### RESET

Assigns file numbers in sequence, following the largest file number existing on the current recording medium.

## AE SHIFT



See page 66.

## WB SHIFT (White Balance Shift)



See page 67.

## NS LIGHT (NightShot Light)



See page 67.

## EXP. FOCUS



See page 68.

## GUIDEFRAAME



See page 68.

## ZEBRA



See page 68.

## FLASH LEVEL



You can set this function when you use the built-in flash, or an external flash (optional) that is compatible with your camcorder.

### HIGH(↕↕)

Makes the flash level higher.

### ► NORMAL(↕)

### LOW(↕↔)

Makes the flash level lower.

## REDEYE REDUC



You can set this function when you use the built-in flash, or an external flash (optional) that is compatible with your camcorder.

You can prevent redeye by activating the flash before recording.

Set [REDEYE REDUC] to [ON], then press **↕** (flash) (p. 36) repeatedly to select a setting.

(Auto redeye reduction): Pre-flashes to reduce redeye before the flash automatically flashes when there is insufficient ambient light.



(Forced redeye reduction): Always uses the flash and the redeye reducing pre-flash.



(No flash): Records without flash.

- The redeye reduction may not produce the desired effect due to individual differences and other conditions.

## RING SETTING



See page 68.

## STILL MEDIA



See page 35.

# VIEW IMAGES SET

(Items to customize the sound volume and display)



Touch ①, then ②.

If the item is not on the screen, touch ▲/▼ to change the page.

## How to set

🏠 (HOME MENU) → page 64

⊕ (OPTION MENU) → page 77

The default settings are marked with ▶.

## VOLUME



Touch **[-]/[+]** to adjust the volume (p. 41).

## DATA CODE



During playback, displays the information (data code) recorded automatically at the time of recording.

### ▶ OFF

Data code is not displayed.

### DATE/TIME

Displays the date and time.

### CAMERA DATA (below)

Displays camera setting data.

## DATE/TIME

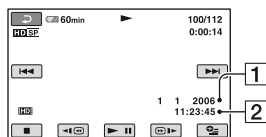

1 Date

2 Time

## CAMERA DATA

### Movie

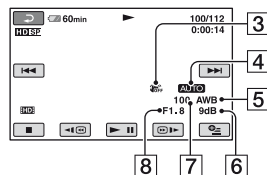

### Still image

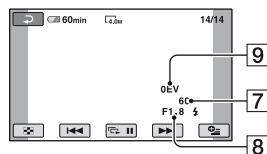

3 SteadyShot off

4 Brightness

5 White balance

6 Gain

7 Shutter speed

8 Aperture value

9 Exposure

## 💡 Tips

- ⚡ appears for an image recorded using a flash.
- The data code is displayed on the TV screen if you connect your camcorder to a TV.
- The indicator toggles through the following sequences as you press DATA CODE on the Remote Commander: [DATE/TIME] → [CAMERA DATA] → [OFF] (no indication).
- Depending on the hard disk condition, bars [--:--:--] appear.

# SOUND/DISP SET

(Items to adjust beep and the screen)

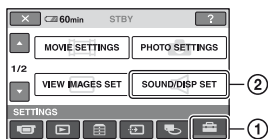

Touch ①, then ②.

If the item is not on the screen, touch ▲/▼ to change the page.

## How to set

⬆️ (HOME MENU) → page 64

⊞ (OPTION MENU) → page 77

The default settings are marked with ▶.

### BEEP

#### ▶ ON

A melody sounds when you start/stop recording, or operate the touch panel.

#### OFF

Cancels the melody.

### LCD BRIGHT

You can adjust the brightness of the LCD screen with  - / + .



#### 💡 Tips

- This adjustment does not affect the recorded images in any way.

### LCD BL LEVEL

You can adjust the brightness of the LCD screen's backlight.

#### ▶ NORMAL

Standard brightness.

#### BRIGHT

Brightens the LCD screen.

#### 📌 Notes

- When you connect your camcorder to outside power sources, [BRIGHT] is automatically selected for the setting.
- When you select [BRIGHT], battery life is slightly reduced during recording.
- If you open the LCD panel 180 degrees to face the screen outside and close the LCD panel to the camcorder body, the setting becomes [NORMAL] automatically.

#### 💡 Tips

- This adjustment does not affect the recorded images in any way.

### LCD COLOR

You can adjust the color of the LCD screen with  - / + .



#### 💡 Tips

- This adjustment does not affect the recorded images in any way.

### VF B. LIGHT

You can adjust the brightness of the viewfinder.

#### ▶ NORMAL

Standard brightness.

#### BRIGHT

Brightens the viewfinder screen.

#### 📌 Notes

- When you connect your camcorder to outside power sources, [BRIGHT] is automatically selected for the setting.
- When you select [BRIGHT], battery life is slightly reduced during recording.

#### 💡 Tips

- This adjustment does not affect the recorded images in any way.

# OUTPUT SETTINGS

(Items for when connecting other devices)

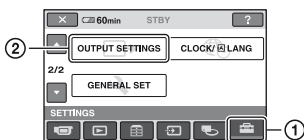

Touch ①, then ②.

If the item is not on the screen, touch ▲/▼ to change the page.

## How to set

⬆️ (HOME MENU) → page 64

⊕ (OPTION MENU) → page 77

The default settings are marked with ▶.

## TV TYPE

You need to convert the signal depending on the TV connected when playing back the image. The recorded images are played back as following illustrations.

### ▶ 16:9

Select this to view your images on a 16:9 (wide) TV.

Wide (16:9) images



4:3 images



### 4:3

Select this to view your images on a 4:3 standard TV.

Wide (16:9) images



4:3 images



## 🔊 Notes

- Aspect ratio of the image recorded with HD (high definition) image quality is 16:9.

## DISP OUTPUT



### ▶ LCD PANEL

Shows displays such as the time code on the LCD screen and in the viewfinder.

### V-OUT/PANEL

Shows displays such as the time code on the TV screen, LCD screen, and in the viewfinder.

## COMPONENT



Select [COMPONENT] when connecting your camcorder to a TV with the component input jack.

### 576i

Select this when connecting your camcorder to a TV with the component input jack.

### ▶ 1080i/576i

Select this when connecting your camcorder to a TV that has the component input jack and is capable of displaying the 1080i signal.

# CLOCK/LANG

(Items to set clock and language)

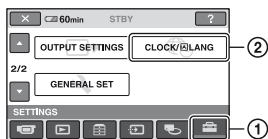

Touch ①, then ②.

If the item is not on the screen, touch ▲/▼ to change the page.

## How to set

🏠 (HOME MENU) → page 64

☰ (OPTION MENU) → page 77

## CLOCK SET



See page 30.

## AREA SET



You can adjust a time difference without stopping the clock.

Set your local area using ▲/▼ when using your camcorder overseas.

Refer to the world time difference on page 109.

## SUMMERTIME



You can change this setting without stopping the clock.

Set to [ON] to move the time forward 1 hour.

## LANGUAGE SET



You can select the language to be used on the LCD screen.

## 💡 Tips

- Your camcorder offers [ENG[SIMP]] (simplified English) for when you cannot find your native tongue among the options.

# GENERAL SET

(Other setup items)

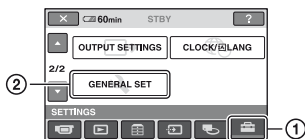

Touch ①, then ②.

If the item is not on the screen, touch ▲/▼ to change the page.

## How to set

🏠 (HOME MENU) → page 64

☰ (OPTION MENU) → page 77

The default settings are marked with ▶.

## DEMO MODE



The default setting is [ON], allowing you to view the demonstration in about 10 minutes, after you slide the POWER switch to (Movie).

## 💡 Tips

- The demonstration will be suspended in situations such as those described below.
  - When you press START/STOP or PHOTO.
  - When you touch the screen during the demonstration (The demonstration starts again after about 10 minutes).
  - When you remove or insert a “Memory Stick Duo.”
  - When you set the POWER switch to (Still).
  - When you press 🏠 (HOME)/▶ (VIEW IMAGES).

## REC LAMP (Recording lamp)



The camera recording lamp will not light up during recording when you set this to [OFF]. (The default setting is [ON].)

## CALIBRATION



See page 116.

### A.SHUT OFF (Auto shut off)



#### ▶ 5 min

The camcorder is automatically turned off when you do not operate your camcorder for more than approximately 5 minutes.

#### NEVER

The camcorder is not automatically turned off.

#### 💡 Tips

- When you connect your camcorder to a wall socket, [A.SHUT OFF] is automatically set to [NEVER].

### REMOTE CTRL (Remote control)



The default setting is [ON], allowing you to use the supplied Remote Commander (p. 126).

#### 🔗 Notes

- Set to [OFF] to prevent your camcorder from responding to a command sent by another VCR remote control unit.

### DISC BURN SET



You can select the data type to be saved on a disc using the One Touch Disc Burn function. See “First Step Guide” on the supplied CD-ROM for details on the One Touch Disc Burn operation.

#### ▶ ALL

Saves all movies with both HD (high definition) image quality and SD (standard definition) image quality, and still images.

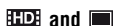

Saves movies with HD (high definition) image quality, and still images.



Saves movies with SD (standard definition) image quality, and still images.

### DROP SENSOR



[DROP SENSOR] is set to [ON] as the default setting. When the drop sensor has detected that the camcorder has been dropped (📵 appears), recording or playing back recorded images may be disabled to protect the internal hard disk.

#### 🔗 Notes

- Set the drop sensor to [ON] (default setting) when you use the camcorder. Otherwise when you drop the camcorder, you may damage the internal hard disk.
- In a non-gravity situation, the drop sensor activates. When you record images during activity such as roller-coasting or skydiving, you can set [DROP SENSOR] to [OFF] (📵<sub>OFF</sub>) so as not to activate the drop sensor.
- [DROP SENSOR] is automatically set to [ON] after you remove the power source for more than 12 hours.



# Activating functions using the OPTION MENU

The OPTION MENU appears just like the pop-up window that appears when you right-click the mouse on a computer. Various functions are displayed in the context of the operation.

## Using the OPTION MENU

### Notes

- The tabs and items that appear on the screen depend on the recording/playback status of your camcorder at the time.
- Some items appear without a tab.

**1** While using your camcorder, touch  (OPTION) on the screen.

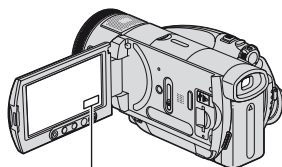

 (OPTION)

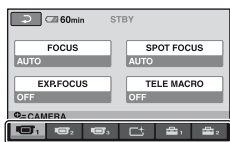

Tab

**2** Touch the desired item.

If you cannot find the desired item, touch another tab to change the page.

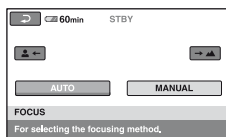









**3** Change the setting, then touch .

## When the item you want is not on the screen

Touch another tab. If you cannot find the item anywhere, the function does not work under the situation.

# Recording items on the OPTION MENU

See page 77 for setting operation.

Items	▲*	Page
 <b>tab</b>		
<b>FOCUS</b>	-	78
<b>SPOT FOCUS</b>	-	79
<b>EXP.FOCUS</b>	○	68
<b>TELE MACRO</b>	-	79
<b>EXPOSURE</b>	-	79
<b>SPOT METER</b>	-	79
<b>AE SHIFT</b>	○	66
<b>PROGRAM AE</b>	-	80
<b>WHITE BAL.</b>	-	80
<b>WB SHIFT</b>	○	67
<b>COLOR SLOW S</b>	-	81
<b>SUPER NS</b>	-	81
 <b>tab</b>		
<b>FADER</b>	-	81
<b>D.EFFECT</b>	-	82
<b>PICT.EFFECT</b>	-	82
 <b>tab</b>		
  <b>REC SET</b>	○	66
 <b>REC MODE</b>	○	66
 <b>REC MODE</b>	○	66
<b>MICREF LEVEL</b>	-	82
<b>GUIDEFAME</b>	○	68
<b>ZEBRA</b>	○	68
<b>FLASH LEVEL</b>	○	71
<b>REDEYE REDUC</b>	○	71
 <b>QUALITY</b>	○	71
 <b>IMAGE SIZE</b>	○	69
<b>SELF-TIMER</b>	-	83
<b>STILL MEDIA</b>	○	35
<b>TIMING</b>	-	38

\* Items that are included also in the HOME MENU.

Items you can set only on the OPTION MENU will be described below.





The default settings are marked with ►.

## FOCUS



You can adjust the focus manually. You can select this function also when you want to focus on a certain subject intentionally.



- ① Touch [MANUAL].  
 appears.
- ② Touch  (focusing on close subjects)/  (focusing on distant subjects) to sharpen the focus.  appears when the focus cannot be adjusted any closer, and  appears when the focus cannot be adjusted farther away.
- ③ Touch [OK].

To adjust the focus automatically, touch [AUTO] → [OK] in step ①.

- It is easier to focus on the subject by moving the power zoom lever towards T (telephoto) to adjust the focus, then towards W (wide angle) to adjust the zoom for recording. When you want to record a subject at close range, move the power zoom lever to W (wide angle), then adjust the focus.
- The minimum possible distance between camcorder and subject while maintaining sharp focus is about 1 cm (about 13/32 in.) for wide angle and about 80 cm (about 2 5/8 feet) for telephoto.
- The setting returns to [AUTO] when you set the POWER switch to OFF (CHG) for more than 12 hours.
- You can also adjust the focus manually using the camera control ring (p. 39).

## SPOT FOCUS



You can select and adjust the focal point to aim it at a subject not located at the center of the screen.

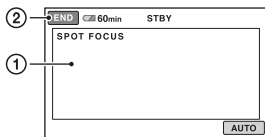

① Touch the subject on the screen.

appears.

② Touch [END].

To adjust the focus automatically, touch [AUTO] → [END] in step ①.

- If you set [SPOT FOCUS], [FOCUS] is automatically set to [MANUAL].
- The setting returns to [AUTO] when you set the POWER switch to OFF (CHG) for more than 12 hours.

## TELE MACRO



This is useful to shoot small subjects, such as flowers or insects. You can blur out backgrounds and the subject stands out clearer.

When you set [TELE MACRO] to [ON] (T), the zoom (p. 35) moves to the top of the T (telephoto) side automatically and allows recording subjects at a close distance, down to about 37 cm (14 5/8 in.).



To cancel, touch [OFF], or zoom to wide-angle (W side).

- When recording a distant subject, focusing may be difficult and can take some time.
- Adjust the focus manually ([FOCUS], p. 78) when it is hard to focus automatically.

## EXPOSURE



You can fix the brightness of a picture manually. Adjust the brightness when the subject is too bright or too dark.

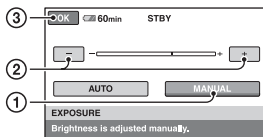

① Touch [MANUAL].

appears.

② Adjust the exposure by touching / .

③ Touch [OK].

To return the setting to automatic exposure, touch [AUTO] → [OK] in step ①.

- The setting returns to [AUTO] when you set the POWER switch to OFF (CHG) for more than 12 hours.
- You can also adjust the setting manually using the camera control ring (p. 39).

## SPOT METER (Flexible spot meter)



You can adjust and fix the exposure to the subject, so that it is recorded in suitable brightness even when there is strong contrast between the subject and the background, such as subjects in the spotlight on stage.

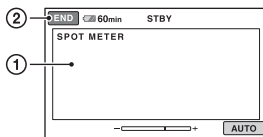

① Touch the point where you want to fix and adjust the exposure on the screen.

appears.

## Recording items on the OPTION MENU (Continued)

### ② Touch [END].

To return the setting to automatic exposure, touch [AUTO] → [END] in step ①.

- If you set [SPOT METER], [EXPOSURE] is automatically set to [MANUAL].
- The setting returns to [AUTO] when you set the POWER switch to OFF (CHG) for more than 12 hours.

## PROGRAM AE



You can record images effectively in various situations with the [PROGRAM AE] function.

### ▶ AUTO

Select this to automatically record images effectively without the [PROGRAM AE] function.

### SPOTLIGHT\* (☹)

Select this to prevent people's faces from appearing excessively white when subjects are lit by strong light.



### PORTRAIT (Soft portrait) (👤)



Select this to bring out the subject such as people or flowers while creating a soft background.

### BEACH&SKI\* (🌴)



Select this to prevent people's faces from appearing dark in strong light or reflected light, such as at a beach in midsummer or on a ski slope.

### SUNSET&MOON\*\* (☾)



Select this to maintain the atmosphere of situations such as sunsets, general night views or fireworks.

### LANDSCAPE\*\* (🏞)



Select this to shoot distant subjects clearly. This setting also prevents your camcorder from focusing on glass or metal mesh in windows that comes in between the camcorder and the subject.

- Items with one asterisk (\*) are adjusted to focus on subjects only a short distance away. Items with two asterisks (\*\*) are adjusted to focus on subjects farther away.
- The setting returns to [AUTO] when you set the POWER switch to OFF (CHG) for more than 12 hours.

## WHITE BAL. (White balance)



You can adjust the color balance to the brightness of the recording environment.

### ▶ AUTO

The white balance is adjusted automatically.

### OUTDOOR (☀)

The white balance is adjusted to be appropriate for the following recording conditions:

- Outdoors
- Night views, neon signs and fireworks
- Sunrise or sunset
- Under daylight fluorescent lamps

### INDOOR (☾)

The white balance is adjusted to be appropriate for the following recording conditions:

- Indoors
- At party scenes or studios where the lighting conditions change quickly
- Under video lamps in a studio, or under sodium lamps or incandescent-like color lamps

## ONE PUSH (📷)

The white balance will be adjusted according to the ambient light.

- ① Touch [ONE PUSH].
- ② Frame a white object such as a piece of paper, to fill the screen under the same lighting conditions as you will shoot the subject.
- ③ Touch [📷].  
📷 flashes quickly. When the white balance has been adjusted and stored in the memory, the indicator stops flashing.
  - Keep framing a white object while 📷 is flashing quickly.
  - 📷 flashes slowly if white balance could not be set.
  - If 📷 keeps flashing even after you have touched [OK], set [WHITE BAL.] to [AUTO].

- If you changed the battery pack, or moved your camcorder to or from outdoors when [AUTO] was selected, aim your camcorder at a nearby white object with [AUTO] for about 10 seconds for better color balance adjustment.
- Redo the [ONE PUSH] procedure if you change the [PROGRAM AE] settings, or bring your camcorder outdoors from inside the house, or vice versa.
- Set [WHITE BAL.] to [AUTO] or adjust the color in [ONE PUSH] under white or cool white fluorescent lamps.
- The setting returns to [AUTO] when you set the POWER switch to OFF (CHG) for more than 12 hours.

## COLOR SLOW S (Color Slow Shutter)



When you set [COLOR SLOW S] to [ON], you can record an image brighter in color even in dark places.

📷 appears on the screen.

To cancel [COLOR SLOW S], touch [OFF].

- Adjust the focus manually ([FOCUS], p. 78) when it is hard to focus automatically.

- The shutter speed of your camcorder changes depending on the brightness, which may result in a slowdown of the motion of the image.

## SUPER NS (Super NightShot)



The image will be recorded at a maximum of 16 times the sensitivity of NightShot recording if you set [SUPER NS] to [ON] while the NIGHTSHOT switch (p. 37) is also set to ON.

📷 appears on the screen.

To return to the normal setting, set [SUPER NS] to [OFF].

- Do not use [SUPER NS] in bright places. This may cause a malfunction.
- Do not cover the infrared port with your fingers or other objects (p. 37).
- Remove the conversion lens (optional).
- Adjust the focus manually ([FOCUS], p. 78) when it is hard to focus automatically.
- The shutter speed of your camcorder changes depending on the brightness, which may result in a slowdown of the motion of the image.

## FADER



You can record a transition with the following effects adding to the interval between scenes.

- ① Select the desired effect in [STBY] (during fading in) or [REC] (during fading out) mode, then touch [OK].
- ② Press START/STOP.

The fader indicator stops flashing and disappears when the fade is complete.

To cancel the fader before starting the operation, touch [OFF] in step ①. If you press START/STOP, the setting is canceled.



## Recording items on the OPTION MENU (Continued)

### WHITE FADER



### BLACK FADER



### D.EFFECT (Digital effect)



You can add digital effects to your recordings. **[D+]** appears.

- ① Touch the desired effect.
- ② When you select **[LUMI. KEY]**, adjust the effect with **[-]/[+]**, then touch **[OK]**.  
The image displayed when you touch **[OK]** is saved as a still image.
- ③ Touch **[OK]**.  
**[D+]** appears.

To cancel **[D.EFFECT]**, touch **[OFF]** in step ①.

### LUMI. KEY (luminance key)

A brighter area in a still image at the moment you select **[LUMI. KEY]** is replaced by a movie.



### OLD MOVIE

Adds an old movie effect to images. The scene is recorded in the 16:9 (wide) mode.

- The aspect ratio cannot be changed when **[OLD MOVIE]** is selected.

### PICT.EFFECT (Picture effect)



You can add special effects to an image during recording or playback. **[P+]** appears.

#### ▶ OFF

Does not use **[PICT.EFFECT]** setting.

#### SEPIA

Images appear in sepia.

#### B&W

Images appear in black and white.

#### PASTEL\*



Images appear as a pale pastel drawing.

### MICREF LEVEL



You can select the microphone level for recording sound.

Select **[LOW]** when you want to record exciting and powerful sound in a concert hall, etc.

#### ▶ NORMAL

Records various surround sounds, converting them into the certain level.

#### LOW (↑↓)

Records surround sound faithfully. This setting is not suitable for recording conversations.

- The setting returns to **[NORMAL]** when you set the **POWER** switch to **OFF (CHG)** for more than 12 hours.

## SELF-TIMER



The self-timer starts recording a still image after about 10 seconds.

Press PHOTO when [SELF-TIMER] is set to [ON], and appears.

To cancel the count down, touch [RESET]. To cancel the self-timer, select [OFF].

- You can also operate by pressing PHOTO on the Remote Commander (p. 126).

# Viewing items on the OPTION MENU

See page 77 for setting operation.

Items	*	Page
tab		
DELETE	<input type="radio"/>	51
DELETE ALL	<input type="radio"/>	52
tab		
ERASE	<input type="radio"/>	55
ERASE ALL	<input type="radio"/>	56
MOVE	<input type="radio"/>	56
COPY →	-	53
-- (A tab depends on the situation)		
ADD	<input type="radio"/>	55
ADD	<input type="radio"/>	55
PRINT	<input type="radio"/>	59
SLIDE SHOW	-	43
VOLUME	<input type="radio"/>	72
DATA CODE	<input type="radio"/>	72
SLIDE SHOW SET	-	43
ADD	<input type="radio"/>	54
ADD	<input type="radio"/>	54
-- (No tab)		
COPIES	-	60
DATE/TIME	-	60
SIZE	-	60

\* Items that are included in the HOME MENU also.

# What you can do with Windows computer

When you install the “Picture Motion Browser” on a Windows computer from the supplied CD-ROM, you can enjoy the following operations.

## 🔧 Tips

- The supplied software “Picture Motion Browser” does not support a Macintosh computer.

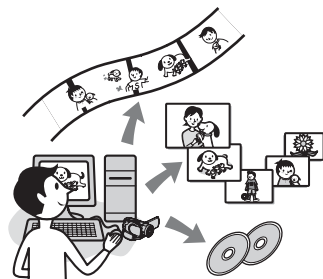

## Main functions

### ■ One Touch Disc Burn

By pressing DISC BURN on your camcorder, you can save images recorded on your camcorder to a disc with the same image quality, automatically. You can create a disc easily. Movies recorded with HD (high definition) image quality are copied as they are.

### ■ Importing images taken with your camcorder to a computer

You can easily import the images recorded on your camcorder to a computer. Movies recorded with HD (high definition) image quality are imported from your camcorder as they are.

### ■ Viewing imported images on a computer

You can manage movies and still images by date and time of shooting, and select movies or still images you want to view as thumbnails. These thumbnails can be enlarged and played in a slide show.

### ■ Creating a Playlist disc

You can create a disc based on a Playlist created on your camcorder.

### ■ Creating a disc with edited images

You can edit images imported to your computer, and create a disc consisting of selected images.

### ■ Rewriting imported movies with HD (high definition) image quality from your computer back to your camcorder

You can rewrite movies that were imported from your camcorder to your computer, back to your camcorder.

### ■ Playing a disc consisting of images with HD (high definition) image quality

→ Player for AVCHD

You can view movies with HD (high definition) image quality recorded on a disc by inserting the disc into the DVD drive of a computer.

### ■ Copying a disc

→ Video Disc Copier

You can copy a disc you created as it is.

## 🔍 Notes

- This camcorder captures high definition footage in the AVCHD format. DVD media containing AVCHD footage should not be used with DVD based players or recorders, as the DVD player/recorder may fail to eject the media and may erase its contents without warning. DVD media containing AVCHD footage may be played on a compatible Blu-ray Disc™ player/recorder or other compatible device.

## About “First Step Guide”

The “First Step Guide” is an instruction manual you can refer to on your computer. This describes basic operations, from initial hookup of your camcorder and computer and making settings, to general operation the first time you use the software “Picture



Motion Browser” stored on the CD-ROM (supplied).

Referring to “Installing the “First Step Guide”” (p. 86), start the “First Step Guide”, then follow the instructions.

## About the help function of the software

The Help guide explains all the functions of all the software applications. Refer to the Help guide for further detailed operations after reading the “First Step Guide” thoroughly.

To display the Help guide, click the [?] mark on the screen.

## System requirements

### When using Picture Motion Browser

**OS:** Microsoft Windows 2000 Professional, Windows XP Home Edition, Windows XP Professional, or Windows XP Media Center Edition  
Standard installation is required.  
Operation is not assured if the above OS has been upgraded or in a multi-boot environment.

**CPU:** Intel Pentium 4 2.8 GHz or faster (Intel Pentium 4 3.6 GHz or faster, Intel Pentium D 2.8 GHz or faster, Intel Core Duo 1.66 GHz or faster is recommended.)  
For processing SD (standard definition) image quality content only, an Intel Pentium III 1 GHz or faster is necessary.

**Application:** DirectX 9.0c or later (This product is based on DirectX technology. It is necessary to have DirectX installed.)  
.Net Framework 1.1 (installed with Picture Motion Browser, depending on your computer environment)

**Sound system:** Direct Sound compatible sound card

**Memory:** 512 MB or more (1 GB or more is recommended.)  
For processing SD (standard definition) image quality content only, 256 MB of memory or more is necessary.

### Hard disk:

Disc volume required for installation:  
Approximately 800 MB (10 GB or more may be necessary when creating AVCHD format discs.)

**Display:** DirectX 7 or later-compatible video card, Minimum 1024 × 768 dots, High Color (16 bit color)

**Others:**  USB port (this must be provided as standard, Hi-Speed USB (USB 2.0 compatible) is recommended), DVD burner (CD-ROM drive is necessary for installation)

### Notes

- Even in a computer environment where the operations are guaranteed, frames may be dropped from movies with HD (high definition) image quality, resulting in uneven playback. However, imported images and images on discs created subsequently will not be affected.
- Operations are not guaranteed, even on computers fulfilling the above system requirements.  
For example, other open or background applications running on currently may limit product performance.
- Picture Motion Browser does not support 5.1ch surround sound reproduction. The sound is reproduced in 2ch sound.
- Some computers do not support 8 cm discs (such as DVD+R DL (double-layered)).
- If you use a Notebook PC, connect it to the AC Adaptor as the power source when you view or edit movies recorded in HD (high definition) format. Otherwise, the software will not work properly due to the power saving function of the PC.
- When you perform the One Touch Disc Burn operation, a long scene may be separated into plural discs or scenes, depending on the scene length. In this case, sound may be lost between the separated scenes.

### When playing still images recorded on a “Memory Stick Duo” on a computer

**OS:** Microsoft Windows 2000 Professional, Windows XP Home Edition, Windows XP Professional or Windows XP Media Center Edition

## What you can do with Windows computer (Continued)

Standard installation is required.

Operation is not assured if the above OS has been upgraded.

**CPU:** MMX Pentium 200 MHz or faster

**Others:** USB port (this must be provided as standard)

### 💡 Tips

- If your computer has a Memory Stick slot, insert the “Memory Stick Duo” on which still images are recorded into the Memory Stick Duo Adaptor (optional), then insert it into the Memory Stick slot on your computer to copy still images to the computer.
- When using a “Memory Stick PRO Duo” and your computer is not compatible with it, connect your camcorder with the USB cable instead of using the Memory Stick slot on the computer.

## Installing the “First Step Guide” and software

You need to install the “First Step Guide” and software to your Windows computer **before connecting your camcorder to the computer**. The installation is required only for the first time. Contents to be installed and procedures may differ depending on your OS.

### Installing the “First Step Guide”

#### 1 Confirm that your camcorder is not connected to the computer.

#### 2 Turn on the computer.

- Log on as Administrators for installation.
- Close all applications running on the computer before installing the software.

#### 3 Place the supplied CD-ROM in the disc drive of your computer.

The installation screen appears.



#### If the screen does not appear

- ① Click [Start], then click [My Computer]. (For Windows 2000, double-click [My Computer].)
- ② Double-click [SONYPICTUTIL (E:)] (CD-ROM) (disc drive).\*

\* Drive names (such as (E:)) may vary depending on the computer.

---

## 4 Click [FirstStepGuide].



---

## 5 Select your language from the pull-down menu.

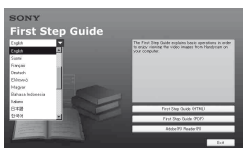

---

## 6 Click [First Step Guide (HTML)].

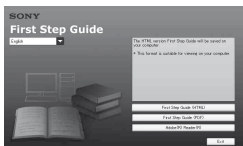

Installation starts.

When [Save is complete] appears, click [OK] to finish the installation.

---

## To install the First Step Guide in PDF

In step 4, click [First Step Guide (PDF)].

## To install the software “Adobe Reader” to display the PDF file

In step 4, click [Adobe(R) Reader(R)].

---

## Installing the software

---

## 1 Perform steps 1 to 3 in “Installing the “First Step Guide”” (p. 86).



---

## 2 Click [Install].



---

## 3 Select the language for the application to be installed, then click [Next].

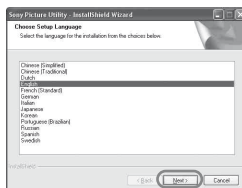

---

## 4 Click [Next].

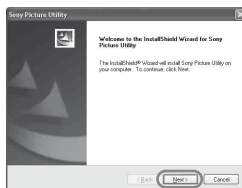

- 5** Read [License Agreement], select [I accept the terms of the license agreement] when you agree, then click [Next].

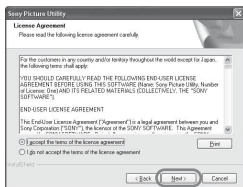

- 6** Select your camcorder video system, then click [Next].

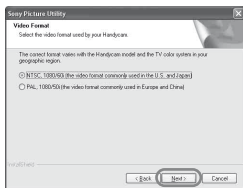

- 7** Select where to save the software, then click [Next].

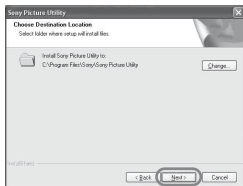

- 8** Click [Install] on the [Ready to Install the Program].

The installation of Picture Motion Browser starts.

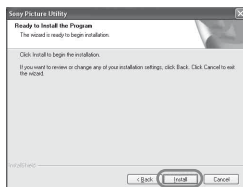

- 9** One of the following installation screens appears, depending on the computer environment. Check the screen and follow the instructions displayed to install the required software.

### ■ Sonic UDF Reader

Software required to recognize an AVCHD format disc

### ■ Windows Media Format 9 Series Runtime (Windows 2000 only)

Software required to create a DVD

### ■ Microsoft .NET Framework 1.1

Software required to create AVCHD

### ■ Microsoft DirectX 9.0c

Software required to handle movies

- 10** Make sure [Yes, I want to restart my computer now.] is selected, then click [Finish].

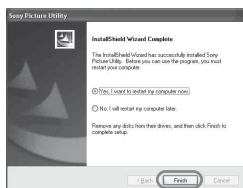

The computer restarts automatically (Restart).

# Viewing “First Step Guide”

The short-cut icons, such as [  ] (Picture Motion Browser), appear on the desktop.



To view “First Step Guide” on your computer, Microsoft Internet Explorer Ver.6.0 or later is recommended. Double-click the [HDR-SR1E First Step Guide (HTML)] icon on the desktop.



---

## 11 Remove the CD-ROM from the disc drive of your computer.

---

After you install the software, a shortcut icon for the customers registration website is created on the desktop.

Once you register on the website, you can get secure and useful customer support.  
<http://www.sony.net/registration/di/>

- You can also start by selecting [Start], [Programs] ([All Programs] for Windows XP), [Sony Picture Utility], [First Step Guide], [HDR-SR1E], then [HDR-SR1E First Step Guide.html].
- To view “First Step Guide” in HTML without installing, copy the desired language folder from the [FirstStepGuide] folder on the CD-ROM, and then double-click [index.html].
- Refer to “FirstStepGuide(pdf)” in the following cases:
  - When printing the desired topics of “First Step Guide”
  - When “First Step Guide” is not displayed correctly due to the browser setting even in recommended environment.
  - When the HTML version of “First Step Guide” cannot be installed.

# Troubleshooting

If you run into any problems using your camcorder, use the following table to troubleshoot the problem. If the problem persists, disconnect the power source and contact your Sony dealer.

## Notes before sending your camcorder for repair

- Your camcorder may be required to initialize or change the current hard disk of the camcorder, depending on the problem. In the event of this, the data stored on the hard disk will be deleted. Be sure to save the data on the internal hard disk (p. 50) on other media (backup) before sending your camcorder for repair. We will not compensate you for any loss of hard disk data.
- During repair, we may check a minimum amount of data stored on the hard disk in order to investigate the problem. However, your Sony dealer will neither copy nor retain your data.

## Overall operations

### The camcorder does not operate even when the power is set to on.

- It takes a few seconds for your camcorder to be ready to shoot after the power is turned on. This is not a malfunction.
- Disconnect the AC Adaptor from the wall socket or remove the battery pack, then reconnect it after about 1 minute. If the functions still do not work, press the RESET button (p. 124) using a sharp-pointed object. (If you press the RESET button, all settings, including the clock setting, are reset.)
- The temperature of your camcorder is extremely high. Turn off your camcorder and leave it for a while in a cool place.
- The temperature of your camcorder is extremely low. With POWER switch turned on, leave the camcorder for a while. If you still cannot operate the camcorder, turn it off, taking it to a warm place. Leave the camcorder there for a while, then turn on the camcorder.

### [DEMO MODE] does not start.

- Set the POWER switch to  (Movie).

### A vibration is felt in your hand or a faint sound is heard during operation.

- This is not a malfunction.

### Your camcorder gets warm.

- This is because the power has been turned on for a long time. This is not a malfunction. Turn off your camcorder and leave it for a while in a cool place.

## Batteries/Power sources

### The power does not turn on.

- The battery pack is not attached to the camcorder. Attach a charged battery pack to the camcorder (p. 24).
- The battery pack is discharged or running low. Charge the battery pack (p. 24).
- The plug of the AC Adaptor has been disconnected from the wall socket. Connect it to the wall socket (p. 24).

---

**The power abruptly turns off.**

- When approximately 5 minutes have elapsed while you do not operate your camcorder, the camcorder is automatically turned off (A.SHUT OFF). Change the setting of [A.SHUT OFF] (p. 76), or turn on the power again, or use the AC Adaptor.
- The battery pack is discharged or running low. Charge the battery pack (p. 24).

---

**The power turns off soon.**

- If you attach the battery or AC Adaptor to the camcorder with the POWER switch set to OFF (CHG), the camcorder turns on once, then off again, after a few seconds. This is not a malfunction.

---

**The CHG (charge) lamp does not light while the battery pack is being charged.**

- Slide the POWER switch to OFF (CHG) (p. 24).
- Attach the battery pack to the camcorder correctly (p. 24).
- Connect the mains lead to the wall socket properly.
- The battery charge is completed (p. 24).

---

**The CHG (charge) lamp flashes while the battery pack is being charged.**

- Attach the battery pack to the camcorder correctly (p. 24). If the problem persists, disconnect the AC Adaptor from the wall socket and contact your Sony dealer. The battery pack may be damaged.

---

**The power turns off frequently although the remaining battery indicator indicates that the battery pack has enough power to operate.**

- A problem has occurred in the remaining battery time indicator, or the battery pack has not been charged enough. Fully charge the battery again to correct the indication (p. 24).

---

**The remaining battery time indicator does not indicate the correct time.**

- The temperature of the environment is too high or too low. This is not a malfunction.
- The battery pack has not been charged enough. Fully charge the battery again. If the problem persists, replace the battery pack with a new one (p. 24).
- The indicated time may not be correct depending on the environment of use. When you open or close the LCD screen, it takes about 1 minute to display the correct remaining battery time.

---

**The battery pack is quickly discharged.**

- The temperature of the environment is too high or low. This is not a malfunction.
- The battery pack has not been charged enough. Fully charge the battery again. If the problem persists, replace the battery pack with a new one (p. 24).

---

**A problem occurs when the camcorder is connected to the AC Adaptor.**

- Turn off the power, and disconnect the AC Adaptor from the wall socket. Then, connect it again.

### LCD screen/viewfinder

#### An unknown image appears on the LCD screen or viewfinder.

- The camcorder is in [DEMO MODE] (p. 75). Touch the LCD screen to cancel [DEMO MODE].

---

#### An unknown indicator appears on the screen.

- A warning indicator or message appears on the screen (p. 103).

---

#### The image remains on the LCD screen.

- This occurs if you disconnect the DC plug or remove the battery pack without turning off the power first. This is not a malfunction.

---

#### The buttons do not appear on the touch panel.

- Touch the LCD screen lightly.
- Press DISP/BATT INFO on your camcorder (or DISPLAY on the Remote Commander) (p. 29).

---

#### The buttons on the touch panel do not work correctly or do not work at all.

- Adjust the touch panel ([CALIBRATION]) (p. 116).

---

#### The image in the viewfinder is not clear.

- Move the viewfinder lens adjustment lever until the image appears clearly (p. 29).

---

#### The image in the viewfinder has disappeared.

- Close the LCD panel. No image is displayed in the viewfinder when the LCD panel is open (p. 29).

### “Memory Stick Duo”

#### You cannot operate functions using the “Memory Stick Duo.”

- Insert a “Memory Stick Duo” into your camcorder (p. 32).
- If you use a “Memory Stick Duo” formatted on a computer, format it again on your camcorder (p. 62).

---

#### Images cannot be deleted.

- Release the lock on the write-protect tab of the “Memory Stick Duo” if there is one (p. 112).
- The maximum number of images that you can delete on the index screen at one time is 100.
- You cannot delete the images protected on another device. Release the protection of the images on the device which you protected the images.



---

**You cannot delete all images at one time.**

- Release the lock on the write-protect tab of the “Memory Stick Duo” if there is one (p. 112).

---

**You cannot format the “Memory Stick Duo.”**

- Release the lock on the write-protect tab of the “Memory Stick Duo” if there is one (p. 112).

---

**The data file name is not indicated correctly.**

- Only the file name is displayed, unless the directory structure conforms to the universal standard.
- The file is damaged.
- The file format is not supported by your camcorder (p. 112).

---

**The data file name flashes.**



- The file is damaged.
- The file format is not supported by your camcorder (p. 112).

## Recording

Refer also to “Adjusting the image during recording” (p. 95).

---

**Pressing START/STOP or PHOTO does not record images.**

- The playback screen is displayed. Set the POWER switch to  (Movie) or  (Still) (p. 33, 34).
- Your camcorder is recording the scene you have just shot on the hard disk. You cannot make new recording during this period (p. 34).
- The hard disk of the camcorder is full. Delete unnecessary images (p. 51). Or perform [⊖FORMAT] (p. 62).
- Total number of movie scenes or still images exceeds the recordable capacity of your camcorder (p. 15). Delete unnecessary images (p. 51).
- While activating [DROP SENSOR] (p. 76), you may not record movies/still images.

---

**You cannot record a still image.**

- The playback screen is displayed. Set your camcorder to recording standby (p. 34).
- You can capture up to 3 still images only during movie recording.
- Release the lock on the write-protect tab of the “Memory Stick Duo” if there is one (p. 112).
- The “Memory Stick Duo” has run out of space. Use a new “Memory Stick Duo” or format the “Memory Stick Duo” (p. 62). Or delete the unnecessary images (p. 52).
- You cannot record a still image together with:
  - [SMTH SLW REC]
  - [FADER]
  - [D.EFFECT]
  - [PICT.EFFECT]

### The ACCESS lamp remains lit or flashing even when you stop recording.

- Your camcorder is recording the scene you have just shot on the hard disk.
- 

### The recording angle differs depending on the POWER switch setting position.

- The recording angle for the still image is wider than the one for the movie.
- 

### The shutter sound is not heard when you record a still image.

- Set [BEEP] to [ON] (p. 73).
  - The shutter does not sound when using the Dual Rec function.
- 

### The flash does not work.

- You cannot record with the flash with:
    - Capturing still images while shooting a movie
    - [SMTH SLW REC]
    - [FADER]
    - [D.EFFECT]
    - [PICT.EFFECT]
    - The conversion lens (optional) attached
  - Even if auto flash or  (Auto redeye reduction) is selected, you cannot use the internal flash with:
    - NightShot
    - [SUPER NS]
    - [SPOTLIGHT], [SUNSET&MOON] or [LANDSCAPE] in [PROGRAM AE]
    - [MANUAL] in [EXPOSURE]
    - [SPOT METER]
- 

### The external flash (optional) does not work.

- The power of the flash is not turned on, or the flash is not attached correctly.
- 

### You cannot record still images continuously.

- You cannot record still images continuously with your camcorder.
- 

### The actual recording time for movie is less than the expected approximate recording time of the hard disk.

- Depending on an object, such as a fast moving object, the time available for recording may shorten (p. 15, 66).
- 

### The recording stops.

- The temperature of your camcorder is extremely high. Turn off your camcorder and leave it for a while in a cool place.
- The temperature of your camcorder is extremely low. Turn off your camcorder and take it to a warm place. Leave the camcorder there for a while, then turn on the camcorder.

- Moisture condensation has occurred. Turn off your camcorder and leave it about 1 hour in a cool place (p. 116).

---

**There is a time difference between the point where you press START/STOP and the point that the recorded movie starts/stops.**

- On your camcorder, there may be a slight time difference between the point where you press START/STOP and the actual point that recording movie starts/stops. This is not a malfunction.

---

**The movie aspect ratio (16:9/4:3) cannot be changed.**

- The aspect ratio of the movie recorded with HD (high definition) image quality is 16:9.

## Adjusting the image during recording

Refer also to “Menu” (p. 98).

---

**The auto focus does not function.**

- Set [FOCUS] to [AUTO] (p. 78).
- The recording conditions are not suitable for auto focus. Adjust the focus manually (p. 78).

---

**[STEADYSHOT] does not function.**

- Set [STEADYSHOT] to [ON] (p. 67).
- [STEADYSHOT] may not be able to compensate for excessive vibrations.

---

**The BACK LIGHT function does not function.**

- In the following settings, the BACK LIGHT function is canceled:
  - [MANUAL] in [EXPOSURE] (p. 79)
  - [SPOT METER] (p. 79)

---

**The subjects passing by the frame very fast appear crooked.**

- This is called the focal plane phenomenon. This is not a malfunction. Because of the way the image device (CMOS sensor) reads out image signals, the subjects passing by the frame rapidly might appear crooked depending on the recording conditions.

---

**Tiny spots in white, red, blue, or green appear on the screen.**

- The spots appear when you are recording with [SUPER NS] or [COLOR SLOW S]. This is not a malfunction.

---

**The color of the image is not correctly displayed.**

- Set the NIGHTSHOT switch to OFF (p. 37).

### **The screen image is bright, and the subject does not appear on the screen.**

- Set the NIGHTSHOT switch to OFF (p. 37).
- 

### **The screen image is dark, and the subject does not appear on the screen.**

- Press and hold DISP/BATT INFO for a few seconds to turn on the backlight (p. 29).
- 

### **The image appears too bright or flickering, or changes in color.**

- This occurs when recording images under a fluorescent lamp, sodium lamp, or mercury lamp. Cancel [PROGRAM AE] to minimize this phenomena (p. 80).
- 

### **Black bands appear when you record a TV screen or computer screen.**

- Set [STEADYSHOT] to [OFF] (p. 67).
- 

## Remote Commander

### **The supplied Remote Commander does not function.**

- Set [REMOTE CTRL] to [ON] (p. 76).
  - Insert a battery into the battery holder with the +/- polarities correctly matching the +/- marks (p. 117).
  - Remove any obstructions between the Remote Commander and the remote sensor.
  - Point the remote sensor away from strong light sources such as direct sunlight or overhead lighting. Otherwise, the Remote Commander may not function properly.
  - Remove the conversion lens (optional) as the remote sensor may be obstructed by it.
- 

### **Another DVD device malfunctions when you use the supplied Remote Commander.**

- Select a commander mode other than DVD 2 for your DVD device, or cover the sensor of your DVD device with black paper.
- 

## Playing back images on your camcorder

### **Still images stored on a “Memory Stick Duo” are not played back in the actual size.**

- Still images recorded on other devices may not appear in the actual size. This is not a malfunction.
- 

### **Still images stored on a “Memory Stick Duo” cannot be played back.**

- Still images cannot be played back if you have modified files or folders, or have edited the data on a computer. (The file name flashes in that case.) This is not a malfunction (p. 113).
- Still images recorded on other devices may not be played back. This is not a malfunction (p. 113).

---

**“?” is indicated on an image in the VISUAL INDEX screen.**

- Loading of the data may have failed. It may be indicated correctly when you turn off the power and then turn it on again, or repeat removing and inserting the “Memory Stick Duo” a couple of times.
- This may appear on still images recorded on other devices, edited on a computer, etc.
- You removed the AC Adaptor or the battery pack before the ACCESS lamp is turned off after recording. This may damage your image data and “?” is displayed.

---

**“” is indicated on an image in the VISUAL INDEX screen.**

- The image data is damaged. Delete the image marked with “” (p. 51).

---

**No sound or only a quiet sound is heard during playback.**

- Turn up the volume (p. 41).
- Sound is not output when the LCD screen is closed. Open the LCD screen.
- When you record sound with [MICREF LEVEL] (p. 82) set to [LOW], the recorded sound may be difficult to hear.
- You cannot record sounds during [SMTH SLW REC].

## Image data

**The data file name flashes.**

- The file is damaged.
- The file format is not supported on your camcorder (p. 110).

## Viewing on the TV

**You cannot view the image or hear the sound on the TV connected with the component video cable.**

- Set [COMPONENT] according to the requirements of the connected device (p. 74).
- When you are using the component video cable, make sure the red and white plugs of the A/V connecting cable are connected (p. 45, 47).

---

**You cannot view the image or hear the sound on the TV connected with the HDMI cable.**

- Images are not output from the HDMI OUT jack, if copyright protection signals are recorded in the images.

---

**You cannot hear the sound.**

- When you are using the component video cable, make sure the red and white plugs of the A/V connecting cable are connected (p. 45, 47).
- When you are using the S VIDEO plug, make sure the red and white plugs of the A/V connecting cable are connected (p. 48).

---

### The aspect ratio of the playback is not correct when connecting your camcorder to the TV.

- Set [TV TYPE] depending on your TV (p. 74).

---

### The image appears distorted on the 4:3 TV.

- This happens when viewing an image recorded in the 16:9 (wide) mode on a 4:3 TV. Set [TV TYPE] correctly (p. 74) and play back the image. If you view the image on a 4:3 TV, black bands may appear at the top and bottom of the screen. This is not a malfunction.

## Menu

### Menu items are grayed out.

- You cannot select grayed items in the current recording/playback situation.
- There are some functions you cannot activate simultaneously. The following list shows examples of unworkable combinations of functions and menu items.

Cannot use	Because of following settings
[PROGRAM AE]	NightShot, [SUPER NS], [COLOR SLOW S], [OLD MOVIE]
[SPOT METER]	NightShot, [SUPER NS]
[EXPOSURE]	NightShot, [SUPER NS]
[WHITE BAL.]	NightShot, [SUPER NS]
[ONE PUSH] in [WHITE BAL.]	[SMTH SLW REC]
[SPOT FOCUS]	[PROGRAM AE]
[SUPER NS]	[FADER], [D.EFFECT]
[COLOR SLOW S]	[FADER], [D.EFFECT], [PROGRAM AE]
[FADER]	[SUPER NS], [COLOR SLOW S], [D.EFFECT]
[D.EFFECT]	[SUPER NS], [COLOR SLOW S], [FADER]
[OLD MOVIE]	[PROGRAM AE], [PICT.EFFECT]
[PICT.EFFECT]	[OLD MOVIE]
[STEADYSHOT]	[SMTH SLW REC]
[EXP.FOCUS]	[SMTH SLW REC], [DIGITAL ZOOM]
[TELE MACRO]	[PROGRAM AE]

---

### [SUPER NS] cannot be operated.

- Set the NIGHTSHOT switch to ON.

---

**[COLOR SLOW S] does not operate correctly.**

- [COLOR SLOW S] may not operate correctly in total darkness. Use NightShot or [SUPER NS].

---

**You cannot adjust [LCD BL LEVEL].**

- You cannot adjust [LCD BL LEVEL] when:
  - The LCD panel is closed on your camcorder with the LCD screen facing out.
  - The power is supplied from the AC Adaptor.

---

**You cannot use [WIDE SELECT].**

- You cannot use [WIDE SELECT] together with HD (high definition) image quality.

## Editing images on your camcorder

**Unable to edit.**

- There are no images recorded.
- Unable to edit because of the condition of the image.

---

**Unable to copy still images.**

- There is not enough space available to copy the images on the “Memory Stick Duo.” Delete unnecessary images (p. 52).
- Release the lock on the write-protect tab of the “Memory Stick Duo” if there is one (p. 112).

---

**Images cannot be added in the Playlist.**

- You can add no more than 999 images with HD (high definition) image quality, or 99 images with SD (standard definition) image quality, to a Playlist. Erase unnecessary images from the Playlist (p. 55).
- You cannot add still images in the Playlist.

---

**Images cannot be deleted.**

- You cannot delete images protected on other devices. Release the protection on the device you used for protecting the image.

## Dubbing/Editing/Connecting to other devices

Refer also to “Viewing on the TV” (p. 97).

---

**No sound is heard during playback.**

- The audio will not be output when you connect a device via the S VIDEO plug only. Connect the white and red plugs of the A/V connecting cable, too (p. 48).

### **You cannot dub correctly using the HDMI cable.**

- You cannot dub images using the HDMI cable.
- 

### **You cannot dub correctly using the A/V connecting cable.**

- The A/V connecting cable is not connected properly. Make sure that the A/V connecting cable is connected to the proper jack, i.e. to the input jack of another device for dubbing a image from your camcorder (p. 58).
- 

### **Prints cannot be made using a PictBridge printer.**

- Your printer may not print images edited on a computer or recorded using other devices. This is not a malfunction.
- 

## Others

### **Unable to clip a still image from a movie on the hard disk of your camcorder.**

- You cannot clip a still image from a movie stored on your camcorder.
- 

### **The beep sounds for 5 seconds.**

- The temperature of your camcorder is extremely high. Turn off your camcorder and leave it for a while in a cool place.
  - Some problems have occurred in your camcorder. Turn off, and on, then operate your camcorder again.
  - The temperature of your camcorder is extremely low. With POWER switch turned on, leave the camcorder for a while. If you still cannot operate the camcorder, turn it off, taking it to a warm place. Leave the camcorder there for a while, then turn on the camcorder.
- 

## Connecting to a computer

### **A computer does not recognize your camcorder.**

- Install Picture Motion Browser (p. 87).
  - When you connect your camcorder to a computer for the first time, it may take some time for the computer to recognize the camcorder. Wait for a while.
  - Disconnect the USB device other than the keyboard, the mouse, and the camcorder from the computer.
  - Disconnect the cable from the computer and camcorder, restart the computer, then connect them again correctly.
- 



### **Cannot use the supplied software, Picture Motion Browser, on the Macintosh computer.**

- You cannot use Picture Motion Browser on a Macintosh.
-





---

**Cannot view the movies on the hard disk played on your camcorder on a computer monitor.**

- Install Picture Motion Browser (p. 87).
- Make sure you insert the connector in the correct direction, then connect the USB cable to the USB jack on your camcorder firmly.
- Select  (SELECT DEVICES) → [COMPUTER] → [ ↔ COMPUTER] on the HOME MENU (p. 57).
- Disconnect the USB device other than the keyboard, the mouse, and the camcorder from the computer.



---

**You cannot view the still images recorded on a “Memory Stick Duo” on the computer.**

- Insert the “Memory Stick Duo” firmly.
- Select  (SELECT DEVICES) → [COMPUTER] → [ ↔ COMPUTER] on the HOME MENU (p. 57).
- The computer does not recognize the “Memory Stick Duo” during camcorder operation such as playback or editing of images on the hard disk. Finish camcorder operation before connecting the camcorder to the computer.

---

**The “Memory Stick” icon ([Removable Disk]) does not appear on the computer screen.**

- Insert a “Memory Stick Duo” into your camcorder.
- Disconnect the USB device other than the keyboard, the mouse, and the camcorder from the computer.
- Select  (SELECT DEVICES) → [COMPUTER] → [ ↔ COMPUTER] on the HOME MENU (p. 57).
- The computer does not recognize the “Memory Stick Duo” during camcorder operation such as playback or editing. Finish camcorder operation before connecting the camcorder to the computer.

---

**Picture Motion Browser does not function correctly.**

- Close Picture Motion Browser, then restart the Windows computer.

---

**An error message appears while operating Picture Motion Browser.**

- Close Picture Motion Browser on your Windows computer first, then set the POWER switch on your camcorder to another mode.

---

**The movie, still image or sound of your camcorder is not played on your computer correctly.**

- If your camcorder is connected to a computer that does not support Hi-speed USB (USB2.0), the movie, still image or sound may not be played back correctly. The movie, still image or sound copied to your computer is not affected.
- Movie playback or sound may stop temporarily depending on your computer. The movie or sound copied to your computer is not affected.

### **The extension of a file is not displayed on your computer.**

- To display the extension, follow the steps below:
    - ① Click [Tool] in the window folder → [Folder option...] → [View] tab.
    - ② Remove the check mark from the [Hide file extensions for known file types] under Advanced Settings.
    - ③ Click [OK].
- 

### **If you press the DISC BURN button on your camcorder, the software on the computer does not run.**

- Install Picture Motion Browser (p. 87).
  - Start [Media Check Tool] up on the computer. (See “First Step Guide” on the supplied CD-ROM for details.)
- 

### **While performing Easy PC Back-up, [Not enough space on destination hard disk.] is displayed on the computer screen.**

- Delete unnecessary files from your computer to free hard disk space.
- 

### **Cannot write from your computer to the hard disk of your camcorder.**

- You cannot write to the hard disk of your camcorder from software other than Picture Motion Browser.
  - You cannot write movies with SD (standard definition) image quality and still images to the hard disk of your camcorder.
- 

### **The file transferred from the computer is not written to the “Memory Stick Duo” in your camcorder.**

- The USB cable (supplied) was not removed with the right procedure. Connect your camcorder to the computer again and transfer the data.
- 

### **The playback screen is paused or distorted on a computer.**

- Check the computer environment required to play movies (p. 85).
  - Close all application except “Player for AVCHD” on a computer.
- 

### **The disc you created cannot be played back.**

- Use the supplied “Player for AVCHD” software to play a disc you created on a computer, by recording images with HD (high definition) image quality transferred from your camcorder to the computer. A standard disc player cannot be used. If other disc player software starts up when a disc recorded with HD (high definition) image quality is inserted in the computer, close that software.
- 

### **The actually displayed screen or message is different from that shown in the “First Step Guide.”**

- The screen or message may be different.

# Warning indicators and messages

## Self-diagnosis display/Warning indicators

If indicators appear on the LCD screen or in the viewfinder, check the following.

Some symptoms you can fix by yourself. If the problem persists even after you have tried a couple of times, contact your Sony dealer or local authorized Sony service facility.

### C:(or E:) □□:□□ (Self-diagnosis display)

#### C:04:□□

- The battery pack is not an “InfoLITHIUM” battery pack. Use an “InfoLITHIUM” battery pack (p.114).
- Connect the DC plug of the AC Adaptor to the DC IN jack securely (p.24).

#### C:13:□□ / C:32:□□

- Remove the power source. Reconnect it and operate your camcorder again.

#### E:20:□□ / E:31:□□ / E:61:□□ / E:62:□□ / E:91:□□ / E:94:□□

- A malfunction that you cannot service has occurred. Contact your Sony dealer or local authorized Sony service facility. Inform them of the 5-digit code, which starts from “E”.

### 101-0001 (Warning indicator pertaining to files)

#### Slow flashing

- The file is damaged.
- The file is unreadable.

### (Warning on the hard disk of the camcorder)\*

#### Fast flashing

- An error may have occurred with the hard disk drive in your camcorder.

### (Warning on the hard disk of the camcorder)\*

#### Fast flashing

- The hard disk of the camcorder is fully recorded.
- An error may have occurred with the hard disk drive in your camcorder.

### (Battery level warning)

#### Slow flashing

- The battery pack is nearly used up.
- Depending on the operating environment or battery conditions,  may flash, even if there are approximately 20 minutes remaining.

### (High temperature warning)

#### Slow flashing

- The temperature of your camcorder is getting higher. Turn off your camcorder and leave it for a while in a cool place.

#### Fast flashing\*

- The temperature of your camcorder is extremely high. Turn off your camcorder and leave it for a while in a cool place.

### (Low temperature warning)\*

#### Fast flashing

- The temperature of your camcorder is extremely low. Make the camcorder warm.

### (Warning indicator pertaining to “Memory Stick Duo”)

- No “Memory Stick Duo” is inserted (p. 32).

### (Warning indicators pertaining to “Memory Stick Duo” formatting)\*

- The “Memory Stick Duo” is damaged.
- The “Memory Stick Duo” is not formatted correctly (p. 62, 112).

## Warning indicators and messages (Continued)

---

### (Warning indicator pertaining to incompatible “Memory Stick Duo”)\*

- An incompatible “Memory Stick Duo” is inserted (p. 112).

---

### (Warning indicator pertaining to the write-protect of the “Memory Stick Duo”)\*

- The write-protect tab on the “Memory Stick Duo” is set to lock (p. 112).
- Access to the “Memory Stick Duo” was restricted on another device.

---

### (Warning indicator pertaining to the flash)

#### Slow flashing:

- Still charging

#### Fast flashing\*:

- There is something wrong with the flash.

---

### (Warning indicator pertaining to camera-shake warning)\*

- The amount of lights is not sufficient, so camera-shake easily occurs. Use the flash.
- The camcorder is unsteady, so camera-shake easily occurs. Hold the camcorder steady with both hands and shoot the image. However, note that the camera-shake warning indicator does not disappear.

---

### (Warning indicator pertaining to drop sensor)

- The drop sensor function (p. 76) is activated, and has detected that the camcorder has been dropped. Therefore, the camcorder is taking steps to protect the hard disk. Recording/playback may be disabled as a result.

- The drop sensor function does not guarantee the protection of the hard disk under all possible situations. Use the camcorder under stable conditions.

\* You hear a melody when the warning indicators appear on the screen (p. 73).

## Description of warning messages

If messages appear on the screen, follow the instructions.

### ■ Hard disk

---

#### Drive error. Turn on power again.

- A problem occurred with the hard disk drive. Turn off and then on again.

---

#### Overheated. Cannot access HDD.

---

#### Low temperature. Cannot access HDD.

---

#### HDD full. Cannot record.

- Delete unnecessary images (p. 51).

---

#### Number of HD movie scenes is full. Cannot record HD movies.

---

#### Number of SD movie scenes is full. Cannot record SD movies.

- Delete unnecessary images (p. 51).

---

#### SD movie folder is full. Cannot record SD movies.

- Delete unnecessary images (p. 51) or perform [  FORMAT ] (p. 62).

---

#### Number of still picture scenes is full. Cannot record still pictures.

- Delete unnecessary images (p. 51).

---

 **Still picture folder is full. Cannot record still pictures.**

- Delete unnecessary images (p. 51) or perform [FORMAT] (p. 62).

---

 **HD movie recording disabled.**

 **SD movie recording disabled.**

- Movies cannot be recorded due to some limitations of the hard disk of the camcorder. However, you may be able to record still images.

---

 **Still recording disabled.**

- Still images cannot be recorded due to some limitations of the hard disk of the camcorder. However, you may be able to record movies.

---

**No more still pictures during movie recording.**

- You are trying to record more than 3 still images, the maximum number that can be recorded at one time of recording with the Dual Rec function(p. 37).

---

**No applicable files available.**

- Image files have been deleted.

---

 **HDD format error.**

- The hard disk of the camcorder is set differently from the default format. Performing [FORMAT] (p. 62) may enable you to use your camcorder. This will delete all data in the hard disk.

---

**Data error.**

- An error occurred during reading or writing the hard disk of the camcorder. This may occur when you keep applying shock on the camcorder.

---

**Unable to access HDD.**

- An error occurred during reading or writing the hard disk of the camcorder. This may occur when you keep applying shock on the camcorder.

---

**Management file damaged. Create new file?**

- The image management file is damaged. When you touch [YES], a new image management file is created. The old recorded images on the hard disk of the camcorder cannot be played back. (Image files are not damaged.) In this case, copy the image files to computer using the supplied software. See “First Step Guide” on the supplied CD-ROM for details.

---

**HD movie management information is damaged. Create new information?**

- The HD movie management information is damaged. When you touch [YES], an HD movie management information is created. The old recorded images on the hard disk of the camcorder cannot be played back. (Image files are not damaged.) In this case, copy the image files to computer using the supplied software. See “First Step Guide” on the supplied CD-ROM for details.

---

**Buffer overflow**

- You cannot record because the drop sensor senses a drop of the camcorder repeatedly. If you may be at risk of dropping the camcorder constantly, set the drop sensor to [OFF], and you may be able to record the image again (p. 76).

---

### Recovering data

- Your camcorder tries to recover data automatically if the data writing was not performed properly.

---

### Cannot recover data.

- Writing data onto the hard disk of the camcorder has failed. Attempts were made to recover the data, but they were unsuccessful.

---

### ■ “Memory Stick Duo”

---

#### Reinsert the Memory Stick.

- Reinsert the “Memory Stick Duo” a few times. If even then the indicator flashes, the “Memory Stick Duo” could be damaged. Try with another “Memory Stick Duo.”

---

### This is a read-only Memory Stick.

- Insert a writable “Memory Stick Duo.”

---

#### Incompatible type of Memory Stick.

- A type of “Memory Stick Duo” incompatible with your camcorder is inserted (p. 112).

---

#### This Memory Stick is not formatted correctly.

- Check the format, then format the “Memory Stick Duo” with your camcorder if necessary (p. 62, 112).

---

### Cannot record. The Memory Stick is full.

- Delete unnecessary images (p. 52).

---

### Cannot record still pictures. (p. 93)

---

#### The Memory Stick is locked. Check the tab. (p. 112)

---

### Memory Stick has been removed. Process canceled.

---

### Memory Stick folders are full.

- You cannot create folders exceeding 999MSDCF. You cannot create or delete nested folders using your camcorder.
- Format the “Memory Stick Duo” (p. 62), or delete them using your computer.

---

### Do not eject the Memory Stick during writing.

---

### Cannot save still picture.

- When using the Dual Rec function, do not remove the still image recording media from the camcorder until recording is finished and still image recording is complete (p. 37).

---

### No more still pictures during movie recording.

- You are trying to record more than 3 still images, the maximum number that can be recorded at one time of recording, on a “Memory Stick Duo” with the Dual Rec function(p. 37).

---

### ■ PictBridge compliant printer

---

#### Check the connected device.

- Turn off the printer and on again, then remove the USB cable (supplied) and reconnect it.

---

#### Not connected to PictBridge compatible printer.

- Turn off the printer and on again, then remove the USB cable (supplied) and reconnect it.

---

**Error. Cancel the task.**

- Check the printer.

---

**Cannot print. Check the printer.**

- Turn off the printer and on again, then remove the USB cable (supplied) and reconnect it.

---

**■ Flash**

---

**Charging... Cannot record still images.**

- You are trying to record a still image while the external flash is charging.

---

**Flash cannot charge. Not available.**

- A malfunction has occurred with the external flash and disable charging.

---

**Lens accessory attached. Cannot use flash.**

---

**■ Other**

---

**Please connect AC adaptor.**

- You are trying to format the camcorder hard disk, while the battery capacity is low. Use the AC Adaptor as the power source to prevent the battery from wearing out in the middle of this operation.

---

**Playback prohibited.**

- You can only play back the images recorded by the camcorder.

---

**No further selection is possible.**

- You can select only 100 images at one time for:
  - deleting images
  - copying still images
  - editing the playlist of HD (high definition) movies

– printing still images

---

**Playlist full.**

- You can add no more than 999 images with HD (high definition) image quality, or 99 images with SD (standard definition) image quality to a Playlist.

---

**Data protected.**

- You tried to delete data protected on another device. Release the protection of the data on the device used to protect the data.

---

** Drop sensor activated. USB function ended.**

---

** Overheated. Ended USB function.**

---

** Low temperature. Ended USB function.**

---

**Exit USB function.**

- During USB connection, you cannot perform One Touch Disc Burn.

---

** Overheated. Cannot activate function. Wait a while and try again later.**

---

** Low temperature. Cannot activate function. Wait a while and try again later.**

## Using your camcorder abroad

### Power supply

You can use your camcorder in any countries/regions using the AC Adaptor supplied with your camcorder within the AC 100 V to 240 V, 50/60 Hz range.

### Viewing images recorded with HD (high definition) image quality

In countries/regions where 1080/50i is supported, you can view the images with the same HD (high definition) image quality as that of the recorded images. You need a PAL-system-based and 1080/50i compatible TV (or monitor) with component and AUDIO/VIDEO input jacks. Both a component video cable and an A/V connecting cable must be connected.

### Viewing images recorded with SD (standard definition) image quality

To view images recorded with SD (standard definition) image quality, you need a PAL-system-based TV with AUDIO/VIDEO input jacks. An A/V connecting cable must be connected.



### On TV color systems

Your camcorder is a PAL-system-based camcorder. If you want to view the playback image on a TV, it must be a PAL-system-based TV with an AUDIO/VIDEO input jack.

System	Used in
PAL	Australia, Austria, Belgium, China, Czech Republic, Denmark, Finland, Germany, Holland, Hong Kong, Hungary, Italy, Kuwait, Malaysia, New Zealand, Norway, Poland, Portugal, Singapore, Slovak Republic, Spain, Sweden, Switzerland, Thailand, United Kingdom, etc.
PAL - M	Brazil
PAL - N	Argentina, Paraguay, Uruguay.
NTSC	Bahama Islands, Bolivia, Canada, Central America, Chile, Colombia, Ecuador, Guyana, Jamaica, Japan, Korea, Mexico, Peru, Surinam, Taiwan, the Philippines, the U.S.A., Venezuela, etc.
SECAM	Bulgaria, France, Guiana, Iran, Iraq, Monaco, Russia, Ukraine, etc.



## Setting to the local time

You can easily set the clock to the local time by setting a time difference when using your camcorder abroad. Set  (SETTINGS) → [CLOCK/LANG] → [AREA SET] and [SUMMERTIME] on the HOME MENU (p. 30).

## World time difference

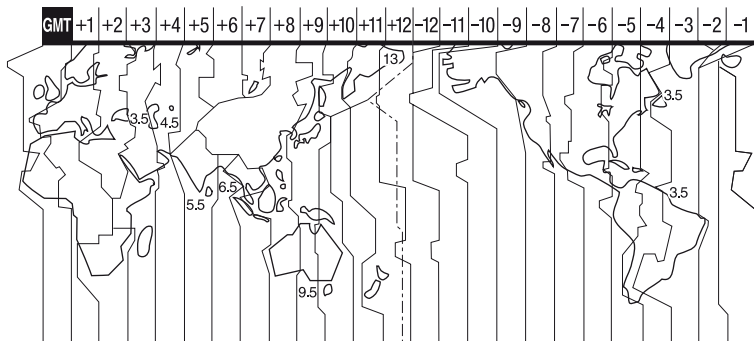

Time-zone differences	Area setting
GMT	Lisbon, London
+01:00	Berlin, Paris
+02:00	Helsinki, Cairo, Istanbul
+03:00	Moscow, Nairobi
+03:30	Tehran
+04:00	Abu Dhabi, Baku
+04:30	Kabul
+05:00	Karachi, Islamabad
+05:30	Calcutta, New Delhi
+06:00	Almaty, Dhaka
+06:30	Rangoon
+07:00	Bangkok, Jakarta
+08:00	HongKong, Singapore, Beijing
+09:00	Seoul, Tokyo
+09:30	Adelaide, Darwin
+10:00	Melbourne, Sydney

Time-zone differences	Area setting
+11:00	Solomon Is.
+12:00	Fiji, Wellington
-12:00	Eniwetok, Kwajalein
-11:00	Midway Is., Samoa
-10:00	Hawaii
-09:00	Alaska
-08:00	LosAngeles, Tijuana
-07:00	Denver, Arizona
-06:00	Chicago, Mexico City
-05:00	New York, Bogota
-04:00	Santiago
-03:30	St. John's
-03:00	Brasilia, Montevideo
-02:00	Fernando de Noronha
-01:00	Azores, Cape Verde Is.

# Files on the camcorder hard disk/folder structure

The file/folder structure is shown below. You do not usually need to acknowledge the file/folder structure, when recording/playing back images on the camcorder. To enjoy still images or movies by connecting to a computer, see page 84, then use the supplied application.

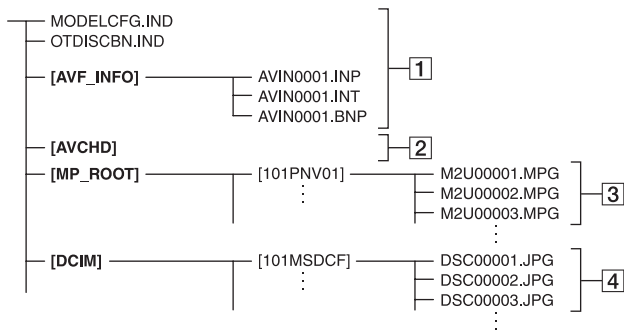

## 1 Image management files

When you delete the files, you cannot record/play back the images correctly. The files are defaulted as hidden files and not usually displayed.

## 2 HD movie management information folder

This folder contains recording data of movies with HD (high definition) image quality. Do not try to open this folder or access the contents of this folder from a computer. Doing so might damage image files, or prevent image files from being played back.

## 3 SD movie files (MPEG2 files)

The extension of the files is “.MPG”. The maximum size is 2 GB. When the capacity of a file exceeds 2 GB, the file becomes divided.

The file numbers go up automatically. When the file numbers exceeds 9 999, another folder is created to record new movie files.

The folder name goes up: [101PNV01] → [102PNV01]

## 4 Still image files (JPEG files)

The extension of the files is “.JPG”. The file numbers go up automatically. When the capacity of a file number exceeds

9 999, another folder is created to store new image files.

The folder name goes up: [101MSDCF] → [102MSDCF]

- By selecting [  ↔COMPUTER ] on [USB SELECT] (p. 59), you can access the hard disk of the camcorder from the computer through USB connection.
- Do not modify the files or folders on the camcorder through the computer without using the supplied computer application. The image files may be destroyed or may not be played back.
- Operation is not guaranteed, if you perform the above operation without using the supplied computer application.
- When you delete image files, see the steps on page 51. Do not delete the image files on the camcorder directly from the computer.
- Do not format the hard disk of the camcorder using the computer. The camcorder may not operate correctly.
- When the file extensions are not displayed on the screen of the computer, see page 102.
- Do not copy the files on the hard disk of the camcorder from the computer. Operation is not guaranteed.

# About the AVCHD format

Your digital video camera recorder incorporates both the AVCHD format and the MPEG2 format for the recording function.

## What is the AVCHD format?

The AVCHD format is a high definition digital video camera format used to record an HD (high definition) signal of either the 1080i specification\*<sup>1</sup> or the 720p specification\*<sup>2</sup> on 8 cm DVD discs, using efficient data compression coding technology. The MPEG-4 AVC/H.264 format is adopted to compress video data, and the Dolby Digital or Linear PCM system is used to compress audio data.

The MPEG-4 AVC/H.264 format is capable of compressing images at higher efficiency than that of the conventional image compressing format. The MPEG-4 AVC/H.264 format enables a high definition video signal shot on a digital video camera recorder to be recorded on 8 cm DVD discs, internal hard disk drive, flash memory, etc.

## Recording and playback on your camcorder

Based on the AVCHD format, your camcorder records with the HD (high definition) image quality mentioned below. In addition to HD (high definition) image quality, your camcorder is capable of recording an SD (standard definition) signal in the conventional MPEG2 format.

### Video signal:

AVCHD format 1440 × 1080/50i\*<sup>3</sup>

### Audio signal:

Dolby Digital 5.1 ch

### Recording media:

Internal hard disk drive

\*1: 1080i specification

A high definition specification which utilizes 1080 effective scanning lines and the interlace system.

\*2: 720p specification

A high definition specification which utilizes 720 effective scanning lines and the progressive system.

\*3: Data recorded in AVCHD format other than the above mentioned cannot be played on your camcorder.

# About the “Memory Stick”

A “Memory Stick” is a compact, portable IC recording medium with a large data capacity.

You can use only a “Memory Stick Duo,” which is about the half size of a standard “Memory Stick,” with your camcorder. However, we do not guarantee the operation of all types of “Memory Stick Duo” on your camcorder. (See the list below for more details.)

Types of “Memory Stick”	Recording/ Playback
“Memory Stick” (without MagicGate)	–
“Memory Stick Duo” <sup>*1</sup> (without MagicGate)	○
“MagicGate Memory Stick”	–
“Memory Stick Duo” <sup>*1</sup> (with MagicGate)	○ <sup>*2*</sup> <sup>3</sup>
“MagicGate Memory Stick Duo” <sup>*1</sup>	○ <sup>*3</sup>
“Memory Stick PRO”	–
“Memory Stick PRO Duo” <sup>*1</sup>	○ <sup>*2*</sup> <sup>3</sup>

<sup>\*1</sup> A “Memory Stick Duo” is about half the size of a standard “Memory Stick.”

<sup>\*2</sup> The types of “Memory Stick” that support high speed data transfer. The speed of data transfer varies depending on the device to be used.

<sup>\*3</sup> “MagicGate” is a copyright protection technology that records and transfers the contents in an encrypted format. Note that data that uses “MagicGate” technology cannot be recorded or played on your camcorder.

- Still image format: Your camcorder compresses and records image data in the JPEG (Joint Photographic Experts Group) format. The file extension is “.JPG.”
- File names of still images:
  - 101- 0001: This file name appears on the screen of your camcorder.
  - DSC00001.JPG: This file name appears on the display of a computer.
- A “Memory Stick Duo” formatted by a computer (Windows OS/Mac OS) does not have guaranteed compatibility with your camcorder.

- Data read/write speed may vary depending on the combination of the “Memory Stick” and “Memory Stick” compliant product you use.

## On a “Memory Stick Duo” with a write-protect tab

You can prevent accidental erasure of images when you slide the write-protect tab on the “Memory Stick Duo” with a small tapered object, to the write-protect position.

## Notes on use

Damaged or lost image data will not be compensated for, and may occur in the following cases:

- If you eject the “Memory Stick Duo,” turn the power off on your camcorder, or remove the battery pack for replacement while your camcorder is reading or writing image files on the “Memory Stick Duo” (while the access lamp is lit or flashing).
- If you use the “Memory Stick Duo” near magnets or magnetic fields.

It is recommended you make a back-up of important data on the hard disk of a computer.

## ■ On handling a “Memory Stick”

Keep the following in mind when handling a “Memory Stick Duo.”

- Be careful not to apply excessive force when writing on a memo area on a “Memory Stick Duo.”
- Do not attach a label or the like on a “Memory Stick Duo” or a Memory Stick Duo adaptor.
- When you carry or store a “Memory Stick Duo,” put it in its case.
- Do not touch, or allow metallic objects to come into contact with the terminals.
- Do not bend, drop or apply strong force to the “Memory Stick Duo.”
- Do not disassemble or modify the “Memory Stick Duo.”
- Do not let the “Memory Stick Duo” get wet.
- Be careful to keep “Memory Stick Duo” media out of the reach of small children. There is danger that a child might swallow it.

- Do not insert anything other than a “Memory Stick Duo” into the “Memory Stick Duo” slot. Doing so may cause a malfunction.

#### ■ On a location for use

Do not use or keep the “Memory Stick Duo” in the following locations:

- Places subject to extremely high temperature, such as a car parked outside in the summer.
- Places under direct sunlight.
- Places with extremely high humidity or subject to corrosive gases.

#### ■ On the Memory Stick Duo adaptor

After inserting a “Memory Stick Duo” into the Memory Stick Duo adaptor, you can use it with a standard “Memory Stick” compliant device.

- When using a “Memory Stick Duo” with a “Memory Stick” compliant device, be sure to insert the “Memory Stick Duo” into a Memory Stick Duo adaptor.
- When inserting a “Memory Stick Duo” into a Memory Stick Duo adaptor, make sure the “Memory Stick Duo” is inserted facing in the correct direction, then insert it all the way in. Note that improper use may cause a malfunction. Also, if you force the “Memory Stick Duo” into the Memory Stick Duo adaptor in the wrong direction, it may be damaged.
- Do not insert a Memory Stick Duo adaptor without a “Memory Stick Duo” attached. Doing so may result in malfunctions of the unit.

#### ■ On a “Memory Stick PRO Duo”

The maximum memory capacity of a “Memory Stick PRO Duo” that can be used on your camcorder is 2 GB.

## On image data compatibility

- Image data files recorded on a “Memory Stick Duo” by your camcorder conform to the “Design rule for Camera File system” universal standard established by the JEITA (Japan Electronics and Information Technology Industries Association).
- On your camcorder, you cannot play back still images recorded on other devices (DCR-TRV900E or DSC-D700/D770) that do not conform to the universal standard. (These models are not sold in some regions.)
- If you cannot use a “Memory Stick Duo” that has been used with another device, format it with your camcorder (p. 62). Note that formatting erases all information on the “Memory Stick Duo.”
- You may not be able to play back images with your camcorder:
  - When playing back image data modified on your computer.
  - When playing back image data recorded with other devices.

# About the “InfoLITHIUM” battery pack

Your camcorder operates only with an “InfoLITHIUM” battery pack (M series). “InfoLITHIUM” M series battery packs have the  mark.

## What is an “InfoLITHIUM” battery pack?

An “InfoLITHIUM” battery pack is a lithium-ion battery pack that has functions for communicating information related to operating conditions between your camcorder and an optional AC Adaptor/charger.

The “InfoLITHIUM” battery pack calculates the power consumption according to the operating conditions of your camcorder, and displays the remaining battery time in minutes.

With an AC Adaptor/charger, the remaining battery time and charging time appear.

## To charge the battery pack

- Be sure to charge the battery pack before you start using your camcorder.
- We recommend charging the battery pack in an ambient temperature of between 10 °C to 30 °C (50 °F to 86 °F) until the CHG (charge) lamp turns off. If you charge the battery pack outside of this temperature range, you may not be able to charge it efficiently.
- After charging is complete, disconnect the cable from the DC IN jack on your camcorder or remove the battery pack.

## To use the battery pack effectively

- Battery pack performance decreases when the surrounding temperature is 10 °C (50 °F) or below, and the length of time you can use the battery pack becomes shorter. In that case, do one of the following to use the battery pack for a longer time.
  - Put the battery pack in a pocket to warm it up, and insert it in your camcorder right before you start taking shots.
  - Use a large capacity battery pack: NP-QM71D/QM91D (optional).
- Frequent use of the LCD screen or a frequent playback, fast forward or rewind operation wears out the battery pack faster.

We recommend using a large capacity battery pack: NP-QM71D/QM91D.

- Be sure to set the POWER switch to OFF (CHG) when not recording or playing back on your camcorder. The battery pack is also consumed when your camcorder is in recording standby or playback pause.
- Have spare battery packs ready for two or three times the expected recording time, and make trial recordings before making the actual recording.
- Do not expose the battery pack to water. The battery pack is not water resistant.

## About the remaining battery time indicator

- When the power goes off even though the remaining battery time indicator indicates that the battery pack has enough power to operate, charge the battery pack fully again. Remaining battery time will be indicated correctly. Note, however, that the battery indication will not be restored if it is used in high temperatures for a long time, or if left in a fully charged state, or when the battery pack is frequently used. Use the remaining battery time indication as a rough guide only.
- The  mark that indicates low battery flashes even if there are still 5 to 10 minutes of battery time remaining, depending on the operating conditions or ambient temperature.

## About storage of the battery pack

- If the battery pack is not used for a long time, fully charge the battery pack and use it up on your camcorder once a year to maintain proper function. To store the battery pack, remove it from your camcorder and put it in a dry, cool place.
- To discharge the battery pack on your camcorder completely, touch  (SETTINGS) → [GENERAL SET] → [A.SHUT OFF] → [NEVER] on the HOME MENU and leave your camcorder in recording standby until the power goes off (p. 76).

# Maintenance and precautions

## About battery life

- Battery capacity decreases over time and through repeated use. If decreased usage time between charges becomes significant, it is probably time to replace it with a new one.
- Each battery's life is governed by storage, operating and environmental conditions.

## On use and care

- Do not use or store the camcorder and accessories in the following locations:
  - Anywhere extremely hot or cold. Never leave them exposed to temperatures above 60 °C (140 °F), such as under direct sunlight, near heaters or in a car parked in the sun. They may malfunction or become deformed.
  - Near strong magnetic fields or mechanical vibration. The camcorder may malfunction.
  - Near strong radio waves or radiation. The camcorder may not be able to record properly.
  - Near AM receivers and video equipment. Noise may occur.
  - On a sandy beach or anywhere dusty. If sand or dust gets in your camcorder, it may malfunction. Sometimes this malfunction cannot be repaired.
  - Near windows or outdoors, where the LCD screen, the viewfinder, or the lens may be exposed to direct sunlight. This damages the inside of the viewfinder or the LCD screen.
  - Anywhere very humid.
- Operate your camcorder on DC 7.2 V (battery pack) or DC 8.4 V (AC Adaptor).
- For DC or AC operation, use the accessories recommended in these operating instructions.
- Do not let your camcorder get wet, for example, from rain or sea water. If your camcorder gets wet, it may malfunction. Sometimes this malfunction cannot be repaired.
- If any solid object or liquid gets inside the casing, unplug your camcorder and have it checked by a Sony dealer before operating it any further.
- Avoid rough handling, disassembling, modifying, physical shock, or impact such as hammering, dropping or stepping on the product. Be particularly careful of the lens.
- Keep the POWER switch setting to OFF (CHG) when you are not using your camcorder.
- Do not wrap your camcorder with a towel, for example, and operate it. Doing so might cause heat to build up inside.
- When disconnecting the mains lead, pull it by the plug and not the cord.
- Do not damage the mains lead such as by placing anything heavy on it.
- Keep metal contacts clean.

## Maintenance and precautions (Continued)

- Keep the Remote Commander and button-type battery out of children's reach. If the battery is accidentally swallowed, consult a doctor immediately.
- If the battery electrolytic liquid has leaked:
  - consult your local authorized Sony service facility.
  - wash off any liquid that may have contacted your skin.
  - if any liquid gets in your eyes, wash with plenty of water and consult a doctor.

### ■ When not using your camcorder for a long time

- Periodically turn it on and let it run such as by playing back or recording images for about 3 minutes.
- Use up the battery pack completely before storing it.

## Moisture condensation

If your camcorder is brought directly from a cold place to a warm place, moisture may condense inside your camcorder. This may cause a malfunction to your camcorder.

### ■ If moisture condensation has occurred

Leave your camcorder for about 1 hour without turning it on.

### ■ Note on moisture condensation

Moisture may condense when you bring your camcorder from a cold place into a warm place (or vice versa) or when you use your camcorder in a humid place as follows:

- You bring your camcorder from a ski slope into a place warmed up by a heating device.
- You bring your camcorder from an air conditioned car or room into a hot place outside.
- You use your camcorder after a squall or a shower.
- You use your camcorder in a hot and humid place.

### ■ How to prevent moisture condensation

When you bring your camcorder from a cold place into a warm place, put your camcorder in a plastic bag and seal it tightly. Remove the bag when the air temperature inside the plastic bag has

reached the surrounding temperature (after about 1 hour).

## LCD screen



- Do not exert excessive pressure on the LCD screen, as it may cause damage.
- If your camcorder is used in a cold place, a residual image may appear on the LCD screen. This is not a malfunction.
- While using your camcorder, the back of the LCD screen may heat up. This is not a malfunction.

### ■ To clean the LCD screen

If fingerprints or dust make the LCD screen dirty, it is recommended you use a soft cloth to clean it. When you use the LCD Cleaning Kit (optional), do not apply the cleaning liquid directly to the LCD screen. Use cleaning paper moistened with the liquid.

### ■ On adjustment of the touch panel (CALIBRATION)

The buttons on the touch panel may not work correctly. If this happens, follow the procedure below. It is recommended that you connect your camcorder to the wall socket using the supplied AC Adaptor during the operation.

- ① Turn on your camcorder, then press  (HOME).
- ② Disconnect cables other than that of the AC Adaptor from your camcorder, and eject "Memory Stick Duo" from your camcorder.
- ③ Touch  (SETTINGS) → [GENERAL SET] → [CALIBRATION].

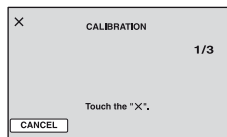

- ④ Touch "x" displayed on the screen with the corner of the "Memory Stick Duo" or the like. The position of "x" changes. Touch [CANCEL] to cancel.



If you did not press the right spot, try the calibration again.

### Notes

- Do not use a sharp-pointed object for calibration. Doing so may damage the LCD screen.
- You cannot calibrate the LCD screen if it is rotated, or closed with the screen facing out.

### On handling the casing

- If the casing is soiled, clean the camcorder body with a soft cloth lightly moistened with water, and then wipe the casing with a dry soft cloth.
- Avoid the following to avoid damage to the finish:
  - Using chemicals such as thinner, benzene, alcohol, chemical cloths, repellent, insecticide and sunscreen.
  - Handling the camcorder with above substances on your hands.
  - Leaving the casing in contact with rubber or vinyl objects for a long period of time.

### About care and storage of the lens

- Wipe the surface of the lens clean with a soft cloth in the following instances:
  - When there are fingerprints on the lens surface.
  - In hot or humid locations
  - When the lens is exposed to salty air such as at the seaside.
- Store in a well-ventilated location subject to little dirt or dust.
- To prevent mold, periodically clean the lens as described above. It is recommended that you operate your camcorder about once a month to keep it in optimum state for a long time.

### On charging the pre-installed rechargeable battery

Your camcorder has a pre-installed rechargeable battery to retain the date, time, and other settings even when the POWER switch is set to OFF (CHG). The pre-installed rechargeable battery is always charged while your camcorder is connected to the wall socket via the AC Adaptor or while the battery pack is attached. The

rechargeable battery will be fully discharged in about **4 months** if you do not use your camcorder at all. Use your camcorder after charging the pre-installed rechargeable battery.

However, even if the pre-installed rechargeable battery is not charged, the camcorder operation will not be affected as long as you are not recording the date.

### Procedures

Connect your camcorder to a wall socket using the supplied AC Adaptor, and leave it with the POWER switch set to OFF (CHG) for more than 24 hours.

### To change the battery of the Remote Commander

- ① While pressing on the tab, inset your fingernail into the slit to pull out the battery case.
- ② Place a new battery with the + side facing up.
- ③ Insert the battery case back into the Remote Commander until it clicks.

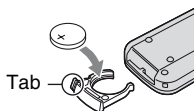

### WARNING

Battery may explode if mistreated. Do not recharge, disassemble or dispose of in fire.

- When the lithium battery becomes weak, the operating distance of the Remote Commander may shorten, or the Remote Commander may not function properly. In this case, replace the battery with a Sony CR2025 lithium battery. Use of another battery may present a risk of fire or explosion.

# Specifications

## System

### Video compression format

AVCHD (HD)/MPEG2 (SD)/JPEG  
(Still images)

### Audio compression format

Dolby Digital 2/5.1ch  
Dolby Digital 5.1 Creator

### Video signal

PAL color, CCIR standards  
1080/50i specification

### Hard disk

30 GB  
When measuring media capacity, 1 GB equals 1 billion bytes, a portion of which is used for data management.

### Recording format

Movie (HD): AVCHD 1080/50i  
Movie (SD): MPEG2-PS  
Still image: Exif™ Ver.2.2

### Recording/playback time (HD)

AVC HD 15M (XP): Approx. 240 min  
AVC HD 9M (HQ): Approx. 420 min  
AVC HD 7M (SP): Approx. 510 min  
AVC HD 5M (LP): Approx. 660 min

### Recording/playback time (SD)

SD 9M (HQ): Approx. 440 min  
SD 6M (SP): Approx. 650 min  
SD 3M (LP): Approx. 1 250 min

### Recordable images/cuts

Movie (HD): 3 999  
Movie (SD): 9 999  
Still image: 9 999

### Viewfinder

Electric viewfinder (color)

### Image device

5.9 mm (1/3 type) CMOS sensor  
Recording pixels (still image, 4:3):  
Max. 4.0 mega (2 304 × 1 728) pixels\*<sup>2</sup>  
Gross: Approx. 2 100 000 pixels  
Effective (movie, 16:9):  
1 430 000 pixels  
Effective (movie, 4:3):  
1 080 000 pixels

Effective (still image, 16:9):  
1 490 000 pixels  
Effective (still image, 4:3):  
1 990 000 pixels

### Lens

Carl Zeiss Vario-Sonnar T\*  
10 × (Optical), 20 ×, 80 × (Digital)

### Focal length

f=5.1 ~ 51 mm (7/32 ~ 2 1/8 in.)  
When converted to a 35 mm still camera  
For movies \*<sup>3</sup>: 41.3 ~ 485 mm (1 11/16 ~ 19 1/8 in.) (16:9), 50.5 ~ 594 mm (2 ~ 23 1/2 in.) (4:3)  
For still images: 37 ~ 370 mm (1 1/2 ~ 14 5/8 in.) (4:3), 40.4 ~ 404 mm (1 5/8 ~ 16 in.) (16:9)  
F1.8 ~ 2.9  
Filter diameter: 30 mm (1 3/16 in.)

### Color temperature

[AUTO], [ONE PUSH],  
[INDOOR] (3 200 K),  
[OUTDOOR] (5 800 K)

### Minimum illumination

5 lx (lux) (F 1.8)  
0 lx (lux) (during NightShot function)

\*1“Exif” is a file format for still images, established by the JEITA (Japan Electronics and Information Technology Industries Association). Files in this format can have additional information such as your camcorder’s setting information at the time of recording.

\*<sup>2</sup>The unique pixel array of Sony’s ClearVid CMOS Sensor and image processing system (new Enhanced Imaging Processor) allows for still image resolution equivalent to twice that of the image sensor’s effective pixel count.

\*<sup>3</sup>The focal length figures are actual figures resulting from wide angle pixel read-out.

## Input/Output connectors

### Audio/Video output

10-pin connector

Video signal: 1 Vp-p, 75  $\Omega$  (ohms), unbalanced

Luminance signal: 1 Vp-p, 75  $\Omega$  (ohms), unbalanced

Chrominance signal: 0.3 Vp-p, 75  $\Omega$  (ohms), unbalanced

Audio signal: 327 mV (at load impedance 47 k $\Omega$  (kilohms)), Output impedance with less than 2.2 k $\Omega$  (kilohms)

### COMPONENT OUT jack

Y: 1 Vp-p, 75 $\Omega$  (ohms), unbalanced  
PB/PR, CB/CR: +/- 350 mVp-p

### HDMI OUT jack

Type A (19-pin)

### Headphone jack

Stereo minijack ( $\varnothing$  3.5 mm)

### USB jack

mini-B

### MIC input jack

Stereo minijack ( $\varnothing$  3.5 mm)

### REMOTE jack

Stereo mini-minijack ( $\varnothing$  2.5 mm)

## LCD screen

### Image

8.8 cm (3.5 type, aspect ratio 16:9)

### Total dot number

211 200 (960  $\times$  220)

## General

### Power requirements

DC 7.2 V (battery pack)

DC 8.4 V (AC Adaptor)

### Average power consumption

During camera recording using the viewfinder with normal brightness: 4.5 W

During camera recording using the LCD with normal brightness: 4.7 W

### Operating temperature

0  $^{\circ}$ C to + 40  $^{\circ}$ C (32  $^{\circ}$ F to 104  $^{\circ}$ F)

### Storage temperature

-20  $^{\circ}$ C to + 60  $^{\circ}$ C (-4  $^{\circ}$ F to + 140  $^{\circ}$ F)

### Dimensions (approx.)

78  $\times$  84  $\times$  165 mm

(3 1/8  $\times$  3 3/8  $\times$  6 1/2 in.) (w/h/d) including the projecting parts

78  $\times$  84  $\times$  165 mm

(3 1/8  $\times$  3 3/8  $\times$  6 1/2 in.) (w/h/d)

including the projecting parts, and the NP-FM50 rechargeable battery pack attached

### Mass (approx.)

640 g (1 lb 6 oz) main unit only

720 g (1 lb 9 oz) including the NP-FM50 rechargeable battery pack

### Supplied accessories

See page 23.

## AC Adaptor AC-L15A

### Power requirements

AC 100 - 240 V, 50/60 Hz

### Current consumption

0.35 - 0.18 A

### Power consumption

18 W

### Output voltage

DC 8.4 V\*

### Operating temperature

0  $^{\circ}$ C to + 40  $^{\circ}$ C (32  $^{\circ}$ F to 104  $^{\circ}$ F)

## Specifications (Continued)

### Storage temperature

-20 °C to + 60 °C (-4 °F to + 140 °F)

### Dimensions (approx.)

56 × 31 × 100 mm (2 1/4 × 1 1/4 × 4 in.)  
(w/h/d) excluding the projecting parts

### Mass (approx.)

190 g (6.7 oz) excluding the mains lead

\* See the label on the AC Adaptor for other specifications.

## Rechargeable battery pack (NP-FM50)

### Maximum output voltage

DC 8.4 V

### Output voltage

DC 7.2 V

### Capacity

8.5 Wh (1 180 mAh)

### Dimensions (approx.)

38.2 × 20.5 × 55.6 mm  
(1 9/16 × 13/16 × 2 1/4 in.) (w/h/d)

### Mass (approx.)

76 g (2.7 oz)

### Operating temperature

0 °C to + 40 °C (32 °F to 104 °F)

### Type

Lithium ion

Design and specifications are subject to change without notice.

## On trademarks

- “Handycam” and **HANDYCAM** are registered trademarks of Sony Corporation.
- “AVCHD” and “AVCHD” logotype are trademarks of Matsushita Electric Industrial Co., Ltd. and Sony Corporation.
- “Memory Stick,”  “Memory Stick Duo,” **“MEMORY STICK DUO,”** “Memory Stick PRO Duo,” **“MEMORY STICK PRO DUO,”** “MagicGate,” **“MAGIC GATE,”** “MagicGate Memory Stick” and “MagicGate Memory Stick Duo” are trademarks of Sony Corporation.
- “InfoLITHIUM” is a trademark of Sony Corporation.
- Dolby and the double-D symbol are trademarks of Dolby Laboratories.
- Dolby Digital 5.1 Creator is a trademark of Dolby Laboratories.
- Microsoft, Windows, and Windows Media are trademarks or registered trademarks of U.S. Microsoft Corporation in the U.S. and other countries.
- Macintosh is a trademark of Apple Computer, Inc in the U.S. and other countries.
- HDMI, the HDMI logo and High-Definition Multimedia Interface are trademarks or registered trademarks of HDMI Licensing LLC.
- Intel, Intel Core, and Pentium are trademarks or registered trademarks of Intel Corporation or its subsidiaries in the United States and other countries.
- Adobe, and Adobe Reader are trademarks of Adobe Systems Incorporated.

All other product names mentioned herein may be the trademarks or registered trademarks of their respective companies. Furthermore, <sup>TM</sup> and “®” are not mentioned in each case in this manual.

## Notes on the License

ANY USE OF THIS PRODUCT OTHER THAN CONSUMER PERSONAL USE IN ANY MANNER THAT COMPLIES WITH THE MPEG-2 STANDARD FOR ENCODING VIDEO INFORMATION FOR PACKAGED MEDIA IS EXPRESSLY PROHIBITED WITHOUT A LICENSE UNDER APPLICABLE PATENTS IN THE MPEG-2 PATENT PORTFOLIO, WHICH LICENSE IS AVAILABLE FROM MPEG LA, L.L.C., 250 STEELE STREET, SUITE 300, DENVER, COLORADO 80206.

THIS PRODUCT IS LICENSED UNDER THE AVC PATENT PORTFOLIO LICENSE FOR THE PERSONAL AND NON-COMMERCIAL USE OF A CONSUMER TO

(i) ENCODE VIDEO IN COMPLIANCE WITH THE AVC STANDARD ("AVC VIDEO") AND / OR

(ii) DECODE AVC VIDEO THAT WAS ENCODED BY A CONSUMER ENGAGED IN A PERSONAL AND NON-COMMERCIAL ACTIVITY AND/OR WAS OBTAINED FROM A VIDEO PROVIDER LICENSED TO PROVIDE AVC VIDEO. NO LICENSE IS GRANTED OR SHALL BE IMPLIED FOR ANY OTHER USE.

ADDITIONAL INFORMATION MAY BE OBTAINED FROM MPEG LA, L.L.C.  
SEE <[HTTP://MPEGLA.COM](http://MPEGLA.COM)>

"C Library," "Expat," "zlib," and "libjpeg" software are provided in your camcorder. We provide this software based on license agreements with their owners of copyright. Based on requests by the owners of copyright of these software applications, we have an obligation to inform you of the following. Please read the following sections.

Read "license1.pdf" in the "License" folder on the CD-ROM. You will find licenses (in English) of "C Library," "Expat," "zlib," and "libjpeg" software.

## On GNU GPL/LGPL applied software

The software that is eligible for the following GNU General Public License (hereinafter referred to as "GPL") or GNU Lesser General Public License (hereinafter referred to as "LGPL") are included in the camcorder.

This informs you that you have a right to have access to, modify, and redistribute source code for these software programs under the conditions of the supplied GPL/LGPL.

Source code is provided on the web. Use the following URL to download it.

<http://www.sony.net/Products/Linux/>

We would prefer you do not contact us about the contents of source code.

Read "license2.pdf" in the "License" folder on the CD-ROM. You will find licenses (in English) of "GPL," and "LGPL" software.



To view the PDF, Adobe Reader is needed. If it is not installed on your computer, you can download it from the Adobe Systems web page:

<http://www.adobe.com/>

# Identifying parts and controls

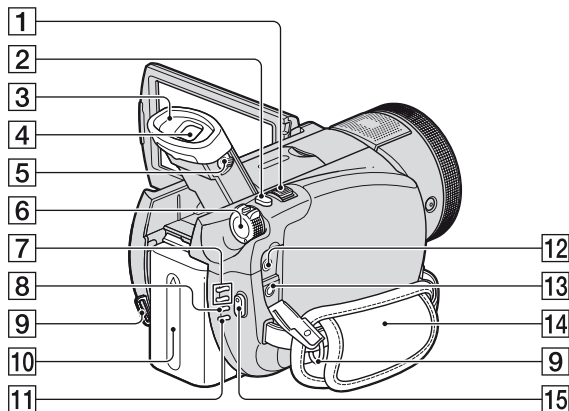
The numbers in ( ) are reference pages.



- 1** Power zoom lever (35, 43)
- 2** PHOTO button (34)
- 3** Eyecup
- 4** Viewfinder (29)
- 5** Viewfinder lens adjustment lever (29)
- 6** POWER switch (28)
- 7**  (Movie)/  (Still) mode lamps (28)
- 8** CHG (charge) lamp (24)
- 9** Hooks for a shoulder belt  
Attach a shoulder belt (optional).
- 10** Battery pack (24)
- 11** ACCESS lamp (Hard disk) (32)
- 12** REMOTE jack
- 13**  (headphones) jack
- 14** Grip belt (32)
- 15** START/STOP button (33)

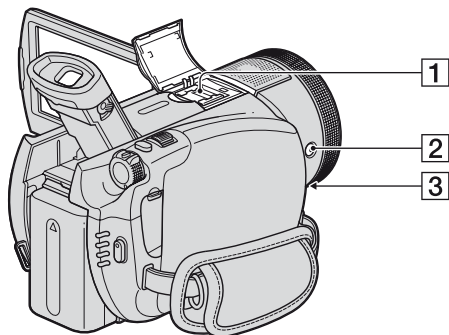

- 1** Active Interface Shoe Active Interface Shoe (36)  
 The Active Interface Shoe supplies power to optional accessories such as a video light, a flash, or a microphone. The accessory can be turned on or off as you operate the POWER switch on your camcorder. Refer to the operating instructions supplied with your accessory for details.

The Active Interface Shoe has a safety device for fixing the installed accessory securely. To connect an accessory, press down and push it to the end, and then tighten the screw. To remove an accessory, loosen the screw, and then press down and pull out the accessory.



- When you are recording movies with an external flash (optional) connected to the accessory shoe, turn off the power of the external flash to prevent charging noise being recorded.
- You cannot use an external flash (optional) and the built-in flash at the same time.
- When an external microphone (optional) is connected, it takes precedence over the internal microphone (p. 36).

- 2**  (flash) button (36)

- 3** MIC (PLUG IN POWER) jack  
 When an external microphone (optional) is connected, it takes precedence over the internal microphone (p. 36).

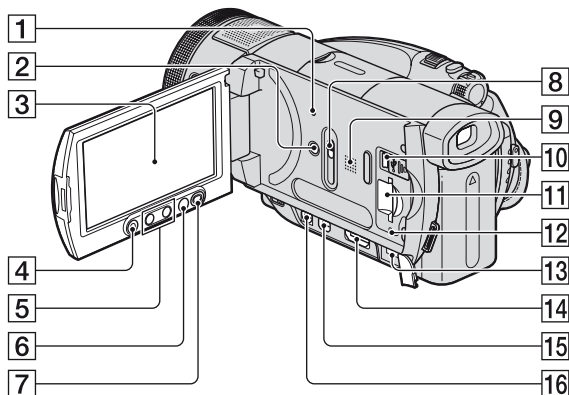
## Identifying parts and controls (Continued)



- 1** RESET button  
Initializes all the settings, including the setting of the date and time.
- 2** DISP/BATT INFO button (25, 29)
- 3** LCD screen/touch panel (16, 29)
- 4** START/STOP button (33)
- 5** Zoom buttons (35, 43)
- 6**  (HOME) button (18, 64)
- 7** DISC BURN button (50)
- 8** JACK COVER OPEN/CLOSE knob (44)
- 9** Speaker  
Playback sounds come out from the speaker. For how to adjust the volume, see page 41.
- 10**  (USB) jack (59)
- 11** “Memory Stick Duo” slot (32)
- 12** Access lamp (“Memory Stick Duo”) (32)
- 13** DC IN jack (24)
- 14** HDMI OUT jack (44)
- 15** COMPONENT OUT jack (44)
- 16** A/V OUT jack (44)

### To open the jack cover

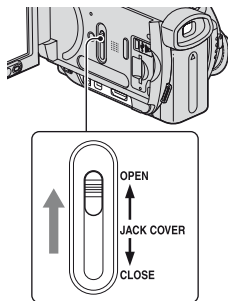

- 11** “Memory Stick Duo” slot (32)



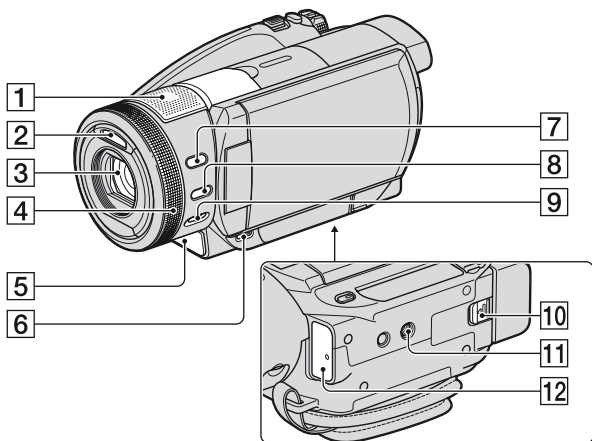

- 1** Internal 4ch microphone (36)  
An Active Interface Shoe compatible microphone (optional) will take precedence when connected.
- 2** Flash (36)
- 3** Lens (Carl Zeiss Lens) (4)
- 4** Camera control ring (39)
- 5** Camera recording lamp (75)  
Lights up in red during recording.  
Flashes when remaining hard disk space or battery power is low.
- 6**  (VIEW IMAGES) button (40)
- 7** BACK LIGHT button (38)
- 8** MANUAL button (39)
- 9** NIGHTSHOT switch (37)
- 10** BATT (battery release) lever (25)
- 11** Tripod receptacle  
Attach the tripod (optional: the length of the screw must be less than 5.5 mm (7/32 in.)) to the tripod receptacle using a tripod screw.
- 12** Remote sensor/Infrared port  
Point the Remote Commander (p. 126) towards the remote sensor to operate your camcorder.

### Remote Commander

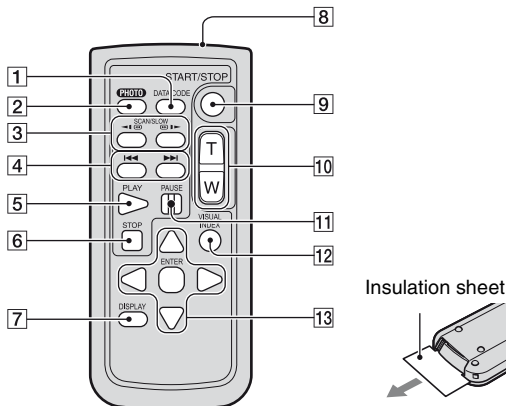

- 1** DATA CODE button (72)  
Displays the date and time or camera setting data of the recorded images when you press this during playback.
- 2** PHOTO button (34)  
The on-screen image when you press this button will be recorded as a still image.
- 3** SCAN/SLOW buttons (41)
- 4** ◀◀ ▶▶ (Previous/Next) buttons (41)
- 5** PLAY button (41)
- 6** STOP button (41)
- 7** DISPLAY button (25)
- 8** Transmitter
- 9** START/STOP button (33)
- 10** Power zoom buttons (35, 43)
- 11** PAUSE buttons (41)
- 12** VISUAL INDEX button (40)  
Displays a VISUAL INDEX screen.
- 13** ◀/▶/▲/▼/ENTER buttons  
When you press any button, the orange frame appears on the LCD screen. Select a desired button or an item with ◀/▶/▲/▼, then press ENTER to enter.

#### 🔌 Notes

- Remove the insulation sheet before using the Remote Commander.
- Point the Remote Commander towards the remote sensor to operate your camcorder (p. 125).
- When no commands have been sent from the Remote Commander in a certain period, the orange frame disappears. When you press any of ◀/▶/▲/▼, or ENTER again, the frame appears at the position where it was displayed last.
- You cannot select some buttons on the LCD screen using ◀/▶/▲/▼.
- To change the battery, see page 117.

# Indicators displayed during recording/playback

## Recording movies

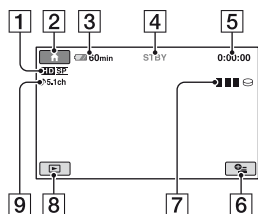

- 1 Recording format (HD/SD) (14) and recording mode (XP/HQ/SP/LP) (66)
- 2 HOME button (16)
- 3 Remaining battery (approx.) (25)
- 4 Recording status ([STBY] (standby) or [REC] (recording))
- 5 Counter (hour/minute/second)
- 6 OPTION button (17)
- 7 Dual Rec (37)
- 8 VIEW IMAGES button
- 9 5.1ch surround recording (36)

## Recording still images

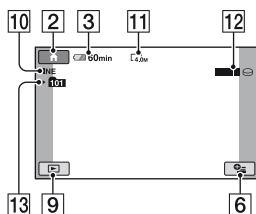

- 10 Quality ([FINE] / [STD]) (71)
- 11 Image size (69)
- 12 Appears while a still image is being saved.
- 13 Recording folder ("Memory Stick Duo")

### 💡 Tips

- As the number of still images recorded on a "Memory Stick Duo" increases, new folders are automatically created to store them.

## Indicators displayed during recording/playback (Continued)

### Viewing movies

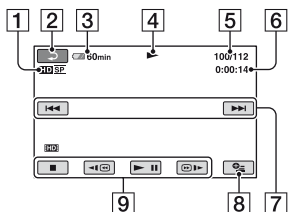

- 1 Recording format (HD/SD) (14) and recording mode (XP/HQ/SP/LP) (66)
- 2 Return button
- 3 Remaining battery (approx.) (25)
- 4 Playback mode
- 5 Current scene number/Number of total scenes
- 6 Counter (hour/minute/second)
- 7 Previous/Next button (41)
- 8 OPTION button (17)
- 9 Video operation buttons (41)

### Viewing still images

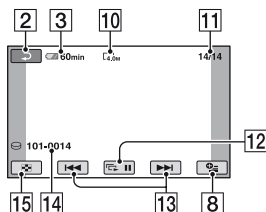

- 10 Image size (69)
- 11 Current still image number /Number of recorded still images
- 12 Slide show button (43)
- 13 Previous/Next button (42)
- 14 Data file name
- 15 VISUAL INDEX button (40)

## Indicators when you made changes

Following indicators appear during recording/playback to indicate the settings of your camcorder.

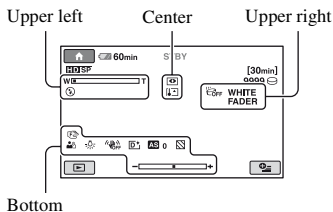

### Upper left

Indicator	Meaning
	5.1ch surround recording/playback (36)
	Self-timer recording (83)
	Flash light (36)
	MICREF LEVEL low (82)

### Center

Indicator	Meaning
	Slide show set (43)
	NightShot (37)
	Super NightShot (81)
	Color Slow Shutter (81)
	PictBridge connecting (59)
	Warning (103)

### Upper right

Indicator	Meaning
	Fader (81)
	LCD backlight off (29)

Indicator	Meaning
	Drop sensor off (76)
	Drop sensor activated (76)

### Bottom

Indicator	Meaning
	Picture effect (82)
	Digital effect (82)
	Manual focus (78)
0.1m, 1.0m, 10m, ∞	Focal distance (78)
	PROGRAM AE (80)
	Backlight (38)
	White balance (80)
	WIDE SELECT (67)
	SteadyShot off (67)
	SPOT METER (79)/EXPOSURE (79)
	AE SHIFT (66)
	WB SHIFT (67)
	Tele macro (79)
	Zebra (68)

### Data code during recording

The recording date and time is recorded automatically on the hard disk and “Memory Stick Duo.” They are not displayed while recording. However, you can check them as [DATA CODE] during playback (p. 72).

# Glossary

## ■ 5.1ch surround sound

A system that plays back sound on 6 speakers, 3 at the front (left, right and center) and 2 at the rear (right and left) with an additional low-pass subwoofer counted as a 0.1 channel for frequencies of 120 Hz or lower.

## ■ AVCHD format

A high definition digital video camera format used to record an HD (high definition) signal using the MPEG-4 AVC/H.264 format.

## ■ Dolby Digital

An audio encoding (compression) system developed by Dolby Laboratories Inc.

## ■ Dolby Digital 5.1 Creator

Sound compression technology developed by Dolby Laboratories Inc. which compresses audio efficiently while preserving high sound quality. It enables recording of 5.1ch surround sound while using hard disk space more efficiently. Discs created by Dolby Digital 5.1 Creator can be played back on a compatible DVD device. You can enjoy more realistic sound by playing the movie on the device that supports 5.1ch surround sound.

## ■ Extension

The last three letters of a file name after “.”. The extension of a movie file recorded on the camcorder is “.MPG,” while that of a still image is “.JPG”. If you cannot see an extension on your file name, see page 102.

## ■ Formatting

The process of deleting all recorded images from the hard disk and restoring its original storage capacity so that it can be rerecorded onto.

## ■ Fragmentation

The condition of a hard disk in which files are divided into pieces scattered around the hard disk. You may not save your images correctly. You can solve the condition by performing [FORMAT] (p. 62).

## ■ HOME MENU

The HOME MENU is the primary screen displayed when  (HOME) is pressed, and works as the gateway to the functions of your camcorder.

## ■ JPEG

JPEG stands for Joint Photographic Experts Group, a still image data compression (data capacity reduction) standard. Your camcorder records still images in JPEG format.

## ■ MPEG

MPEG stands for Moving Picture Experts Group, the group of standards for the coding (image compression) of video (movie) and audio. There are MPEG1 and MPEG2 formats. Your camcorder records movies with SD (standard definition) image quality in MPEG2 format.

## ■ MPEG2 format

A format used to record an SD (standard definition) signal on the hard disk.

## ■ MPEG-4 AVC/H.264

The latest image coding format standardized jointly by two international standardization organizations, the ISO-IEC and the ITU-T, in 2003. Compared with the conventional MPEG2 format, MPEG-4 AVC/H.264 has more than twice the efficiency. Your camcorder employs MPEG-4 AVC/H.264 to encode high definition movies.

## ■ OPTION MENU

The OPTION MENU appears when  (OPTION) is pressed, and allows quick access to the functions available for your camcorder's status at that time.

## ■ Original

A movie recorded by your camcorder onto the hard disk is called an “original.”

## ■ Playlist

A list of your favorite selected original movies.

## ■ Recording image quality

The image quality, HD (high definition) or SD (standard definition), can be selected for movies. The higher the recording quality, the shorter the recording time of the hard disk.

## ■ Thumbnail

Reduced-size images which enable you to view many images at the same time. “VISUAL INDEX” use a thumbnail display system.

## ■ VBR

VBR stands for Variable Bit Rate, the recording format for automatically controlling the bit rate (the volume of recording data in a given time segment) according to the scene being recorded. For fast-moving video, a lot of hard disk space is used to produce a clear image, so the recording time to the hard disk shortens.

## ■ VISUAL INDEX

This function displays images of movies and still images you have recorded so that you can select those scenes you want to play back.

# Index

## Numeric

1080i/576i.....	74
16:9.....	74
16:9 WIDE.....	67
21-pin adaptor.....	49
4:3.....	67, 74
4:3 TV.....	47
576i.....	74
5.1ch surround recording.....	36
5.1-channel surround sound.....	36

## A

AC Adaptor.....	24
Access lamp	
Hard disk.....	32
"Memory Stick Duo".....	32
Active Interface Shoe.....	36
Adjusting exposure for back light.....	38, 95
AE SHIFT.....	66
AREA SET.....	75
AVCHD format.....	14, 111, 130
A.SHUT OFF (Auto shut off).....	76
A/V connecting cable.....	45, 58
A/V OUT jack.....	45, 58

## B

BACK LIGHT.....	38, 95
Backup.....	See Saving images
BATT (battery release) lever.....	25
Battery	
BATT INFO (Battery info).....	25
Remaining battery.....	25
BEACH&SKI.....	80
BEEP.....	73
BLACK FADER.....	82
Button-type lithium battery.....	117

B&W.....	82
----------	----

## C

CALIBRATION.....	116
Camera control ring.....	39
CAMERA DATA.....	72
CD-ROM.....	84
Charging the battery.....	24
Battery pack.....	24
Pre-installed rechargeable battery.....	117
Charging time.....	26
CHG (charge) lamp.....	24
CLOCK SET.....	30
CLOCK/LANG.....	75
COLOR SLOW S (Color Slow Shutter).....	81, 98, 99
COMPONENT.....	74
COMPONENT OUT jack.....	45
Component video cable.....	45
Compression format.....	112
Computer.....	84
Connection	
4:3 TV.....	47
DVD/HDD recorders.....	58
High definition TV.....	45
Printer.....	59
VCR.....	58
Wide TV.....	47
Copyright.....	4, 120
Counter.....	127

## D

DATA CODE.....	30, 72
DATE/TIME.....	30, 72
DC IN jack.....	24
DC plug.....	24
DELETE	
Hard disk.....	51
"Memory Stick Duo".....	52
DEMO MODE.....	75, 90

DIGITAL ZOOM.....	67
DISP OUTPUT.....	74
Display indicators.....	127
DISP/BATT INFO button.....	25, 29
Dolby Digital 5.1 Creator.....	36
DROP SENSOR.....	76
Dual Rec.....	37
Dubbing.....	58
D.EFFECT (Digital effect).....	82, 98

## E

Easy PC-Back-up.....	See First Step Guide
Editing.....	51
EXPOSURE.....	79, 98
EXP.FOCUS (Expanded Focus).....	68, 98
Extension.....	102, 110, 130

## F

FADER.....	81, 98
File.....	110
FILE NO. (File number).....	71
FINE.....	71
Fireworks.....	80
First Step Guide.....	84, 89
Flash.....	94
Flash button.....	36
FLASH LEVEL.....	71
FOCUS.....	78, 95
Folder.....	110
FORMAT	
Hard disk.....	62
"Memory Stick Duo".....	62
Fragmentation.....	130
Full charge.....	24

## G

GENERAL SET.....	75
Grip belt.....	32



GUIDEFAME .....68

## H

HD movie management  
file.....110

HD QUALITY .....66

HD REC MODE .....66

HD (high definition) image  
quality .....14

HDD INFO .....63

HDMI cable .....46

HDMI OUT jack.....45

Help

HOME MENU .....20

Software.....85

High altitudes.....5

High Definition TV .....45

Holding the camcorder .....32

HOME MENU .....16, 64, 130

CLOCK/LANG .....75

GENERAL SET .....75

MOVIE SETTINGS .....66

OUTPUT SETTINGS ...74

PHOTO SETTINGS.....69

SOUND/DISP SET .....73

VIEW IMAGES SET ...72

HQ .....66

## I

Icon .....See Display indicators

Image management files.....110

Image quality

Movie.....14

Still image.....71

IMAGE SIZE.....69

Index screen display  
button .....128

Indicators .....129

INDOOR.....80

“InfoLITHIUM” battery  
pack .....114

Infrared port .....37, 125

Install.....86

Insulation sheet .....126

Internal 4ch microphone ....125

## J

Jacks .....44

JPEG.....110, 112, 130

## L

LANDSCAPE .....80

LANGUAGE SET .....75

LCD backlight.....29

LCD BL LEVEL (LCD back  
light level) .....73, 99

LCD BRIGHT .....73

LCD COLOR .....73

LCD PANEL .....74

LCD panel .....29

LCD BL LEVEL.....73

LCD BRIGHT.....73

LCD COLOR.....73

LCD screen .....29

Lens cover .....28, 32

LP .....66

LUMI. KEY  
(luminance key).....82

## M

Mains lead .....24

Maintenance .....115

MANAGE HDD/MEMORY  
category .....61

“Memory Stick” .....112

“Memory Stick Duo”  
Number of recordable  
pictures.....70

Write-protect tab .....112

Memory Stick Duo  
adaptor.....113

“Memory Stick Duo” slot ....32

MICREF LEVEL .....82

Mirror mode .....38

Moisture condensation.....116

Movie

Image quality.....14

Recording mode .....66

Shooting .....33

MOVIE SETTINGS .....66

MPEG .....130

MPEG2 .....110

MPEG2 format .....14, 130

MPEG-4 AVC/H.264 .....130

## N

NightShot.....37

NIGHTSHOT switch.....37

NS LIGHT (NightShot  
Light) .....67

Number of recordable  
pictures .....70

## O

OLD MOVIE .....82, 98

ONE PUSH.....81

One Touch Disc Burn  
.....See First Step Guide

Operation confirmation beep  
.....See BEEP

OPTION MENU .....17, 77, 130

Original .....54, 130

OTHERS category.....51

OUTDOOR.....80

OUTPUT SETTINGS .....74

## P

PAL.....108

PASTEL .....82

PB zoom .....43

PHOTO SETTINGS .....69

PictBridge .....59

PictBridge PRINT .....59

PICT.EFFECT (Picture  
effect).....82, 98

Playback .....40

## Index (Continued)

- Playing time ..... 26
- Playlist
- Creating ..... 54
  - ERASE ..... 55
  - MOVE ..... 56
  - Playback ..... 55
- PORTRAIT (Soft portrait) ... 80
- POWER switch ..... 28
- Pre-installed rechargeable battery ..... 117
- Preparation
- Camcorder ..... 23
  - Computer ..... 84
- Previous/Next buttons ..... 42
- Print ..... 59
- PROGRAM AE ..... 80, 98
- ### Q
- QUALITY ..... 71
- ### R
- REC LAMP (Recording lamp) ..... 75
- REC SET ..... 66
- Recording format ..... 14, 66
- Recording image quality ..... 14, 131
- Recording time ..... 26
- REDEYE REDUC ..... 71
- Remaining
- Battery ..... 25
  - Hard disk ..... 63
  - “Memory Stick Duo” ..... 35
- REMAINING (movie) ..... 68
- Remote Commander ..... 96, 126
- REMOTE CTRL (Remote control) ..... 76
- Remote sensor ..... 125
- RESET ..... 124
- RING SETTING ..... 68
- ### S
- S VIDEO cable ..... 48
- S VIDEO jack ..... 58
- Saving images ..... 50
- SD movie files ..... 110
- SD QUALITY ..... 66
- SD REC MODE ..... 66
- SD (standard definition) image quality ..... 14
- SELECT DEVICES category ..... 57
- Self-diagnosis display ..... 103
- SELF-TIMER ..... 83
- SEPIA ..... 82
- Setting the date and time ..... 30
- SETTINGS ..... 64
- SETTINGS category ..... 64
- Shooting ..... 32
- Shoulder belt ..... 122
- SMTH SLW REC ..... 38
- Software ..... 86
- SOUND/DISP SET ..... 73
- SP ..... 66
- Speaker ..... 124
- Specifications ..... 118
- SPOT FOCUS ..... 79, 98
- SPOT METER (Flexible spot meter) ..... 79, 98
- SPOTLIGHT ..... 80
- STANDARD ..... 71
- STEADYSHOT ..... 67, 95, 98
- Still image
- IMAGE SIZE ..... 69
  - QUALITY ..... 71
  - Shooting ..... 34
  - Still image format ..... 112
- Still image files ..... 110
- SUNSET&MOON ..... 80
- SUPER NS (Super NightShot) ..... 81, 98
- System requirements ..... 85
- ### T
- TELE MACRO ..... 79, 98
- Telephoto ..... 35
- Thumbnail ..... 131
- Touch panel ..... 18
- Trademark ..... 120
- Transmitter ..... 126
- Tripod ..... 125
- TV color system ..... 108
- TV CONNECT Guide ..... 44
- TV TYPE ..... 74
- ### U
- USB 2.0 ..... 85
- USB cable ..... 23
- USB jack ..... 124
- Using abroad ..... 108
- ### V
- VBR ..... 15, 131
- VF B.LIGHT (Viewfinder brightness) ..... 73
- VIEW IMAGES SET ..... 72
- Viewfinder ..... 29
- Brightness ..... 73
- Viewfinder lens adjustment lever ..... 29
- Viewing pictures on a TV ... 44
- VISUAL INDEX ..... 40, 131
- VOLUME ..... 72
- Volume adjustment ..... 41
- V-OUT/PANEL ..... 74
- ### W
- Wall socket ..... 24
- Warning indicators ..... 103
- Warning messages ..... 104
- WB SHIFT (White Balance Shift) ..... 67
- WHITE BAL. (White balance) ..... 80, 98

WHITE FADER .....	82
Wide angle .....	35
WIDE SELECT .....	67, 99
Wide TV .....	47
Windows .....	84, 85
World time difference .....	109
Write-protect tab .....	112

## **X**

XP .....	66
----------	----

## **Z**

ZEBRA .....	68
Zoom .....	35
Zoom lever .....	35