

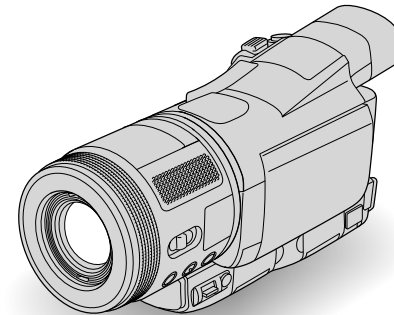

Digital HD Video Camera Recorder
HANDYCAM

Operating Guide

HDR-HC1E



 Enjoying pictures with high definition quality **8**

Getting Started **10**

 Recording/Playback **22**

Using the Menu **38**

Dubbing/Editing **62**

Using a Computer **72**

Troubleshooting **80**

Additional Information **99**

Quick Reference **112**

<http://www.sony.net/>



Printed on 100% recycled paper using VOC (Volatile Organic Compound)-free vegetable oil based ink.

Printed in Japan

GB



2 631 478 120

HDV
HDV 1080i

Mini **DV** Digital Video Cassette

 MEMORY STICK™

 InfoLITHIUM™ **M** SERIES

© 2005 Sony Corporation

Read this first

Before operating the unit, please read this manual thoroughly, and retain it for future reference.



WARNING

To prevent fire or shock hazard, do not expose the unit to rain or moisture.

FOR CUSTOMERS IN THE UNITED KINGDOM

NOTICE ON THE SUPPLIED AC ADAPTOR

A moulded plug complying with BS1363 is fitted to this equipment for your safety and convenience.

Should the fuse in the plug supplied need to be replaced, a fuse of the same rating as the supplied one and approved by ASTA or BSI to BS1362 (i.e., marked with  or  mark) must be used.

If the plug supplied with this equipment has a detachable fuse cover, be sure to attach the fuse cover after you change the fuse. Never use the plug without the fuse cover. If you should lose the fuse cover, please contact your nearest Sony service station.

FOR CUSTOMERS IN EUROPE

ATTENTION

The electromagnetic fields at the specific frequencies may influence the picture and sound of this camcorder.

This product has been tested and found compliant with the limits set out in the EMC Directive for using connection cables shorter than 3 meters (9.8 feet).

Notice

If static electricity or electromagnetism causes data transfer to discontinue midway (fail), restart the application or disconnect and connect the communication cable (USB, etc.) again.



Disposal of Old Electrical & Electronic Equipment (Applicable in the European Union and other European countries with separate collection systems)

This symbol on the product or on its packaging indicates that this product shall not be treated as household waste. Instead it shall be handed over to the applicable collection point for the recycling of electrical and electronic equipment. By ensuring this product is disposed of correctly, you will help prevent potential negative consequences for the environment and human health, which could otherwise be caused by inappropriate waste handling of this product. The recycling of materials will help to conserve natural resources. For more detailed information about recycling of this product, please contact your local city office, your household waste disposal service or the shop where you purchased the product.

Applicable Accessories: “Memory Stick Duo” and Remote Commander

“Memory Stick”



Notes on use

On the types of cassette you can use in your camcorder

- You can use mini DV cassettes marked with ^{Mini} DV. Mini DV cassettes with Cassette Memory are incompatible (p. 100).

On the types of “Memory Stick” you can use in your camcorder

- There are two sizes of “Memory Stick.” You can use “Memory Stick Duo” marked with **MEMORY STICK DUO** or **MEMORY STICK PRO DUO** (p. 102).

“Memory Stick Duo”
(Size used with this unit)



“Memory Stick”
(You cannot use it in your camcorder.)



- You cannot use any type of memory card except “Memory Stick Duo.”
- “Memory Stick PRO” and “Memory Stick PRO Duo” can be used only with “Memory Stick PRO” compatible equipment.

When using a “Memory Stick Duo” with “Memory Stick” compatible equipment

Be sure to insert the “Memory Stick Duo” into the supplied Memory Stick Duo Adaptor.

Memory Stick Duo Adaptor



On using the camcorder

- Do not hold the camcorder by the following parts.



LCD panel

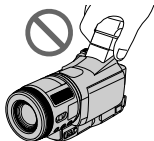

Viewfinder



Flash

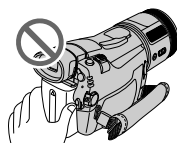

Battery pack

- The camcorder is not dustproofed, dripproofed or waterproofed. See “Maintenance and precautions” (p. 106).
- Before connecting your camcorder to another device with a component video cable, USB or i.LINK cable, be sure to insert the connector plug in the proper direction. If you insert the connector plug forcibly in the wrong direction, the terminal may be damaged, or this may cause a malfunction of your camcorder.

On the menu items, LCD panel, viewfinder, and lens

- A menu item that is grayed out is not available under the current recording or playback conditions.
- The LCD screen and the viewfinder are manufactured using extremely high-precision technology, so over 99.99% of the pixels are operational for effective use. However, there may be some tiny black points and/or bright points (white, red, blue, or green in color) that appear constantly on the LCD screen and the viewfinder. These points are normal results of the manufacturing process and do not affect the recording in any way.

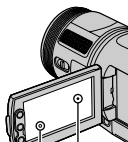

Black point
White, red, blue
or green point

- Exposing the LCD screen, the viewfinder, or the lens to direct sunlight for long

Read this first (Continued)

- periods of time may cause malfunctions.
- Do not aim at the sun. Doing so might cause your camcorder to malfunction. Take pictures of the sun only in low light conditions, such as at dusk.

On recording

- Before starting to record, test the recording function to make sure the picture and sound are recorded without any problems.
- Compensation for the contents of recordings cannot be provided, even if recording or playback is not possible due to a malfunction of the camcorder, storage media, etc.
- TV color systems differ depending on the countries/regions. To view your recordings on a TV, you need a PAL system-based TV.
- Television programs, films, video tapes, and other materials may be copyrighted. Unauthorized recording of such materials may be contrary to the copyright laws.

Playing back HDV tapes on other devices

A tape recorded in the HDV format cannot be played back on a device that is not compatible with the HDV format. The screen appears blue.

Check the contents of tapes by playing them back on this camcorder prior to playing them back on other devices.

On this manual

- The images of the LCD screen and the viewfinder used in this manual for illustration purposes are captured using a digital still camera, and therefore may appear different.
- Design and specifications of recording media and accessories are subject to change without notice.

- The on-screen displays in each local language are used for illustrating the operating procedures. Change the screen language before using your camcorder if necessary (p. 17).

About the Carl Zeiss lens

Your camcorder is equipped with a Carl Zeiss lens, which was developed jointly by Carl Zeiss, in Germany, and Sony Corporation, and produces superior images. It adopts the MTF measurement system for video cameras and offers a quality typical of a Carl Zeiss lens. Also, the lens for your camcorder is T^{*}-coated to suppress unwanted reflections and faithfully reproduce colors.

MTF= Modulation Transfer Function. The number value indicates the amount of light from a subject coming into the lens.

Table of Contents

Note on the icons used in this manual

HDV1080i: Features available for the HDV format only.

DV: Features available for the DV format only.

Read this first	2
-----------------------	---

Enjoying pictures with high definition quality

Trying out the new HDV format!.....	8
-------------------------------------	---

Viewing video recorded in the HDV format!.....	9
--	---

Getting Started

Step 1: Checking supplied items	10
---------------------------------------	----

Step 2: Charging the battery pack	11
---	----

Step 3: Turning the power on and holding your camcorder firmly	14
--	----

Step 4: Adjusting the LCD panel and viewfinder	16
--	----

Step 5: Using the touch panel	17
-------------------------------------	----

Changing the language setting	17
-------------------------------------	----

Checking the screen indicators (Display guide)	17
--	----

Step 6: Setting the date and time	18
---	----

Step 7: Inserting a tape or a “Memory Stick Duo”.....	19
---	----



Recording/Playback

Recording	22
-----------------	----

Playback	23
----------------	----

Functions used for recording/playback, etc.	24
--	----

Recording

To use zoom

To fix the brightness of the picture manually (exposure)

To record in dark places (NightShot)

To make the subject stand out clearer (TELE MACRO)

To use the AUTO LOCK switch

To adjust the focus manually

To enlarge and focus on the image (Expanded focus)

To adjust the exposure for backlit subjects

To record in mirror mode

To use the flash

To use a tripod

Playback

To use PB zoom







To adjust the movie volume

Recording/playback

- To check the remaining battery (Battery Info)
- To turn off the operation confirmation beep
- To initialize the settings
- Other part names and functions

Indicators displayed during recording/playback.....	28
Searching for the starting point	31
Searching for the last scene of the most recent recording (END SEARCH)	31
Reviewing the most recently recorded scenes (Rec review).....	31
Remote Commander	32
Searching quickly for a desired scene (Zero set memory).....	32
Searching for a scene by date of recording (Date search)	33
Connecting to a TV for viewing.....	34

Using the Menu

<i>Using the menu items</i>	38
Menu items.....	40
 CAMERA SET menu	42
Settings to adjust your camcorder to the recording conditions (SPOT METER/WHITE BAL./STEADYSHOT, etc.)	
 MEMORY SET menu.....	47
Settings for the "Memory Stick Duo"(BURST/QUALITY/IMAGE SIZE/ALL ERASE/NEW FOLDER, etc.)	
 PICT.APPLI. menu.....	50
Special effects on pictures or additional functions on recording/playback (SLIDE SHOW/PICT. EFFECT, etc.)	
 EDIT/PLAY menu	53
Settings for editing or playing back in various modes (VAR.SPD PB/END SEARCH, etc.)	
 STANDARD SET menu	54
Settings while recording on a tape or other basic settings (REC MODE/ MULTI-SOUND/LCD/VF SET/DISP OUTPUT, etc.)	
 TIME/LANGU. menu.....	59
(CLOCK SET/WORLD TIME/LANGUAGE)	
Customizing Personal Menu.....	60

Dubbing/Editing

Dubbing to another device such as a VCR, DVD recorder, etc.....	62
Recording pictures from a VCR.....	65
Dubbing pictures from a tape to a "Memory Stick Duo".....	67
Deleting recorded pictures from the "Memory Stick Duo".....	67

Marking images on the “Memory Stick Duo” with specific information (Image protection/Print mark)	68
Printing recorded images (PictBridge compliant printer)	69
Jacks to connect external devices	70

Using a computer

Connecting to a computer	72
Copying still images to a computer	72
Copying movies on a tape to the computer	75
Creating a DVD (Direct Access to “Click to DVD”)	77

Troubleshooting

Troubleshooting	80
Warning indicators and messages	95

Additional Information

Using your camcorder abroad	99
HDV format and recording/playback	100
About the “Memory Stick”	102
About the “InfoLITHIUM” battery pack	104
About i.LINK	105
Maintenance and precautions	106
Specifications	109

Quick Reference

Identifying parts and controls	112
Index	115

Trying out the new HDV format!

Shooting in the HDV format

High image quality

The HDV format has about two times the horizontal resolution of a standard TV resulting in about four times the amount of pixels providing high quality images. Being HDV format compliant, your camcorder is ready to shoot crystal clear, high-definition images.



What is the HDV format?

The HDV format is a new video format for shooting and playing back high definition images on popular DV standard cassette tapes.

- Your camcorder adopts the **HDV1080i specification, which utilizes 1080 effective scanning lines, within the HDV standards**, and records pictures at the image bit rate of about 25 Mbps.



1080 effective scanning lines

- These operating instructions refer to the HDV1080i format as HDV format unless there is a need to specify.



Why shooting in the HDV format?

Moving to digital video, like the rest of the world, will enable you to capture important moments in your life using the HDV format and the high quality images will allow you to relive them.

Your camcorder's down convert function converts pictures in HDV format to pictures in SD (standard definition) quality for viewing on previous wide TV formats and 4:3 aspect ratio TV when high definition TV sets are not available to provide an easy path to HDV format video.

- The down convert function converts HDV format video to DV for playback or editing when your camcorder is connected to a TV or VCR that is not HDV1080i specification compliant. The image quality is then SD (standard definition).

Viewing video recorded in the HDV format!



Viewing on a high definition TV (p. 34)

Pictures recorded in the HDV format can be played back as crisp HD (high definition) picture on a high definition TV.

- For details on HDV1080i specification compliant TVs, see page 101.

Viewing on a 16:9 TV/4:3 TV (p. 34)

Your camcorder can down convert video recorded in the HDV format to SD (standard definition) quality for playback on a conventional TV.

Dubbing to other video equipment (p. 62)

Connecting to an HDV1080i device

An optional i.LINK cable allows you to copy pictures in HD (high definition) quality.

Connecting to HDV1080i non-compliant devices

Use your camcorder to down convert HDV format video to SD (standard definition) quality to enable copying.

Connecting to a computer (p. 72)

Copying "Memory Stick Duo" still images to a computer

See page 72.

Copying movie from tape to a computer

The computer will need to be set up differently depending on whether HDV or DV format video is to be copied. See page 75 for details.

Step 1: Checking supplied items

Make sure that you have following items supplied with your camcorder. The number in the parentheses indicates the number of that item supplied.

"Memory Stick Duo" (1) (p. 20, 102)

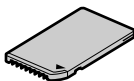

Memory Stick Duo adaptor (1) (p. 103)

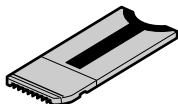

AC Adaptor (1) (p. 11)

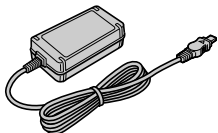

Mains lead (1) (p. 11)

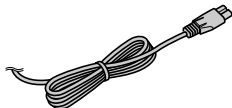

Lens cap (1)

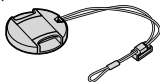

Attached to your camcorder.

Lens hood (1) (p. 114)



Use the lens hood to record under strong light, such as under the sun.

Wireless Remote Commander (1)
(p. 32)



A button-type lithium battery is already installed.

A/V connecting cable (1) (p. 34, 62)



Component video cable (1) (p. 34, 35)

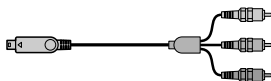

USB cable (1) (p. 72)

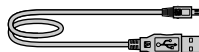

Shoulder Strap (1) (p. 113)

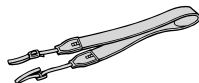

Rechargeable battery pack NP-FM50 (1)
(p. 11, 104)

Operating Guide (This manual) (1)

Step 2: Charging the battery pack

You can charge the “InfoLITHIUM” battery pack (M series) (p. 104) after attaching it to your camcorder.

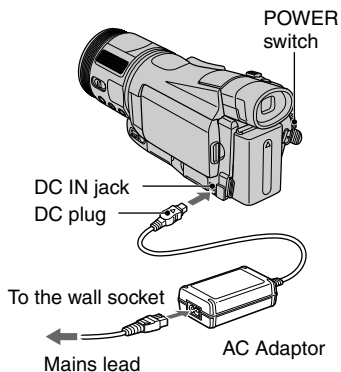

- 1** Attach the battery pack by sliding it in the direction of the arrow until it clicks.

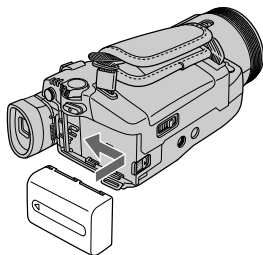

- 2** Slide the **POWER** switch up to **OFF(CHG)**. (The default setting.)

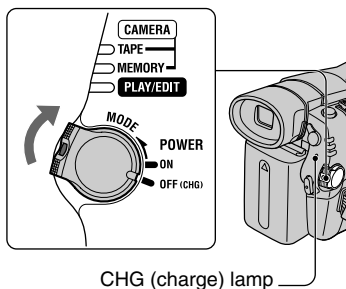

- 3** Connect the AC Adaptor to the DC IN jack of your camcorder. Be sure that the ▲ mark on the DC plug is facing up.

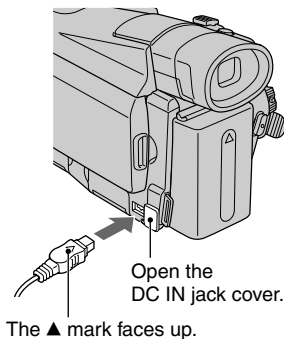

Step 2: Charging the battery pack (Continued)

4 Connect the mains lead to the AC Adaptor and the wall socket.

The CHG (charge) lamp lights up and charging starts.

5 The CHG (charge) lamp turns off when the battery is fully charged. Disconnect the AC Adaptor from the DC IN jack on your camcorder and the DC plug.

Disconnect the AC Adaptor from the DC IN jack holding both the camcorder and the DC plug.

To remove the battery pack

Slide the POWER switch up to OFF (CHG). Slide the BATT (battery release) lever and remove the battery pack.

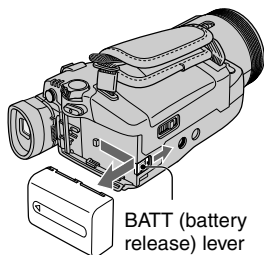

When storing the battery pack

Fully discharge the battery before storing it for an extended period (p. 104).

To use an outside power source

You can operate your camcorder using the power from the wall socket by making the same connections as you do when charging the battery pack. The battery pack will not lose its charge in this case.

Charging time

Approximate time (min.) required when you fully charge a fully discharged battery pack.

Battery pack	Charging time
NP-FM50 (supplied)	150
NP-QM71D	260
NP-QM91D	360

Recording time

Approximate time (min.) available when you use a fully charged battery pack.

Recording in the HDV format

Battery pack	Continuous recording time*	Typical recording time*
NP-FM50 (supplied)	80	40
	90	50
	85	45
NP-QM71D	205	110
	225	120
	215	115
NP-QM91D	315	170
	345	190
	325	175

Recording in the DV format

Battery pack	Continuous recording time*	Typical recording time*
NP-FM50 (supplied)	90	50
	100	55
	95	50
NP-QM71D	225	120
	250	135
	235	130
NP-QM91D	345	190
	380	205
	360	195

* Top: When the LCD backlight turns on.
Middle: When the LCD backlight turns off.
Bottom: Recording time when recording with the viewfinder while the LCD panel is closed.

- Typical recording time shows the time when you repeat recording start/stop, turning the power on/off and zooming.

Playing time

Approximate time (min.) available when you use a fully charged battery pack.

HDV format pictures

Battery pack	LCD panel opened*	LCD panel closed
NP-FM50 (supplied)	105	115
NP-QM71D	255	285
NP-QM91D	390	430

DV format pictures

Battery pack	LCD panel opened*	LCD panel closed
NP-FM50 (supplied)	125	145
NP-QM71D	305	355
NP-QM91D	465	535

* When the LCD backlight turns on.

On the battery pack

- Before changing the battery pack, slide the POWER switch up to OFF (CHG).
- The CHG (charge) lamp flashes during charging, or the battery information (p. 27) will not be correctly displayed under the following conditions.
 - The battery pack is not attached correctly.
 - The battery pack is damaged.
 - The battery pack is fully discharged. (For Battery Info only.)
- The power will not be supplied from the battery as long as the AC Adaptor is connected to the DC IN jack of your camcorder, even when the mains lead is disconnected from the wall socket.
- Use the supplied or optional Sony "InfoLITHIUM" battery pack (M series). You cannot use the battery pack NP-FM30 with your camcorder.

- When attaching an optional video light, it is recommended that you use a NP-QM71D or NP-QM91D battery pack.

On the charging/recording/playback time

- Times measured with the camcorder at 25 °C (77 °F) . (10 to 30 °C (50 °F to 86 °F) is recommended.)
- The recording and playback time will be shorter when you use your camcorder in low temperatures.
- The recording and playback time will be shorter depending on the conditions under which you use your camcorder.

On the AC Adaptor

- Use the nearby wall socket when using the AC Adaptor. Disconnect the AC Adaptor from the wall socket immediately if any malfunction occurs while using your camcorder.
- Do not use the AC Adaptor placed in a narrow space, such as between a wall and furniture.
- Do not short-circuit the DC plug of the AC Adaptor or battery terminal with any metallic objects. This may cause a malfunction.

PRECAUTION

- Even if your camcorder is turned off, AC power (mains) is still supplied to it while connected to the wall socket via the AC Adaptor.

Step 3: Turning the power on and holding your camcorder firmly

To record or play back, slide the POWER switch repeatedly to turn on the respective lamp.

When using it for the first time, the [CLOCK SET] screen appears (p. 18).

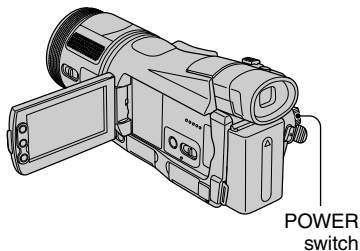

- 1** Remove the lens cap. Pull the lens cap string down and attach it to the grip belt.

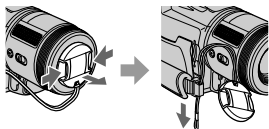

- 2** Slide the POWER switch repeatedly in the direction of the arrow to turn on the respective lamp.

If the POWER switch is set to OFF (CHG), slide it down while pressing the green button.

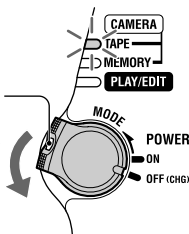

Lamps that light up

CAMERA-TAPE: To record on a tape.

CAMERA-MEMORY: To record on a "Memory Stick Duo."

PLAY/EDIT: To play or edit pictures.

- When you slide the POWER switch from OFF (CHG) to CAMERA-TAPE or CAMERA-MEMORY, the current date and time will be displayed on the LCD screen for about 5 seconds.

- 3** Hold the camcorder correctly.

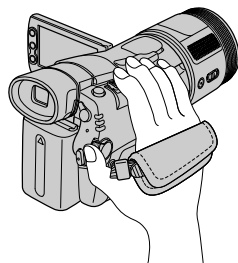

- 4** Ensure a good grip, then fasten the grip belt.

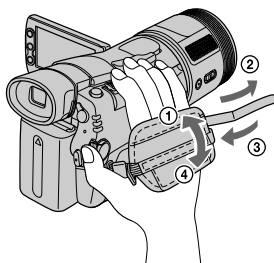

To turn off the power

Slide the POWER switch up to OFF (CHG).

- At the time of purchase, the power will be set to turn off automatically if you leave your camcorder without any operation attempted for approximately 5 minutes, to save battery power. ([A.SHUT OFF], p. 59).

Step 4: Adjusting the LCD panel and viewfinder

The LCD panel

Open the LCD panel 90 degrees to the camcorder (①), then rotate it to the best angle to record or play (②).

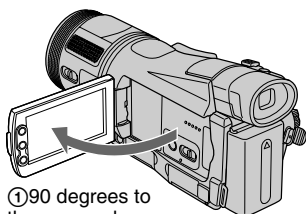

① 90 degrees to the camcorder

② 180 degrees (max.)

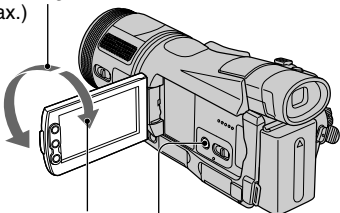



② 90 degrees (max.)

DISPLAY/BATT INFO

- Do not press the buttons beside the LCD frame accidentally when you open or adjust the LCD panel.
- If you rotate the LCD panel 180 degrees to the lens side from the status ①, you can close the LCD panel with the LCD screen facing out. This is convenient during playback operations.
- When closing the LCD panel, rotate the LCD panel as illustrated in ①, and then close the LCD panel facing inward.

To turn off the LCD backlight to make the battery last longer

Press and hold DISPLAY/BATT INFO for a few seconds until  appears.

This setting is practical when you use your camcorder in bright conditions or where you want to save battery power. The recorded picture will not be affected by the setting. To turn on the LCD backlight, press and hold DISPLAY/BATT INFO for a few seconds until  appears.

- See [LCD BRIGHT] (p. 56) to adjust the brightness of the LCD screen.

The viewfinder

You can view images using the viewfinder with the LCD panel closed. The battery will last longer than when using the LCD panel.

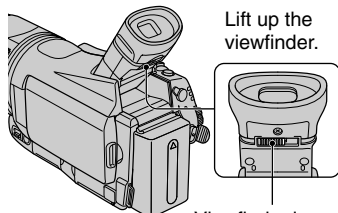

Lift up the viewfinder.

Viewfinder lens adjustment lever
Move it until the picture is clear.

- You can adjust the brightness of the viewfinder backlight by selecting [LCD/VF SET] - [VF B.LIGHT] (p. 56).

Step 5: Using the touch panel

You can play back recorded pictures (p. 23), or change the settings (p. 38) using the touch panel.

Place your hand on the rear side of the LCD panel to support it. Then, touch the buttons displayed on the screen.

Touch the button on the LCD screen.

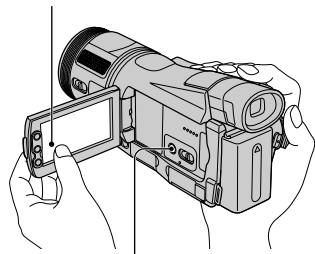

DISPLAY/BATT INFO

- Perform the same actions as explained above when you press the buttons on the LCD frame.
- Be careful not to press buttons on the LCD frame accidentally while using the touch panel.

To hide the screen indicators

Press DISPLAY/BATT INFO to toggle the screen indicators (such as time code, etc.) on or off.

Changing the language setting

You can change the on-screen displays to show messages in a specified language. Select the screen language in [LANGUAGE] on the (TIME/LANGU.) menu (p. 59).

Checking the screen indicators (Display guide)

You can easily check the meaning of each indicator that appears on the LCD screen.

1 Touch [P-MENU].

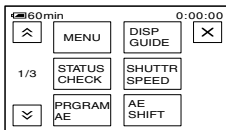

2 Touch [DISP GUIDE].

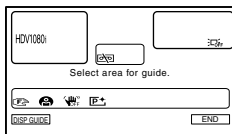

The indicators vary depending on the settings.

3 Touch the area including the indicator that you want to check.

The meanings of the indicators in the area are listed on the screen. If you cannot find the indicator you want to check, touch / to toggle. When you touch , the screen returns to the area selecting display.

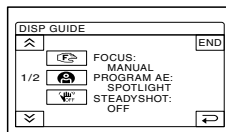

To finish the operation

Touch [END].

Step 6: Setting the date and time

Set the date and time when using this camcorder for the first time. If you do not set the date and time, the [CLOCK SET] screen appears every time you turn on your camcorder or change the POWER switch position.

- If you do not use your camcorder for **about 3 months**, the built-in rechargeable battery gets discharged and the date and time settings may be cleared from the memory. In that case, charge the rechargeable battery and then set the date and time again (p. 108).

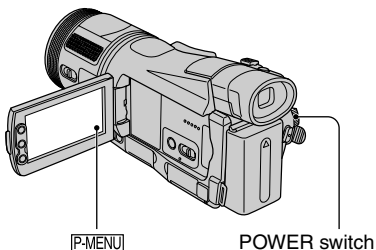

Skip to step 4 when you set the clock for the first time.

- 1 Touch **P-MENU** → **[MENU]**.

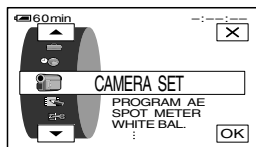

- 2 Select **(TIME/LANGU.)** menu with **▲/▼**, then touch **OK**.

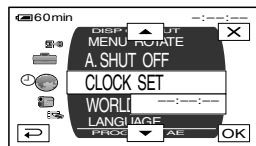

- 3 Select **[CLOCK SET]** with **▲/▼**, then touch **OK**.

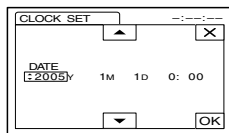

- 4 Set **[Y]** (year) with **▲/▼**, then touch **OK**.

You can set any year up to the year 2079.

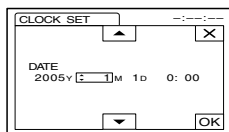

- 5 Set **[M]** (month), **[D]** (day), hour and minute, then touch **OK**.

The clock starts.

Step 7: Inserting a tape or a “Memory Stick Duo”

Cassette tape

You can use mini DV ^{Mini DV} cassettes only (p. 100).

- The recordable time varies depending on [ REC MODE] (p. 54). DV

- 1** Slide and hold the OPEN/EJECT  lever in the direction of the arrow and open the lid.

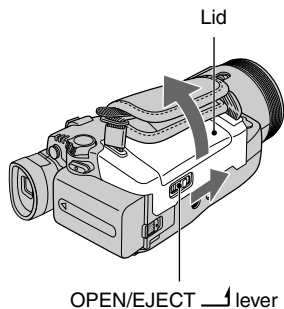

The cassette compartment automatically comes out and opens up.

- 2** Insert a cassette with its window facing outwards, then press .

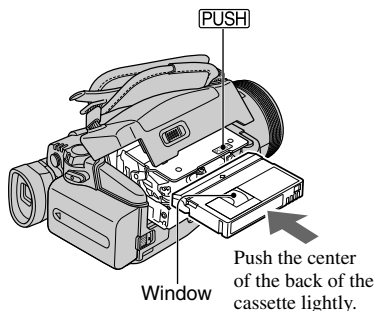

The cassette compartment automatically slides back in. Do not force the cassette into the compartment. This may cause a malfunction.

- 3** Close the lid.

To eject the cassette

Open the lid following the same procedure as described in step **1** and remove the cassette.

Step 7: Inserting a tape or a “Memory Stick Duo” (Continued)

“Memory Stick Duo”

You can use only a “Memory Stick Duo” marked with **MEMORY STICK DUO** or **MEMORY STICK PRO DUO** (p. 102).

- The number of recordable pictures varies depending on the image quality or the image size. For details, see page 47.

Insert the “Memory Stick Duo” into the “Memory Stick Duo” slot in the right direction until it clicks.

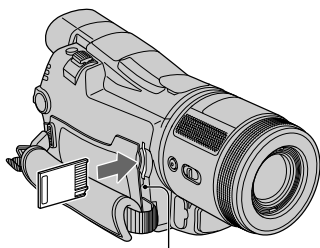

Access lamp

- If you force the “Memory Stick Duo” into the slot in the wrong direction, the “Memory Stick Duo,” the “Memory Stick Duo” slot, or image data may be damaged.

To eject a “Memory Stick Duo”

Lightly push the “Memory Stick Duo” in once.

- When the access lamp is lit or flashing, your camcorder is reading/writing data. Do not shake or knock your camcorder, turn the power off, eject the “Memory Stick Duo,” or remove the battery pack. Otherwise, image data may be damaged.
- Make sure that the “Memory Stick Duo” does not pop up and drop off when inserting and removing it from your camcorder.

Recording

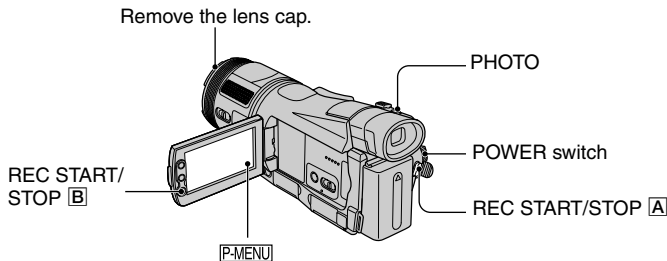

1 Slide the **POWER** switch in the direction of the arrow repeatedly to turn on the respective lamp to select a recording medium.

[CAMERA] **Movies on tape:** The CAMERA-TAPE lamp lights up.

[MEMORY] **Still images on “Memory Stick Duo”:** The CAMERA-MEMORY lamp lights up.*

* The image size ratio is set by default to 4:3.

If the **POWER** switch is set to **OFF (CHG)**, slide it down while pressing the green button.

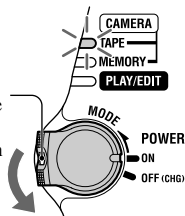

2 Start recording.

Movies [CAMERA]

Press **REC START/STOP [A]** (or **[B]**).

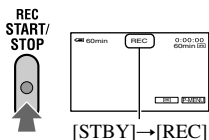

To stop the movie recording, press **REC START/STOP** again.

- The pictures are recorded in the **HDV** format in the default setting (p. 54).

Still images [MEMORY]

Press and hold **PHOTO** lightly to adjust the focus (**A**), then press it fully (**B**).

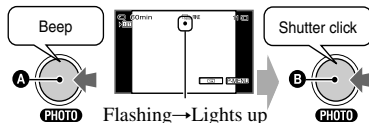

A shutter sound is heard. When **||||** disappears, the image has been recorded.

- You can record a still image on a “Memory Stick Duo,” while recording movies on a tape or in standby mode by pressing **PHOTO** deeply. Still images will be fixed to image size [1440 × 810] in the **HDV** format, [1080 × 810] (4:3) or [1440 × 810] (16:9) in the **DV** format.

To check the latest recording on a “Memory Stick Duo”

Touch **[G]**. To delete the picture, touch **[DELETE]** → **[YES]**. Touch **[RETURN]** to return to the standby mode.

- See page 47 for the image size.

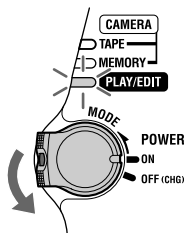

Playback

- 1 Slide the POWER switch in the direction of the arrow repeatedly to turn on the PLAY/EDIT lamp.



- 2 Start playing back.

Movies

Touch , then touch  to start playback.

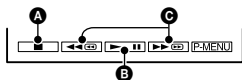

- A Stop
- B Play/Pause toggles as you touch it.*
- C Rewind/Fast forward

* Playback automatically stops if pause is engaged for more than 3 minutes.

Still images

Touch . The most recently recorded image is displayed.

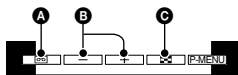





- A Tape playback
- B Previous/Next
- C Index screen display

•  is not displayed when a “Memory Stick Duo” is not inserted or no image files exist in it.

To adjust the volume

Move the EXPOSURE/VOL lever up and down to adjust the volume (p. 27).



To search for a scene during playback

Touch and hold / during playback (Picture Search), or / while fast forwarding or rewinding the tape (Skip Scan).

• You can play back in various modes ( VAR. SPD PB], p. 53).

To display pictures on a “Memory Stick Duo” on the Index screen

Touch . Touch the picture you want to display in the single display mode. To view pictures in other folders, touch

 → [SET] → [PB FOLDER], select a folder with /, then touch  (p. 49).

Index display screen

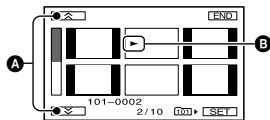

- A Previous/Next 6 pictures
- B The picture displayed before switching to the index screen.

Functions used for recording/playback, etc.

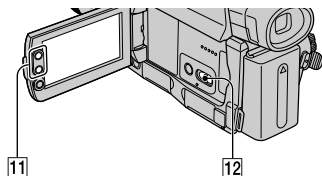
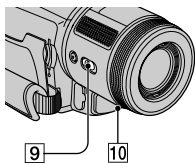
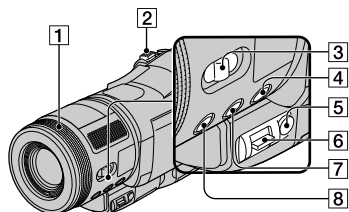

- The minimum distance required between your camcorder and the subject to get a sharp focus is about 1 cm (about 1/2 in.) for wide angle and about 80 cm (about 2 5/8 ft.) for telephoto.
- You can set [DIGITAL ZOOM] if you want to zoom to a level greater than 10 x. (p. 46)
- Zooming may not be able to catch up the rotating speed of the ring if it is rotated too fast.

To fix the brightness of the picture manually (exposure) 5 6

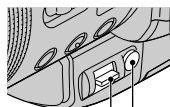

EXPOSURE/VOL lever
EXPOSURE button

You can fix the brightness of a picture manually. When recording indoors on a clear day, for instance, you can avoid backlight shadows on people next to the window by fixing the exposure to that of the wall side of the room. Set the AUTO LOCK switch to OFF beforehand (p. 25).

- ① Press EXPOSURE 5.
- ② Adjust the brightness by moving the EXPOSURE/VOL lever 6 up or down.

↔ appears. Move the lever up to make the image brighter and move it down to make the image darker.

- To return to the automatic mode, press EXPOSURE again.
- The setting you have made will return to the default setting if you set the POWER switch to OFF (CHG) for more than 12 hours.

Recording

To use zoom 1 2 3 11

Move the power zoom lever 2 slightly for a slower zoom. Move it further for a faster zoom.

Wider range of view: (Wide angle)

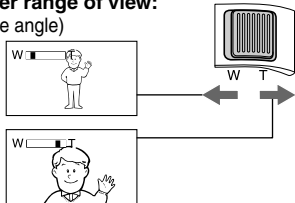

Close view: (Telephoto)

- When using the zoom ring 1, set the FOCUS/ZOOM switch 3 to ZOOM and rotate it at the desired speed (Ⓞ appears).
- You cannot change the zoom speed with the zoom buttons 11 on the LCD frame.

To record in dark places (NightShot) 9

Set the NIGHTSHOT switch 9 to ON. (Ⓞ and ["NIGHTSHOT"] appear.)

- To record an image brighter, use Super NightShot function (p. 45). To record an image more faithful to the original colors, use Color Slow Shutter function (p. 45).

- The NightShot and Super NightShot function use infrared light. Therefore, do not cover the infrared port [10] with your fingers or other objects and remove the conversions lens (optional).
- Adjust the focus manually (p. 25) when it is hard to focus automatically.
- Do not use these functions in bright places. This may cause a malfunction.

To make the subject stand out clearer (TELE MACRO) [8]

Press TELE MACRO [8]. **T** appears and the zoom moves to the top of the T (Telephoto) side automatically and allows for recording subjects at a close distance, down to about 48 cm (19 in.). This is useful to shoot small subjects, such as flowers or insects.

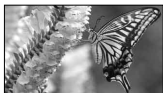

To cancel, press TELE MACRO again, or zoom to wide-angle (W side).

- When recording a distant subject, it may be difficult to focus on and take time for focusing.
- Adjust the focus manually (p. 25) when it is hard to focus automatically.

To use the AUTO LOCK switch [12]

You can set up the following settings manually with the AUTO LOCK switch [12] to OFF. The settings return to the automatic mode with the switch ON.

- [SPOT METER]
- exposure
- [PROGRAM AE]
- [WHITE BAL.]
- [SHUTTR SPEED]
- Settings adjusted while the AUTO LOCK switch is OFF are retained when it is set to ON, and will be restored when set to OFF again.
- Set the AUTO LOCK switch to ON when using the external flash (optional).

To adjust the focus manually.... [1][3]

- ① Set the FOCUS/ZOOM switch [3] to MANUAL (M appears).
- ② Rotate the focus ring [1] to adjust the focus.

To adjust the focus automatically, set the FOCUS/ZOOM switch to AUTO.

- You can also use this function when changing the subject to be focused intentionally.
- M changes to ▲ when the focus cannot be adjusted any farther. M changes to ▼ when the focus cannot be adjusted any closer.
- It is easier to focus on the subject by moving the power zoom lever [2] towards T (telephoto) to adjust the focus, then towards W (wide angle) to adjust the zoom for recording. When you want to record a subject at close range, move the power zoom lever to W (wide angle), then adjust the focus.

To enlarge and focus on the image (Expanded focus) [3][7]

- ① Set the FOCUS/ZOOM switch [3] to MANUAL in standby mode.
- ② Press EXPANDED FOCUS [7] to double the size of the picture. When you finish focusing, the screen automatically returns to the normal picture display.

To cancel the expanded focus, press EXPANDED FOCUS again.

- Press [SET] on the LCD screen of your camcorder during expanded focus for setting up the peaking function. Press [ON] to enhance the outline of the subject for easier focusing.
- The peaking is not recorded on a tape.

To adjust the exposure for backlit subjects [4]

To adjust the exposure for backlit subjects, press BACK LIGHT [4] to display B. To cancel the back light function, press BACK LIGHT again.

- The setting you have made will return to the default setting if you set the POWER switch to OFF (CHG) for more than 12 hours.

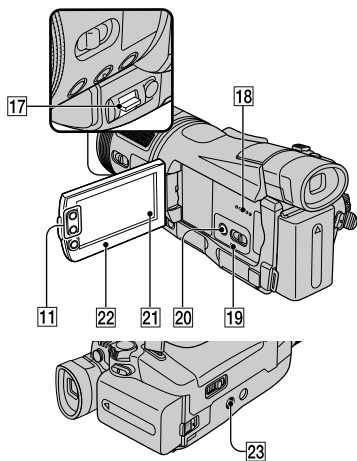
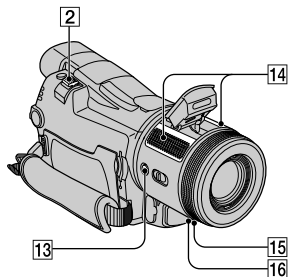

To record in mirror mode 22

Open the LCD panel 22 90 degrees to the camcorder (1), then rotate it 180 degrees to the lens side (2).

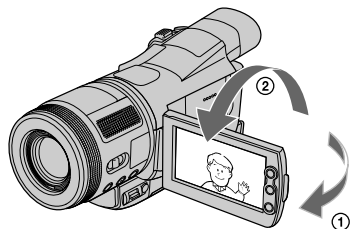

- A mirror-image of the subject appears on the LCD screen, but the picture will be normal when recorded.

To use the flash 13

Press (flash) repeatedly to select a setting.

No indicator displayed: Automatically flashes when there is insufficient ambient light.



(Forced flash): Always uses the flash regardless of the surrounding brightness.



(No flash): Records without flash.

- The recommended distance to the subject when using the built-in flash is 0.5 to 2.5 m (1 5/8 to 8 ft.).
- Remove any dust from the surface of the flash lamp before using it. Flash effect may be impaired if heat discoloration or dust obscures the lamp.
- The flash charge lamp flickers when charging the flash, and remains lit when the battery charge is complete.
- You can only use the flash in the CAMERA-MEMORY mode.
- If you use the flash in bright places such as when shooting a backlit subject, the flash may not be effective.
- You can change the brightness of the flash by setting [FLASH LEVEL], or you can prevent the red-eye by setting [REDEYE REDUC], in [FLASH SET] (p. 44).

To use a tripod 23

Attach the tripod (optional: the length of the screw must be less than 5.5 mm (7/32 in.) to the tripod receptacle 23 using a tripod screw.

Playback

To use PB zoom 2 11

You can magnify still pictures on the “Memory Stick Duo” from about 1.5 to 5 times the original size.

Magnification can be adjusted with the power zoom lever 2 or the zoom buttons 11 on the LCD frame.

- 1 Play back the picture you want to magnify.

- ② Magnify the picture with T (Telephoto).
- ③ Touch the screen at the point you want to display in the center of the displayed frame.
- ④ Adjust the magnification with W (Wide angle)/T (Telephoto).

To cancel, touch [END].

- You cannot change the zoom speed with the zoom buttons on the LCD frame.

To adjust the movie volume 17

Move the EXPOSURE/VOL lever 17 up or down to adjust the volume. Move the lever up to increase the volume and move it down to decrease the volume.

- You can also adjust the volume by touching  (STANDARD SET) → [VOLUME] (p. 55).

Recording/playback

To check the remaining battery (Battery Info) 20

Set the POWER switch up to OFF (CHG), then press DISPLAY/BATT INFO 20. The approximate recordable time in the selected format and battery information appear for about 7 seconds. By pressing DISPLAY/BATT INFO, you can view the battery information for up to 20 seconds while it is displayed.

Remaining battery (approx.)

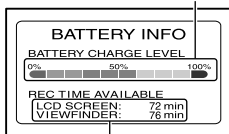

Recording capacity (approx.)

To turn off the operation confirmation beep 21

See [BEEP] (p. 58) to set the operation beep.

To initialize the settings 19

Press RESET 19 to initialize all the settings, including the setting of the date and time.

(Menu items customized on Personal Menu are not initialized.)

Other part names and functions

- 14 Internal stereo microphone
When an external microphone is connected, the audio input from the external microphone takes precedence over others.
- 15 REC lamp
The REC lamp lights up in red during recording (p. 58).
- 16 Remote sensor
Point the Remote Commander (p. 32) towards the remote sensor to operate your camcorder.
- 18 Speaker
Sounds come out from the speaker.
 - For how to adjust the volume, see page 23.

Indicators displayed during recording/playback

Recording movies

In the CAMERA-TAPE mode

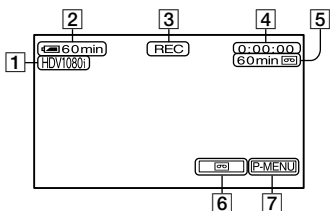

- 1 Recording format (HDV1080i or DV) (54)
Recording mode (SP or LP) is also displayed in the DV format.
- 2 Remaining battery (approx.)
- 3 Recording status ([STBY] (standby) or [REC] (recording))
- 4 Time code (hour: minute: second: frame)/Tape counter (hour: minute: second)
- 5 Recording capacity of the tape (approx.) (58)
- 6 END SEARCH/Rec review display switch button (31)
- 7 Personal Menu button (38)

Recording still images

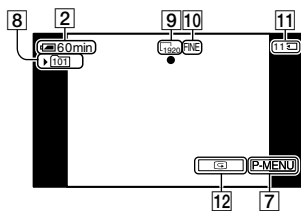

- 8 Recording folder (49)
- 9 Image size (47)
- 10 Quality ([FINE] or [STD]) (47)
- 11 “Memory Stick Duo” indicator and the number of images that can be recorded (approx.)
- 12 Review button (22)

Data code during playback

The date/time during recording and the camera setting data will be recorded automatically. They do not appear on the screen during recording, but you can check them as [DATA CODE] during playback (p. 58).

() is a reference page.

The indicators during recording will not be recorded.

Viewing movies

On a tape

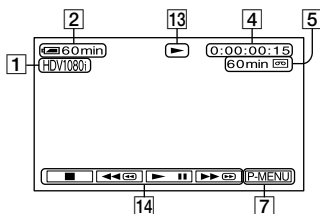

13 Tape transport indicator

14 Video operation buttons (23)

- When playing back a tape recorded in the HDV and DV formats, and the signal switches between HDV and DV formats, the picture and sound disappear temporarily.
- You cannot play back the tape recorded in the HDV format on video cameras of the DV format or mini-DV players.

Viewing still images

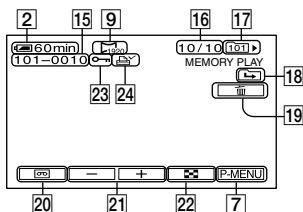

15 Data file name

16 Picture number/Total number of recorded pictures in the current playback folder

17 Playback folder (49)

18 Previous/Next folder icon

The following indicators appear when the first or last picture of the current folder is displayed and when there are multiple folders on the same "Memory Stick Duo."

: Touch to move to the previous folder.

: Touch to move to the next folder.

: Touch / to move to either the previous or the next folder.

19 Image delete button (67)

20 Tape playback select button (23)

21 Previous/Next image button (23)

22 Index screen display button (23)

23 Image protection mark (68)

24 Print mark (68)

Indicators displayed during recording/playback (Continued)

Indicators when you made changes

You can check the [DISP GUIDE] (p. 17) to check the function of each indicator that appears on the LCD screen.

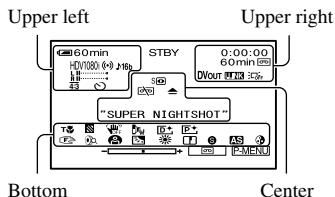

Upper left

Indicator	Meaning
HDV1080i DV	Recording format (54)
(↔)	EXT SUR MIC (56)
J16b	AUDIO MODE (55)*
BRK	Continuous photo recording (47)
SP LP	Recording mode (54)*
⏸	Self-timer recording (46)
4:3	WIDE SELECT (55)*
📷	Interval photo recording (52)
⚡ 🔆 🔆 🔆 🔆 🔆 🔆	Flash light (44)
	Recording level meter (56)

Upper right

Indicator	Meaning
HDVIN DVIN	HDV input/DV input (65)
HDVout DVout	HDV output/DV output (34, 64)
i.LINK	i.LINK connection (34, 64, 65)
+0+	Zero set memory (32)
all [] ↺	Slide show (51)

📺 Off	LCD backlight off (16)
-------	------------------------

Center

Indicator	Meaning
📷	NightShot (24)
S📷	Super NightShot (45)
📷	Color Slow Shutter (45)
🔗	PictBridge connecting (69)
🚨	Warning (95)

Bottom

Indicator	Meaning
AS	AE SHIFT (44)
WS	WB SHIFT (44)
🖼️	Picture effect (51)
🔍	Digital effect (50)
👁️	Manual focus (25)
👤	PROGRAM AE (42)
🔍	Sharpness (43)
📺	Backlight (25)
☀️	White balance (43)
📷	SteadyShot off (46)
📷	Zebra (45)
👤	TELE MACRO (25)
🌈	CAMERA COLOR (44)
🔍	Zoom ring (24)
⌚	Shutter speed (43)
📷	CONV. LENS (46)

* The settings can be made only for the pictures in the DV format.

Searching for the starting point

Make sure that the CAMERA-TAPE lamp lights up (p. 22).

Searching for the last scene of the most recent recording (END SEARCH)

END SEARCH will not work once you eject the cassette after you have recorded on the tape.

Touch  → .

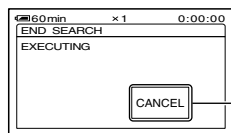

Touch here to cancel the operation.

The last scene of the most recent recording is played back for about 5 seconds, and the camcorder enters the standby mode at the point where the last recording has finished.

- END SEARCH will not work correctly when there is a blank section between recorded sections on the tape.
- You can also select [END SEARCH] from the menu. When the PLAY/EDIT lamp lights up, select the [END SEARCH] shortcut in Personal Menu (p. 38).

Reviewing the most recently recorded scenes (Rec review)

You can view about 2 seconds of the scene recorded just before you stopped the tape.

Touch  → .

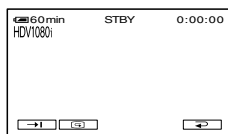

The last 2 seconds (approx.) of the most recently recorded scene are played back. Then, your camcorder is set to the standby.

Remote Commander

Remove the insulation sheet before using the Remote Commander.

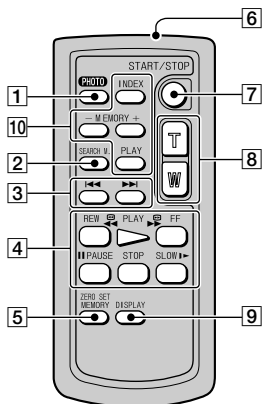
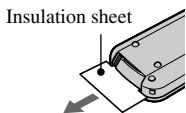

1 PHOTO (p. 22)

The on-screen image when you press this button will be recorded as a still image.

2 SEARCH M. (p. 33)



4 Video control buttons (Rewind, Playback, Fast-forward, Pause, Stop, Slow) (p. 23)

5 ZERO SET MEMORY

6 Transmitter

7 REC START/STOP (p. 22)

8 Power zoom (p. 24)

9 DISPLAY (p. 17)

10 Memory control buttons (Index, -/+, Memory playback) (p. 23)

- Aim the Remote Commander towards the remote sensor to operate your camcorder (p. 27).

- To change the battery, see page 109.

Searching quickly for a desired scene (Zero set memory)

1 During playback, press ZERO SET MEMORY **5** at a point you want to locate later on.

The tape counter is reset to “0:00:00” and +0+ appears on the screen.

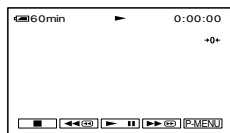

If the tape counter is not displayed, press DISPLAY **9**.

2 Press STOP **4** when you want to stop playback.

3 Press ◀REW **4**.

The tape stops automatically when the tape counter reaches “0:00:00.”

4 Press PLAY **4**.

Playback starts from the point designated “0:00:00” on the tape counter.

- There may be a discrepancy of several seconds between the time code and the tape counter.
- Zero set memory will not function correctly if there is a blank section between recorded sections on the tape.

To cancel the operation

Press ZERO SET MEMORY **5** again.

Searching for a scene by date of recording (Date search)

You can locate the point where the recording date changes.

1 Slide the **POWER** switch down to turn on the **PLAY/EDIT** lamp.

2 Press **SEARCH M.** [2].

3 Press **◀◀(previous)/▶▶(next)** [3] to select a recording date.

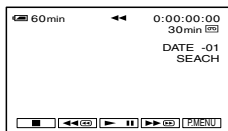

To cancel the operation

Press **STOP** [4].

- The Date search will not function correctly when there is a blank section between recorded sections on the tape.

Connecting to a TV for viewing

Connection methods and image quality will differ depending on what TV to be connected and connectors used.

Use the supplied AC Adaptor as the power source (p. 11).

See page 37 for “Notes on Connection” and refer also to the instruction manuals supplied with the devices to be connected.

Select connection method depending on what TV to be connected with and connectors the TV is equipped with.

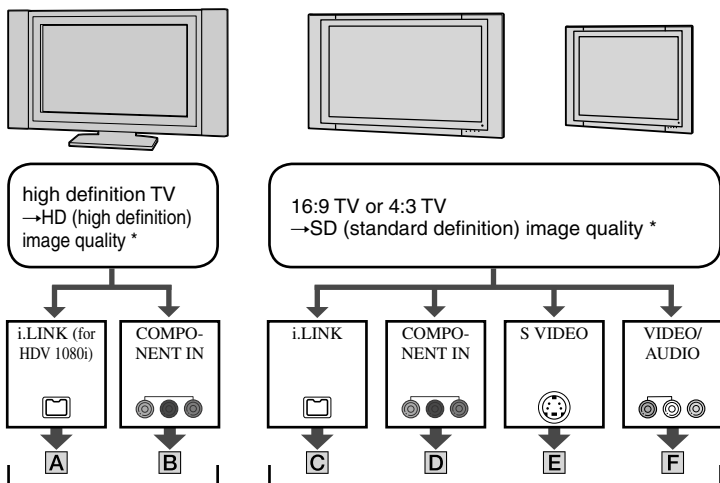

See page 35 for connecting methods.
See page 37 for notes on connection.

See page 35 for connecting method **C** and 36 for connecting method **D**, **E** and **F**.
See page 37 for notes on connection.

- Set the menu on your camcorder before connection. The TV may not recognize the video signal properly when changing [VCR HDV/DV] and [i.LINK CONV] settings after connecting with an i.LINK cable (optional).

* Pictures recorded in the DV format is played back as SD (standard definition) images regardless of connection.

Jacks on your camcorder

Open the jack cover and connect the cable.

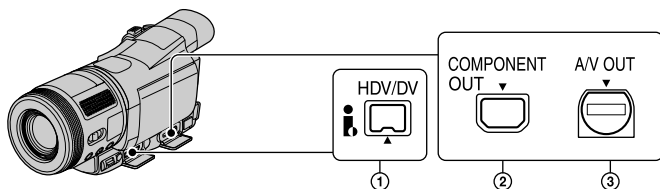

 : Signal flow

Type	Camcorder	Cable	TV	Menu Setting
------	-----------	-------	----	--------------

A

① i.LINK cable (optional)

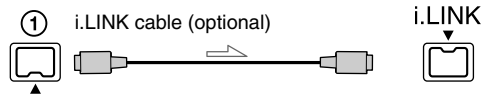

i.LINK

 (STANDARD SET)

[VCR HDV/DV] → [AUTO] (p. 54)

[i.LINK CONV] → [OFF] (p.57)

B

Component video cable (supplied)

②

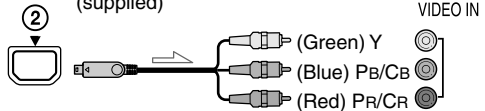

(Green) Y

(Blue) PB/CB

(Red) PR/CR

COMPONENT VIDEO IN

A/V connecting cable (supplied)

③

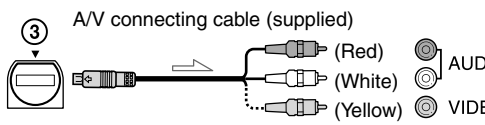

(Red)

(White)

(Yellow)

AUDIO

VIDEO

Do not connect the video plug (yellow).

 (STANDARD SET)

[VCR HDV/DV] → [AUTO] (p. 54)

[COMPONENT] → [1080i/576i] (p. 57)

C

① i.LINK cable (optional)

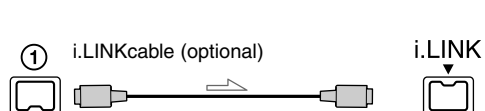

i.LINK

 (STANDARD SET)

[VCR HDV/DV] → [AUTO] (p. 54)

[i.LINK CONV] → [ON HDV→DV] (p. 57)

[TV TYPE] → [16:9]/[4:3]* (p. 57)

* Change the settings depending on the TV connected.

Connecting to a TV for viewing (Continued)

 : Signal flow

Type	Camcorder	Cable	TV	Menu Setting
------	-----------	-------	----	--------------

D

Component video cable (supplied)

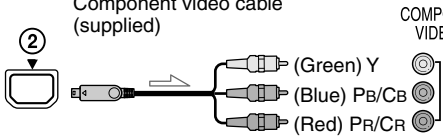

COMPONENT VIDEO IN

(Green) Y
(Blue) PB/Cb
(Red) PR/CR

A/V connecting cable (supplied)

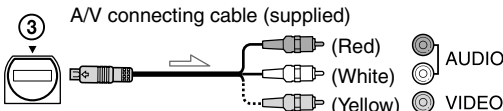

(Red)
(White)
(Yellow)

AUDIO
VIDEO

Do not connect the video plug (yellow).

 (STANDARD SET)

[VCR HDV/DV] →
[AUTO] (p. 54)
[COMPONENT] →
[576i] (p. 57)
[TV TYPE] →
[16:9]/[4:3]* (p. 57)

E

A/V connecting cable with S VIDEO (optional)

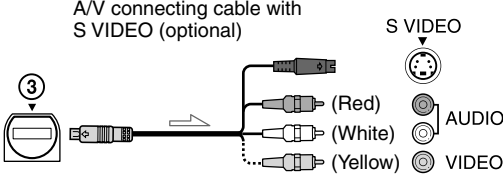

S VIDEO

(Red)
(White)
(Yellow)

AUDIO
VIDEO

Do not connect the video plug (yellow).

 (STANDARD SET)

[VCR HDV/DV] →
[AUTO] (p. 54)
[TV TYPE] →
[16:9]/[4:3]* (p. 57)

F

A/V connecting cable (supplied)

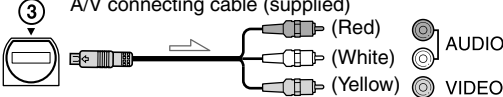

(Red)
(White)
(Yellow)

AUDIO
VIDEO

 (STANDARD SET)

[VCR HDV/DV] →
[AUTO] (p. 54)
[TV TYPE] →
[16:9]/[4:3]* (p. 57)

* Change the settings depending on the TV connected.

Notes on Connection

Type	Notes
A	<ul style="list-style-type: none"> Requires HDV1080i specification connectors. Consult your TV manufacturer for details. See page 101 for a list of supported device. The TV needs to be set so that it recognizes that the camcorder is connected. Refer to the instruction manuals supplied with your TV.
B	<ul style="list-style-type: none"> When connecting only with the component video cable (supplied), audio signals are not output. To output audio signals, connect the white and red plugs of the A/V connecting cable (supplied) to the audio input jack of your TV. Pictures in the DV format are not output from the COMPONENT OUT jack, if copyright protection signals are recorded in the pictures.
C	<ul style="list-style-type: none"> The TV needs to be set so that it recognizes that the camcorder is connected. Refer to the instruction manuals supplied with your TV.
D	<ul style="list-style-type: none"> When connecting only with the component video cable (supplied), audio signals are not output. To output audio signals, connect the white and red plugs of the A/V connecting cable (supplied) to the audio input jack of your TV. Pictures in the DV format are not output from the COMPONENT OUT jack, if copyright protection signals are recorded in the pictures.
E	<ul style="list-style-type: none"> When connecting only S VIDEO plug, audio signals are not output. To output audio signals, connect the white and red plugs of the A/V connecting cable with an S VIDEO cable (optional) to the audio input jack of your TV. This connection produces high resolution pictures compared with A/V connecting cable (Type F).
F	_____

- If you connect your camcorder to your TV using more than one type of cable to output images from a jack other than the i.LINK jack, the order of priority of the output signals is as follows:
component video → S video → audio/video
- See page 105 for the details of i.LINK.

To set the aspect ratio according to the connected TV (16:9/4:3)

Change the [TV TYPE] setting depending on your TV (p. 57).

- When you play back a tape recorded in the DV format on a 4:3 TV not compatible with the 16:9 signal, set [WIDE SELECT] to [4:3] on your camcorder when recording a picture (p. 55).

When your TV is connected to a VCR

Select the connecting method on page 62 depending on the input jack of the VCR. Connect your camcorder to the LINE IN input on the VCR using the A/V connecting cable (supplied). Set the input selector on the VCR to LINE (VIDEO 1, VIDEO 2, etc.).

When your TV is monaural (When your TV has only one audio input jack)

Connect the yellow plug of the A/V connecting cable (supplied) to the video input jack and connect the white or the red plug to the audio input jack of your TV or VCR. When you want to play the sound in monaural mode, use a connecting cable (optional) for that purpose.

If your TV/VCR has a 21-pin adaptor (EUROCONNECTOR)

Use a 21-pin adaptor (optional) to view playback picture.

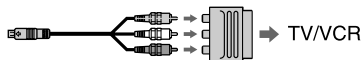

Using the menu items

Follow the instructions below to use each of the menu items listed after this page.

1 Slide the POWER switch down to turn on the respective lamp.

CAMERA-TAPE lamp:  settings on a tape

CAMERA- MEMORY lamp:  settings on a “Memory Stick Duo”

PLAY/EDIT lamp: settings for viewing/editing

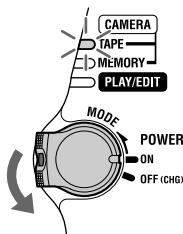

2 Touch the LCD screen to select the menu item.

Unavailable items will be grayed out.

■ To use the short-cuts of Personal Menu



On Personal Menu, short-cuts for frequently used menu items are added.

- You can customize Personal Menu as you like (p. 60).

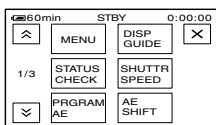
① Touch .



② Touch the desired item.

If the desired item is not displayed on the screen, touch / until the item is displayed.

③ Select the desired setting, then touch .

■ To use menu items

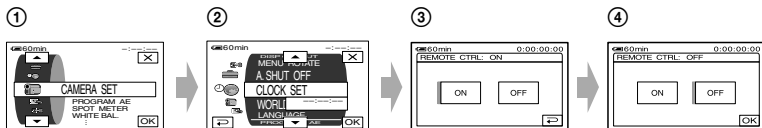

You can customize menu items that are not added to Personal Menu.



① Touch →[MENU].

The menu index screen appears.

② Select the desired menu.

Touch / to select the item, then touch . (The process in step ③ is the same as that in step ②.)

③ Select the desired item.

- You can also touch the item directly to select it.

④ Customize the item.

After finishing the settings, touch → (close) to hide the menu screen.

If you decide not to change the setting, touch to return to the previous screen.

Menu items

- The menu items available for the operation (●) differ depending on where the lit lamp for the POWER switch is positioned.



Position of lamp:

TAP	MEM	PLAY/EDIT
-----	-----	-----------

CAMERA SET menu (p. 42)

	TAP	MEM	PLAY/EDIT
PROGRAM AE	●	●	—
SPOT METER	●	●	—
WHITE BAL.	●	●	—
SHARPNESS	●	●	—
SHUTTR SPEED	●	—	—
AUTO SHUTTER	●	—	—
AE SHIFT	●	●	—
CAMERA COLOR	●	●	—
WB SHIFT	●	●	—
SPOT FOCUS	●	●	—
FLASH SET	—	●	—
SUPER NS	●	—	—
NS LIGHT	●	●	—
COLOR SLOW S	●	—	—
ZEBRA	●	●	—
HISTOGRAM	●	●	—
SELF-TIMER	●	●	—
DIGITAL ZOOM	●	—	—
STEADYSHOT	●	—	—
CONV. LENS	●	—	—

MEMORY SET menu (p. 47)



	TAP	MEM	PLAY/EDIT
STILL SET	—	●	●
 ALL ERASE	—	—	●
 FORMAT	—	●	●
FILE NO.	—	●	●
NEW FOLDER	—	●	●
REC FOLDER	—	●	●
PB FOLDER	—	—	●

PICT.APPLI. menu (p. 50)



	TAP	MEM	PLAY/EDIT
FADER	●	—	—
D. EFFECT	●	—	●
PICT. EFFECT	●	—	●
SLIDE SHOW	—	—	●
INT.REC-STL	—	●	—
SHOT TRANS	●	—	—
DEMO MODE	●	—	—
PictBridge PRINT	—	—	●

Position of lamp: TAPE MEMORY PLAY/EDIT

 **EDIT/PLAY menu** (p. 53)

 VAR. SPD PB	–	–	●
 REC CTRL	–	–	●
BURN DVD	–	–	●
END SEARCH	●	–	●

 **STANDARD SET menu** (p. 54)

VCR HDV/DV	–	–	●
REC FORMAT	●	–	–
DV SET 	●	–	●
VOLUME	●	●	●
MULTI-SOUND	–	–	●
MIC LEVEL	●	–	–
EXT SUR MIC	●	–	–
LCD/VF SET	●	●	●
COMPONENT	●	●	●
i.LINK CONV	●	–	●
TV TYPE	●	–	●
USB SELECT	–	–	●
DISP GUIDE	●	●	●
STATUS CHECK	●	–	●
GUIDEFAME	●	●	–
COLOR BAR	●	–	–
DATA CODE	–	–	●
 REMAINING	●	–	●
REMOTE CTRL	●	●	●
REC LAMP	●	●	–
BEEP	●	●	●
DISP OUTPUT	●	●	●
MENU ROTATE	●	●	●
A.SHUT OFF	●	●	●
CALIBRATION	–	–	●

 **TIME/LANGU. menu** (p. 59)

CLOCK SET	●	●	●
WORLD TIME	●	●	●
LANGUAGE	●	●	●

CAMERA SET menu

Settings to adjust your camcorder to the recording conditions (SPOT METER/WHITE BAL./STEADYSHOT, etc.)

The default settings are marked with ►.
The indicators in parentheses appear when the items are selected.

See page 38 for details on selecting menu items.

PROGRAM AE

You can record pictures effectively in various situations with the PROGRAM AE function. Set the AUTO LOCK switch to OFF beforehand (p. 25).

► AUTO

Select to automatically record pictures effectively without the [PROGRAM AE] function.

SPOTLIGHT* (☹)



Select to prevent people's faces from appearing excessively white when subjects are lit by strong light.

PORTRAIT (Soft portrait) (☺)



Select to bring out the subject such as people or flowers while creating a soft background.

BEACH&SKI* (☀)



Select to prevent people's faces from appearing dark in strong light or reflected light, such as at a beach in midsummer or on a ski slope.

SUNSET&MOON** (☾)



Select to maintain the atmosphere of situations such as sunsets, general night views or fireworks.

LANDSCAPE** (⬆)



Select to shoot distant subjects clearly. This setting also prevents your camcorder from focusing on glass or metal mesh in windows that comes in between the camcorder and the subject.

- Items with one asterisk (*) can be adjusted to focus on subjects only a short distance away. Items with two asterisks (**) can be adjusted to focus on subjects farther away.
- The setting returns to [AUTO] when you set the POWER switch to OFF (CHG) for more than 12 hours.

SPOT METER (Flexible spot meter)

You can adjust and fix the exposure to the subject, so that it is recorded in suitable brightness even when there is strong contrast between the subject and the background, such as subjects in the spotlight on stage. Set the AUTO LOCK switch to OFF beforehand (p. 25).

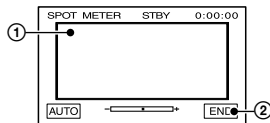

① Touch the point where you want to fix and adjust the exposure on the screen.

—<=>— appears.

② Touch [END].

To return the setting to automatic exposure, touch [AUTO]→[END].

- If you set [SPOT METER], the exposure is set to the manual mode automatically.

WHITE BAL. (White balance)

You can adjust the color balance to the brightness of the recording environment. Set the AUTO LOCK switch to OFF beforehand (p. 25).

▶ AUTO

The white balance is adjusted automatically.

OUTDOOR (☀️)

The white balance is adjusted to be appropriate for the following recording conditions:

- Outdoors
- Night views, neon signs and fireworks
- Sunrise or sunset
- Under daylight fluorescent lamps

INDOOR (🏠)

The white balance is adjusted to be appropriate for the following recording conditions:

- Indoors
- At party scenes or studios where the lighting conditions change quickly
- Under the video lamps of those at a studio, or under sodium lamps or incandescent-like color lamps

ONE PUSH (📷)

The white balance will be adjusted according to the ambient light.

- ① Touch [ONE PUSH].
- ② Frame a white object such as a piece of paper, to fill the screen under the same lighting conditions as you will shoot the subject.
- ③ Touch [📷].
 📷 flashes quickly. When the white balance has been adjusted and stored in the memory, the indicator stops flashing.
 - Keep framing a white object while 📷 is flashing quickly.
 - 📷 flashes slowly if white balance

could not be set.

- If 📷 keeps flashing even after you have touched [OK], set [WHITE BAL.] to [AUTO].
- When you have changed the battery pack while [AUTO] is selected, select [AUTO] and aim your camcorder at a nearby white object for about 10 seconds for better color balance adjustment.
- Redo the [ONE PUSH] procedure if you change the [PROGRAM AE] settings, or bring your camcorder outdoors from inside the house, or vice versa.
- To adjust the white balance under white or cool white fluorescent lamps, set [WHITE BAL.] to [AUTO], or follow the procedure when using [ONE PUSH].
- The setting returns to [AUTO] when you set the POWER switch to OFF (CHG) for more than 12 hours.

SHARPNESS

You can adjust the sharpness of the image outline with [-]/[+]. [📷] appears when the sharpness is anything other than the default setting.



SHUTTR SPEED

You can manually adjust and fix the shutter speed for your convenience. Depending on the shutter speed, you can make the subject look still, or on the contrary, emphasize the fluidity of movement. Set the AUTO LOCK switch to OFF beforehand (p. 25).

▶ AUTO

Select to adjust the shutter speed automatically.

MANUAL Ⓢ

Adjust the shutter speed using

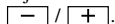

You can select a shutter speed between 1/10000 second and 1/3 second.

Slower [-] 120, 150, 215 [+] Faster



CAMERA SET menu (Continued)

- For example, if you select 1/100 second, [100] appears on the screen.
- When shooting a bright subject, setting the shutter speed to a faster value is recommended.
- At a slow shutter speed, automatic focus may be lost. Use a tripod and adjust the focus manually.
- When recording under a discharge tube such as a fluorescent lamp, sodium lamp or mercury lamp, horizontal bands may appear in the screen or color discrepancies may occur depending on the shutter speed.
- The setting you have made will return to the default setting if you set the POWER switch to OFF (CHG) for more than 12 hours.



AUTO SHUTTER

Automatically activates the electronic shutter to adjust the shutter speed when recording in bright conditions if you set it to [ON] (the default setting).

AE SHIFT



When the exposure (p. 24) is set automatically, you can adjust the exposure using  (dark)/ (bright).  and the setting value appear when [AE SHIFT] is anything other than the default setting.

CAMERA COLOR

You can adjust the color intensity with /.  appears when [CAMERA COLOR] is anything other than the default setting.

  
Decreases color intensity \longleftrightarrow Increases color intensity

WB SHIFT (White Balance Shift)

You can adjust the white balance to the desired setting using /.  and the setting value are displayed when [WB SHIFT] is anything other than the default setting.

- When the white balance is set to a lower value, pictures appear bluish, and when set to a higher value, pictures appear reddish.

SPOT FOCUS

You can select and adjust the focal point to aim it at a subject not located in the center of the screen.

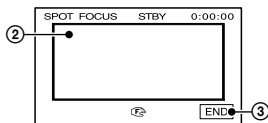

- ① Set the FOCUS/ZOOM switch to MANUAL (p. 24).
- ② Touch the subject on the screen.
- ③ Touch [END].

To adjust the focus automatically, set the FOCUS/ZOOM switch to AUTO.

FLASH SET

■ FLASH LEVEL

HIGH(⚡+)

Makes the flash level higher.

► NORMAL(⚡)

LOW(⚡-)

Makes the flash level lower.

■ REDEYE REDUC

You can prevent redden by activating the flash before recording. Set [REDEYE REDUC] to [ON], then press  (flash) (p. 26) repeatedly to select a setting.

 (Auto redden reduction): Pre-flashes to reduce redden before the flash automatically flashes when there is insufficient ambient light.

↓
 (Forced redden reduction): Always uses the flash and the redden reducing pre-flash.



 (No flash): Records without flash.

- The redeye reduction may not produce the desired effect due to individual differences and other conditions.

SUPER NS (Super NightShot)

The picture will be recorded at a maximum of 16 times the sensitivity of NightShot recording if you set [SUPER NS] to [ON] while the NIGHTSHOT switch (p. 24) is also set to ON.

 and ["SUPER NIGHTSHOT"] appear on the screen.

To return to the normal setting, set the NIGHTSHOT switch to OFF.

- Do not use NightShot/[SUPER NS] in bright places. This may cause a malfunction.
- Do not cover the infrared port with your fingers or other object
- Remove the conversion lens (optional).
- Adjust the focus manually (p. 25) when it is hard to focus automatically.
- The shutter speed of your camcorder changes depending on the brightness. The motion of the picture may slow down at this time.

NS LIGHT (NightShot Light)

When using either the NightShot (p. 24) or [SUPER NS] (p.45) function to record, you can record clearer pictures by setting [NS LIGHT], which emits infrared light (invisible), to [ON] (the default setting).

- Do not cover the infrared port with your fingers or other objects.
- Remove the conversion lens (optional).
- The maximum shooting distance using [NS LIGHT] is about 3 m (10 ft.).

COLOR SLOW S (Color Slow Shutter)

When you set [COLOR SLOW S] to [ON], you can record an image brighter in color even in dark places.

 and [COLOR SLOW SHUTTER] appear on the screen.

To cancel [COLOR SLOW S], touch [OFF].

- Adjust the focus manually (p. 25) when it is hard to focus automatically.
- The shutter speed of your camcorder changes depending on the brightness. The motion of the picture may slow down at this time.

ZEBRA

This is useful as a guide when adjusting the brightness. When you change the default setting,  is displayed. The zebra pattern is not recorded.

► OFF

The zebra pattern is not displayed.

70

The zebra pattern appears at a screen brightness level of about 70 IRE.

100

The zebra pattern appears at a screen brightness level of about 100 IRE or higher.

- Portions of the screen where brightness is about 100 IRE or above may appear overexposed.
- The zebra pattern is diagonal stripes that appear in portions of the screen where brightness is at a preset level.

HISTOGRAM

When you set [HISTOGRAM] to [ON], the [HISTOGRAM] (a graph to display a distribution of tones in your picture) window appears on the screen.

This item is useful when you adjust exposure. You can adjust the exposure or [AE SHIFT] checking the [HISTOGRAM] window. The [HISTOGRAM] will not be recorded on a tape or "Memory Stick Duo."

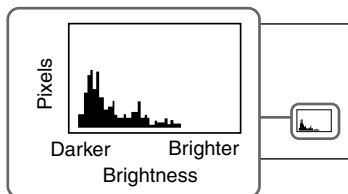

- The left area on the graph shows the darker areas of the picture while the right area shows the brighter areas.

SELF-TIMER

The self-timer starts recording after about 10 seconds.

- ① Touch **P-MENU** → [SELF-TIMER] → [ON] → **OK**.
 Ⓞ appears.
- ② Press **REC START/STOP** to record movies, or **PHOTO** to record still images.
 To cancel the count down, touch [RESET].

To cancel the self-timer, select [OFF] in step ①.

- You can also use the self-timer with the Remote Commander (p. 32).

DIGITAL ZOOM

You can select the maximum zoom level in case you want to zoom to a level greater than 10 × (the default setting) while recording on a tape. Note that the image quality decreases when you are using the digital zoom.

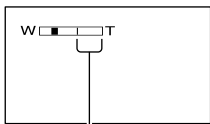

The right side of the bar shows the digital zooming factor. The zooming zone appears when you select the zooming level.

▶ OFF

Up to 10 × zoom is performed optically.

20 ×

Up to 10 × zoom is performed optically, and after that, up to 20 × zoom is performed digitally.

120 ×

Up to 10 × zoom is performed optically, and after that, up to 120 × zoom is performed digitally.

STEADYSHOT

You can compensate for camera shake (the default setting is [ON]). Set [STEADYSHOT] to [OFF] (OFF) when using a tripod (optional), then the image becomes natural.

CONV. LENS

When using an optional conversion lens, use this function to record using the optimum compensation for camera shake for each lens.

▶ OFF

Select this when the conversion lens (optional) is not used.

WIDE CONV. (W)

Select this to use the wide conversion lens (optional).

TELE CONV. (T)

Select this to use the tele conversion lens (optional).

MEMORY SET menu

Settings for the “Memory Stick Duo” (BURST/QUALITY/IMAGE SIZE/ALL ERASE/ NEW FOLDER, etc.)

The default settings are marked with ▶.
The indicators in parentheses appear when
the items are selected.

See page 38 for details on selecting
menu items.

STILL SET

■ BURST

You can record several still images one
after another by pressing PHOTO.

▶ OFF

Select this when not recording
continuously.

NORMAL

Records from 3 (1920 × 1440 image size),
5 (1440 × 1080 image size) to 25 (640 ×
480 image size) images continuously at
about 0.5 second intervals.

The maximum number of images are
recorded when you press and hold PHOTO
fully.

EXP. BRKTG (BRK)

Records 3 images consecutively with
different exposures at about 0.5 second
intervals. You can compare the 3 images
and select an image recorded at the best
exposure.

- The flash will not function during continuous
photo recording.
- The maximum number of images will be
recorded in the self-timer mode or when you are
operating with the Remote Commander.
- [EXP. BRKTG] will not function when you
have space for fewer than 3 images remaining
on the “Memory Stick Duo.”
- When you set wide (16:9) ratio of the screen
you can record 3 images (1920 × 1080 image
size) continuously.

■ QUALITY

▶ FINE (FINE)

Records still images at the fine image
quality level.

STANDARD (STD)

Records still images at the standard image
quality level.

■ IMAGE SIZE

▶ 1920 × 1440

Records still images clearly.

1920 × 1080

Records still images clearly in the wide
(16:9) ratio.

1440 × 1080





Allows you to record more still images in
relatively clear quality.

640 × 480

Allows for the maximum number of
images to be recorded.

Capacity of the “Memory Stick Duo” (MB) and the number of recordable pictures

When the POWER switch is set to CAMERA-MEMORY

	1920 × 1440 	1920 × 1080 	1440 × 1080 	640 × 480 
16MB	11 26	14 34	19 43	96 240
32MB	22 54	29 69	39 88	190 485
64MB	45 105	59 135	78 175	390 980
128MB	91 215	115 280	155 355	780 1970
256MB	165 395	215 500	280 640	1400 3550
512MB	335 800	435 1000	570 1300	2850 7200
1GB	680 1600	890 2100	1150 2650	5900 14500
2GB	1400 3350	1800 4300	2400 5500	12000 30000

When the POWER switch is set to CAMERA-TAPE or PLAY/EDIT*

	1440 × 810 └─┬─┘ 1440	1080 × 810 └─┬─┘ 1080	640 × 480 └─┬─┘ 640	640 × 360 └─┬─┘ 640
16MB	25 60	34 80	96 240	115 240
32MB	51 120	69 160	190 485	240 485
64MB	100 240	135 325	390 980	490 980
128MB	205 490	280 650	780 1970	980 1970
256MB	370 890	500 1150	1400 3550	1750 3550
512MB	760 1800	1000 2400	2850 7200	3600 7200
1GB	1550 3650	2100 4900	5900 14500	7300 14500
2GB	3150 7500	4300 10000	12000 30000	15000 30000

* The image size is fixed as follows:

- Images recorded with the POWER switch set to CAMERA-TAPE are 1440 × 810 when in HDV format or DV format (16:9), and 1080 × 810 when in DV format (4:3).
- Images recorded with the POWER switch set to PLAY/EDIT are 1440 × 810 when in HDV format, 640 × 360 when in DV format (16:9), and 640 × 480 when in DV format (4:3).
- The number of recordable pictures is shown in the table.
[FINE] is on top, and [STANDARD] is on the bottom.
- When using the “Memory Stick Duo” made by Sony Corporation. The number of recordable pictures varies depending on the recording environment.

Approximate image size of a picture (kB)

4:3 picture

1920 × 1440	1440 × 1080	1080 × 810	640 × 480
1380	800	450	150
580	350	190	60

16:9 picture

1920 × 1080	1440 × 810	640 × 360
1060	600	130
450	260	60

- The table shows the approximate number of still images that can be taken for each image size. [FINE] is on top, and [STANDARD] is on the bottom.

ALL ERASE

Deletes all the pictures on a “Memory Stick Duo” without image protection, or in the selected folder.

- ① Select [ALL FILES] or [CURRENT FOLDER].
[ALL FILES]: Deletes all the images on the “Memory Stick Duo.”
[CURRENT FOLDER]: Deletes all the images in the selected folder.
- ② Touch [YES] twice → [X].
- Cancel image protection on the “Memory Stick Duo” beforehand when using the “Memory Stick Duo” with the write-protect tab (p. 102).
- The folder will not be deleted even when you delete all the pictures in the folder.
- Do not do any of the following while [Erasing all data...] is displayed:
 - Operate the POWER switch/operation buttons.
 - Eject the “Memory Stick Duo.”

FORMAT

The supplied or newly purchased “Memory Stick Duo” has been formatted at the factory, and does not require formatting.

To execute formatting, touch [YES] twice → [X].

Formatting is completed, and all the images will be deleted.

- Do not do any of the following while [Formatting...] is displayed:
 - Operate the POWER switch/operation buttons.
 - Eject the “Memory Stick Duo.”
- Formatting erases everything on the “Memory Stick Duo” including protected image data and newly created folders.

FILE NO.

► SERIES

Assigns file numbers in sequence even if the “Memory Stick Duo” is replaced with another one. The file number is reset when a new folder is created or the recording folder is replaced with another.

RESET

Resets the file number to 0001 each time the “Memory Stick Duo” is changed.

NEW FOLDER

You can create a new folder (102MSDCF to 999MSDCF) on a “Memory Stick Duo.” When a folder is full (a maximum of 9999 images are stored) a new folder is automatically created.

Touch [YES] → [X].

- You cannot delete the created folders using your camcorder. You will have to format the “Memory Stick Duo” (p. 49), or delete them using your computer.
- The number of recordable pictures on a “Memory Stick Duo” may decrease as the number of folders increases.

REC FOLDER (Recording folder)

Select the folder to be used for recording with [▲]/[▼], then touch [OK].

- As the default setting, pictures are saved in the 101MSDCF folder.
- Once you record a picture in a folder, the same folder will be set as the default folder for playback.

PB FOLDER (Playback folder)

Select the playback folder with [▲]/[▼], then touch [OK].

PICT.APPLI. menu

Special effects on pictures or additional functions on recording/playback (SLIDE SHOW/PICT. EFFECT, etc.)

The default settings are marked with ►. The indicators in parentheses appear when the items are selected.

See page 38 for details on selecting menu items.

FADER

You can add the following effects to currently recording pictures.

- ① Select the desired effect, then touch [OK].
- ② Press REC START/STOP.

The fader indicator stops flashing and disappears when the fade is complete.

To cancel the operation, touch [OFF] in step ①.



WHITE FADER



BLACK FADER



MOSAIC FADER



MONOTONE

When fading in, the picture gradually changes from black-and-white to color. When fading out, it gradually changes from color to black-and-white.

D. EFFECT (Digital effect)

You can add digital effects to your recordings.

- ① Touch the desired effect.
- ② Adjust the effect with \square / \square , then touch [OK].

When you select [STILL], the image when you touch [OK] is saved as a still image.

Effect	Items to adjust
CINEMA EFFECT*	No adjustment necessary.
STILL	The degree of transparency of the still image you want to superimpose on a movie.
FLASH	The interval of frame-by-frame playback.
TRAIL	The fade time of the incidental image.
OLD MOVIE*	No adjustment necessary.

* Available during recording only.

- ③ Touch [OK].
[D+] appears.

To cancel [D. EFFECT], touch [OFF] in step ①.

CINEMA EFFECT (Cinematic effect)

You can add a cinematic atmosphere to pictures by adjusting the image quality.

STILL

Records a movie while superimposing it on a previously recorded still image.



FLASH (flash motion)

Records a movie with a serial-still-image effect (strobe effect).

TRAIL

Records a picture so that an incidental image like a trail is left.

OLD MOVIE

Adds an old movie effect with a sepia hue to pictures.

- You cannot change to another digital effect while recording pictures on a tape with [CINEMA EFFECT] selected.
- You cannot record pictures edited using special effects on the tape in your camcorder.
- You cannot add effects to externally input pictures. The playback pictures edited with digital effects are output via the  HDV/DV Interface (i.LINK) jack without effect control.
- You can save pictures edited using special effects on a "Memory Stick Duo" (p. 67) or record them on another tape (p. 62).

PICT. EFFECT (Picture effect)

You can add special effects to a picture during recording or playback.  appears.

▶ OFF

Does not use [PICT. EFFECT] setting.

SKINTONE

Makes skin texture look more smoother and more appealing.

NEG.ART

The color and brightness are reversed.

SEPIA

Pictures appear in sepia.

B&W

Pictures appear in black and white.

SOLARIZE

Pictures appear as an illustration with strong contrast.

PASTEL

Pictures appear as a pale pastel drawing.*

MOSAIC

Pictures appear mosaic-patterned.*

* Available during recording only.



- While using the back light function, you cannot select [SKINTONE]. And when you use the back light function with [PICT.EFFECT] set to [SKINTONE], the [SKINTONE] setting will be canceled.
- You cannot add effects to externally input pictures. The playback pictures edited with picture effects are output via the  HDV/DV Interface (i.LINK) jack without effect control.
- You can also record pictures edited using special effects on another tape (p. 62).

SLIDE SHOW

Plays back the images stored on a "Memory Stick Duo," or in a folder in sequence (slide show).

- ① Touch [SET]→[PB FOLDER].
- ② Select [ALL FILES (a)] or [CURRNT FOLDER (T)], then touch [OK].
If you select [CURRNT FOLDER (T)], all the images in the current playback folder selected in [PB FOLDER] (p. 49) are played back in sequence.
- ③ Touch [REPEAT].
- ④ Select [ON] or [OFF], then [OK].
To repeat the slide show, select [ON] (C).
To execute the slide show only once, select [OFF].
- ⑤ Touch [END]→[START].

To cancel [SLIDE SHOW], touch [END].
To pause, touch [PAUSE].

- You can select the first picture for the slide show with / before touching [START].

INT.REC-STL (Interval photo recording)

You can record still images on the “Memory Stick Duo” at a selected interval. This function is useful to observe the movement of clouds or the changes in daylight, etc.

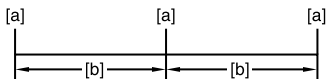

[a]: Recording

[b]: Interval

- ① Touch [SET] → a desired interval time (1, 5 or 10 minutes) → [OK] → [ON] → [OK] → [X].
- ② Press PHOTO fully.
 stops flashing and the interval still image recording starts.

To cancel [INT.REC-STL], select [OFF] in step ①.

SHOT TRANS

You can register the settings of focus and zoom and then change the recording setting from the current one to the registered one, resulting in a smooth transition of scenes (Shot transition).

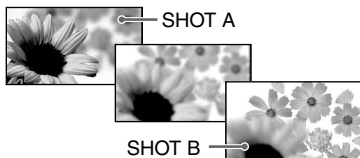

STORE

Set the zoom (p. 24) and focus (p. 25) at the desirable setting and press [STORE-A]. [SHOT-A] flashes and will be registered. Register [STORE-B] as well.

EXEC

Touch [NEXT] → [EXEC-A] or [EXEC-

B] and the recording setting changes to the registered one. Touch [BACK] to register again or touch [END] to finish the operation.

- You cannot register the setting while recording.
- It takes about 4 seconds to change to the registered setting.
- If you register [SHOT TRANS], the [WHITE BAL.] setting is also registered at the same time.
- The recording angle varies during [SHOT TRANS].
- Use the tripod because [STEADYSHOT] does not function.

DEMO MODE

The default setting is [ON], allowing you to view the demonstration in about 10 minutes, after you have removed both a cassette and a “Memory Stick Duo” from your camcorder, and slide the POWER switch down to turn on the CAMERA-TAPE lamp.

- The demonstration will be suspended in situations such as those described below.
 - When you touch the screen during the demonstration. (The demonstration starts again in about 10 minutes.)
 - When a cassette or a “Memory Stick Duo” is inserted.
 - When the POWER switch is set to other than CAMERA-TAPE.

PictBridge PRINT

See page 69.

EDIT/PLAY menu

Settings for editing or playing back in various modes (VAR.SPD PB/END SEARCH, etc.)







The default settings are marked with ►.
The indicators in parentheses appear when the items are selected.

See page 38 for details on selecting menu items.

VAR.SPD PB (Various speed playback)



You can play back in various modes while viewing movies.

- ① Touch the following buttons during playback.

To	Touch
change the playback direction*	 (frame)
play back slowly**	 To reverse direction :  (frame) →  DV
play back frame by frame	 (frame) during playback pause. To reverse direction:  (frame) during frame playback. DV

* Horizontal lines may appear at the top, bottom, or in the center of the screen. This is not a malfunction.

** Pictures output from the  HDV/DV Interface (i.LINK) jack cannot be played back smoothly in slow mode.

- ② Touch  → .

To return to the normal playback mode, touch  (Play/Pause) twice (once from frame playback).

- You will not hear the recorded sound. You may see mosaic-like images of the previously played picture.
- Pictures in the HDV format are not output from the  HDV/DV Interface (i.LINK) jack when they are paused or played back in other than normal playback mode.

- Pictures in the HDV format may appear distorted during:
 - Picture search
 - Reverse playback

REC CTRL (Movie recording control)

See page 65.

BURN DVD

When your camcorder is connected to a Sony VAIO series personal computer, you can easily burn the picture recorded on the tape on a DVD (Direct Access to “Click to DVD”) using this command. See “Creating a DVD (Direct Access to “Click to DVD”)” (p. 77) for details.

- The quality of the picture to be copied to DVDs is SD (standard definition).

END SEARCH

EXEC

The most recently recorded picture is played back for about 5 seconds and then stops automatically.

CANCEL

Stops [END SEARCH].

STANDARD SET menu

Settings while recording on a tape or other basic settings (REC MODE/MULTI-SOUND/LCD/VF SET/DISP OUTPUT, etc.)

The default settings are marked with ►. The indicators in parentheses appear when the items are selected.

See page 38 for details on selecting menu items.

VCR HDV/DV

Select the playback signal. Normally select [AUTO].

When the camcorder is connected to another device using an i.LINK cable (optional), select the signal to be input/output from the  HDV/DV Interface (i.LINK) jack. The selected signal is recorded or played back.

►AUTO

Select this to play back signals by switching the format between HDV and DV automatically.

For an i.LINK connection, select this to record/play back signals input/output from the  HDV/DV Interface (i.LINK) jack by switching the format between HDV and DV automatically.

HDV

Select this to play back the signals in the HDV format only.

For an i.LINK connection, select this to record/play back the input/output signals in the HDV format only. Select this when connecting the camcorder to a computer, etc.

DV

Select this to play back the signals in the DV format only.

For an i.LINK connection, select this to record/play back the input/output signals in the DV format only. Select this when connecting the camcorder to a computer, etc.

- Disconnect the i.LINK cable (optional) before setting [VCR HDV/DV]. Otherwise, the connected device such as a VCR may not be able to recognize the video signal from this

camcorder.

- When [AUTO] is selected and the signal switches between HDV and DV formats, the picture and sound disappear temporarily.
- When [i.LINK CONV] is set to [ON HDV→DV], pictures are output as follows:
 - at [AUTO], an HDV signal is converted to the DV format and output; a DV signal is output as it is.
 - at [HDV], an HDV signal is converted to the DV format and output; a DV signal is not output.
 - at [DV], a DV signal is output as it is; an HDV signal is not output.

REC FORMAT

You can select a recording format.

► HDV1080i (HDV1080i)

Select to record in the HDV1080i specification.

DV (DV)

Select to record in the DV format.

- When you output the picture during recording simultaneously to a connected device using an i.LINK cable (optional), also set [i.LINK CONV] accordingly.

DV SET DV

REC MODE(Recording mode)

► SP (SP)

Records in the SP (Standard Play) mode on a cassette.

LP (LP)

Increases the recording time to 1.5 times the SP mode (Long Play).

- If you record in the LP mode, a mosaic-like noise may appear or sound may be interrupted when you play back the tape on other camcorders or VCRs.
- When you mix recordings in the SP mode and in the LP mode on one tape, the playback picture may be distorted or the time code may not be written properly between the scenes.

WIDE SELECT

You can select the picture size for the TV to be connected. Refer also to the instruction manuals supplied with your TV.

▶ 16:9 WIDE

You can record the picture for the full screen.

4:3 (4:3)

You can record the picture for the normal screen.

On the LCD screen or viewfinder when setting to [16:9 WIDE]

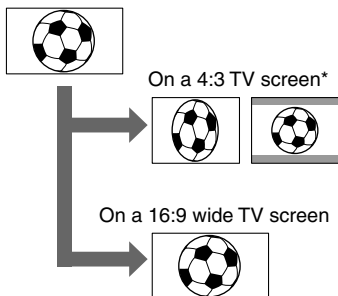

- * The playback picture may look different depending on the TV connected.
- A recorded [16:9 WIDE] image played back on a 4:3 TV has the same width as the original but is cropped horizontally. For better viewing on the 4:3 TV, set [WIDE SELECT] to [4:3] on your camcorder when recording a picture.

AUDIO MODE

▶ 12BIT

Records in the 12-bit mode (2 stereo sounds).

16BIT (16b)

Records in the 16-bit mode (1 stereo sound with high quality).

- When recording in the HDV format, sound is automatically recorded in [16BIT] mode.

AUDIO MIX

You can monitor the sound recorded on the tape using another device with audio dubbing during playback.

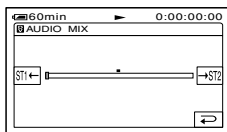

Touch [ST1←] / [→ST2] to adjust the balance of the original sound (ST1) and the sound recorded afterwards (ST2), then touch [OK].

- The original sound (ST1) is output at the default setting.
- The adjusted audio balance returns to the default setting when you set the POWER switch to OFF (CHG) for more than 12 hours.

VOLUME

Touch [−] / [+] to adjust the volume.

MULTI-SOUND

You can select whether to play back audio recorded using other devices with dual sound or stereo sound.

▶ STEREO

Plays back with main and sub sound (or stereo sound).

1

Plays back with main sound or the left channel sound.

2

Plays back with sub sound or the right channel sound.

- You can play back, but cannot record a dual sound track cassette on your camcorder.
- The setting returns to [STEREO] when you set the POWER switch to OFF (CHG) for more than 12 hours.

MIC LEVEL

You can adjust the recording sound level manually.

► AUTO

Select to adjust the recording sound level automatically.

MANUAL

Touch / to adjust the recording sound level during recording or standby.

The recording sound level adjustment bars appear on the screen. The recording sound level increases as the bar goes to the right. The recording level meter appears when the default setting is changed.

- Use headphones to monitor the sound when adjusting it.
- The setting returns to [AUTO] when you set the POWER switch to OFF (CHG) for more than 12 hours.
- The limiter in your camcorder enables recording with reduced distortion, even if you set the recording level too high in the [MANUAL] setting. For best results, adjust the recording level so as to avoid exceeding 0dB.

EXT SUR MIC (External surround microphone)

► WIDE STEREO ((••))

Records 2 channel sound with more presence by connecting a microphone (optional).

STEREO

Records the stereo sound normally.

- You need a compatible accessory such as the ECM-HQP1 microphone (optional) to record the sound in the [WIDE STEREO] setting.
- Sound is recorded in the [STEREO] setting if the microphone is not connected, even if another setting is selected.

LCD/VF SET

The recorded picture will not be affected by this operation.

■ LCD BRIGHT

You can adjust the brightness of the LCD screen.

- ① Adjust the brightness with / .
- ② Touch .

- You can also turn off the LCD backlight (p.16).

■ LCD BL LEVEL

You can adjust the brightness of the LCD screen's backlight.

► NORMAL

Standard brightness.

BRIGHT

Brightens the LCD screen.

- When you connect your camcorder to outside power sources, [BRIGHT] is automatically selected for the setting.
- When you select [BRIGHT], battery life is slightly reduced during recording.

■ LCD COLOR

You can adjust the color on the LCD screen with / .



■ VF B.LIGHT

You can adjust the brightness of the viewfinder.

► NORMAL

Standard brightness.

BRIGHT

Brightens the viewfinder screen.

- When you connect your camcorder to outside power sources, [BRIGHT] is automatically selected for the setting.
- When you select [BRIGHT], battery life is slightly reduced during recording.

COMPONENT

Select [COMPONENT] when connecting your camcorder to a TV with the component input jack.

576i

Select when connecting your camcorder to a TV with the component input jack.

▶ 1080i/576i

Select when connecting your camcorder to a TV that has the component input jack and is capable of displaying the 1080i signal.

i.LINK CONV

When the POWER switch is set to CAMERA-TAPE, this setting is effective only when [HDV1080i] is selected in [REC FORMAT]. When the POWER switch is set to PLAY/EDIT, this setting is effective only when [AUTO] or [HDV] is selected in [VCR HDV/DV].

▶ OFF

Select to output the pictures from the  HDV/DV Interface (i.LINK) jack in accordance with the [REC FORMAT] and [VCR HDV/DV] settings.

ON HDV→DV

Select to always output the pictures in the DV format from the  HDV/DV Interface (i.LINK) jack.

- See [VCR HDV/DV] for information about an input signal via an i.LINK connection (p. 54).
- Disconnect the i.LINK cable (optional) before setting [i.LINK CONV]. Otherwise, the connected video device may not be able to recognize the video signal from this camcorder.

TV TYPE

You need to convert the signal depending on the TV connected when playing back the picture. The recorded pictures are played back as following illustrations.

▶ 16:9

Select to view your pictures on a 16:9 wide TV.

HDV format pictures DV format pictures



4:3

Select to view your pictures on a 4:3 standard TV.

HDV format pictures



DV format pictures



USB SELECT

Select [USB SELECT] to view pictures on a computer via the USB cable (supplied) (p. 72), or connect your camcorder to a PictBridge compliant printer.

▶ MEMORY STICK

Select to view pictures in the “Memory Stick Duo.”

PictBridge PRINT

See page 69.

DISP GUIDE

See page 17.

STATUS CHECK

You can check the setup value of the following items.

- [COMPONENT] (p. 57)
- [i.LINK CONV] (p. 57)
- [TV TYPE] (p. 57)
- [VCR HDV/DV] (when setting the POWER switch to PLAY/EDIT) (p. 54)

GUIDEFAME

You can display the frame and check that the subject is horizontal or vertical by setting [GUIDEFAME] to [ON]. The frame is not recorded. Press DISPLAY/BATT INFO to make the frame disappear.

- Pointing the subject at the cross point of the guide frame makes a balanced composition.

COLOR BAR

You can display the color bar or record it on the tape by setting [COLOR BAR] to [ON]. It is convenient to adjust the color on the monitor connected.

DATA CODE

During playback, displays the information recorded automatically (data code) during recording.

▶ OFF

Data code is not displayed.

DATE/TIME

Displays the date and time.

CAMERA DATA (below)

Displays camera setting data.

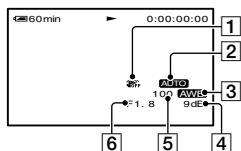

- SteadyShot off*
- Exposure*
- White balance*
- Gain*
- Shutter speed
- Aperture value

* Appears only during tape playback.

- The exposure adjustment value (OEV), a shutter speed, and the aperture value appear when still images on a "Memory Stick Duo" are played

back.

- ⚡ appears for a picture recorded using a flash.
- In the DATE/TIME data display, the date and time are displayed in the same area. If you record a picture without setting the clock, [-- --:--:] and [--:--:--:] will appear.

REMAINING

▶ AUTO

Displays the remaining tape indicator for about 8 seconds in situations such as those described below.

- When you set the POWER switch to PLAY/EDIT or CAMERA-TAPE with a cassette inserted.
- When you touch (Play/Pause).

ON

Always displays the remaining tape indicator.

REMOTE CTRL (Remote control)

The default setting is [ON], allowing you to use the Remote Commander (p. 32).

- Set to [OFF] to prevent your camcorder from responding to a command sent by another VCR remote control unit.

REC LAMP (Recording lamp)

The camera recording lamp will not light up during recording when you set this to [OFF]. (The default setting is [ON].)

BEEP

▶ ON

A melody sounds when you start/stop recording, or operate the touch panel.

OFF

Cancels the melody.

DISP OUTPUT

▶ LCD PANEL



TIME/LANGU. menu

(CLOCK SET/WORLD TIME/LANGUAGE)

Shows displays such as the time code on the LCD screen and in the viewfinder.

V-OUT/PANEL

Shows displays such as the time code on the TV screen, LCD screen, and in the viewfinder.

MENU ROTATE

► NORMAL

Scrolls the menu items downwards by touching .

OPPOSITE

Scrolls the menu items upwards by touching .

A.SHUT OFF (Auto shut off)

► 5 min

The camcorder is automatically turned off when you do not operate your camcorder for more than approximately 5 minutes.

NEVER

The camcorder is not automatically turned off.

- When you connect your camcorder to a wall socket, [A.SHUT OFF] is automatically set to [NEVER].

CALIBRATION

See page 108.

CLOCK SET

See page 18.

WORLD TIME

When using your camcorder abroad, you can set the time difference by touching /, the clock will be adjusted in accordance with the time difference.

If you set the time difference to 0, the clock returns to the originally set time.

LANGUAGE

You can select the language to be used on the LCD screen.

You can select from English, Simplified English, Traditional-Chinese, Simplified-Chinese, French, Spanish, Portuguese, German, Dutch, Italian, Greek, Russian, Arabic, Persian, or Thai.

- Your camcorder offers [ENG[SIMP]] (simplified English) for when you cannot find your native tongue among the options.

Customizing Personal Menu

You can add desired menu items to Personal Menu, and customize Personal Menu settings for each POWER switch position. This is convenient if you add frequently used menu items to Personal Menu.

Adding a menu item

You can add up to 28 menu items for each POWER switch position. Delete a less important menu item, if you want to add more.

- 1 Touch [P-MENU] → [P-MENU SET UP] → [ADD].

If the desired menu item is not displayed, touch \uparrow / \downarrow .

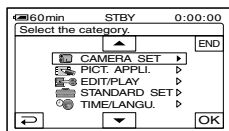

- 2 Touch \uparrow / \downarrow to select a menu category, then touch [OK].

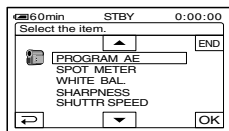

- 3 Touch \uparrow / \downarrow to select a menu item, then touch [OK] → [YES] → [X].

The menu item is added to the end of the list.

Deleting a menu item

- 1 Touch [P-MENU] → [P-MENU SET UP] → [DELETE].

If the desired menu item is not displayed, touch \uparrow / \downarrow .

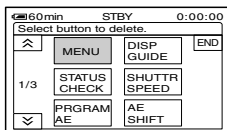

- 2 Touch the menu item that you want to delete.

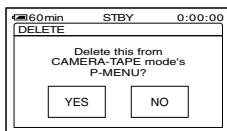

- 3 Touch [YES] → [X].

- You cannot delete [MENU] and [P-MENU SET UP].

Arranging the order of menu items displayed on Personal Menu

- 1 Touch **[P-MENU]** → **[P-MENU SET UP]** → **[SORT]**.

If the desired menu item is not displayed, touch **[↗]**/**[↘]**.

- 2 Touch the menu item you want to move.

- 3 Touch **[▲]**/**[▼]** to move the menu item to the desired place.

- 4 Touch **[OK]**.

To sort more items, repeat steps 2 to 4.

- 5 Touch **[END]** → **[X]**.

- You cannot move [P-MENU SET UP].

Initializing the Personal Menu settings (Reset)

- Touch **[P-MENU]** → **[P-MENU SET UP]** → **[RESET]** → **[YES]** → **[YES]** → **[X]**.

If the desired menu item is not displayed, touch **[↗]**/**[↘]**.









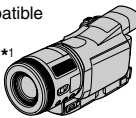

Dubbing to another device such as a VCR, DVD recorder, etc.

Use the supplied AC Adaptor as the power source (p. 11).
Refer also to the instruction manuals supplied with the devices to be connected.

Connecting to external devices

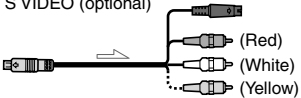
The connection method and the image quality will differ depending on the video equipment and the connectors used.

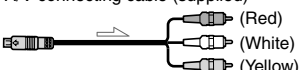
 : Signal flow

Camcorder	Cable	External device
<p>①</p> 	<p>i.LINK cable (optional)</p>  <p>i.LINK jack which is compatible with HDV1080i specification is required.</p>	<p>HDV1080i compatible device →HD quality *1</p> 
<p>①</p> 	<p>i.LINK cable (optional)</p> 	<p>AV device with i.LINK jack →SD quality *1</p> 
<p>②</p> 	<p>A/V connecting cable with S VIDEO (optional)</p>  <p>Do not connect the video plug (yellow).</p>	<p>S VIDEO AUDIO VIDEO</p> <p>AV device with S VIDEO jack →SD quality *1</p> 
<p>②</p> 	<p>A/V connecting cable (supplied)</p> 	<p>AUDIO VIDEO</p> <p>AV device with audio/video jacks *2 →SD quality *1</p> 

*1 Pictures recorded in the DV format is played back as SD (standard definition) images regardless of connection.

*2 When connecting your camcorder to a monaural device, connect the yellow plug of the A/V connecting cable to the video jack on the device, and the white or red plug to the audio jack on the device.

Jacks on your camcorder

Open the jack cover and connect the cable.

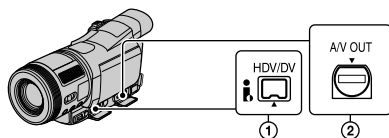

Using an i.LINK cable (optional)

The dubbed format differs depending on the video recording format or recording equipment format. Select the required settings from the table below and make the menu settings.

- Disconnect the i.LINK cable (optional) before changing these menu settings, otherwise the video equipment may not correctly identify the video signal.

Copy format	Camcorder recording format	Recording equipment format		Menu setting	
		HDV format* ¹	DV format	[VCR HDV/DV] (p. 54)	[i.LINK CONV] (p. 57)
Copy HDV recording as HDV	HDV	HDV	_* ³		[OFF]
Convert HDV recording to DV	HDV	DV	DV	[AUTO]	[ON HDV →DV]
Copy DV recording as DV	DV	DV	DV		[OFF]
When tape is recorded in both HDV and DV format					
Convert both HDV and DV format to DV	HDV/DV	DV	DV	[AUTO]	[ON HDV →DV]
Copy only portions recorded in HDV format	HDV	HDV	_* ³	[HDV]	[OFF]
	DV	_* ²	_* ³		
Copy only portions recorded in DV format	HDV	_* ²	_* ²	[DV]	[OFF]
	DV	DV	DV		

*¹Equipment compliant with the HDV1080i specification.

*²Results in a copy without an image (video nor sound is copied).

*³Picture is not recognized (no recording is made).

- When [VCR HDV/DV] is set to [AUTO] and the signal switches between HDV and DV, the picture and sound disappear temporarily.
- When the recorder is an HDR-HC1E, set [VCR HDV/DV] also on the recording device to [AUTO] (p. 54).
- If the player and the recorder are both HDR-HC1E and connected with the i.LINK cable (optional), pictures are not continued smoothly after recording pause or stop.

When connecting with the A/V connecting cable with S VIDEO (optional)

Connect with S video jack instead of the video plug (yellow). This connection produces pictures more faithfully. This connection produces higher quality DV format pictures. The audio will not be output when you connect with the S video cable alone.

Dubbing to another device

1 Connect your VCR to your camcorder as a recording device.

See page 62 for connection details.

- Set [DISP OUTPUT] to [LCD PANEL] (default setting) when connecting with an A/V connecting cable (supplied) (p. 58).

2 Prepare your VCR for recording.

When dubbing to the VCR, insert a cassette for recording.

When dubbing to the DVD recorder, insert a DVD for recording.

If your recording device has an input selector, set it to the appropriate input (such as video input1, video input2, etc.).

3 Prepare your camcorder for playback.

Insert the recorded cassette.





Slide the POWER switch down to turn on the PLAY/EDIT lamp.

Set [TV TYPE] according to the playback device (TV, etc.) (p. 57).

4 Start the playback on your camcorder, and record it on the VCR.

Refer to the operating instructions supplied with your recording device for details.

5 When the dubbing is finished, stop your camcorder and the VCR.

- The following cannot be output via the  HDV/DV interface (i.LINK) jack:
 - Indicators
 - Pictures edited with [PICT. EFFECT] (p. 51) or [D. EFFECT] (p. 50).
 - Titles that are recorded on other camcorder.
- To record the date/time and camera settings data when connected by the A/V connecting cable (supplied), display them on the screen (p. 58).
- Pictures recorded in the HDV format are not output from the  HDV/DV Interface (i.LINK) jack during playback pause or in playback modes other than normal playback.
- Note the following when connecting with an i.LINK cable (optional):
 - The recorded picture becomes rough when a picture is paused on your camcorder while recording to a VCR.
 - Data code (date/time/camera settings data) may not be displayed or recorded depending on the device or application.
 - You cannot record the picture and sound separately.
- When you use an i.LINK cable (optional), the video and sound signals are transmitted digitally, producing high quality pictures.
- When i.LINK cable (optional) is connected, the format of the output signal (**HDVOut ** or **DVOut **) will be indicated on the LCD screen of your camcorder.

Recording pictures from a VCR **i.LINK**

You can record pictures from a VCR on a tape. You can record a scene as a still image on a “Memory Stick Duo.”

Be sure to insert a cassette or a “Memory Stick Duo” for recording in your camcorder beforehand.

- You need an i.LINK cable (optional) for this operation. You cannot record pictures from any jack other than i.HDV/DV Interface (i.LINK) jack.
- Your camcorder can only record from a PAL source. For example, French video or TV programs (SECAM) cannot be recorded correctly. See page 99 for details on TV color systems.
- If you use a 21-pin adaptor to input PAL source, you need a dual direction 21-pin adaptor (optional).

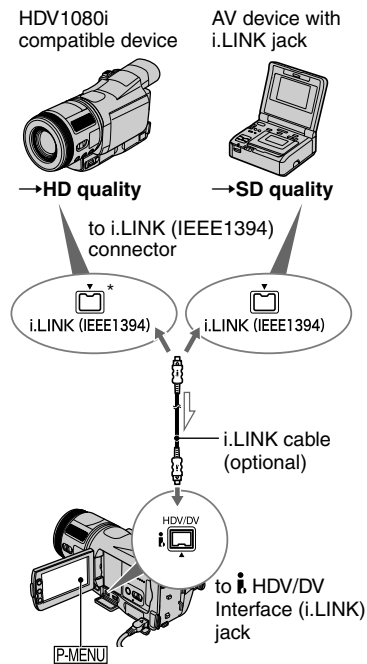

:Signal flow

* i.LINK jack which is compatible with HDV1080i specification is required.

Recording movies

1 Slide the **POWER** switch down to turn on the **PLAY/EDIT** lamp.

2 Set the input signal of your camcorder.

Set [VCR HDV/DV] to [AUTO] when recording from an HDV format compatible device.
Set [VCR HDV/DV] to [DV] or [AUTO] when recording from a DV format compatible device (p. 54).

3 Connect your VCR as a player to your camcorder.

- When i.LINK cable (optional) is connected, the format of the input signal (**HDV i.LINK** or **DV i.LINK**) will be indicated on the LCD screen of your camcorder. (This indicator may appear on the screen of the playback device, however, they will not be recorded.)

4 Insert the cassette into the VCR.

5 Operate your camcorder to record movies.

Touch [P.MENU] → [REC CTRL] → [REC PAUSE].



6 Start playing the cassette on your VCR.

The picture played on the connected device appears on the LCD screen of your camcorder.

7 Touch [REC START] at the point you want to start recording.

8 Stop recording.

When recording on a tape, touch  (STOP) or [REC PAUSE].

9 Touch  → .

- You cannot record TV programs from the  HDV/DV Interface (i.LINK) jack.
- You can record pictures from DV devices only in the DV format.
- Note the following when connecting with an i.LINK cable (optional):
 - The recorded picture becomes rough when a picture is paused on your camcorder while recording to a VCR.
 - You cannot record the picture and sound separately.
 - If you pause or stop the recording and restart it, the picture may not be recorded smoothly.
- When a 4:3 video signal is input, it appears with black bands on the right and left sides on the screen of your camcorder.

Recording still images

1 Perform steps 1 to 4 in “Recording movies.”

2 Play the video you want to record.

The pictures on the VCR appear on the screen of your camcorder.

3 Press PHOTO lightly at the scene you want to record. Check the image and press it fully.

Dubbing pictures from a tape to a “Memory Stick Duo”

You can record still images on a “Memory Stick Duo.” Make sure you have a recorded tape and a “Memory Stick Duo” inserted into your camcorder.

1 Slide the **POWER** switch down to turn on the **PLAY/EDIT** lamp.

2 Search and record the scene you want to record.

Touch  (PLAY) to play back the tape, then press PHOTO lightly at the scene you want to record. Check the image and press it fully.



- The data code recorded on the tape cannot be recorded on the “Memory Stick Duo.” The time and date the picture is copied on the “Memory Stick Duo” will be recorded.
- Still images will be fixed to image size [1440 × 810] when playing back in the HDV format. Still images will be fixed to image size [640 × 360] (16:9) or [640 × 480] (4:3) when playing back in the DV format.

Deleting recorded pictures from the “Memory Stick Duo”

1 Slide the **POWER** switch down to turn on the **PLAY/EDIT** lamp.

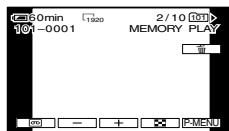
2 Touch .





3 Select a picture you want to delete with  / .

- To delete all pictures at once, select  ALL ERASE [p. 48).

4 Touch  → [YES].

- The pictures cannot be restored once they are deleted.

- You can delete pictures on the index screen (p. 23). You can easily search for the picture to be deleted by displaying 6 pictures at once.
Touch  →  DELETE → the picture you want to delete →  → [YES].
- Pictures cannot be deleted when a “Memory Stick Duo” with the write-protect tab is set to the write-protect position (p. 102), or when the selected picture is protected (p. 68).

Marking images on the “Memory Stick Duo” with specific information (Image protection/Print mark)

When you are using a “Memory Stick Duo” with the write-protect tab, make sure the write-protect tab on the “Memory Stick Duo” is not set to the write-protect position (p. 102).

Preventing accidental erasure (Image protection)

You can select and mark images to prevent accidental erasure.

1 Slide the **POWER** switch down to turn on the **PLAY/EDIT** lamp.

2 Touch **MEMORY** →  → **SET** → **[PROTECT]**.

3 Touch the image that you want to protect.

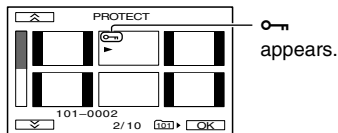

4 Touch **OK** → **[END]**.

- To cancel image protection, touch the image again to cancel image protection in step **3**.

Selecting still images for printing (Print mark)

The DPOF (Digital Print Order Format) standard is used to select images for printing on your camcorder.

By marking images that you want to print out, you do not need to reselect them when you print them out. (You cannot specify the number of printouts.)

1 Slide the **POWER** switch down to turn on the **PLAY/EDIT** lamp.

2 Touch **MEMORY** →  → **SET** → **[PRINT MARK]**.

3 Touch the image that you want to print out later.

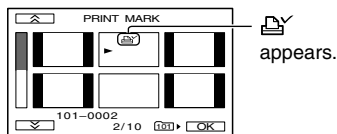

4 Touch **OK** → **[END]**.

- To cancel Print mark, touch the image again to cancel Print mark in step **3**.
- Do not mark images on your camcorder if the “Memory Stick Duo” already has some images with the Print mark put on using other devices. This may change the information of the images with the Print mark put on using the other device.

Printing recorded images

(PictBridge compliant printer)

You can print out pictures using a PictBridge compliant printer without connecting the camcorder to a computer.

PictBridge

Connect your camcorder to the AC Adaptor to supply power from the wall socket. Insert the “Memory Stick Duo” on which still images are stored into your camcorder and turn on the power of the printer.

Connect your camcorder to the printer

1 Slide the **POWER** switch down to turn on the **PLAY/EDIT** lamp.

2 Touch **P-MENU** → **[MENU]** →  **(STANDARD SET)** → **[USB SELECT]** → **[PictBridge PRINT]** → **[OK]** → .

3 Connect the  (**USB**) jack of your camcorder to the printer using the **USB cable (supplied)**.

4 Touch  (**PICT.APPLI.**) → **[PictBridge PRINT]**.

When connection is complete,  (PictBridge connecting) appears on the screen.

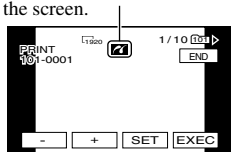



One of the images stored on the “Memory Stick Duo” will be displayed.

that are not PictBridge compatible.

Printing

1 Select the image to be printed with  / .

2 Touch **[SET]** → **[COPIES]**.

3 Select the number of copies to be printed with  / .

You can set a maximum of 20 copies of one image to be printed.

4 Touch **[OK]** → **[END]**.

To print the date on the image, touch **[SET]** → **[DATE/TIME]** → **[DATE]** or **[DAY&TIME]** → **[OK]**.

5 Touch **[EXEC]** → **[YES]**.

When printing is finished, **[Printing...]** disappears and the image selection screen appears again.

Touch **[END]** when printing is completed.

- Refer also to the operating instructions for the printer to be used.
- Do not attempt the following operations when  is on the screen. The operations may not be performed properly.
 - Operating the **POWER** switch.
 - Disconnect the **USB cable (supplied)** from the printer.
 - Removing the “Memory Stick Duo” from your camcorder.
- If the printer stops working, disconnect the **USB cable (supplied)**, turn the printer off and on again and restart the operation from the beginning.

• We cannot guarantee the operation of models

Printing recorded images (PictBridge compliant printer) (Continued)

- If you print a still image recorded with a 16:9 ratio, left and right ends of the image may be cut off.
- Some printer models may not support the date printing function. Refer to your printer's operating instructions for details.
- We cannot guarantee the printing of images recorded with a device other than your camcorder.
- PictBridge is an industry standard established by the Camera & Imaging Products Association (CIPA). You can print still images without using a computer by connecting a printer directly to a digital video camera or digital still camera, regardless of model or manufacturer.

Jacks to connect external devices

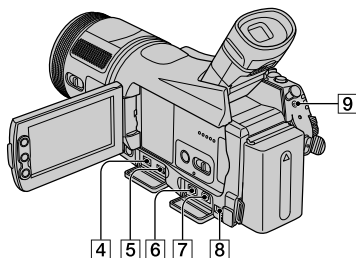
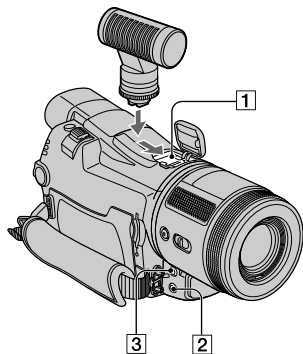

1 ...Open the shoe cover.

2 - 9 ...Open the jack cover.

1 Active Interface Shoe Active Interface Shoe

The Active Interface Shoe supplies power to optional accessories such as a video light, a flash, or a microphone. The accessory can be turned on or off as you operate the POWER switch on your camcorder. Refer to the operating instructions supplied with your accessory for details.

- When you connect an accessory, open the shoe cover.
- The Active Interface Shoe has a safety device for fixing the installed accessory securely. To connect an accessory, press down and push it to the end, and then tighten the screw. To remove an accessory, loosen the screw, and then press down and pull out the accessory.

- Connecting with an external device wears out the battery pack faster.
- You cannot use an external flash (optional) and the built-in flash at the same time.
- When an external microphone (optional) is connected, it takes precedence over the internal microphone (p. 27).

2  (headphones) jack (green)

- When you use headphones, the speaker on your camcorder is silent.

3 MIC (PLUG IN POWER) jack (red)

- This jack works as an input jack for an external microphone as well as a power-supply jack for a plug-in-power microphone. When an external microphone (optional) is connected, it takes precedence over the internal microphone (p.27).
- To fix an external microphone, the optional accessory shoe adaptor VCT-55L is recommended. Remove the accessory shoe adaptor when inserting and removing a cassette.

4  HDV/DV Interface (i.LINK) jack (p. 62, 77)

5  (USB) jack (p. 69, 72)

6 COMPONENT OUT jack (p. 34)

7 A/V (audio/video) OUT jack (p. 34, 62)

8 DC IN jack (p. 11)

9  LANC jack (blue)

- The LANC control jack is used for controlling the tape transport of video devices and peripherals connected to it.

Connecting to a computer

When connecting your camcorder to the computer, you can operate the followings:

- Copy the still images on a “Memory Stick Duo” to the computer
→ p. 72
- Copy the movie in the HDV format on a tape to the computer
→ p. 75
- Copy the movie in the DV format on a tape to the computer
→ p. 75

About connection

There are 2 ways to connect your camcorder to a computer:

– USB cable (supplied)

When copying pictures on a “Memory Stick Duo”

– i.LINK cable (optional)

When copying pictures on a tape

Notes on connecting to a computer

- When you are using a USB cable (supplied) or an i.LINK cable (optional) to connect your camcorder to a computer, make sure you insert the connector in the correct direction. If you insert the connector forcibly, it may be damaged, and causes a malfunction of your camcorder.
- You cannot do the followings:
 - Copying pictures on a tape to a computer with a USB cable (supplied).
 - Copying pictures on a “Memory Stick Duo” to a computer with an i.LINK cable (optional).
- Remove the USB cable according to the correct procedure when disconnecting it from the computer (p. 74).

Copying still images to a computer

System requirements

For Windows users

- OS: Windows 2000 Professional/Windows Millennium Edition/Windows XP Home Edition/Windows XP Professional
Standard installation is required. Operation is not assured if the above OS has been upgraded.
- CPU: MMX Pentium 200MHz or faster
- Others: USB port (This must be provided as standard)

For Macintosh users

- OS: Mac OS 9.1/9.2 or Mac OS X (v10.1/v10.2/v10.3)
- Others: USB port (This must be provided as standard)

Using the USB cable (supplied)

- You can do this operation with the standard driver of your computer. You do not need to install a software.
- If your computer has a Memory Stick slot, insert the “Memory Stick Duo” on which pictures are recorded into the Memory Stick Duo Adaptor (supplied), then insert it into the Memory Stick slot on your computer to copy still images to the computer.
- When using a “Memory Stick PRO Duo” and your computer is not compatible with it, connect your camcorder with the USB cable (supplied) instead of using the Memory Stick slot on the computer.

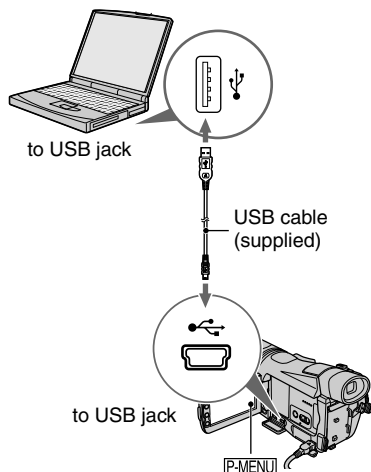

- Do not connect your camcorder to the computer at this point.
- The computer may not recognize the camcorder if you connect them with the USB cable (supplied) before turning on your camcorder.
- Refer to 75 page for the recommended connection.

1 Turn on the computer.

Close down all applications running on the computer.

For Windows 2000/Windows XP
Log on as Administrators.

2 Insert a “Memory Stick Duo” into your camcorder.

3 Prepare the power source for your camcorder.

Use the supplied AC Adaptor as the power source (p. 11).

4 Slide the POWER switch down to turn on the PLAY/EDIT lamp.

5 Touch **P-MENU** → **[MENU]** → **(STANDARD SET)** → **[USB SELECT]** → **[MEMORY STICK]** → **OK**.

6 Connect the USB cable (supplied) to the USB jack on your camcorder.

7 Connect the other end of the USB cable to the USB jack on your computer.

[USB CONNECT] appears on the LCD screen of your camcorder.

It may take some time for the computer to recognize the camcorder when you connect the USB cable for the first time.

Copying the pictures

For Windows users

Double-click the [Removable Disk] icon displayed in [My Computer]. Then, drag and drop a picture in the folder onto the hard disk drive of your computer.

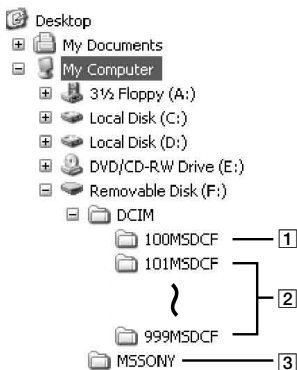

- 1 Folder containing image files recorded using other camcorders without the folder creation function (for playback only)
- 2 Folder containing image files recorded with your camcorder
When no new folders have been created, only [101MSDCF] is displayed.
- 3 Folder containing movie data recorded using other camcorders without the folder creation function (for playback only)

Folder	File	Meaning
101MSDCF (up to 999MSDCF)	DSC0□□□□ □.JPG	Still image file
□□□□ stands for any number between 0001 and 9999.		

For Macintosh users

Double-click the drive icon, then drag and drop the desired picture file onto the hard disk of your computer.

Disconnecting the USB cable (supplied)

For Windows users

If [USB CONNECT] appears on the LCD screen, follow the procedure below to disconnect the USB cable.

- 1 Click the [Unplug or eject hardware] icon on the task tray.

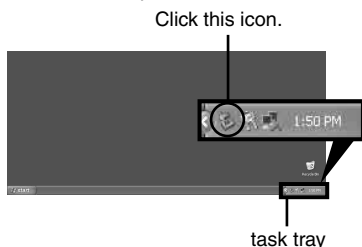

- 2 Click [Safely remove USB Mass Storage Device-Drive].



- 3 Click [OK].
- 4 Disconnect the USB cable from the camcorder and computer.

If [USB CONNECT] does not appear on the LCD screen, do only step 4 above.

- Remove the USB cable according to the correct procedure, otherwise files in the “Memory Stick Duo” may not be updated correctly. Also, this may cause a malfunction of the “Memory Stick Duo.”

Copying movies on a tape to the computer

For Macintosh users

- ① Close down all applications running on the computer.
 - ② Drag and drop the drive icon on the desktop onto the [Trash] icon.
 - ③ Disconnect the USB cable (supplied) from the camcorder and computer.
- If you are using Mac OS X, turn off the computer before disconnecting the USB cable and ejecting the “Memory Stick Duo.”
 - Do not disconnect the USB cable while the access lamp is lit.
 - Make sure to disconnect the USB cable (supplied) before turning off your camcorder.

Recommended connection

Connect as shown in the following illustrations to operate the camcorder correctly.

- Connect the camcorder to a computer via the USB cable (supplied). Make sure no other USB devices are connected to the computer.
- If your computer has a USB keyboard and a USB mouse as standard equipment, leave them connected and connect the camcorder to an available USB jack with the USB cable (supplied).
- Operation is not guaranteed if you connect two or more USB devices to the computer.
- Operation is not guaranteed if you connect the USB cable to the USB jack on a keyboard or USB hub.
- Make sure to connect the cable to the USB jack on the computer.
- Operation is not guaranteed on all the recommended environments.

Connect your camcorder to the computer with an i.LINK cable (optional). The computer needs to be provided with an i.LINK connector and be installed with editing software that can copy HDV signals. The software required depends on the format of the recorded pictures and the format for copying to the computer (HDV or DV) as shown in the table below.

Format for copying to the computer	Recorded format	Required software
HDV	HDV	Editing software capable of copying HDV signal
DV	HDV	Editing software capable of copying DV signal
DV	DV	Editing software capable of copying DV signal

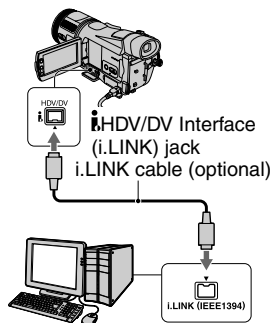

- Refer to the operating instructions of the software for the details on image copying.
- Refer to the operational instruction of the editing software for the recommended connection.
- Some editing software on the computer may not work correctly.



Notes on connecting to the computer

- Connect the i.LINK cable (optional) to the computer first, then to your camcorder.

Copying movies on a tape to the computer (Continued)

- Connecting in the opposite order may cause static electricity to build up, resulting in a malfunction of your camcorder.
- The computer may hang up or may not recognize the signal from your camcorder in the following situation.
 - Making the following setup to connect your camcorder to a computer that does not support the video signal formats that appear on the LCD screen of your camcorder display (HDV or DV).
 - Changing the [VCR HDV/DV] and [i.LINK CONV] settings on the  (STANDARD SET) menu while connecting with an i.LINK cable (optional).
 - Changing the [REC FORMAT] setting on the  (STANDARD SET) menu while connecting with an i.LINK cable (optional) with the POWER switch set to CAMERA-TAPE.
 - Changing the POWER switch position while connecting with an i.LINK cable (optional).
 - The format (HDV or DV) of input/output signal appears on the LCD screen of your camcorder while connecting with an i.LINK cable (optional).

When setting up your camcorder

The menu settings required depend on the format of the recorded pictures and the format for copying.

Copied format to the computer	Menu setting*1	Recorded format
HDV	[VCR HDV/DV] →[HDV] [i.LINK CONV] →[OFF]	HDV
DV	[VCR HDV/DV] →[HDV] [i.LINK CONV] →[ON HDV→ DV]	HDV
DV	[VCR HDV/DV] →[DV] [i.LINK CONV] →[OFF]	DV

*1 See page 54 for [VCR HDV/DV] and 57 for [i.LINK CONV].

- A tape recorded in the DV format cannot be copied in the HDV format to a computer.
- You can create DVDs from a tape by connecting your camcorder to a Sony VAIO series computer that has “Click to DVD Ver.2.3” or later installed (p. 77). The quality of the picture to be copied to DVDs is SD (standard definition).

When copying the movie in the HDV format from the computer to your camcorder

- Set [VCR HDV/DV] to [HDV] and [i.LINK CONV] to [ON HDV→DV] on the  (STANDARD SET) menu to copy an HDV format tape in the DV format (p. 54, 57).

When copying the movie in the DV format from the computer to your camcorder

- Set [VCR HDV/DV] to [DV] on the  (STANDARD SET) menu (p. 54).

Creating a DVD (Direct Access to “Click to DVD”)

i.LINK

You can create DVDs from a tape when you connect your camcorder to a Sony VAIO series computer* with “Click to DVD” installed via an i.LINK cable (optional). The picture is automatically copied and written to a DVD. The following procedures describe how to create a DVD from a picture recorded on a tape. For details of compatible computers, operating environment, “Click to DVD,” and upgrading to “Click to DVD Ver.2.3” or later, visit the following URL:

– Europe

<http://www.vaio-link.com/>

– USA

<http://cisadb.sel.sony.com/perl/select-p-n.pl>

– Asia Pacific Regional

<http://www.css.ap.sony.com/>

– Korea

<http://scs.sony.co.kr/>

– Taiwan

<http://vaio-online.sony.com/tw/vaio/>

– China

<http://www.sonystyle.com.cn/vaio/>

– Thailand

<http://www.sony.co.th/vaio/index.html>

– Latin America

<http://vaio-online.sony.com/>

* Note that you need a computer with a DVD drive that can be used to write DVDs, and “Click to DVD Ver.2.3” (Sony original software) or later installed.

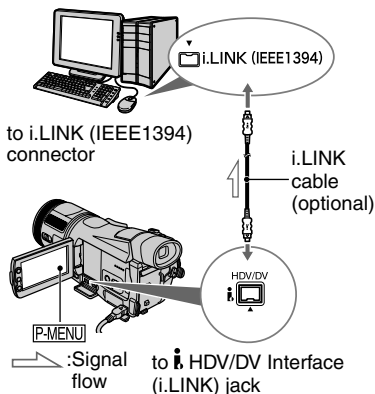

- Images recorded in HDV format are down-converted to SD (standard definition) quality when copying to DVDs. (They are not copied in the HD (high definition) quality.)
- You can only use an i.LINK cable (optional) for this operation. You cannot use a USB cable (supplied).

Using the Direct Access to “Click to DVD” function for the first time

The Direct Access to “Click to DVD” function enables you to copy pictures recorded on a tape to a DVD easily if your camcorder is connected to a computer. Before operating the Direct Access to “Click to DVD” function, follow the steps below to start “Click to DVD Automatic Mode Launcher.”

- ① Turn on the computer.
- ② Click the start menu, then select [All Programs].
- ③ Select [Click to DVD] from the programs displayed, then click [Click to DVD Automatic Mode Launcher].
[Click to DVD Automatic Mode Launcher] starts up.

- After you start up [Click to DVD Automatic Mode Launcher] once, from then on it starts up automatically when you turn on your computer.
- [Click to DVD Automatic Mode Launcher] is set up for each Windows XP user.

1 Turn on the computer.

Close all applications running with an i.LINK.

2 Prepare the power source for the camcorder.

Use the supplied AC Adaptor as the power source since it takes a few hours to create a DVD.

3 Slide the POWER switch down to turn on the PLAY/EDIT lamp.

4 Touch [P.MENU] → [MENU] → (STANDARD SET) → [i.LINK CONV] → [ON HDV → DV] → [OK].

5 Insert a recorded cassette into your camcorder.

6 Connect your camcorder to a computer via an i.LINK cable (optional) (p. 77).

- When you connect your camcorder to a computer, make sure you insert the connector in the correct direction. If you insert the connector forcibly, it may be damaged, and causes a malfunction of your camcorder.

7 Touch [P.MENU] → [MENU] → (EDIT/PLAY) → [BURN DVD] → [OK].

“Click to DVD” starts up and the on-screen instructions appear on your computer.

8 Place a writable DVD in the disc drive of the computer.

9 Touch [EXEC] on the screen of your camcorder.

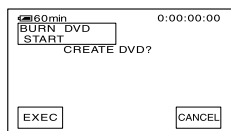

The status of the operation on your computer is displayed on the LCD screen of your camcorder.

CAPTURING: The picture recorded on the tape is being copied to the computer.

CONVERTING: The picture is being converted to the MPEG2 format.

WRITING: The picture is being written onto the DVD.

- If you use a DVD-RW/+RW which has other data stored on it, the message [This is a recorded disc. Delete and overwrite?] appears on the LCD screen of your camcorder. When you touch [EXEC], the existing data is erased and new data is written.

10 Touch [NO] to finish creating a DVD.

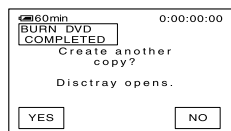

The disc tray comes out automatically. To create another DVD with the same content, touch [YES].

The disc tray comes out. Place a new writable DVD in the disc drive. Then, repeat step 9 and 10.

To cancel the operation

Touch [CANCEL] on the LCD screen of your camcorder.

- You cannot cancel the operation after [Finalizing DVD.] is displayed on the LCD screen of your camcorder.
- Do not disconnect the i.LINK cable (optional) or set the POWER switch to another mode on your camcorder until the picture is completely copied to the computer.
- When [CONVERTING] or [WRITING] is displayed on the screen, capturing of pictures has already finished. Even if you disconnect the i.LINK cable (optional) or turn off the camcorder at this stage, DVD creation will continue on your computer.
- When any of the following occurs, copying of the picture is canceled. A DVD containing the data up to the point the operation was canceled is created. Refer to the help files of “Click to DVD Automatic Mode Launcher” for details.
 - When there is a blank portion of 10 seconds or longer on the tape.
 - When the data of the tape contains a date before the recording date of the later images.
 - When normal and wide size pictures are recorded on the same tape.
- You cannot operate your camcorder in the following situations:
 - While playing back a tape
 - While recording images onto a “Memory Stick Duo”
 - When “Click to DVD” is started up from the computer

Troubleshooting

If you run into any problems using your camcorder, use the following table to troubleshoot the problem. If the problem persists, remove the power source and contact your Sony dealer.

Overall operations

The power does not turn on.

- The battery pack is discharged, running low, or not attached to the camcorder.
- Attach a charged battery pack to the camcorder (p. 11).
- Use the AC Adaptor to connect to a wall socket (p. 11).

The camcorder does not operate even when the power is set to on.

- Disconnect the AC Adaptor from the wall socket or remove the battery pack, then reconnect it after about 1 minute. If the functions still do not work, press the RESET button (p. 27) using a sharp-pointed object. (If you press the RESET button, all settings, including the clock setting, are reset, except the Personal Menu items.)

[DEMO MODE] does not start.

- Eject the cassette and “Memory Stick Duo” from your camcorder (p. 19, 20).

The camcorder gets warm.

- The camcorder may get warmer while you use it. This is not a malfunction.

Batteries/Power sources

The power abruptly turns off.

- When approximately 5 minutes have elapsed while you do not operate your camcorder, the camcorder is automatically turned off (A.SHUT OFF). Change the setting of [A.SHUT OFF] (p. 59), or turn on the power again (p. 14), or use the AC Adaptor.
- Charge the battery pack (p. 11).

The CHG (charge) lamp does not light while the battery pack is being charged.

- Slide the POWER switch up to OFF (CHG) (p. 11).
- Attach the battery pack to the camcorder correctly (p. 11).
- No power is supplied from the wall socket. (p. 11).
- The battery charge is completed (p. 11).

The CHG (charge) lamp flashes while the battery pack is being charged.

- Attach the battery pack to the camcorder correctly (p. 11). If the problem persists, disconnect the AC Adaptor from the wall socket and contact your Sony dealer. The battery pack may be damaged.

The power turns off frequently although the remaining battery time indicator indicates that the battery pack has enough power to operate.

- A problem has occurred in the remaining battery time indicator, or the battery pack has not been charged enough. Fully charge the battery again to correct the indication (p. 11).

The remaining battery time indicator does not indicate the correct time.

- The temperature of the environment is too high or too low, or the battery pack has not been charged enough. This is not a malfunction.
- Fully charge the battery again. If the problem persists, replace the battery pack with a new one. It may be damaged (p. 11, 104).
- The indicated time may not be correct depending on the environment of use. When you open or close the LCD panel, it takes about 1 minute to display the correct remaining battery time.

The battery pack is quickly discharged.

- The temperature of the environment is too high or low, or the battery pack has not been charged enough. This is not a malfunction.
- Fully charge the battery again. If the problem persists, replace the battery pack with a new one. It may be damaged (p. 11, 104).

A problem occurs when the camcorder is connected to the AC Adaptor.

- Turn off the power, and disconnect the AC Adaptor from the wall socket. Then, connect it again.

LCD screen/viewfinder

An unknown picture appears on the LCD screen or viewfinder.

- The camcorder is in [DEMO MODE] (p. 52). Touch the LCD screen or insert a cassette or a "Memory Stick Duo" to cancel [DEMO MODE].

An unknown indicator appears on the screen.

- Refer to the indicator list (p. 95).

The picture remains on the LCD screen.

- This occurs if you disconnect the AC Adaptor from the wall socket or remove the battery pack without turning off the power first. This is not a malfunction.

The buttons do not appear on the touch panel.

- Touch the LCD screen lightly.
- Press DISPLAY/BATT INFO on your camcorder (or DISPLAY on the Remote Commander) (p. 17).

Troubleshooting (Continued)

The buttons on the touch panel do not work correctly or do not work at all.

- Adjust the screen ([CALIBRATION]) (p. 108).
-

The picture in the viewfinder is not clear.

- Use the viewfinder lens adjustment lever to adjust the lens (p. 16).
-

The picture in the viewfinder has disappeared.

- Close the LCD panel. The picture is not displayed in the viewfinder when the LCD panel is open (p. 16).

Cassette tapes

The cassette cannot be ejected from the compartment.

- Make sure the power source (battery pack or AC Adaptor) is connected correctly (p. 11).
 - Remove the battery pack from the camcorder, then attach it again (p. 12).
 - Attach a charged battery pack to the camcorder (p. 11).
-

The cassette is not ejected even when the cassette lid is open.

- Moisture condensation is starting in your camcorder (p. 107).
-

The Cassette Memory indicator or title display does not appear while using a cassette with Cassette Memory.

- This camcorder does not support Cassette Memory, so the indicator does not appear.
-

The remaining tape indicator is not displayed.

- Set  REMAINING to [ON] to always display the remaining tape indicator (p. 58).
-

The cassette is noisier during rewinding or fast-forwarding.

- When using the AC adaptor, rewind/fast forward speed increases (compared with battery operation) and therefore increases noise.

“Memory Stick Duo”

You cannot operate functions using the “Memory Stick Duo.”

- Slide the POWER switch down to turn on the CAMERA-MEMORY or PLAY/EDIT lamp (p. 14).
- Insert a “Memory Stick Duo” into your camcorder (p. 20).
- If you use a “Memory Stick Duo” formatted on a computer, format it on your camcorder (p. 49).

Pictures cannot be deleted.

- Release the lock on the write-protect tab of the “Memory Stick Duo.” (p. 102)
- Cancel image protection on the picture (p. 68).
- The maximum number of pictures that you can delete at one time is 100.

You cannot delete all pictures at once.

- Release the lock on the write-protect tab of the “Memory Stick Duo.” (p. 102)
- Cancel image protection on the pictures (p. 68).

You cannot format the “Memory Stick Duo.”

- Release the lock on the write-protect tab of the “Memory Stick Duo.” (p. 102)

Image protection cannot be applied.

- Release the lock on the write-protect tab of the “Memory Stick Duo.” (p. 102)
- Perform the operation again on the index screen (p. 68).

You cannot mark pictures for print.

- Release the lock on the write-protect tab of the “Memory Stick Duo.” (p. 102)
- Perform the operation again on the index screen (p. 68).
- The maximum number of pictures you can mark for print is 999.

The data file name is not indicated correctly.

- Only the file name is displayed if the directory structure does not conform to the universal standard.
- The file is damaged.
- The file format is not supported on your camcorder (p. 102).

The data file name flashes.

- The file is damaged.
- The file format is not supported on your camcorder (p. 102).

Recording

Refer also to “Adjusting the image during recording” (p. 85) and “Memory Stick Duo” section (p. 82).

The tape does not start when you press REC START/STOP.

- Slide the POWER switch down to turn on the CAMERA-TAPE lamp (p. 22).
- The tape has reached the end. Rewind it, or insert a new cassette.

Troubleshooting (Continued)

- Set the write-protect tab to REC or insert a new cassette (p. 100).
- The tape is stuck to the drum due to moisture condensation. Remove the cassette and leave your camcorder for at least 1 hour, then re-insert the cassette (p. 107).

The zoom does not function.

- You cannot use the zoom while executing [SHOT TRANS].

You cannot record on the “Memory Stick Duo.”

- Release the lock on the write-protect tab of the “Memory Stick Duo.” (p. 102)
- The capacity is full. Delete unnecessary pictures recorded on the “Memory Stick Duo.” (p. 67)
- Format the “Memory Stick Duo” on your camcorder or insert another “Memory Stick Duo.” (p. 49)
- You cannot record movies with this unit on the “Memory Stick Duo.”
- When the POWER switch is set to CAMERA-TAPE, you cannot record still images on the “Memory Stick Duo” with:
 - [PICT. EFFECT]
 - [D. EFFECT]
 - [COLOR SLOW S]
 - [SUPER NS]
 - When [SHUTTR SPEED] is set to less than 1/25
 - While executing [FADER]
 - [COLOR BAR]

The recording angle differs depending on the POWER switch setting position.

- The recording angle when the POWER switch is set to CAMERA-MEMORY is wider than when it is set to CAMERA-TAPE.

You cannot record a smooth transition on a tape from the last recorded scene to the next.

- Note the following.
 - Perform END SEARCH. (p. 31).
 - Do not remove the cassette. (The picture will be recorded continuously without a break even when you turn the power off.)
 - Do not record pictures in the HDV and DV formats on the same tape.
 - Do not record pictures in the SP and LP modes on the same tape. DV
 - Avoid stopping then recording a movie in the LP mode. DV

The shutter sound is not heard when you record a still image.

- Set [BEEP] to [ON] (p. 58).

The internal flash does not work.

- You cannot use the internal flash with:
 - [BURST]
 - When the POWER switch is set to CAMERA-TAPE
 - When the optional microphone (ECM-HST1 or ECM-HQP1) is attached
- Even if auto flashing or  (Auto red-eye reduction) is selected, you cannot use the internal flash with:
 - [SPOTLIGHT], [SUNSET&MOON], and [LANDSCAPE] of [PROGRAM AE]
 - [SPOT METER]

The external flash (optional) does not work.

- The power of the flash is not turned on, or the flash is not attached correctly.
- The external flash (optional) does not work when the POWER switch is set to CAMERA-TAPE.

[END SEARCH] does not work.

- The cassette was ejected after recording (p. 31).
- The cassette is new and has nothing recorded.

[END SEARCH] does not work correctly.

- There is a blank section in the beginning or middle of the tape. This is not a malfunction.

Adjusting the image during recording

Refer also to “Menu” (p. 89).

You cannot adjust the exposure manually.

- You cannot adjust the exposure manually with:
 - NightShot
 - [COLOR SLOW S]
 - [CINEMA EFFECT] of [D. EFFECT]
 - [COLOR BAR]
 - When the AUTO LOCK switch is set to ON (p. 25)
- If you set [PROGRAM AE], the exposure is canceled.

The TELE MACRO button does not function.

- You cannot use the TELE MACRO function together with:
 - [PROGRAM AE]
 - When recording a movie on a tape.

The auto focus does not function.

- Set the FOCUS/ZOOM switch to AUTO to enable auto focus (p. 25).

Troubleshooting (Continued)

- The recording conditions are not suitable for auto focus. Adjust the focus manually (p. 25).
-

The focus does not function.

- You cannot operate focus while executing [SHOT TRANS].
-

[STEADYSHOT] does not function.

- Set [STEADYSHOT] to [ON] (p. 46).
 - [STEADYSHOT] does not function during [SHOT TRANS] (p. 52).
-

The BACK LIGHT function does not function.

- The BACK LIGHT function is canceled when you select [SPOT METER] (p. 42).
 - You cannot use the BACK LIGHT function when the exposure is anything other than the automatic mode.
-

[DIGITAL ZOOM] does not function.

- You cannot use [DIGITAL ZOOM] together with:
 - TELE MACRO
 - When the setting is being stored in [SHOT TRANS]
-

Tiny spots in white, red, blue, or green appear on the screen.

- The spots appear when you are recording in [SUPER NS] or [COLOR SLOW S]. This is not a malfunction.
-

The subjects passing by the frame might appear crooked.

- This is called the focal plane phenomenon. This is not a malfunction. Because of the way the image device (CMOS sensor) reads out image signals, the subjects passing by the frame rapidly might appear crooked depending on the recording conditions.
-

The color of the picture is not correctly displayed.

- Deactivate the NightShot function (p. 24).
-

The picture appears too dark on the screen, and the subject does not appear on the screen.

- The LCD backlight is turned off. Press and hold DISPLAY/BATT INFO for a few seconds to turn on the backlight (p. 16).
-

The picture appears bright, horizontal bands appear, or changes in color occurs.

- This occurs when recording pictures under a fluorescent lamp, sodium lamp, or mercury lamp. This is not a malfunction. Cancel [PROGRAM AE] (p.42) to lessen the symptom.

Black bands appear when you record a TV screen or computer screen.

- Set [STEADYSHOT] to [OFF] (p. 46).

Tiny spots in white appear on the screen.

- The spots appear at a slower shutter speed. This is not a malfunction.

Picture appears too bright on the screen, and the subject does not appear on the screen.

- Cancel the BACK LIGHT function (p. 25).

Playback

If you are playing back the pictures stored on a “Memory Stick Duo,” refer also to the “Memory Stick Duo” section (p. 82).

You cannot play back the tape.

- Slide the POWER switch down to turn on the PLAY/EDIT lamp.
- Rewind the tape (p. 23).

Cannot play back in reverse direction.

- Reverse playback is not possible with the tape recorded in the HDV format.

The pictures stored on a “Memory Stick Duo” are not played back in the actual size or aspect ratio.

- Pictures recorded on other devices may not appear in the actual size. This is not a malfunction.

Image data stored on a “Memory Stick Duo” cannot be played back.

- You cannot see movies recorded with other camcorder on the “Memory Stick Duo.”
- Image data cannot be played back if you have modified files or folders, or have edited the data on a computer. (The file name flashes in that case.) This is not a malfunction (p. 103).
- Pictures recorded on other devices may not be played back. This is not a malfunction (p. 103).

Horizontal lines appear on the picture. The displayed pictures are not clear or do not appear.

- Clean the head using the cleaning cassette (optional) (p. 107).

You cannot hear the sound recorded with 4CH MIC REC on another camcorder.

DV

- Adjust [ AUDIO MIX] (p. 55).

Fine patterns flicker, diagonal lines look jagged.

- Adjust [SHARPNESS] to the  (soften) side (p. 43).
-

No sound or only a low sound is heard.

- Set [MULTI-SOUND] to [STEREO] (p. 55).
 - Turn up the volume (p. 23).
 - Adjust [ AUDIO MIX] from the [ST2] (additional sound) side until the sound is heard appropriately (p. 55).
 - When you are using an S VIDEO plug or component video cable (supplied), make sure the red and white plugs of the A/V connecting cable are connected as well (p. 34).
-

The picture or sound breaks off.

- The tape was recorded in both HDV and DV formats. This is not a malfunction.
-

The sound breaks off.

- Clean the head using the cleaning cassette (optional) (p. 107).
-

“---” is displayed on the screen.

- The tape you are playing was recorded without setting the date and time.
 - A blank section on the tape is being played.
 - The data code on a tape with a scratch or noise cannot be read.
-

Noises appear and or is displayed on the screen.

- The tape was recorded in a TV color system other than that of your camcorder (PAL). This is not a malfunction (p. 99).
-

Date Search does not work correctly.

- If one day's recording is less than 2 minutes, your camcorder may not accurately find the point where the recording date changes.
 - There is a blank section in the beginning or middle of the tape. This is not a malfunction.
-

No picture appears during END SEARCH or Rec Review.

- The tape was recorded in both HDV and DV formats. This is not a malfunction.
-



Cannot view the picture on the TV connected with the i.LINK cable (optional).

- You cannot view the picture in the HD (high definition) quality on the TV which is not compatible with the HDV1080i specification (p. 34). Refer to the instruction manuals supplied with your TV.

Cannot view the picture or hear the sound on the TV connected with the component video cable (supplied).

- Set [COMPONENT] on the  (STANDARD SET) menu according to the requirements of the connected device (p. 57).
- When you are using the component video cable (supplied), make sure the red and white plugs of the A/V connecting cable are connected (p. 34).

The picture appears distorted on the 4:3 TV.

- This happens when viewing a picture recorded in the 16:9 wide mode on a 4:3 TV. Set [TV TYPE] on the  (STANDARD SET) menu (p. 57) and play back the picture.
- Before recording, select [DV SET] from the  (STANDARD SET) menu and set [P WIDE SELECT] to [4:3] (p. 55).

4ch-12b appears on the LCD screen.

- This appears when you play back a tape recorded on other recording devices using a 4ch microphone (4CH MIC REC). This camcorder does not comply with the 4ch microphone recording standard.

Remote Commander

The supplied Remote Commander does not function.

- Set [REMOTE CTRL] to [ON] (p. 58).
- Remove any obstructions between the Remote Commander and the remote sensor.
- Point the remote sensor away from strong light sources such as direct sunlight or overhead lighting. Otherwise, the Remote Commander may not function properly.
- Insert a new battery. Insert a battery into the battery holder with the +/- polarities correctly matching the +/- marks. (p. 109).
- Remove the conversion lens (optional) as the remote sensor may be obstructed by it.

Another VCR malfunctions when you use the supplied Remote Commander.

- Select a commander mode other than VTR 2 for your VCR, or cover the sensor of your VCR with black paper.

Menu

Menu items are grayed out.

- You cannot select grayed items in the current recording/playback situation.

You cannot use [PROGRAM AE].

- You cannot use [PROGRAM AE] together with:
 - NightShot
 - [COLOR BAR]

Troubleshooting (Continued)

- [OLD MOVIE] or [CINEMA EFFECT] of [D. EFFECT]
 - TELE MACRO
 - [COLOR SLOW S]
 - When the AUTO LOCK switch is set to ON (p. 25)
-

You cannot use [SPOT METER].

- You cannot use [SPOT METER] together with:
 - NightShot
 - [COLOR BAR]
 - [CINEMA EFFECT] of [D. EFFECT]
 - [COLOR SLOW S]
 - When the AUTO LOCK switch is set to ON (p. 25)
 - If you set [PROGRAM AE], [SPOT METER] is automatically set to [AUTO].
-

[WHITE BAL.] does not function.

- You cannot use [WHITE BAL.] together with:
 - NightShot
 - [COLOR BAR]
 - When the AUTO LOCK switch is set to ON (p. 25)
-

You cannot adjust [SHARPNESS].

- You cannot adjust [SHARPNESS] with:
 - [COLOR BAR]
 - [CINEMA EFFECT] of [D. EFFECT]
-

[SHUTTR SPEED] cannot be adjusted manually.

- You cannot adjust [SHUTTR SPEED] with:
 - NightShot
 - [PROGRAM AE]
 - [COLOR BAR]
 - [COLOR SLOW S]
 - [OLD MOVIE] or [CINEMA EFFECT] of [D. EFFECT]
 - [SPOT METER]
 - When the exposure is anything other than the automatic mode
 - When the POWER switch is set to CAMERA-MEMORY
 - When the AUTO LOCK switch is set to ON (p. 25)
 - When [PROGRAM AE] is set, [SHUTTR SPEED] returns to [AUTO].
-

[AE SHIFT] cannot be operated.

- You cannot use [AE SHIFT] together with:
 - [COLOR BAR]
 - [CINEMA EFFECT] of [D. EFFECT]
 - When the exposure is anything other than the automatic mode

You cannot use [SPOT FOCUS].

- You cannot use [SPOT FOCUS] together with:
 - [PROGRAM AE]
 - [COLOR BAR]
 - When the FOCUS/ZOOM switch is set to AUTO

[COLOR SLOW S] does not operate correctly.

- You cannot use [COLOR SLOW S] together with:
 - [FADER]
 - [D. EFFECT]
 - [PROGRAM AE]
 - [SHUTTR SPPED]
 - [COLOR BAR]
 - NightShot
 - [SPOT METER]
 - When the exposure is anything other than the automatic mode

[HISTOGRAM] is not displayed.

- [HISTOGRAM] is not displayed in the following.
 - While using expanded focus
 - While displaying the date and time
-  indicator appears and [HISTOGRAM] is not displayed in the following.
 - While using [DIGITAL ZOOM]
 - While using [D.EFFECT]
 - While using [COLOR BAR]

You cannot use [FADER].

- You cannot use [FADER] together with:
 - [SELF-TIMER]
 - [COLOR SLOW S]
 - [D. EFFECT]
 - [COLOR BAR]
 - [SUPER NS]

You cannot use [D. EFFECT].

- You cannot use [D. EFFECT] together with:
 - [COLOR SLOW S]
 - [FADER]
 - When [SHUTTR SPEED] is set to less than 1/25
 - [COLOR BAR]
 - [SUPER NS]
- You cannot use [OLD MOVIE] together with:
 - [PICT. EFFECT]
 - When [SHUTTR SPEED] is set to [MANUAL]
 - [PROGRAM AE]
 - When [ WIDE SELECT] of [DV SET] is set to [4:3]

Troubleshooting (Continued)

- You cannot use [CINEMA EFFECT] together with:
 - When the exposure is anything other than the automatic mode
 - Other than 0 in [AE SHIFT]
 - [PICT. EFFECT]
 - When [ WIDE SELECT] of [DV SET] is set to [4:3]
 - [PROGRAM AE]
 - [SPOT METER]
 - When [SHUTTR SPEED] is set to [MANUAL]
-

You cannot use [PICT. EFFECT] .

- You cannot use [PICT. EFFECT] together with:
 - [COLOR BAR]
 - [OLD MOVIE] or [CINEMA EFFECT] of [D. EFFECT]
 - [PICT. EFFECT] cannot be set to [SKINTONE] while using the BACK LIGHT function.
-

You cannot use [SHOT TRANS].

- You cannot use [SHOT TRANS] together with:
 - NightShot
 - [COLOR BAR]
-

Dubbing/Editing/Connecting to other devices

Pictures from connected devices are not displayed on the LCD screen or the viewfinder.

- Set [DISP OUTPUT] to [LCD PANEL] (p. 58).
 - You cannot input a signal to your camcorder if you press DISPLAY/BATT INFO while [DISP OUTPUT] is set to [V-OUT/PANEL] (p. 58).
-

Pictures from connected devices cannot be zoomed.

- You cannot zoom the pictures from connected devices on your camcorder (p. 26).
-

Time code and other information appear on the display of the connected device.

- Set [DISP OUTPUT] to [LCD PANEL] while connected with an A/V connecting cable (p. 58).
-

You cannot dub correctly using the A/V connecting cable.

- You cannot input externally from a device connected with the A/V connecting cable.
- The A/V connecting cable is not connected properly.
Make sure that the A/V connecting cable is connected to the input jack of another device for dubbing a picture from your camcorder.

When connected using an i.LINK cable (optional), no picture appears on the monitor screen during dubbing.

- Set [VCR HDV/DV] on the  (STANDARD SET) menu according to the requirements of the connected device (p. 54).

You cannot add sound to the recorded tape.

- You cannot add sound to the recorded tape on this unit.

New sound added to a recorded tape on another camcorder is not heard. DV

- Adjust [ AUDIO MIX] from the [ST1] (original sound) side until the sound is heard appropriately (p. 55).

Still pictures cannot be dubbed from a tape to a “Memory Stick Duo.”

- You cannot record or a distorted picture may be recorded if the tape has been used repeatedly for recording.

You cannot input pictures.

- You cannot input pictures while [DISP OUTPUT] is set to [V-OUT/PANEL] (p. 58).
- You cannot input pictures if you press DISPLAY/BATT INFO.

Connecting to a computer

The computer does not recognize your camcorder.  

- Disconnect the cable from the computer and camcorder, then connect it again securely.
- Disconnect USB devices other than the keyboard, the mouse, and the camcorder from the  (USB) jack on the computer.
- Disconnect the cable from the computer and camcorder, restart the computer, then connect them again correctly.

You cannot monitor video that the camcorder is capturing. 

- Disconnect the cable from the computer, turn on the camcorder, then connect it again.

You cannot view the video recorded on a tape on the computer. 

- Disconnect the cable from the computer, then connect it again.
- Connect the i.LINK cable (optional) because you cannot copy pictures with the USB cable (supplied).

You cannot view the video and still images recorded on a “Memory Stick Duo” on the computer. 

- Insert a “Memory Stick Duo” in the correct direction, then push it all the way in.
- You cannot use an i.LINK cable (optional). Connect the camcorder and the computer using

the USB cable (supplied).

- The computer does not recognize the “Memory Stick Duo” during camcorder operations such as tape playback or editing. Finish any camcorder operations before connecting the camcorder to the computer.
 - Slide the POWER switch down to turn on the PLAY/EDIT lamp, then set [USB SELECT] to [MEMORY STICK].
-

[Removable Disk] does not appear on the computer screen. [USB]

- Slide the POWER switch down to turn on the PLAY/EDIT lamp, then set [USB SELECT] to [MEMORY STICK].
 - Insert a “Memory Stick Duo” into your camcorder.
 - Disconnect the USB device other than the keyboard, the mouse, and the camcorder from the Ψ (USB) jack on the computer.
 - The computer does not recognize the “Memory Stick Duo” during camcorder operations such as tape playback or editing. Finish camcorder operations before connecting the camcorder to the computer.
-

You cannot copy video and still images to the computer. [USB]

- Display pictures recorded on a “Memory Stick Duo” with the following procedures for the Windows computer.
 - 1 Double-click [My Computer].
 - 2 Double-click the icon for the newly recognized drive [Removable Disk]. It may take some time until the drive is recognized.
 - 3 Double-click the desired image file.
-

The file copied from the computer is not copied to the “Memory Stick Duo.”

- The USB cable (supplied) is not removed with the right procedure. Connect your camcorder to the computer and transfer the data (p. 72).

Warning indicators and messages

Self-diagnosis display/Warning indicators

If indicators appear on the LCD screen or in the viewfinder, check the following. Some symptoms you can fix by yourself. If the problem persists even after you have tried a couple of times, contact your Sony dealer or local authorized Sony service facility.

C:(or E:) □□:□□ (Self-diagnosis display)

C:04:□□

- The battery pack is not an “InfoLITHIUM” battery pack. Use an “InfoLITHIUM” battery pack (p. 104).
- Connect the DC plug of the AC Adaptor to the DC IN jack of your camcorder securely (p. 11).

C:21:□□

- Moisture condensation has occurred. Remove the cassette and leave your camcorder for at least 1 hour, then re-insert the cassette (p. 107).

C:22:□□

- Clean the head using a cleaning cassette (optional) (p. 107).

C:31:□□ / C:32:□□

- Symptoms that are not described above have occurred. Remove and insert the cassette, then operate your camcorder again. Do not perform this procedure if moisture starts to condense (p. 107).
- Remove the power source. Reconnect it again and operate your camcorder again.
- Change the cassette. Press RESET (p. 27), and operate your camcorder again.

E:61:□□ / E:62:□□ / E:91:□□

- Contact your Sony dealer or local authorized Sony service facility. Inform them of the 5-digit code, which starts from “E.”

101-1001(Warning indicator pertaining to files)

- The file is damaged.
- The file is unreadable (p. 102).

(Battery level warning)

- The battery pack is nearly used up.
- Depending on the operating, environment, or battery conditions,  may flash, even if there are approximately 5 to 10 minutes remaining.

(Moisture condensation warning)*

- Eject the cassette, remove the power source, and then leave it for about 1 hour with the cassette lid open (p. 107).

(Warning indicator pertaining to “Memory Stick Duo”)

- “Memory Stick Duo” is not inserted (p. 20).

(Warning indicators pertaining to “Memory Stick Duo”)*

- The “Memory Stick Duo” is damaged.
- The “Memory Stick Duo” is not formatted correctly (p. 49).

(Warning indicator pertaining to incompatible “Memory Stick Duo”)*

- An incompatible “Memory Stick Duo” is inserted (p. 102).

(Warning indicators pertaining to the tape)

Slow flashing:

- There is less than 5 minutes remaining on the tape.
- No cassette is inserted.*
- The write-protect tab on the cassette is set to lock (p. 100).*

Fast flashing:

- The tape has run out.*

▲ (Eject cassette warning)*

Slow flashing:

- The write-protect tab on the cassette is set to lock (p. 100).

Fast flashing:

- Moisture condensation has occurred (p. 107).
- The self-diagnosis display code is displayed (p. 95).

🔒 (Warning indicator pertaining to image deletion)*

- The image is protected (p. 68).

🔒🔒 (Warning indicator pertaining to write-protect of the “Memory Stick Duo”)*

- The write-protect tab on the “Memory Stick Duo” is set to lock (p. 102).

⚡ (Warning indicator pertaining to the flash)

Slow flashing:

- Still charging

Fast flashing:

- The self-diagnosis display code is displayed (p. 95).*
- There is something wrong with the flash.

📷 (Warning indicator pertaining to camera-shake warning)

- The amount of lights is not sufficient, so camera-shake easily occurs. Use the flash.
- The camcorder is unsteady, so camera-shake easily occurs. Hold the camcorder steady with both hands and shoot the image. However, note that the camera-shake warning indicator

does not disappear.

* You hear a melody when the warning indicators appear on the screen (p. 58).

Description of warning messages

If messages appear on the screen, follow the instructions.

■ Battery

Use the “InfoLITHIUM” battery pack (p. 104).

Battery level is low.

- Change the battery (p. 11, 104)

Old battery. Use a new one (p. 104).

▲Re-attach the power source (p. 11).

■ Moisture condensation

🔒▲Moisture condensation. Eject the cassette (p. 107).

🔒Moisture condensation. Turn off for 1H (p. 107).

■ Cassette/Tape

📷Insert a cassette (p. 19).

▲Reinsert the cassette.

- Check if the cassette is damaged.

 **The tape is locked - check the tab** (p. 100).

 **The tape has reached the end.**

- Rewind or change the tape.

■ “Memory Stick Duo”

 **Insert a Memory Stick** (p. 20).

 **Reinsert the Memory Stick.**

- Reinsert the “Memory Stick Duo” a few times. If even then the indicator flashes, the “Memory Stick Duo” might be damaged. Try with another “Memory Stick Duo.”

This is a read-only Memory Stick.

- Insert a writable “Memory Stick Duo.”

 **Incompatible type of Memory Stick.**

- A type of “Memory Stick Duo” incompatible with your camcorder is inserted (p. 102).

 **This Memory Stick is not formatted correctly.**

- Check the format, then format the “Memory Stick Duo” as necessary (p. 49, 102).

Cannot record. The Memory Stick is full.

- Delete unnecessary images (p. 67).

 **The Memory Stick is locked. Check the tab** (p. 102).

Cannot playback. Reinsert the Memory Stick (p. 20).

Cannot record. Reinsert the Memory Stick (p. 20).

No file.

- No file is recorded or there is no readable file on the “Memory Stick Duo.”

Memory Stick folders are full.

- You cannot create folders exceeding 999MSDCF. You cannot delete created folders using your camcorder.
- You will have to format the “Memory Stick Duo” (p. 49), or delete them using your computer.

Cannot record still images on Memory Stick (p. 84).

■ PictBridge compliant printer

Check the connected device.

- Switch off the printer and switch it on again, then disconnect the USB cable (supplied) and reconnect it.

Connect the camcorder to a PictBridge compatible printer.

- Switch off the printer and switch it on again, then disconnect the USB cable (supplied) and reconnect it.

Error. Cancel the task.

- Check the printer.

Cannot print. Check the printer.

- Switch off the printer and switch it on again, then disconnect the USB cable (supplied) and reconnect it.

■ Flash

Charging... Cannot record still images.

- You are trying to record a still image while charging the flash (optional)
-

Microphone attached. Cannot use flash.

■ Others

Cannot record due to copyright protection (p. 100).

Change to correct tape format.

- The pictures cannot be played back because of an incompatible format.
-

No output image in “VCR HDV/DV”. Change format.

- Stop the playback or signal input, or change the [VCR HDV/DV] setting (p. 54).
-

Dirty video head. Use a cleaning cassette (p. 107).

Invalid in AUTO LOCK mode (p. 25).

Using your camcorder abroad

Power supply

You can use your camcorder in any countries/regions using the AC Adaptor supplied with your camcorder within the AC 100 V to 240 V, 50/60 Hz range.

On TV color systems

Your camcorder is a PAL system-based camcorder. If you want to view the playback picture on a TV, it must be a PAL system-based TV (see following list).

System	Used in
PAL	Australia, Austria, Belgium, China, Czech Republic, Denmark, Finland, Germany, Holland, Hong Kong, Hungary, Italy, Kuwait, Malaysia, New Zealand, Norway, Poland, Portugal, Singapore, Slovak Republic, Spain, Sweden, Switzerland, Thailand, United Kingdom, etc.
PAL - M	Brazil
PAL - N	Argentina, Paraguay, Uruguay.
SECAM	Bulgaria, France, Guiana, Iran, Iraq, Monaco, Russia, Ukraine, etc.
NTSC	Bahama Islands, Bolivia, Canada, Central America, Chile, Colombia, Ecuador, Guyana, Jamaica, Japan, Korea, Mexico, Peru, Surinam, Taiwan, the Philippines, the U.S.A., Venezuela, etc.

Viewing HDV format pictures recorded in HDV format HDV1080i

You need an HDV1080i compatible TV (or monitor) with a component jack and AUDIO/VIDEO input jack.

Viewing DV format pictures recorded in DV format DV

You need the TV with the AUDIO/VIDEO input jack.

Simple setting of the clock by time difference

You can easily set the clock to the local time by setting a time difference when using your camcorder abroad. Select [WORLD TIME] in the  (TIME/LANGU.) menu, then set the time difference (p. 59).

HDV format and recording/playback

Your camcorder is capable of recording in both HDV and DV formats.

You can use mini DV format cassettes only. Use a cassette with the ^{Mini} DV mark.

Mini **DV** Digital Video Cassette is a trademark.

Your camcorder is not compatible with cassettes with Cassette Memory.

What is the HDV (**HDV**) format?

The HDV format is a video format developed to record and play back digital high definition (HD) video signals on a DV cassette.

Your camcorder adopts the Interlace mode with 1080 effective scan lines of screen ruling (1080i, number of pixels 1440 × 1080 dots).

The video bit rate for recording is about 25 Mbps.

i.LINK is adopted for the digital interface, enabling a digital connection with an HDV compatible TV or computer.

- HDV signals are compressed in MPEG2 format, which is adopted in BS (broadcast satellite) digital and terrestrial digital HDTV broadcastings and in Blu-ray disc recorders.

Playback

- Your camcorder can play back pictures in both the DV format and HDV1080i specification.
- Your camcorder can play back pictures recorded in the HDV 720/30p format, but cannot output it from the  HDV/DV Interface (i.LINK) jack.

To prevent a blank section from being made on the tape

Go to the end of the recorded section using END SEARCH (p. 31) before you begin the next recording when you have played back the tape.

Copyright signal

■ When you play back

If the cassette you play back on your camcorder contains copyright signals, you cannot copy it to a tape in another video camera connected to your camcorder.

■ When you record

You cannot record software on your camcorder that contains copyright control signals for copyright protection of software. [Cannot record due to copyright protection.] appears on the LCD screen, or on the viewfinder if you try to record such software. Your camcorder does not record copyright control signals on the tape when it records.

Notes on use

■ When not using your camcorder for a long time

Remove the cassette and store it.

■ To prevent accidental erasure

Slide the write-protect tab on the cassette to set it to SAVE.

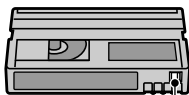

REC: The cassette can be recorded.

SAVE: The cassette cannot be recorded (write-protected).



■ When labeling the cassette

Be sure to place the label only on the locations shown in the following illustration so as not to cause a malfunction of your camcorder.

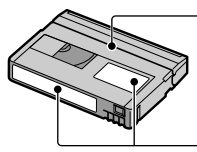

Do not put a label along this border.

Labeling position

■ After using the cassette

Rewind the tape to the beginning to avoid distortion of the picture or the sound. The cassette should then be put in its case, and stored in an upright position.

■ When cleaning the gold-plated connector

Generally, clean the gold-plated connector on a cassette with a cotton-wool swab after every 10 times it has been ejected.

If the gold-plated connector on the cassette is dirty or dusty, the remaining tape indicator may not be indicated correctly.

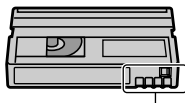

Gold-plated connector

On HDV1080i specification compliant TVs HDV1080i

An HDV format compatible TV with the component input jack is required to view playback pictures recorded in the HDV format. See the table below for the main 2004/05 models.

Sony TV models

KDL-L42MRX1, KLV-L42MRX1, KDL-L32MRX1, KLV-L32MRX1, KLV-L32M1, KLV-L32M1, KDE-P42MRX1, KE-P42MRX1, KDE-P42XS1, KE-P42XS1, KDE-P37XS1, KE-P37XS1, KE-P42M1, KE-P37M1, KDS-R60A10, KDS-R50A10, KDF-E50A10, KDF-E42A10, KDL32XBR950, KLV-L32MRX1, KLV-32M1, KE-MX42N1, KE-MX42K1, KE-MX42S1, KE-MX42A1, KE-MX42M1, KE-MX32N1, KE-MX32K1, KE-MX32S1, KE-MX32A1, KE-MX32M1, KE-P42M1, KE-MV42A1, KE-MV42M1, KV-DA32M84, KV-DA32M94, KV-DA32M86, KV-DA32M66, KV-DA32M64, KV-DA32M36, KV-DA32K94L, KV-DA32K94B, KV-DA34M80, KV-DA34X80, KV-DA34N90, KV-DA34M81, KV-DA34M86, KV-DA34M61, KV-DA34M80, KV-DA34M50, KV-DA29M80, KV-DA29MX80, KV-DA29N90, KV-DA29M90, KV-DA29M81, KV-DA29M86, KV-DA29M61, KV-DA29M60, KV-DA29M80, KV-DA29M50, KV-DA29M31, KV-DA29K90L, KV-DA29K90B, KP-FW51M90A, KP-FW46M90A, KP-FW46X90A, KP-FX43M90A, KDF-60WE610K, KDF-50WE610K, KDF-42WE610K, KF-WS60M90, KF-WE50M90, KF-WE42M90, KDF-60WF655K, KDF-55WF655K, KS-R60A10, KS-R50A10, KF-E50A10, KF-E42A10, KDS-R60A10, KDS-R50A10, KDF-E50A10, KDF-E42A10

As of 1st of June, 2005 (including models on sale in the near future)

- Some models are not available depending on the country or region.

About the “Memory Stick”

A “Memory Stick” is a compact, portable IC recording medium with a data capacity that exceeds the capacity of a floppy disk. You can use only a “Memory Stick Duo,” which is about the half size of a standard “Memory Stick” in your camcorder. However, appearance on the list below does not guarantee the operation of all types of “Memory Stick Duo” in your camcorder.

Types of “Memory Stick”	Recording/ Playback
“Memory Stick” (without MagicGate)	–
“Memory Stick Duo” (without MagicGate) ¹	○
“MagicGate Memory Stick”	–
“Memory Stick Duo” (with MagicGate) ¹	○ ^{2*3}
“MagicGate Memory Stick Duo” ¹	○ ³
“Memory Stick PRO”	–
“Memory Stick PRO Duo” ¹	○ ^{2*3}

¹A “Memory Stick Duo” is about half the size of a standard “Memory Stick.”

²The types of “Memory Stick” that support high speed data transfer. The speed of data transfer varies depending on the device to be used.

³“MagicGate” is a copyright protection technology that records and transfers the contents in an encrypted format. Note that data that uses “MagicGate” technology cannot be recorded or played on your camcorder.

- Still image format: Your camcorder compresses and records image data in the JPEG (Joint Photographic Experts Group) format. The file extension is “.JPG.”
- File names of still images:
 - 101- 0001: This file name appears on the screen of your camcorder.
 - DSC00001.JPG: This file name appears on the display of a computer.
- A “Memory Stick Duo” formatted by a computer (Windows OS/Mac OS) does not have guaranteed compatibility with your camcorder.
- Data read/write speed may vary depending on

the combination of the “Memory Stick” and “Memory Stick” compliant product you use.

On a “Memory Stick Duo” with a write-protect tab

You can prevent accidental erasure of images when you slide the write-protect tab on the “Memory Stick Duo” with a small tapered object, to the write-protect position. The “Memory Stick Duo” supplied with your camcorder is not equipped with a write-protect tab.

Notes on use

Image data may be damaged in the following cases. Compensation for damaged image data will not be made.

- If you eject the “Memory Stick Duo,” turn the power off on your camcorder, or remove the battery pack for replacement while your camcorder is reading or writing image files on the “Memory Stick Duo” (while the access lamp is lit or flashing).
- If you use the “Memory Stick Duo” near magnets or magnetic fields.

It is recommended you make a back-up of important data on the hard disk of a computer.

■ On handling a “Memory Stick”

Keep the following in mind when handling a “Memory Stick Duo.”

- Be careful not to apply excessive force when writing on a memo area on a “Memory Stick Duo.”
- Do not attach a label or the like on a “Memory Stick Duo” or a Memory Stick Duo adaptor.
- When you carry or store a “Memory Stick Duo,” put it in its case.
- Do not touch, or allow metallic objects to come into contact with the terminals.
- Do not bend, drop or apply strong force to the “Memory Stick Duo.”
- Do not disassemble or modify the “Memory Stick Duo.”
- Do not let the “Memory Stick Duo” get wet.
- Be careful to keep “Memory Stick Duo” media out of the reach of small children. There is danger that a child might swallow it.

■ On a location for use

Do not use or keep the “Memory Stick Duo” in the following locations.

- Places subject to extremely high temperature, such as a car parked outside in the summer.
- Places under direct sunlight.
- Places with extremely high humidity or subject to corrosive gases.

■ On the Memory Stick Duo adaptor (supplied)

After inserting a “Memory Stick Duo” into the Memory Stick Duo adaptor, you can use it with a standard “Memory Stick” compliant device.

- When using a “Memory Stick Duo” with a “Memory Stick” compliant device, be sure to insert the “Memory Stick Duo” into a Memory Stick Duo adaptor.
- When inserting a “Memory Stick Duo” into a Memory Stick Duo adaptor, make sure the “Memory Stick Duo” is inserted facing in the correct direction, then insert it all the way in. Note that improper use may damage the device. Also, if you force the “Memory Stick Duo” into the “Memory Stick Duo” slot in the wrong direction, the “Memory Stick Duo” slot may be damaged.
- Do not insert anything other than a “Memory Stick Duo” into the “Memory Stick Duo” slot. Doing so may cause a malfunction.
- Do not insert a Memory Stick Duo adaptor without a “Memory Stick Duo” attached. Doing so may result in malfunctions of the unit.

■ On a “Memory Stick PRO Duo”

- The maximum memory capacity of a “Memory Stick PRO Duo” that can be used on your camcorder is 2 GB.
- This unit does not support high speed data transfer.

On image data compatibility

- Image data files recorded on a “Memory Stick Duo” by your camcorder conform to the Design Rule for Camera File Systems universal standard established by the JEITA (Japan Electronics and Information Technology Industries Association).
- On your camcorder, you cannot play back still images recorded on other devices (DCR-TRV900E or DSC-D700/D770) that do not

conform to the universal standard. (These models are not sold in some regions.)

- If you cannot use a “Memory Stick Duo” that has been used with another device, format it with your camcorder (p. 49). Note that formatting erases all information on the “Memory Stick Duo.”
- You may not be able to play back images with your camcorder:
 - When playing back image data modified on your computer.
 - When playing back image data recorded with other devices.

About the “InfoLITHIUM” battery pack

This unit is compatible with an “InfoLITHIUM” battery pack (M series). Your camcorder operates only with an “InfoLITHIUM” battery pack. “InfoLITHIUM” M series battery packs have the  mark.

What is an “InfoLITHIUM” battery pack?

An “InfoLITHIUM” battery pack is a lithium-ion battery pack that has functions for communicating information related to operating conditions between your camcorder and an optional AC Adaptor/charger.

The “InfoLITHIUM” battery pack calculates the power consumption according to the operating conditions of your camcorder, and displays the remaining battery time in minutes. With an AC adaptor/charger (optional), the remaining battery time and charging time appear.

To charge the battery pack

- Be sure to charge the battery pack before you start using your camcorder.
- We recommend charging the battery pack in an ambient temperature of between 10°C to 30°C (50 °F to 86 °F) until the CHG (charge) lamp turns off. If you charge the battery pack outside of this temperature range, you may not be able to charge it efficiently.
- After charging is complete, disconnect the cable from the DC IN jack on your camcorder or remove the battery pack.

To use the battery pack effectively

- Battery pack performance decreases when the surrounding temperature is 10°C (50 °F) or below, and the length of time you can use the battery pack becomes shorter. In that case, do one of the following to use the battery pack for a longer time.
 - Put the battery pack in a pocket to warm it up, and insert it in your camcorder right before you start taking shots.
 - Use a large capacity battery pack: NP-

QM71D/QM91D (optional).

- Frequent use of the LCD screen or a frequent playback, fast forward or rewind operation wears out the battery pack faster.
 - We recommend using a large capacity battery pack: NP-QM71D/QM91D (optional).
- Be sure to set the POWER switch to OFF (CHG) when not recording or playing back on your camcorder. The battery pack is also consumed when your camcorder is in recording standby or playback pause.
- Have spare battery packs ready for two or three times the expected recording time, and make trial recordings before making the actual recording.
- Do not expose the battery pack to water. The battery pack is not water resistant.

About the remaining battery time indicator

- When the power goes off even though the remaining battery time indicator indicates that the battery pack has enough power to operate, charge the battery pack fully again. The indication on the remaining battery time will be indicated correctly. Note, however, that the battery indication will not be restored if it is used in high temperatures for a long time, or if left in a fully charged state, or when the battery pack is frequently used. Use the remaining battery time indication as a guide to the approximate shooting time.
- The  mark that indicates low battery flashes even if there are still 5 to 10 minutes of battery time remaining, depending on the operating conditions or ambient temperature and environment.

About storage of the battery pack

- If the battery pack is not used for a long time, fully charge the battery pack and use it up on your camcorder once a year to maintain proper function. To store the battery pack, remove it from your camcorder and put it in a dry, cool place.
- To discharge the battery pack on your camcorder completely, set [A.SHUT OFF] to [NEVER] on the  (STANDARD SET) menu and leave your camcorder in tape recording standby until the power goes off (p. 59).

About i.LINK

About battery life

- The battery life is limited. Battery capacity drops little by little as you use it more and more, and as time passes. When the available battery time is shortened considerably, a probable cause is that the battery pack has reached the end of its life. Please buy a new battery pack.
- The battery life varies depending on how it is stored and the operating conditions and environment for each battery pack.

The HDV/DV Interface on this unit is an i.LINK-compliant Interface. This section describes the i.LINK standard and its features.

What is i.LINK?

i.LINK is a digital serial interface for transferring digital video, digital audio, and other data to other i.LINK-compatible devices. You can also control other devices using the i.LINK.

i.LINK-compatible devices can be connected using an i.LINK cable (optional). Possible applications are operations and data transactions with various digital AV devices.

When two or more i.LINK-compatible devices are connected to this unit in a daisy chain, operations and data transactions are possible with not only the device that this unit is connected to but also with other devices via the directly connected device. Note, however, that the method of operation sometimes varies according to the characteristics and specifications of the device to be connected. Also, operations and data transactions may not be possible on some connected devices.

- Normally, only one device can be connected to this unit with the i.LINK cable (optional). When connecting this unit to an HDV/DV-compatible device having two or more DV Interfaces, refer to the operating instructions of the device to be connected.
- i.LINK is a more familiar term for the IEEE 1394 data transport bus proposed by Sony, and is a trademark approved by many corporations.
- IEEE 1394 is an international standard standardized by the Institute of Electrical and Electronics Engineers.

About the i.LINK Baud rate

i.LINK's maximum baud rate varies according to the device. There are three types.

S100 (approx. 100Mbps*)

S200 (approx. 200Mbps)

S400 (approx. 400Mbps)

The baud rate is listed under “Specifications” in the operating instructions of each piece of equipment. It is also indicated near the i.LINK interface on some devices.

The baud rate may differ from the indicated value when the unit is connected to a device with a different maximum baud rate.

* What is Mbps?

Mbps stands for “megabits per second,” or the amount of data that can be sent or received in one second. For example, a baud rate of 100 Mbps means that 100 megabits of data can be sent in one second.

To use i.LINK functions on this unit

For details on how to dub when this unit is connected to other video devices having an i.LINK Interface, see page 62.

This unit can also be connected to other i.LINK compatible devices made by Sony (e.g. a VAIO series personal computer) as well as to video devices.

Before connecting this unit to your computer, make sure that application software supported by this unit is already installed on your computer.

Some i.LINK compatible video devices, such as Digital Televisions, DVD, MICROMV or HDV recorders/players are not compatible with this unit. Before connecting to other devices, be sure to confirm whether the device is compatible with an HDV/DV device or not. For details on precautions and compatible application software, refer also to the operating instructions for the device to be connected.

About the required i.LINK cable

Use the Sony i.LINK 4-pin-to-4-pin cable (during HDV/DV dubbing).

Maintenance and precautions

On use and care



- Do not use or store the camcorder and accessories in the following locations.
 - Anywhere extremely hot or cold. Never leave them exposed to temperatures above 60°C (140 °F), such as under direct sunlight, near heaters or in a car parked in the sun. They may malfunction or become deformed.
 - Near strong magnetic fields or mechanical vibration. The camcorder may malfunction.
 - Near strong radio waves or radiation. The camcorder may not be able to record properly.
 - Near AM receivers and video equipment. Noise may occur.
 - On a sandy beach or anywhere dusty. If sand or dust gets in your camcorder, it may malfunction. Sometimes this malfunction cannot be repaired.
 - Near windows or outdoors, where the LCD screen, the viewfinder, or the lens may be exposed to direct sunlight. This damages the inside of the viewfinder or the LCD screen.
 - Anywhere very humid.
- Operate your camcorder on DC 7.2 V (battery pack) or DC 8.4 V (AC Adaptor).
- For DC or AC operation, use the accessories recommended in these operating instructions.
- Do not let your camcorder get wet, for example, from rain or sea water. If your camcorder gets wet, it may malfunction. Sometimes this malfunction cannot be repaired.
- If any solid object or liquid gets inside the casing, unplug your camcorder and have it checked by a Sony dealer before operating it any further.
- Avoid rough handling, disassembling, modifying, physical shock, or impact such as hammering, dropping or stepping on the product. Be particularly careful of the lens.
- Keep the POWER switch setting to OFF (CHG) when you are not using your camcorder.
- Do not wrap your camcorder with a towel, for example, and operate it. Doing so might cause heat to build up inside.
- When disconnecting the mains lead, pull it by the plug and not the cord.
- Do not damage the mains lead such as by placing anything heavy on it.
- Keep metal contacts clean.

- Keep the Remote Commander and button-type battery out of children's reach. If the battery is accidentally swallowed, consult a doctor immediately.
- If the battery electrolytic liquid has leaked,
 - consult your local authorized Sony service facility.
 - wash off any liquid that may have contacted your skin
 - if any liquid gets in your eyes, wash with plenty of water and consult a doctor.



■ When not using your camcorder for a long time

- Occasionally turn it on and let it run such as by playing back tapes for about 3 minutes.
- Use up the battery pack completely before storing it.

Moisture condensation

If your camcorder is brought directly from a cold place to a warm place, moisture may condense inside your camcorder, on the surface of the tape, or on the lens. In this state, the tape may stick to the head drum and be damaged or your camcorder may not operate correctly. If there is moisture inside your camcorder, [▲ Moisture condensation. Eject the cassette.] or [ Moisture condensation. Turn off for 1H.] appears. The indicator will not appear when the moisture condenses on the lens.

■ If moisture condensation has occurred

None of the functions except cassette ejection will work. Eject the cassette, turn off your camcorder, and leave it for about one hour with the cassette lid open. Your camcorder can be used again if [] or [] does not appear when the power is turned on again.

If moisture starts to condense, your camcorder sometimes cannot detect condensation. If this happens, the cassette is sometimes not ejected for 10 seconds after the cassette lid is opened. This is not a malfunction. Do not close the cassette lid until the cassette is ejected.

■ Note on moisture condensation

Moisture may condense when you bring your camcorder from a cold place into a warm place (or vice versa) or when you use your camcorder in a humid place as shown below.

- When you bring your camcorder from a ski slope into a place warmed up by a heating device.
- When you bring your camcorder from an air conditioned car or room into a hot place outside.
- When you use your camcorder after a squall or a shower.
- When you use your camcorder in a hot and humid place.

■ How to prevent moisture condensation

When you bring your camcorder from a cold place into a warm place, put your camcorder in a plastic bag and seal it tightly. Remove the bag when the air temperature inside the plastic bag has reached the surrounding temperature (after about one hour).

Video head

- When the video head becomes dirty, you cannot record pictures normally, or distorted picture or sound is played back.
- If the following problem occurs, clean the video heads for 10 seconds with the Sony DVM-12CLD cleaning cassette (optional).
 - Mosaic-pattern noise appears on the playback picture or the screen is displayed in blue.



- A part of playback pictures does not move.
- Playback pictures do not move.
- Playback pictures do not appear or the sound breaks off.
- [ Dirty video head. Use a cleaning cassette.] appears on the screen during recording.
- The video head suffers from wear after long use. If you cannot obtain a clear image even after using a cleaning cassette, it might be because the video head is worn. Please contact

Maintenance and precautions (Continued)

your Sony dealer or local authorized Sony service facility to have the video head replaced.

LCD screen

- Do not exert excessive pressure on the LCD screen, as it may cause damage.
- If your camcorder is used in a cold place, a residual image may appear on the LCD screen. This is not a malfunction.
- While using your camcorder, the back of the LCD screen may heat up. This is not a malfunction.

■ To clean the LCD screen

If fingerprints or dust make the LCD screen dirty, it is recommended you use a soft cloth to clean it. When you use the LCD Cleaning Kit (optional), do not apply the cleaning liquid directly to the LCD screen. Use cleaning paper moistened with the liquid.

■ On adjustment of the LCD screen (CALIBRATION)

The buttons on the touch panel may not work correctly. If this happens, follow the procedure below. It is recommended you connect your camcorder to the wall socket using the supplied AC Adaptor during the operation.

- ① Slide the POWER switch down to turn on the PLAY/EDIT lamp.
- ② Disconnect cables other than that of the AC Adaptor from your camcorder, then eject the cassette and “Memory Stick Duo” from your camcorder.
- ③ Touch [P-MENU] → [MENU] →  (STANDARD SET) → [CALIBRATION] → [OK].

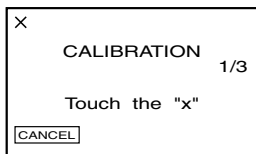

- ④ Touch the “x” displayed on the screen with the corner of the supplied “Memory Stick Duo” or the like.

Touch [CANCEL] to cancel.

The position of the “x” changes. If you did not press the right spot, start from step ④ again.

- You cannot calibrate the LCD screen if it is rotated.

On handling the casing

- If the casing is soiled, clean the camcorder body with a soft cloth lightly moistened with water, and then wipe the casing with a dry soft cloth.
- Avoid the following to avoid damage to the finish.
 - Using chemicals such as thinner, benzene, alcohol, chemical cloths, repellent, insecticide and sunscreen.
 - Handling with above substances on your hands.
 - Leaving the casing in contact with rubber or vinyl objects for a long period of time.

About care and storage of the lens

- Wipe the surface of the lens clean with a soft cloth in the following instances:
 - When there are fingerprints on the lens surface.
 - In hot or humid locations
 - When the lens is exposed to salty air such as at the seaside.
- Store in a well-ventilated location subject to little dirt or dust.
- To prevent mold, periodically clean the lens as described above. It is recommended that you operate your camcorder about once a month to keep it in optimum state for a long time.

To charge the pre-installed rechargeable battery

Your camcorder has a pre-installed rechargeable battery to retain the date, time, and other settings even when the POWER switch is set to OFF (CHG). The pre-installed rechargeable battery is always charged while your camcorder is connected to the wall socket via the AC Adaptor or while the battery pack is inserted. The rechargeable battery will be fully discharged in about **3 months** if you do

Specifications

not use your camcorder at all without the AC adaptor connected or the battery pack attached. However, even if the pre-installed rechargeable battery is not charged, the camcorder operation will not be affected as long as you are not recording the date.

■ Procedures

Connect your camcorder to a wall socket using the supplied AC Adaptor, and leave it with the POWER switch set to OFF (CHG) for more than 24 hours.

To change the battery of the Remote Commander

- ① While pressing on the tab, inset your fingernail into the slit to pull out the battery case.
- ② Place a new battery with the + side facing up.
- ③ Insert the battery case back into the Remote Commander until it clicks.

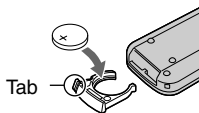

WARNING

Battery may explode if mistreated. Do not recharge, disassemble or dispose of in fire.

Caution

Danger of explosion if battery is incorrectly replaced. Replace only with the same or equivalent type recommended by the manufacturer. Discard used batteries according to the manufacturer's instructions.

- When the lithium battery becomes weak, the operating distance of the Remote Commander may shorten, or the Remote Commander may not function properly. In this case, replace the battery with a Sony CR2025 lithium battery. Use of another battery may present a risk of fire or explosion.

System

Video recording system (HDV)	2 rotary heads, Helical scanning system
Video recording system (DV)	2 rotary heads, Helical scanning system
Still image recording system	Exif Ver. 2.2* ¹
Audio recording system (HDV)	Rotary heads, MPEG-1 Audio Layer -2, Quantization: 16 bits (Fs 48 kHz, stereo) transfer rate: 384 kbps
Audio recording system (DV)	Rotary heads, PCM system Quantization: 12 bits (Fs 32 kHz, stereo 1, stereo 2), 16 bits (Fs 48 kHz, stereo)
Video signal	PAL color, CCIR standards 1080/50i specification
Usable cassette	Mini DV cassette with the Mini DV mark printed
Tape speed (HDV)	Approx. 18.81 mm/s
Tape speed (DV)	SP: Approx. 18.81 mm/s LP: Approx. 12.56 mm/s
Recording/playback time (HDV)	60 min (using a DVM60 cassette)
Recording/playback time (DV)	SP: 60 min (using a DVM60 cassette) LP: 90 min (using a DVM60 cassette)
Fast forward/rewind time	Approx. 2 min 40 s (using a DVM60 cassette and rechargeable battery pack) Approx. 1 min 45 s (using a DVM60 cassette and AC Adaptor)
Viewfinder	Electric viewfinder (color)
Image device	5.9 mm (1/3 type) CMOS sensor Gross: Approx. 2 969 000 pixels Effective (movie, 4:3): 1 486 000 pixels Effective (movie, 16:9): 1 983 000 pixels Effective (still, 4:3): 2 764 800 pixels Effective (still, 16:9): 2 073 600 pixels
Lens	Carl Zeiss Vario-Sonnar T* 10 × (Optical), 120 × (Digital)

Specifications (Continued)

Focal length	f=5.1 ~ 51 mm (7/32 ~ 2 1/8 in.) When converted to a 35 mm still camera In CAMERA-TAPE *2: 41 ~ 480 mm (1 5/8 ~ 19 in.) (16:9), 50 ~ 590 mm (2 ~ 23 1/4 in.) (4:3) In CAMERA-MEMORY: 37 ~ 370 mm (1 1/2 ~ 14 5/8 in.) (4:3), 40 ~ 400 mm (1 5/8 ~ 15 3/4 in.) (16:9) F1.8 ~ 2.1 Filter diameter: 37 mm (1 1/2 in.)
Color temperature	[AUTO], [ONE PUSH], [INDOOR] (3 200 K), [OUTDOOR] (5 800 K)
Minimum illumination	7 lx (lux) (F 1.8) 0 lx (lux) (during NightShot function)*3

*1“Exif” is a file format for still images, established by the JEITA (Japan Electronics and Information Technology Industries Association). Files in this format can have additional information such as your camcorder’s setting information at the time of recording.

*2The focal length figures are actual figures resulting from wide angle pixel read-out.

*3Objects unable to be seen due to the dark can be shot with infrared lighting.

Output connectors

Audio/Video output	10-pin connector Video signal: 1 Vp-p, 75 Ω (ohms), unbalanced Luminance signal: 1 Vp-p, 75 Ω (ohms), unbalanced Chrominance signal: 0.3 Vp-p, 75 Ω (ohms), unbalanced Audio signal: 327 mV (at Load impedance more than 47 kΩ (kilohms)), Output impedance with less than 2.2 kΩ (kilohms)
COMPONENT OUT jack	Y: 1 Vp-p, 75 Ω (ohms), unbalanced Pb/Pr, Cb/Cr: +/- 350 mVp-p
Headphones jack	Stereo minijack (Ø 3.5)

Input/Output connectors

MIC jack	Minijack, 0.388 mV low impedance with DC 2.5 to 3.0 V, output impedance 6.8 kΩ (kilohms) (Ø 3.5 mm), Stereo type
LANC jack	Stereo mini-minijack (Ø 2.5 mm)
USB jack	mini-B
 i.LINK/DV jack	i.LINK Interface (IEEE 1394, 4-pin connector S100)

LCD screen

Picture	6.9 cm (2.7 type, aspect ratio 16:9)
Total dot number	123 200 (560 × 220)

General

Power requirements	DC 7.2 V (battery pack) DC 8.4 V (AC Adaptor)
Average power consumption (when using the battery pack)	During camera recording using the viewfinder with normal brightness: HDV recording 5.5 W DV recording 5.0 W During camera recording using the LCD with normal brightness: HDV recording 5.7 W DV recording 5.2 W
Operating temperature	0 °C to 40 °C (32 °F to 104 °F)

Storage temperature	-20 °C to + 60 °C (-4 °F to + 140 °F)
Dimensions (approx.)	71 × 94 × 188 mm (2 7/8 × 3 3/4 × 7 1/2 in.) (w/h/d) excluding the projecting parts
Mass (approx.)	680 g (1lb 7oz) main unit only 780 g (1lb 11oz) including the NP-FM50 rechargeable battery pack, DVM60 cassette and lens cap.
Supplied accessories	See page 10.

AC Adaptor AC-L15A/L15B

Power requirements	AC 100 - 240 V, 50/60 Hz
Current consumption	0.35 - 0.18 A
Power consumption	18 W
Output voltage	DC 8.4 V*
Operating temperature	0 °C to 40 °C (32 °F to 104 °F)
Storage temperature	-20 °C to + 60 °C (-4 °F to + 140 °F)
Dimensions (approx.)	56 × 31 × 100 mm (2 1/4 × 1 1/4 × 4 in.) (w/h/d) excluding the projecting parts
Mass (approx.)	190 g (6.7 oz) main unit only

* See the label on the AC Adaptor for other specifications.



Rechargeable battery pack (NP-FM50)

Maximum output voltage	DC 8.4 V
Output voltage	DC 7.2 V
Capacity	8.5 Wh (1 180 mAh)
Dimensions (approx.)	38.2 × 20.5 × 55.6 mm (1 9/16 × 13/16 × 2 1/4 in.) (w/h/d)
Mass (approx.)	76 g (2.7 oz)
Operating temperature	0 °C to 40 °C (32 °F to 104 °F)
Type	Lithium ion

Design and specifications are subject to change without notice.

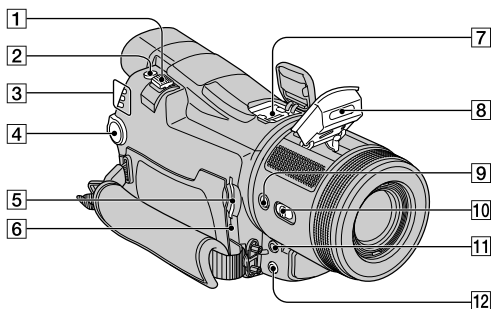
Identifying parts and controls



- 1 Power zoom lever (24)
- 2 PHOTO button (22)
- 3 CAMERA-TAPE, CAMERA-MEMORY, PLAY/EDIT mode lamps (14)
- 4 POWER switch (14)
- 5 "Memory Stick Duo" slot (20)
- 6 Access lamp (20, 102)
- 7 Active Interface Shoe  (70)
- 8 Flash
- 9  (flash) button (26)
- 10 NIGHTSHOT switch (24)
- 11 MIC (PLUG IN POWER) jack (71)
- 12  (headphones) jack (71)

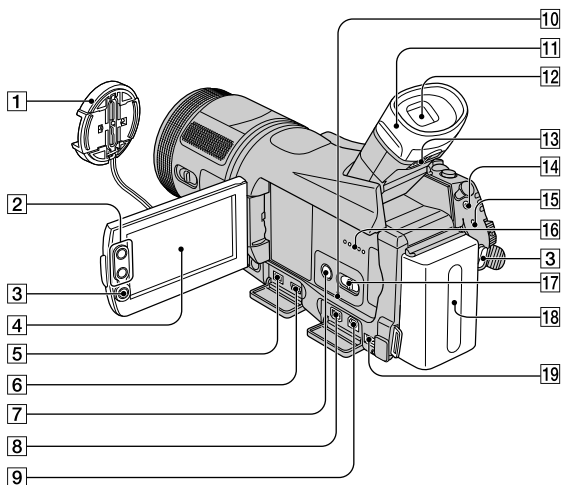

- 1 Lens cap (14, 22)
- 2 Zoom buttons (24)
- 3 REC START/STOP button (22)
- 4 LCD screen/touch panel (3, 17)
- 5 iHDV/DV Interface (i.LINK) jack (70)
- 6 USB (USB) jack (70)
- 7 DISPLAY/BATT INFO button (27)
- 8 COMPONENT OUT jack (70)
- 9 A/V OUT jack (70)
- 10 RESET button (27)
- 11 Eyecup
- 12 Viewfinder (16)
- 13 Viewfinder lens adjustment lever (16)
- 14 LANC jack (70)
- 15 CHG (charge) lamp (11)
- 16 Speaker (27)
- 17 AUTO LOCK switch (25)
- 18 Battery pack (11)
- 19 DC IN jack (70)

Attaching the shoulder strap

Attach the shoulder strap supplied with your camcorder to the hooks for the shoulder strap.

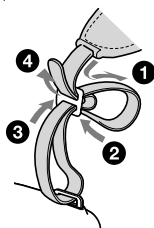

Identifying parts and controls (Continued)

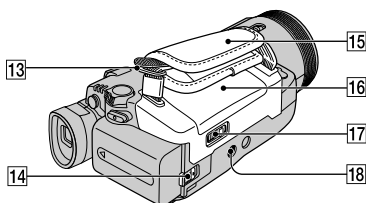
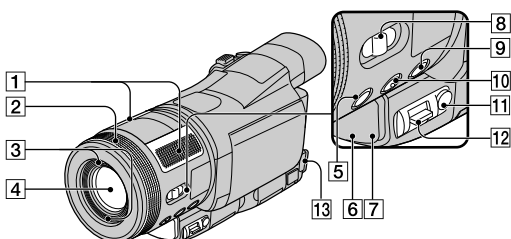

- 1 Microphone (27)
- 2 Zoom ring/focus ring (24, 25)
- 3 Holes for the lens hood
- 4 Lens (Carl Zeiss Lens) (4)
- 5 TELE MACRO button (25)
- 6 Camera recording lamp (27)
- 7 Remote sensor (27)
- 8 FOCUS/ZOOM switch (24, 25)
- 9 BACK LIGHT button (25)
- 10 EXPANDED FOCUS button (25)
- 11 EXPOSURE button (24)
- 12 EXPOSURE/VOL lever (24)
- 13 Hooks for the shoulder strap (113)
- 14 BATT (battery release) lever (12)
- 15 Grip belt (14)
- 16 Cassette compartment lid (19)
- 17 OPEN/EJECT  lever (19)
- 18 Tripod receptacle (26)

Attaching the lens hood

Insert the hooks on the lens hood into the holes on the camcorder, then turn the lens hood fixing screw in the direction of the arrow.

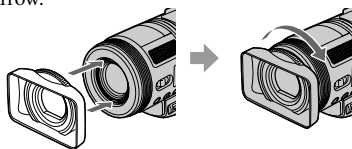

To remove the lens hood

Loosen the lens hood fixing screw by turning it in the opposite direction of the arrow in the illustration above.

- You cannot attach a filter (optional) with the lens hood on.

Index

Numeric

1080i/576i	57
12BIT	55
16BIT	55
21-pin adaptor	65
576i	57

A

A/V connecting cable.....	35, 62
A/V OUT jack	34, 62
Access lamp	20
Active Interface Shoe.....	70
AC Adaptor	11
Adjusting exposure for back light	25
AE SHIFT	44, 92
ALL ERASE	48
AUDIO MIX	55
AUDIO MODE	55
Audio recording	93
AUTO LOCK switch	25
AUTO SHUTTER.....	44
A.SHUT OFF (Auto shut off).....	59

B

BACK LIGHT	25, 86
Battery	
BATTERY INFO (Battery info)	27
Battery pack	11
Remaining battery.....	27
BATT (battery release) lever	12
BEACH&SKI.....	42
BEEP.....	58
BLACK FADER	50
BURN DVD	53
BURST.....	47
Button-type lithium battery	109

B&W	51
-----------	----

C

Calibration.....	108
CAMERA COLOR.....	44
CAMERA DATA	58
CAMERA SET menu	42
Cassette	19, 100
Insert/Eject.....	19
Charging the battery.....	11
Battery pack	11
Pre-installed rechargeable battery....	108
Charging time.....	12
CHG (charge) lamp.....	12
CINEMA EFFECT (Cinematic effect)	50
Click to DVD	77
CLOCK SET	18
COLOR BAR.....	58
COLOR SLOW S (Color Slow Shutter)	45, 91
COMPONENT.....	57
COMPONENT OUT jack	34, 71
Component video cable	35, 36
Connect	
computer.....	72
TV	34
VCR equipment	62
CONV. LENS.....	46

D

DATA CODE	58
Date search.....	33
DATE/TIME.....	58
DC IN jack	11
DC plug.....	11
Delete pictures	67
DEMO MODE	52, 80
DIGITAL ZOOM.....	46, 86

DISPLAY/BATT INFO button	17, 27
Display indicators	28
DISP GUIDE (Display guide)	17
DISP OUTPUT	58
Down convert function.....	9
Dubbing.....	64
DV format	54
DV interface.....	64
D. EFFECT (Digital effect)	50

E

END SEARCH.....	31, 53
END SEARCH/Rec review display switch button	28
ERASE	
ALL ERASE.....	48
Pictures	67
Expanded focus	25
Exposure	24, 85
EXPOSURE button.....	24
EXPOSURE/VOL lever.....	24
EXP. BRKTG (Exposure bracketing)	47
EXT SUR MIC (External surround microphone).....	56
EDIT/PLAY menu	53

F

FADER.....	50, 91
FILE NO. (File number)	49
FINE.....	47
Flash button.....	26, 84
FLASH LEVEL	44
FLASH (Flash motion)	50
FLASH SET.....	44
Focus	25, 85
Focus ring.....	25
FOCUS/ZOOM switch	24, 25

Index (Continued)

- Folder
- NEW FOLDER..... 49
 - PB FOLDER (Playback folder) 49
 - REC FOLDER (Recording folder) 49
- FORMAT 49, 102
- Frame-by-frame playback.... 53
- Full charge 12
- ### G
- Grip belt 14
- GUIDEFAME 58
- ### H
- HDV 1080i 8, 54
- HDV format 54
- HD (high definition) image quality 34
- Headphones jack 71
- HISTOGRAM..... 45, 92
- Holding the camcorder..... 14
- ### I
- Icon See Display indicators
- Image delete button..... 29
- Image protection 68
- Image quality (QUALITY) 47
- Image size (IMAGE SIZE) 47
- Still image..... 47
- Index screen 23
- Index screen display button 29
- Indicators..... 30
- INDOOR..... 43
- “InfoLITHIUM” battery pack 104
- Initialize (Reset)..... 27
- Insulation sheet 32
- Internal microphone 27
- INT.REC-STL (Interval photo recording)..... 52
- i.LINK 105
- i.LINK cable 62, 77
- i.LINK CONV..... 34, 57
- ### J
- Jack 70
- Jack cover..... 70
- JPEG 102
- ### L
- Label 100
- LANC jack 71
- LANDSCAPE..... 42
- LANGUAGE..... 59
- LCD/VF SET 56
- LCD backlight..... 16
- LCD BL LEVEL (LCD back light) 56
- LCD BRIGHT..... 56
- LCD COLOR..... 56
- LCD PANEL..... 58
- LCD panel..... 16
- LCD BL LEVEL 56
 - LCD BRIGHT 56
 - LCD COLOR..... 56
- LCD screen 3
- Lens cap 10
- Lens hood..... 114
- Lid 19
- LP (Long Play)..... 54
- ### M
- Macintosh..... 72, 74, 75
- Mains lead..... 11
- Maintenance 106
- Main sound..... 55
- Manual focus..... 25
- MEMORY SET menu..... 47
- “Memory Stick” 102
- “Memory Stick Duo” 19
- FORMAT 49
 - Insert/Eject..... 20
 - Number of recordable pictures..... 47
 - Write-protect tab..... 102
- Memory Stick Duo adaptor..... 10, 103
- “Memory Stick Duo” slot 20
- Menu 38
- CAMERA SET menu ... 42
 - EDIT/PLAY menu 53
 - MEMORY SET menu 47
 - Menu items 40
 - Personal Menu 38, 60
 - PICT.APPLI. menu 50
 - STANDARD SET menu 54
 - TIME/LANGU. menu 59
 - Using the menu 38
- MENU ROTATE 59
- MIC (PLUG IN POWER) jack 71
- MIC LEVEL 56
- Mirror mode 26
- Moisture condensation..... 107
- MONOTONE..... 50
- MOSAIC 51
- MOSAIC FADER 50
- MULTI-SOUND 55
- ### N
- NEG.ART..... 51
- NEW FOLDER 49
- NightShot 24
- NORMAL 47
- NS LIGHT 45
- NTSC 99
- Number of recordable pictures 47

O

OLD MOVIE	51
ONE PUSH	43
OPEN/EJECT lever.....	19
OUTDOOR	43

P

PAL	65, 99
PASTEL	51
PB FOLDER (Playback folder).....	49
PB zoom.....	26
Peaking.....	25
Personal Menu	38, 60
Add	60
Arrange the order.....	61
Customize.....	60
Delete.....	60
Reset	61
Use.....	38
Personal Menu button	28
PHOTO button	22, 32
PictBridge	69
PictBridge PRINT.....	69
Picture Search	23
PICT.APPLI. menu (Picture Application menu)	50
PICT. EFFECT (Picture effect).....	51
Playback.....	23
Frame.....	53
Reverse	53
Slow	53
Playing time	13
PORTRAIT (Soft portrait) ...	42
POWER switch	14
Previous/Next image button	29
Print.....	69
Print mark.....	68
PROGRAM AE.....	42, 89

P.MENU See Personal Menu

Q

QUALITY	47
---------------	----

R

Rechargeable battery pack See Battery	
Recording.....	22
Recording capacity.....	28
Recording time.....	12
REC CTRL (Recording control).....	65
REC FOLDER (Recording folder).....	49
REC FORMAT	54
REC LAMP.....	58
REC Lamp (Recording lamp).....	27
REC MODE (Recording mode).....	54
Rec review.....	31
REC START/STOP	22
REDEYE REDUC	44
REMAINING.....	58
Remaining battery	28
Remote Commander	32
REMOTE CTRL (Remote control).....	58
Remote sensor.....	27
RESET button	27
Reversal Playback	53
Review button	28

S

SD (standard definition) image quality.....	34
Searching for the starting point	31
Self-diagnosis display	95
SELF-TIMER	46
SEPIA	51

Setting the date and time.....	18
SHARPNESS	43, 90
SHOT TRANS	52
Shoulder Strap.....	10, 113
SHUTTR SPEED.....	43
SKINTONE.....	51, 92
Skip Scan	23
SLIDE SHOW.....	51
Slow Playback.....	53
SOLARIZE	51
SP (Standard Play)	54
Speaker.....	27
Specifications	109
SPOTLIGHT	42
SPOT FOCUS	44, 91
SPOT METER (Flexible spot meter)	42, 90
STANDARD	47
STANDARD SET menu	54
STATUS CHECK.....	57
STEADYSHOT.....	46, 86
STEREO	56
STILL.....	50
Still image	
Image size	47
Quality	47
Still image format	102
STILL SET.....	47
Sub sound.....	55
SUNSET&MOON	42
SUPER NS	45
System requirements.....	72
S VIDEO cable	36, 62
S VIDEO jack	34, 62

T

Tape..... See Cassette	
Tape counter.....	28
Tape playback select button ..	29
Telephoto.....	24
TELE MACRO button ...	25, 85

Index (Continued)

TIME/LANGU. menu..... 59
Time code..... 28
Touch panel..... 17
Trademark..... 119
TRAIL..... 51
Transmitter..... 32
Tripod..... 26
TV..... 34
TV color systems..... 99
TV TYPE..... 57

U

USB jack..... 71
USB SELECT..... 57
Using abroad..... 99

V

VAR.SPD PB (Various speed playback)..... 53
VCR HDV/DV..... 54
VF B.LIGHT (Viewfinder brightness)..... 56
Video head..... 107
Video operation buttons..... 29
Viewfinder..... 16
 Brightness..... 56
Viewfinder lens adjustment lever..... 16
VOLUME..... 55
Volume..... 23
V-OUT/PANEL..... 59

W

Warning indicators..... 95
Warning messages..... 95
WB SHIFT (White Balance Shift)..... 44
WHITE BAL. (White balance)..... 43
White Balance Shift..... 44
WHITE FADER..... 50

Wide angle..... 24
WIDE SELECT..... 55
WIDE STEREO..... 56
Windows..... 72, 73
WORLD TIME..... 59
Write-protect tab..... 100, 102

Z

ZEBRA..... 45
Zero set memory..... 32
ZERO SET MEMORY button..... 32
Zoom..... 24
Zoom lever..... 24
Zoom ring..... 24

On trademarks

- “Memory Stick,” , “Memory Stick Duo,” **MEMORY STICK DUO**, “Memory Stick PRO Duo,” **MEMORY STICK PRO DUO**, “MagicGate,” **MAGIC GATE**, “MagicGate Memory Stick” and “MagicGate Memory Stick Duo” are trademarks or registered trademarks of Sony Corporation.
- “InfoLITHIUM” is a trademark of Sony Corporation.
- i.LINK and  are trademarks of Sony Corporation.
- Mini  is a trademark.
- Microsoft, Windows, and Windows Media are trademarks or registered trademarks of U.S. Microsoft Corporation in the U.S. and other countries.
- Macintosh and Mac OS are trademarks of Apple Computer, Inc in the U.S. and other countries.
- HDV and the HDV logo are trademarks of Sony Corporation and Victor Company of Japan, Ltd.
- Pentium is a trademark or registered trademark of Intel Corporation.

All other product names mentioned herein may be the trademarks or registered trademarks of their respective companies. Furthermore, TM and “®” are not mentioned in each case in this manual.