

SONY®

3-093-316-13(1)

Digital Video Camera Recorder

HANDYCAM®

Handycam Handbook

**DCR-SR32E/SR33E/SR42E/
SR52E/SR62E/SR72E/
SR82E/SR190E/SR200E/
SR290E/SR300E**

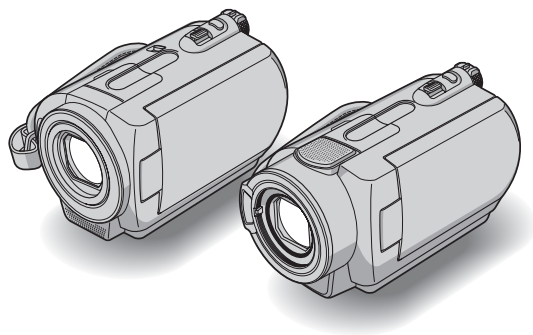

**Enjoying your
camcorder** 8

Getting Started 12

**Recording/
Playback** 20

Editing 38

Utilizing recording
media 49

Customizing your
camcorder 52

Performing with
a computer 73

Troubleshooting 94

Additional Information 108

Quick Reference 118



Read this before operating your camcorder

Before operating the unit, please read this Handbook thoroughly, and retain it for future reference.

Notes on use

Your camcorder is supplied with two kinds of operations guides.

For operating and handling the camcorder, refer to “Operating Guide” and “Handycam Handbook” (PDF/this Handbook).

Types of “Memory Stick” you can use in your camcorder

You can use “Memory Stick Duo” marked with MEMORY STICK DUO or MEMORY STICK PRO DUO (p. 111).

“Memory Stick Duo”
(This size can be used with your camcorder.)



“Memory Stick”
(You cannot use it in your camcorder.)



- You cannot use any type of memory card except “Memory Stick Duo.”
- “Memory Stick PRO” and “Memory Stick PRO Duo” can be used only with “Memory Stick PRO” compatible equipment.
- Do not attach a label or the like on a “Memory Stick Duo” or a Memory Stick Duo Adaptor.

When using a “Memory Stick Duo” with “Memory Stick” compatible equipment

Be sure to insert the “Memory Stick Duo” into the Memory Stick Duo Adaptor.

Memory Stick Duo Adaptor



On using the camcorder

- Do not hold the camcorder by the following parts.

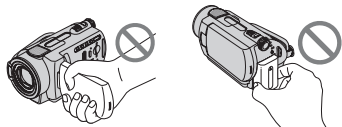

LCD screen

Battery

- The camcorder is not dustproofed, dripproofed or waterproofed. See “About handling of your camcorder” (p. 114).
- To prevent the hard disk from being broken or recorded images from being lost, do not do the following when either of the respective lamps of the POWER switch (p. 17) or the access lamp (p. 23, 27) is on:
 - to remove the battery pack or AC Adaptor from the camcorder.
 - to apply mechanical shock or vibration to the camcorder.
- Before connecting your camcorder to another device with a USB cable etc., be sure to insert the connector plug in the proper direction. If you insert the connector plug forcibly in the wrong direction, the terminal may be damaged, or this may cause a malfunction of your camcorder.
- Disconnect the AC Adaptor from the Handycam Station holding both the camcorder and the DC plug.
- Be sure to turn the POWER switch to OFF (CHG), when you set the camcorder onto the Handycam Station or remove the camcorder from it.

About menu items, LCD panel and lens

- A menu item that is grayed out is not available under the current recording or playback conditions.
- The LCD screen is manufactured using extremely high-precision technology, so over 99.99% of the pixels are operational for effective use. However, there may be some tiny black points and/or bright points (white, red, blue, or green in color) that appear constantly on the LCD screen. These points are normal results of the manufacturing process and do not affect the recording in any way.

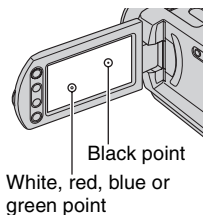

- Exposing the LCD screen or the lens to direct sunlight for long periods of time may cause malfunctions.
- Do not aim at the sun. Doing so might cause your camcorder to malfunction. Take images of the sun only in low light conditions, such as at dusk.

On recording

- Before starting to record, test the recording function to make sure the image and sound are recorded without any problems.
- Compensation for the contents of recordings cannot be provided, even if recording or playback is not possible due to a malfunction of the camcorder, recording media, etc.
- TV color systems differ depending on the countries/regions. To view your recordings on a TV, you need a PAL system-based TV.

- Television programs, films, video tapes, and other materials may be copyrighted. Unauthorized recording of such materials may be contrary to the copyright laws.
- You cannot play back both movies and still images other than the images recorded with your camcorder. You also cannot play back images recorded with other DCR-SR32E/SR33E/SR42E/SR52E/SR62E/SR72E/SR82E/SR190E/SR200E/SR290E/SR300E.

About language setting

The on-screen displays in each local language are used for illustrating the operating procedures. Change the screen language before using your camcorder if necessary (p. 18).

About this Handbook

- The LCD screens and indicators shown in this Handbook were taken with a digital still camera, and may look different from what you actually see.
- Design and specifications of recording media and other accessories are subject to change without notice.
- Unless otherwise specially indicated, illustrations in this Handbook are based on DCR-SR300E.

About the Carl Zeiss lens

Your camcorder is equipped with a Carl Zeiss lens, which was developed jointly by Carl Zeiss, in Germany, and Sony Corporation, and produces superior images. It adopts the MTF measurement system for video cameras and offers a quality typical of a Carl Zeiss lens. Also, the lens for DCR-SR190E/SR200E/SR290E/SR300E is T*_{coated} to suppress unwanted reflections, then faithfully reproduce colors.

MTF = Modulation Transfer Function. The number value indicates the amount of light from a subject coming into the lens.

Notes on using the Hard Disk Drive Handycam

Save all your recorded image data

- To prevent your image data from being lost, save all your recorded images on external media. It is recommended that you save the image data on a disc such as DVD-R using your computer (p. 77). Also, you can save your image data using a VCR, or a DVD/HDD recorder (p. 45).
- It is recommended that you save your image data periodically, after recording.

Do not apply shock or vibration to your camcorder

- The hard disk of the camcorder may not be recognized, or recording or playback may not be possible.
- Especially, during recording/playback, do not apply shock. After recording, do not apply vibration or shock to the camcorder, while the ACCESS lamp is lit.
- When using the shoulder belt (not supplied), do not crash the camera against an object.

On the drop sensor

- To protect the internal hard disk from the shock by dropping, the camcorder has the drop sensor function (p. 64). When a drop occurs, or under a non-gravity condition, the block noise to protect the camcorder may also be recorded. If the drop sensor catches a drop repeatedly, recording/playback may be stopped.

Notes on battery pack/AC Adaptor

- While the ACCESS lamp is lit, be sure to avoid the following. They may cause malfunctions.
 - Removing the battery pack
 - Removing the AC Adaptor (while charging the battery pack using the AC Adaptor)
- Be sure to remove the battery pack or the AC Adaptor after turning off the POWER switch.

Note on operating temperatures

- When the temperature of the camcorder becomes extremely high or extremely low, you may not be able to record or play back on the camcorder, due to the protection features of the camcorder being activated in such situations. In this case, a message appears on the LCD screen (p. 104).

When the camcorder is connected to a computer

- Do not try to format the hard disk of the camcorder using a computer. If you do so, your camcorder may not operate correctly.

Note on using the camcorder at high altitudes

- Do not turn on the camcorder in a low-pressure area, where the altitude is more than 3,000 meters (9,800 feet). Doing so may damage the hard disk drive of your camcorder.

Note on disposal/transfer

- If you perform [⊖ FORMAT] (p.49) or formatting the hard disk of the camcorder, you may not delete data from the hard disk completely. When you transfer the camcorder, it is recommended that you perform [⊖ EMPTY] (p.51) to prevent the recovery of your data.
In addition to the above, when you dispose of the camcorder, it is recommended that you destroy the actual body of the camcorder.



If you cannot record/play back images, perform [⊖FORMAT]

- If you repeat recording/deleting images for a long time, fragmentation of data occurs on the hard disk. Images cannot be saved or recorded. In such a case, save your images on some type of external media first (p. 37), and then perform [⊖FORMAT] (p. 49).
Fragmentation ☞ Glossary (p. 127)

Table of Contents

Read this before operating your camcorder	2
Notes on using the Hard Disk Drive Handycam	4
Subject examples and solutions	7

Enjoying your camcorder

Operation flow	8
“  HOME” and “  OPTION” - Taking advantage of two types of menus	9

Getting Started

Step 1: Checking supplied items	12
Step 2: Charging the battery pack	13
Step 3: Turning the power on, and setting the date and time	17
Changing the language setting	18
Step 4: Preparing for recording	19

Recording/Playback

Recording and playback with ease (Easy Handycam operation)	20
Recording	23
Zooming	25
Recording sound with more presence (5.1ch surround recording) (DCR-SR190E/SR200E/SR290E/SR300E)	25
Using the flash (DCR-SR190E/SR200E/SR290E/SR300E)	26
Capturing high quality still images during movie recording (Dual Rec) (DCR-SR190E/SR200E/SR290E/SR300E)	26
Recording still images on a “Memory Stick Duo”	27
Recording in dark places (NightShot plus/NightShot)	27

Adjusting the exposure for backlit subjects	28
Recording in mirror mode	28
Selecting the aspect ratio (16:9 or 4:3) of the recording image	28
Recording the fast action in slow-motion (SMTH SLW REC) (DCR-SR190E/SR200E/SR290E/SR300E)	29
Playback	31
Using PB zoom	33
Searching for desired images by date (Date Index)	33
Playing back a series of still images (Slide show)	34
Playing the image on a TV	35
Saving images	37





Editing

 (OTHERS) category	38
Deleting images	38
Dividing a movie	40
Copying still images	41
Creating the Playlist	42
Dubbing to VCR or DVD/HDD recorders	45
Printing recorded images (PictBridge compliant printer)	46

Utilizing recording media

 (MANAGE HDD/MEMORY) category	49
Formatting the hard disk or the “Memory Stick Duo”	49
Checking the hard disk information	50
Preventing data on the hard disk of the camcorder from being recovered	51

Customizing your camcorder

What you can do with the  (SETTINGS) category of the HOME MENU	52
Using the HOME MENU	52
List of the  (SETTINGS) category items	53
MOVIE SETTINGS	54
(Items for recording movies)	
PHOTO SETTINGS	57
(Items for recording still images)	
VIEW IMAGES SET	60
(Items to customize the display)	
SOUND/DISP SET	61
(Items to adjust beep and the screen)	
OUTPUT SETTINGS	62
(Items for when connecting other devices)	
CLOCK/  LANG	63
(Items to set clock and language)	
GENERAL SET	64
(Other setup items)	
Activating functions using the  OPTION MENU	65
Using the OPTION MENU	65
Recording items on the OPTION MENU	66
Viewing items on the OPTION MENU	66
Functions set in the OPTION MENU	67

Performing with a computer

What you can do with Windows computer	73
System requirements	74
Installing the software	75
Creating a DVD with One Touch	77
Importing images to a computer ...	81

Deleting images recorded on the camcorder through the computer (DCR-SR42E/SR62E/SR82E/SR200E/SR300E)	85
Viewing images imported to a computer	86
Editing the imported images	88
Creating and copying a DVD	90
Manipulating still images	93

Troubleshooting

Troubleshooting	94
Warning indicators and messages	104

Additional Information

Using your camcorder abroad	108
Files on the camcorder hard disk/folder structure	110
Maintenance and precautions	111

Quick Reference

Identifying parts and controls	118
Indicators displayed during recording/playback	123
Glossary	127
Index	128

Subject examples and solutions

Checking your golf swing



- ▶ SMTH SLW REC*29
- ▶ SPORTS** 69

Getting a good shot of a ski slope or beach



- ▶ Backlight28
- ▶ BEACH..... 69
- ▶ SNOW69

Capturing still images during movie recording



- ▶ Dual Rec*26

A child on the stage under a spot light



- ▶ SPOTLIGHT69

Flowers in close-up



- ▶ PORTRAIT69
- ▶ FOCUS67
- ▶ TELE MACRO67

Fireworks with all its splendor



- ▶ FIREWORKS69
- ▶ FOCUS67

Focusing on the dog on the left side of the screen



- ▶ FOCUS67
- ▶ SPOT FOCUS67

A sleeping child under dim light



- ▶ NightShot plus**27
- ▶ NightShot*27
- ▶ COLOR SLOW SHTR 70

* DCR-SR190E/SR200E/SR290E/SR300E

** DCR-SR32E/SR33E/SR42E/SR52E/SR62E/SR72E/SR82E

Operation flow

▶ Get ready (p. 12).

▶ Shoot using your camcorder (p. 23).

Movies are recorded on the hard disk, and still images are recorded on either the hard disk or a "Memory Stick Duo."



▶ Play back the images.

- Viewing on the LCD screen of your camcorder (p. 31)
- Viewing on the TV connected to your camcorder (p. 35)



▶ Save recorded images.

- Saving images on a DVD using a computer (p. 77)
- Importing images to a computer (p. 81)
- Dubbing images on VCR or DVD/HDD recorders (p. 45)



▶ Delete images.

If the hard disk of your camcorder is full, you cannot record new images. Delete the image data that has been saved on your camcorder. If you delete the images, you can record new images on the free hard disk space again.

- Deleting the selected images (p. 38)
- Deleting all the images ([ FORMAT], p. 49)

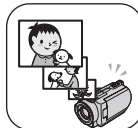

“HOME” and “OPTION”

- Taking advantage of two types of menus

“HOME MENU” - the starting point for operations with your camcorder

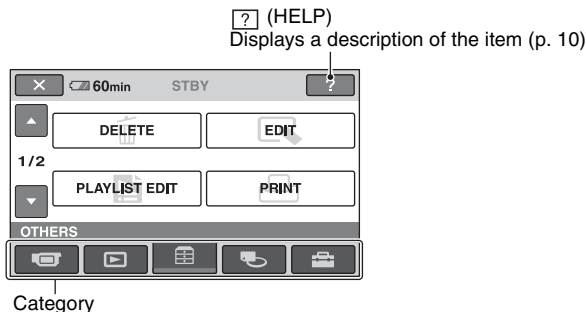

► Categories and items of the HOME MENU

(CAMERA) category

Item	Page
MOVIE*	24
PHOTO*	24
SMTH SLW REC**	29

(VIEW IMAGES) category

Item	Page
VISUAL INDEX*	31
PLAYLIST	42

(OTHERS) category

Item	Page
DELETE*	38
EDIT	40, 41
PLAYLIST EDIT	42
PRINT	46
COMPUTER	73

(MANAGE HDD/MEMORY) category

Item	Page
FORMAT*	49
FORMAT*	50
INFO	50

(SETTINGS) category

To customize your camcorder (p. 52)*.

* You can also set these items during Easy Handycam operation (p. 20). For the items available in the (SETTINGS) category, see page 53.

**DCR-SR190E/SR200E/SR290E/SR300E

Using the HOME MENU

- 1 While pressing the green button in the center, turn the POWER switch in the direction of the arrow to turn on the power.

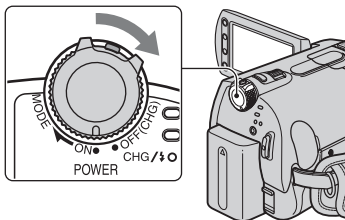

- 2 Press (HOME) (or).

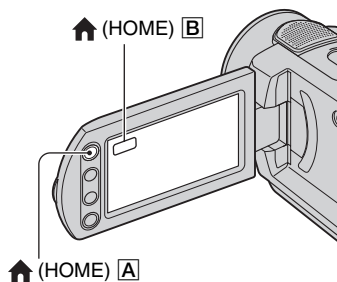

- 3 Touch the desired category.
Example: (OTHERS) category



- 4 Touch the desired item.

Example: [EDIT]

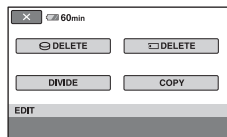

- 5 Follow the guide on the screen for further operation.

To hide the HOME MENU screen

Touch .

- ▶ When you want to know something about the function of each item on the HOME MENU - HELP

- 1 Press (HOME).

The HOME MENU appears.



- 2 Touch (HELP).

The bottom of the (HELP) button turns orange.



3 Touch the item you want to know the content.

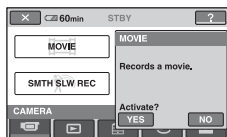

When you touch an item, its explanation appears on the screen.

To apply the option, touch [YES], otherwise, touch [NO].

To deactivate the HELP

Touch [?] (HELP) again in step 2.

Using the OPTION MENU

Just a touch on the screen during shooting or playback displays the functions available at that moment. You will find it easy to make various settings. See page 65 for further details.

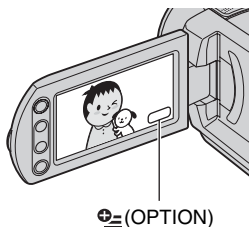

Step 1: Checking supplied items

Make sure that you have the following items supplied with your camcorder. The number in the parentheses indicates the number of that item supplied.

AC Adaptor (1) (p. 13)

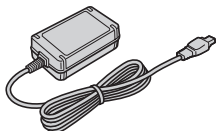

Mains lead (1) (p. 13)



Handycam Station (1) (p. 13)

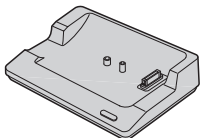

A/V connecting cable (1) (p. 35, 45)



USB cable (1) (p. 46, 78, 81)

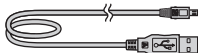

Wireless Remote Commander (1) (p. 122)
(except for DCR-SR32E/SR33E/SR42E)



A button-type lithium battery is already installed.

Rechargeable battery pack

NP-FH40 (1) (p. 13, 112) (DCR-SR32E/
SR33E/SR42E/SR52E/SR62E/SR72E/
SR82E)

NP-FH60 (1) (p. 13, 112) (DCR-SR190E/
SR200E/SR290E/SR300E)

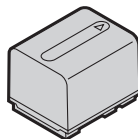

21-pin adaptor (p. 36)

For the model with the **CE** mark printed on their bottom surfaces only.

CD-ROM "Handycam Application
Software" (1) (p. 73)

- Picture Motion Browser (Software)
- Handycam Handbook (This Handbook)

Operating Guide (1)

Step 2: Charging the battery pack

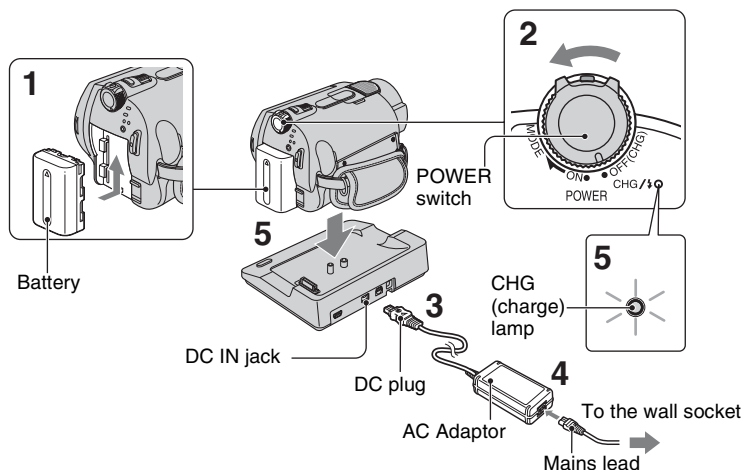

You can charge the “InfoLITHIUM” battery pack (H series) (p. 112) after attaching it to your camcorder.

Notes

- Your camcorder operates only with an “InfoLITHIUM” battery pack (H series).

1 Attach the battery pack by sliding it in the direction of the arrow until it clicks.

2 Turn the POWER switch in the direction of the arrow to OFF (CHG) (The default setting).

3 Connect the AC Adaptor to the DC IN jack on the Handycam Station.

Be sure that the ▲ mark on the DC plug is facing up.

4 Connect the mains lead to the AC Adaptor and the wall socket.

5 Set the camcorder onto the Handycam Station securely.

The CHG (charge) lamp lights up and charging starts.

The CHG (charge) lamp turns off when the battery pack is fully charged.

- When setting the camcorder onto the Handycam Station, close the DC IN jack cover.

To charge the battery pack using only the AC Adaptor

Turn the POWER switch to OFF (CHG), then connect the AC Adaptor directly to the DC IN jack on the camcorder.

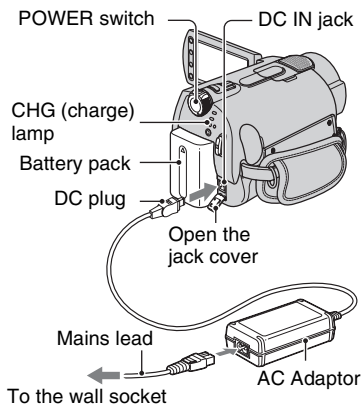

⚡ Notes



- Disconnect the AC Adaptor from the DC IN jack holding both the camcorder and the DC plug.

To remove the battery pack

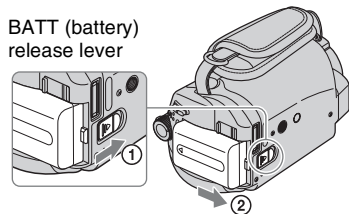
Turn the POWER switch to OFF (CHG). Slide the BATT (battery) release lever and remove the battery pack.



⚡ Notes

- When you remove the battery pack or the AC Adaptor, make sure that the  (Movie) lamp/ (Still) lamp (p. 23) is turned off.

To remove your camcorder from the Handycam Station

Turn off the power, then remove the camcorder from the Handycam Station holding both.

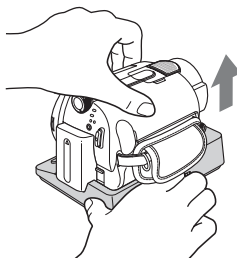

When storing the battery pack

Fully discharge the battery before storing it for an extended period (see page 113 for the details of storage).

To use an outside power source

Make the same connections as you do when charging the battery pack. The battery pack will not lose its charge in this case.

To check the remaining battery (Battery Info)

Set the POWER switch to OFF (CHG), then press DISP/BATT INFO.

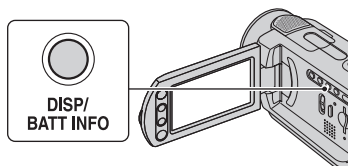

After a while, the approximate recordable time and battery information appear for about 7 seconds. You can view the battery information for up to 20 seconds by pressing DISP/BATT INFO again while the information is displayed.

Remaining battery (approx.)

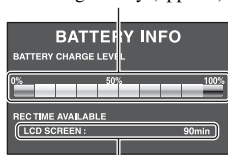

Recording capacity (approx.)

Charging time

Approximate time (min.) required when you fully charge a fully discharged battery pack.

Battery pack	Charging time
NP-FH40 (supplied*)	125
NP-FH50	135
NP-FH60 (supplied**)	135
NP-FH70	170
NP-FH100	390

* DCR-SR32E/SR33E/SR42E/SR52E/SR62E/SR72E/SR82E

** DCR-SR190E/SR200E/SR290E/SR300E

Recording time

Approximate time (min.) available when you use a fully charged battery pack.

DCR-SR32E/SR33E/SR42E:

Battery pack	Continuous recording time	Typical recording time*
NP-FH40 (supplied)	105	50
NP-FH50	125	60
NP-FH70	270	135
NP-FH100	615	305

DCR-SR52E/SR62E/SR72E/SR82E:

Battery pack	Continuous recording time	Typical recording time*
NP-FH40 (supplied)	90	45
NP-FH50	105	50
	115	55
NP-FH70	230	115
	245	120
NP-FH100	525	260
	565	280

DCR-SR190E/SR200E:

Battery pack	Continuous recording time	Typical recording time*
NP-FH50	85	40
	90	45
NP-FH60 (supplied)	115	55
	125	60
NP-FH70	190	95
	200	100
NP-FH100	440	220
	465	230

DCR-SR290E/SR300E:

Battery pack	Continuous recording time	Typical recording time*
NP-FH50	75	35
	80	40
NP-FH60 (supplied)	100	50
	105	50
NP-FH70	160	80
	170	85
NP-FH100	375	185
	395	195

* Typical recording time shows the time when you repeat recording start/stop, turning the power on/off and zooming.

Notes

- All times measured with recording mode [SP] under the following conditions:
Top: When the LCD backlight turns on.
Bottom: When the LCD backlight turns off (except for DCR-SR32E/SR33E/SR42E).

Playback time

Approximate time (min.) available when you use a fully charged battery pack.

DCR-SR32E/SR33E/SR42E:

Battery pack	Playback time
NP-FH40 (supplied)	120
NP-FH50	140
NP-FH70	300
NP-FH100	695

DCR-SR52E/SR62E/SR72E/SR82E:

Battery pack	Playback time*
NP-FH40 (supplied)	110
NP-FH50	130
NP-FH70	280
NP-FH100	635

DCR-SR190E/SR200E:



Battery pack	Playback time*
NP-FH50	125
NP-FH60 (supplied)	165
NP-FH70	270
NP-FH100	615

DCR-SR290E/SR300E:

Battery pack	Playback time*
NP-FH50	120
NP-FH60 (supplied)	160
NP-FH70	255
NP-FH100	590

* When the LCD backlight is on.

On the battery pack

- Before changing the battery pack, turn the POWER switch to OFF (CHG) and turn off the  (Movie) lamp/ (Still) lamp (p. 23).
- The CHG (charge) lamp flashes during charging, or Battery Info (p. 14) will not be correctly displayed under the following conditions:
 - The battery pack is not attached correctly.
 - The battery pack is damaged.
 - The battery pack is worn-out (For Battery Info only).
- The power will not be supplied from the battery as long as the AC Adaptor is connected to the DC IN jack of your camcorder or the Handycam Station, even when the mains lead is disconnected from the wall socket.
- When attaching an optional video light, it is recommended that you use an NP-FH70/FH100 battery pack (except for DCR-SR32E/SR33E/SR42E).
- We do not recommend using an NP-FH30, which only allows short recording and playback times, with your camcorder.

On the charging/recording/playback time

- Times measured when using the camcorder at 25 °C (77 °F) (10 °C to 30 °C (50 °F to 86 °F) is recommended).
- The available recording and playback time will be shorter when you use your camcorder in low temperatures.
- The available recording and playback time will be shorter depending on the conditions under which you use your camcorder.

Step 3: Turning the power on, and setting the date and time

On the AC Adaptor

- Use the nearby wall socket when using the AC Adaptor. Disconnect the AC Adaptor from the wall socket immediately if any malfunction occurs while using your camcorder.
- Do not use the AC Adaptor placed in a narrow space, such as between a wall and furniture.
- Do not short-circuit the DC plug of the AC Adaptor or battery terminal with any metallic objects. This may cause a malfunction.
- Even if your camcorder is turned off, AC power (mains) is still supplied to it while connected to the wall socket via the AC Adaptor.

Set the date and time when using this camcorder for the first time. If you do not set the date and time, the [CLOCK SET] screen appears every time you turn on your camcorder or change the POWER switch position.

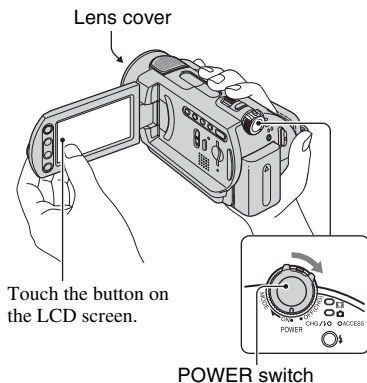

- 1 While pressing the green button, turn the **POWER** switch repeatedly in the direction of the arrow until the respective lamp lights up.

 **(Movie):** To record movies

 **(Still):** To record still images

The [CLOCK SET] screen appears.

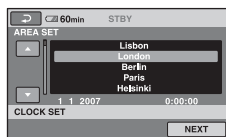

- 2 Select the desired geographical area with **▲/▼**, then touch [NEXT].

3 Set [SUMMERTIME], then touch [NEXT].

4 Set [Y] (year) with ▲/▼.



5 Select [M] with ◀/▶, then set the month with ▲/▼.

6 Set [D] (day), hour and minute in the same way, then touch [NEXT].

7 Make sure that the clock is correctly set, then touch [OK].



The clock starts.

You can set any year up to the year 2037.

To turn off the power

Turn the POWER switch to OFF (CHG).

To reset the date and time

Touch  (HOME) →  (SETTINGS) → [CLOCK/ALANG] → [CLOCK SET], and set the date and time.

Notes



- If you do not use your camcorder for **about 3 months**, the built-in rechargeable battery gets discharged and the date and time settings may be cleared from the memory. In that case, charge the built-in rechargeable battery and then set the date and time again (p. 116).

- It takes a few seconds for your camcorder to be ready to shoot after the power is turned on. You cannot operate your camcorder during this time.
- The lens cover opens automatically when the power is turned on (DCR-SR190E/SR200E/SR290E/SR300E). It closes when the playback screen is selected, or the power is turned off.
- In the setting at the time of purchase, the power turns off automatically if you leave your camcorder without any operation attempted for approximately 5 minutes, to save battery power ([A.SHUT OFF], p. 64).

💡 Tips

- The date and time does not appear during recording, but they are automatically recorded on the hard disk, and can be displayed during playback ([DATA CODE], p. 60).
- Refer to page 109 for information concerning “World time difference.”
- If the buttons on the touch panel do not work correctly, adjust the touch panel (CALIBRATION) (p. 115).

Changing the language setting

You can change the on-screen displays to show messages in a specified language. Touch  (HOME) →  (SETTINGS) → [CLOCK/ALANG] → [ALANGUAGE SET], then select the desired language.

Step 4: Preparing for recording

Opening the lens cover manually (DCR-SR32E/SR33E/SR42E/SR52E/SR62E/SR72E/SR82E)

Slide the lens cover switch to open.

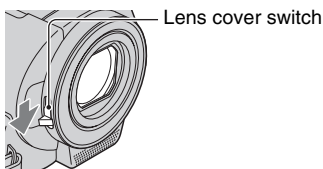

💡 Tips

- When you finish recording or when you playback images, close the lens cover.
- For DCR-SR190E/SR200E/SR290E/SR300E, the lens cover opens and closes automatically.

Adjusting the LCD panel

Open the LCD panel 90 degrees to the camcorder (①), then rotate it to the best angle to record or play (②).

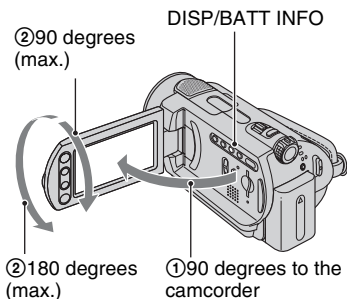

To turn off the LCD backlight to make the battery last longer (except for DCR-SR32E/SR33E/SR42E)

Press and hold DISP/BATT INFO for a few seconds until L_{OFF} appears.

This setting is practical when you use your camcorder in bright conditions or when you want to save battery power. The recorded image will not be affected by the setting. To turn on the LCD backlight, press and hold DISP/BATT INFO for a few seconds until L_{OFF} disappears.

🔔 Notes

- Do not press the buttons on the LCD frame accidentally when you open or adjust the LCD panel.

💡 Tips

- If you open the LCD panel 90 degrees to the camcorder, then rotate it 180 degrees to the lens side, you can close the LCD panel with the LCD screen facing out. This is convenient during playback operations.
- Touch HOME (HOME) → SETTINGS (SETTINGS) → [SOUND/DISP SET] → [LCD BRIGHT] (p. 61), and adjust the brightness of the LCD screen.
- The information is displayed or hidden (display \leftrightarrow no display) each time you press DISP/BATT INFO.

Fastening the grip belt

Fasten the grip belt and hold your camcorder correctly.

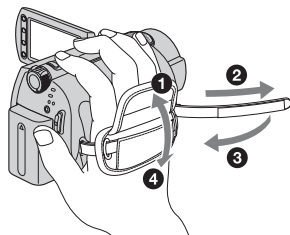



Recording and playback with ease (Easy Handycam operation)

Easy Handycam operation makes nearly all settings automatic so that you can perform recording or playback operation without detailed settings. It also makes screen font size larger for easy viewing.

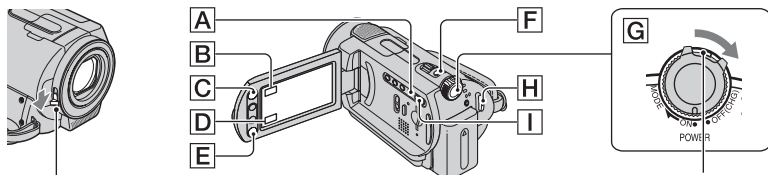

Open the lens cover (DCR-SR32E/SR33E/SR42E/SR52E/SR62E/SR72E/SR82E) (p. 19)

If the POWER switch is set to OFF (CHG), turn it while pressing the green button.

Recording movies



- 1 Turn the POWER switch **G** until the  (Movie) lamp lights up.



- 2 Press EASY **A**.



EASY appears on the LCD screen.

- 3 Press START/STOP **H** (or **E**) to start recording.*

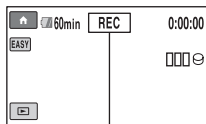

[STBY] → [REC]

To stop recording, press START/STOP again.

Recording still images



Still images are recorded on the hard disk in the default setting. You can change the recording media of still images to a "Memory Stick Duo" (p. 27).

- 1 Turn the POWER switch **G** until the  (Still) lamp lights up.



- 2 Press EASY **A**.



EASY appears on the LCD screen.

- 3 Press PHOTO **F** lightly to adjust the focus **A** (a beep sounds), then press it fully **B** (a shutter click sounds).**

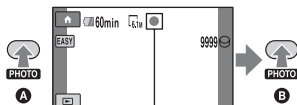

Flashing → Lights up

* The setting of [REC MODE] is fixed to [SP] (p. 54).

** The setting of [QUALITY] is fixed to [FINE] (p. 58).

Playing back recorded movies/still images

1 Turn the POWER switch **G** to turn on your camcorder.

2 Press **VIEW IMAGES** **I** (or **D**) button

The VISUAL INDEX screen appears on the LCD screen. (It may take some time to display the thumbnails.)

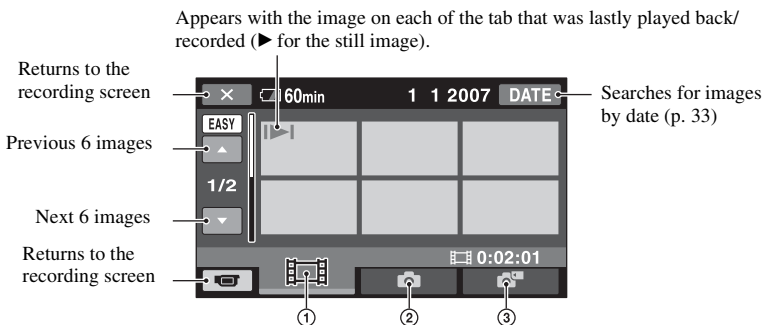

- ① :Displays movies.
- ② :Displays still images on the hard disk.
- ③ :Displays still images on a "Memory Stick Duo."

3 Start playback.

Movies:

Touch the tab and the movie to be played back.

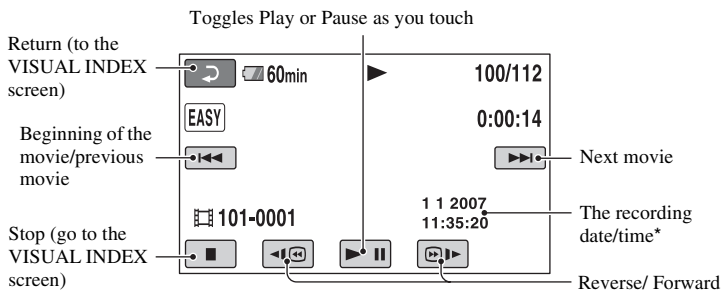

* The setting of [DATA CODE] is fixed to [DATE/TIME] (p. 60).

💡 Tips

- When playback from the selected movie reaches the last movie, the screen returns to the VISUAL INDEX screen.
- You can slow down the playback speed by touching [⏮] / [⏪] during pause.
- You can adjust volume by selecting [🏠] (HOME) → [⚙️] (SETTINGS) → [SOUND SETTINGS] → [VOLUME], then with [−] / [+].

Still images:

Touch the [📷], or [🖼️] tab and the still image to be played back.

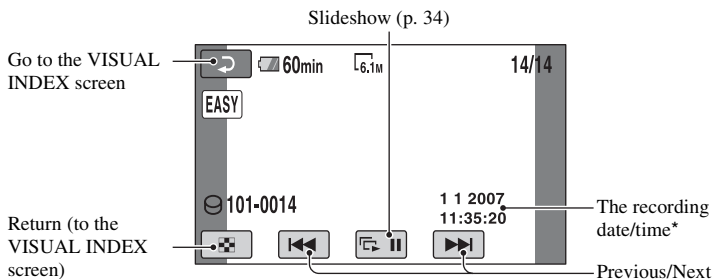

* The setting of [DATA CODE] is fixed to [DATE/TIME] (p. 60).

To cancel Easy Handycam operation

Press EASY [A] again. [EASY] disappears from the LCD screen.

Menu settings during Easy Handycam operation

Press [🏠] (HOME) [C] (or [B]) to display the menu items available for setup changes (p. 9, 53).

🔔 Notes

- Most of the menu items automatically return to the default settings. The settings of some menu items are fixed. For details, see page 95.
- You cannot use [OPTION] menu.
- Cancel Easy Handycam operation if you want to add effects to images or change settings.

Invalid buttons during Easy Handycam operation

You cannot use some buttons/functions during Easy Handycam operation since they are automatically set (p. 95). If you set an invalid operation, [Invalid during Easy Handycam operation] may appear.

Recording

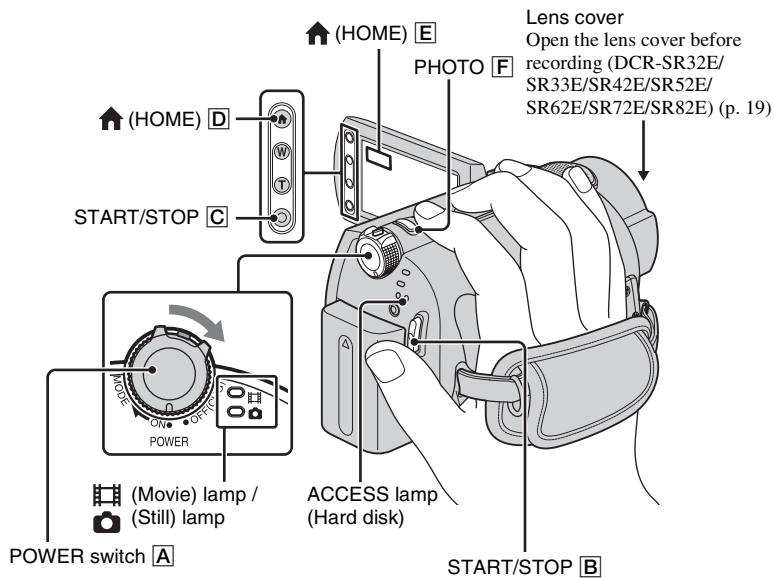

Notes

- If the ACCESS lamp is lit or flashing after recording is finished, it means data is still being written onto the hard disk or “Memory Stick Duo.” Do not apply shock or vibration to your camcorder, and do not remove the battery or AC Adaptor.
- The maximum continuous recordable time is approximately 13 hours.
- When a movie file exceeds 2 GB, the next movie file is created automatically.

Tips

- You can check the free hard disk space by touching (HOME) → (MANAGE HDD/MEMORY) → [INFO] (p. 50).

Recording movies



You can record movies on the hard disk of your camcorder. For the recordable time, see page 54.

1 Turn the **POWER** switch **A** until the (Movie) lamp lights up.

2 Press **START/STOP** **B** (or **C**).

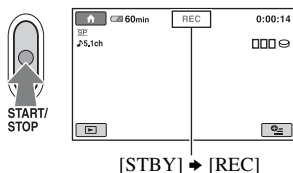

To stop recording, press **START/STOP** again.

Recording still images



You can record still images on the hard disk of your camcorder in the default setting. To record still images on a “Memory Stick Duo,” change the recording media. For the number of recordable still images, see page 57.

1 Turn the **POWER** switch **A** until the (Still) lamp lights up.

2 Press **PHOTO** **F** lightly to adjust the focus **A** (a beep sounds), then press it fully **B** (a shutter click sounds).

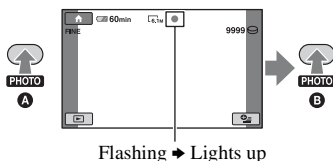

When disappears, the image has been recorded.

To switch the shooting mode using the **HOME** **D** (or **E**) button

On the **HOME** MENU, touch (CAMERA) → [MOVIE] or [PHOTO].

To capture high resolution still images during recording a movie (Dual Rec) (DCR-SR190E/SR200E/SR290E/SR300E)

→ For details, see page 26.

To change the recording media of still images

→ For details, see page 27.

Zooming

You can zoom in up to the magnifications shown in the following table.

	(optical zoom)
DCR-SR32E/SR33E/SR42E	40 ×
DCR-SR52E/SR62E/SR72E/SR82E	25 ×
DCR-SR190E/SR200E/SR290E/SR300E	10 ×

You can adjust the magnifications with the power zoom lever or the zoom buttons on the LCD frame.

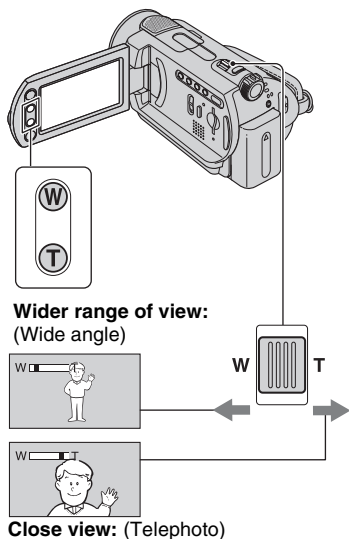

Move the power zoom lever slightly for a slower zoom. Move it further for a faster zoom.

Notes

- [STEADYSHOT] may not reduce image blurring as desired when the power zoom lever is set to the T (Telephoto) side (except for DCR-SR290E/SR300E).
- Be sure to keep your finger on the power zoom lever. If you move your finger off the power zoom lever, the operation sound of the lever may also be recorded.

- You cannot change the zoom speed with the zoom buttons on the LCD frame.
- The minimum possible distance between camcorder and subject while maintaining sharp focus is about 1 cm (about 13/32 in.) for wide angle and about 80 cm (about 2 5/8 feet) for telephoto.

Tips

- Using [DIGITAL ZOOM] (p. 55) let you zoom in further than the magnification shown in the table.

Recording sound with more presence (5.1ch surround recording) (DCR-SR190E/SR200E/SR290E/SR300E)

Sound picked up by the built-in microphone is converted to 5.1ch surround sound and recorded.

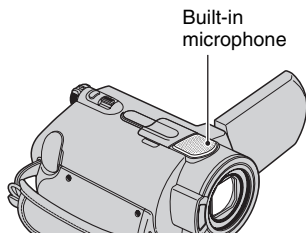

Your camcorder has Dolby Digital 5.1 Creator installed for recording 5.1ch surround sound. Enjoy realistic sound when playing the movie on devices that support 5.1ch surround sound.

Dolby Digital 5.1 Creator, 5.1ch surround sound
☞ Glossary (p. 127)

Notes

- 5.1ch sound is converted to 2ch when played back on your camcorder.
- 5.1ch is displayed on the screen during 5.1ch recording/playback.

Using the flash (DCR-SR190E/ SR200E/SR290E/SR300E)

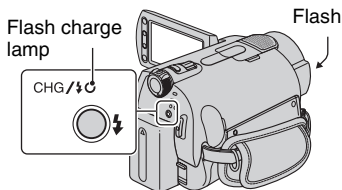

Press **⚡** (flash) repeatedly to select an appropriate setting.

No indication (Auto flash): Automatically flashes when there is insufficient ambient light.



⚡ (Forced flash): Always uses the flash regardless of the surrounding brightness.



⊕ (No flash): Records without flash.

⚡ Notes

- The recommended distance to the subject when using the built-in flash is approximately 0.3 to 2.5 m (1 to 8 feet).
- Remove any dust from the surface of the flash lamp before using it. Flash effect may be impaired if heat discoloration or dust obscures the lamp.
- The flash charge lamp flickers while charging the flash, and remains lit when the battery charge is complete.
- If you use the flash in bright places such as when shooting a backlit subject, the flash may not be effective.
- When attaching a conversion lens (optional) or a filter (optional) to your camcorder, the flash light does not emit light.

💡 Tips

- You can change the brightness of the flash by setting [FLASH LEVEL] (p. 59), or you can prevent the redeye by setting [REDEYE REDUC] (p. 59).

Capturing high quality still images during movie recording (Dual Rec) (DCR-SR190E/ SR200E/SR290E/SR300E)

You can capture high quality still images while recording a movie on the hard disk.

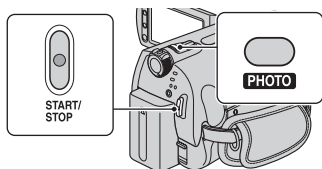

- ① Turn the POWER switch until the **⏏** (Movie) lamp lights up, then press START/STOP to start movie recording.

- ② Press PHOTO fully.

After you start recording, and before you finish, you can capture up to 3 frames of still images from your movie.



Orange color boxes indicate the number of captured images. When capturing is finished, the color changes to orange.

- ③ Press START/STOP to stop movie recording.

Captured still images appear one by one, and the images are recorded. When **|||||** disappears, the image has been recorded.

⚡ Notes

- When you record still images on a “Memory Stick Duo,” do not eject the “Memory Stick Duo” before recording a movie is finished and the still images are recorded on it.
- You cannot use the flash during Dual Rec.

💡 Tips

- Still images are recorded in the following sizes with Dual Rec.

DCR-SR190E/SR200E:

-  2.3M (16:9 (wide))
- 1.7M (4:3)

DCR-SR290E/SR300E:

-  4.6M (16:9 (wide))
- 3.4M (4:3)

- You can record still images during recording standby in the same way as when the POWER switch is set to  (Still). You can also record with the flash.

Recording still images on a "Memory Stick Duo"

You can change the recording media of still images to a "Memory Stick Duo." In the default setting, still images are recorded on the hard disk of the camcorder.

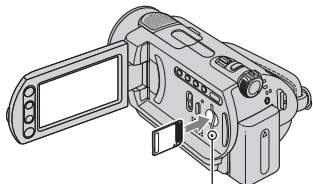

You can use only a "Memory Stick Duo" marked with **MEMORY STICK DUO** or **MEMORY STICK PRO DUO** (p. 111).





ACCESS lamp
("Memory Stick Duo")

Open the LCD panel, then insert the "Memory Stick Duo" into the Memory Stick Duo slot in the right direction until it clicks.

To change the recording media of still images

- ① Touch  (OPTION) →  tab → [STILL MEDIA].

- ② Select the media in which you want to save still images, then touch .
Your camcorder returns to recording standby mode. If you select [MEMORY STICK],  appears on the screen.

To eject a "Memory Stick Duo"

Open the LCD panel, lightly push the "Memory Stick Duo" in once.

⚠ Notes

- Do not try to force the "Memory Stick Duo" out. Doing so may result in damage.
- When the ACCESS lamp is lit or flashing, your camcorder is reading/writing data. Do not shake or knock your camcorder, turn the power off, eject the "Memory Stick Duo," or remove the battery pack. Otherwise, image data may be damaged.
- If you insert the "Memory Stick Duo" into the slot in the wrong direction, the "Memory Stick Duo," the "Memory Stick Duo" slot, or image data may be damaged.

💡 Tips

- The number of recordable images varies depending on the image quality or the image size. For details, see page 57.

Recording in dark places (NightShot plus/NightShot)

DCR-SR32E/SR33E/SR42E/SR52E/SR62E/SR72E/SR82E:

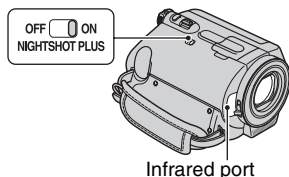

Set the NIGHTSHOT PLUS switch to ON. ( appears.)

Notes

- The NightShot plus and Super NightShot plus functions use infrared light. Therefore, do not cover the infrared port with your fingers or other objects, and remove the conversion lens (optional).
- Adjust the focus manually ([FOCUS], p. 67) when it is hard to focus automatically.
- Do not use the NightShot plus and Super NightShot plus functions in bright places. This may cause a malfunction.

Tips

- To record an image brighter, use Super NightShot plus function (p. 70). To record an image more faithfully to the original colors, use Color Slow Shutter function (p. 70).

DCR-SR190E/SR200E/SR290E/SR300E:

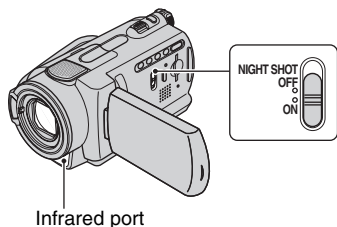

Set the NIGHTSHOT switch to ON. ( appears.)

Notes

- The NightShot and Super NightShot functions use infrared light. Therefore, do not cover the infrared port with your fingers or other objects, and remove the conversion lens (optional).
- Adjust the focus manually ([FOCUS], p. 67) when it is hard to focus automatically.
- Do not use the NightShot and Super NightShot functions in bright places. This may cause a malfunction.

Tips

- To record an image brighter, use Super NightShot function (p. 70). To record an image more faithfully to the original colors, use Color Slow Shutter function (p. 70).

Adjusting the exposure for backlit subjects

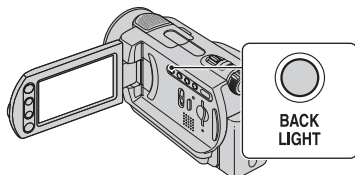

To adjust the exposure for backlit subjects, press **BACK LIGHT** to display . To cancel the back light function, press **BACK LIGHT** again.

Recording in mirror mode

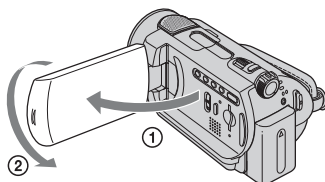

Open the LCD panel 90 degrees to the camcorder (1), then rotate it 180 degrees to the lens side (2).

Tips

- A mirror-image of the subject appears on the LCD screen, but the image will be normal when recorded.

Selecting the aspect ratio (16:9 or 4:3) of the recording image

To select the aspect ratio of the movies

DCR-SR32E/SR33E/SR42E:

- 1 Turn the **POWER** switch until the  (Movie) lamp lights up.

- On the HOME MENU, touch  (SETTINGS) → [MOVIE SETTINGS] → [WIDE SELECT] → [4:3] or [16:9 WIDE] (p. 54).

DCR-SR52E/SR62E/SR72E/SR82E/SR190E/SR200E/SR290E/SR300E:

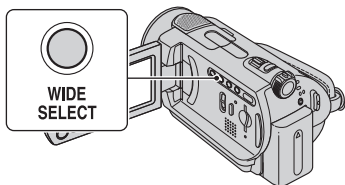

- Turn the POWER switch until the  (Movie) lamp lights up.
- Press WIDE SELECT repeatedly to select the desired screen aspect ratio.

Notes



- Differences in the angle of view between 16:9 (wide) and 4:3 vary depending on the zoom position.
- When you view the movie on a TV, set [TV TYPE] to [16:9] or [4:3] according to your TV (16:9/4:3) (p. 62).
- When you view 16:9 (wide) images with [TV TYPE] set to [4:3], they may appear rough depending on subjects.

To select the aspect ratio of the still images (except for DCR-SR32E/SR33E/SR42E)

- Turn the POWER switch until the  (Still) lamp lights up. The aspect ratio changes to 4:3 automatically.
- Press WIDE SELECT repeatedly to select the desired screen aspect ratio.

Notes

- For DCR-SR52E/SR62E/SR72E/SR82E, the size of still images is [ 0.7M] (16:9 (wide)) or [1.0M] (4:3) at maximum.

- For DCR-SR190E/SR200E, the size of still images is [ 3.0M] (16:9 (wide)) or [4.0M] (4:3) at maximum.
- For DCR-SR290E/SR300E, the size of still images is [ 4.6M] (16:9 (wide)) or [6.1M] (4:3) at maximum.



Tips

- For the number of recordable still images, see page 57.

Recording the fast action in slow-motion (SMTH SLW REC) (DCR-SR190E/SR200E/SR290E/SR300E)

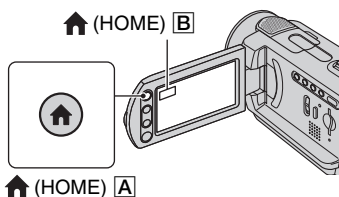
Fast moving subjects and actions, which cannot be captured under the ordinary shooting conditions, can be shot in smooth moving slow-motion for about 3 seconds. This is useful to shoot fast actions such as a golf or tennis swing.



- Turn the POWER switch to turn on the camcorder.
- Press  (HOME) [A] (or [B]) to display the HOME MENU.
- Touch  (CAMERA).
- Touch [SMTH SLW REC].





⑤ Press START/STOP.

An about 3 second-movie is recorded as a 12 second-slow-motion-movie.

When [Recording...] disappears, recording is finished.

Touch  to cancel the smooth slow recording.

To change the setting

Touch  (OPTION) →  tab, then select the setting you want to change.

• [TIMING]

Select the recording start point after START/STOP is pressed. The default setting is [3sec AFTER].

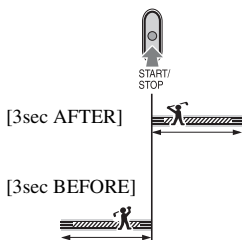

• [RECORD SOUND]

Select [ON] () to superimpose sounds such as conversation on the slow motion pictures (The default setting is [OFF]). Your camcorder records sounds for about 12 seconds while [Recording...] is displayed in step ⑤.

🔊 Notes

- Sounds are not recorded during the about 3 second-movie shooting.
- Image quality of [SMTH SLW REC] is not as good as that of normal recording.

Playback

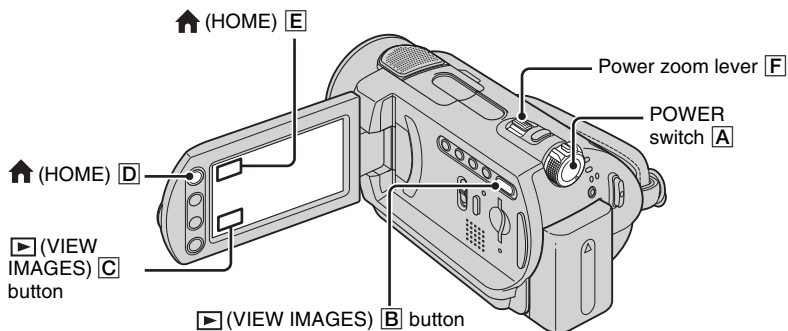

1 Turn the POWER switch **A** to turn on your camcorder.

2 Press ▶ (VIEW IMAGES) **B** (or **C**) button.

The VISUAL INDEX screen appears on the LCD screen. (It may take some time to display the thumbnails.)

Appears with the image on each of the tab that was lastly played back/recorded (▶ for the still image).

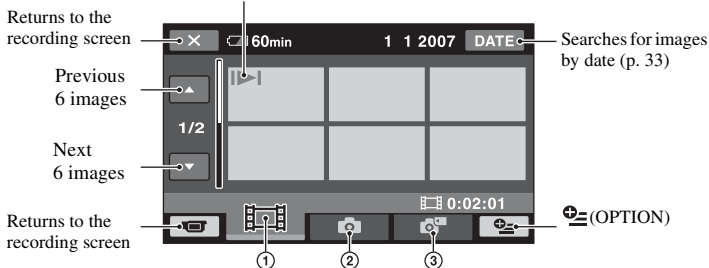

① : Displays movies.

② : Displays still images on the hard disk.

③ : Displays still images on a “Memory Stick Duo.”

💡 Tips

- Moving the power zoom lever **F** let you select whether to display 6 or 12 images on the VISUAL INDEX screen. To fix this number, touch (SETTINGS) on the HOME MENU → [VIEW IMAGES SET] → [DISPLAY] (p. 61).

3 Start playback.

Movies



Touch the tab, and the movie to be played back.

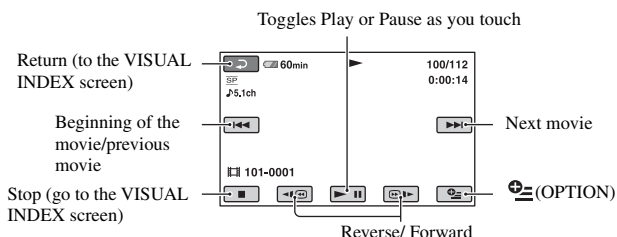

Still images



Touch the , or tab, and the still image to be played back.

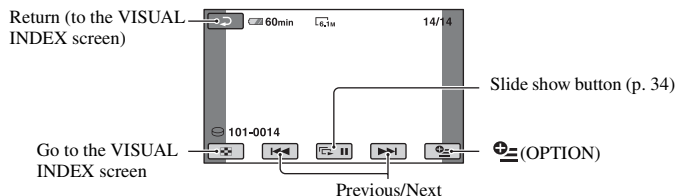

To switch to the playback mode using the (HOME) (or)

On the HOME MENU, touch (VIEW IMAGES) → [VISUAL INDEX].

To adjust the sound volume of movies

Touch (OPTION) → tab → [VOLUME], then adjust the volume with / .

Tips

- When playback from the selected movie reaches the last movie, the screen returns to the VISUAL INDEX screen.
- Touch / during pause to play back movie slowly.
- One touch of / makes the reverse/fast forward approximately 5 times faster, 2 touches makes it approximately 10 times faster, 3 touches makes it approximately 30 times faster, and 4 touches makes it approximately 60 times faster.

Using PB zoom

You can magnify still images from about 1.1 to 5 times the original size. Magnification can be adjusted with the power zoom lever or the zoom buttons on the LCD frame.

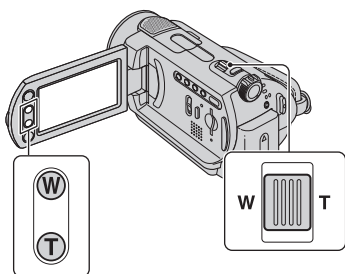





- 1 Play back the still images you want to magnify.
- 2 Magnify the still image with T (Telephoto).
The screen is framed.
- 3 Touch the screen at the point you want to display in the center of the displayed frame.
- 4 Adjust the magnification with W (Wide angle)/T (Telephoto).

To cancel, touch .

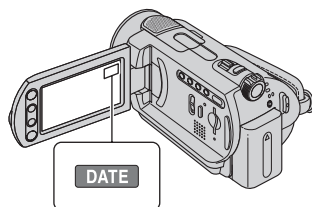
Searching for desired images by date (Date Index)

You can search for desired images by date efficiently.



- 1 Turn the POWER switch to turn on the camcorder, and press  (VIEW IMAGES) button.
The VISUAL INDEX screen appears on the LCD screen.
- 2 To search for movies, touch  tab. To search for still images, touch  tab.
 - You cannot search for images recorded on "Memory Stick Duo" by date.
- 3 Touch [DATE].
The recording dates of images are displayed on the screen.

Return to the VISUAL INDEX screen

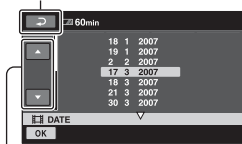

Previous/Next Date button

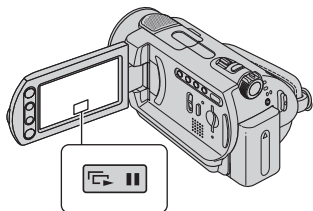

- 4 Touch Previous/Next Date button to select the date of the desired image.
- 5 Touch  while the selected date of the desired image is highlighted.
The images for selected date are displayed on the VISUAL INDEX screen.

Playing back a series of still images (Slide show)



Touch  on the still image playback screen.



The slide show begins from the selected image.

Touch  to stop the slide show. To restart, touch  again.

Notes

- You cannot operate playback zoom during slide show.

Tips

- You can set continuous slide show playback by selecting  (OPTION) →  tab → [SLIDE SHOW SET]. The default setting is [ON] (continuous playback).

Playing the image on a TV

Connect your camcorder to the input jack of TV or VCR using A/V connecting cable **1** or A/V connecting cable with S VIDEO **2**. Connect your camcorder to the wall socket using the supplied AC Adaptor for this operation (p. 13). Refer also to the instruction manuals supplied with the devices to be connected.

- To view the recorded images on a computer, see page 73.

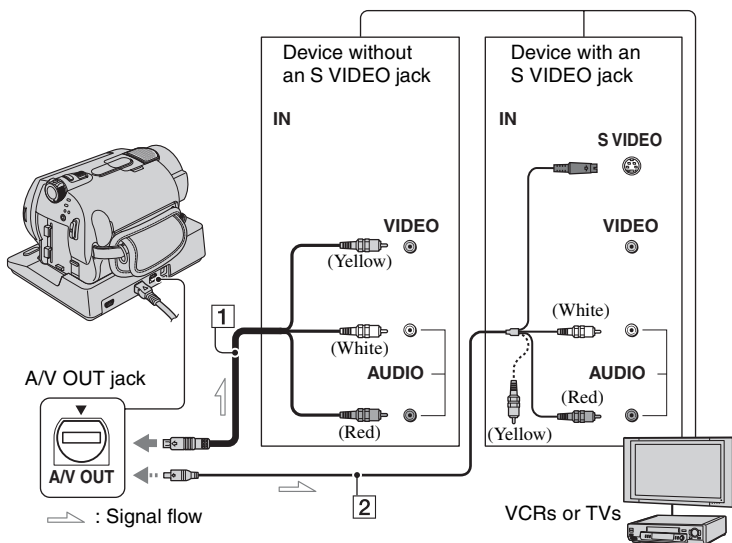

1 A/V connecting cable (supplied)

The Handycam Station and your camcorder are both equipped with A/V OUT jacks (p. 120, 121). Connect the A/V connecting cable either to the Handycam Station or to your camcorder, according to your setup.

2 A/V connecting cable with S VIDEO (optional)

When connecting to another device via the S VIDEO jack, by using an A/V connecting cable with an S VIDEO cable (optional), higher quality images can be produced than with an A/V connecting cable. Connect the white and red plug (left/right audio) and the S VIDEO plug (S VIDEO channel) of the A/V connecting cable with an S VIDEO cable (optional). The yellow plug connection is not necessary. S VIDEO connection only will not output audio.

Notes

- Do not connect A/V connecting cables to both your camcorder and the Handycam Station at the same time. The image might get disturbed.

Tips

- You can display the counter on the TV screen by setting [DISP OUTPUT] to [V-OUT/PANEL] (p. 63).

When your TV is connected to a VCR

Connect your camcorder to the LINE IN input on the VCR. Set the input selector on the VCR to LINE (VIDEO 1, VIDEO 2, etc.), if the VCR has an input selector.

To set the aspect ratio according to the connected TV (16:9/4:3)

Change the setting according to the screen aspect ratio of the TV you will view images on.

- ① Turn the POWER switch to turn on the camcorder.
- ② Touch **HOME** → **SETTINGS** → [OUTPUT SETTINGS] → [TV TYPE] → [16:9] or [4:3] → **OK**.

Notes

- When you set [TV TYPE] to [4:3], the image quality may deteriorate. Also, when the recorded image's aspect ratio switches between 16:9 (wide) and 4:3, the image may jitter.
- On some 4:3 TVs, the still images recorded in 4:3 aspect ratio may not be displayed full screen. This is not a malfunction.



- When you play back an image recorded in 16:9 (wide) aspect ratio on a 4:3 TV not compatible with the 16:9 (wide) signal, set [TV TYPE] to [4:3].

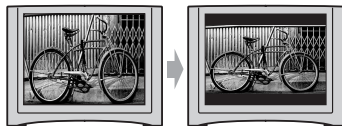

When your TV is monaural (When your TV has only one audio input jack)

Connect the yellow plug of the A/V connecting cable to the video input jack and connect the white (left channel) or red (right channel) plug to the audio input jack of your TV or VCR. When you want to play the sound in monaural mode, use a connecting cable for that purpose.

If your TV/VCR has a 21-pin adaptor (EUROCONNECTOR)

Use the 21-pin adaptor supplied with your camcorder (For models with the **CE** mark printed on their bottom surfaces only). This adaptor is designed for output use only.

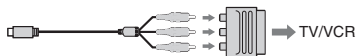

Saving images

Recorded images are stored on the internal hard disk of your camcorder. Due to the limited capacity of the internal hard disk, make sure that you save the image data to some type of external media such as a DVD-R or a computer.

You can save the images recorded on the camcorder as described below.

Saving images using a computer

By using the software on the supplied CD-ROM, you can save images on a DVD or the hard disk of a computer.

Creating a DVD with One Touch (One Touch Disc Burn)

You can save images recorded on the camcorder directly to a DVD with ease.



See “Creating a DVD with One Touch” on page 77.

Saving images on a computer

You can save images recorded on the camcorder on the hard disk of a computer.



See “Importing images to a computer” on page 81.

Creating a DVD with selected images

You can save images imported to your computer on a DVD. You can also edit those images.



See “Creating and copying a DVD” on page 90.

Saving images by connecting your camcorder to other devices

Dubbing to VCR or DVD/HDD devices



See “Dubbing to VCR or DVD/HDD recorders” on page 45.



(OTHERS) category

This category enables you to edit the images, to print still images and to connect your camcorder to a computer.



(OTHERS) category

Item list

DELETE

You can delete images on the hard disk or a “Memory Stick Duo” (p. 38).

EDIT

You can edit the images on the hard disk or a “Memory Stick Duo” (p. 40, 41).

PLAYLIST EDIT

You can create and edit a Playlist (p. 42).

PRINT

You can print still images on a connected PictBridge printer (p. 46).

COMPUTER

You can connect your camcorder to a computer (p. 73).

Deleting images

You can delete images recorded on the hard disk or a “Memory Stick Duo” using your camcorder.

Notes

- You cannot restore images once they are deleted.

Tips

- You can select up to 100 images at one time.
- You can delete a image when viewing it by selecting (OPTION) → tab → [DELETE].

Deleting the images on the hard disk

You can free hard disk space by deleting image data from the camcorder.

You can check the free hard disk space of the camcorder using [INFO] (p. 50).

Notes

- Important data should be saved on external media (p. 37).
- Do not try to delete the files on the hard disk of the camcorder using a computer.

1 On the (HOME MENU), touch (OTHERS) → [DELETE].

2 Touch [DELETE].

3 Touch [DELETED] (movies) or [DELETED] (still images), according to the type of image you want to delete.

4 Touch the image to be deleted.



The selected image is marked with ✓. Press and hold the image on the LCD screen to confirm the image. Touch [↩] to return to the previous screen.

5 Touch [OK] → [YES] → [OK].

To delete all movies or still images at one time

In step 3, touch [☰] [DELETE ALL] or [☑] [DELETE ALL] → [YES] → [YES] → [OK].

To delete all the movies or the still images recorded on the same day at one time

- On the (HOME MENU), touch (OTHERS) → [DELETE] → [☑] [DELETE].
- Touch [☰] [DELETE by date] or [☑] [DELETE by date] according to the type of image you want to delete. The recording dates of images are displayed on the screen.

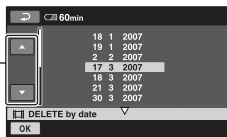

Previous/Next button

- Touch Previous/Next Date button to select the recording date of the desired image.
- Touch [OK] while the selected recording date is highlighted. The images recorded on the selected date are displayed on the screen. Touch the image on the LCD screen to confirm the image. Touch [↩] to return to the previous screen.
- Touch [OK] → [YES] → [OK].

Notes

- Do not remove the battery pack or the AC Adaptor from your camcorder while deleting the images. It may damage the hard disk.
- If the deleted movie is included in the Playlist (p. 42), the movie is deleted also from the Playlist.

Tips

- To delete all images recorded on the hard disk, and recover all the recordable space of hard disk, format the hard disk (p. 49).
- The images recorded by this camcorder and stored onto the hard disk are called "original."

Deleting the still images in the "Memory Stick Duo"

To delete images on a "Memory Stick Duo," insert it in your camcorder before the operation.

1 On the (HOME MENU), touch (OTHERS) → [DELETE].

2 Touch [☑] [DELETE].

3 Touch [☑] [DELETE].

Dividing a movie

4 Touch the still image to be deleted.



The selected still image is marked with ✓.
Press and hold the still image on the LCD screen to confirm the still image.
Touch [↶] to return to the previous screen.

5 Touch [OK] → [YES] → [OK].

To delete all still images on the “Memory Stick Duo”

In step 3, touch [DELETED ALL] → [YES] → [YES] → [OK].

Notes

- You cannot delete still images in the following cases:
 - “Memory Stick Duo” is write-protected (p. 111).
 - write-protection is set to the still images by the other device.

Tips

- To delete all images recorded on the “Memory Stick Duo,” format the “Memory Stick Duo” (p. 50).

You can divide movies on the hard disk of your camcorder.

Notes

- During Easy Handycam operation, you cannot divide movies. Cancel Easy Handycam operation.

1 On the [HOME MENU], touch [OTHERS] → [EDIT].

2 Touch [DIVIDE].

3 Touch the movie to be divided.

The selected movie starts playback.

4 Touch [PAUSE] at the point where you want to divide the movie into scenes.

The movie pauses.

Adjusts the dividing point with more precision after the dividing point has been selected with [PAUSE].

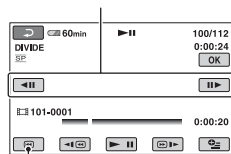

Returns to the beginning of the selected movie.

Play and pause toggles as you press



5 Touch [OK] → [YES] → [OK].



Copying still images



Notes



- You cannot restore movies once they are divided.
- Do not remove the battery pack or the AC Adaptor from your camcorder while dividing the movie. It may damage the hard disk.
- If the divided original movie is included in the Playlist, the movie in the Playlist will also be divided.
- A slight difference may occur from the point where you touch  and the actual dividing point, as your camcorder selects the dividing point based on about half-second increments.

You can copy still images from the hard disk to a “Memory Stick Duo.” Insert a “Memory Stick Duo” in your camcorder before the operation.

Tips

- You can select up to 100 still images at one time.
- You can copy a still image when viewing it by selecting  (OPTION) →  tab → [COPY → ].

1 On the  (HOME MENU), touch  (OTHERS) → [EDIT] → [COPY].

2 Touch  →  COPY].

3 Touch the still image to be copied.



The selected still image is marked with .

Press and hold the image on the LCD screen to confirm the image.

Touch  to return to the previous screen.

4 Touch  → [YES].

Copying starts.

5 When [Completed.] appears, touch .

Creating the Playlist

To copy all the still images recorded on the same day at one time

- 1 On the **↑** (HOME MENU), touch **☰** (OTHERS) → [EDIT] → [COPY].
- 2 Touch **☰** → **☑** COPY by date. The recording dates of still images are displayed on the screen.

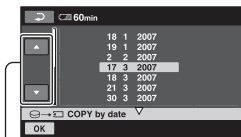

Previous/Next button

- 3 Touch Previous/Next Date button to select the recording date of the desired still image.
- 4 Touch **OK** while the selected recording date is highlighted. The still images recorded on the selected date are displayed on the screen. Touch the image on the LCD screen to confirm the still image. Touch **☑** to return to the previous screen.
- 5 Touch **OK** → [YES] → **OK**.

Notes

- Use the AC Adaptor as the power source to prevent your camcorder from running out of power during copying.
- Do not apply shock or vibration to your camcorder, and do not disconnect the AC Adaptor during copying.
- It may take long when there are many still images to be copied.
- You cannot copy still images on a "Memory Stick Duo" to the hard disk.

A Playlist is a list showing thumbnails of the movies that you have selected. The original movies are not modified even though you edit or delete the movies in the Playlist.

Notes

- During Easy Handycam operation, you cannot add movies to the Playlist or edit the Playlist. Cancel Easy Handycam operation.

-
- 1 On the **↑** (HOME MENU), touch **☰** (OTHERS) → [PLAYLIST EDIT].

-
- 2 Touch **☰** [ADD].

-
- 3 Touch the movie to be added to the Playlist.

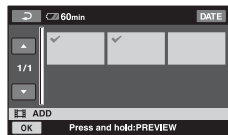

The selected image is marked with **✓**. Press and hold the image on the LCD screen to confirm the image. Touch **☑** to return to the previous screen.

-
- 4 Touch **OK** → [YES] → **OK**.
-

To add all the movies recorded on the same day at one time

- On the (HOME MENU), touch (OTHERS) → [PLAYLIST EDIT].
- Touch [ADD by date].
The recording dates of movies are displayed on the screen.

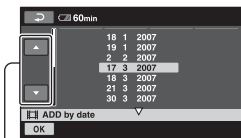

Previous/Next button

- Touch Previous/Next Date button to select the recording date of the desired movie.
- Touch while the selected recording date is highlighted.
The movies recorded on the selected date are displayed on the screen. Touch the image on the LCD screen to confirm the movie. Touch to return to the previous screen.
- Touch → [YES] → .

Notes

- Do not remove the battery pack or the AC Adaptor from your camcorder while editing the Playlist. It may damage the hard disk.
- You cannot add still images to a Playlist.

Tips

- You can add a maximum of 99 movies to the Playlist.
- You can add a movie when viewing it by selecting (OPTION) → tab → [ADD].
- You can copy the Playlist to a DVD as it is, by using the supplied software (p. 91).

Playing the Playlist

- On the (HOME MENU), touch (VIEW IMAGES) → [PLAYLIST]

The Playlist screen appears.



- Touch the image from which you want to playback.

The Playlist is played back from the selected image to the end, then the screen returns to the Playlist screen.

To erase unnecessary images from the Playlist

- On the (HOME MENU), touch (OTHERS) → [PLAYLIST EDIT].
- Touch [ERASE].
To erase all the images from the Playlist, touch [ERASE ALL] → [YES] → [YES] → .
- Select the image to be deleted from the list.

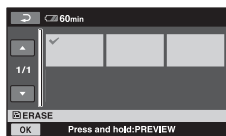

The selected image is marked with .

Press and hold the image on the LCD screen to confirm the image.

Touch to return to the previous screen.

- ④ Touch [OK] → [YES] → [OK].

💡 Tips

- The original images are not changed even if you erase the images from the Playlist.

To change the order within the Playlist

- ① On the 🏠 (HOME MENU), touch 📁 (OTHERS) → [PLAYLIST EDIT].
- ② Touch [📄 MOVE].
- ③ Select the image to be moved.

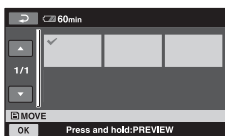

The selected image is marked with ✓.

Press and hold the image on the LCD screen to confirm the image.

Touch [↩] to return to the previous screen.

- ④ Touch [OK].
- ⑤ Select the destination with [←]/[→].

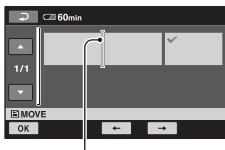

Destination bar

- ⑥ Touch [OK] → [YES] → [OK].

💡 Tips

- When you select multiple images, the images are moved following the order appeared in the Playlist.

Dubbing to VCR or DVD/HDD recorders

You can dub images played back on your camcorder to other recording devices, such as VCRs or DVD/HDD recorders. Connect the device in either of the following ways.

Connect your camcorder to the wall socket using the supplied AC Adaptor for this operation (p. 13). Refer also to the instruction manuals supplied with the devices to be connected.

Notes

- Since dubbing is performed via analog data transfer, the image quality may deteriorate.

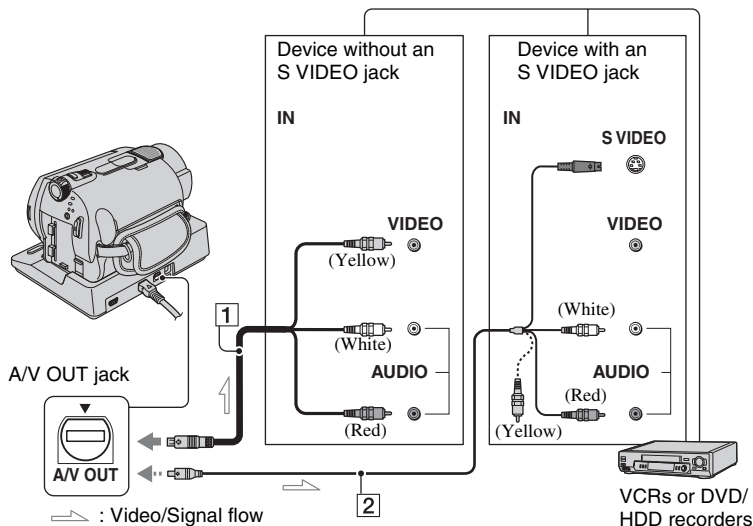

1 A/V connecting cable (supplied)

The Handycam Station and your camcorder are both equipped with A/V OUT jacks (p. 120, 121). Connect the A/V connecting cable either to the Handycam Station or to your camcorder, according to your setup.

2 A/V connecting cable with S VIDEO (optional)

When connecting to another device via the S VIDEO jack, by using an A/V connecting cable with an S VIDEO cable (optional), higher quality images can be produced than with an A/V connecting cable. Connect the white and red plug (left/right audio) and the S VIDEO plug (S VIDEO channel) of the A/V connecting cable with an S VIDEO cable (optional). The yellow plug connection is not necessary. S VIDEO connection only will not output audio.

Notes



- To hide the screen indicators (such as a counter, etc.) on the screen of the monitor device connected, set (SETTINGS) → [OUTPUT SETTINGS] → [DISP OUTPUT] → [LCD PANEL] (the default setting) on the HOME MENU (p. 63).
- To record the date/time and camera settings data, display them on the screen (p. 60).
- When you are connecting your camcorder to a monaural device, connect the yellow plug of the A/V connecting cable to the video input jack, and the red (right channel) or the white (left channel) plug to the audio input jack on the device.

-
- 1 Turn on your camcorder, and press  (VIEW IMAGES) button.**

Set [TV TYPE] according to the display device (p. 62).

- 2 Insert the recording media in the recording device.**

If your recording device has an input selector, set it to the input mode.

- 3 Connect your camcorder to the recording device (VCR or DVD/HDD recorder) with the A/V connecting cable (supplied)  or an A/V connecting cable with S VIDEO (optional) .**

Connect your camcorder to the input jacks of the recording device.

- 4 Start the playback on your camcorder, and record it on the recording device.**

Refer to the instruction manuals supplied with your recording device for details.

- 5 When dubbing is finished, stop the recording device, and then your camcorder.**
-

Printing recorded images (PictBridge compliant printer)

You can print out still images using a PictBridge compliant printer, without connecting the camcorder to a computer.

PictBridge

Connect your camcorder to the AC Adaptor to obtain power from the wall socket (p. 13). Turn on the printer.

To print still images on a “Memory Stick Duo,” insert the “Memory Stick Duo” containing them into your camcorder.

Connecting your camcorder to the printer

- 1 Connect the Handycam Station to the wall socket using the supplied AC Adaptor.**
-

- 2 Set the camcorder onto the Handycam Station securely, then turn the POWER switch to turn on.**
-

- 3 Connect the  (USB) jack of the Handycam Station to the printer using the supplied USB cable.**

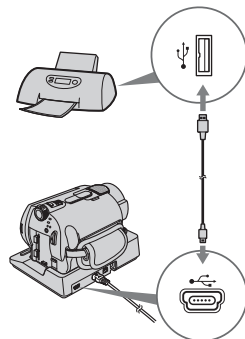

[USB SELECT] appears on the screen automatically.

4 Touch [PRINT] (hard disk) or [PRINT] (“Memory Stick Duo”) depending on the media of the image to be printed.

When connection is complete,  (PictBridge connecting) appears on the screen.

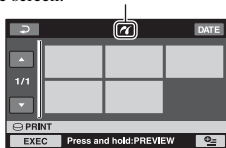

You can select a still image on the screen.

Notes

- We can guarantee the operation of only models that are PictBridge compatible.

Printing

1 Touch the still image to be printed.

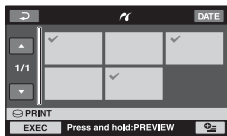

The selected image is marked with . Press and hold the image on the LCD screen to confirm the image.

Touch  to return to the previous screen.

2 Touch (OPTION), set the following options, then touch .

[COPIES]: Set number of copies of a still image to be printed. You can set up to 20 copies.

[DATE/TIME]: Select [DATE], [DAY&TIME], or [OFF] (no date/time printed).

[SIZE]: Select the paper size.

If you do not change the setting, go to step 3.



3 Touch [EXEC] → [YES] → .

The image selection screen appears again.

To finish printing



Touch  on the image selection screen.

Notes

- Refer also to the instruction manual of the printer to be used.
- Do not attempt the following operations when  is on the screen. The operations may not be performed properly.
 - To operate the POWER switch
 - To press  (VIEW IMAGES) button
 - To remove your camcorder from the Handycam Station
 - To disconnect the USB cable (supplied) from the Handycam Station or the printer
 - To remove the “Memory Stick Duo” from your camcorder, in the case of [PRINT]
- If the printer stops working, disconnect the USB cable, turn the printer off and on again, and restart the operation from the beginning.
- You can select only the paper sizes that the printer can print.

- On some printer models, the top, bottom, right, and left edges of images may be trimmed. If you print a still image recorded in a 16:9 (wide) ratio, the left and right ends of the image may be trimmed widely.
- Some printer models may not support the date printing function. Refer to your printer's instruction manual for details.
- The images described below may not be printed out:
 - The image edited by a computer
 - The image recorded by other devices
 - The image file exceeding 3 MB
 - The image file larger than 2848 × 2136 pixels

Tips

- PictBridge is an industry standard established by the Camera & Imaging Products Association (CIPA). You can print still images without using a computer by connecting a printer directly to a digital video camera or digital still camera, regardless of model or manufacturer.
- You can print a still image when viewing it by selecting  (OPTION) →  tab → [PRINT].

(MANAGE HDD/MEMORY) category

This category enables you to use the hard disk or a “Memory Stick Duo” for various purposes.

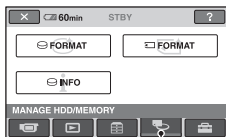

 (MANAGE HDD/MEMORY) category

Item list

FORMAT

You can format the hard disk and recover recordable free space (p. 49).

FORMAT

You can format the “Memory Stick Duo” and recover the recordable free space (p. 50).

INFO

You can display the hard disk capacity (p. 50).

Formatting the hard disk or the “Memory Stick Duo”



Formatting the hard disk

You can delete all the images on the hard disk of the camcorder to recover recordable free space to allow you to write in.

Connect your camcorder to the wall socket using the supplied AC adaptor for this operation (p. 13).

Notes

- To avoid the loss of important images, you should save them (p. 37) before performing [ FORMAT].

- 1 On the  (HOME MENU), touch  (MANAGE HDD/MEMORY) → [ FORMAT].

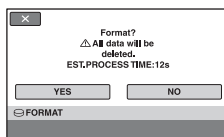

- 2 Touch [YES] → [YES].

- 3 When [Completed.] appears, touch .

Notes



- While [ FORMAT] is activated, do not remove the AC Adaptor or the battery pack.

Formatting the “Memory Stick Duo”

Formatting deletes all images on a “Memory Stick Duo.”

1 Turn on your camcorder.

2 Insert the “Memory Stick Duo” to be formatted into your camcorder.

3 On the  (HOME MENU), touch  (MANAGE HDD/MEMORY) → [FORMAT].

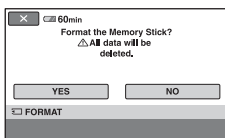

4 Touch [YES] → [YES].

5 When [Completed.] appears, touch [OK].

Notes

- Even the still images protected with another device against accidental deletion are also deleted.
- Do not attempt the following operations when [Executing...] is on the screen:
 - To operate the POWER switch or buttons
 - To remove the “Memory Stick Duo”

Checking the hard disk information

You can display the hard disk information, and check the approximate amount of free hard disk space.

On the  (HOME MENU), touch  (MANAGE HDD/MEMORY) → [INFO].

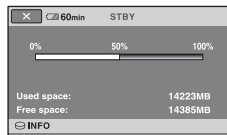



To turn off the display

Touch [X].





Notes

- The calculation for hard disk space is 1MB = 1 048 576 bytes. The fractions less than MB are discarded when the hard disk space is displayed. The displayed size of the whole hard disk space will be slightly smaller than the size shown below despite of displaying both free and used hard disk space.
 - DCR-SR32E/SR42E/SR52E/SR62E:
30 000 MB
 - DCR-SR72E/SR82E:
60 000MB
 - DCR-SR33E/SR190E/SR200E/SR290E/
SR300E:
40 000MB
- Since there is the management file area, the used space is not displayed as 0MB even if you perform [INFO] (p. 49).

Preventing data on the hard disk of the camcorder from being recovered



[ EMPTY] allows you to write non important data onto the hard disk of the camcorder. In this way, it may become more difficult to recover any original data. When you dispose or transfer the camcorder to others, it is recommended that you perform [ EMPTY]. Connect your camcorder to the wall socket using the supplied AC Adaptor for this operation (p. 13)

Notes

- If you perform [ EMPTY], all the images are deleted. To avoid the loss of important images, they should be saved (p. 37) before performing [ EMPTY].
- You cannot perform [ EMPTY] unless you connect the AC adaptor to the wall socket.
- Disconnect all cables except the AC Adaptor. Do not disconnect the AC Adaptor during the operation.
- While performing [ EMPTY], do not apply any vibrations or shocks.

1 Make sure the AC Adaptor is connected, then turn the POWER switch to turn on.

Tips

- You can perform this operation, whichever position of the  (Movie) lamp/  (Still) lamp is lit.

2 On the (HOME MENU), touch (MANAGE HDD/MEMORY) → [FORMAT].

The [ FORMAT] screen appears.

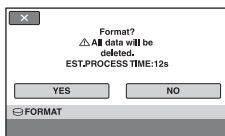

3 Press and hold BACK LIGHT button for a few seconds.



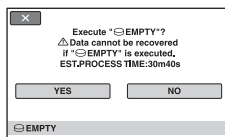

The [ EMPTY] screen appears.



4 Touch [YES] → [YES].

5 When [Completed.] appears, touch .

Notes

- The actual performing time for [ EMPTY] is as follows;
 - DCR-SR32E/SR42E/SR52E/SR62E:
approx. 30 minutes
 - DCR-SR72E/SR82E:
approx. 60 minutes
 - DCR-SR33E/SR190E/SR200E/SR290E/
SR300E:
approx. 40 minutes
- If you stop performing [ EMPTY] between step 4 and 5, be sure to complete the operation by performing [ FORMAT] or [ EMPTY] when you use the camcorder next time.

What you can do with the (SETTINGS) category of the HOME MENU

You can change the recording functions and the operating settings for your convenience.

Using the HOME MENU

- 1 Turn on your camcorder, then press  (HOME).

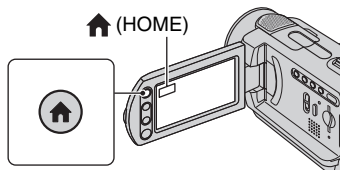

 (HOME)



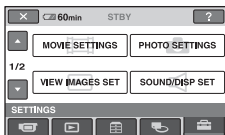

 (SETTINGS) category

- 2 Touch  (SETTINGS).



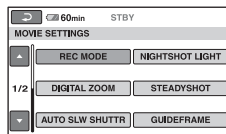

- 3 Touch the desired setup item.

If the item is not on the screen, touch   to change the page.



- 4 Touch the desired item.

If the item is not on the screen, touch   to change the page.

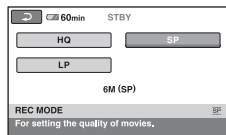

- 5 Change the setting, then touch .

List of the (SETTINGS) category items

MOVIE SETTINGS (p. 54)





Items	Page
REC MODE	54
NIGHTSHOT LIGHT	54
WIDE SELECT*1	54
DIGITAL ZOOM	55
STEADYSHOT	55
AUTO SLW SHUTTR	55
GUIDEFAME*2	56
ZEBRA*2	56
 REMAINING	56
FLASH LEVEL*2	59
REDEYE REDUC*2	59

PHOTO SETTINGS (p. 57)

Items	Page
 IMAGE SIZE*3*4	57
 QUALITY	58
FILE NO.	58
NIGHTSHOT LIGHT	54
STEADYSHOT*5	55
GUIDEFAME*2	56
ZEBRA*2	56
FLASH LEVEL*3	59
REDEYE REDUC*3	59
STILL MEDIA*4	27

VIEW IMAGES SET (p. 60)

Items	Page
DATA CODE	60
 DISPLAY	61

SOUND/DISP SET*6 (p. 61)

Items	Page
VOLUME*4	61
BEEP*4	61
LCD BRIGHT	61
LCD BL LEVEL	62
LCD COLOR	62

OUTPUT SETTINGS (p. 62)

Items	Page
TV TYPE	62
DISP OUTPUT	63

CLOCK/ LANG (p. 63)

Items	Page
CLOCK SET*4	17
AREA SET	63
SUMMERTIME	63
 LANGUAGE SET*4	63

GENERAL SET (p. 64)

Items	Page
DEMO MODE	64
CALIBRATION	115
A.SHUT OFF	64
REMOTE CTRL*3	64
DROP SENSOR	64

*1 DCR-SR32E/SR33E/SR42E

*2 DCR-SR190E/SR200E/SR290E/SR300E

*3 DCR-SR52E/SR62E/SR72E/SR82E/SR190E/SR200E/SR290E/SR300E

*4 You can set these items also during Easy Handycam operation (p. 20).

*5 DCR-SR290E/SR300E

*6 [SOUND SETTINGS] (during Easy Handycam operation)

MOVIE SETTINGS

(Items for recording movies)

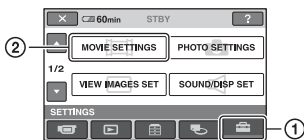

Touch ①, then ②.

If the item is not on the screen, touch ▲/▼ to change the page.

How to set

🏠 (HOME MENU) → page 52

☰ (OPTION MENU) → page 65

The default settings are marked with ▶.

REC MODE



You can select a recording mode to record a movie with the image quality from 3 levels.

HQ

Records in high quality mode.
(9M (HQ))

▶ SP

Records in standard quality mode.
(6M (SP))

LP

Increases the recording time (Long Play).
(3M (LP))

Recordable time (approx.)

DCR-SR32E/SR42E/SR52E/SR62E:

Recording mode	Recordable time
HQ	7 hours 20 min.
SP	10 hours 50 min.
LP	20 hours 50 min.

DCR-SR72E/SR82E:

Recording mode	Recordable time
HQ	14 hours 40 min.
SP	21 hours 40 min.
LP	41 hours 50 min.

DCR-SR33E/SR190E/SR200E/SR290E/ SR300E:

Recording mode	Recordable time
HQ	9 hours 30 min.
SP	14 hours 30 min.
LP	28 hours

🔍 Notes

- If you record in the LP mode, the quality of scenes may be degraded, or scenes with quick movements may appear with a block noise when you play back the movie.

NIGHTSHOT LIGHT



When using either the NightShot plus/ NightShot (p. 27) or [S. NIGHTSHOT PLS] (p. 70)/[SUPER NIGHTSHOT] (p. 70) function to record, you can record clearer images by setting [NIGHTSHOT LIGHT], which emits infrared light (invisible), to [ON] (the default setting).

🔍 Notes

- Do not cover the infrared port with your fingers or other objects.
- Remove the conversion lens (optional).
- The maximum shooting distance using [NIGHTSHOT LIGHT] is about 3 m (10 feet).

WIDE SELECT (DCR-SR32E/SR33E/ SR42E)



When recording images, you can select the aspect ratio according to the TV connected. Refer also to the instruction manuals supplied with your TV.

► 4:3

Records images to the full screen on a 4:3 TV screen.

16:9 WIDE (16:9)

Records images to the full screen on a 16:9 (wide) TV screen.

🔊 Notes

- Set [TV TYPE] correctly according to the TV connected for playback (p. 62).

DIGITAL ZOOM

You can select the maximum zoom level in case you want to zoom greater than optical zoom magnification (p. 25). Note that the image quality decreases when you use the digital zoom.

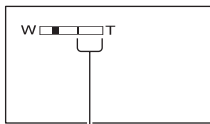

The right side of the bar shows the digital zooming factor. The zooming zone appears when you select the zooming level.

DCR-SR32E/SR33E/SR42E:

► OFF

Up to 40 × zoom is performed optically.

80 ×

Up to 40 × zoom is performed optically, and after that, up to 80 × zoom is performed digitally.

2000 ×

Up to 40 × zoom is performed optically, and after that, up to 2000 × zoom is performed digitally.

DCR-SR52E/SR62E/SR72E/SR82E:

► OFF

Up to 25 × zoom is performed optically.

50 ×

Up to 25 × zoom is performed optically, and after that, up to 50 × zoom is performed digitally.

2000 ×

Up to 25 × zoom is performed optically, and after that, up to 2000 × zoom is performed digitally.

DCR-SR190E/SR200E:

► OFF

Up to 10 × zoom is performed optically.

20 ×

Up to 10 × zoom is performed optically, and after that, up to 20 × zoom is performed digitally.

80 ×

Up to 10 × zoom is performed optically, and after that, up to 80 × zoom is performed digitally.

DCR-SR290E/SR300E:

► OFF

Up to 10 × zoom is performed optically.

20 ×

Up to 10 × zoom is performed optically, and after that, up to 20 × zoom is performed digitally.

STEADYSHOT

You can compensate for camera shake (the default setting is [ON]). Set [STEADYSHOT] to [OFF] (👤) when using a tripod (optional), then the image becomes natural.

AUTO SLW SHUTTR (Auto Slow Shutter)

When recording in dark places, the shutter speed is automatically reduced to 1/25 second (the default setting is [ON]).

GUIDEFRA (DCR-SR190E/SR200E/ SR290E/SR300E)



You can display the frame and check that the subject is horizontal or vertical by setting [GUIDEFRA] to [ON]. The frame is not recorded. Press DISP/BATT INFO to make the frame disappear.

Tips

- Positioning the subject at the cross point of the guide frame makes a balanced composition.

ZEBRA (DCR-SR190E/ SR200E/SR290E/ SR300E)



Diagonal stripes appear in portions of the screen where brightness is at a preset level. This is useful as a guide when adjusting the brightness. When you change the default setting, is displayed. The zebra pattern is not recorded.

▶ OFF

The zebra pattern is not displayed.

70

The zebra pattern appears at a screen brightness level of about 70 IRE.

100

The zebra pattern appears at a screen brightness level of about 100 IRE or higher.

Notes

- Portions of the screen where brightness is about 100 IRE or above may appear overexposed.

Tips

- IRE represents the screen brightness level.

REMAINING



▶ AUTO

Displays the remaining recording time of movies for about 8 seconds in situations such as those described below.

- When your camcorder recognizes the remaining hard disk capacity with the POWER switch is set to (Movie).
- When you press DISP/BATT INFO to switch the indicator from off to on with the POWER switch is set to (Movie).
- When you select the movie recording mode on the HOME MENU.

ON

Always displays the remaining hard disk indicator.

Notes

- When the remaining recordable time for movies is less than 5 minutes, the indicator stays on the screen.

FLASH LEVEL (DCR-SR190E/SR200E/ SR290E/SR300E)



See page 59.

REDEYE REDUC (DCR-SR190E/SR200E/ SR290E/SR300E)



See page 59.

PHOTO SETTINGS

(Items for recording still images)



Touch ①, then ②.

If the item is not on the screen, touch ▲/▼ to change the page.

How to set

🏠 (HOME MENU) → page 52

⊕ (OPTION MENU) → page 65

The default settings are marked with ▶.

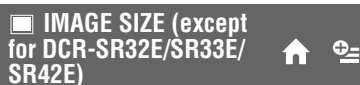

DCR-SR52E/SR62E/SR72E/SR82E:

▶ 1.0M (1.0M)

Records still images clearly.

VGA (0.3M) (VGA)

Allows the maximum number of still images to be recorded.

💡 Tips

- The image size is set to [0.7M] automatically in the aspect ratio 16:9 (wide).

DCR-SR190E/SR200E:

▶ 4.0M (4.0M)

Records still images clearly.

1.9M (1.9M)

Allows you to record more still images in relatively clear quality.

VGA (0.3M) (VGA)

Allows the maximum number of still images to be recorded.

💡 Tips

- The image size is set to [3.0M] automatically in the aspect ratio 16:9 (wide).

DCR-SR290E/SR300E:

▶ 6.1M (6.1M)

Records still images clearly.

3.1M (3.1M)

Allows you to record more still images in relatively clear quality.

VGA (0.3M) (VGA)

Allows the maximum number of still images to be recorded.

💡 Tips

- The image size is set to [4.6M] automatically in the aspect ratio 16:9 (wide).

🔍 Notes

- You can set [IMAGE SIZE] only while the (Still) lamp is lit.
- For DCR-SR32E/SR33E/SR42E, the image size is fixed to [VGA (0.3M)].

💡 Tips

- Still images are recorded in the following sizes with Dual Rec.

DCR-SR190E/SR200E:

– [2.3M] (16:9 (wide))

– [1.7M] (4:3)

DCR-SR290E/SR300E:

– [4.6M] (16:9 (wide))

– [3.4M] (4:3)

Capacity of the “Memory Stick Duo” (MB) and the number of recordable images (approx.)

	6.1M 2848 × 2136	4.6M 2848 × 1602	4.0M 2304 × 1728	3.4M 2136 × 1602
	6.1M	4.6M	4.0M	3.4M
64MB	21 53	28 70	32 81	37 93
128MB	42 105	56 135	64 160	74 185
256MB	76 190	100 250	115 295	130 335

	6.1M 2848 × 2136 6.1M	4.6M 2848 × 1602 4.6M	4.0M 2304 × 1728 4.0M	3.4M 2136 × 1602 3.4M
512MB	155 390	205 510	235 600	270 690
1GB	315 800	420 1050	480 1200	550 1400
2GB	650 1600	860 2150	990 2500	1100 2850
4GB	1250 3200	1700 4250	1950 4900	2250 5700

	3.1M 2048 × 1536 3.1M	3.0M 2304 × 1296 3.0M	2.3M 2016 × 1134 2.3M	1.9M 1600 × 1200 1.9M
64MB	40 100	42 105	56 135	65 160
128MB	80 205	85 215	110 280	130 325
256MB	140 370	150 395	200 500	235 590
512MB	295 760	310 800	410 1000	480 1200
1GB	600 1550	640 1600	840 2100	980 2450
2GB	1200 3150	1300 3350	1700 4300	2000 5000
4GB	2400 6300	2600 6600	3400 8500	3950 9500

	1.7M 1512 × 1134 1.7M	1.0M 1152 × 864 1.0M	0.7M 1152 × 648 0.7M	VGA 640 × 480 VGA
64MB	72 175	120 325	160 390	390 980
128MB	145 355	245 650	325 780	780 1970
256MB	260 640	445 1150	590 1400	1400 3550
512MB	530 1300	900 2400	1200 2850	2850 7200

	1.7M 1512 × 1134 1.7M	1.0M 1152 × 864 1.0M	0.7M 1152 × 648 0.7M	VGA 640 × 480 VGA
1GB	1050 2650	1800 4900	2450 5900	5900 14500
2GB	2200 5500	3750 10000	5000 12000	12000 30000
4GB	4400 10500	7400 19500	9500 23500	23500 59000

Notes

- All numbers measured at the following setting:
Top: [FINE] is selected for image quality.
Bottom: [STANDARD] is selected for image quality.
- All numbers measured when using a “Memory Stick Duo” made by Sony Corporation. The number of recordable images varies depending on the recording environment.
- You can record up to 9,999 still images on the hard disk.
- Still image resolution is obtained by the unique pixel array of Sony's ClearVid CMOS Sensor and image processing system (new Enhanced Imaging Processor)(DCR-SR190E/SR200E/SR290E/SR300E).

QUALITY

► FINE (FINE)

Records still images at the fine image quality level.

STANDARD (STD)

Records still images at the standard image quality level.

FILE NO. (File number)

► SERIES

Assigns file numbers in sequence, even if you change the recording media or replace the “Memory Stick Duo.”

RESET

Assigns file numbers in sequence, following the largest file number existing on the current recording medium.

NIGHTSHOT LIGHT

See page 54.

STEADYSHOT (DCR-SR290E/SR300E)

See page 55.

GUIDEFRA (DCR-SR190E/SR200E/ SR290E/SR300E)

See page 56.

ZEBRA (DCR-SR190E/SR200E/ SR290E/SR300E)

See page 56.

FLASH LEVEL (except for DCR-SR32E/SR33E/ SR42E)

You can set this function when you use the built-in flash (DCR-SR190E/SR200E/SR290E/SR300E), or an external flash (optional) that is compatible with your camcorder.

HIGH(⚡+)

Makes the flash level higher.

▶ NORMAL(⚡)

LOW(⚡-)

Makes the flash level lower.

REDEYE REDUC (except for DCR-SR32E/SR33E/ SR42E)

You can set this function when you use the built-in flash (DCR-SR190E/SR200E/SR290E/SR300E), or an external flash (optional) that is compatible with your camcorder.

You can prevent redden by activating the flash before recording.

DCR-SR52E/SR62E/SR72E/SR82E:

Set [REDEYE REDUC] to [ON], when using this function.

DCR-SR190E/SR200E/SR290E/SR300E:

Set [REDEYE REDUC] to [ON], then press ⚡ (flash) (p. 26) repeatedly to select a setting.

 (Auto redden reduction): Pre-flashes to reduce redden before the flash automatically flashes when there is insufficient ambient light.



 (Forced redden reduction): Always uses the flash and the redden reducing pre-flash.



 (No flash): Records without flash.

Notes

- The redden reduction may not produce the desired effect due to individual differences and other conditions.

STILL MEDIA

See page 27.

VIEW IMAGES SET

(Items to customize the display)



Touch ①, then ②.

If the item is not on the screen, touch ▲/▼ to change the page.

How to set

🏠 (HOME MENU) → page 52

⊕ (OPTION MENU) → page 65

The default settings are marked with ▶.

DATA CODE



During playback, displays the information (data code) recorded automatically at the time of recording.

▶ OFF

Data code is not displayed.

DATE/TIME

Displays the date and time.

CAMERA DATA (below)

Displays camera setting data.

DATE/TIME

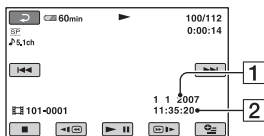

① Date

② Time

CAMERA DATA

Movie

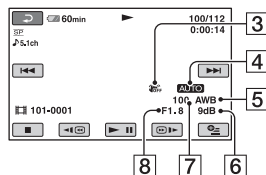

Still image

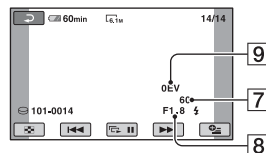

③ SteadyShot off

④ Brightness

⑤ White balance

⑥ Gain

⑦ Shutter speed

⑧ Aperture value

⑨ Exposure

💡 Tips

- ⚡ appears for an image recorded using a flash (except for DCR-SR32E/SR33E/SR42E).
- The data code is displayed on the TV screen if you connect your camcorder to a TV.
- The indicator toggles through the following sequences as you press DATA CODE on the Remote Commander: [DATE/TIME] → [CAMERA DATA] → [OFF] (no indication) (except for DCR-SR32E/SR33E/SR42E).
- Depending on the hard disk condition, bars [--:--:--] appear.

DISPLAY



You can select the number of thumbnails that appear on the VISUAL INDEX screen.

► ZOOM LINK

Change the number of thumbnails (6 or 12) with the power zoom lever on your camcorder.*

6IMAGES

Displays thumbnails of 6 images.

12IMAGES

Displays thumbnails of 12 images.

* You can operate with the zoom buttons on the LCD frame or on the Remote Commander (except for DCR-SR32E/SR33E/SR42E).

SOUND/DISP SET

(Items to adjust beep and the screen)



Touch ①, then ②.

If the item is not on the screen, touch ▲/▼ to change the page.

How to set

🏠 (HOME MENU) → page 52

☰ (OPTION MENU) → page 65

The default settings are marked with ►.

VOLUME



Touch / to adjust the volume (p. 32).

BEEP



► ON

A melody sounds when you start/stop recording, or operate the touch panel.

OFF

Cancels the melody and shutter sound.

LCD BRIGHT



You can adjust the brightness of the LCD screen.

① Adjust the brightness with / .

② Touch .

💡 Tips

- This adjustment does not affect the recorded images in any way.

LCD BL LEVEL (LCD backlight level)



You can adjust the brightness of the LCD screen's backlight.

► NORMAL

Standard brightness.

BRIGHT

Brightens the LCD screen.

🔊 Notes

- When you connect your camcorder to outside power sources, [BRIGHT] is automatically selected for the setting.
- When you select [BRIGHT], battery life is slightly reduced during recording.
- If you open the LCD panel 180 degrees to face the screen outside and close the LCD panel to the camcorder body, the setting becomes [NORMAL] automatically.

💡 Tips

- This adjustment does not affect the recorded images in any way.

LCD COLOR



You can adjust the color of the LCD screen with / .



Low intensity

High intensity

💡 Tips

- This adjustment does not affect the recorded images in any way.

OUTPUT SETTINGS

(Items for when connecting other devices)

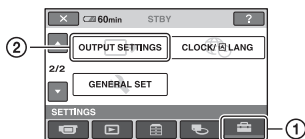

Touch ①, then ②.

If the item is not on the screen, touch ▲/▼ to change the page.

How to set

🏠 (HOME MENU) → page 52

⊕ (OPTION MENU) → page 65

The default settings are marked with ►.

TV TYPE



You need to convert the signal depending on the TV connected when playing back the image. The recorded images are played back as following illustrations.

16:9

(Default setting for DCR-SR52E/SR62E/SR72E/SR82E/SR190E/SR200E/SR290E/SR300E)

Select this to view your images on a 16:9 (wide) TV.

Wide (16:9) images

4:3 images



4:3

(Default setting for DCR-SR32E/SR33E/SR42E)

Select this to view your images on a 4:3 standard TV.

Wide (16:9) images

4:3 images



CLOCK/LANG

(Items to set clock and language)

DISP OUTPUT

► LCD PANEL

Shows displays such as the time code on the LCD screen.

V-OUT/PANEL

Shows displays such as the time code on the TV screen and the LCD screen.

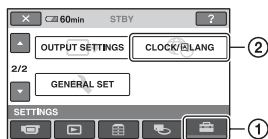

Touch ①, then ②.

If the item is not on the screen, touch ▲/▼ to change the page.

How to set

(HOME MENU) → page 52

(OPTION MENU) → page 65

CLOCK SET

See page 17.

AREA SET

You can adjust a time difference without stopping the clock.

Set your local area using ▲/▼ when using your camcorder overseas.

Refer to the world time difference on page 109.

SUMMERTIME

You can change this setting without stopping the clock.

Set to [ON] to move the time forward 1 hour.

LANGUAGE SET

You can select the language to be used on the LCD screen.

Tips

- Your camcorder offers [ENG[SIMP]] (simplified English) for when you cannot find your native tongue among the options.

GENERAL SET

(Other setup items)

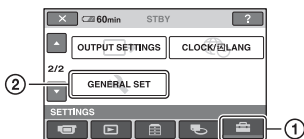

Touch ①, then ②.

If the item is not on the screen, touch ▲/▼ to change the page.

How to set

🏠 (HOME MENU) → page 52

⊕ (OPTION MENU) → page 65

The default settings are marked with ▶.

DEMO MODE



The default setting is [ON], allowing you to view the demonstration in about 10 minutes, after you turn the POWER switch to (Movie).

💡 Tips

- The demonstration will be suspended in situations such as those described below.
 - When you press START/STOP or PHOTO.
 - When you touch the screen during the demonstration (The demonstration starts again after about 10 minutes).
 - When you remove or insert a “Memory Stick Duo.”
 - When you turn the POWER switch to (Still).
 - When you press (HOME)/ (VIEW IMAGES) button.

CALIBRATION



See page 115.

A.SHUT OFF (Auto shut off)



▶ 5 min

The camcorder is automatically turned off when you do not operate your camcorder for more than approximately 5 minutes.

NEVER

The camcorder is not automatically turned off.

🔔 Notes

- When you connect your camcorder to a wall socket, [A.SHUT OFF] is automatically set to [NEVER].

REMOTE CTRL (Remote control) (except for DCR-SR32E/SR33E/SR42E)



The default setting is [ON], allowing you to use the supplied Remote Commander (p. 122).

💡 Tips

- Set to [OFF] to prevent your camcorder from responding to a command sent by another VCR remote control unit.

DROP SENSOR



[DROP SENSOR] is set to [ON] as the default setting. When the drop sensor has detected that the camcorder has been dropped (appears), recording or playing back recorded images may be disabled to protect the internal hard disk.

🔔 Notes

- Set the drop sensor to [ON] (default setting) when you use the camcorder. Otherwise when you drop the camcorder, you may damage the internal hard disk.
- In a non-gravity situation, the drop sensor activates. When you record images during activity such as roller-coasting or skydiving, you can set [DROP SENSOR] to [OFF] (OFF) so as not to activate the drop sensor.

Activating functions using the OPTION MENU

The OPTION MENU appears just like the pop-up window that appears when you right-click the mouse on a computer. Various functions are displayed in the context of the operation.

Using the OPTION MENU

- 1 While using your camcorder, touch  (OPTION) on the screen.

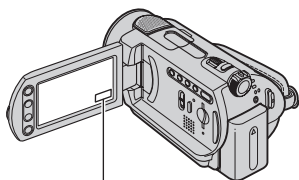

 (OPTION)

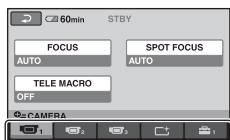

Tab

- 2 Touch the desired item.

If you cannot find the desired item, touch another tab to change the page.

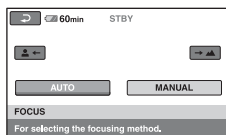

- 3 Change the setting, then touch .

When the item you want is not on the screen







Touch another tab. If you cannot find the item anywhere, the function does not work under the situation.

Notes

- The tabs and items that appear on the screen depend on the recording/playback status of your camcorder at the time.
- Some items appear without a tab.
- The OPTION MENU cannot be used during Easy Handycam operation.

Recording items on the OPTION MENU

See page 65 for setting operation.

Items	 *1	Page
 tab		
FOCUS	-	67
SPOT FOCUS	-	67
TELE MACRO	-	67
EXPOSURE	-	68
SPOT METER	-	68
SCENE SELECTION	-	68
WHITE BAL.	-	69
COLOR SLOW SHTR	-	70
S. NIGHTSHOT PLS *2	-	70
SUPER NIGHTSHOT *3	-	70
 tab		
FADER	-	71
D.EFFECT	-	71
PICT.EFFECT	-	71
 tab		
REC MODE	○	54
MICREF LEVEL	-	71
 IMAGE SIZE *4	○	57
 QUALITY	○	58
SELF-TIMER	-	71
STILL MEDIA	○	27
FLASH MODE *5	-	72
TIMING *3	-	30
RECORD SOUND *3	-	30

*1 Items that are included also in the HOME MENU.

*2 DCR-SR32E/SR33E/SR42E/SR52E/SR62E/SR72E/SR82E









*3 DCR-SR190E/SR200E/SR290E/SR300E

*4 Except for DCR-SR32E/SR33E/SR42E

*5 DCR-SR52E/SR62E/SR72E/SR82E

Viewing items on the OPTION MENU

See page 65 for setting operation.

Items	 *	Page
 tab		
DELETE	○	38
DELETE by date	○	39
DELETE ALL	○	39
 tab		
DIVIDE	○	40
ERASE	○	43
ERASE ALL	○	43
MOVE	○	44
-- (A tab depends on the situation)		
 ADD	○	43
 ADD by date	○	43
PRINT	○	46
SLIDE SHOW	-	34
VOLUME	○	32
DATA CODE	○	60
SLIDE SHOW SET	-	34
 ADD	○	42
 ADD by date	○	43
COPY → 	○	41
 COPY by date	○	42
-- (No tab)		
COPIES	-	47
DATE/TIME	-	47
SIZE	-	47

* Items that are included also in the HOME MENU.

Functions set in the OPTION MENU

Items you can set only on the OPTION MENU will be described below.

The default settings are marked with ►.

FOCUS

You can adjust the focus manually. You can select this function also when you want to focus on a certain subject intentionally.



- ① Touch [MANUAL].
F appears.
- ② Touch (focusing on close subjects) / (focusing on distant subjects) to sharpen the focus. appears when the focus cannot be adjusted any closer, and appears when the focus cannot be adjusted farther away.
- ③ Touch [OK].

To adjust the focus automatically, touch [AUTO] → [OK] in step ①.

Notes

- The minimum possible distance between camcorder and subject while maintaining sharp focus is about 1 cm (about 13/32 in.) for wide angle and about 80 cm (about 2 5/8 feet) for telephoto.

Tips

- It is easier to focus on the subject by moving the power zoom lever towards T (telephoto) to adjust the focus, then towards W (wide angle) to adjust the zoom for recording. When you want to record a subject at close range, move the power zoom lever to W (wide angle), then adjust the focus.
- The focal distance information (the distance at which the subject is focused on, for when it is dark and hard to adjust focus) appears for a few seconds in the following cases; (It will not be displayed correctly if you are using a conversion lens (optional).)
 - When the focus mode is switched from automatic to manual.
 - When you set focus manually.

SPOT FOCUS

You can select and adjust the focal point to aim it at a subject not located at the center of the screen.

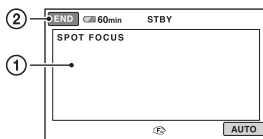

- ① Touch the subject on the screen.
 appears.
- ② Touch [END].

To adjust the focus automatically, touch [AUTO] → [END] in step ①.

Notes

- If you set [SPOT FOCUS], [FOCUS] is automatically set to [MANUAL].

TELE MACRO

This is useful to shoot small subjects, such as flowers or insects. You can blur out backgrounds and the subject stands out clearer.

When you set [TELE MACRO] to [ON] (T), the zoom (p. 25) moves to the top of the T (telephoto) side automatically and allows recording subjects at a close distance as follows;

DCR-SR32E/SR33E/SR42E:

down to about 43 cm (17 in.)

DCR-SR52E/SR62E/SR72E/SR82E:

down to about 38 cm (15 in.)

DCR-SR190E/SR200E:

down to about 37 cm (14 5/8 in.)

DCR-SR290E/SR300E:

down to about 45 cm (17 3/4 in.)



To cancel, touch [OFF], or zoom to wide-angle (W side).

Notes

- When recording a distant subject, focusing may be difficult and can take some time.
- Adjust the focus manually ([FOCUS], p. 67) when it is hard to focus automatically.

EXPOSURE



You can fix the brightness of an image manually. When the subject is too much brighter or gloomier than the background, adjust [EXPOSURE].

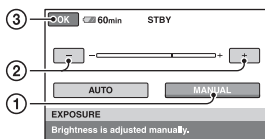

① Touch [MANUAL].

← → appears.

② Adjust the exposure by touching [−] / [+] .

③ Touch [OK].

To return the setting to automatic exposure, touch [AUTO] → [OK] in step ①.

SPOT METER (Flexible spot meter)



You can adjust and fix the exposure to the subject, so that it is recorded in suitable brightness even when there is strong contrast between the subject and the background, such as subjects in the spotlight on stage.

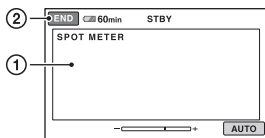

① →

②

① Touch the point where you want to fix and adjust the exposure on the screen.

← → appears.

② Touch [END].

To return the setting to automatic exposure, touch [AUTO] → [END] in step ①.

Notes

- If you set [SPOT METER], [EXPOSURE] is automatically set to [MANUAL].

SCENE SELECTION



You can record images effectively in various situations with the [SCENE SELECTION] function.

► AUTO

Select this to automatically record images effectively without the [SCENE SELECTION] function.

TWILIGHT* (☾)

Select this to take night view without losing the mood.



TWILIGHT PORT. (👤)

Select this to take subject in foreground against night view (DCR-SR190E/SR200E/SR290E/SR300E).



CANDLE (🕯)

Select this to take scene without losing candle mood.



SUNRISE&SUNSET* (☀)

Select this to reproduce the atmosphere of scenes such as sunsets or sunrises.



FIREWORKS* (🎆)

Select this to take spectacular shots of fireworks.



LANDSCAPE* (🏞️)

Select to shoot distant subjects clearly. This setting also prevents your camcorder from focusing on glass or metal mesh in windows that comes in between the camcorder and the subject.



PORTRAIT (👤)

Select to bring out the subject such as people or flowers while creating a soft background.



SPOTLIGHT** (🎤)

Select to prevent people's faces from appearing excessively white when subjects are lit by strong light.



SPORTS** (🏃)

Select to minimize shake when shooting fast moving subjects (DCR-SR32E/SR33E/SR42E/SR52E/SR62E/SR72E/SR82E).



BEACH** (🏖️)

Select to take the vivid blue of the ocean or a lake.



SNOW** (❄️)

Select to take bright pictures of a white landscape.



* Your camcorder is set to focus only on distant subjects.

** Your camcorder is set not to focus on nearby subjects.

🔔 Notes

- The [WHITE BAL.] setting is cleared when you set [SCENE SELECTION].

WHITE BAL. (White balance)



You can adjust the color balance to the brightness of the recording environment.

▶ AUTO

The white balance is adjusted automatically.

OUTDOOR (🌞)

The white balance is adjusted to be appropriate for the following recording conditions:

- Outdoors
- Night views, neon signs and fireworks
- Sunrise or sunset
- Under daylight fluorescent lamps

INDOOR (🏠)



The white balance is adjusted to be appropriate for the following recording conditions:

- Indoors
- At party scenes or studios where the lighting conditions change quickly
- Under video lamps in a studio, or under sodium lamps or incandescent-like color lamps





ONE PUSH (👉)

The white balance will be adjusted according to the ambient light.

- ① Touch [ONE PUSH].

- ② Frame a white object such as a piece of paper, to fill the screen under the same lighting conditions as you will shoot the subject.
- ③ Touch .  flashes quickly. When the white balance has been adjusted and stored in the memory, the indicator stops flashing.

Notes

- Set [WHITE BAL.] to [AUTO] or adjust the color in [ONE PUSH] under white or cool white fluorescent lamps.
- When you select [ONE PUSH], keep framing white object while  is flashing quickly.
-  flashes slowly if [ONE PUSH] could not be set.
- When [ONE PUSH] was selected, if  keeps flashing after touching , set [WHITE BAL.] to [AUTO].
- If you change the [WHITE BAL.] settings, the [SCENE SELECTION] settings return to [AUTO] automatically.

Tips

- If you changed the battery pack, or moved your camcorder to or from outdoors when [AUTO] was selected, aim your camcorder at a nearby white object with [AUTO] for about 10 seconds for better color balance adjustment.
- If you change the [SCENE SELECTION] settings or move your camcorder outdoors during white balance setting with [ONE PUSH], you need to repeat the [ONE PUSH] operation.

COLOR SLOW SHTR (Color Slow Shutter)



When you set [COLOR SLOW SHTR] to [ON], you can record an image brighter in color even in dark places.

 appears on the screen.

To cancel [COLOR SLOW SHTR], touch [OFF].

Notes

- Adjust the focus manually ([FOCUS], p. 67) when it is hard to focus automatically.

- The shutter speed of your camcorder changes depending on the brightness, which may result in a slowdown of the motion of the image.
- When the  (Still) lamp is lit, this item is available for DCR-SR190E/SR200E/SR290E/SR300E only.

S. NIGHTSHOT PLS (Super NightShot plus) (DCR-SR32E/SR33E/ SR42E/SR52E/SR62E/ SR72E/SR82E)



The image will be recorded at a maximum of 16 times the sensitivity of NightShot plus recording if you set [S. NIGHTSHOT PLS] to [ON] while the NIGHTSHOT PLUS switch (p. 27) is also set to ON.

 appears on the screen.

To return to the normal setting, set [S. NIGHTSHOT PLS] to [OFF].

Notes

- Do not use [S. NIGHTSHOT PLS] in bright places. This may cause a malfunction.
- Do not cover the infrared port with your fingers or other objects.
- Remove the conversion lens (optional).
- Adjust the focus manually ([FOCUS], p. 67) when it is hard to focus automatically.
- The shutter speed of your camcorder changes depending on the brightness, which may result in a slowdown of the motion of the image.

SUPER NIGHTSHOT (DCR-SR190E/SR200E/ SR290E/SR300E)



The image will be recorded at a maximum of 16 times the sensitivity of NightShot recording if you set [SUPER NIGHTSHOT] to [ON] while the NIGHTSHOT switch (p. 27) is also set to ON.

 appears on the screen.

To return to the normal setting, set [SUPER NIGHTSHOT] to [OFF].

Notes

- Do not use [SUPER NIGHTSHOT] in bright places. This may cause a malfunction.
- Do not cover the infrared port with your fingers or other objects.
- Remove the conversion lens (optional).
- Adjust the focus manually ([FOCUS], p. 67) when it is hard to focus automatically.
- The shutter speed of your camcorder changes depending on the brightness, which may result in a slowdown of the motion of the image.

FADER



You can record a transition with the following effects adding to the interval between scenes.

- ① Select the desired effect in [STBY] (during fading in) or [REC] (during fading out) mode, then touch [OK].
- ② Press START/STOP.

The fader indicator stops flashing and disappears when the fade is complete.

To cancel the fader before starting the operation, touch [OFF] in step ①. If you press START/STOP, the setting is canceled.



WHITE FADER



BLACK FADER



D.EFFECT (Digital effect)



When you select [OLD MOVIE],  appears and you can add an old movie effect to images.

To cancel [D.EFFECT], touch [OFF].

PICT.EFFECT (Picture effect)



You can add special effects to an image during recording or playback.  appears.

▶ OFF

Does not use [PICT.EFFECT] setting.

SEPIA

Images appear in sepia.

B&W

Images appear in black and white.

PASTEL



Images appear as a pale pastel drawing.

MICREF LEVEL



You can select the microphone level for recording sound.

Select [LOW] when you want to record exciting and powerful sound in a concert hall, etc.

▶ NORMAL

Records various surround sounds, converting them into the certain level.

LOW (↑↓)

Records surround sound faithfully. This setting is not suitable for recording conversations.

SELF-TIMER



You can record a still image after about 10 seconds.

Press PHOTO when [SELF-TIMER] is set to [ON], and  appears.

To cancel the count down, touch [RESET]. To cancel the self-timer, select [OFF].

💡 Tips

- You can also operate by pressing PHOTO on the Remote Commander (p. 122) (except for DCR-SR32E/SR33E/SR42E).

FLASH MODE
**(DCR-SR52E/SR62E/
SR72E/SR82E)**



You can set this function when you use an external flash (optional) that is compatible with your camcorder. Attach the external flash to the Active Interface Shoe (p. 120).

► **ON ($\frac{1}{2}$)**

Flashes every time.

AUTO

Flashes automatically.

What you can do with Windows computer

When you install the “Picture Motion Browser” on a Windows computer from the supplied CD-ROM, you can enjoy the following operations.

Notes

- The supplied software is not compatible with a Macintosh.

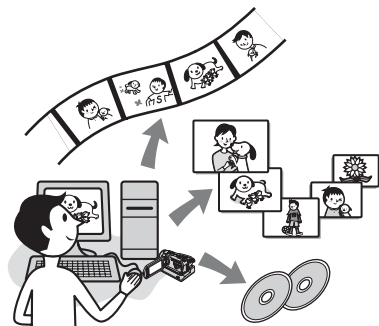

Main functions

■ Creating a DVD using the One Touch Disc Burn function (p. 77)

You can save images recorded on the hard disk of your camcorder on a DVD by pressing DISC BURN button on your Handycam Station (One Touch Disc Burn function).

It is a simple operation to save images to a DVD.

■ Importing images recorded on the hard disk of your camcorder to a computer (p. 81)

You can import images recorded on the hard disk of your camcorder to a computer with a simple operation.

■ Deleting images recorded on the hard disk of your camcorder by a computer (DCR-SR42E/SR62E/SR82E/SR200E/SR300E) (p. 85)

You can delete images recorded on the hard disk of your camcorder by using a computer.

■ Viewing images imported to a computer (p. 86)

You can manage images recorded on the hard disk of your camcorder by date, and select images you want to view as thumbnails.

These thumbnails can be enlarged and played in a slide show.

■ Creating a DVD with edited images

You can edit images imported to a computer (p. 88).

You can create a DVD with selected images (p. 90).

■ Creating a DVD with movies included in a Playlist on your camcorder (p. 91)

You can save movies included in a Playlist on your camcorder on a DVD with a simple operation.

■ Copying a DVD → Video Disc Copier (p. 92)

You can copy a DVD you created as it is.

About the help function of the software

The Help guide explains all the functions of all the software applications. Refer to the Help guide for further detailed operations after reading this Handbook thoroughly. To display the Help guide, click the  mark on the screen.

System requirements

When using Picture Motion Browser

OS: Microsoft Windows 2000 Professional, Windows XP Home Edition, Windows XP Professional, or Windows XP Media Center Edition
Standard installation is required.
Operation is not assured if the above OS has been upgraded or in a multi-boot environment.

CPU: Intel Pentium III 1 GHz or faster

Application: DirectX 9.0c or later (This product is based on DirectX technology. It is necessary to have DirectX installed.)

Sound system: Direct Sound compatible sound card

Memory: 256 MB or more

Hard disk: Available free hard disk space for installation required: Approximately 600 MB (for creating a DVD, 5 GB or more may be required)

Display: DirectX 7 or later-compatible video card, Minimum 1024 × 768 dots, High Color (16 bit color)

Others:  USB port (this must be provided as standard), DVD burner (CD-ROM drive is necessary for installation)

When playing still images recorded on a “Memory Stick Duo” with a computer

OS: Microsoft Windows 2000 Professional, Windows XP Home Edition, Windows XP Professional or Windows XP Media Center Edition
Standard installation is required.
Operation is not assured if the above OS has been upgraded.

CPU: MMX Pentium 200 MHz or faster

Others:  USB port (this must be provided as standard)

Notes

- Even in a computer environment where the operations are guaranteed, frames may be dropped from movies, resulting in uneven playback. However, imported images and images on a DVD created subsequently will not be affected.
- Operations are not guaranteed, even on computers fulfilling the above system requirements.
- Picture Motion Browser does not support 5.1ch surround sound reproduction. The sound is reproduced in 2ch sound.
- If you use a Notebook computer, connect it to the AC Adaptor as the power source. Otherwise, the software will not work properly due to the power saving function of the computer.

Tips

- If your computer has a Memory Stick slot, insert the “Memory Stick Duo” on which still images are recorded into the Memory Stick Duo Adaptor (optional), then insert it into the Memory Stick slot on your computer to import still images to the computer.
- When using a “Memory Stick PRO Duo” and your computer is not compatible with it, connect your camcorder with the USB cable instead of using the Memory Stick slot on the computer.

Use a special caution for preventing damages and malfunctions of the camcorder

- When connecting your camcorder with the USB cable or other cable, make sure you insert the connector in the correct direction. Do not insert the connector forcibly as it may damage the cable or your camcorder.
- Be sure to use the supplied software when operating images recorded on the camcorder through a computer.

On screenshots

- The screenshots are from Windows XP. The scenes may vary depending on the operating system of the computer.
- On screenshots in this Handbook, the application for English version is used. When you install the application, you can select other language (p. 75).

Installing the software

You need to install the software to your Windows computer **before connecting your camcorder to the computer**. The installation is required only for the first time.

Provide the camcorder and the Handycam Station, and a USB cable beforehand. Contents to be installed and procedures may differ depending on your OS.

1 Confirm that your camcorder is not connected to the computer.

2 Turn on the computer.

Notes

- Log on as Administrators for installation.
- Close all applications running on the computer before installing the software.

3 Place the supplied CD-ROM in the disc drive of your computer.

The installation screen appears.



If the screen does not appear

- 1** Click [Start], then click [My Computer]. (For Windows 2000, double-click [My Computer].)
- 2** Double-click [SONYPICTUTIL (E:)] (CD-ROM) (disc drive).*

* Drive names (such as (E:)) may vary depending on the computer.

4 Click [Install].

5 Select the language for the application to be installed, then click [Next].

6 Check your area and country/region, then click [Next].

Notes

- The software is set up for your selected country/region.

7 Read [License Agreement], select [I accept the terms of the license agreement] when you agree, then click [Next].

8 Set the camcorder onto the Handycam Station, then turn the POWER switch to turn on.

9 Connect the Handycam Station to your computer using the supplied USB cable, then click [Next] on the connection confirmation screen.

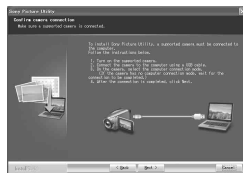

Even if a screen prompting you to restart your computer appears, you do not need to restart it at this time. Restart your computer after completing the installation.

10 Follow the on-screen instructions to install the software.

Depending on the computer, you may need to install third party software (shown below). If the installation screen appears, follow the instructions to install the required software.

■ Windows Media Format 9 Series Runtime (Windows 2000 only)

Software required to create a DVD

■ Microsoft DirectX 9.0c

Software required to handle movies

Restart the computer if required to complete the installation.

The short-cut icons, such as [] (Picture Motion Browser), appear on the desktop.



11 Remove the CD-ROM from the disc drive of your computer.

Tips

- For disconnecting the USB cable, see page 79.



After you install the software, a shortcut icon for the customers registration website is created on the desktop.

- Once you register on the website, you can get secure and useful customer support.
<http://www.sony.net/registration/di/>

- For the information about Picture Motion Browser, visit the following URL:
<http://www.sony.net/support-disoft/>

Creating a DVD with One Touch

Types of DVDs you can use

The kinds of DVD that you can use with the supplied software are as listed below. The DVDs you can use differ, depending on the computer you use. For details on the DVDs compatible with your computer, refer to the operations manual supplied with your computer. You may not be able to play back some types of DVDs, depending on the device you have. Refer to the specifications of your playback equipment for additional compatibility information.

DVD types	Characteristics
DVD-R	<ul style="list-style-type: none">• Unrewritable• Fairly inexpensive. Mainly used for saving data• Compatible with most DVD players
DVD+R	<ul style="list-style-type: none">• Unrewritable
DVD+R DL	<ul style="list-style-type: none">• Using the double layer DVD+R system containing more recordable capacity• Unrewritable
DVD-RW	<ul style="list-style-type: none">• Rewritable and reusable
DVD+RW	<ul style="list-style-type: none">• Rewritable and reusable

- 8 cm DVDs are not supported.
- When saving data on a DVD+RW, the data is recorded in VIDEO format. You cannot add more data on the DVD+RW.
- Use a DVD produced by a reliable manufacturer. You may not save images correctly when using a low quality DVD.

Saving images on a DVD with One Touch (One Touch Disc Burn)

You can save images recorded on the hard disk of your camcorder on a DVD in your computer by pressing DISC BURN button on the Handycam Station (One Touch Disc Burn function) without any complex operations on your computer. The images that have not yet been saved on a DVD with One Touch Disc Burn can automatically be saved on a DVD.

Tips

- The image data previously saved on a DVD in this operation cannot be saved again with the same operation. To save data on a DVD again after it has been saved previously, import the images to a computer (p. 81). Then, save the data on a DVD, following the instructions in “Creating and copying a DVD” (p. 90).
- The history of each saved image is recorded according to the user account. If you use a different user account, the image that has already been saved to a DVD is written to the DVD again.
- If you cannot save all your image data on a DVD, the data is automatically saved on more than one DVD. The required number of DVDs is displayed in step 7 on the screen.
- Still images are recorded first on a DVD. When you save images on several DVDs, the still images are recorded on the first DVD.
- The sound quality remains as it is when you save a movie recorded in 5.1ch surround sound on a DVD (DCR-SR190E/SR200E/SR290E/SR300E).

Notes

- Still images on a DVD created with One Touch Disc Burn function cannot be played back on a DVD player. Play them back on a computer.

1 Confirm that the Handycam Station is not connected to the computer.

2 Turn on the computer.

3 Place the recordable DVD to be saved in the DVD drive of your computer.



💡 Tips

- It is recommended that you use a new recordable DVD.
- If any software starts on the computer automatically, close it.

4 Connect the Handycam Station to the wall socket using the supplied AC Adaptor.

5 Set the camcorder onto the Handycam Station, then turn the POWER switch to turn on.

💡 Tips

- You can perform this operation, whichever position of the  (Movie)/ (Still) lamp is lit.

6 Press DISC BURN button on the Handycam Station.

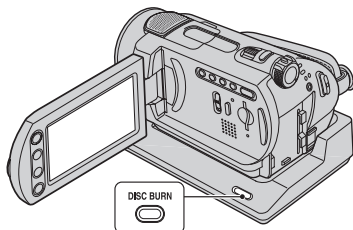

7 Connect the USB (USB) jack of the Handycam Station to a computer using the supplied USB cable.

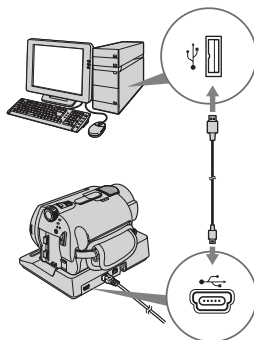

The DVD recognition window is displayed on the computer screen.

When the DVD type is recognized, DVD creation begins.

🔧 Notes

- When connecting your camcorder to a computer, make sure you insert the connector in the correct direction. Do not insert the connector forcibly as it may damage the cable, the Handycam Station or your computer.

💡 Tips

- Your camcorder is compatible with Hi-Speed USB (USB 2.0). You can transfer data at a faster rate using a computer compatible with Hi-Speed USB (USB 2.0). When you connect a USB interface not compatible with Hi-Speed USB (USB 2.0), the data transfer ratio will be that of USB 1.1 (USB Full-Speed).

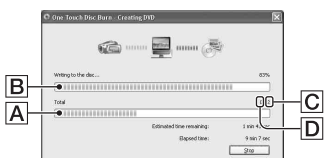

- A** Current status of all DVD creation
- B** Current status per DVD
- C** Number of DVDs required
- D** Number of DVDs being created

When the DVD creation is completed, the disc tray opens automatically.

Notes

- During DVD creation, do not apply vibration to the camcorder. The DVD creation may be terminated.
- Make sure no other USB devices are connected to your computer.

Tips

- When you insert a burned DVD-RW/DVD+RW in the DVD drive in step 3, a message appears, asking if you want to delete data saved on a DVD.
- When you cannot store all the recordable data on a DVD, follow the on-screen instructions, then insert a new DVD onto the DVD drive.

8 Once the completion dialog for DVD creation appears, click [Close] on the computer screen.

To create another DVD, click [Copy].

Tips

- You can also create a DVD by selecting [DISC BURN] on the [USB SELECT] screen of your camcorder (p. 80).
- You can also create a DVD by selecting [One Touch Disc Burn] in the HDD Handycam Utility (p. 80).

To disconnect the USB cable

- ① Touch [END] on the LCD screen of your camcorder.
- ② Click the [Unplug or eject hardware] icon on the task tray.

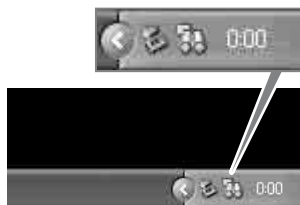

- ③ Click [Safely remove USB Mass Storage Device].

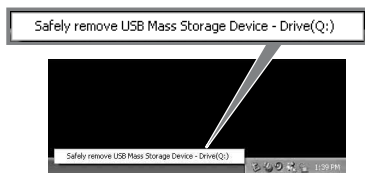

- ④ Touch [YES] on the LCD screen of your camcorder.
- ⑤ Disconnect the USB cable from the Handycam Station and the computer.

Notes

- Do not disconnect the USB cable while the ACCESS lamp is lit.
- Before turning off your camcorder, disconnect the USB cable following the proper procedures described above.
- Disconnect the USB cable using the proper procedures described above. Otherwise, files stored on the hard disk of your camcorder or in a "Memory Stick Duo" may not be updated correctly. Also, disconnecting the USB cable improperly may cause a malfunction of the hard disk of your camcorder or of the "Memory Stick Duo."

After creating a DVD

- After creating a DVD, check that the DVD can be played back properly on a DVD player or other devices.

When you cannot play back the DVD properly, import the images to the computer by following the steps on page 81.

Then save the data on a DVD, following the instructions in “Creating and copying a DVD” (p. 90).

- If you check that the DVD can be played back properly, it is recommended that you delete the images from the camcorder using the functions on the camcorder by following the steps on page 38. In this way, you can increase the free hard disk space of your camcorder.
- To copy a created DVD, use the supplied DVD copy software (p. 92).
- You cannot save the images on the hard disk of your computer in this operation.
- You cannot delete the images on the hard disk of the camcorder in this operation.
- You cannot edit the images on the created DVD with a computer. When you want to edit the images with the computer, import the images onto the computer first (p. 81).
- If DVD creation ends unexpectedly, the last correctly saved file is completed. When you create a DVD with the One Touch Disc Burn function next time, the image data file that has not yet been saved on the DVD will be the first one to be saved.
- The images that have been imported to a computer using Easy PC Back-up, can be saved on a DVD with the One Touch Disc Burn function.

To perform [DISC BURN] on the [USB SELECT] screen of your camcorder

- ① Turn on the computer.
- ② Place the recordable DVD to be saved in the DVD drive of your computer.
- ③ Connect the Handycam Station to the wall socket using the supplied AC Adaptor.
- ④ Set the camcorder onto the Handycam Station, then turn the POWER switch to turn on.
- ⑤ Connect the ψ (USB) jack of the Handycam Station to a computer using the supplied USB cable.
The [USB SELECT] screen is displayed on the LCD screen of your camcorder.
 - For connecting with the USB cable, see page 78.
- ⑥ Touch [DISC BURN] on the LCD screen of your camcorder.
The DVD recognition window is displayed on the computer screen.
When the DVD type is recognized, DVD creation begins.

To perform [One Touch Disc Burn] on the HDD Handycam Utility of a computer

- ① Turn on the computer.
- ② Place the recordable DVD to be saved in the DVD drive of your computer.
- ③ Connect the Handycam Station to the wall socket using the supplied AC Adaptor.
- ④ Set the camcorder onto the Handycam Station, then turn the POWER switch to turn on.
- ⑤ Connect the ψ (USB) jack of the Handycam Station to a computer using the supplied USB cable.
The [USB SELECT] screen is displayed on the LCD screen of your camcorder.
 - For connecting with the USB cable, see page 78.
- ⑥ Touch [COMPUTER] on the LCD screen of your camcorder.
The [HDD Handycam Utility] window is displayed on the computer screen.

- ⑦ Click [One Touch Disc Burn] in the [HDD Handycam Utility] window on the computer screen.

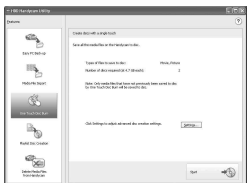

- ⑧ Click [Start].
The DVD recognition window is displayed on the computer screen. When the DVD type is recognized, DVD creation begins.

To customize the settings of the DVD drive used for creating a DVD

- ① Click [Settings...] in step ⑦ in “To perform [One Touch Disc Burn] on the HDD Handycam Utility of a computer”.

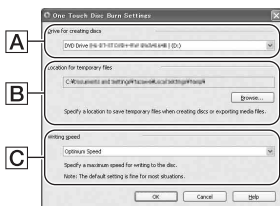

A Drive settings

Select the drive you want to use to create a DVD.

B Location for temporary files

Specify a folder to be used to save temporary files in the window displayed when [Browse] is clicked.

C Writing speed

Select [Optimum Speed] for normal usage. If DVD creation failure persists, select lower speed.

- ② Click [OK] when the setting is completed.

Importing images to a computer

You can view and edit images imported from the camcorder to the computer. Also, you can create a DVD with the imported materials. To import images from the camcorder, use [Easy PC Back-up], [Media File Import], etc.

Importing entire images to a computer (Easy PC Back-up)

You can import images recorded on the hard disk of your camcorder to a computer with a simple operation using the Easy PC Back-up function of the HDD Handycam Utility. The images recorded on the hard disk of your camcorder that have not yet been imported to a computer can automatically be imported to your computer.

1 Turn on the computer.

2 Connect the Handycam Station to the wall socket using the supplied AC Adaptor.

3 Set the camcorder onto the Handycam Station, then turn the POWER switch to turn on.

4 Connect the Ψ (USB) jack of the Handycam Station to a computer using the supplied USB cable.

The [USB SELECT] screen is displayed on the LCD screen of your camcorder.

- For connecting with the USB cable, see page 78.

5 Touch [COMPUTER] on the LCD screen of your camcorder.

The [HDD Handycam Utility] window is displayed on the computer screen.

6 Click [Easy PC Back-up] in the [HDD Handycam Utility] window on the computer screen.

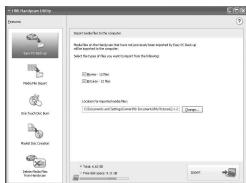

7 Select the type of image file and the destination folder.

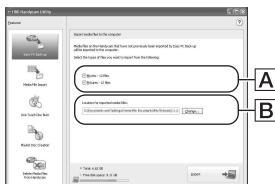

A Importing file type

Select if you want to import movies and still images individually. In the default setting, both the movies and still images are set to be imported.

B The destination folder

To change the destination folder to save the imported images, click [Change]. The default destination is set as the [My Pictures] folder.

8 Click [Import].

The image that have not been imported to a computer are automatically imported to your computer.

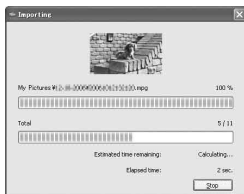

When the import of the data is completed, [Picture Motion Browser] starts up automatically and the imported images are displayed in the window.

Notes

- While importing images, do not apply vibration on the camcorder. The importing may be terminated.

Importing selected images to a computer (Media File Import)

You can import selected images on your camcorder to a computer with [Media File Import] on the HDD Handycam Utility.

1 Turn on the computer.

2 Connect the Handycam Station to the wall socket using the supplied AC Adaptor.

3 Set the camcorder onto the Handycam Station, then turn the POWER switch to turn on.

4 Connect the ψ (USB) jack of the Handycam Station to a computer using the supplied USB cable.

The [USB SELECT] screen is displayed on the LCD screen of your camcorder.

- For connecting with the USB cable, see page 78.

5 Touch [COMPUTER] on the LCD screen of your camcorder.

The [HDD Handycam Utility] window is displayed on the computer screen.

6 Click [Media File Import] in the [HDD Handycam Utility] window on the computer screen.

The image select window for importing is displayed.

Movies and still images recorded on the camcorder are displayed as thumbnails on each tab.



7 To import movies, click [Movies] tab, or to import still images, click [Still images] tab.

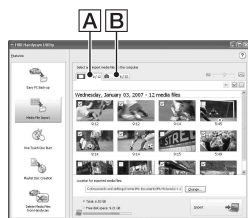

- A Movies
B Still images

8 Select the images you want to import.

Click the check box at the top left on the thumbnails of movies and still images you want to import. If you want to import all the images on selected tab, click [✓] (Select All).

💡 Tips

- By switching the tabs, you can select both movies and still images at the same time.
- To change the destination, click [Change], then select the desired folder. The default destination is set as [My Pictures]. You can change the destination where imported files will be saved by selecting a folder from among those registered as [Viewed folder] in the window that is displayed when you click [Change].

9 Click [Import].



The import of selected images starts.

To import still images using the Memory Stick slot of a computer

You can import still images recorded on a “Memory Stick Duo” by inserting the “Memory Stick Duo” into the Memory Stick slot of a computer.

Tips

- You can import the still images recorded on a “Memory Stick Duo” with connecting your camcorder and a computer (p. 84).

- ① Turn on the computer.
- ② Insert a recorded “Memory Stick Duo” into the Memory Stick slot of your computer.
- ③ Double-click [] (Picture Motion Browser) on the desktop.
[Picture Motion Browser] starts up.
- ④ Click [].
Or, select [Import Media Files] in the [File] menu.
- ⑤ Click [Digital Still Camera/Memory Stick (DCF Format)] → [OK].

The window to be used to select the drive/folder for the still images to be imported from/to is displayed.

- ⑥ Select the medium holding the still images you want to import.
- ⑦ Select the destination folder to save the imported still images.

Tips



- The default destination is set as [My Pictures].
You can change the destination where imported files will be saved by selecting a folder from among those registered as [Viewed folder] in the window that is displayed when you click [Change].

- ⑧ Click [Import].
The import of the selected still images starts.

To import still images from the “Memory Stick Duo” to a computer via a USB cable

You can import the still images recorded on the “Memory Stick Duo” to a computer with connecting your camcorder and a computer.

- ① Turn on the computer.

- ② Connect the Handycam Station to the wall socket using the supplied AC Adaptor.
- ③ Set the camcorder onto the Handycam Station, then turn the POWER switch to turn on.
- ④ Connect the  (USB) jack of the Handycam Station to a computer using the supplied USB cable.
The [USB SELECT] screen is displayed on the LCD screen of your camcorder.
 - For connecting with the USB cable, see page 78.
- ⑤ Touch [ COMPUTER] on the LCD screen of your camcorder.
The importing image window is displayed on the computer screen.
- ⑥ Select the drive that the images recorded.
- ⑦ Select the destination folder to save the imported still images.
- ⑧ Click [Import].
The import of selected still images to the selected folder starts.

On destination folders

The images are imported to the date folders (named with the date imported) created in the [My Pictures] folder in the default setting.

Deleting images recorded on the camcorder through the computer (DCR-SR42E/SR62E/SR82E/SR200E/SR300E)

You can delete images recorded on the camcorder using Picture Motion Browser.

Notes

- This function is not available for DCR-SR32E/SR33E/SR52E/SR72E/SR190E/SR290E.
- You cannot restore images once they are deleted.
- You cannot delete images recorded on the "Memory Stick Duo" using this function.

1 Turn on the computer.

2 Connect the Handycam Station to the wall socket using the supplied AC Adaptor.

3 Set the camcorder onto the Handycam Station, then turn the POWER switch to turn on.

4 Connect the ψ (USB) jack of the Handycam Station to a computer using the supplied USB cable.

The [USB SELECT] screen is displayed on the LCD screen of your camcorder.

- For connecting with the USB cable, see page 78.

5 Touch [COMPUTER] on the LCD screen of your camcorder.

The [HDD Handycam Utility] window is displayed on the computer screen.

6 Click [Delete Media Files from Handycam] in the [HDD Handycam Utility] window on the computer screen.

The image select window is displayed.

Movies and still images recorded on the camcorder are displayed as thumbnails on each tab.

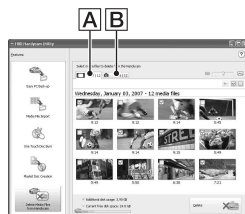

- A Movies
- B Still images

7 To delete movies, click [Movies] tab, or to delete still images, click [Still images] tab.

8 Select the images you want to delete.

Click the check box at the top left on the thumbnails of movies and still images you want to delete.

9 Click [Delete].

The deleting confirmation screen appears.

10 Click [Yes].

Tips

- For disconnecting the USB cable, see page 79.

Viewing images imported to a computer

You can browse images imported to a computer, sorted by registered folder (Folder view), or sorted by the date and time they were recorded (Calendar view).

1 Turn on the computer.

2 Double-click [] (Picture Motion Browser) on the desktop.

[Picture Motion Browser] starts up.

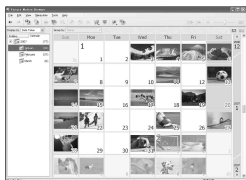

3 Click [Folders] or [Calendar] on the Folder/Calendar switching tab.



When you click [Folders], a list of registered folders is displayed.

When you click [Calendar], the years and months that have images are displayed in a list on a calendar tree.

4 Click the folder, or click the year and month of recording images you want to view.

When you click the folder, thumbnails of images stored in the selected folder are listed.

When you click the year and month, a calendar is displayed. In the date box of the calendar, thumbnails of images recorded on that date are displayed.

When you click the folder



When you click the month icon

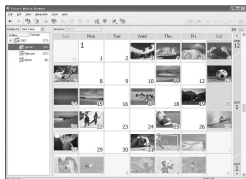

Tips

- When you click the month on the yearly calendar, the calendar switches to the selected month.
- When you click the date on a monthly calendar, the calendar switches to a time calendar for the selected date. Thumbnails of the images recorded on that day are displayed, arranged according to the hour they were recorded.

To enlarge an image

Double-click the thumbnail.

The view image window starts up and the selected image is enlarged.

When you select a movie, the slider and the playback control buttons appear and playback starts.

When you select a still image



When you select a movie

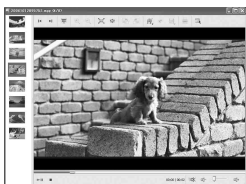

To playback images continuously

You can playback images continuously as a slide show. Here we explain the procedure for starting a slide show by selecting images in the Calendar view.

- ① Turn on the computer.
- ② Double-click [] (Picture Motion Browser) on the desktop.
[Picture Motion Browser] starts up.

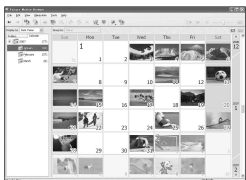

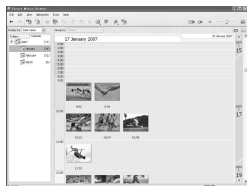

- ③ Click [Calendar] on the Folder/Calendar switching tab.

- ④ Click the date when the image you want to view in the slide show is recorded.
A list of images recorded on the selected date is displayed.

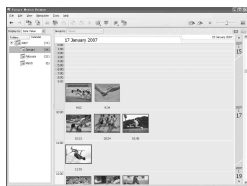

- ⑤ Select the images.
The selected images are marked with a blue frame.
 - To select listed images in the image display area on the main window, click the first thumbnail, then press and hold down [Shift] key and click the last thumbnail.
To select two or more random images, press and hold down [Ctrl] key while clicking thumbnails.



- ⑥ Click [].
The selected image is displayed full screen, and a slide show starts.
If you move the mouse while the slide show is playing, a setting bar for controlling the playback is displayed and you can control playback and adjust the volume.

To delete unnecessary image from the computer

- ① Right-click the thumbnail of the image you want to delete.
- ② Click [Delete] → [Yes].

Editing the imported images

Editing movies

You can cut out only required movie parts to save.

1 Turn on the computer.

2 Double-click [] (Picture Motion Browser) on the desktop.

[Picture Motion Browser] starts up.

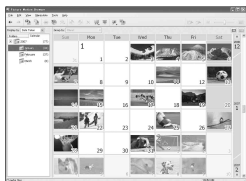

3 Select the movie you want to edit in the Folder view or Calendar view (p. 86).

4 Click [] and select [Video Trimming].

The Video Trimming window is displayed.



Tips

- You can display the Video Trimming window by selecting [Video Trimming] from the [Manipulate] menu in the Main window, or clicking [] in the view image window and selecting [Video Trimming].

5 Select the scene you want to set as an IN point (the beginning of the required part) using the [◀II], [II▶] buttons on the right side of the window, or the slider, and click [Set IN point].

The selected scene is displayed in the thumbnail of [IN point].



6 Select the scene you want to set as an OUT point (the end of the required part) in the same way, and click [Set OUT point].

The selected scene is displayed in the thumbnail of [OUT point].



7 After setting the points, click [Save Edited Video].

The Save Video window is displayed. The edited movie file will be saved with a file name different from that of the original file name.

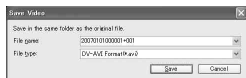

8 Click [Save] to save the edited movie.

Saving takes some time. When the saving is completed, a message is displayed. Click [OK].

To capture still images from a movie

Click [Save Frame] in the Video Trimming window to save the current frame as a still image. The file of the still image is saved in the same folder as the original movie.

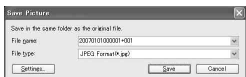

💡 Tips

- Still images are saved in high resolution. By clicking [Settings] on the window displayed after you click [Save Frame], you can adjust the settings for noise reduction and color correction.

Editing still images

You can edit imported still images as follows. For details about the operation, refer to the Picture Motion Browser Help.

Automatic Correction

Automatically corrects the brightness and contrast to the most suitable levels for that image.

Correcting brightness and contrast

The brightness and contrast of still images can be corrected. You can also correct only dark or light areas.

Correcting saturation

Adjusts the saturation of images.

Adjusting sharpness

Emphasizes the outline of images.

Adjusting with the tone curve

The histogram and tone curve for the channel being displayed in the drop-down list are shown. You can adjust the tone curve for each channel.

Red-eye Reduction

If the red-eye is caused by shooting a person with flash, you can correct the red-eye portion of the still image. You can correct and remove the red-eye portion of still images.

Trimming

You can edit still images and use only the parts of the image you want.

Resizing

You can resize still images and save them to the desired folder.

Changing the date and time stamp

You can change the date and time stamp of still images in a batch.

Inserting date

You can insert a date stamp into still images.

Creating and copying a DVD

Creating a DVD with selected images

You can create a DVD Video with a DVD menu by putting images on your computer as materials.

💡 Tips

- The selected movies are written to the DVD as they are. If there are unnecessary scenes in the movie, edit it beforehand (p. 88).

1 Turn on the computer, and place the recordable DVD to be saved in the DVD drive of your computer.

2 Double-click [] (Picture Motion Browser) on the desktop.

[Picture Motion Browser] starts up.

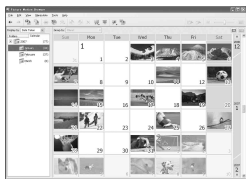

3 Select the images you want to write to the DVD in the Folder view or Calendar view (p. 86).

You can select two or more images, or select images by folder or date.

💡 Tips

- To select listed images in the image display area on the main window, click the first thumbnail, then press and hold down [Shift] key and click the last thumbnail.
To select two or more random images, press and hold down [Ctrl] key while clicking thumbnails.

4 Select [DVD-Video Creation] in the [Manipulate] menu.

The window used to select images is displayed.

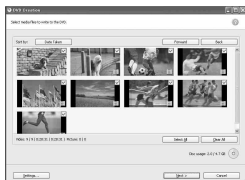

5 Confirm the images to write to the DVD.

💡 Tips

- Double-click a thumbnail to playback the image.
- To add images to the previously selected ones, select the images you want to add in the image display area on the main window and drag and drop onto this window.

6 Click [Next].

Menu selection window of the DVD is displayed.

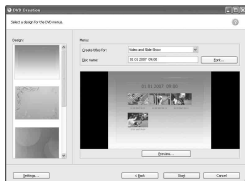

7 Select menu design and a title creation method, and enter the DVD name.

Image of DVD video menu to create is displayed.

Tips

- Selecting [Menu Sorted by Date Taken] in the Menu structure drop-down list automatically changes the order of movies and still images into the order of date on which they were recorded.
- Clicking [Font] lets you select the text color of the DVD name and title, etc.
- Clicking [Preview] lets you check the completion image of the DVD video to create.
- Clicking [Settings] lets you set the various operations that take place upon the first play of a DVD, movie quality, and display time for each still image in slide show.

8 Click [Start].

The images are written to the DVD.

Tips

- You can choose to create more copies of the same DVD after writing to the DVD is completed.

Saving movies in the Playlist to a DVD

You can save movies listed in a Playlist on the hard disk of your camcorder on a DVD using [Playlist Disc Creation] in the HDD Handycam Utility.

1 Turn on the computer.

2 Place the recordable DVD to be saved in the DVD drive of your computer.

3 Connect the Handycam Station to the wall socket using the supplied AC Adaptor.

4 Set the camcorder onto the Handycam Station, then turn the POWER switch to turn on.

5 Connect the (USB) jack of the Handycam Station to a computer using the supplied USB cable.

The [USB SELECT] screen is displayed on the LCD screen of your camcorder.

- For connecting with the USB cable, see page 78.

6 Touch [COMPUTER] on the LCD screen of your camcorder.

The [HDD Handycam Utility] window is displayed on the computer screen.

7 Click [Playlist Disc Creation] in the [HDD Handycam Utility] window on the computer screen.



8 Click [Start].

The movies listed in a Playlist on your camcorder are displayed as thumbnails.



9 Confirm the movies to write to a DVD.

The movies with checkmarks at the top right are written on the DVD in the Playlist order.

10 Click [Next].

The menu selection window of the DVD is displayed.

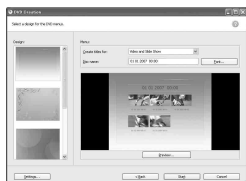

11 Select a menu design and a title creation method, and enter the DVD name.

Image of DVD video menu to create is displayed.

💡 Tips

- Selecting [Menu Sorted by Date Taken] in the Menu structure drop-down list automatically changes the order of movies and still images into the order of date on which they were recorded.
- Clicking [Font] lets you select the text color of the DVD name and title, etc.
- Clicking [Preview] lets you check the completion image of the DVD video to create.
- Clicking [Settings] lets you set the various operations that take place upon the first play of a DVD, movie quality, and display time for each still image in slide show.

12 Click [Start].

DVD creation starts.

💡 Tips

- You can choose to create more copies of the same DVD after writing to the DVD is completed.

Copying a DVD

You can copy the images recorded on a DVD to another DVD.

You can also back up a DVD.

This procedure describes how to copy the images recorded on a DVD-RW (12 cm) to a DVD-R (12 cm) in the DVD drive of your computer.

1 Turn on the computer.

2 Insert a recorded DVD into the DVD drive of your computer.

3 Click [Start] → [All Programs] (for Windows 2000, click [Programs]) → [Sony Picture Utility] → [Video Disc Copier] on your computer.

Disc copy window is displayed.

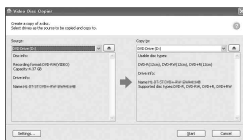

4 Select a DVD drive for [Source:] and [Copy to:].

The status of the drive and DVD is displayed. Depending on the status, copying cannot start. Follow the instruction to change the DVD.

Obtaining information from a DVD of your computer takes time. Wait until the DVD information is displayed in the window.

5 When preparations for copying are completed, click [Start].

DVD copy starts.

Tips

- You can choose to create more copies of the same DVD after writing to the DVD is completed.

To change the location for temporary files and the writing speed

On the Disc copy window, click [Settings]. Select [Manually select a writing speed before writing to the disc] and click [OK] to specify the writing speed each time, before writing starts.

Tips

- Depending on the capacity of the source DVD, the free space required on your hard disk for temporary files varies.

Manipulating still images

You can manipulate imported still images as follows. For details about the operation, refer to the Picture Motion Browser Help.

Printing still images

You can print imported still images. You can also print still images with the date information.

Tips

- You can save a scene you select from the movie as a still image and print it.

Sending still images by e-mail

You can start your e-mail software, attach still images to e-mail and send them via e-mail.

Notes

- MAPI must be enabled in your e-mail software for this feature to work. Refer to the user manual or help files of your e-mail software for more information about MAPI.
- Movie data files cannot be sent by e-mail.

Opening with external applications

You can start a commercially available application via Picture Motion Browser and view images with these applications.

Troubleshooting

If you run into any problems using your camcorder, use the following table to troubleshoot the problem. If the problem persists, disconnect the power source and contact your Sony dealer.

- Overall operations/Easy Handycam operation/Remote Commander94
- Batteries/Power sources95
- LCD screen.....96
- “Memory Stick Duo”96
- Recording97
- Playing back images on your camcorder99
- Editing images on your camcorder 100
- Dubbing/Connecting to other devices100
- Connecting to a computer100
- Functions that cannot be used simultaneously 102

Notes before sending your camcorder for repair

- Your camcorder may be required to initialize or change the current hard disk of the camcorder, depending on the problem. In the event of this, the data stored on the hard disk will be deleted. Be sure to save the data on the internal hard disk (p. 37) on other media (backup) before sending your camcorder for repair. We will not compensate you for any loss of hard disk data.
- During repair, we may check a minimum amount of data stored on the hard disk in order to investigate the problem. However, your Sony dealer will neither copy nor retain your data.

Overall operations/Easy Handycam operation/Remote Commander

The power does not turn on.

- Attach a charged battery pack to the camcorder (p. 13).
- Connect the plug of the AC Adaptor to the wall socket (p. 13).
- Set the camcorder onto the Handycam Station securely (p. 13).

The camcorder does not operate even when the power is set to on.

- It takes a few seconds for your camcorder to be ready to shoot after the power is turned on. This is not a malfunction.
- Disconnect the AC Adaptor from the wall socket or remove the battery pack, then reconnect it after about 1 minute. If the functions still do not work, press the RESET button (p. 119) using a sharp-pointed object. (If you press the RESET button, all settings, including the clock setting, are reset.)
- The temperature of your camcorder is extremely high. Turn off your camcorder and leave it for a while in a cool place.
- The temperature of your camcorder is extremely low. Turn off the camcorder and take it to a warm place. Leave the camcorder there for a while, then turn on the camcorder.

Buttons do not work.

- During Easy Handycam operation, the following buttons/functions are not available.
 - BACK LIGHT button (p. 28)
 - Playback zoom (p. 33)
 - To turn on and off the LCD backlight (Pressing and holding the DISP/BATT INFO button for a few seconds) (p. 19)



The (OPTION) button is not displayed.

- The OPTION MENU cannot be used during Easy Handycam operation.

The menu settings have changed automatically.

- During Easy Handycam operation, nearly all the menu items will be automatically set to the default settings.
- During Easy Handycam operation, some menu items are fixed as follows.
 - [REC MODE] : [SP]
 - [ QUALITY] : [FINE]
 - [DATA CODE] : [DATE/TIME]
- Following menu items return to the default settings when you set the POWER switch to OFF (CHG) for more than 12 hours.
 - [FOCUS]
 - [SPOT FOCUS]
 - [EXPOSURE]
 - [SPOT METER]
 - [SCENE SELECTION]
 - [WHITE BAL.]
 - [MICREF LEVEL]
 - [DROP SENSOR]

Even if you press EASY, menu settings do not switch to their defaults automatically.

- During Easy Handycam operation, settings for the following menu items are maintained the ones before Easy Handycam operation.
 - [FILE NO.]
 - [VOLUME]
 - [TV TYPE]
 - [ DISPLAY]
 - [BEEP]
 - [CLOCK SET]
 - [AREA SET]
 - [SUMMERTIME]
 - [WIDE SELECT]*¹
 - [ IMAGE SIZE]*²
 - [DEMO MODE]
 - [TIMING]*²
 - [STILL MEDIA]
 - [ LANGUAGE SET]

- [RECORD SOUND]*²
- [FLASH MODE]*³

*¹DCR-SR32E/SR33E/SR42E

*²DCR-SR190E/SR200E/SR290E/SR300E

*³DCR-SR52E/SR62E/SR72E/SR82E

Your camcorder gets warm.

- This is because the power has been turned on for a long time. This is not a malfunction.

The supplied Remote Commander does not function (except for DCR-SR32E/SR33E/SR42E).

- Set [REMOTE CTRL] to [ON] (p. 64).
- Insert a battery into the battery holder with the +/- polarities correctly matching the +/- marks (p. 122).
- Remove any obstructions between the Remote Commander and the remote sensor.
- Point the remote sensor away from strong light sources such as direct sunlight or overhead lighting. Otherwise, the Remote Commander may not function properly.

Another DVD device malfunctions when you use the supplied Remote Commander (except for DCR-SR32E/SR33E/SR42E).

- Select a commander mode other than DVD 2 for your DVD device, or cover the sensor of your DVD device with black paper.

Batteries/Power sources

The power abruptly turns off.

- When approximately 5 minutes have elapsed while you do not operate your camcorder, the camcorder is automatically turned off (A.SHUT OFF). Change the setting of [A.SHUT OFF] (p. 64), or turn on the power again, or use the AC Adaptor.
- Charge the battery pack (p. 13).

The CHG (charge) lamp does not light while the battery pack is being charged.

- Turn the POWER switch to OFF (CHG) (p. 13).
- Attach the battery pack to the camcorder correctly (p. 13).
- Connect the mains lead to the wall socket properly.
- The battery charge is completed (p. 13).
- Set the camcorder onto the Handycam Station securely (p. 13).

The CHG (charge) lamp flashes while the battery pack is being charged.

- Attach the battery pack to the camcorder correctly (p. 13). If the problem persists, disconnect the AC Adaptor from the wall socket and contact your Sony dealer. The battery pack may be damaged.

The remaining battery time indicator does not indicate the correct time.

- The temperature of the environment is too high or too low. This is not a malfunction.
- The battery pack has not been charged enough. Fully charge the battery again. If the problem persists, replace the battery pack with a new one (p. 13).
- The indicated time may not be correct depending on the environment of use.

The battery pack is quickly discharged.

- The temperature of the environment is too high or low. This is not a malfunction.
- The battery pack has not been charged enough. Fully charge the battery again. If the problem persists, replace the battery pack with a new one (p. 13).

LCD screen

The buttons do not appear on the touch panel.

- Touch the LCD screen lightly.
- Press DISP/BATT INFO on your camcorder (or DISPLAY on the Remote Commander (except for DCR-SR32E/SR33E/SR42E)) (p. 19).

The buttons on the touch panel do not work correctly or do not work at all.

- Adjust the touch panel ([CALIBRATION]) (p. 115).

Menu items are grayed out.

- You cannot select grayed items in the current recording/playback situation.
- There are some functions you cannot activate simultaneously (p. 102).

“Memory Stick Duo”

You cannot operate functions using the “Memory Stick Duo.”

- If you use a “Memory Stick Duo” formatted on a computer, format it again on your camcorder (p. 50).

You cannot delete images stored on or format the “Memory Stick Duo.”

- The maximum number of still images that you can delete on the index screen at one time is 100.
- You cannot delete still images that have write-protection set by another device.

The data file name is not indicated correctly or flashes.

- The file is damaged.
- The file format is not supported by your camcorder (p. 111). Use the supported file format.

Recording

Refer also to “Memory Stick Duo” (p. 96).

Pressing START/STOP or PHOTO does not record images.

- The playback screen is displayed. Set your camcorder to recording standby (p. 24).
- Your camcorder is recording the image you have just shot on the hard disk. You cannot make new recording during this period (p. 24).
- The hard disk of the camcorder is full. Delete unnecessary images (p. 38).
- Total number of movies or still images exceeds the recordable capacity of your camcorder (p. 57, 110). Delete unnecessary images (p. 38).
- While activating [DROP SENSOR] (p. 64), you may not record images.
- The temperature of your camcorder is extremely high. Turn off your camcorder and leave it for a while in a cool place.
- The temperature of your camcorder is extremely low. Turn off the camcorder and take it to a warm place. Leave the camcorder there for a while, then turn on the camcorder.

You cannot record a still image.

- The playback screen is displayed. Set your camcorder to recording standby (p. 24).
- You can capture up to 3 still images only during movie recording (DCR-SR190E/SR200E/SR290E/SR300E).
- The “Memory Stick Duo” has run out of space. Use a new “Memory Stick Duo” or format the “Memory Stick Duo” (p. 50). Or delete the unnecessary images (p. 39).
- You cannot record a still image together with:
 - [SMTH SLW REC] (DCR-SR190E/SR200E/SR290E/SR300E)
 - [FADER]
 - [D.EFFECT]
 - [PICT.EFFECT]

The ACCESS lamp remains lit even when you stop recording.

- Your camcorder is recording the image you have just shot on the hard disk.

The recording angle looks different.

- Recording angle may vary depending on the condition of the camcorder. This is not a malfunction.

The flash does not work (except for DCR-SR32E/SR33E/SR42E).

- You cannot record with the flash with:
 - Capturing still images while recording a movie
 - The conversion lens (optional) attached
- Even if auto flash or  (Auto redeye reduction) is selected, you cannot use the flash with:
 - NightShot
 - [SUPER NIGHTSHOT]
 - [TWILIGHT], [CANDLE], [SUNRISE&SUNSET], [FIREWORKS], [LANDSCAPE], [SPOTLIGHT], [BEACH] or [SNOW] in [SCENE SELECTION]
 - [MANUAL] in [EXPOSURE]
 - [SPOT METER]

The actual recording time for movie is less than the expected approximate recording time of the hard disk.

- Depending on an object, such as a fast moving object, the time available for recording may shorten (p. 54).

The recording stops.

- The temperature of your camcorder is extremely high. Turn off your camcorder and leave it for a while in a cool place.
- The temperature of your camcorder is extremely low. Turn off the camcorder and take it to a warm place. Leave the camcorder there for a while, then turn on the camcorder.
- If you keep applying vibration on the camcorder, recording may stop.

There is a time difference between the point where you press START/STOP and the point that the recorded movie starts/stops.

- On your camcorder, there may be a slight time difference between the point where you press START/STOP and the actual point that recording movie starts/stops. This is not a malfunction.

The auto focus does not function.

- Set [FOCUS] to [AUTO] (p. 67).
- The recording conditions are not suitable for auto focus. Adjust the focus manually (p. 67).

[STEADYSHOT] does not function.

- Set [STEADYSHOT] to [ON] (p. 55).
- [STEADYSHOT] may not be able to compensate for excessive vibrations.

The BACK LIGHT function does not function.

- The BACK LIGHT function cannot be used during Easy Handycam operation.

The subjects passing by the frame very fast appear crooked (DCR-SR190E/SR200E/SR290E/SR300E).

- This is called the focal plane phenomenon. This is not a malfunction. Because of the way the image device (CMOS sensor) reads out image signals, the subjects passing by the frame rapidly might appear crooked depending on the recording conditions.

Tiny spots in white, red, blue, or green appear on the screen.

- The spots appear when you are recording with [S. NIGHTSHOT PLS] (DCR-SR32E/SR33E/SR42E/SR52E/SR62E/SR72E/SR82E), [SUPER NIGHTSHOT] (DCR-SR190E/SR200E/SR290E/SR300E) or [COLOR SLOW SHTR]. This is not a malfunction.

The color of the image is not correctly displayed.

- Set the NIGHTSHOT PLUS switch (DCR-SR32E/SR33E/SR42E/SR52E/SR62E/SR72E/SR82E) or NIGHTSHOT switch (DCR-SR190E/SR200E/SR290E/SR300E) to OFF (p. 27).

The screen image is bright, and the subject does not appear on the screen.

- Set the NIGHTSHOT PLUS switch (DCR-SR32E/SR33E/SR42E/SR52E/SR62E/SR72E/SR82E) or NIGHTSHOT switch (DCR-SR190E/SR200E/SR290E/SR300E) to OFF (p. 27).

The screen image is dark, and the subject does not appear on the screen.

- Press and hold DISP/BATT INFO for a few seconds to turn on the backlight (p. 19).

A vertical band appears when recording candlelight or electric light in the dark (DCR-SR32E/SR33E/SR42E/SR52E/SR62E/SR72E/SR82E).

- This occurs when the contrast between the subject and the background is too high. This is not a malfunction.

Horizontal stripes appear on the image (DCR-SR190E/SR200E/SR290E/SR300E).

- This occurs when recording images under a fluorescent lamp, sodium lamp, or mercury lamp. This is not a malfunction.

A vertical white line may appear on an image taken in bright light (DCR-SR32E/SR33E/SR42E/SR52E/SR62E/SR72E/SR82E).

- This phenomenon is called the smear effect. This is not a malfunction.

Undesirable flicker occurs (DCR-SR32E/SR33E/SR42E/SR52E/SR62E/SR72E/SR82E).

- This occurs when recording images under a fluorescent lamp, sodium lamp, or mercury lamp. This is not a malfunction.

Black bands appear when you record a TV screen or computer screen (except for DCR-SR290E/SR300E).

- Set [STEADYSHOT] to [OFF] (p. 55).

[S. NIGHTSHOT PLS] cannot be operated (DCR-SR32E/SR33E/SR42E/SR52E/SR62E/SR72E/SR82E).

- Set the NIGHTSHOT PLUS switch to ON.

[SUPER NIGHTSHOT] cannot be operated (DCR-SR190E/SR200E/SR290E/SR300E).

- Set the NIGHTSHOT switch to ON.

[COLOR SLOW SHTR] does not operate correctly.

- [COLOR SLOW SHTR] may not operate correctly in total darkness. Use NightShot plus or [S. NIGHTSHOT PLS] (DCR-SR32E/SR33E/SR42E/SR52E/SR62E/SR72E/SR82E), NightShot or [SUPER NIGHTSHOT] (DCR-SR190E/SR200E/SR290E/SR300E).

You cannot adjust [LCD BL LEVEL].

- You cannot adjust [LCD BL LEVEL] when:
 - The LCD panel is closed on your camcorder with the LCD screen facing out.
 - The power is supplied from the AC Adaptor.

Playing back images on your camcorder

Still images stored on a “Memory Stick Duo” cannot be played back.

- Still images cannot be played back if you have modified files or folders, or have edited the data on a computer. (The file name flashes in that case.) This is not a malfunction (p. 112).
- Still images recorded by other devices may not be played back, or appeared in the actual size. This is not a malfunction (p. 112).

“?” is indicated on an image in the VISUAL INDEX screen.

- Loading of the data may have failed. It may be indicated correctly when you turn off the power and then turn it on again, or repeat removing and inserting the “Memory Stick Duo” a couple of times.

- This may appear on still images recorded by other devices, edited on a computer, etc.

No sound or only a quiet sound is heard during playback.

- Turn up the volume (p. 32).
- Sound is not output when the LCD panel is closed. Open the LCD panel.
- When you record sound with [MICREF LEVEL] (p. 71) set to [LOW], the recorded sound may be difficult to hear.
- In case of [SMTH SLW REC], you cannot record sounds during shooting (about 3 seconds) (DCR-SR190E/SR200E/SR290E/SR300E).

Editing images on your camcorder

Unable to edit.

- There are no images recorded.
- Unable to edit because of the condition of the image.

Movies cannot be added in the Playlist.

- The hard disk is full, or the added movies exceed 99. Erase unnecessary movies (p. 43).
- You cannot add still images in the Playlist.

A movie cannot be divided.

- A movie that is too short cannot be divided.
- A movie protected on another device cannot be divided.

Unable to copy the images from the hard disk to a “Memory Stick Duo.”

- You cannot copy a movie from the hard disk to a “Memory Stick Duo” as a still image during playback on your camcorder.

Dubbing/Connecting to other devices

You cannot hear the sound.

- The audio will not be output when you connect a device via the S VIDEO plug only. Connect the white and red plugs of the A/V connecting cable, too (p. 35).

The aspect ratio of the playback is not correct when connecting your camcorder to the TV.

- Set [TV TYPE] depending on your TV (p. 62).

You cannot dub correctly using the A/V connecting cable.

- The A/V connecting cable is not connected properly. Make sure that the A/V connecting cable is connected to the proper jack, i.e. to the input jack of another device for dubbing a image from your camcorder (p. 45).

Connecting to a computer

The computer does not recognize your camcorder.

- Install Picture Motion Browser (p. 75).
- Disconnect the USB device other than the keyboard, the mouse, and the camcorder from the computer.
- Disconnect the cable from the computer and the Handycam Station, restart the computer, then connect them again correctly.
- Check if Media Check Tool is running on the computer. For details on Media Check Tool, refer to the Help for Picture Motion Browser.



Cannot use the supplied software, Picture Motion Browser, on the Macintosh computer.

- You cannot use Picture Motion Browser on a Macintosh.





The One Touch Disc Burn function does not work.

- Install Picture Motion Browser (p. 75).
- Check if Media Check Tool is running on the computer. For details on Media Check Tool, refer to the Help for Picture Motion Browser.

You cannot view the images recorded on your camcorder with a computer.



- Make sure you insert the connector in the correct direction, then connect the USB cable to the ψ (USB) jack on the Handycam Station and the computer firmly.
- Touch  (OTHERS) → [COMPUTER] → [ COMPUTER] on the HOME MENU of the camcorder (p. 81).
- Disconnect the USB device other than the keyboard, the mouse, and the camcorder from the computer.

You cannot view the still images recorded on a “Memory Stick Duo” on the computer.

- Insert the “Memory Stick Duo” firmly.
- Touch  (OTHERS) → [COMPUTER] → [ COMPUTER] on the HOME MENU of the camcorder (p. 83).
- When you connect your camcorder to a computer by selecting [ COMPUTER], you cannot view the still images stored in a “Memory Stick Duo.” Make sure that you have connected the camcorder to the computer with [ COMPUTER].

- The computer does not recognize the “Memory Stick Duo” during camcorder operation such as playback or editing of images on the hard disk. Finish camcorder operation before connecting the camcorder to the computer.

The “Memory Stick” icon ([Removable Disk]) does not appear on the computer screen.

- Insert a “Memory Stick Duo” into your camcorder.
- Disconnect the USB device other than the keyboard, the mouse, and the camcorder from the computer.
- Touch  (OTHERS) → [COMPUTER] → [ COMPUTER] on the HOME MENU of the camcorder (p. 83).
- The computer does not recognize the “Memory Stick Duo” during camcorder operation such as playback or editing of images on the hard disk. Finish camcorder operation before connecting the camcorder to the computer.

Picture Motion Browser does not function correctly.

- Close Picture Motion Browser, then restart the Windows computer.

The image or sound recorded on the camcorder is not played on the computer correctly.

- If your camcorder is connect to a computer that does not support Hi-speed USB (USB 2.0), the movie/still image or sound may not be played back correctly. The movie/still image or sound imported to your computer is not affected.
- Movie playback or sound may stop temporarily depending on your computer. The movie or sound imported to your computer is not affected.

The playback screen is paused or distorted.

- Check the recommended computer environment required to play movies.

The actual displayed screen or message is different from that shown in this Handbook.

- The screen or message may be different.

The extension of a file is not displayed on your computer.

- To display the extension, follow the steps below:
 - ① Click [Tool] in the window folder → [Folder option...] → [View] tab.
 - ② Remove the check mark from the [Hide file extensions for known file types] under Advanced Settings.
 - ③ Click [OK].

While performing Easy PC Back-up, [Not enough space on destination hard disk.] is displayed on the computer screen.

- Delete unnecessary files from your computer to free hard disk space.

Functions that cannot be used simultaneously

The following list shows examples of unworkable combinations of functions and menu items.

Cannot use	Because of following settings
BACK LIGHT	[FIREWORKS] in [SCENE SELECTION], [MANUAL] in [EXPOSURE], [SPOT METER]
WIDE SELECT* ¹	[OLD MOVIE]
[WIDE SELECT]* ²	[OLD MOVIE]
[STEADY SHOT]* ³	[SMTH SLW REC]
[AUTO SLW SHUTTR]	[S. NIGHTSHOT PLS]* ⁴ , [SUPER NIGHTSHOT]* ⁵ , [COLOR SLOW SHTR], [D.EFFECT], [SCENE SELECTION], [SMTH SLW REC]* ⁵
[SPOT FOCUS]	[SCENE SELECTION]
[TELE MACRO]	[SCENE SELECTION]
[EXPOSURE]	NightShot plus* ⁴ , [S. NIGHTSHOT PLS]* ⁴ , NightShot* ⁵ , [SUPER NIGHTSHOT]* ⁵
[SPOT METER]	NightShot plus* ⁴ , [S. NIGHTSHOT PLS]* ⁴ , NightShot* ⁵ , [SUPER NIGHTSHOT]* ⁵

Cannot use	Because of following settings
[SCENE SELECTION]	NightShot plus* ⁴ , [S. NIGHTSHOT PLS]* ⁴ , NightShot* ⁵ , [SUPER NIGHTSHOT]* ⁵ , [COLOR SLOW SHTR], [OLD MOVIE], [TELE MACRO], [FADER]
[WHITE BAL.]	NightShot plus* ⁴ , [S. NIGHTSHOT PLS]* ⁴ , NightShot* ⁵ , [SUPER NIGHTSHOT]* ⁵
[ONE PUSH] in [WHITE BAL.]	[SMTH SLW REC]* ⁵
[COLOR SLOW SHTR]	[FADER], [D.EFFECT], [SCENE SELECTION]
[S. NIGHTSHOT PLS]* ⁴	[FADER], [D.EFFECT]
[SUPER NIGHTSHOT]* ⁵	[FADER], [D.EFFECT]
[FADER]	[S. NIGHTSHOT PLS]* ⁴ , [SUPER NIGHTSHOT]* ⁵ , [COLOR SLOW SHTR], [D.EFFECT], [CANDLE]/ [FIREWORKS] in [SCENE SELECTION]
[D.EFFECT]	[S. NIGHTSHOT PLS]* ⁴ , [SUPER NIGHTSHOT]* ⁵ , [COLOR SLOW SHTR], [FADER]
[OLD MOVIE]	[SCENE SELECTION], [PICT.EFFECT]
[PICT.EFFECT]	[OLD MOVIE]

*¹ DCR-SR52E/SR62E/SR72E/SR82E/SR190E/SR200E/SR290E/SR300E

*² DCR-SR32E/SR33E/SR42E

*³ DCR-SR190E/SR200E

*⁴ DCR-SR32E/SR33E/SR42E/SR52E/SR62E/SR72E/SR82E

*⁵ DCR-SR190E/SR200E/SR290E/SR300E

Warning indicators and messages

Self-diagnosis display/Warning indicators

If indicators appear on the LCD screen, check the following.

Some symptoms you can fix by yourself. If the problem persists even after you have tried a couple of times, contact your Sony dealer or local authorized Sony service facility.

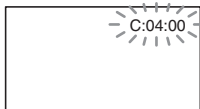

C:(or E:) □□:□□ (Self-diagnosis display)

C:04:□□

- The battery pack is not an "InfoLITHIUM" battery pack. Use an "InfoLITHIUM" battery pack (p.112).
- Connect the DC plug of the AC Adaptor to the DC IN jack of the Handycam Station or your camcorder securely (p. 13).

C:13:□□ / C:32:□□

- Remove the power source. Reconnect it and operate your camcorder again.
- Turn on your camcorder again.

E:20:□□ / E:31:□□ / E:61:□□ / E:62:□□ / E:91:□□ / E:94:□□

- A malfunction that you cannot service has occurred. Contact your Sony dealer or local authorized Sony service facility. Inform them of the 5-digit code, which starts from "E".

101-0001 (Warning indicator pertaining to files)

Slow flashing

- The file is damaged.
- The file is unreadable.

(Warning on the hard disk of the camcorder)*

Fast flashing

- An error may have occurred with the hard disk drive in your camcorder.

(Warning on the hard disk of the camcorder)*

Fast flashing

- The hard disk of the camcorder is fully recorded.
- An error may have occurred with the hard disk drive in your camcorder.

(Battery level warning)

Slow flashing

- The battery pack is nearly used up.
- Depending on the operating environment or battery conditions,  may flash, even if there are approximately 20 minutes remaining.

(High temperature warning)

Slow flashing

- The temperature of your camcorder is getting higher. Turn off your camcorder and leave it for a while in a cool place.

Fast flashing*

- The temperature of your camcorder is extremely high. Turn off your camcorder and leave it for a while in a cool place.

(Low temperature warning)*

Fast flashing

- The temperature of your camcorder is extremely low. Make the camcorder warm.

 **(Warning indicator pertaining to “Memory Stick Duo”)**



- No “Memory Stick Duo” is inserted (p. 27).

 **(Warning indicators pertaining to “Memory Stick Duo” formatting)***

- The “Memory Stick Duo” is damaged.
- The “Memory Stick Duo” is not formatted correctly (p. 50, 111).

 **(Warning indicator pertaining to incompatible “Memory Stick Duo”)***

- An incompatible “Memory Stick Duo” is inserted (p. 111).

  **(Warning indicator pertaining to the write-protect of the “Memory Stick Duo”)***

- The write-protect tab on the “Memory Stick Duo” is set to lock (p. 111).
- Access to the “Memory Stick Duo” was restricted on another device.

 **(Warning indicator pertaining to the flash)**

Fast flashing

- There is something wrong with the flash.

 **(Warning indicator pertaining to camera-shake warning)**

- The amount of lights is not sufficient, so camera-shake easily occurs. Use the flash.
- The camcorder is unsteady, so camera-shake easily occurs. Hold the camcorder steady with both hands and shoot the image. However, note that the camera-shake warning indicator does not disappear.

 **(Warning indicator pertaining to drop sensor)**

- The drop sensor function (p. 64) is activated, and has detected that the camcorder has been dropped. Therefore, the camcorder is taking steps to protect the hard disk. Recording/playback may be disabled as a result.
- The drop sensor function does not guarantee the protection of the hard disk under all possible situations. Use the camcorder under stable conditions.

* You hear a melody when the warning indicators appear on the screen (p. 61).

Description of warning messages

If messages appear on the screen, follow the instructions.

 **Hard disk**

 **Movie folder full. Cannot record movies.**

- Delete unnecessary images (p. 38) or perform [FORMAT] (p. 49).

 **HDD format error.**

- The hard disk of the camcorder is set differently from the default format. Performing [FORMAT] (p. 49) may enable you to use your camcorder. This will delete all data in the hard disk.

Data error.

- An error occurred during reading or writing the hard disk of the camcorder. This may occur when you keep applying shock on the camcorder.

Management file damaged. Create new file?

- The image management file is damaged. When you touch [YES], a new image management file is created. The old recorded images on the hard disk of the camcorder cannot be played back. (Image files are not damaged.) In this case, import the image files to your computer.

Buffer overflow

- You cannot record because the drop sensor senses a drop of the camcorder repeatedly. If you may be at risk of dropping the camcorder constantly, set [DROP SENSOR] to [OFF], and you may be able to record the image again (p. 64).

Recovering data

- Your camcorder tries to recover data automatically if the data writing was not performed properly.

Cannot recover data.

- Writing data onto the hard disk of the camcorder has failed. Attempts were made to recover the data, but they were unsuccessful.

■ “Memory Stick Duo”

Reinsert the Memory Stick.

- Reinsert the “Memory Stick Duo” a few times. If even then the indicator flashes, the “Memory Stick Duo” could be damaged. Try with another “Memory Stick Duo.”

This Memory Stick is not formatted correctly.

- Check the format, then format the “Memory Stick Duo” with your camcorder if necessary (p. 50).

Memory Stick folders are full.

- You cannot create folders exceeding 999MSDCF. You cannot create or delete created folders using your camcorder.
- You will have to format the “Memory Stick Duo” (p. 50), or delete them using your computer.

Cannot save still picture.

- When using the Dual Rec function, do not remove the still image recording media from the camcorder until recording is finished and still image recording is complete (p. 26).

■ PictBridge compliant printer

Not connected to PictBridge compatible printer.

- Turn off the printer and on again, then remove the USB cable (supplied) and reconnect it.

Cannot print. Check the printer.

- Turn off the printer and on again, then remove the USB cable (supplied) and reconnect it.

■ Other

No further selection is possible.

- You can select only 100 images at one time for:
 - deleting images
 - printing still images
-

Data protected.

- You tried to delete data protected on another device. Release the protection of the data on the device used to protect the data.
-

Cannot divide.

- You cannot divided a movie that is extremely short.

Using your camcorder abroad

Power supply

You can use your camcorder in any countries/regions using the AC Adaptor supplied with your camcorder within the AC 100 V to 240 V, 50/60 Hz range.

On TV color systems

Your camcorder is a PAL-system-based camcorder. If you want to view the playback image on a TV, it must be a PAL-system-based TV with an AUDIO/VIDEO input jack.

System	Used in
PAL	Australia, Austria, Belgium, China, Czech Republic, Denmark, Finland, Germany, Holland, Hong Kong, Hungary, Italy, Kuwait, Malaysia, New Zealand, Norway, Poland, Portugal, Singapore, Slovak Republic, Spain, Sweden, Switzerland, Thailand, United Kingdom, etc.
PAL - M	Brazil
PAL - N	Argentina, Paraguay, Uruguay.
NTSC	Bahama Islands, Bolivia, Canada, Central America, Chile, Colombia, Ecuador, Guyana, Jamaica, Japan, Korea, Mexico, Peru, Surinam, Taiwan, the Philippines, the U.S.A., Venezuela, etc.
SECAM	Bulgaria, France, Guiana, Iran, Iraq, Monaco, Russia, Ukraine, etc.

Setting to the local time

You can easily set the clock to the local time by setting a time difference when using your camcorder abroad. Set **⏸** (SETTINGS) → [CLOCK/ **A**LANG] → [AREA SET] and [SUMMERTIME] on the HOME MENU (p. 17).

World time difference

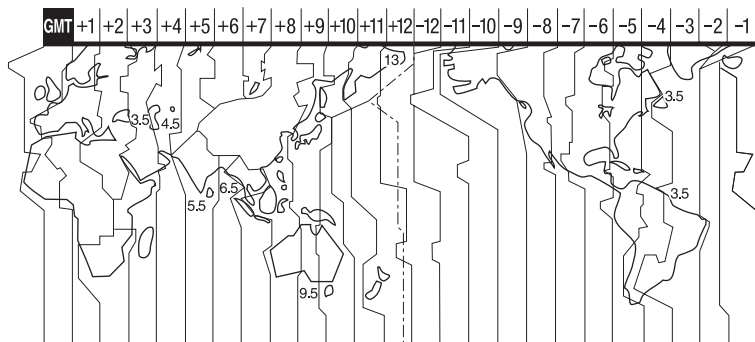

Time-zone differences	Area setting
GMT	Lisbon, London
+01:00	Berlin, Paris
+02:00	Helsinki, Cairo, Istanbul
+03:00	Moscow, Nairobi
+03:30	Tehran
+04:00	Abu Dhabi, Baku
+04:30	Kabul
+05:00	Karachi, Islamabad
+05:30	Calcutta, New Delhi
+06:00	Almaty, Dhaka
+06:30	Rangoon
+07:00	Bangkok, Jakarta
+08:00	HongKong, Singapore, Beijing
+09:00	Seoul, Tokyo
+09:30	Adelaide, Darwin
+10:00	Melbourne, Sydney

Time-zone differences	Area setting
+11:00	Solomon Is.
+12:00	Fiji, Wellington
-12:00	Eniwetok, Kwajalein
-11:00	Samoa
-10:00	Hawaii
-09:00	Alaska
-08:00	LosAngeles, Tijuana
-07:00	Denver, Arizona
-06:00	Chicago, Mexico City
-05:00	NewYork, Bogota
-04:00	Santiago
-03:30	St. John's
-03:00	Brasilia, Montevideo
-02:00	Fernando de Noronha
-01:00	Azores, Cape Verde Is.

Files on the camcorder hard disk/folder structure

The file/folder structure is shown below. You do not usually need to acknowledge the file/folder structure, when recording/playing back images on the camcorder. To enjoy still images or movies by connecting to a computer, see page 73, then use the supplied application.

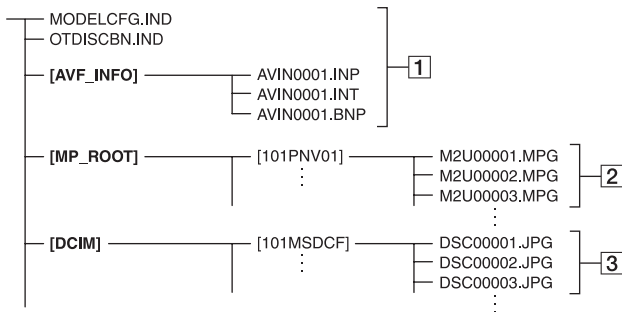

1 Image management files

When you delete the files, you cannot record/play back the images correctly. The files are defaulted as hidden files and not usually displayed.

2 Movie (MPEG2 files)

The extension of the files is “.MPG”. The maximum size is 2 GB. When the capacity of a file exceeds 2 GB, the file becomes divided.

The file numbers go up automatically. When the file numbers exceeds 9,999, another folder is created to record new movie files.

The folder name goes up: [101PNV01]
→ [102PNV01]

3 Still image files (JPEG files)

The extension of the files is “.JPG”. The file numbers go up automatically. When the capacity of a file number exceeds 9,999, another folder is created to store new image files.

The folder name goes up: [101MSDCF]
→ [102MSDCF]

- Do not modify the files or folders on the camcorder through the computer without using the supplied computer application. The image files may be destroyed or may not be played back.
- Operation is not guaranteed, if you perform the above operation without using the supplied computer application.
- Do not format the hard disk of the camcorder using the computer. The camcorder may not operate correctly.
- When the file extensions are not displayed on the computer screen, see page 102.
- Do not copy the files on the hard disk of the camcorder from the computer. Operation is not guaranteed.
- When the folder number shows 999 and file number exceeds 9,999, recording may not be possible. In this case, perform [⊖] FORMAT (p. 49).

For DCR-SR32E/SR33E/SR52E/SR72E/SR190E/SR290E only:

- You cannot import data on the hard disk of the camcorder from the computer.

- By selecting [⊖COMPUTER] on [USB SELECT], you can access the hard disk of the camcorder from the computer through USB connection.

Maintenance and precautions

About the “Memory Stick”

A “Memory Stick” is a compact, portable IC recording medium with a large data capacity.

However, we do not guarantee the operation of all types of “Memory Stick Duo” on your camcorder. (See the list below for more details.)

Types of “Memory Stick”	Recording/ Playback
“Memory Stick” (without MagicGate)	—
“Memory Stick Duo” ^{*1} (without MagicGate)	○
“MagicGate Memory Stick”	—
“Memory Stick Duo” ^{*1} (with MagicGate)	○ ^{*2*3}
“MagicGate Memory Stick Duo” ^{*1}	○ ^{*3}
“Memory Stick PRO”	—
“Memory Stick PRO Duo” ^{*1}	○ ^{*2*3}

^{*1} A “Memory Stick Duo” is about half the size of a standard “Memory Stick.”

^{*2} The types of “Memory Stick” that support high speed data transfer. The speed of data transfer varies depending on the device to be used.

^{*3} “MagicGate” is a copyright protection technology that records and transfers the contents in an encrypted format. Note that data that uses “MagicGate” technology cannot be recorded or played on your camcorder.

- Still image format: Your camcorder compresses and records image data in the JPEG (Joint Photographic Experts Group) format. The file extension is “.JPG.”
- File names of still images:
 - 101- 0001: This file name appears on the screen of your camcorder.
 - DSC00001.JPG: This file name appears on the display of a computer.
- A “Memory Stick Duo” formatted by a computer (Windows OS/Mac OS) does not have guaranteed compatibility with your camcorder.

- Data read/write speed may vary depending on the combination of the “Memory Stick” and “Memory Stick” compliant product you use.

On a “Memory Stick Duo” with a write-protect tab

You can prevent accidental erasure of images when you slide the write-protect tab on the “Memory Stick Duo” with a small tapered object, to the write-protect position.

Notes on use

Damaged or lost image data will not be compensated for, and may occur in the following cases:

- If you eject the “Memory Stick Duo,” turn the power off on your camcorder, or remove the battery pack for replacement while your camcorder is reading or writing image files on the “Memory Stick Duo” (while the ACCESS lamp is lit or flashing).
- If you use the “Memory Stick Duo” near magnets or magnetic fields.

It is recommended you make a back-up of important data on the hard disk of a computer.

■ On handling a “Memory Stick”

Keep the following in mind when handling a “Memory Stick Duo.”

- Be careful not to apply excessive force when writing on a memo area on a “Memory Stick Duo.”
- Do not attach a label or the like on a “Memory Stick Duo” or a Memory Stick Duo adaptor.
- When you carry or store a “Memory Stick Duo,” put it in its case.
- Do not touch, or allow metallic objects to come into contact with the terminals.
- Do not bend, drop or apply strong force to the “Memory Stick Duo.”
- Do not disassemble or modify the “Memory Stick Duo.”
- Do not let the “Memory Stick Duo” get wet.
- Be careful to keep “Memory Stick Duo” media out of the reach of small children. There is danger that a child might swallow it.

- Do not insert anything other than a “Memory Stick Duo” into the “Memory Stick Duo” slot. Doing so may cause a malfunction.

■ On a location for use

Do not use or keep the “Memory Stick Duo” in the following locations:

- Places subject to extremely high temperature, such as a car parked outside in the summer.
- Places under direct sunlight.
- Places with extremely high humidity or subject to corrosive gases.

■ On the Memory Stick Duo adaptor

After inserting a “Memory Stick Duo” into the Memory Stick Duo adaptor, you can use it with a standard “Memory Stick” compliant device.

- When using a “Memory Stick Duo” with a “Memory Stick” compliant device, be sure to insert the “Memory Stick Duo” into a Memory Stick Duo adaptor.
- When inserting a “Memory Stick Duo” into a Memory Stick Duo adaptor, make sure the “Memory Stick Duo” is inserted facing in the correct direction, then insert it all the way in. Note that improper use may cause a malfunction. Also, if you force the “Memory Stick Duo” into the Memory Stick Duo adaptor in the wrong direction, it may be damaged.
- Do not insert a Memory Stick Duo adaptor without a “Memory Stick Duo” attached. Doing so may result in malfunctions of the unit.

■ On a “Memory Stick PRO Duo”

The maximum memory capacity of a “Memory Stick PRO Duo” that can be used on your camcorder is 4 GB.

On image data compatibility

- Image data files recorded on a “Memory Stick Duo” by your camcorder conform to the “Design rule for Camera File system” universal standard established by the JEITA (Japan Electronics and Information Technology Industries Association).
- On your camcorder, you cannot play back still images recorded on other devices (DCR-TRV900E or DSC-D700/D770) that do not conform to the universal standard. (These models are not sold in some regions.)

- If you cannot use a “Memory Stick Duo” that has been used with another device, format it with your camcorder (p. 50). Note that formatting erases all information on the “Memory Stick Duo.”
- You may not be able to play back images with your camcorder:
 - When playing back image data modified on your computer.
 - When playing back image data recorded with other devices.

About the “InfoLITHIUM” battery pack

Your camcorder operates only with an “InfoLITHIUM” battery pack (H series). “InfoLITHIUM” H series battery packs have the  mark.

What is an “InfoLITHIUM” battery pack?

An “InfoLITHIUM” battery pack is a lithium-ion battery pack that has functions for communicating information related to operating conditions between your camcorder and an optional AC Adaptor/charger.

The “InfoLITHIUM” battery pack calculates the power consumption according to the operating conditions of your camcorder, and displays the remaining battery time in minutes.

With an AC Adaptor/charger, the remaining battery time and charging time appear.

To charge the battery pack

- Be sure to charge the battery pack before you start using your camcorder.
- We recommend charging the battery pack in an ambient temperature of between 10 °C to 30 °C (50 °F to 86 °F) until the CHG (charge) lamp turns off. If you charge the battery pack outside of this temperature range, you may not be able to charge it efficiently.
- After charging is complete, disconnect the cable from the DC IN jack on the Handycam Station or your camcorder, then remove the battery pack.

To use the battery pack effectively

- Battery pack performance decreases when the surrounding temperature is 10 °C (50 °F) or below, and the length of time you can use the battery pack becomes shorter. In that case, do one of the following to use the battery pack for a longer time.
 - Put the battery pack in a pocket to warm it up, and insert it in your camcorder right before you start taking shots.
 - Use a large capacity battery pack: NP-FH70/FH100 (optional).
- Frequent use of the LCD screen or a frequent playback, fast forward or rewind operation wears out the battery pack faster. We recommend using a large capacity battery pack: NP-FH70/FH100.
- Be sure to set the POWER switch to OFF (CHG) when not recording or playing back on your camcorder. The battery pack is also consumed when your camcorder is in recording standby or playback pause.
- Have spare battery packs ready for two or three times the expected recording time, and make trial recordings before making the actual recording.
- Do not expose the battery pack to water. The battery pack is not water resistant.

About the remaining battery time indicator

- When the power goes off even though the remaining battery time indicator indicates that the battery pack has enough power to operate, charge the battery pack fully again. Remaining battery time will be indicated correctly. Note, however, that the battery indication will not be restored if it is used in high temperatures for a long time, or if left in a fully charged state, or when the battery pack is frequently used. Use the remaining battery time indication as a rough guide only.
- The  mark that indicates low battery flashes even if there are still 5 to 10 minutes of battery time remaining, depending on the operating conditions or ambient temperature.

About storage of the battery pack

- If the battery pack is not used for a long time, fully charge the battery pack and use it up on your camcorder once a year to maintain proper function. To store the battery pack, remove it from your camcorder and put it in a dry, cool place.
- To discharge the battery pack on your camcorder completely, touch  (SETTINGS) → [GENERAL SET] → [A.SHUT OFF] → [NEVER] on the HOME MENU and leave your camcorder in recording standby until the power goes off (p. 64).

About battery life

- Battery capacity decreases over time and through repeated use. If decreased usage time between charges becomes significant, it is probably time to replace it with a new one.
- Each battery's life is governed by storage, operating and environmental conditions.

About handling of your camcorder

On use and care

- Do not use or store the camcorder and accessories in the following locations:
 - Anywhere extremely hot, cold or humid. Never leave them exposed to temperatures above 60 °C (140 °F), such as under direct sunlight, near heaters or in a car parked in the sun. They may malfunction or become deformed.
 - Near strong magnetic fields or mechanical vibration. The camcorder may malfunction.
 - Near strong radio waves or radiation. The camcorder may not be able to record properly.
 - Near AM receivers and video equipment. Noise may occur.
 - On a sandy beach or anywhere dusty. If sand or dust gets in your camcorder, it may malfunction. Sometimes this malfunction cannot be repaired.
 - Near windows or outdoors, where the LCD screen or the lens may be exposed to direct sunlight. This damages the inside of the LCD screen.
- Operate your camcorder on DC 6.8 V/7.2 V (battery pack) or DC 8.4 V (AC Adaptor).
- For DC or AC operation, use the accessories recommended in these operating instructions.
- Do not let your camcorder get wet, for example, from rain or sea water. If your camcorder gets wet, it may malfunction. Sometimes this malfunction cannot be repaired.
- If any solid object or liquid gets inside the casing, unplug your camcorder and have it checked by a Sony dealer before operating it any further.
- Avoid rough handling, disassembling, modifying, physical shock, or impact such as hammering, dropping or stepping on the product. Be particularly careful of the lens.
- Keep the POWER switch setting to OFF (CHG) when you are not using your camcorder.
- Do not wrap your camcorder with a towel, for example, and operate it. Doing so might cause heat to build up inside.
- When disconnecting the mains lead, pull it by the plug and not the cord.

- Do not damage the mains lead such as by placing anything heavy on it.
- Keep metal contacts clean.
- Keep the Remote Commander and button-type battery out of children's reach. If the battery is accidentally swallowed, consult a doctor immediately (DCR-SR52E/SR62E/SR72E/SR82E/SR190E/SR200E/SR290E/SR300E).
- If the battery electrolytic liquid has leaked:
 - consult your local authorized Sony service facility.
 - wash off any liquid that may have contacted your skin.
 - if any liquid gets in your eyes, wash with plenty of water and consult a doctor.

■ When not using your camcorder for a long time

- Periodically turn it on and let it run such as by playing back or recording images for about 3 minutes.
- Use up the battery pack completely before storing it.

Moisture condensation

If your camcorder is brought directly from a cold place to a warm place, moisture may condense inside your camcorder. This may cause a malfunction to your camcorder.

■ If moisture condensation has occurred

Leave your camcorder for about 1 hour without turning it on.

■ Note on moisture condensation

Moisture may condense when you bring your camcorder from a cold place into a warm place (or vice versa) or when you use your camcorder in a humid place as follows:

- You bring your camcorder from a ski slope into a place warmed up by a heating device.
- You bring your camcorder from an air conditioned car or room into a hot place outside.
- You use your camcorder after a squall or a shower.
- You use your camcorder in a hot and humid place.

■ How to prevent moisture condensation

When you bring your camcorder from a cold place into a warm place, put your camcorder in a plastic bag and seal it tightly. Remove the bag when the air temperature inside the plastic bag has reached the surrounding temperature (after about 1 hour).

LCD screen



- Do not exert excessive pressure on the LCD screen, as it may cause damage.
- If your camcorder is used in a cold place, a residual image may appear on the LCD screen. This is not a malfunction.
- While using your camcorder, the back of the LCD screen may heat up. This is not a malfunction.

■ To clean the LCD screen

If fingerprints or dust make the LCD screen dirty, it is recommended you use a soft cloth to clean it. When you use the LCD Cleaning Kit (optional), do not apply the cleaning liquid directly to the LCD screen. Use cleaning paper moistened with the liquid.

■ On adjustment of the touch panel (CALIBRATION)

The buttons on the touch panel may not work correctly. If this happens, follow the procedure below. It is recommended that you connect your camcorder to the wall socket using the supplied AC Adaptor during the operation.

- ① Turn on your camcorder, then press  (HOME).
- ② Touch  (SETTINGS) → [GENERAL SET] → [CALIBRATION].

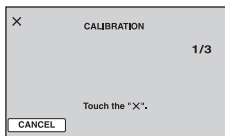

- ③ Touch "X" displayed on the screen with the corner of the "Memory Stick Duo" or the like. The position of "X" changes. Touch [CANCEL] to cancel.

If you did not press the right spot, try the calibration again.

🔔 Notes

- Do not use a sharp-pointed object for calibration. Doing so may damage the LCD screen.
- You cannot calibrate the LCD screen if it is rotated, or closed with the screen facing out.

On handling the casing

- If the casing is soiled, clean the camcorder body with a soft cloth lightly moistened with water, and then wipe the casing with a dry soft cloth.
- Avoid the following to avoid damage to the finish:
 - Using chemicals such as thinner, benzene, alcohol, chemical cloths, repellent, insecticide and sunscreen.
 - Handling the camcorder with above substances on your hands.
 - Leaving the casing in contact with rubber or vinyl objects for a long period of time.

About care and storage of the lens

- Wipe the surface of the lens clean with a soft cloth in the following instances:
 - When there are fingerprints on the lens surface.
 - In hot or humid locations
 - When the lens is exposed to salty air such as at the seaside.
- Store in a well-ventilated location subject to little dirt or dust.
- To prevent mold, periodically clean the lens as described above. It is recommended that you operate your camcorder about once a month to keep it in optimum state for a long time.

On charging the pre-installed rechargeable battery

Your camcorder has a pre-installed rechargeable battery to retain the date, time, and other settings even when the POWER switch is set to OFF (CHG). The pre-installed rechargeable battery is always charged while your camcorder is connected to the wall socket via the AC Adaptor or while the battery pack is attached. The rechargeable battery will be fully discharged in about **3 months** if you do not use your camcorder at all. Use your camcorder after charging the pre-installed rechargeable battery.

However, even if the pre-installed rechargeable battery is not charged, the camcorder operation will not be affected as long as you are not recording the date.

■ Procedures

Connect your camcorder to a wall socket using the supplied AC Adaptor, and leave it with the POWER switch set to OFF (CHG) for more than 24 hours.

On trademarks

- “Handycam” and **HANDYCAM** are registered trademarks of Sony Corporation.
- “Memory Stick,” “,” “Memory Stick Duo,” “**MEMORY STICK DUO**,” “Memory Stick PRO Duo,” “**MEMORY STICK PRO DUO**,” “MagicGate,” “**MAGIC GATE**,” “MagicGate Memory Stick” and “MagicGate Memory Stick Duo” are trademarks of Sony Corporation.
- “InfoLITHIUM” is a trademark of Sony Corporation.
- DVD-R, DVD+R DL, DVD-RW, and DVD+RW logo are trademarks.
- Dolby and the double-D symbol are trademarks of Dolby Laboratories.
- Dolby Digital 5.1 Creator is a trademark of Dolby Laboratories.
- Microsoft, Windows, and Windows Media are trademarks or registered trademarks of U.S. Microsoft Corporation in the U.S. and other countries.
- Macintosh and Mac OS are registered trademarks of Apple Inc. in the U.S. and other countries.
- Intel, Intel Core, and Pentium are trademarks or registered trademarks of Intel Corporation or its subsidiaries in the United States and other countries.
- Adobe, the Adobe logo, and Adobe Acrobat are either registered trademarks or trademarks of Adobe Systems Incorporated in the United States and/or other countries.

All other product names mentioned herein may be the trademarks or registered trademarks of their respective companies. Furthermore, “™” and “©” are not mentioned in each case in this Handbook.

Notes on the License

ANY USE OF THIS PRODUCT OTHER THAN CONSUMER PERSONAL USE IN ANY MANNER THAT COMPLIES WITH THE MPEG-2 STANDARD FOR ENCODING VIDEO INFORMATION FOR PACKAGED MEDIA IS EXPRESSLY PROHIBITED WITHOUT A LICENSE UNDER APPLICABLE PATENTS IN THE MPEG-2 PATENT PORTFOLIO, WHICH LICENSE IS AVAILABLE FROM MPEG LA, L.L.C., 250 STEELE STREET, SUITE 300, DENVER, COLORADO 80206.

“C Library,” “Expat,” “zlib,” and “libjpeg” software are provided in your camcorder. We provide this software based on license agreements with their owners of copyright. Based on requests by the owners of copyright of these software applications, we have an obligation to inform you of the following. Please read the following sections.

Read “license1.pdf” in the “License” folder on the CD-ROM. You will find licenses (in English) of “C Library,” “Expat,” “zlib,” and “libjpeg” software.

On GNU GPL/LGPL applied software

The software that is eligible for the following GNU General Public License (hereinafter referred to as “GPL”) or GNU Lesser General Public License (hereinafter referred to as “LGPL”) are included in the camcorder.

This informs you that you have a right to have access to, modify, and redistribute source code for these software programs under the conditions of the supplied GPL/LGPL.

Source code is provided on the web. Use the following URL to download it. When downloading the source code, select HDR-UX1/HDR-SR1 as the model for your camcorder.

<http://www.sony.net/Products/Linux/>

We would prefer you do not contact us about the contents of source code.

Read “license2.pdf” in the “License” folder on the CD-ROM. You will find licenses (in English) of “GPL,” and “LGPL” software.

To view the PDF, Adobe Reader is needed. If it is not installed on your computer, you can download it from the Adobe Systems web page:

<http://www.adobe.com/>



Identifying parts and controls

The numbers in () are reference pages.

**DCR-SR32E/SR33E/SR42E/SR52E/SR62E/
SR72E/SR82E:**

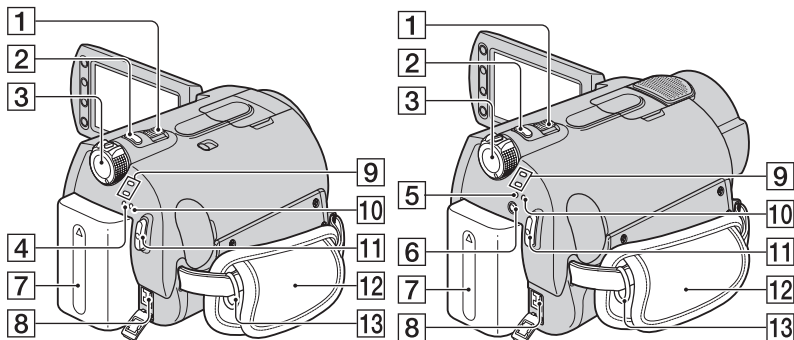
DCR-SR190E/SR200E/SR290E/SR300E:





- 1** Power zoom lever (25, 33)
- 2** PHOTO button (20, 24)
- 3** POWER switch (17)
- 4** CHG (charge) lamp (13)
- 5** CHG (charge)/ ζ (flash) lamp (13, 26)
- 6** ζ (flash) button (26)
- 7** Battery pack (13)
- 8** DC IN jack (13)
- 9**  (Movie)/  (Still) mode lamps (23)
- 10** ACCESS lamp (Hard disk) (23)
- 11** START/STOP button (20, 24)
- 12** Grip belt (19)
- 13** Hooks for a shoulder belt
Attach a shoulder belt (optional).

**DCR-SR32E/SR33E/SR42E/SR52E/SR62E/
SR72E/SR82E:**

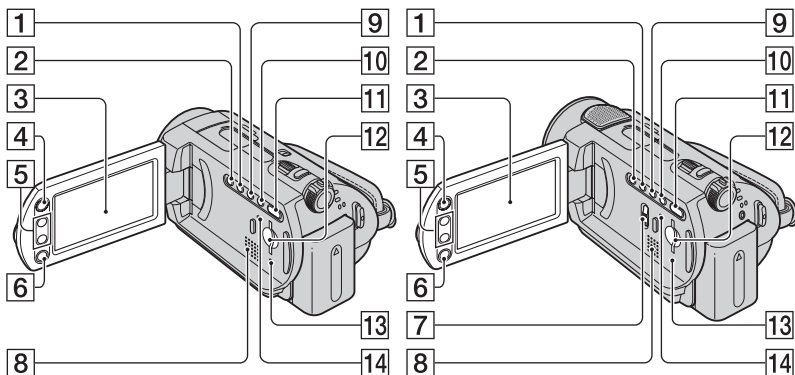
DCR-SR190E/SR200E/SR290E/SR300E:



- 1** WIDE SELECT button (except for DCR-SR32E/SR33E/SR42E) (28)
- 2** BACK LIGHT button* (28)
- 3** LCD screen/touch panel (19)
- 4**  (HOME) button (10, 52)
- 5** Zoom buttons (25, 33)
- 6** START/STOP button (20, 24)
- 7** NIGHTSHOT switch (27)
- 8** Speaker
For how to adjust the volume, see page 32.
- 9** DISP/BATT INFO button (14, 19)
- 10** EASY button (20)
- 11**  (VIEW IMAGES) button (21, 31)
- 12** Memory Stick Duo slot (27)
- 13** ACCESS lamp (“Memory Stick Duo”) (27)
- 14** RESET button
Initializes all the settings, including the setting of the date and time.

* For DCR-SR32E/SR33E/SR42E, the position of the buttons differ from the illustration above.

**DCR-SR32E/SR33E/SR42E/SR52E/SR62E/
SR72E/SR82E:**

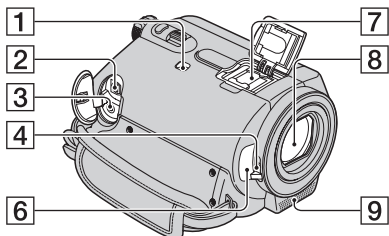

DCR-SR190E/SR200E/SR290E/SR300E:

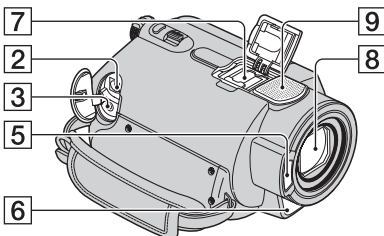

1 NIGHTSHOT PLUS switch (27)

2 A/V OUT jack (35, 45)

3 REMOTE jack (except for DCR-SR32E/SR33E/SR42E)

Connect other optional accessories.

4 Lens cover switch (19)

5 Flash (26)

6 Remote sensor (except for DCR-SR32E/SR33E/SR42E) /Infrared port
Point the Remote Commander (p. 122) towards the remote sensor to operate your camcorder.

7 Active Interface Shoe  (except for DCR-SR32E/SR33E/SR42E)
The Active Interface Shoe supplies power to optional accessories such as a video light, a flash, or a microphone. The accessory can be turned on or off as you operate the POWER switch on your camcorder. Refer to the operating instructions supplied with your accessory for details.

The Active Interface Shoe has a safety device for fixing the installed accessory securely. To connect an accessory, press down and push it to the end, and then tighten the screw. To remove an accessory, loosen the screw, and then press down and pull out the accessory.

- When you are recording movies with an external flash (optional) connected to the accessory shoe, turn off the power of the external flash to prevent charging noise being recorded.

- You cannot use an external flash (optional) and the built-in flash at the same time.

- When an external microphone (optional) is connected, it takes precedence over the built-in microphone (p. 25).

8 Lens (Carl Zeiss Lens) (3)

9 Built-in microphone (25)

An Active Interface Shoe compatible microphone (optional) will take precedence when connected.

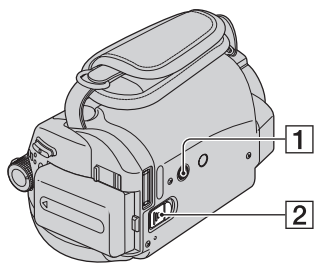

- 1** Tripod receptacle
Attach the tripod (optional: the length of the screw must be less than 5.5 mm (7/32 in.)) to the tripod receptacle using a tripod screw.
- 2** BATT (battery) release lever (14)

Handycam Station:

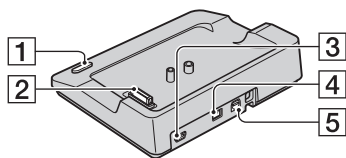

- 1** DISC BURN button (78)
- 2** Interface connector
- 3** Ψ (USB) jack (46, 78)
DCR-SR32E/SR33E/SR52E/SR72E/
SR190E/SR290E: output only
- 4** DC IN jack (13)
- 5** A/V OUT jack (35, 45)

Remote Commander (DCR-SR52E/SR62E/SR72E/SR82E/ SR190E/SR200E/SR290E/SR300E)

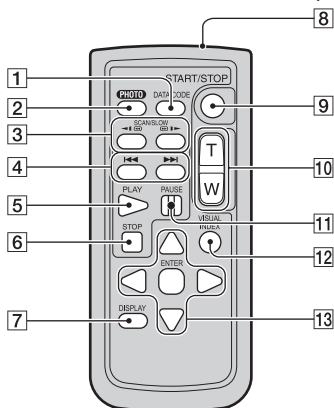

- 1 DATA CODE button (60)
Displays the date and time or camera setting data of the recorded images when you press this during playback.
- 2 PHOTO button (20, 24)
The on-screen image when you press this button will be recorded as a still image.
- 3 SCAN/SLOW buttons (21, 32)
- 4 ◀▶▶▶ (Previous/Next) buttons (22, 32)
- 5 PLAY button (21, 32)
- 6 STOP button (21, 32)
- 7 DISPLAY button (14)
- 8 Transmitter
- 9 START/STOP button (20, 24)
- 10 Power zoom buttons (25, 33)
- 11 PAUSE buttons (21, 32)
- 12 VISUAL INDEX button (21, 31)
Displays the VISUAL INDEX screen when you press this during playback.
- 13 ◀/▶/▲/▼/ENTER buttons
When you press any button on the VISUAL INDEX screen or Playlist, the orange frame appears on the LCD screen. Select a desired

button or an item with ◀/▶/▲/▼, then press ENTER to enter.

Notes

- Remove the insulation sheet before using the Remote Commander.

Insulation sheet

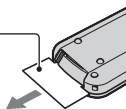

- Point the Remote Commander towards the remote sensor to operate your camcorder (p. 120).
- When no commands have been sent from the Remote Commander in a certain period, the orange frame disappears. When you press any of ◀/▶/▲/▼, or ENTER again, the frame appears at the position where it was displayed last.
- You cannot select some buttons on the LCD screen using ◀/▶/▲/▼.

To change the battery of the Remote Commander

- 1 While pressing on the tab, inset your fingernail into the slit to pull out the battery case.
- 2 Place a new battery with the + side facing up.
- 3 Insert the battery case back into the Remote Commander until it clicks.

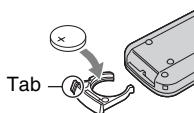

WARNING

Battery may explode if mistreated. Do not recharge, disassemble or dispose of in fire.

- When the lithium battery becomes weak, the operating distance of the Remote Commander may shorten, or the Remote Commander may not function properly. In this case, replace the battery with a Sony CR2025 lithium battery. Use of another battery may present a risk of fire or explosion.

Indicators displayed during recording/playback

Recording movies

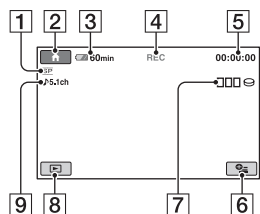

- 1 Recording mode (HQ/SP/LP) (54)
- 2 HOME button (10, 52)
- 3 Remaining battery (approx.) (14)
- 4 Recording status ([STBY] (standby) or [REC] (recording))
- 5 Counter (hour/minute/second)
- 6 OPTION button (65)
- 7 Dual Rec (DCR-SR190E/SR200E/SR290E/SR300E) (26)
- 8 VIEW IMAGES button (21, 31)
- 9 5.1ch surround recording (DCR-SR190E/SR200E/SR290E/SR300E) (25)

Recording still images

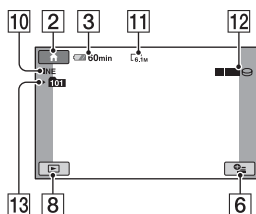

- 10 Quality ([FINE] / [STD]) (58)
- 11 Image size (57)
- 12 Appears while a still image is being saved.
- 13 Recording folder
Displays only during the recording media of still images is a "Memory Stick Duo."

💡 Tips

- When using the Dual Rec function, the movie and still image shooting screens are both shown together. The display position differs slightly from that during normal operation (DCR-SR190E/SR200E/SR290E/SR300E).
- As the number of still images recorded on a "Memory Stick Duo" increases, new folders are automatically created to store them.

Viewing movies

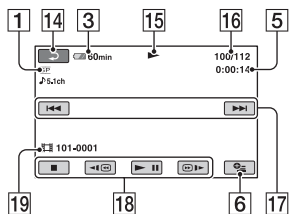

- 1** Recording mode (HQ/SP/LP) (54)
- 3** Remaining battery (approx.) (14)
- 5** Counter (hour/minute/second)
- 6** OPTION button (65)
- 14** Return button
- 15** Playback mode
- 16** Current movie number/Number of total movies
- 17** Previous/Next button (32)
- 18** Video operation buttons (21, 32)
- 19** Data file name

Viewing still images

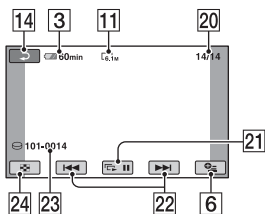

- 11** Image size (57)
- 20** Current still image number /Number of recorded still images
- 21** Slide show button (34)
- 22** Previous/Next button (22, 32)
- 23** Data file name
- 24** VISUAL INDEX button (21, 31)

Indicators when you made changes

Following indicators appear during recording/playback to indicate the settings of your camcorder.

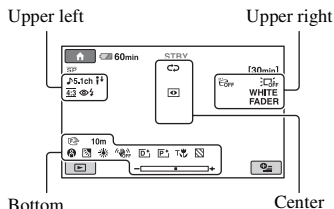

Upper left

Indicator	Meaning
	5.1ch surround recording/playback*1 (25)
	Self-timer recording (71)
	Flash (26, 59, 72)
	MICREF LEVEL low (71)
	WIDE SELECT*2 (54)
	WIDE SELECT*3 (28)

Upper right

Indicator	Meaning
	Fader (71)
	LCD backlight off (19)
	Drop sensor off (64)
	Drop sensor activated (64)

Center

Indicator	Meaning
	Slide show set (34)
	NightShot plus*4 / NightShot*1 (27)
	Super NightShot plus*4 (70) Super NightShot*1 (70)
	Color Slow Shutter (70)
	PictBridge connecting (46)
	Warning (104)

Bottom

Indicator	Meaning
	Picture effect (71)
	Digital effect (71)
	Manual focus (67)
	SCENE SELECTION (68)
	Backlight (28)
	White balance (69)
	SteadyShot off (55)
	EXPOSURE (68)/ SPOT METER (68)
	Tele macro (67)
	Zebra*1 (56)

*1 DCR-SR190E/SR200E/SR290E/SR300E

*2 DCR-SR32E/SR33E/SR42E

*3 DCR-SR52E/SR62E/SR72E/SR82E/SR190E/
SR200E/SR290E/SR300E

*4 DCR-SR32E/SR33E/SR42E/SR52E/SR62E/
SR72E/SR82E

Data code during recording

The recording date and time is recorded automatically on the hard disk and “Memory Stick Duo.” They are not displayed while recording. However, you can check them as [DATA CODE] during playback (p. 60).

Glossary

■ 5.1ch surround sound

A system that plays back sound on 6 speakers, 3 at the front (left, right and center) and 2 at the rear (right and left) with an additional low-pass subwoofer counted as a 0.1 channel for frequencies of 120 Hz or lower.

■ Dolby Digital

An audio encoding (compression) system developed by Dolby Laboratories Inc.

■ Dolby Digital 5.1 Creator

Sound compression technology developed by Dolby Laboratories Inc. which compresses audio efficiently while preserving high sound quality. It enables recording of 5.1ch surround sound while using hard disk space more efficiently. DVDs created by Dolby Digital 5.1 Creator can be played back on a compatible DVD device. You can enjoy more realistic sound by playing the movie on the device that supports 5.1ch surround sound.

■ Fragmentation

The condition of a hard disk in which files are divided into pieces scattered around the hard disk. You may not save your images correctly. You can solve the condition by performing [FORMAT] (p. 49).

■ JPEG

JPEG stands for Joint Photographic Experts Group, a still image data compression (data capacity reduction) standard. Your camcorder records still images in JPEG format.

■ MPEG

MPEG stands for Moving Picture Experts Group, the group of standards for the coding (image compression) of video (movie) and audio. There are MPEG1 and MPEG2 formats. Your camcorder records movies with SD (standard definition) image quality in MPEG2 format.

■ Thumbnail

Reduced-size images which enable you to view many images at the same time. "VISUAL INDEX" use a thumbnail display system.

■ VBR

VBR stands for Variable Bit Rate, the recording format for automatically controlling the bit rate (the volume of recording data in a given time segment) according to the scene being recorded. For fast-moving video, a lot of hard disk space is used to produce a clear image, so the recording time to the hard disk shortens.

■ VISUAL INDEX

This function displays images of movies and still images you have recorded so that you can select those scenes you want to play back.

Index

Numeric

12IMAGES.....	61
16:9.....	36, 62
16:9 WIDE.....	55
21-pin adaptor.....	36
4:3.....	36, 54, 62
5.1ch surround recording.....	25
6IMAGES.....	61

A

AC Adaptor.....	13
ADD.....	42
ADD by date.....	43
AREA SET.....	63
AUTO SLW SHUTTR (Auto Slow Shutter).....	55
A.SHUT OFF (Auto shut off).....	64
A/V connecting cable.....	35, 45

B

BACK LIGHT.....	28
Backup.....	See Save
Battery.....	13, 14
Battery Info.....	14
BEACH.....	69
BEEP.....	61
BLACK FADER.....	71
Button-type lithium battery.....	122
B&W.....	71

C

CALIBRATION.....	115
CAMERA DATA.....	60
CANDLE.....	68
CD-ROM.....	73
Charging time.....	15
CLOCK SET.....	17
CLOCK/LANG.....	63

COLOR SLOW SHTR (Color Slow Shutter).....	70
Compression format.....	111
COMPUTER.....	73
Hard disk.....	80, 82, 83, 85, 91
“Memory Stick Duo”.....	84
Connection.....	
Computer.....	73
Printer.....	46
TV.....	35
VCR or DVD/HDD recorders.....	45
COPIES.....	47
COPY.....	41, 92
COPY by date.....	42
Copyright.....	3, 116

D

DATA CODE.....	60, 126
Date Index.....	33
DATE/TIME.....	18, 47, 60, 126
DC plug.....	13
DELETE.....	
by date.....	39
Hard disk.....	38, 85
“Memory Stick Duo”.....	39
DELETE ALL.....	39
DEMO MODE.....	64
DIGITAL ZOOM.....	55
DISC BURN.....	78, 80
DISP OUTPUT.....	63
DISPLAY.....	61
Display indicators.....	123
DIVIDE.....	40
Dolby Digital 5.1 Creator.....	25
DROP SENSOR.....	64
Dual Rec.....	26
Dubbing.....	45
DVD.....	77, 90
D.EFFECT (Digital effect).....	71

E

Easy Handycam.....	20
Easy PC Back-up.....	81
EDIT.....	40, 41
Editing.....	38
On the camcorder.....	40, 41
On the computer.....	88
EMPTY.....	51
ERASE.....	43
ERASE ALL.....	43
EXPOSURE.....	68
Extension.....	110

F

FADER.....	71
FILE NO. (File number).....	58
FINE.....	58
FIREWORKS.....	69
Flash.....	26
FLASH LEVEL.....	59
FLASH MODE.....	72
FOCUS.....	67
FORMAT.....	
Hard disk.....	49
“Memory Stick Duo”.....	50
Fragmentation.....	127

G

GENERAL SET.....	64
GUIDEFAME.....	56

H

Handycam Station.....	13, 121
HDD Handycam Utility.....	80, 81, 82, 85, 91
HOME MENU.....	9, 52
CLOCK/LANG.....	63
GENERAL SET.....	64
MOVIE SETTINGS.....	54
OUTPUT SETTINGS.....	62
PHOTO SETTINGS.....	57

SOUND/DISP SET	61
VIEW IMAGES SET	60
HQ	54

I

Icon	See Display indicators
Image management files	110
Image quality	58
IMAGE SIZE	57
INDOOR	69
INFO	50
“InfoLITHIUM” battery pack	112
Install	75
Insulation sheet	122

J

JPEG	110, 111, 127
------------	---------------

L

LANDSCAPE	69
LANGUAGE SET	18, 63
LCD backlight	19
LCD BL LEVEL (LCD back light level)	62, 99
LCD BRIGHT	61
LCD COLOR	62
LCD PANEL	63
LCD panel	19
Lens cover	19
LP	54

M

MANAGE HDD/MEMORY category	49
Media File Import	82
“Memory Stick”	111
“Memory Stick Duo”	27, 111
Number of recordable images	57
Memory Stick Duo adaptor	112

MICREF LEVEL	71
Mirror mode	28
Moisture condensation	114
MOVE	44
Movie	20, 24
MOVIE SETTINGS	54
MPEG	127
MPEG2	110

N

NightShot	27
NIGHTSHOT LIGHT	54
NightShot plus	27
NTSC	108
Number of recordable images	57

O

OLD MOVIE	71
ONE PUSH	69
One Touch Disc Burn	77
OPTION MENU	65
Original	42
OTHERS category	38
OUTDOOR	69
OUTPUT SETTINGS	62

P

PAL	108
PASTEL	71
PB zoom	33
PHOTO SETTINGS	57
PictBridge	46
Picture Motion Browser	73, 86, 88, 90
PICT.EFFECT (Picture effect)	71
Playback	21, 31
Playback time	16
Playlist	42
Creating	42

ERASE	43
ERASE ALL	43
MOVE	44
Playback	43
PLAYLIST EDIT	42
PORTRAIT	69
Pre-installed rechargeable battery	116
Print	46
Printer	46

Q

QUALITY	58
---------------	----

R

REC MODE	54
RECORD SOUND	30
Recording	20, 23
Recording time	15
REDEYE REDUC	59
Remaining	
Battery	14
Hard disk	50
REMAINING (movie)	56
Remote Commander	122
REMOTE CTRL (Remote control)	64
RESET	58, 119
RESET button	119

S

S VIDEO cable	35, 45
Save	37
SCENE SELECTION	68
Self-diagnosis display	104
SELF-TIMER	71
SEPIA	71
SERIES	58
SETTINGS category	52
SIZE	47
Slide show	34

SLIDE SHOW SET.....	34
SMTH SLW REC.....	29
SNOW	69
Software.....	75
SOUND/DISP SET	61
SP.....	54
SPORTS	69
SPOT FOCUS	67
SPOT METER (Flexible spot meter).....	68
SPOTLIGHT	69
STANDARD	58
STEADYSHOT.....	55
Still images	20, 24
STILL MEDIA	27
SUMMERTIME.....	63
SUNRISE&SUNSET	68
SUPER NIGHTSHOT.....	70
Supplied items	12
System requirements	74
S. NIGHTSHOT PLS (Super NightShot plus).....	70

T

TELE MACRO.....	67
Thumbnail	127
TIMING.....	30
Trademark	116
Tripod	121
TV.....	35
TV color system	108
TV TYPE.....	36, 62
TWILIGHT	68
TWILIGHT PORT.	68

U

USB cable.....	46, 78, 81
USB SELECT.....	46, 80, 81, 91
Using abroad.....	108

V

VBR	127
VCR or DVD/HDD recorders	45
Video Disc Copier	92
VIEW IMAGES SET.....	60
Viewing images on a TV	35
VISUAL INDEX ...	21, 31, 127
VOLUME	32, 61
Volume adjustment	32
V-OUT/PANEL.....	63

W

Warning indicators.....	104
Warning messages	105
WHITE BAL. (White balance)	69
WHITE FADER	71
WIDE SELECT	54
Windows	73, 74
World time difference.....	109
Write-protect tab	111

Z

ZEBRA	56
Zoom.....	25
ZOOM LINK	61

Additional information on this product and answers to frequently asked questions can be found at our Customer Support Website.

<http://www.sony.net/>