

SONY®

2-891-371-11(1)

Digital Video Camera Recorder
HANDYCAM®

Operating Guide

DCR-HC27E/HC28E

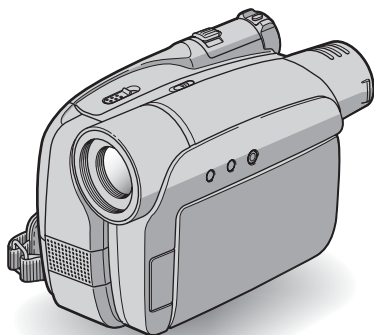

Getting Started **8**



Recording/
Playback **18**

Using the Menu **30**

Dubbing/Editing **45**

Troubleshooting **51**

Additional Information **61**

Mini **DV** Digital
Video
Cassette

i InfoLITHIUM™ **P**
SERIES

Read this first

Before operating the unit, please read this manual thoroughly, and retain it for future reference.

WARNING

To reduce fire or shock hazard, do not expose the unit to rain or moisture.



CAUTION

Replace the battery with the specified type only. Otherwise, fire or injury may result.

FOR CUSTOMERS IN THE UNITED KINGDOM

NOTICE ON THE SUPPLIED AC ADAPTOR

A moulded plug complying with BS 1363 is fitted to this equipment for your safety and convenience.

Should the fuse in the plug supplied need to be replaced, a fuse of the same rating as the supplied one and approved by ASTA or BSI to BS 1362, (i.e., marked with an  or  mark) must be used.

If the plug supplied with this equipment has a detachable fuse cover, be sure to attach the fuse cover after you change the fuse. Never use the plug without the fuse cover. If you should lose the fuse cover, please contact your nearest Sony service station.

FOR CUSTOMERS IN EUROPE

ATTENTION

The electromagnetic fields at the specific frequencies may influence the picture and sound of this camcorder.

This product has been tested and found compliant with the limits set out in the EMC Directive for using connection cables shorter than 3 meters (9.8 feet).

Notice

If static electricity or electromagnetism causes data transfer to discontinue midway (fail), restart the application or disconnect and connect the communication cable (i.LINK, etc.) again.



Disposal of Old Electrical & Electronic Equipment (Applicable in the European Union and other European countries with separate collection systems)

This symbol on the product or on its packaging indicates that this product shall not be treated as household waste. Instead it shall be handed over to the applicable collection point for the recycling of electrical and electronic equipment. By ensuring this product is disposed of correctly, you will help prevent potential negative consequences for the environment and human health, which could otherwise be caused by inappropriate waste handling of this product. The recycling of materials will help to conserve natural resources.

For more detailed information about recycling of this product, please contact your local Civic Office, your household waste disposal service or the shop where you purchased the product.

Notes on use

Types of cassette you can use in your camcorder

- You can use mini DV cassettes marked with **Mini DV**. Mini DV cassettes with Cassette Memory are incompatible (p. 61).

Using the camcorder

- Do not hold the camcorder by the following parts.

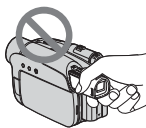

Viewfinder



Battery pack

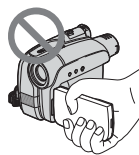

LCD panel

- The camcorder is not dustproof, dripproof or waterproof. See “Maintenance and precautions” (p. 65).
- Before connecting your camcorder to another device with an i.LINK cable, be sure to insert the connector plug the correct way, and not forcibly to avoid damaging the terminal, or cause a malfunction of your camcorder.

About menu items, LCD panel, viewfinder, and lens

- A menu item that is grayed out is not available under the current recording or playback conditions.
- The LCD screen and the viewfinder are manufactured using extremely high-precision technology, so over 99.99% of the pixels are operational for effective use. However, there may be some tiny black points and/or bright points (white, red, blue, or green in color) that appear constantly on the LCD screen and the viewfinder. These points are normal results of the manufacturing process and do not affect the recording in any way.

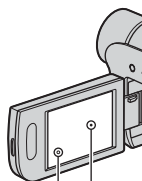

Black point

White, red, blue
or green point

- Exposing the LCD screen, the viewfinder, or the lens to direct sunlight for long periods of time may cause malfunctions.
- Do not aim at the sun. Doing so might cause your camcorder to malfunction. Take pictures of the sun only in low light conditions, such as at dusk.

Read this first (Continued)

On recording

- Before starting to record, test the recording function to make sure the picture and sound are recorded without any problems.
- Compensation for the contents of recordings cannot be provided, even if recording or playback is not possible due to a malfunction of the camcorder, storage media, etc.
- TV color systems differ depending on the countries/regions. To view your recordings on a TV, you need a PAL system-based TV.
- Television programs, films, video tapes, and other materials may be copyrighted. Unauthorized recording of such materials may be contrary to the copyright laws.

About this manual

- The images of the LCD screen and the viewfinder used in this manual for illustration purposes are captured using a digital still camera, and therefore may appear different.
- The on-screen displays in each local language are used for illustrating the operating procedures. Change the screen language before using your camcorder if necessary (p. 14).
- The illustrations used on this manual are based on the model DCR-HC28E. The model name is indicated on the bottom of your camcorder.
- Design and specifications of recording media and accessories are subject to change without notice.

About the Carl Zeiss lens

Your camcorder is equipped with a Carl Zeiss lens, which was developed jointly by Carl Zeiss, in Germany, and Sony Corporation, and produces superior images. It adopts the MTF* measurement system for video cameras and offers a quality typical of a Carl Zeiss lens.

- * MTF stands for Modulation Transfer Function. The number value indicates the amount of light from a subject coming into the lens.

Table of Contents

Read this first	2
-----------------------	---

Getting Started

Step 1: Checking supplied items	8
Step 2: Charging the battery pack	9
Step 3: Turning the power on and holding your camcorder firmly	12
Step 4: Adjusting the LCD panel and viewfinder	13
Step 5: Using the touch panel	14
Changing the language setting	14
Checking the screen indicators (Display guide)	14
Step 6: Setting the date and time	16
Step 7: Inserting a Cassette	17



Recording/Playback

Easy Recording/Playback (Easy Handycam)	18
Recording	20
Playback	21
Functions used for recording/playback, etc.	22

Recording

- To use zoom
- To record in dark places (NightShot plus)
- To adjust the exposure for backlit subjects (BACK LIGHT)
- To adjust the focus for an off center subject (SPOT FOCUS)
- To fix the exposure for the selected subject (Flexible spot meter)
- To record in mirror mode
- To use a tripod
- To use a Shoulder Belt

Playback

- To play back the images with added special effects (Picture effect)

Recording/playback

- To check the remaining battery (Battery Info)
- To turn off the operation confirmation beep (BEEP)
- To initialize the settings (RESET)
- Other part names and functions

Indicators displayed during recording/playback	24
Searching for the starting point	26
Searching for the last scene of the most recent recording (END SEARCH)	26
Searching manually (EDIT SEARCH)	26
Reviewing the most recently recorded scenes (Rec review)	27

Playing the picture on a TV	28
-----------------------------------	----

Using the Menu

<i>Using the menu items</i>	30
Operation button items	32
Menu items	37
 MANUAL SET menu	38
– PROGRAM AE/P EFFECT, etc.	
 CAMERA SET menu	39
– D ZOOM/WIDE SEL/STEADYSHOT, etc.	
 PLAYER SET /  VCR SET menu	41
– AUDIO MIX	
 LCD/VF SET menu	41
– LCD B.L./LCD COLOR/VF B.L., etc	
 TAPE SET menu	42
– REC MODE/AUDIO MODE/REMAIN	
 SETUP MENU menu	43
– CLOCK SET/LANGUAGE, etc.	
 OTHERS menu	44
– WORLD TIME/BEEP, etc.	

Dubbing/Editing

Dubbing to VCR/DVD device, etc.	45
Recording pictures from a TV or VCR/DVD device, etc. (DCR-HC28E)	47
Dubbing sound to a recorded tape	48
Jacks to connect external devices	50

Troubleshooting

Troubleshooting	51
Warning indicators and messages	58

Additional Information

Using your camcorder abroad	61
Usable cassette tapes	61
About the “InfoLITHIUM” battery pack	62
About i.LINK	64
Maintenance and precautions	65
Specifications	68
Index	71

Step 1: Checking supplied items

Make sure that you have following items supplied with your camcorder. The number in the parentheses indicates the number of that item supplied.

AC Adaptor (1) (p. 9)

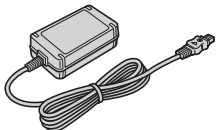

Mains lead (1) (p. 9)

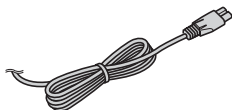

A/V connecting cable (1) (p. 28, 45)



Lens cap (1) (p. 12, 20)



- To attach the lens cap

Attach the lens cap to the metal fittings of the grip belt, as illustrated below, using the strap.

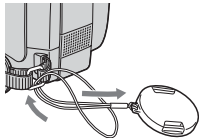

Rechargeable battery pack NP-FP30 (1)
(p. 9, 62)

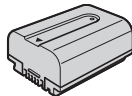

Operating Guide (This manual) (1)

Step 2: Charging the battery pack

You can charge the “InfoLITHIUM” battery pack (P series) (p. 62) after attaching it to your camcorder.

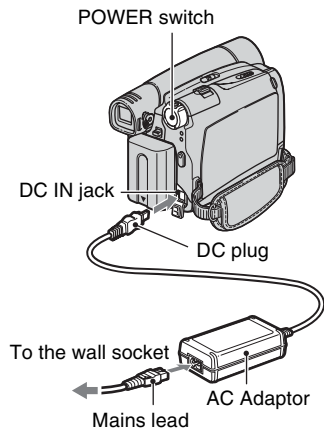

- 1 Align the terminals of the battery pack and your camcorder ①, then attach the battery pack and click it into place ②.

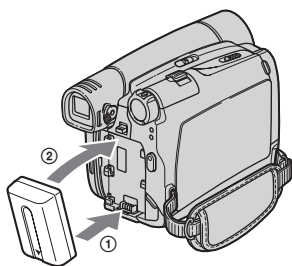

- 2 Slide the POWER switch in the direction of the arrow to OFF(CHG) (The default setting).



- 3 Connect the AC Adaptor to the DC IN jack on your camcorder.

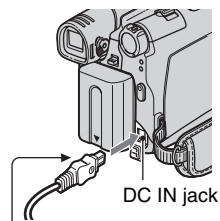

With the ▲ mark facing to the LCD screen

Step2: Charging the battery pack (Continued)

4 Connect the mains lead to the AC Adaptor and the wall socket.

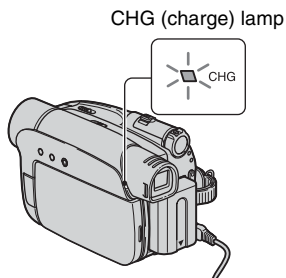

The CHG (charge) lamp lights up and charging starts.

5 The CHG (charge) lamp turns off when the battery is fully charged. Disconnect the AC Adaptor from the DC IN jack.

Disconnect the AC Adaptor from the DC IN jack holding both the camcorder and the DC plug.

To use an outside power source

You can operate your camcorder using the power from the wall socket by making the same connections as you do when charging the battery pack. The battery pack will not lose its charge in this case.

To remove the battery pack

- 1 Slide the POWER switch to OFF(CHG). Hold down the ▼ BATT (battery) release lever with one hand.
- 2 Remove the battery in the direction of the arrow with the other hand.

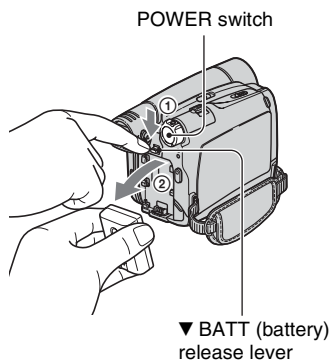

When storing the battery pack

Fully discharge the battery before storing it for an extended period (p. 63).

Charging time

Approximate time (min.) required when you fully charge a fully discharged battery pack.

Battery pack	Charging time
NP-FP30 (supplied)	115
NP-FP50	125
NP-FP71	170
NP-FP90	220

Recording time

Approximate time (min.) available when you use a fully charged battery pack.

Battery pack	Continuous recording time	Typical recording time*
NP-FP30 (supplied)	95	45
	110	55
NP-FP50	135	65
	160	80
NP-FP71	330	165
	395	195
NP-FP90	500	250
	580	290

- All times measured under the following conditions:
Top: Recording with LCD screen.
Bottom: Recording with viewfinder while the LCD panel closed.

* Typical recording time shows the time when you repeat recording start/stop, turning the power on/off and zooming.

Playing time

Approximate time (min.) available when you use a fully charged battery pack.

Battery pack	LCD panel opened	LCD panel closed
NP-FP30 (supplied)	105	135
NP-FP50	150	190
NP-FP71	370	465
NP-FP90	550	705

On the battery pack

- Before changing the battery pack, slide the POWER switch to OFF(CHG).
- The CHG (charge) lamp flashes during charging, or the Battery Info (p. 23) will not be correctly displayed under the following conditions.
 - The battery pack is not attached correctly.
 - The battery pack is damaged.
 - The battery pack is worn-out. (For Battery Info only.)
- The power will not be supplied from the battery as long as the AC Adaptor is connected to the DC IN jack of your camcorder, even when the mains lead is disconnected from the wall socket.

On the charging/recording/playback time

- Times measured with the camcorder at 25 °C (77 °F). (10 °C to 30 °C (50 °F to 86 °F) is recommended.)
- The recording and playback time will be shorter when you use your camcorder in low temperatures.
- The recording and playback time will be shorter depending on the conditions under which you use your camcorder.

On the AC Adaptor

- Use the nearby wall socket when using the AC Adaptor. Disconnect the AC Adaptor from the wall socket immediately if any malfunction occurs while using your camcorder.
- Do not use the AC Adaptor placed in a narrow space, such as between a wall and furniture.
- Do not short-circuit the DC plug of the AC Adaptor or battery terminal with any metallic objects. This may cause a malfunction.

PRECAUTION

- Even if your camcorder is turned off, AC power (mains) is still supplied to it while connected to the wall socket via the AC Adaptor.

Step 3: Turning the power on and holding your camcorder firmly

To record or play back, slide the POWER switch repeatedly to turn on the respective lamp.

When using it for the first time, the [CLOCK SET] screen appears (p. 16).

POWER switch Lens cap

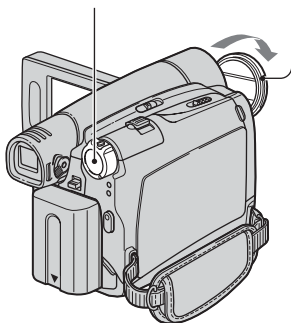

- After you have set the date and time ([CLOCK SET], p. 16), the next time you turn on the power of your camcorder, the current date and time will be displayed on the LCD screen for a few seconds.

3 Hold the camcorder correctly.

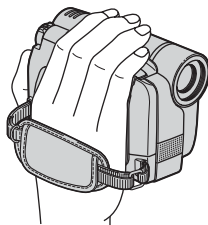

1 Remove the lens cap by pressing both knobs on the sides of the cap.

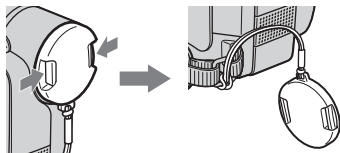

4 Ensure a good grip, then fasten the grip belt.

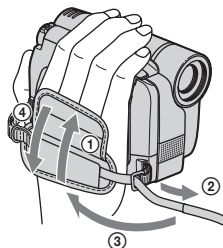

2 Slide the POWER switch repeatedly in the direction of the arrow to turn on the respective lamp.

If the POWER switch is set to OFF(CHG), slide it while pressing the green button.

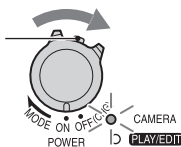

Lamps that light up

CAMERA: To record on a tape.

PLAY/EDIT: To play or edit pictures.

To turn off the power

- ① Slide the POWER switch to OFF(CHG).
- ② Attach the lens cap.

- At the time of purchase, the power will be set to turn off automatically if you leave your camcorder without any operation attempted for approximately 5 minutes, to save battery power ([A.SHUT OFF], p. 44).

Step 4: Adjusting the LCD panel and viewfinder

The LCD panel

Open the LCD panel 90 degrees to the camcorder (①), then rotate it to the best angle to record or play (②).

180 degrees
(max.)

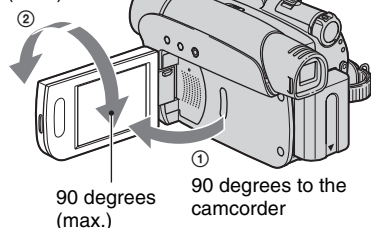

- If you rotate the LCD panel 180 degrees to the lens side, you can close the LCD panel with the LCD screen facing out. This is convenient during playback operations.
- See [LCD BRT] (p. 35) to adjust the brightness of the LCD screen.

The viewfinder

You can view pictures using the viewfinder to avoid wearing down the battery, or when the picture seen on the LCD screen is poor.

Viewfinder

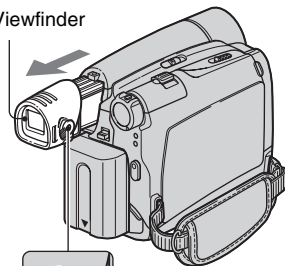

Move it until the picture is clear.

- You can adjust the brightness of the viewfinder backlight by selecting [LCD/VF SET] - [VF B.L.] (p. 42).
- You can adjust the [FADER] and the [EXPOSURE] setting using the viewfinder (p. 33).

Step 5: Using the touch panel

You can play back recorded pictures (p. 21), or change the settings (p. 30) using the touch panel.

Place your hand on the rear side of the LCD panel to support it. Then, touch the buttons displayed on the screen.

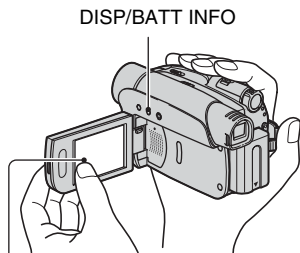



Touch the button on the LCD screen.

- If the buttons on the touch panel do not work correctly, adjust the LCD screen (CALIBRATION) (p. 67).
- Dots in lines may appear on the LCD screen, but this is not a malfunction. These dots are not recorded.

To hide the screen indicators

Press DISP/BATT INFO to toggle the screen indicators (such as time code) on or off.

Changing the language setting

You can change the on-screen displays to show messages in a specified language. Select the screen language in [ LANGUAGE] on the [ (SETUP MENU)] (p. 30, 43).

Checking the screen indicators (Display guide)

You can easily check the meaning of each indicator (p. 25) that appears on the LCD screen.

1 Touch [FN].

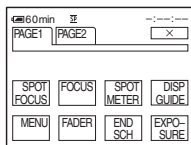

2 Touch [DISP GUIDE].

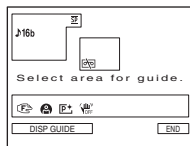

The indicators vary depending on the settings.

3 Touch the area including the indicator that you want to check.

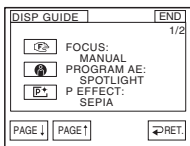

The meanings of the indicators in the area are listed on the screen. If you cannot find the indicator you want to check, touch [PAGE ↓]/[PAGE ↑] to toggle.

When you touch [RET.], the screen returns to the area selecting display.

To finish the operation

Touch [END].

Step 6: Setting the date and time

Set the date and time when using this camcorder for the first time. If you do not set the date and time, the [CLOCK SET] screen appears every time you turn on your camcorder or change the POWER switch position.

- If you do not use your camcorder for **about 3 months**, the built-in rechargeable battery gets discharged and the date and time settings may be cleared from the memory. In that case, charge the rechargeable battery and then set the date and time again (p. 68).

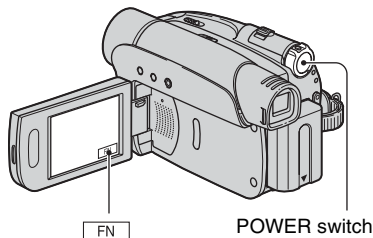

Skip to step 4 when you set the clock for the first time.

1 Touch **FN** → [MENU].

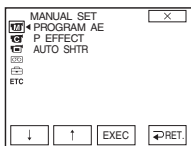

2 Select **[MENU]** (SETUP MENU) with **↓** / **↑**, then touch [EXEC].

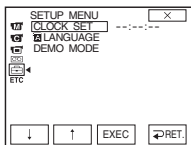

3 Select [CLOCK SET] with **↓** / **↑**, then touch [EXEC].

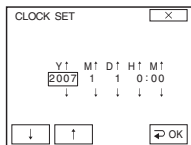

4 Set [Y] (year) with **↓** / **↑**, then touch **[OK]**.

You can set any year up to the year 2079.

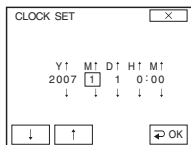

5 Set [M] (month), then touch **[OK]** and repeat for [D] (day), [H] (hour) and [M] (minute).

The clock starts.

- The date and time are not displayed while recording, but they are automatically recorded on the tape, and can be displayed during playback (see page 35 for [DATA CODE] (During Easy Handycam operation, you can set only [DATE/TIME])).

Step 7: Inserting a Cassette

You can use mini DV **Mini DV** cassettes only (p. 61).

- The recordable time varies depending on [REC MODE] (p. 42).

- 1** Slide and hold the  OPEN/EJECT lever in the direction of the arrow and open the lid.

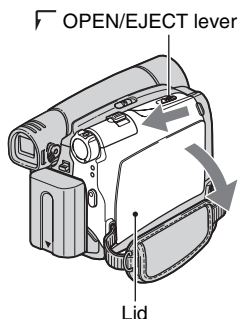

The cassette compartment automatically comes out and opens up.

- 2** Insert a cassette with its window facing outwards, then press **PUSH**.

Push the center of the back of the cassette lightly.

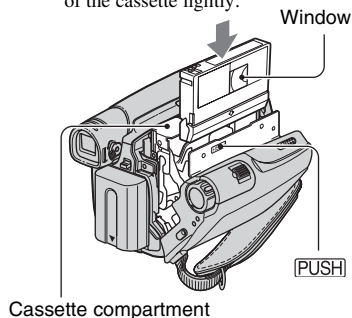

The cassette compartment automatically slides back in.

- Do not force the cassette compartment closed by pressing the portion marked **DO NOT PUSH** while it is sliding in. It may cause a malfunction.

- 3** Close the lid.

To eject the cassette

Open the lid following the same procedure as described in step **1** and remove the cassette.



Easy Recording/Playback (Easy Handycam)

With this Easy Handycam operation, most of the camera settings are automatically optimally adjusted, which frees you from detailed adjustments. The screen font size increases for easy viewing.

Remove the lens cap (p. 12).

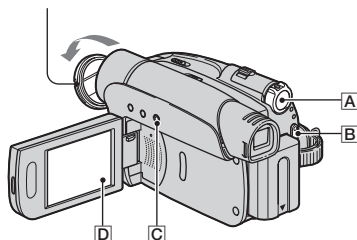

Recording

- Slide the **POWER** switch **A** in the direction of the arrow repeatedly to turn on the **CAMERA** lamp.

If the **POWER** switch **A** is set to OFF(CHG), slide it while pressing the green button.

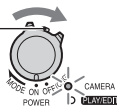

- Press **EASY** **C**.

EASY



EASY appears on the screen **D**.

- Press **REC START/STOP** **B** to start recording.*

The indicator **(A)** changes [STBY] to [REC].
To stop recording, press **B** again.

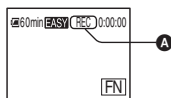

* Movies are recorded in SP (Standard Play) mode on a cassette.

Playback

Slide the **POWER** switch **A** in the direction of the arrow repeatedly to turn on the **PLAY/EDIT** lamp. Touch the buttons on the screen **D** as follows.

If the **POWER** switch is set to **OFF(CHG)**, slide it while pressing the green button.

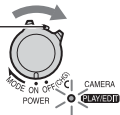

Touch **◀◀(C)**, then touch **▶▶(B)** to start playback.

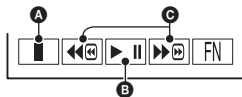

- A** Stop
- B** Play/Pause toggles as you touch it
- C** Rewind/Fast forward

■ To cancel Easy Handycam operation

Press **EASY (C)** again. **EASY** disappears from the screen **D**.

■ Adjustable menu settings during Easy Handycam operation

Touch **FN** and **[MENU]** to display adjustable menu settings. See page 30 for details on setting.

- Almost all the settings return to the default setting automatically (p. 37).
- Cancel Easy Handycam operation if you want to add any effects or settings to the images. Almost all the settings are returned to the previous situation.

■ Unavailable buttons during Easy Handycam

During Easy Handycam operation, the **BACK LIGHT** button (p. 22) is unavailable. [Invalid during Easy Handycam operation.] appears if operations not available during Easy Handycam are attempted.

Recording

Lens cap

Remove the lens cap by pressing both knobs on the sides of the cap

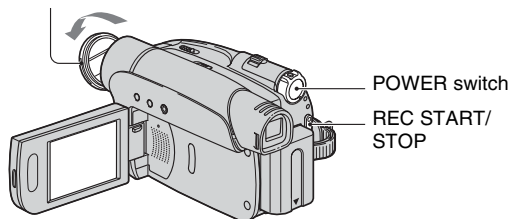

- 1 Slide the POWER switch in the direction of the arrow repeatedly to turn on the CAMERA lamp.**

If the POWER switch is set to OFF(CHG), slide it while pressing the green button.

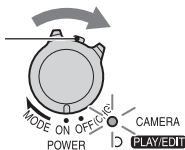

- 2 Press REC START/STOP to start recording.**

The indicator (A) changes [STBY] to [REC].

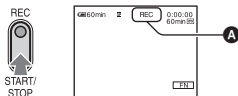

To stop movie recording

Press REC START/STOP again.

Playback

- 1 Slide the **POWER** switch in the direction of the arrow repeatedly to turn on the **PLAY/EDIT** lamp.

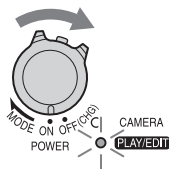

- 2 Start playing back.

Touch to rewind the tape to the desired point, then touch to start playback.

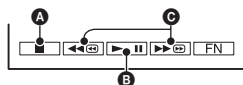

- A** Stop
- B** Play/Pause toggles as you touch it
 - Playback automatically stops if pause is engaged for more than 3 minutes.
- C** Rewind/Fast forward

To adjust the volume

Touch → [PAGE1] → [VOL], then / to adjust the volume.

To search for a scene during playback

Touch and hold / during playback (Picture Search), or / while fast forwarding or rewinding the tape (Skip Scan).

- You can play back in various modes ([V SPD PLAY], p. 36).

Functions used for recording/playback, etc.

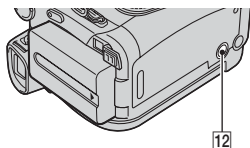
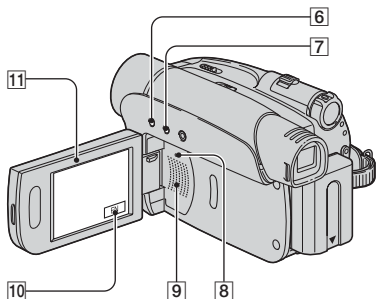
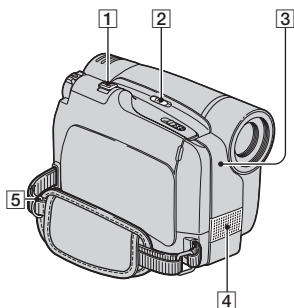

Recording

To use zoom 1

Move the power zoom lever **1** slightly for a slower zoom. Move it further for a faster zoom.

Wider range of view: (Wide angle)

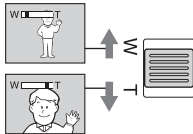

Close view: (Telephoto)

- The minimum possible distance between camcorder and subject while maintaining sharp focus is about 1 cm (about 13/32 in.) for wide angle and about 80 cm (about 2 5/8 feet) for telephoto.
- You can set [D ZOOM] (p. 39) if you want to zoom to a level greater than 20x.
- Be sure to keep your finger on the power zoom lever. If you move your finger off the power zoom lever, the operation sound of the power zoom lever may also be recorded.

To record in dark places (NightShot plus) 2

Set the NIGHTSHOT PLUS switch **2** to ON. (and ["NIGHTSHOT PLUS"] appear.)

- The NightShot plus function uses infrared light. Therefore, do not cover the infrared port **3** with your fingers or other objects. Remove the conversion lens (optional) if it is attached.
- Adjust the focus manually ([FOCUS], p. 32) when it is hard to focus automatically.
- Do not use these functions in bright places. This may cause a malfunction.

To adjust the exposure for backlit subjects (BACK LIGHT) 6

To adjust the exposure for backlit subjects, press BACK LIGHT **6** to display . To cancel the back light function, press BACK LIGHT again.

To adjust the focus for an off center subject (SPOT FOCUS) 10

See [SPOT FOCUS] on page 32.

To fix the exposure for the selected subject (Flexible spot meter) 10

See [SPOT METER] on page 32.

To record in mirror mode 11

Open the LCD panel 11 90 degrees to the camcorder (1), then rotate it 180 degrees to the lens side (2).

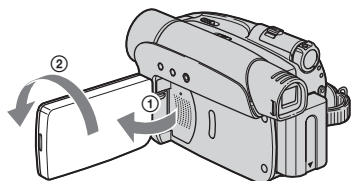

• A mirror-image of the subject appears on the LCD screen, but the picture will be normal when recorded.

To use a tripod 12

Attach the tripod (optional: the length of the screw must be less than 5.5 mm (7/32 in.)) to the tripod receptacle 12 using a tripod screw.

To use a Shoulder Belt 5

Attach the Shoulder Belt (optional) to its designated hook 5.

Playback

To play back the images with added special effects (Picture effect) 10

See [P EFFECT] on page 38.

Recording/playback

To check the remaining battery (Battery Info) 7

Set the POWER switch to OFF(CHG), then press DISP/BATT INFO 7. The battery information appears for about 7 seconds. You can view the battery information for up to 20 seconds by pressing DISP/BATT INFO again while the battery information is displayed.

Remaining battery (approx.)

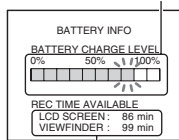

Recording capacity (approx.)

To turn off the operation confirmation beep (BEEP) 10

See [BEEP] on page 44.

To initialize the settings (RESET) 8

Press RESET 8 to initialize all the settings, including the setting of the date and time.

Other part names and functions

4 Internal stereo microphone

9 Speaker

Playback sound comes out from the speaker.

• For how to adjust the volume, see page 21.

Indicators displayed during recording/playback

Recording

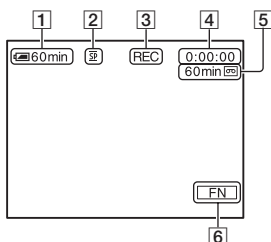

- 1 Remaining battery (approx.)
- 2 Recording mode (SP or LP) (42)
- 3 Recording status ([STBY] (standby) or [REC] (recording))
- 4 Recording: Tape counter (hour: minute: second)
Playback: Time code (hour: minute: second: frame)
- 5 Recording capacity of the tape (approx.) (43)
- 6 Function button (30)

Viewing

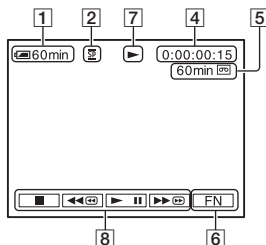

- 7 Tape transport indicator
- 8 Video operation buttons (21)

Data code during recording

The date/time during recording and the camera setting data will be recorded automatically. They do not appear on the screen during recording, but you can check them as [DATA CODE] during playback (p. 35).

() is a reference page.

The indicators during recording will not be recorded.

Indicators when you made changes

You can use [DISP GUIDE] (p. 14) to check the function of each indicator that appears on the LCD screen.

- Some of the indicators may not appear when you use [DISP GUIDE].

Upper left

Upper right

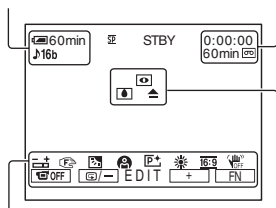

Bottom

Center

Upper left

Indicator	Meaning
16b	AUDIO MODE (42)

Upper right

Indicator	Meaning
DV IN	DV input (47)

Center

Indicator	Meaning
	NightShot plus (22)
	Warning (58)

Bottom

Indicator	Meaning
	Flexible spot meter (32)/ Manual exposure (34)
	Manual focus (32)
	Backlight (22)
	PROGRAM AE (38)
	Picture effect (38)
	White balance (34)
	Wide select (40)
	SteadyShot off (40)
	Panel off (33)
	EDITSEARCH (40)

Searching for the starting point

Make sure that the CAMERA lamp lights up (p. 20).

Searching for the last scene of the most recent recording (END SEARCH)

[END SCH] (END SEARCH) will not work once you eject the cassette after you have recorded on the tape.

Touch **[FN]** → **[PAGE1]**, then touch **[END SCH]**.

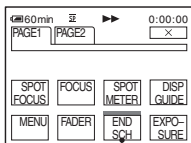

Touch here again to cancel the operation.

The last scene of the most recent recording is played back for about 5 seconds, and the camcorder enters the standby mode at the point where the last recording has finished.

- [END SCH] will not work correctly when there is a blank section between recorded sections on the tape.
- This operation is also available when the POWER switch is set to PLAY/EDIT.

Searching manually (EDIT SEARCH)

You can search for the start point to start the next recording while viewing the pictures on the screen. The sound is not played back during the search.

1 Touch **[FN]** → **[PAGE1]** → **[MENU]**.

2 Select **[CAMERA SET]** with **[↓]** / **[↑]**, then touch **[EXEC]**.

3 Select **[EDITSEARCH]** with **[↓]** / **[↑]**, then touch **[EXEC]**.

4 Select **[ON]** with **[↓]** / **[↑]**, then touch **[EXEC]** → **[X]**.

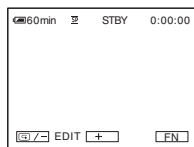

5 Touch and hold **[G/-]** (to go backward) / **[+]** (to go forward) and release it at the point where you want the recording to start.

Reviewing the most recently recorded scenes (Rec review)

You can view a few seconds of the scene recorded just before you stopped the tape.

- 1 Touch **FN** → **[PAGE1]** → **[MENU]**.
- 2 Select **📷** (CAMERA SET) with **↓** / **↑**, then touch **[EXEC]**.
- 3 Select **[EDITSEARCH]** with **↓** / **↑**, then touch **[EXEC]**.
- 4 Select **[ON]** with **↓** / **↑**, then touch **[EXEC]** → **✕**.

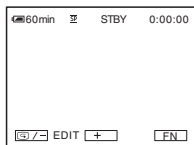

- 5 Touch **📷** / **-**.

The last few seconds of the most recently recorded scene are played back. Then, your camcorder is set to the standby.

Playing the picture on a TV

You can connect your camcorder to the input jack of a TV or a VCR using the A/V connecting cable (1) or the A/V connecting cable with S VIDEO (2). Connect your camcorder to the wall socket using the supplied AC Adaptor for this operation (p. 9). Refer also to the instruction manuals supplied with the devices to be connected.

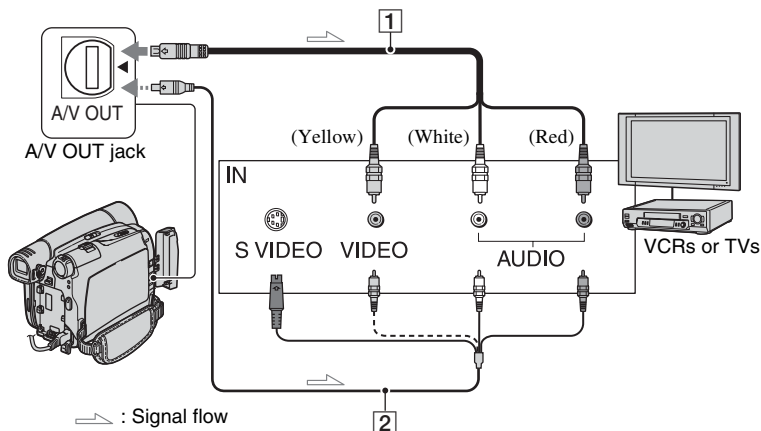

1 A/V connecting cable (supplied)

2 A/V connecting cable with S VIDEO (optional)

When connecting to another device via the S VIDEO jack, by using the A/V connecting cable with an S VIDEO cable, pictures can be reproduced more faithfully than with the supplied A/V cable connection.

Connect the white and red plugs (left/right audio) and S VIDEO plug (S VIDEO channel) of an A/V connecting cable. In this case, the yellow (standard video) plug connection is not necessary. S VIDEO connection only will not output audio.

- You can display the time code on the TV screen by setting [DISP OUT] to [V-OUT/LCD] (p. 44).

When connecting your camcorder to a TV through a VCR

Connect your camcorder to the LINE IN input on the VCR. Set the input selector on the VCR to LINE (VIDEO 1, VIDEO 2, etc.), if the VCR has an input selector.

When your TV is monaural (Only one audio input jack)

Connect the yellow plug of the A/V connecting cable to the video input jack and connect the white (left channel) or the red (right channel) plug to the audio input jack of your TV or VCR.

If your TV/VCR has a 21-pin adaptor (EUROCONNECTOR)

You need the 21-pin adaptor (optional) to connect your camcorder to a TV for viewing recorded images. This adaptor is designed for output use only.

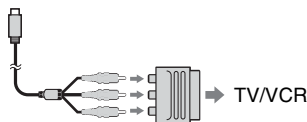

Using the menu items

Follow the instructions below to use each of the menu items listed after this page.

1 Slide the POWER switch in the direction of the arrow repeatedly to turn on the respective lamp.

CAMERA lamp: settings for recording on a tape

PLAY/EDIT lamp: settings for viewing/editing

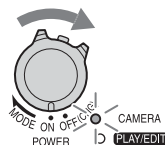

2 Touch the LCD screen to select the menu item.

Unavailable items will be grayed out.

■ To use the operation buttons on PAGE1/PAGE2/PAGE3

For details of the button items, see page 32.

- ① Touch .
- ② Touch the desired page.
- ③ Touch the desired button.
- ④ Select the desired setting, then touch → (close).
 - With some settings, you do not have to touch .

■ To use menu items

For details of the items, see page 38.

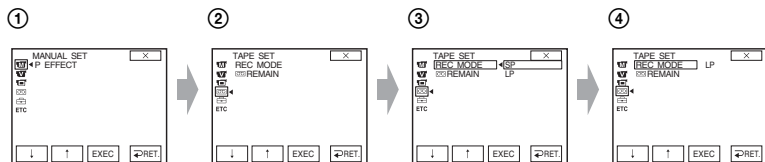

- ① Touch → [MENU] on [PAGE1].
The menu index screen appears.
- ② Select the desired menu.
Touch / to select the item, then touch [EXEC]. (The process in step ③ and ④ is the same as that in step ②.)
- ③ Select the desired item.
- ④ Customize the item.
After finishing the settings, touch (close) to hide the menu screen.
Each touch of [] takes you to the previous screen.

■ To use menu items during Easy Handycam operation



① Touch .

② Select the desired menu.

Touch [MENU] then select the desired menu.

③ Change your item setting.

After finishing the settings, touch (close) to hide the menu screen.

Each touch of [RET.] takes you to the previous screen.

- Cancel Easy Handycam operation to use menu items normally.

Operation button items

Available operation buttons vary depending on the position of the lamp and the display (PAGE).

The default settings are marked with ►.

The indicators in parentheses appear when the items are selected.

The available functions during Easy Handycam operation are marked with “***”.
See page 30 for details on selecting button items.

When the CAMERA lamp lights up

[PAGE1]

SPOT FOCUS

You can select and adjust the focal point to aim it at a subject not located in the center of the screen.

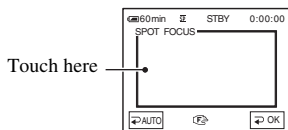

Touch the point where you want to focus on in the frame.

☞ appears.

To adjust the focus automatically, touch [↩ AUTO] or set [FOCUS] to [↩ AUTO].

- If you set [SPOT FOCUS], [FOCUS] is automatically set to [MANUAL].
- The setting returns to [↩ AUTO] when you turn the power off for more than 12 hours.

FOCUS

You can adjust the focus manually. You can select this function also when you want to focus on a certain subject intentionally.



① Touch [MANUAL].

☞ appears.

② Touch [⏏] (focusing on close subjects)/ [⏏] (focusing on distant subjects) to sharpen the focus. ☞ appears when the focus cannot be adjusted any closer, and ▲ appears when the focus cannot be adjusted farther away.

To adjust the focus automatically, touch [↩ AUTO] in step ①.

- It is easier to focus on the subject by moving the power zoom lever towards T (telephoto) to adjust the focus, then towards W (wide angle) to adjust the zoom for recording. When you want to record a subject at close range, move the power zoom lever to W (wide angle), then adjust the focus.
- The minimum possible distance between camcorder and subject while maintaining sharp focus is about 1 cm (about 13/32 in.) for wide angle and about 80 cm (about 2 5/8 feet) for telephoto.
- The setting returns to [↩ AUTO] when you turn the power off for more than 12 hours.

SPOT METER (Flexible spot meter)

You can adjust and fix the exposure to the subject, so that it is recorded in suitable brightness even when there is strong contrast between the subject and the background, such as subjects in the spotlight on stage.

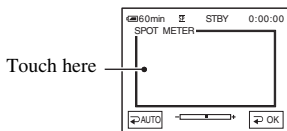

Touch the point where you want to fix and adjust the exposure on the screen.

☞ appears.

To return the setting to automatic exposure, touch [AUTO] or set [EXPOSURE] to [AUTO].

- If you set [SPOT METER], [EXPOSURE] is automatically set to [MANUAL].
- The setting returns to [AUTO] when you turn the power off for more than 12 hours.

DISP GUIDE (Display Guide)*

See page 14.

MENU*

See page 37.

FADER

You can add the following effects to currently recording pictures.

- ① Select the desired effect in standby mode (to fade in) or recording mode (to fade out), then touch [] → [].
- ② Press REC START/STOP.

The fader indicator stops flashing and disappears when the fade is complete.

To cancel [FADER] before starting the operation, touch [OFF] in step ①.

- If you press REC START/STOP once, the setting is canceled.



WHITE



BLACK



MOSC. FADER



MONOTONE

When fading in, the picture gradually changes from black and white to color. When fading out, it gradually changes from color to black and white.

Using the viewfinder

You can adjust [EXPOSURE] and [FADER] while using the viewfinder by having the LCD panel rotated 180 degrees and closed with the screen facing out.

- 1 Make sure that the CAMERA lamp lights up.
- 2 Close the LCD panel with the screen facing out.
[] appears.
- 3 Touch [].
- 4 Touch [].
The LCD screen is turned off.
- 5 Touch the LCD screen while checking the display in the viewfinder.
[EXPOSURE], etc. are displayed.
- 6 Touch the button you want to set.
[EXPOSURE]: Adjust with []/[], and touch [].
[FADER]: Touch it repeatedly to select a desired effect.
[]: The LCD screen lights up.

To hide the buttons, touch [].

END SCH (END SEARCH)

See page 26.

EXPOSURE

You can fix the brightness of a picture manually. When recording indoors on a clear day, for instance, you can avoid backlight shadows on people next to the window by fixing the exposure to that of the wall side of the room.

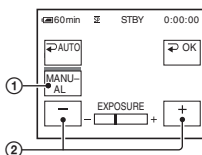

① Touch [MANUAL].

— appears.

② Adjust the exposure by touching [-] / [+].

To return the setting to automatic exposure, touch [AUTO].

- You can adjust [EXPOSURE] and [FADER] while using the viewfinder by having the LCD panel rotated 180 degrees and closed with the screen facing out (p. 33).
- The setting returns to [AUTO] when you turn the power off for more than 12 hours.

[PAGE2]

WHT BAL (White balance)

You can adjust the color balance to the brightness of the recording environment.

▶ AUTO

The white balance is adjusted automatically.

OUTDOOR ()

The white balance is adjusted to be appropriate for the following recording conditions:

- Outdoors
- Night views, neon signs and fireworks
- Sunrise or sunset
- Under daylight fluorescent lamps

INDOOR ()

The white balance is adjusted to be appropriate for the following recording conditions:

- Indoors
- At party scenes or studios where the lighting conditions change quickly
- Under video lamps in a studio, or under sodium lamps or incandescent-like color lamps

ONE PUSH ()

The white balance will be adjusted according to the ambient light.

① Touch [ONE PUSH].

② Frame a white object such as a piece of paper, to fill the screen under the same lighting conditions as you will shoot the subject.

③ Touch [].

flashes quickly. When the white balance has been adjusted and stored in the memory, the indicator stops flashing.

• Do not shake your camcorder while is flashing quickly.

• flashes slowly if white balance could not be set.

• If keeps flashing even after you have touched [OK], set [WHT BAL] to [AUTO].

- If you have changed the battery pack while [AUTO] was selected, or taken your camcorder outdoors after inside use with the [EXPOSURE] set (or vice versa), select [AUTO] and aim your camcorder at a nearby white object for about 10 seconds for better color balance adjustment.
- Redo the [ONE PUSH] procedure if you change the [PROGRAM AE] settings, or bring your camcorder outdoors from inside the house, or vice versa.
- Set [WHT BAL] to [AUTO] or [ONE PUSH] under white or cool white fluorescent lamps.
- The setting returns to [AUTO] when you turn the power off for more than 12 hours.

LCD BRT (LCD bright)

You can adjust the brightness of the LCD screen. The recorded picture will not be affected by this operation.

Adjust the brightness with $\boxed{-}$ / $\boxed{+}$.

When the PLAY/EDIT lamp lights up

You can use the video operation buttons ($\boxed{\blacksquare}$ / $\boxed{\llcorner}$ / $\boxed{\blacktriangleright}$ / $\boxed{\blacktriangleright}$) on every PAGE.

[PAGE1]

MENU*

See page 37.

VOL* (Volume)

See page 21.

END SCH (END SEARCH)

See page 26.

DISP GUIDE (Display Guide)*

See page 14.

[PAGE2]

DATA CODE*

During playback, displays information (data code) recorded automatically at the time of recording.

▶ \square OFF

Data code is not displayed.

DATE/TIME

Displays the date and time.

CAM DATA (below)

Displays camera setting data.

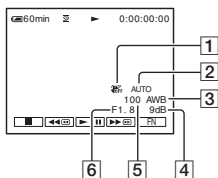

- 1 SteadyShot off
- 2 Exposure
- 3 White balance
- 4 Gain
- 5 Shutter speed
- 6 Aperture value

- In the [DATE/TIME] data display, the date and time are displayed in the same area. If you record a picture without setting the clock, [---:---:---] and [---:---:---] will appear.
- During Easy Handycam operation, you can set [DATE/TIME] only.

LCD BRT (LCD bright)

You can adjust the brightness of the LCD screen. The recorded picture will not be affected by this operation.

Adjust the brightness with $\boxed{-}$ / $\boxed{+}$.

[PAGE3]

V SPD PLAY (Various speed playback)

You can play back in various modes while viewing movies.

- ① Touch the following buttons during playback.

To	Touch
change the playback direction*	(frame)
play back slowly**	SLOW To reverse direction: (frame) → SLOW
play back 2 times faster (double speed)	(double speed) To reverse direction: (frame) → (double speed)
play back frame by frame	(frame) during playback pause. To reverse direction: (frame) during frame playback.

* Horizontal lines may appear at the top, bottom, or in the center of the screen. This is not a malfunction.

**Pictures output from the DV Interface (i.LINK) cannot be played back smoothly in slow mode.

- ② Touch [RET.] → .

To return to the normal playback mode, touch (Play/Pause) twice (once from frame playback).

- You will not hear the recorded sound. You may see mosaic-like images of the previously played picture.

A DUB CTRL (Audio dubbing)

See page 49.

REC CTRL (Recording control) (DCR-HC28E)

See page 47.

Menu items

- Available menu items (●) vary depending on which lamp is lit.
- During Easy Handycam operation, the following settings are automatically applied (p. 18).

	CAMERA	PLAY/EDIT	Easy Handycam
MANUAL SET menu (p. 38)			
PROGRAM AE	●	–	AUTO
P EFFECT	●	●	OFF
AUTO SHTR	●	–	ON
CAMERA SET menu (p. 39)			
D ZOOM	●	–	OFF
WIDE SEL	●	–	4:3
STEADYSHOT	●	–	ON
EDITSEARCH	●	–	OFF
N.S.LIGHT	●	–	ON
PLAYER SET (DCR-HC27E)/			
VCR SET (DCR-HC28E) menu (p. 41)			
AUDIO MIX	–	●	–
LCD/VF SET menu (p. 41)			
LCD B.L.	●	●	BRT NORMAL
LCD COLOR	●	●	–
VF B.L.	●	●	BRT NORMAL
WIDE DISP	●	●	–
TAPE SET menu (p. 42)			
REC MODE (DCR-HC27E)	●	–	SP
REC MODE (DCR-HC28E)	●	●	SP
AUDIO MODE	●	–	12BIT
REMAIN	●	●	AUTO
SETUP MENU menu (p. 43)			
CLOCK SET	●	●	●
LANGUAGE	●	●	●
DEMO MODE	●	–	ON
OTHERS menu (p. 44)			
WORLD TIME	●	●	–*
BEEP	●	●	●
A.SHUT OFF	●	●	5min
DISP OUT	●	●	LCD

* The value set before Easy Handycam operation will be retained during Easy Handycam operation.

MANUAL SET menu

– PROGRAM AE/P EFFECT, etc.

The default settings are marked with ►. The indicators in parentheses appear when the items are selected.

See page 30 for details on selecting menu items.

PROGRAM AE

You can record pictures effectively in various situations with the PROGRAM AE function.

► AUTO

Select to automatically record pictures effectively without the [PROGRAM AE] function.

SPOTLIGHT* (☹)

Select to prevent people's faces from appearing excessively white when subjects are lit by strong light.



PORTRAIT (Soft portrait) (👤)

Select to bring out the subject such as people or flowers while creating a soft background.



SPORTS* (Sports lesson) (🏃)

Select to minimize shake when shooting fast moving subjects.



BEACH&SKI* (🏖)

Select to prevent people's faces from appearing dark in strong light or reflected light, such as at a beach in midsummer or on a ski slope.



SUNSETMOON** (🌅)

Select to maintain the atmosphere of situations such as sunsets, general night views or fireworks.



LANDSCAPE** (🏞)

Select to shoot distant subjects clearly. This setting also prevents your camcorder from focusing on glass or metal mesh in windows that comes in between the camcorder and the subject.



- Items with one asterisk (*) can be adjusted to focus on subjects only a short distance away. Items with two asterisks (**) can be adjusted to focus on subjects farther away.
- The setting returns to [AUTO] when you turn the power off for more than 12 hours.

P EFFECT (Picture effect)

You can add special effects to a picture during recording or playback.  appears.

► OFF

Does not use [P EFFECT] setting.

NEG.ART

The color and brightness are reversed.



CAMERA SET menu

– D ZOOM/WIDE SEL/STEADYSHOT, etc.

SEPIA

Pictures appear in sepia.

B&W

Pictures appear in black and white.

SOLARIZE

Pictures appear as an illustration with strong contrast.



PASTEL*

Pictures appear as a pale pastel drawing.



MOSAIC*

Pictures appear mosaic-patterned.



* Not available during playback.

- You can record pictures edited with special effects on another VCR/DVD device, etc. (p. 45).
- You cannot output playback pictures edited with picture effects via the  DV Interface (i.LINK).
- For DCR-HC28E:
You cannot add effects to externally input pictures.

AUTO SHTR (Auto shutter)

Automatically activates the electronic shutter to adjust the shutter speed when recording in bright conditions if you set it to [ON] (the default setting).

The default settings are marked with ►. The indicators in parentheses appear when the items are selected.

See page 30 for details on selecting menu items.

D ZOOM (Digital zoom)

You can select the maximum zoom level in case you want to zoom to a level greater than 20 × (the default setting) while recording on a tape. Note that the image quality decreases when you are using the digital zoom.

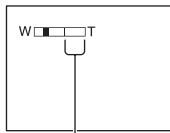

The right side of the bar shows the digital zooming factor. The zooming zone appears when you select the zooming level.

► OFF

Up to 20 × zoom is performed optically.

40 ×

Up to 20 × zoom is performed optically, and after that, up to 40 × zoom is performed digitally.

800 ×

Up to 20 × zoom is performed optically, and after that, up to 800 × zoom is performed digitally.

WIDE SEL (Wide select)

You can record a picture in a ratio suitable for the screen on which it will be displayed. Refer also to the operating instructions supplied with your TV for details.

▶ 4:3

Standard setting (to record pictures to be played back on a 4:3 TV).

16:9 WIDE (16:9)

Records pictures to be played back on a 16:9 wide TV in full screen mode.

When viewed on the LCD screen/viewfinder with [16:9 WIDE] selected.



When viewed on a 16:9 wide screen TV*



When viewed on a standard TV**



* Picture appears in full screen mode when the wide-screen TV switches to full mode.

** Played in 4:3 mode. When you play a picture in the wide mode, it appears as you have seen on the LCD screen or in the viewfinder.

STEADYSHOT

You can compensate for camera shake (the default setting is [ON]). Set [STEADYSHOT] to [OFF] (OFF) when using a tripod (optional) or the conversion lens (optional), then the image becomes natural.

EDITSEARCH**▶ OFF**

Does not display [G/-] or [+] on the LCD screen.

ON

Displays [G/-] and [+] on the LCD screen, and enables the EDIT SEARCH function and Rec review (p. 26).

N.S.LIGHT (NightShot Light)

When using the NightShot plus (p. 22) function to record, you can record clearer pictures by setting [N.S.LIGHT], which emits infrared light (invisible), to [ON] (the default setting).

- Do not cover the infrared port with your fingers or other objects (p. 22).
- Remove the conversion lens (optional) if it is attached.
- The maximum shooting distance using [N.S.LIGHT] is about 3 m (10 feet). If you record subjects in dark places, such as night scenes or in moonlight, set [N.S.LIGHT] to [OFF]. You can make the image color deeper this way.

PLAYER SET/ **VCR SET menu**

– AUDIO MIX

The **PLAYER SET** menu is for the DCR-HC27E, and the **VCR SET** menu is for the DCR-HC28E.

See page 30 for details on selecting menu items.

AUDIO MIX

See page 49.

LCD/VF SET menu

– LCD B.L./LCD COLOR/VF B.L., etc

The default settings are marked with ►. See page 30 for details on selecting menu items.

LCD B.L. (LCD back light)

You can adjust the brightness of the LCD screen's backlight. The recorded picture will not be affected by this operation.

► BRT NORMAL



Standard brightness.

BRIGHT

Brightens the LCD screen.

- When you connect your camcorder to outside power sources, [BRIGHT] is automatically selected for the setting.
- When you select [BRIGHT], battery life is slightly reduced during recording.

LCD COLOR

You can adjust the color on the LCD screen with  / . The recorded picture will not be affected by this operation.

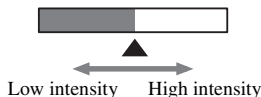

- REC MODE/AUDIO MODE/REMAIN

VF B.L. (Viewfinder back light)

You can adjust the brightness of the viewfinder. The recorded picture will not be affected by this operation.

▶ BRT NORMAL

Standard brightness.

BRIGHT

Brightens the viewfinder screen.

- When you connect your camcorder to outside power sources, [BRIGHT] is automatically selected for the setting.
- When you select [BRIGHT], battery life is slightly reduced during recording.

WIDE DISP (Wide display)

You can select how a 16:9 aspect ratio picture appears in the viewfinder and the LCD screen by setting [WIDE SEL] to [16:9 WIDE]. The recorded picture will not be affected by this operation.

▶ LETTER BOX

Normal setting (standard type of display)

SQUEEZE

Expands the picture vertically if black bands at the top and bottom in 16:9 aspect ratio are undesirable.

The default settings are marked with ▶. The indicators in parentheses appear when the items are selected.

See page 30 for details on selecting menu items.

REC MODE (Recording mode)**▶ SP (SP)**

Records in the SP (Standard Play) mode on a cassette.

LP (LP)

Increases the recording time to 1.5 times the SP mode (Long Play).

- If you record in the LP mode, a mosaic-like noise may appear or sound may be interrupted when you play back the tape on other camcorders or VCRs.
- When you mix recordings in the SP mode and in the LP mode on one tape, the playback picture may be distorted or the time code may not be written properly between the scenes.

AUDIO MODE**▶ 12BIT**

Records in the 12-bit mode (2 stereo sounds).

16BIT (16b)

Records in the 16-bit mode (1 stereo sound with high quality).



SETUP MENU

menu

– CLOCK SET/LANGUAGE, etc.

See page 30 for details on selecting menu items.

CLOCK SET

See page 16.

LANGUAGE

You can select the language to be used on the LCD screen.

- Your camcorder offers [ENG[SIMP]] (simplified English) for when you cannot find your native tongue among the options.

DEMO MODE

The default setting is [ON], allowing you to view the demonstration in about 10 minutes, after you have removed a cassette from your camcorder, and slide the POWER switch repeatedly to turn on the CAMERA lamp.

- The demonstration will be suspended in situations such as those described below.
 - When you touch the screen during the demonstration. (The demonstration starts again after about 10 minutes.)
 - When a cassette is inserted.
 - When the POWER switch is set to other than CAMERA.

REMAIN

▶ AUTO

Displays the remaining tape indicator for about 8 seconds in situations such as those described below.

- When you set the POWER switch to PLAY/EDIT or CAMERA with a cassette inserted.
- When you touch (Play/Pause).

ON

Always displays the remaining tape indicator.



ETC OTHERS menu

– WORLD TIME/BEEP, etc.

The default settings are marked with ►.

See page 30 for details on selecting menu items.

WORLD TIME

When using your camcorder abroad, you can set the time difference by touching  / , the clock will be adjusted in accordance with the time difference.

If you set the time difference to 0, the clock returns to the originally set time.

BEEP

► ON

A melody sounds when you start/stop recording, or operate the touch panel.

OFF

Cancels the melody.

A.SHUT OFF (Auto shut off)

► 5min

The camcorder is automatically turned off when you do not operate your camcorder for more than approximately 5 minutes.

NEVER

The camcorder is not automatically turned off.

- When you connect your camcorder to a wall socket, [A.SHUT OFF] is automatically set to [NEVER].

DISP OUT (Display output)

► LCD

Shows displays such as the time code on the LCD screen and in the viewfinder.

V-OUT/LCD

Shows displays such as the time code on the TV screen, LCD screen, and in the viewfinder.

Dubbing to VCR/DVD device, etc.

You can copy the picture played back on your camcorder to other recording devices (VCR/ DVD device, etc.).

You can connect your camcorder to a VCR/DVD device, etc., using the A/V connecting cable (1), the A/V connecting cable with S VIDEO (2), or the i.LINK cable (3).

Connect your camcorder to the wall socket using the supplied AC Adaptor for this operation (p. 9). Refer also to the instruction manuals supplied with the devices to be connected.

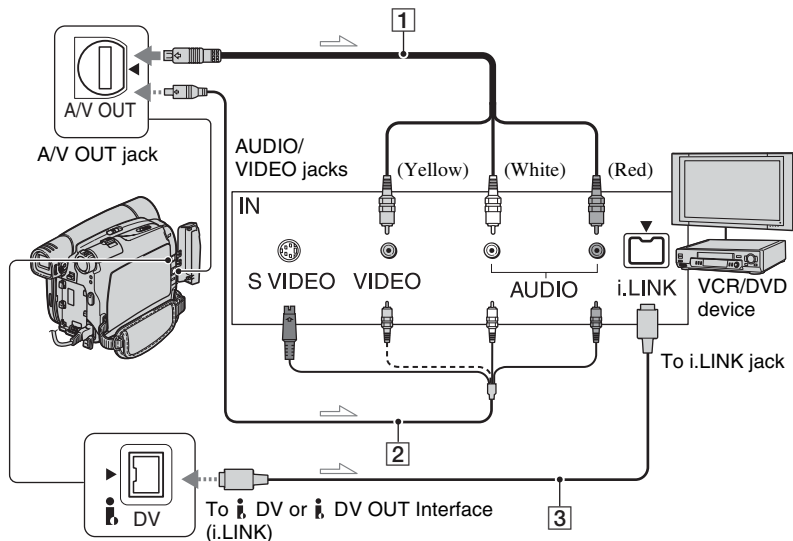

→ : Signal flow

1 A/V connecting cable (supplied)

2 A/V connecting cable with S VIDEO (optional)

When connecting to another device via the S VIDEO jack, by using the A/V connecting cable with an S VIDEO cable, pictures can be reproduced more faithfully than with the supplied A/V cable connection. Connect the white and red plugs (left/right audio) and S VIDEO plug (S VIDEO channel) of an A/V connecting cable. In this case, the yellow (standard video) plug connection is not necessary. S VIDEO connection only will not output audio.

3 i.LINK cable (optional)

Use an i.LINK cable to connect your camcorder to another device equipped with an i.LINK jack. The video and audio signals are transmitted digitally, producing high quality pictures and sound. Note that you cannot output picture and sound separately.

- When you are connecting your camcorder to a monaural device, connect the yellow plug of the A/V connecting cable to the video jack, and the red (right channel) or the white (left channel) plug to the audio jack on the VCR/TV.
- When you connect a device via an A/V connecting cable, set [DISP OUT] to [LCD] (the default setting) (p. 44).

1 Prepare your camcorder for playback.

Insert the recorded cassette.

Slide the POWER switch repeatedly to turn on the PLAY/EDIT lamp.

2 Prepare your VCR/DVD device for recording.

When dubbing to the VCR, insert a cassette for recording.

When dubbing to the DVD recorder, insert a DVD for recording.

If your recording device has an input selector, set it to the appropriate input (such as video input1, video input2).

3 Connect your VCR/DVD device to your camcorder as a recording device.

Connect your camcorder to the input jacks of a VCR or a DVD device.

4 Start playback on the camcorder, and recording on the VCR/DVD device.

Refer to the operating instructions supplied with your recording device for details.

5 When dubbing is complete, stop your camcorder and the VCR/DVD device.

- To record the date/time and camera settings data when connected by the A/V connecting cable, display them on the screen (p. 35, 44).
- The following cannot be output via the  DV Interface (i.LINK):
 - Indicators
 - Pictures edited using [P EFFECT] (p. 38)
- When connected using an i.LINK cable, the recorded picture becomes rough when a picture is paused on your camcorder while recording to a VCR.
- When connected using an i.LINK cable, data code (date/time/camera settings data) may not be displayed or recorded depending on the device or application.

Recording pictures from a TV or VCR/DVD device, etc. (DCR-HC28E)

You can record pictures or TV programs from a TV or VCR/DVD device, etc., on a tape. Be sure to insert a cassette for recording in your camcorder beforehand.

You can connect your camcorder to a TV, VCR/DVD or an i.LINK-compatible device using the i.LINK cable.

Connect your camcorder to the wall socket using the supplied AC Adaptor for this operation (p. 9). Refer also to the instruction manuals supplied with the devices to be connected.

- You cannot record pictures on your camcorder from a TV or VCR/DVD device that does not have an i.LINK jack.
- You cannot input picture and sound separately.
- Your camcorder can only record from a PAL source. For example, French system video/broadcasts (SECAM) will not be recorded correctly. See page 61 for details on TV color systems.

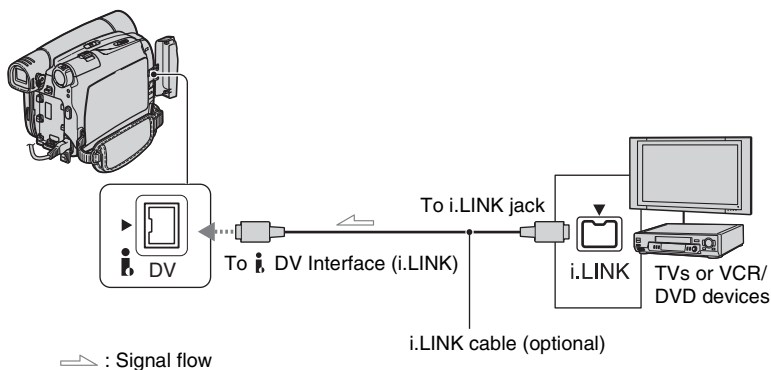

1 Connect your TV or VCR/DVD device to your camcorder with an i.LINK cable.

- The **DVIN** indicator appears when you connect your camcorder and other devices via an i.LINK cable. (This indicator may also appear on the connected device.)

2 If you are recording from a VCR/DVD device, insert a cassette or a DVD.

3 Slide the POWER switch repeatedly to turn on the PLAY/EDIT lamp.

4 Set your camcorder to recording pause mode.

Touch **FN** → [PAGE3] → [REC CTRL] → [REC PAUSE].

5 When recording pictures from a VCR/DVD device:

Start playing the cassette or the disc on the VCR/DVD device.

When recording pictures from a TV:

Select a TV program.

The picture played on the connected device appears on the LCD screen of your camcorder.

6 Touch [REC START] at the point you want to start recording.

7 Stop recording.

Touch  (Stop) or [REC PAUSE].

8 Touch [ RET.] → .

Dubbing sound to a recorded tape

You can add sound to a tape already recorded in the 12-bit mode (p. 42) without erasing the original sound.

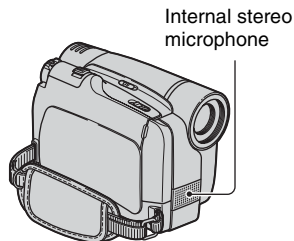

You can record audio by using the internal stereo microphone.

- You cannot record additional audio:
 - When the tape has been recorded in the 16-bit mode (p. 42).
 - When the tape has been recorded in the LP mode.
 - When your camcorder is connected via an i.LINK cable.
 - When the tape has been recorded in 4CH MIC mode.
 - On blank sections of the tape.
 - When the tape has been recorded in a TV color system other than that of your camcorder (p. 61).
 - When the write-protect tab of the cassette is set to SAVE (p. 62).
 - On sections recorded in HDV format.
- When you add sound, the picture will not be output from the A/V OUT jack. Check the picture on the LCD screen or the viewfinder.

Recording sound

Insert a recorded cassette into your camcorder beforehand.

1 Slide the **POWER** switch repeatedly to turn on the **PLAY/EDIT** lamp.

2 Touch **[▶||]** (**Play/Pause**) to play back the tape, then touch it again at the point where you want to start recording the sound.

3 Touch **[FN]** → **[PAGE3]** → **[A DUB CTRL]** → **[AUDIO DUB]**.

[▶||] appears.

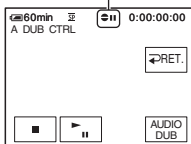

4 Touch **[▶||]** (**Play**) and start playing back the audio you want to record at the same time.

[▶||] appears while recording the new sound in stereo 2 (ST2) during the playback of the tape.

5 Touch **[■]** (**Stop**) when you want to stop recording.

To dub on other scenes, repeat step **2** to select scenes, then touch **[AUDIO DUB]**.

6 Touch **[↶ RET.]** → **[X]**.

- You can only record additional audio over a tape recorded on your camcorder. The sound may deteriorate when you dub audio on a tape recorded on other camcorders (including other DCR-HC27E/HC28E camcorders).

To check the recorded sound

- ① Play back the tape on which you have recorded audio (p. 21).
- ② Touch **[FN]** → **[PAGE1]** → **[MENU]**.
- ③ Select **[▶]** (**PLAYER SET**) for the DCR-HC27E, or **[V]** (**VCR SET**) for the DCR-HC28E, then touch **[↓]** / **[↑]** to select **[AUDIO MIX]**, then touch **[EXEC]**.

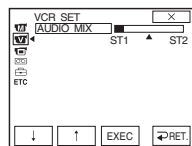

- ④ Touch **[↓]** / **[↑]** to adjust the balance of the original sound (ST1) and the new sound (ST2), then touch **[EXEC]**.

- The original sound (ST1) is output at the default setting.
- Audio balance adjustment returns to the default setting after 12 hours of turning the power off.

Jacks to connect external devices

Open the jack cover.

- 1 For DCR-HC27E:
 - DV OUT Interface (i.LINK) (p. 45)
- For DCR-HC28E:
 - DV Interface (i.LINK) (p. 45, 47)
- 2 A/V (audio/video) OUT jack (p. 28, 45)
- 3 DC IN jack (p. 9)

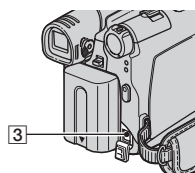
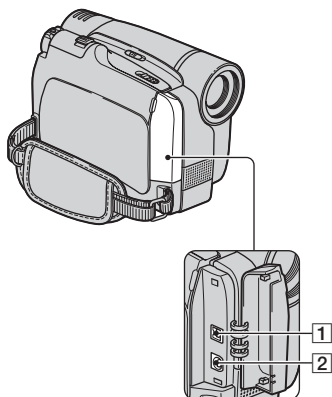

Troubleshooting

If you run into any problems using your camcorder, use the following table to troubleshoot the problem. If the problem persists, disconnect the power source and contact your Sony dealer.

Overall operations/Easy Handycam

The power does not turn on.

- Attach a charged battery pack to the camcorder (p. 9).
- Use the AC Adaptor to connect to a wall socket (p. 9).

The camcorder does not operate even when the power is set to on.

- Disconnect the AC Adaptor from the wall socket or remove the battery pack, then reconnect it after about 1 minute.
- Press the RESET button (p. 23) using a sharp-pointed object. (If you press the RESET button, all settings are reset.)

Buttons do not work.

- During Easy Handycam operation, not all buttons are functional (p. 19).

Settings change during Easy Handycam operation.

- During Easy Handycam operation, the settings of the functions that are not displayed on the screen return to their defaults. Previously made settings are restored when you cancel the Easy Handycam operation (p. 18, 37).

[DEMO MODE] does not start.

- You cannot view the demonstration together with NightShot plus (p. 22).
- Eject the cassette from your camcorder (p. 17).

The camcorder gets warm.

- The camcorder may get warmer while you use it. This is not a malfunction.

Batteries/Power sources

The power abruptly turns off.

- When approximately 5 minutes have elapsed while you do not operate your camcorder, the camcorder is automatically turned off (A.SHUT OFF). Change the setting of [A.SHUT OFF] (p. 44), or turn on the power again (p. 12), or use the AC Adaptor.
- Charge the battery pack (p. 9).

The CHG (charge) lamp does not light while the battery pack is being charged.

- Slide the POWER switch to OFF(CHG) (p. 9).
- Attach the battery pack to the camcorder correctly (p. 9).
- Connect the mains lead to the wall socket properly (p. 9).
- The battery charge is completed (p. 10).

The CHG (charge) lamp flashes while the battery pack is being charged.

- Attach the battery pack to the camcorder correctly (p. 9). If the problem persists, disconnect the AC Adaptor from the wall socket and contact your Sony dealer. The battery pack may be worn-out.
-

The power turns off frequently although the remaining battery time indicator indicates that the battery pack has enough power to operate.

- A problem has occurred in the remaining battery time indicator, or the battery pack has not been charged enough. Fully charge the battery again to correct the indication (p. 9).
-

The remaining battery time indicator does not indicate the correct time.

- Ambient temperature is too high or too low, or the battery pack has not been charged enough. This is not a malfunction.
 - Fully charge the battery again. If the problem persists, the battery may be worn-out. Replace it with a new one (p. 9, 62).
 - The indicated time may not be correct in certain circumstances. For example, when you open or close the LCD panel, it takes about 1 minute to display the correct remaining battery time.
-

The battery pack discharges too quickly.

- Ambient temperature is too high or too low, or the battery pack has not been charged enough. This is not a malfunction.
 - Fully charge the battery again. If the problem persists, the battery may be worn-out. Replace it with a new one (p. 9, 62).
-

A problem occurs when the camcorder is connected to the AC Adaptor.

- Turn off the power, and disconnect the AC Adaptor from the wall socket. Then, connect it again.
-

LCD screen/viewfinder

A rippling effect appears on the LCD screen when you touch it.

- This is not a malfunction. Do not press hard on the LCD screen.
-

An unknown picture appears on the LCD screen or viewfinder.

- The camcorder is in [DEMO MODE] (p. 43). Touch the LCD screen or insert a cassette to cancel [DEMO MODE].
-

An unknown indicator appears on the screen.

- A warning indicator or message appears on the screen (p. 58).
-

The picture remains on the LCD screen.

- This occurs if you disconnect the DC plug from your camcorder or remove the battery pack without turning off the power first. This is not a malfunction.

The buttons do not appear on the touch panel.

- Touch the LCD screen lightly.
- Press DISP/BATT INFO on your camcorder (p. 14).

The buttons on the touch panel do not work correctly or do not work at all.

- Adjust the screen ([CALIBRATION]) (p. 67).

The picture in the viewfinder is not clear.

- Move the viewfinder lens adjustment lever until the picture appears clearly (p. 13).

The picture in the viewfinder has disappeared.

- Close the LCD panel. The picture is not displayed in the viewfinder when the LCD panel is open (p. 13).

Dots in lines appear on the LCD screen.

- This is not a malfunction. These dots are not recorded.

Cassette tapes

The cassette cannot be ejected from the compartment.

- Make sure the power source (battery pack or AC Adaptor) is connected correctly (p. 9).
- Remove the battery pack from the camcorder, then attach it again (p. 10).
- Attach a charged battery pack to the camcorder (p. 9).
- Moisture condensation has occurred inside the camcorder (p. 65).

The Cassette Memory indicator or title display does not appear while using a cassette with Cassette Memory.

- This camcorder does not support Cassette Memory, so the indicator does not appear.

The remaining tape indicator is not displayed.

- Set  [REMAIN] to [ON] to always display the remaining tape indicator (p. 43).

The cassette is noisier during rewinding or fast-forwarding.

- When using the AC Adaptor, rewind/fast forward speed increases (compared with battery operation) and therefore increases noise. This is not a malfunction.

Recording

Refer also to “Adjusting the image during recording” (p. 54).

The tape does not start when you press REC START/STOP.

- Slide the POWER switch repeatedly to turn on the CAMERA lamp (p. 20).
- The tape has reached the end. Rewind it, or insert a new cassette.
- Set the write-protect tab to REC or insert a new cassette (p. 62).
- The tape is stuck to the drum due to moisture condensation. Remove the cassette and leave your camcorder for at least 1 hour, then re-insert the cassette (p. 65).

You cannot record a smooth transition on a tape from the last recorded scene to the next.

- Perform END SEARCH (p. 26).
- Do not remove the cassette. (The picture will be recorded continuously without a break even when you turn the power off.)
- Do not record pictures in SP mode and LP mode on the same tape.
- Avoid stopping then recording a movie in the LP mode.

[END SCH] does not work.

- Do not eject the cassette after recording (p. 26).
- There is nothing recorded on the cassette.

[END SCH] does not work correctly.

- There is a blank section between recorded sections of the tape. This is not a malfunction.

Adjusting the image during recording

Refer also to “Menu” (p. 56).

The auto focus does not function.

- Set [FOCUS] to [↔ AUTO] (p. 32).
- The recording conditions are not suitable for auto focus. Adjust the focus manually (p. 32).

[STEADYSHOT] does not function.

- Set [STEADYSHOT] to [ON] (p. 40).

The BACK LIGHT function does not function.

- In the following settings, the BACK LIGHT function is canceled.
 - [MANUAL] of [EXPOSURE]
 - [SPOT METER]
- The BACK LIGHT function does not work during Easy Handycam operation (p. 19).

A vertical band appears when recording candlelight or electric light in the dark.

- This occurs when the contrast between the subject and the background is too high. This is not a malfunction.

A vertical band appears when recording a bright subject.

- This phenomenon is called the smear effect. This is not a malfunction.

The color of the picture is not correctly displayed.

- Deactivate the NightShot plus function (p. 22).

The screen picture is bright, and the subject does not appear on the screen.

- Deactivate the NightShot plus function (p. 22), or cancel the BACK LIGHT function (p. 22).

The picture appears too bright, or flickering or changes in color occurs.

- These anomalies may occur when recording pictures under the discharge tube, such as a fluorescent lamp, sodium lamp, or mercury lamp, with [PORTRAIT] or [SPORTS]. This is not a malfunction. Cancel [PROGRAM AE] to reduce the anomaly (p. 38).

Black bands appear when you record a TV screen or computer screen.

- Set [STEADYSHOT] to [OFF] (p. 40).

Playback

You cannot play back tape.

- Slide the POWER switch repeatedly to turn on the PLAY/EDIT lamp.
- Rewind the tape (p. 21).

Horizontal lines appear on the picture. The displayed pictures are not clear or do not appear.

- Clean the head using the cleaning cassette (optional) (p. 66).

No sound or only a low sound is heard.

- Turn up the volume (p. 21).
- Adjust [AUDIO MIX] from the [ST2] (additional sound) side until the sound is heard appropriately (p. 49).
- If you are using an S VIDEO plug, make sure the red and white plugs of the A/V connecting cable are also connected (p. 28).

The sound breaks off.

- Clean the head using the cleaning cassette (optional) (p. 66).
-

“---” is displayed on the screen.

- The tape you are playing was recorded without setting the date and time.
 - A blank section on the tape is being played.
 - The data code on a tape with a scratch or noise cannot be read.
-

Noises appear and **NIS** is displayed on the screen.

- The tape was recorded in a TV color system other than that of your camcorder (PAL). This is not a malfunction (p. 61).
-

4ch-12b is displayed on the screen.

- The tape you are playing was recorded on another device with a 4ch microphone (4CH MIC REC). Your camcorder is not compatible with 4ch microphone recording.
-

Menu

Menu items are grayed out.

- You cannot select grayed items in the current recording/playback situation.
-

You cannot use [SPOT FOCUS].

- You cannot use [SPOT FOCUS] together with [PROGRAM AE].
-

You cannot use [SPOT METER].

- You cannot use [SPOT METER] together with NightShot plus.
 - If you set [PROGRAM AE], [SPOT METER] is automatically set to [↵ AUTO].
-

You cannot use [EXPOSURE].

- You cannot use [EXPOSURE] together with NightShot plus.
 - If you set [PROGRAM AE], [EXPOSURE] is automatically set to [↵ AUTO].
-

You cannot use [WHT BAL].

- You cannot use [WHT BAL] together with NightShot plus.
-

You cannot use [PROGRAM AE].

- You cannot use [PROGRAM AE] together with NightShot plus.
-

Dubbing/Editing/Connecting to other devices

Time code and other information appear on the display of the connected device.

- Set [DISP OUT] to [LCD] while connected with an A/V connecting cable (p. 44).

You cannot dub correctly using the A/V connecting cable.

- The A/V connecting cable is not connected properly. Make sure that the A/V connecting cable is connected to the input jack of another device for dubbing a picture from your camcorder (p. 45).

New sound added to a recorded tape is not heard.

- Adjust [AUDIO MIX] from the [ST1] (original sound) side until the sound is heard appropriately (p. 49).

Pictures from connected devices are not displayed correctly.

- The input signal is not PAL (p. 61).

Connecting to a computer

The computer does not recognize your camcorder.

- Disconnect the cable from the computer and camcorder, then connect it again securely.
- Disconnect the cable from the computer and camcorder, restart the computer, then connect them again correctly.

You cannot view the video your camcorder is seeing on the computer.

- Disconnect the cable from the computer, turn on the camcorder, then connect it again.

You cannot view the video recorded on a tape on the computer.

- Disconnect the cable from the computer, then connect it again.

Warning indicators and messages

Self-diagnosis display/Warning indicators

If indicators appear on the LCD screen or in the viewfinder, check the following.

Some symptoms you can fix by yourself. If the problem persists even after you have tried a couple of times, contact your Sony dealer or local authorized Sony service facility.

C:(or E:) □□:□□ (Self-diagnosis display)

C:04:□□

- The battery pack is not an “InfoLITHIUM” battery pack. Use an “InfoLITHIUM” battery pack (p. 62).
- Connect the DC plug of the AC Adaptor to the DC IN jack of your camcorder securely (p. 9).

C:21:□□

- Moisture condensation has occurred. Remove the cassette and leave your camcorder for at least 1 hour, then re-insert the cassette (p. 65).

C:22:□□

- Clean the head using a cleaning cassette (optional) (p. 66).

C:31:□□ / C:32:□□

- Symptoms that are not described above have occurred. Remove and insert the cassette, then operate your camcorder again. Do not perform this procedure if moisture condensation has occurred (p. 65).
- Remove the power source. Reconnect it and operate your camcorder again.
- Change the cassette. Press RESET (p. 23), and operate your camcorder again.

E:61:□□ / E:62:□□

- Contact your Sony dealer or local authorized Sony service facility. Inform them of the 5-digit code, which starts from “E.”

(Battery level warning)

- The battery pack is nearly used up.
- Depending on the operating environment, or battery conditions,  may flash, even if there are approximately 5 to 10 minutes remaining.

(Moisture condensation warning)*

- Eject the cassette, remove the power source, and then leave it for about 1 hour with the cassette lid open (p. 65).

(Warning indicators pertaining to the tape)

Slow flashing:

- There is less than 5 minutes remaining on the tape.
- No cassette is inserted.*
- The write-protect tab on the cassette is set to lock (p. 62).*

Fast flashing:

- The tape has run out.*

(Eject cassette warning)*

Slow flashing:

- The write-protect tab on the cassette is set to lock (p. 62).

Fast flashing:

- Moisture condensation has occurred (p. 65).
- The self-diagnosis display code is displayed (p. 58).

* You hear a melody when the warning indicators appear on the screen (p. 44).

Description of warning messages

If messages appear on the screen, follow the instructions.

■ Battery/Power

Use the “InfoLITHIUM” battery pack. (p. 62)

Battery level is low.

- Change the battery (p. 9, 62).

Old battery. Use a new one. (p. 62)

▲ Re-attach the power source. (p. 9)

Use new AC adapter or reinsert. (p. 9)

■ Moisture condensation

☒▲ Moisture condensation. Eject the cassette (p. 65)

☒ Moisture condensation. Turn off for 1H. (p. 65)

■ Cassette/Tape

☒ Insert a cassette. (p. 17)

▲ Reinsert the cassette. (p. 17)

- Check if the cassette is damaged.

☒▲ The tape is locked - check the tab. (p. 62)

☒ The tape has reached the end. (p. 17, 21)

- Rewind or change the tape.

■ Others

Cannot record due to copyright protection. (p. 61)

Cannot add audio. Disconnect the i.LINK cable. (p. 48)

Not recorded in SP mode. Cannot add audio. (p. 48)

Not recorded in 12-bit audio. Cannot add audio. (p. 48)

Cannot add audio on the blank portion of a tape. (p. 48)

Cannot add audio. (p. 48)

- You cannot add sound to a tape recorded on other devices by 4CH MIC REC.

☒☒ Dirty video head. Use a cleaning cassette. (p. 66)

Cannot start Easy Handycam. (p. 18, 51)

Cannot cancel Easy Handycam. (p. 18, 51)

Invalid during Easy Handycam operation. (p. 19)

HDV recorded tape. Cannot playback.

- Your camcorder cannot play back this format. Play back the tape with the equipment that recorded it.
-

HDV recorded tape. Cannot add audio.

- Your camcorder does not allow you to add audio on a section of a tape recorded in HDV format (p. 48).
-

Using your camcorder abroad

Power supply

You can use your camcorder in any country/region using the AC Adaptor supplied with your camcorder within the AC 100 V to 240 V, 50/60 Hz range.

On TV color systems

Your camcorder is PAL system, so its picture can only be viewed on a PAL system TV with an AUDIO/VIDEO input jack.

System	Used in
PAL	Australia, Austria, Belgium, China, Czech Republic, Denmark, Finland, Germany, Holland, Hong Kong, Hungary, Italy, Kuwait, Malaysia, New Zealand, Norway, Poland, Portugal, Singapore, Slovak Republic, Spain, Sweden, Switzerland, Thailand, United Kingdom, etc.
PAL - M	Brazil
PAL - N	Argentina, Paraguay, Uruguay.
SECAM	Bulgaria, France, Guiana, Iran, Iraq, Monaco, Russia, Ukraine, etc.
NTSC	Bahama Islands, Bolivia, Canada, Central America, Chile, Colombia, Ecuador, Guyana, Jamaica, Japan, Korea, Mexico, Peru, Surinam, Taiwan, the Philippines, the U.S.A., Venezuela, etc.

Simple setting of the clock by time difference

You can easily set the clock to local time abroad by the time difference you are in. Select [WORLD TIME] in the **[ETC]** (OTHERS) menu, then set the time difference (p. 44).

Usable cassette tapes

You can use mini DV format cassettes only. Use a cassette with the **Mini DV** mark. Your camcorder is not compatible with the Cassette Memory function.

To prevent a blank section from being created on the tape

Go to the end of the recorded section using END SEARCH (p. 26) before you begin the next recording in the following cases:

- You have played back the tape.
- You have used EDIT SEARCH.

Copyright signal

■ When you play back

If the cassette you play back on your camcorder contains copyright signals, you cannot copy it to a tape in another video camera connected to your camcorder.

■ For DCR-HC28E: When you record

You cannot record software on your camcorder that contains copyright control signals for copyright protection of software. [Cannot record due to copyright protection.] appears on the LCD screen, or on the viewfinder if you try to record such software. Your camcorder does not record copyright control signals on the tape when it records.

Notes on use

■ When not using your camcorder for a long time

Remove the cassette and store it.

Usable cassette tapes (Continued)

■ To prevent accidental erasure

Slide the write-protect tab on the cassette to set it to SAVE.



REC: The cassette can be recorded.

SAVE: The cassette cannot be recorded (write-protected).



■ When labeling the cassette

Be sure to place the label only on the locations shown in the following illustration so as not to cause a malfunction of your camcorder.

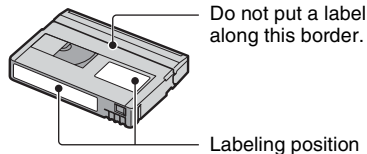

■ After using the cassette

Rewind the tape to the beginning to avoid distortion of the picture or the sound. The cassette should then be put in its case, and stored in an upright position.

■ When cleaning the gold-plated connector

Generally, clean the gold-plated connector on a cassette with a cotton-wool swab after every 10 times it has been ejected.

If the gold-plated connector on the cassette is dirty or dusty, the remaining tape indicator may not show correctly.

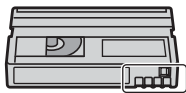

Gold-plated connector

About the “InfoLITHIUM” battery pack

This unit is compatible with an “InfoLITHIUM” battery pack (P series). Your camcorder operates only with an “InfoLITHIUM” battery pack. “InfoLITHIUM” P series battery packs have the  mark.

What is an “InfoLITHIUM” battery pack?

An “InfoLITHIUM” battery pack is a lithium-ion battery pack that has functions for communicating information related to operating conditions between your camcorder and an optional AC Adaptor/charger.

The “InfoLITHIUM” battery pack calculates the power consumption according to the operating conditions of your camcorder, and displays the remaining battery time in minutes.

To charge the battery pack

- Be sure to charge the battery pack before you start using your camcorder.
- We recommend charging the battery pack in an ambient temperature of between 10 °C to 30 °C (50 °F to 86 °F) until the CHG (charge) lamp turns off. If you charge the battery pack outside of this temperature range, you may not be able to charge it efficiently.
- When charging the battery pack while the AC Adaptor is connected to your camcorder, after charging is complete, disconnect the cable from the DC IN jack on your camcorder or remove the battery pack.

To use the battery pack effectively

- Battery pack performance decreases when the surrounding temperature is 10 °C (50 °F) or below, and the length of time you can use the battery pack becomes shorter. In that case, do one of the following to use the battery pack for a longer time.
 - Put the battery pack in a pocket to warm it up, and insert it in your camcorder right before you start taking shots.
 - Use a large capacity battery pack: NP-FP50/FP71/FP90 (optional).

- Frequent use of the LCD screen or a frequent playback, fast forward or rewind operation wears out the battery pack faster.
We recommend using a large capacity battery pack: NP-FP50/FP71/FP90 (optional).
- Be sure to set the POWER switch to OFF(CHG) when not recording or playing back on your camcorder. The battery pack is also consumed when your camcorder is in recording standby or playback pause.
- Have spare battery packs ready for two or three times the expected recording time, and make trial recordings before making the actual recording.
- Do not expose the battery pack to water. The battery pack is not water resistant.

About the remaining battery time indicator

- When the power goes off even though the remaining battery time indicator indicates that the battery pack has enough power to operate, charge the battery pack fully again. Remaining battery time will be indicated correctly. Note, however, that the battery indication will not be restored if it is used in high temperatures for a long time, or if left in a fully charged state, or when the battery pack is frequently used. Use the remaining battery time indication as a rough guide only.
- The  mark that indicates low battery flashes even if there are still 5 to 10 minutes of battery time remaining, depending on the operating conditions or ambient temperature.

About storage of the battery pack

- If the battery pack is not used for a long time, fully charge the battery pack and use it up on your camcorder once a year to maintain proper function. To store the battery pack, remove it from your camcorder and put it in a dry, cool place.
- To discharge the battery pack on your camcorder completely, set [A.SHUT OFF] to [NEVER] on the  (OTHERS) menu and leave your camcorder in tape recording standby until the power goes off (p. 44).

About battery life

- Battery capacity decreases over time and through repeated use. If decreased usage time between charges becomes significant, it is probably time to replace it with a new one.
- Each battery's life is governed by storage, operating and environmental conditions.

About i.LINK

The DV Interface on this unit is an i.LINK-compliant DV Interface. This section describes the i.LINK standard and its features.

What is i.LINK?

i.LINK is a digital serial interface for transferring digital video, digital audio, and other data to other i.LINK-compatible devices. You can also control other devices using the i.LINK.

i.LINK-compatible devices can be connected using an i.LINK cable. Possible applications are operations and data transactions with various digital AV devices.

When two or more i.LINK-compatible devices are daisy-chained with the unit, operation becomes possible from any device in the chain. Note that operation method may vary, or data transactions may not be possible, depending on specifications and characteristics of the connected devices.

- Normally, only one device can be connected to this unit with an i.LINK cable. When connecting this unit to an i.LINK-compatible device having two or more DV Interfaces, refer to the operating instructions of the device to be connected.
- i.LINK is a more familiar term for the IEEE 1394 data transport bus proposed by Sony, and is a trademark approved by many corporations.
- IEEE 1394 is an international standard standardized by the Institute of Electrical and Electronics Engineers.

About the i.LINK Baud rate

i.LINK's maximum baud rate varies according to the device. There are 3 types.

S100 (approx. 100Mbps*)

S200 (approx. 200Mbps)

S400 (approx. 400Mbps)

The baud rate is listed under "Specifications" in the operating instructions of each piece of equipment. It is also indicated near the i.LINK interface on some devices.

The baud rate may differ from the indicated value when the unit is connected to a device with a different maximum baud rate.

* What is Mbps?

Mbps stands for "megabits per second," or the amount of data that can be sent or received in one second. For example, a baud rate of 100 Mbps means that 100 megabits of data can be sent in one second.

To use i.LINK functions on this unit

For details on how to dub when this unit is connected to other video devices having a DV Interface, see page 45, 47.

This unit can also be connected to other i.LINK (DV Interface) compatible devices made by Sony (e.g. a VAI0 series personal computer) as well as to video devices.

Some i.LINK compatible video devices, such as Digital Televisions, DVD, MICROMV or HDV recorders/players are not compatible with DV devices. Before connecting to other devices, be sure to confirm whether the device is compatible with a DV device or not. For details on precautions and compatible application software, refer also to the operating instructions for the device to be connected.

- When you connect this unit to a device equipped with an i.LINK jack using an i.LINK cable, power off the device and remove the mains lead from the wall socket before connecting (or disconnecting) an i.LINK cable.

About the required i.LINK cable

Use the Sony i.LINK 4-pin-to-4-pin cable (during DV dubbing).

Maintenance and precautions

On use and care



- Do not use or store the camcorder and accessories in the following locations.
 - Anywhere extremely hot or cold. Never leave them exposed to temperatures above 60 °C (140 °F), such as under direct sunlight, near heaters or in a car parked in the sun. They may malfunction or become deformed.
 - Near strong magnetic fields or mechanical vibration. The camcorder may malfunction.
 - Near strong radio waves or radiation. The camcorder may not be able to record properly.
 - Near AM receivers and video equipment. Noise may occur.
 - On a sandy beach or anywhere dusty. If sand or dust gets in your camcorder, it may malfunction. Sometimes this malfunction cannot be repaired.
 - Near windows or outdoors, where the LCD screen, the viewfinder, or the lens may be exposed to direct sunlight. This damages the inside of the viewfinder or the LCD screen.
 - Anywhere very humid.
- Operate your camcorder on DC 7.2 V (battery pack) or DC 8.4 V (AC Adaptor).
- For DC or AC operation, use the accessories recommended in these operating instructions.
- Do not let your camcorder get wet, for example, from rain or sea water. If your camcorder gets wet, it may malfunction. Sometimes this malfunction cannot be repaired.
- If any solid object or liquid gets inside the casing, unplug your camcorder and have it checked by a Sony dealer before operating it any further.
- Avoid rough handling, disassembling, modifying, physical shock, or impact such as hammering, dropping or stepping on the product. Be particularly careful of the lens.
- Keep the POWER switch setting to OFF(CHG) when you are not using your camcorder.

- Do not wrap your camcorder with a towel, for example, and operate it. Doing so might cause heat to build up inside.
- When disconnecting the mains lead, pull it by the plug and not the lead.
- Do not damage the mains lead such as by placing anything heavy on it.
- Keep metal contacts clean.
- If the battery electrolytic liquid has leaked,
 - consult your local authorized Sony service facility.
 - wash off any liquid that may have contacted your skin
 - if any liquid gets in your eyes, wash with plenty of water and consult a doctor.

■ When not using your camcorder for a long time

- Periodically turn on the camcorder and play a cassette for about 3 minutes.
- Use up the battery pack completely before storing it.



Moisture condensation

If your camcorder is brought directly from a cold place to a warm place, moisture may condense inside your camcorder, on the surface of the tape, or on the lens. In this state, the tape may stick to the head drum and be damaged or your camcorder may not operate correctly. If there is moisture inside your camcorder, [] Moisture condensation. Eject the cassette] or [] Moisture condensation. Turn off for 1H.] appears. The indicator will not appear when the moisture condenses on the lens.

■ If moisture condensation has occurred

None of the functions except cassette ejection will work. Eject the cassette, turn off your camcorder, and leave it for about one hour with the cassette lid open. Your camcorder can be used again when both of the following conditions are met:

Maintenance and precautions (Continued)

- The warning message does not appear when the power is turned on.
- Neither  or  flash when a cassette is inserted and video operation buttons are touched.

If moisture starts to condense, your camcorder sometimes cannot detect condensation. If this happens, the cassette is sometimes not ejected for 10 seconds after the cassette lid is opened. This is not a malfunction. Do not close the cassette lid until the cassette is ejected.

■ Note on moisture condensation

Moisture may condense when you bring your camcorder from a cold place into a warm place (or vice versa) or when you use your camcorder in a humid place as shown below.

- When you bring your camcorder from a ski slope into a place warmed up by a heating device.
- When you bring your camcorder from an air conditioned car or room into a hot place outside.
- When you use your camcorder after a squall or a shower.
- When you use your camcorder in a hot and humid place.

■ How to avoid moisture condensation

When you bring your camcorder from a cold place into a warm place, put your camcorder in a plastic bag and seal it tightly. Remove the bag when the air temperature inside the plastic bag has reached the surrounding temperature (after about one hour).

Video head

- If the video heads are dirty, video or sound distortion may be apparent.
- If the following problem occurs, clean the video heads for 10 seconds with the Sony DVM-12CLD cleaning cassette (optional).

- Mosaic-pattern noise appears on the playback picture or the screen is displayed in blue.



- Playback pictures do not move.
 - Playback pictures do not appear or the sound breaks off.
 -  Dirty video head. Use a cleaning cassette.] appears on the screen during recording/playback.
- The video heads will wear after long use. If you cannot obtain a clear image even after using a cleaning cassette (optional), it might be because the video heads are worn. Please contact your Sony dealer or local authorized Sony service facility to have the video heads replaced.

LCD screen

- Do not exert excessive pressure on the LCD screen, as it may cause damage.
- If your camcorder is used in a cold place, a residual image may appear on the LCD screen. This is not a malfunction.
- While using your camcorder, the back of the LCD screen may heat up. This is not a malfunction.

■ To clean the LCD screen

If fingerprints or dust make the LCD screen dirty, it is recommended you use a soft cloth to clean it. When you use the LCD Cleaning Kit (optional), do not apply the cleaning liquid directly to the LCD screen. Use cleaning paper moistened with the liquid.

■ On adjustment of the LCD screen (CALIBRATION)

The buttons on the touch panel may not work correctly. If this happens, follow the procedure below. It is recommended you connect your camcorder to the wall socket using the supplied AC Adaptor during the operation.

- ① Slide the POWER switch to OFF(CHG).
- ② Eject the cassette from your camcorder, then disconnect any connecting cables except the AC Adaptor from your camcorder.
- ③ Slide the POWER switch repeatedly to turn on the PLAY/EDIT lamp while pressing DISP/BATT INFO on your camcorder, and keep pressing down DISP/BATT INFO for about 5 seconds.
- ④ Touch the “x” displayed on the screen with the corner of the “Memory Stick” or the like.

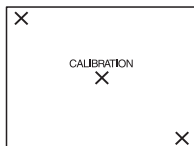

The position of the “x” changes. If you did not press the right spot, start from step ④ again.

- You cannot calibrate the LCD screen if it is rotated.

On handling the casing

- If the casing is soiled, clean the camcorder body with a soft cloth lightly moistened with water, and then wipe the casing with a dry soft cloth.
- Avoid the following to avoid damage to the finish.
 - Using chemicals such as thinner, benzene, alcohol, chemical cloths, repellent, insecticide and sunscreen.
 - Handling with above substances on your hands.
 - Leaving the casing in contact with rubber or vinyl objects for a long period of time.

About care and storage of the lens

- Wipe the surface of the lens clean with a soft cloth in the following instances:
 - When there are fingerprints on the lens surface.
 - In hot or humid locations
 - When the lens is exposed to salty air such as at the seaside.
- Store in a well-ventilated location subject to little dirt or dust.
- To prevent mold, periodically clean the lens as described above. It is recommended that you operate your camcorder about once a month to keep it in optimum state for a long time.

On charging the pre-installed rechargeable battery

Your camcorder has a pre-installed rechargeable battery to retain the date, time, and other settings even when the POWER switch is set to OFF(CHG). The pre-installed rechargeable battery is always charged while your camcorder is connected to the wall socket via the AC Adaptor or while the battery pack is attached. The rechargeable battery will be fully discharged in about **3 months** if you do not use your camcorder at all without the AC Adaptor connected or the battery pack attached. Use your camcorder after charging the pre-installed rechargeable battery.

However, even if the pre-installed rechargeable battery is not charged, the camcorder operation will not be affected as long as you are not recording the date.

■ Procedures

Connect your camcorder to a wall socket using the supplied AC Adaptor, and leave it with the POWER switch set to OFF(CHG) for more than 24 hours.

Specifications

System

Video recording system

2 rotary heads, Helical scanning system

Audio recording system

Rotary heads, PCM system

Quantization: 12 bits (Fs 32 kHz, stereo 1, stereo 2), 16 bits (Fs 48 kHz, stereo)

Video signal

PAL color, CCIR standards

Usable cassette

Mini DV cassette with the ^{Mini} DV mark printed

Tape speed

SP: Approx. 18.81 mm/s

LP: Approx. 12.56 mm/s

Recording/playback time

SP: 60 min (using a DVM60 cassette)

LP: 90 min (using a DVM60 cassette)

Fast forward/rewind time

Approx. 2 min 40 s (using a DVM60 cassette and rechargeable battery pack)

Approx. 1 min 45 s (using a DVM60 cassette and AC Adaptor)

Viewfinder

Electric viewfinder (color)

Image device

3.0 mm (1/6 type) CCD (Charge Coupled Device)

Gross: Approx. 800 000 pixels

Effective (movie): Approx. 400 000 pixels

Lens

Carl Zeiss Vario-Tessar

20 × (Optical), 800 × (Digital)

Focal length

f=2.3 ~ 46 mm (3/32 ~ 1 13/16 in.)

When converted to a 35 mm still camera

In CAMERA: 44 ~ 880 mm (1 3/4 ~ 34 1/32 in.)

F1.8 ~ 3.1

Filter diameter: 25 mm (1 in.)

Color temperature

[AUTO], [ONE PUSH], [INDOOR]
(3 200 K), [OUTDOOR] (5 800 K)

Minimum illumination

5 lx (lux) (F 1.8)

0 lx (lux) (during NightShot plus
function)

Input/Output connectors**Audio/Video output**

10-pin connector

Video signal: 1 Vp-p, 75 Ω (ohms),
unbalanced

Luminance signal: 1 Vp-p, 75 Ω
(ohms), unbalanced

Chrominance signal: 0.3 Vp-p, 75 Ω
(ohms), unbalanced

Audio signal: 327 mV (at load
impedance 47 kΩ (kilohms)), Output
impedance with less than 2.2 kΩ
(kilohms)

DV input/output (DCR-HC28E)

i.LINK Interface (IEEE1394, 4-pin
connector S100)

DV output (DCR-HC27E)

i.LINK Interface (IEEE1394, 4-pin
connector S100)

LCD screen**Picture**

6.2 cm (2.5 type)

Total dot number

123 200 (560 × 220)

General**Power requirements**

DC 7.2 V (battery pack)

DC 8.4 V (AC Adaptor)

Average power consumption

During camera recording using the
viewfinder 1.8 W

During camera recording using the
LCD 2.1 W

Operating temperature

0 °C to 40 °C (32 °F to 104 °F)

Storage temperature

-20 °C to +60 °C (-4 °F to +140 °F)

Dimensions (approx.)

65 × 79 × 113 mm

(2 5/8 × 3 1/8 × 4 1/2 in.) (w/h/d)

(including the projecting parts)

65 × 79 × 113 mm

(2 5/8 × 3 1/8 × 4 1/2 in.) (w/h/d)

(including the projecting parts with
supplied battery pack NP-FP30
attached)

Mass (approx.)

360 g (12 oz) main unit only

420 g (14 oz) including the NP-FP30
rechargeable battery pack and DVM60
cassette.

Supplied accessories

See page 8.

AC Adaptor AC-L25A/L25B**Power requirements**

AC 100 - 240 V, 50/60 Hz

Current consumption

0.35 - 0.18 A

Power consumption

18 W

Output voltage

DC 8.4 V*

Operating temperature

0 °C to 40 °C (32 °F to 104 °F)

Storage temperature

-20 °C to +60 °C (-4 °F to +140 °F)

Specifications (Continued)

Dimensions (approx.)

56 × 31 × 100 mm (2 1/4 × 1 1/4 × 4 in.)
(w/h/d) excluding the projecting parts

Mass (approx.)

190 g (6.7 oz) excluding the mains lead

* See the label on the AC Adaptor for other specifications.

Rechargeable battery pack (NP-FP30)

Maximum output voltage

DC 8.4 V

Output voltage

DC 7.2 V

Capacity

3.6 Wh (500 mAh)

Dimensions (approx.)

31.8 × 18.5 × 45.0 mm
(1 5/16 × 3/4 × 1 13/16 in) (w/h/d)

Mass (approx.)

40 g (1.5 oz)

Operating temperature

0 °C to 40 °C (32 °F to 104 °F)

Type



Lithium ion

Design and specifications are subject to change without notice.

Types of differences

DCR-HC	27E	28E
DV Interface	OUT	IN/OUT

On trademarks

- “InfoLITHIUM” is a trademark of Sony Corporation.
- i.LINK and  are trademarks of Sony Corporation.
- Mini  Digital Video Cassette is a trademark.
- “Handycam” and  are registered trademarks of Sony Corporation.
- Microsoft, Windows, and Windows Media are trademarks or registered trademarks of U.S. Microsoft Corporation in the U.S. and other countries.

All other product names mentioned herein may be the trademarks or registered trademarks of their respective companies. Furthermore, TM and “®” are not mentioned in each case in this manual.

Index

Numeric

12BIT	42
16BIT	42
16:9 WIDE.....	40
21-pin adaptor.....	28
4:3	40

A

A DUB CTRL (Audio dubbing)	49
AC Adaptor.....	9
Adjusting exposure for back light	22, 54
AUDIO MIX.....	49
AUDIO MODE.....	42
AUTO SHTR (Auto shutter).....	39
A.SHUT OFF (Auto shut off)	44
A/V connecting cable	28, 45
A/V OUT jack.....	28, 45

B

BACK LIGHT	22, 54
BATT (battery) release lever	10
Battery	
Battery info.....	23
Battery pack.....	9
Charging time	10
Playing time.....	11
Recording time	11
Remaining battery	24
BEACH&SKI	38
BEEP	44
BLACK.....	33
B&W.....	39

C

CALIBRATION	67
CAM DATA	35

CAMERA SET menu.....	39
Cassette	17, 61
Insert/Eject.....	17
Write-protect tab	62
Cassette compartment	17
Charging the battery.....	9
Battery pack	9
Pre-installed rechargeable battery	68
Charging time.....	10
CHG (charge) lamp.....	10
CLOCK SET	16
Connect	
TV	28, 47
VCR	28, 45, 47

D

D ZOOM (Digital zoom)	39
DATA CODE.....	24, 35
DATE/TIME	16, 24, 35
DC IN jack	9
DC plug	9
DEMO MODE	43, 51
DISP GUIDE (Display guide).....	14
DISP OUT (Display output)	44
Display indicators	24
DISP/BATT INFO button	14, 23
Double speed Playback	36
Dubbing.....	45, 48
DV Interface.....	45, 47, 50

E

EASY button	18
Easy Handycam.....	18, 31
EDITSEARCH	26, 40
END SCH (END SEARCH).....	26, 54
EXPOSURE	34, 56

F

FADER	33
Fireworks	38
Flexible spot meter	See SPOT METER
FN (Function) button.....	24, 30
FOCUS	32, 54
Frame-by-frame Playback	36
Full charge	10

G

Getting started	8
Grip belt.....	12

H

Holding the camcorder	12
-----------------------------	----

I

Icon.....	See Display indicators
Indicators	25
INDOOR.....	34
“InfoLITHIUM” battery pack	62
Infrared port.....	22
Initialize (Reset)	23
Internal stereo microphone...23	
i.LINK	64
i.LINK cable.....	45, 47

J

Jack.....	50
-----------	----

L

Label	62
LANDSCAPE.....	38
LANGUAGE.....	43
LCD	44
LCD BRT (LCD bright)	35
LCD B.L. (LCD back light).....	41
LCD COLOR.....	41

Index (Continued)

LCD panel	13
LCD screen.....	13
LCD/VF SET menu.....	41
Lens cap.....	8, 12, 18
LETTER BOX.....	42
Lid	17
LP (Long Play).....	42

M

Mains lead	9
Maintenance	65
MANUAL SET menu	38
Menu.....	30
CAMERA SET menu.....	39
LCD/VF SET menu.....	41
MANUAL SET menu	38
Menu items.....	37
OTHERS menu	44
PLAYER SET menu	41
SETUP MENU menu.....	43
TAPE SET menu.....	42
Using the menu	30
VCR SET menu.....	41
Mirror mode	23
Moisture condensation	65
MONOTONE	33
MOSAIC	39
MOSC. FADER.....	33
Movie	
REC MODE	
(Recording mode).....	42

N

NEG.ART.....	38
NightShot plus.....	22
NIGHTSHOT PLUS switch	
.....	22
NTSC.....	61
N.S.LIGHT	
(NightShot Light)	40

O

ONE PUSH.....	34
OPEN/EJECT lever	17
Operation button	30
Operation confirmation beep	
..... See BEEP	
OTHERS menu.....	44
OUTDOOR.....	34

P

P EFFECT (Picture effect)...	38
PAL.....	56, 61
PASTEL.....	39
Picture Search	21
Playback.....	21
Double speed	36
Frame	36
Reverse	36
Slow	36
PLAYER SET menu.....	41
Playing time	11
PORTRAIT (Soft portrait)...	38
POWER switch.....	9, 12
Pre-installed rechargeable	
battery	68
PROGRAM AE	38, 56

R

REC CTRL	
(Recording control).....	47
REC MODE	
(Recording mode)	42
Rec review	27
REC START/STOP button	
.....	18, 20
Rechargeable battery pack	
..... See Battery	
Recording.....	20
Recording capacity	24
Recording time.....	11
REMAIN.....	43
RESET button	23

Reversal Playback	36
-------------------------	----

S

S VIDEO cable.....	28, 45
S VIDEO jack.....	28, 45
Searching for the starting point	
.....	26
Self-diagnosis display	58
SEPIA.....	39
Setting the date and time	16
SETUP MENU menu	43
Shoulder Belt.....	23
Skip Scan.....	21
Slow Playback	36
SOLARIZE.....	39
SP (Standard Play)	42
Speaker	23
Specifications	68
SPORTS (Sports lesson)	38
SPOT FOCUS	32, 56
SPOT METER	
(Flexible spot meter)	32, 56
SPOTLIGHT	38
SQUEEZE	42
STEADYSHOT.....	40, 54
SUNSETMOON.....	38

T

Tape counter	24
TAPE SET menu	42
Tape	See Cassette
Telephoto.....	22
Time code.....	24
Touch panel.....	14
Trademark	70
Tripod	23
TV.....	28, 47
TV color systems.....	61

U

Using abroad	61
--------------------	----

V

V SPD PLAY (Various speed playback)	36
VCR SET menu	41
VF B.L. (Viewfinder back light).....	42
Video head	66
Video operation buttons.....	24
Viewfinder	13
Back light	42
Viewfinder lens adjustment lever	13
VOL (Volume).....	21
V-OUT/LCD.....	44

W

Wall socket	9
Warning indicators.....	58
Warning messages	59
WHITE	33
WHT BAL (White balance).....	34, 56
Wide angle	22
WIDE DISP (Wide display)	42
WIDE SEL (Wide select).....	40
WORLD TIME.....	44
Write-protect tab	62

Z

Zoom.....	22
Zoom lever.....	22

Additional information on this product and answers to frequently asked questions can be found at our Customer Support Website.

<http://www.sony.net/>



Printed on 70% or more recycled paper using VOC (Volatile Organic Compound)-free vegetable oil based ink.

Printed in Japan



2891371110