

SONY[®]

3-089-914-14 (1)

Digital Video Camera Recorder



Operating Instructions

Before operating the unit, please read this manual thoroughly, and retain it for future reference.

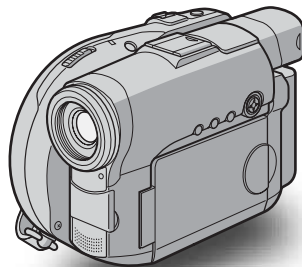
**HANDYCAM**

**DCR-DVD91E/DVD101E/
DVD201E**

Welcome!

Congratulations on your purchase of this Sony Handycam. With your Handycam you can capture life's precious moments with superior picture and sound quality. Your Handycam is loaded with advanced features, but at the same time it is very easy to use. You will soon be producing home video that you can enjoy for years to come.

WARNING

To prevent fire or shock hazard, do not expose the unit to rain or moisture.
To avoid electrical shock, do not open the cabinet.
Refer servicing to qualified personnel only.



Certain countries and regions may regulate disposal of the battery used to power this product. Please consult with your local authority.

CAUTION

The use of optical instruments with this product will increase eye hazard. Use of controls or adjustments or performance of procedures other than those specified herein may result in hazardous radiation exposure.

NOTICE ON THE SUPPLIED AC ADAPTOR FOR CUSTOMERS IN THE UNITED KINGDOM

A moulded plug complying with BS1363 is fitted to this equipment for your safety and convenience.

Should the fuse in the plug supplied need to be replaced, a fuse of the same rating as the supplied one and approved by ASTA or BSI to BS1362 (i.e., marked with  or  mark) must be used.

If the plug supplied with this equipment has a detachable fuse cover, be sure to attach the fuse cover after you change the fuse. Never use the plug without the fuse cover. If you should lose the fuse cover, please contact your nearest Sony service station.

For the customers in Europe

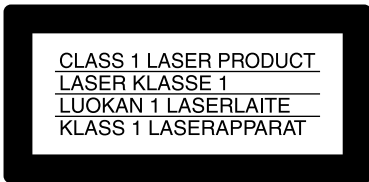

ATTENTION

The electromagnetic fields at the specific frequencies may influence the picture and sound of this camcorder.

This product has been tested and found compliant with the limits set out in the EMC Directive for using connection cables shorter than 3 meters. (9.8 feet)

Notice

If static electricity or electromagnetism causes data transfer to discontinue midway (fail), restart the application or disconnect and connect the USB cable again.

Read this first

What you can do with your DVD Handycam

Your DVD Handycam uses DVD-R and DVD-RW as a recording media. You can enjoy your DVD Handycam in ways that are new and different from those of a tape media-based camcorder. Read the next few pages to find out how.

You can find a scene quickly using a Visual Index display.

The Visual Index display shows thumbnails of movies and still images recorded on the disc in your DVD Handycam. You can find the desired scene quickly using this convenient index.

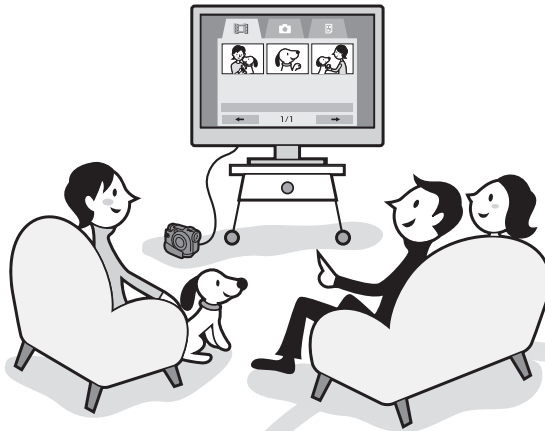

You can play back still images, one after another.

You can play back still images one after another on your DVD Handycam. You can also enjoy the playback of still images continuously on a DVD player if you finalize the disc.

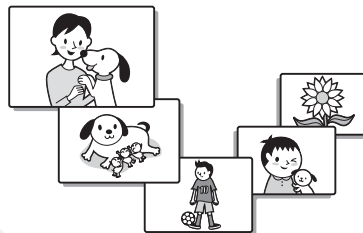

You can play back a disc recorded with your DVD Handycam on your DVD player.

You can play back a disc recorded with your DVD Handycam on DVD players that can play back DVD-R/DVD-RW.

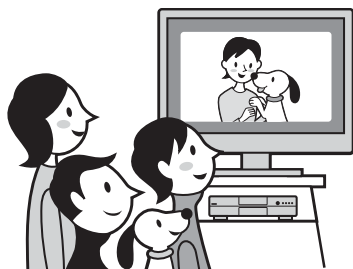

You can edit and copy a disc easily by connecting your DVD Handycam to your computer.

You can edit and copy a disc easily on your computer using the supplied ImageMixer Ver.1.5 for Sony DVD Handycam software. It also enables you to produce your own original DVD disc.

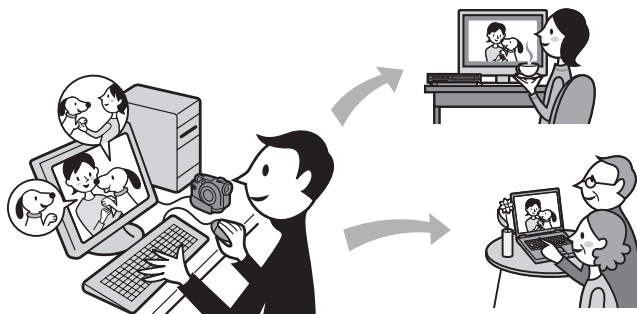

What is the difference between DVD-R and DVD-RW?

2 types of discs are available and they are different in the following ways.



Which disc can I use?

8cm DVD-Rs and 8cm DVD-RWs are available.



How can I choose between these 2 discs?

The number of recordable times is different for the 2 discs. Choose the one that meets your needs.

8cm DVD-R

You can use the following discs:

- **DMR30 (single-sided disc)**
- **DMR60DS (double-sided disc)**

DVD-Rs can be recorded only once.

They are suitable for long-term records and for making a backup copies.
Recorded in VIDEO mode.

8cm DVD-RW

You can use the following discs:

- **DMW30 (single-sided disc)**
- **DMW60DS (double-sided disc)**

DVD-RWs can be overwritten repeatedly.

They are suitable for source gathering and temporary recordings.
You can choose VIDEO mode or VR mode to make your recordings.

Discs other than these 2 types cannot be used in your DVD Handycam.

Examples of incompatible discs

- **12cm DVD-R**
- **12cm DVD-RW**
- **DVD+R**
- **DVD-RAM**
- **DVD+RW**
- **DVD-ROM**
- **CD-R**
- **CD-RW**



What kind of player can I use for playback?

You can play back a disc you have recorded on your DVD Handycam on other players by finalizing the disc (see page 65).

The following list shows examples of players that can play back a disc recorded by your DVD Handycam. However, playback compatibility is not guaranteed with all players.*¹

DVD-R (VIDEO mode only)

Players compatible with the DVD Video format.



DVD player/
DVD recorder



Computer with a
DVD drive installed

DVD-RW (in VIDEO mode)

Players that can play back DVD-RWs.



DVD player/
DVD recorder



Computer with a
DVD drive installed

DVD-RW (in VR mode)

Players that can play back DVD-RWs in VR mode.



DVD player/
DVD recorder



Computer with a
DVD drive installed

In VIDEO mode and VR (Video Recording) mode

VIDEO mode: A disc has wide compatibility with other players.

VR mode: A disc can be edited on DVD Handycam but the players are limited.

*¹ DVD-R/RW discs recorded by Sony DVD Handycam camcorders are designed to be compatible with and may be played back on home DVD players, computer DVD drives and PlayStation 2 video game consoles.*²

*² Playback on all home DVD players, computer DVD drives and PlayStation 2 consoles cannot be guaranteed. Some players, drives, and video game consoles lack the ability to read due to the optical reflection standards of DVD-R/RW discs and/or due to decoding incompatibilities. Refer to the specifications of your playback equipment for additional compatibility information.

How to prepare and use your DVD Handycam

Preparing



Prepare a new disc.

- You can start recording promptly with a DVD-R.
- You need to format a DVD-RW before recording. Formatting is also required when using a once recorded DVD-RW again.

Select a recording format (either VIDEO mode or VR mode) when using DVD-RW.

Shooting

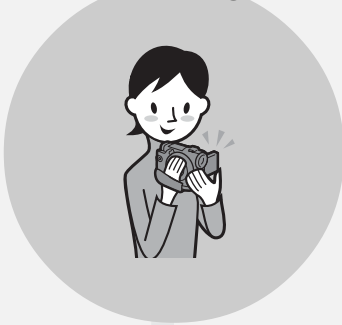

Both movies and still images can be recorded on a single disc.

Because your movies and still images are recorded in free areas on the disc automatically, important recordings are not overwritten.

If you finalize the recorded disc after shooting, you can play it back immediately on DVD players, etc..

Playing back

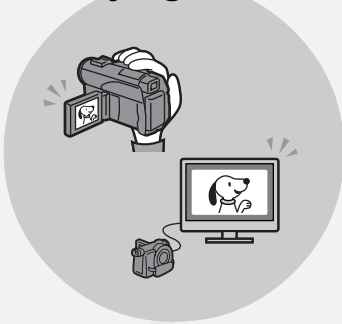

Select a scene to play back from the Visual Index display.

If you finalize the recorded disc after shooting, you can play it back on DVD players, etc..

Continued on the right page.

Editing



- You can make a copy of a disc you have recorded by connecting your DVD Handycam to your computer with the supplied software.

For the recommended computer system environment, see page 91.

- You can produce an original DVD by editing your movies/still images on your computer.

Finalizing

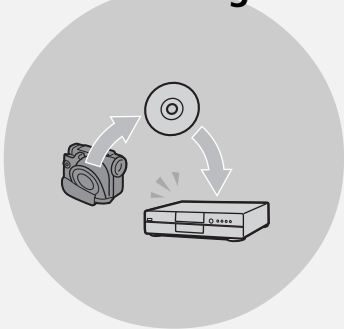

- Finalize the disc so that it becomes compatible with other DVD players.

You may not be able to record additional material, edit, or format a disc after finalizing it, depending on the kind of the disc used.

	Overwrite	Edit	Format
DVD-R (VIDEO mode)	No	No	No
DVD-RW (VIDEO mode)	Yes*1	No	Yes*3
DVD-RW (VR mode)	Yes*2	Yes*2	Yes*3

*1 Unfinalizing is required.

*2 Unfinalizing is not required.

*3 Recorded data will be erased.

Table of contents

Read this first

What you can do with your DVD Handycam	4
What is the difference between DVD-R and DVD-RW?	6
How to prepare and use your DVD Handycam	8

Getting Started

Using this manual	12
Checking the supplied accessories	14
Step 1 Preparing the power source ..	15
Installing/removing the battery pack	15
Charging the installed battery pack	16
Showing the remaining battery time – BATTERY INFO	18
Connecting to a wall socket	18
Step 2 Turning on the power	19
Step 3 Adjusting the LCD screen and the viewfinder	20
Adjusting the angle and the brightness of the LCD screen	20
Adjusting the viewfinder	22
Step 4 Setting the date and time	23
Simple setting of the clock using a time difference	25
Step 5 Preparing a disc for recording ..	26

Shooting movies/still images

Before shooting	28
Shooting movies	29
Selecting the recording mode	32
Using the zoom feature	33
Shooting with the subject checking the image – Mirror mode	34
Shooting still images	35
Selecting the still image quality and size	38
Shooting images continuously (BURST, DCR-DVD201E only)	41
Adjusting the exposure	43
Adjusting the exposure for backlit subjects – BACK LIGHT	43
Adjusting the exposure manually	43
Shooting in the dark – NightShot plus, etc.	45
Using NightShot plus	45

Using Super NightShot plus	45
Using the NightShot Light	46
Using Color Slow Shutter	46
Self-timer recording	47
On shooting movies	47
On shooting still images	47
Shooting for the wide-screen TV – 16:9 Wide mode	48
Adjusting the white balance manually	50
Shooting techniques to match your circumstances – PROGRAM AE ...	51
Focusing manually	52
Shooting with special effects	53
Using fader (for movies only)	53
Using special effects – Picture effect/Digital effect ..	54
Checking/Deleting the last scene	55
Checking the last scene – Review	55
Deleting the last scene (DVD-RWs only)	55

Viewing the recordings

Playing a disc on your camcorder	56
Choosing and viewing a recording – Visual Index	56
Various playback modes	58
Displaying the indicators during playback – Display	59
Magnifying recorded images – PB ZOOM (Playback zoom)	61
Playing still images automatically – Slide Show	62
Viewing recordings on TV	63

Finalizing a disc for other players

Finalizing a disc	65
Changing the disc title	68
Playing back a disc on a DVD player, etc.	70
Playing back a disc on a computer with a DVD drive installed	71
Recording on a finalized disc – Unfinalizing (VIDEO mode DVD-RWs only)	73
Recording again on a used disc – Formatting (DVD-RWs only)	74

Using a disc in VR mode (DVD-RWs only)

Selecting the playing order on your camcorder – Playlist	76
Registering movies or still images in the Playlist	76
Converting all the still images on a disc to a movie file – Photomovie	79
Erasing unnecessary scenes from the Playlist	80
Changing the order within the Playlist	82
Dividing a movie within the Playlist	84
Playing the Playlist	86
Editing the original data	87
Dividing a movie	87
Deleting movies/still images	89

Viewing/duplicating discs/ editing the recordings on your computer (DCR-DVD101E/ DVD201E only)

Connecting your camcorder to your computer – Introduction	91
System requirements	91
Installing the USB driver	92
Installing software	93
Connecting your camcorder to the computer	94
Consulting the on-line help	98
Viewing scenes recorded on your computer	99
Viewing scenes on the disc	99
Making a disc copy – Disc Duplicating	101
Making a disc copy	101
Editing and saving scenes	102
Editing movies	102
Saving the movie on your computer	102
Creating an original disc	103
Making a menu	103
Editing the contents	104
Recording on a disc	105

Connecting your camcorder to a TV and a VCR

Dubbing a disc to a tape	106
Connecting your camcorder to a VCR	106
Dubbing to a tape	107
Dubbing a TV program or video tape onto a disc (DCR-DVD101E/ DVD201E only)	108
Connecting your camcorder to a TV or a VCR	108
Selecting the Video jack to be used on the TV or the VCR	108
Dubbing onto a disc	109

Customizing your camcorder

Changing the SETUP display	110
Selecting the option of each item ..	111

Troubleshooting

Types of trouble and corrective action	118
Self-diagnosis display	125
Warning indicators	126
Warning messages	127

Additional information

About the disc	129
About the “InfoLITHIUM” battery pack	130
Using your camcorder abroad	131
Maintenance information and precautions	132
Specifications	135

Parts and controls/Index

Identifying parts and controls	137
Index	145

Using this manual

The instructions in this manual are for the 3 models listed in the table below. Before you start reading this manual and operating your camcorder, check the model number by looking at the bottom of your camcorder. The DCR-DVD201E is the model used for illustration purposes. Otherwise, the model name is indicated in the illustrations. Any differences in operation are clearly indicated in the text, for example, “DCR-DVD201E only”.

Types of differences

Model (DCR-)	DVD91E	DVD101E	DVD201E
Image device	3.0 mm (1/6 type) CCD, gross approx. 800 000 pixels	3.0 mm (1/6 type) CCD, gross approx. 800 000 pixels	3.6 mm (1/5 type) CCD, gross approx. 1 070 000 pixels
AUDIO/VIDEO jack	OUT	IN/OUT	IN/OUT
USB jack	–	●	●

Note on TV color systems

TV color systems differ depending on the country or region. To view your recordings on a TV, you need an PAL system-based TV.

Copyright precautions

Television programs, films, video tapes, and other materials may be copyrighted. Unauthorized recording of such materials may be contrary to copyright laws. You cannot dub copyright protected software on your camcorder.

Contents of the recording cannot be compensated if recording or playback is not made due to a malfunction of the camcorder, storage media, etc.

Camcorder care

LCD display/viewfinder

The LCD display and the viewfinder are manufactured using extremely high-precision technology, so over 99.99 % of the pixels are operational for effective use. However, there may be some tiny black points and/or bright points (white, red, blue or green in color) that appear constantly on the LCD display and the viewfinder. These points are normal in the manufacturing process and do not affect the recording in any way.

Disc compatibility with other players

Discs recorded on your camcorder must be finalized to be played on other players. For details on how to finalize a disc, see “Finalizing a disc” (page 65).

Discs recorded in VIDEO mode

You must finalize a disc after all the recording is finished. You cannot record additional scene on a disc recorded in VIDEO mode once you finalize it. On DVD-RW, you can record additional scene by unfinalizing it.

Discs recorded in VR mode

Only DVD-RWs can be recorded in VR mode. Finalizing is required only when other DVD-RW compatible players cannot play the disc. You can record again with your camcorder on a finalized disc recorded in VR mode.

Compatible players: DVD players that can play back DVD-RWs in VR mode.

Note

You may not be able to play certain finalized discs, depending on the disc and the players.

Checking the supplied accessories

Make sure that the following accessories are supplied with your camcorder.

1



2

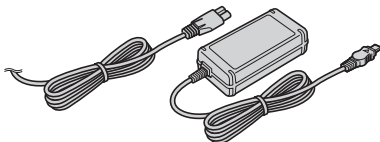

3

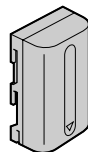

4

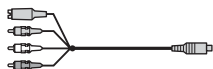

5

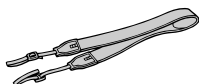

6

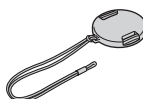

7

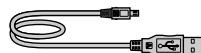

8

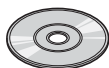

9

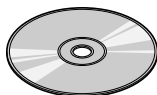

10

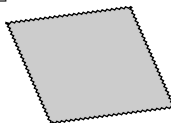

- 1 **Wireless Remote Commander** (1)
(page 142)
- 2 **AC-L15A/L15B AC adaptor** (1),
Mains lead (1) (page 16)
- 3 **NP-FM50 rechargeable battery pack**
(1) (page 15)
- 4 **A/V connecting cable** (1)

- 5 **Shoulder strap** (1)
- 6 **Lens cap** (1) (page 28)
- 7 **USB cable (Hi-SPEED USB compatible)**
(1) (page 92)
DCR-DVD101E/DVD201E only.
- 8 **DVD-R (DMR30)** (1)
- 9 **CD-ROM (SPVD-011 USB Driver)** (1)
DCR-DVD101E/DVD201E only.
- 10 **Cleaning cloth** (1)
- 11 **21-pin adaptor** (1)
For the models with **CE** mark printed on
their bottom surfaces only.

Step 1 Preparing the power source

Installing/removing the battery pack

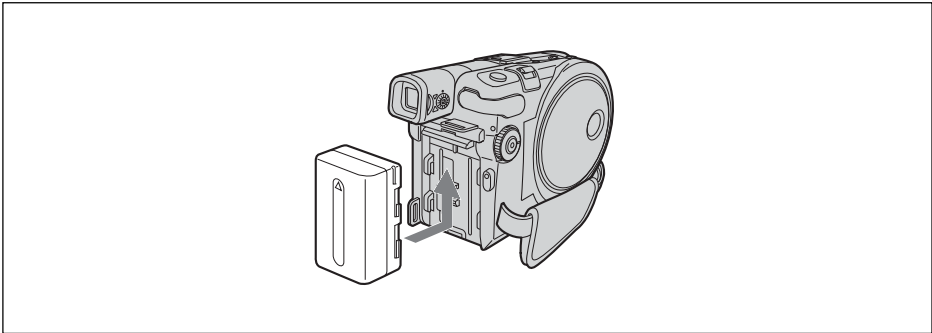

To install the battery pack, slide it in and up in the direction of the arrow until it clicks.

To remove the battery pack

- 1** Slide the battery pack in the direction of arrow while pressing the battery release button.
- 2** Slide the battery pack down.

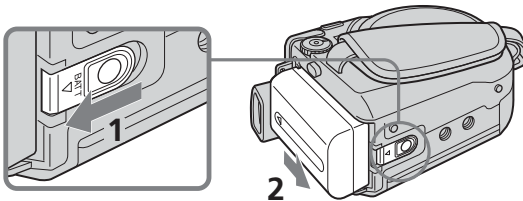

BATT release button

Step 1 Preparing the power source

Charging the installed battery pack

Your camcorder operates only with the "InfoLITHIUM" battery pack (M series).
See page 130 for more information on the "InfoLITHIUM" battery pack.

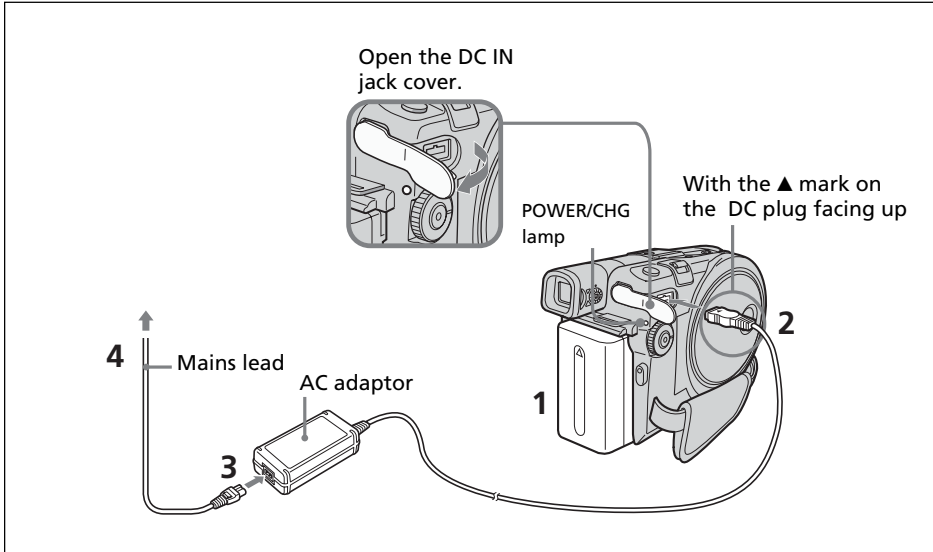

- 1 Make sure that the battery pack is installed on the camcorder.
- 2 Open the DC IN jack cover, then connect the AC adaptor supplied with your camcorder to the DC IN jack on your camcorder with the plug's ▲ mark facing up.
- 3 Connect the mains lead to the AC adaptor.
- 4 Connect the mains lead to the wall socket.
Charging begins. The POWER/CHG lamp lights in orange during the charge, then turns off when the charge is completed (full charge).

After charging the battery pack

Disconnect the AC adaptor from the DC IN jack on your camcorder.

Notes

- Prevent metallic objects from coming into contact with the metal parts of the DC plug of the AC adaptor. This may cause a short-circuit, damaging the AC adaptor.
- Place the AC adaptor near a wall socket. If any trouble occurs with this unit while using the AC adaptor, disconnect the plug from the wall socket as soon as possible to cut off the power.
- The POWER/CHG lamp may flash if the battery pack is not installed correctly or the battery pack is damaged.

Step 1 Preparing the power source

Charging time (full charge)*1

Battery pack	
NP-FM50 (supplied)	150
NP-QM71/QM71D	260
NP-QM91/QM91D	360

Recording time with the viewfinder*2

Battery pack	Continuous			Typical*3		
	DVD91E	DVD101E	DVD201E	DVD91E	DVD101E	DVD201E
NP-FM50 (supplied)	135	135	115	65	65	55
NP-QM71/QM71D	325	325	285	160	160	140
NP-QM91/QM91D	490	490	430	245	245	215

Recording time with the LCD display*2

LCD BACKLIGHT is set to ON

Battery pack	Continuous			Typical*3		
	DVD91E	DVD101E	DVD201E	DVD91E	DVD101E	DVD201E
NP-FM50 (supplied)	120	120	105	60	60	50
NP-QM71/QM71D	290	290	265	145	145	130
NP-QM91/QM91D	445	445	400	220	220	200

LCD BACKLIGHT is set to OFF

Battery pack	Continuous			Typical*3		
	DVD91E	DVD101E	DVD201E	DVD91E	DVD101E	DVD201E
NP-FM50 (supplied)	135	135	120	65	65	60
NP-QM71/QM71D	335	335	300	165	165	150
NP-QM91/QM91D	505	505	455	250	250	225

Playing time*2

Battery pack	Playing time on LCD screen			Playing time with LCD closed		
	DVD91E	DVD101E	DVD201E	DVD91E	DVD101E	DVD201E
NP-FM50 (supplied)	130	130	115	140	140	125
NP-QM71/QM71D	315	315	285	340	340	305
NP-QM91/QM91D	475	475	430	520	520	465

*1 Approximate number of minutes required at 25°C to charge an empty battery pack. The charging time may increase if the battery's temperature is extremely high or low because of the ambient temperature.

*2 Approximate number of minutes you can record when using a fully charged battery pack.

*3 Approximate number of minutes you can record, including starting/stopping, zooming, and turning the power on/off. The actual battery life may be shorter.

Notes

- If the power goes off even though the remaining battery time indicator indicates that the battery pack has enough power to operate, charge the battery pack fully again so that the indication on the remaining battery time indicator is correct.
- Battery pack performance decreases in low-temperature surroundings and recording may not be possible even though the battery time remaining may be as much as 20 minutes. Recharge the battery pack fully in this case.
- NP-FM30 is not recommended because of its short recording time when used with your camcorder.

Step 1 Preparing the power source

Showing the remaining battery time – BATTERY INFO

- 1 Open the LCD screen.
- 2 Press DISPLAY/BATT INFO.
The remaining battery time appears for a while on the LCD display.

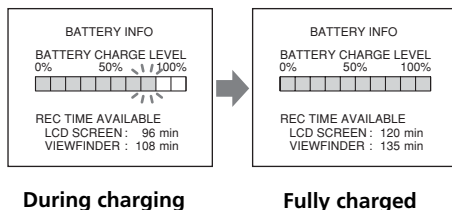

Notes

- BATTERY INFO does not appear when the power of the camcorder is ON.
- The remaining battery time may not be indicated in the following cases:
 - The battery pack is not installed correctly.
 - The battery pack is damaged.
 - The battery pack is empty.
- The number displayed as Battery Info is the approximate recording time.
- While the remaining battery time is being calculated, "CALCULATING BATTERY INFO..." is displayed.
- It may take some time to display the remaining battery time after DISPLAY/BATT INFO is pressed.

Connecting to a wall socket

When you use your camcorder for a long time, it is recommended that you power it from a wall socket using the AC adaptor.

- 1 Open the DC IN jack cover, then connect the AC adaptor supplied with your camcorder to the DC IN jack on your camcorder with the plug's ▲ mark facing up.
- 2 Connect the mains lead to the AC adaptor.
- 3 Connect the mains lead to a wall socket.
See page 16 for details.

Notes

- The AC adaptor can supply power even if the battery pack is attached to your camcorder.
- The DC IN jack has "source priority". This means that the battery pack cannot supply any power if the AC adaptor is connected to the DC IN jack, even when the mains lead is not plugged into a wall socket.
- Your camcorder is not disconnected from the AC power source (mains) as long as it is connected to the wall socket, even if your camcorder itself has been turned off.

Step 2 Turning on the power

Press the POWER button for a few seconds. Your camcorder turns on and the POWER/CHG lamp lights up in green. When you turn on your camcorder for the first time, the CLOCK SET display appears.

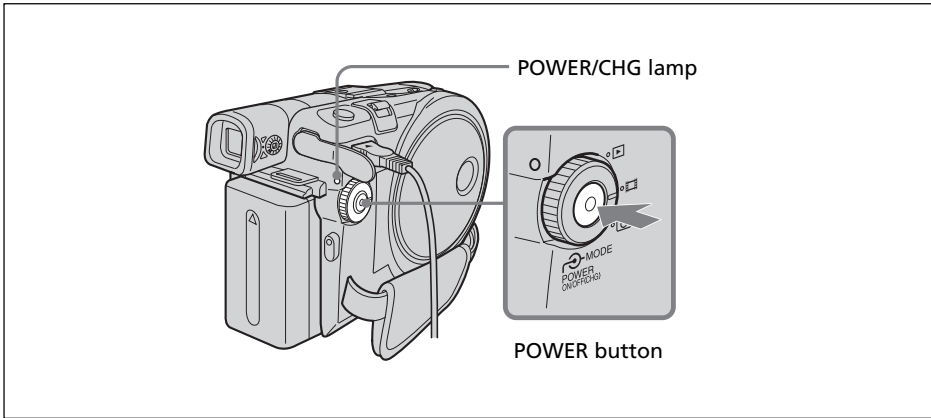



To turn the power off

Press the POWER button for a few seconds again. When the POWER/CHG lamp turns off, the power cuts off.

To set the mode dial

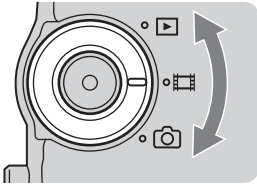
Rotate and set the mode dial to the operation you want to perform, such as shooting or playback.



 : Playback/edit

Select this when you play back or edit the recorded scenes on your camcorder.

 : Movies

Select this when you shoot the movies.

 : Still images

Select this when you shoot the still images.

Step 3 Adjusting the LCD screen and the viewfinder

Adjusting the angle and the brightness of the LCD screen

Adjust the brightness and the angle of the LCD screen properly in your sight.

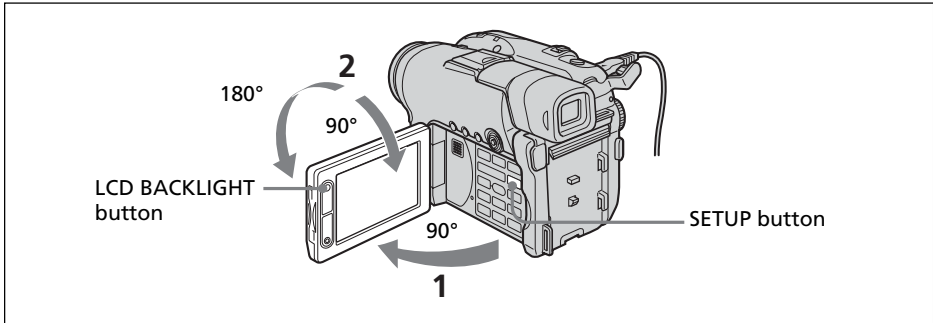

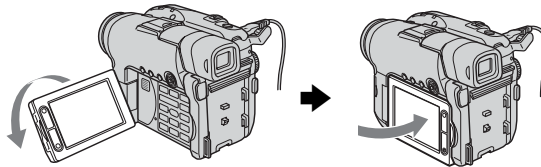

- 1 Open the LCD screen.
- 2 Adjust the direction of the LCD screen to the desired position.
When you adjust the angle of the LCD screen, make sure if the LCD screen is opened up to a full 90 degrees.
You can turn the LCD screen over and then fold it back to the camcorder body with the LCD screen facing out as shown below.

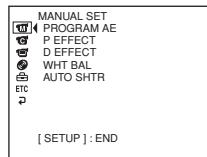

To adjust the brightness of the LCD display

- 1 Turn the power on by pressing the POWER button for a few seconds.
- 2 Press SETUP.
The SETUP display appears.



- 3 Use the multi-selector to select  (LCD/VF SET).
Refer to page 23 to see how to use the multi-selector.

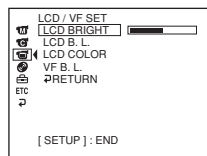

Step 3 Adjusting the LCD screen and the viewfinder

- 4 Use the multi-selector to select [LCD BRIGHT].

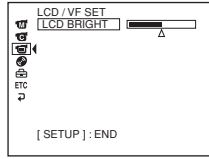



- 5 Use the multi-selector to adjust the brightness of the LCD display.
 – : Get Darker
 + : Get Brighter
 The LCD screen brightness is adjusted.
- 6 Press SETUP.
 The SETUP display disappears from the LCD display.

Note

[LCD B.L.] is set to [BRT NORMAL] when you close the LCD screen facing out.

Tips

- You can change the brightness of the backlight. Select  (LCD/VF SET) then [LCD B.L.] in the SETUP display when using the battery pack (page 113).
- The [LCD BRIGHT], [LCD B.L.] and [LCD COLOR] settings do not affect the brightness of the image when you are recording.
- The backlight of the LCD screen is set to ON normally. When you use the camcorder outdoors, set it to OFF so that the battery pack lasts longer.
- When you turn off the LCD back light, the  icon appears on the LCD display.

Step 3 Adjusting the LCD screen and the viewfinder

Adjusting the viewfinder

When recording pictures with the LCD screen closed, check the picture with the viewfinder. Adjust the viewfinder lens to accommodate your eyesight so that the image in the viewfinder comes into sharp focus.

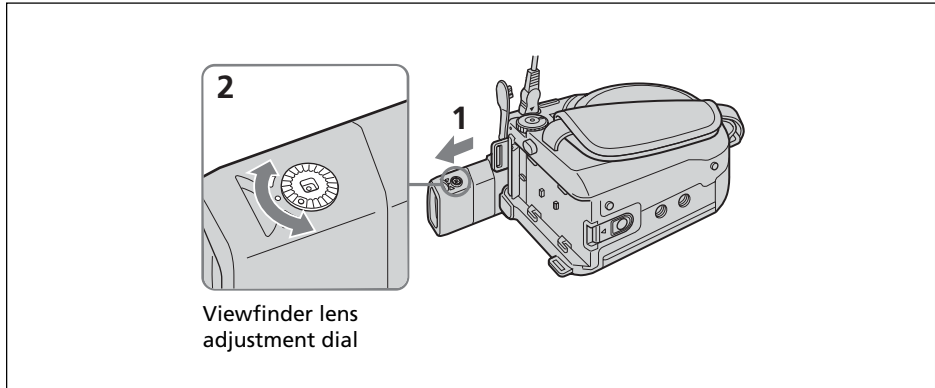

- 1** Extend the viewfinder.
- 2** Turn the viewfinder lens adjustment dial until you can see the characters in the viewfinder clearly.

Tips

- If you install a large capacity battery pack such as the NP-QM91/QM91D in your camcorder, extend the viewfinder and adjust the angle.
- You can change the brightness of the viewfinder backlight. Select [VF B.L.] in the SETUP display when using the battery pack (page 113).
- The [VF B.L.] setting does not affect the brightness of the image when you are recording.
- Recording pictures with the viewfinder is recommended in the following cases:
 - When the pictures on the LCD screen are hard to see.
 - When you want to save on battery consumption.

Step 4 Setting the date and time

Set the date and time when you use your camcorder for the first time. Set the geographical area, then daylight savings time ([DST]), the year, the month, the day, the hour and the minute, in that order. If you do not set the date and time, the [CLOCK SET] display appears whenever you turn on your camcorder or change the mode dial. If you do not use your camcorder for **about 3 months**, the date and time settings may be cleared from memory because the built-in rechargeable battery in your camcorder will have been discharged during that time. In that case, charge the built-in rechargeable battery by connecting the AC adaptor, and set the date and time again (page 16, 134).

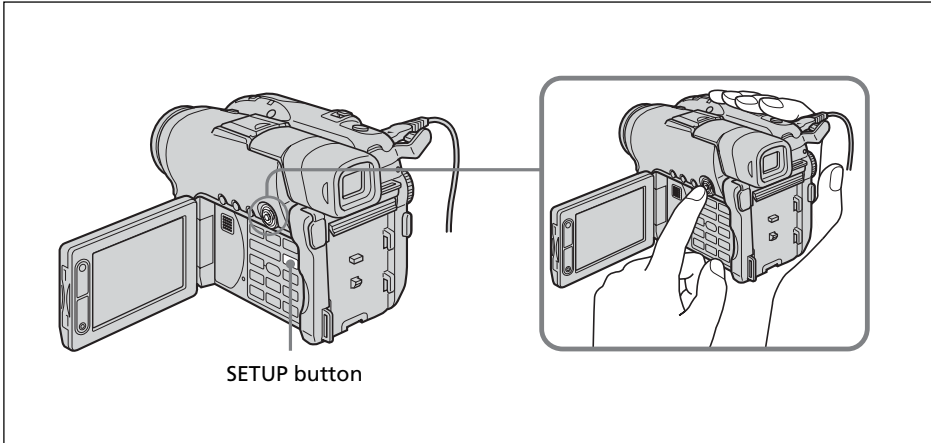

- 1 Open the LCD screen.
- 2 Turn the power on by pressing the POWER button for a few seconds. The CLOCK SET display appears.

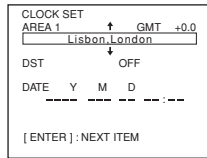

- 3 Use the multi-selector to select the desired geographical area.

Multi-selector

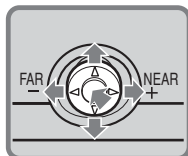

Select with ▼/▲/▶/◀ and press the button in the center to confirm your selection.

Step 4 Setting the date and time

Simple setting of the clock using a time difference

You can easily set the clock to the local time by setting the area. In the SETUP display use the multi-selector to select **ETC** (OTHERS) then **[AREA SET]** .

World time difference

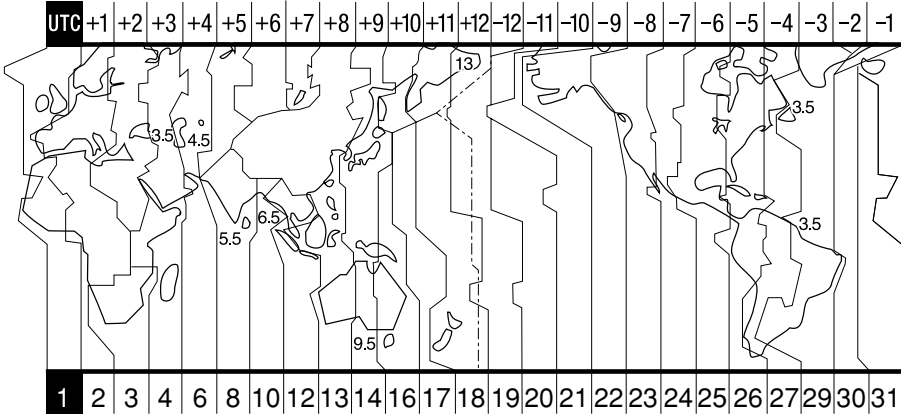

Getting Started

Area code	Time-zone differences	Area setting
1	GMT	Lisbon, London
2	+01:00	Berlin, Paris
3	+02:00	Helsinki, Cairo
4	+03:00	Moscow, Nairobi
5	+03:30	Tehran
6	+04:00	Abu Dhabi, Baku
7	+04:30	Kabul
8	+05:00	Karachi, Islamabad
9	+05:30	Calcutta, New Delhi
10	+06:00	Almaty, Dhaka
11	+06:30	Rangoon
12	+07:00	Bangkok, Jakarta
13	+08:00	HongKong, Singapore
14	+09:00	Seoul, Tokyo
15	+09:30	Adelaide, Darwin
16	+10:00	Melbourne, Sydney

Area code	Time-zone differences	Area setting
17	+11:00	Solomon Is.
18	+12:00	Fiji, Wellington
19	-12:00	Eniwetok, Kwajalein
20	-11:00	Midway Is., Samoa
21	-10:00	Hawaii
22	-09:00	Alaska
23	-08:00	LosAngeles, Tijuana
24	-07:00	Denver, Arizona
25	-06:00	Chicago, Mexico City
26	-05:00	New York, Bogota
27	-04:00	Santiago
28	-03:30	St. John's
29	-03:00	Brasilia, Montevideo
30	-02:00	Fernando de Noronha
31	-01:00	Azores

Step 5 Preparing a disc for recording



A new DVD-R or DVD-RW is required for recording. You cannot overwrite or delete data recorded on a DVD-R, but you can delete data and record again with a DVD-RW. The preparation procedure is different depending on the type of disc you use.

Notes

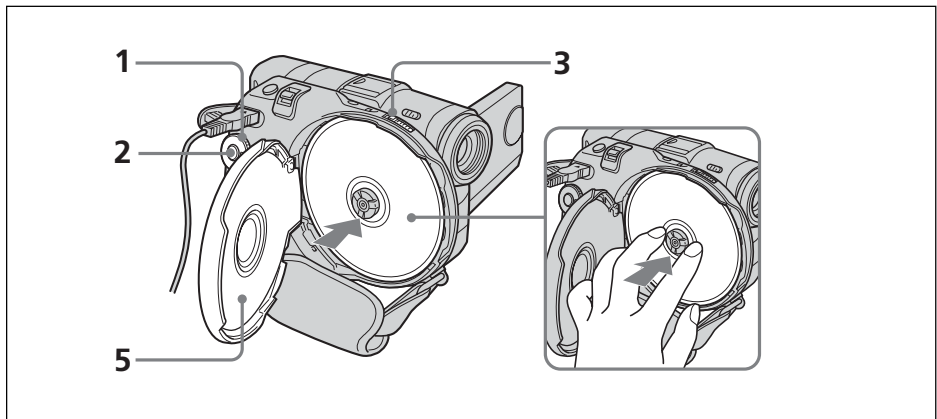
- When you insert or remove a disc, move the grip belt to the bottom of the camcorder so as not to obstruct the operation with your hand, etc.
- Do not apply shock or vibration to your camcorder while [DISC ACCESS] or [PREPARING TO OPEN COVER] is displayed on the LCD display.
- Formatting is required when a DVD-RW is used for the first time.



Make sure that the disc is not exposed to fingerprints and dust.

- 1** Set the mode dial to  (Movie) or  (Still).
- 2** Turn the power on by pressing the POWER button for a few seconds.
- 3** Slide the disc cover OPEN switch in the direction of the arrow mark. Opening melody rings once, then the camcorder beeps intermittently. [PREPARING TO OPEN COVER] appears on the LCD display. After the beeps stop, the disc cover opens slightly automatically. Open the cover completely.

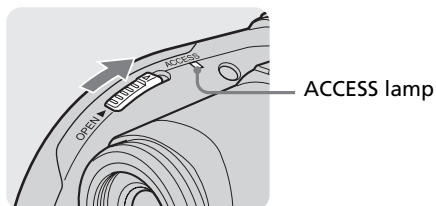

- 4** Set the disc with the label side facing out, then press the center of the disc until it clicks to seat it firmly on the center spindle.

Step 5 Preparing a disc for recording

5 Close the disc cover.

Your camcorder starts recognizing the inserted disc.

With a DVD-R, you can start recording immediately after [DISC ACCESS] disappears on the LCD display.

The FORMAT display appears when you insert a DVD-RW. Proceed to step 6.

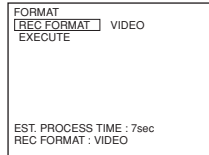

6 Use the multi-selector to select [REC FORMAT].

7 Use the multi-selector to select desired recording format.

Your camcorder is set in VIDEO mode as the default setting. Refer to page 7 about recording mode.

8 Use the multi-selector to select [EXECUTE].

9 Use the multi-selector to select [YES].

The selection of the recording format is completed.

The disc formatting starts. When the formatting is completed, you can start recording on the DVD-RW.

Notes

- It may take some time to recognize the disc depending on the disc type and condition.
- If you close the disc cover with the disc set incorrectly, it may cause your camcorder to malfunction.
- You may hear the motor running when the disc cover is closed without a disc being set. This is not a malfunction.
- Do not remove the battery pack or disconnect the AC adaptor while formatting.
- You can remove the disc when a power source is connected to your camcorder even when your camcorder is turned off. However, when you change the disc, the disc recognition process does not start automatically.

To remove the disc

It may take some time to remove the disc depending on the disc condition or recorded materials.

1 Perform the step 3 on page 26.

2 Remove the disc.

Tips

- When you replace a disc, disc information such as the date you started to use it and information on previously recorded areas appears for about 5 seconds. The information on previously recorded areas may not be displayed correctly depending on the condition of the disc.
- See page 129 for details on disc handling.

Before shooting

Note

To shoot movies/still images correctly, note the following:

- Hold your camcorder correctly.
- Do not shock or vibrate your camcorder during shooting.
- Do not scratch, put the fingerprint on, or get the disc dirty.

To hold your camcorder

Hold your camcorder with your fingers inserted through the grip belt.

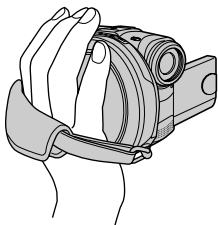

To fasten the grip belt

Fasten the grip belt firmly following the illustration below.

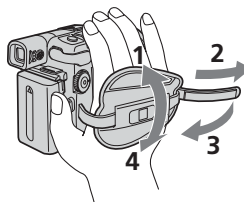

To attach the lens cap

Attach the lens cap to the metal fittings of the grip belt, as illustrated below, using the strap.

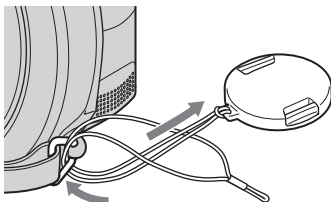

Note

Do not pick up your camcorder by the viewfinder, the LCD screen, or the battery pack.

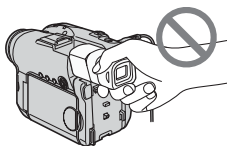

Viewfinder

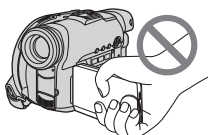

LCD screen

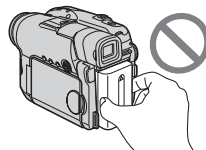

Battery pack

Shooting movies

Perform "Getting Started" from step 1 to 5 beforehand (page 15 to 27).
The following operation is common with VIDEO mode and VR mode.

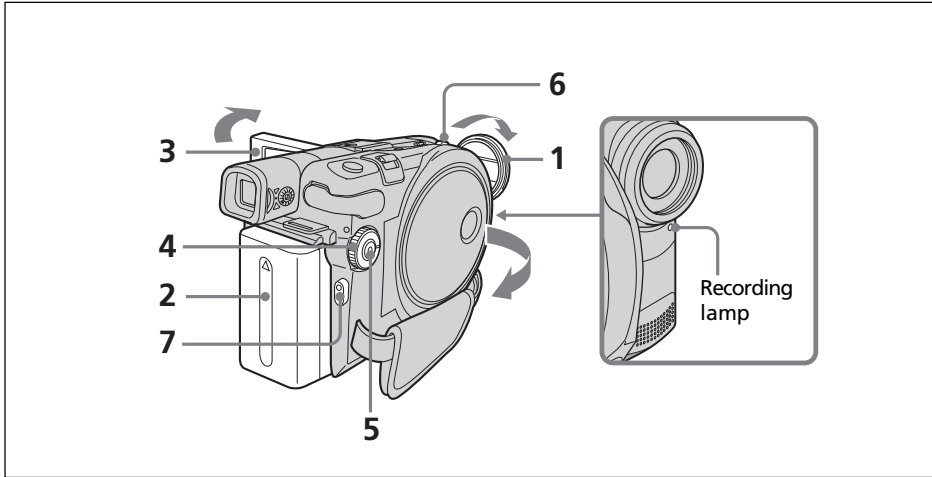

- 1** Remove the lens cap by pressing both knobs on the sides of the cap.

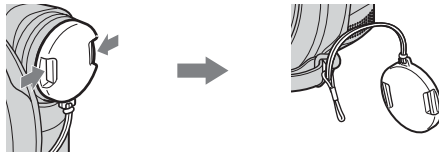

- 2** Install the battery pack or connect the AC adaptor (page 15).
- 3** Open the LCD screen.
The image is not displayed in the viewfinder when the LCD screen opens.
- 4** Set the mode dial to  (Movie).
- 5** Turn the power on by pressing the POWER button for a few seconds.
- 6** Insert a disc (page 26).
This sets your camcorder to standby.

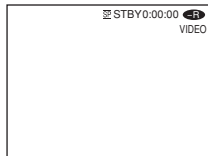

Shooting movies

7 Press START/STOP (●).

Your camcorder starts recording. [REC] appears on the LCD display. The camera recording lamp located on the front of your camcorder lights up. To stop recording, press START/STOP again.

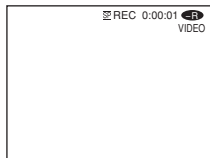

You can operate start/stop with the REC START/STOP button on the LCD screen. This is useful when you shoot movies from a low angle.

After recording

- 1 Remove the disc (page 27).
- 2 Turn the power off by pressing the POWER button for a few seconds again.
- 3 Close the LCD screen.
- 4 Remove the battery pack or disconnect the AC adaptor.

Notes

- Make sure that the lens cap strap is not caught into the disc cover when you insert or remove a disc.
- Do not touch the built-in microphone during recording.
- When the ACCESS lamp lights on, data is being recorded on the disc. Take note of the following when data is being recorded, or the data or the disc may be damaged.
 - Do not apply shock or shake the camcorder.
 - Do not turn the power off.
 - Do not remove the battery pack or disconnect the AC adaptor.
 - Do not open the disc cover.
- The writing time to the disc for recording may vary depending on the recording mode (page 32).
- There may be time difference between the point when you press START/STOP and the actual point that the recording starts/stops.
- Make sure the POWER/CHG lamp is off when you remove the power source.

Tip

If you leave your camcorder powered by the battery pack for 5 minutes, your camcorder automatically turns off. This is to save battery power and to prevent battery wear. Turn the power on again by pressing the POWER button for a few seconds. You can cancel the automatic power-off by setting the  (SETUP MENU) – [A. SHUT OFF] menu item to [NEVER] in the SETUP display.

Indicators displayed in the recording mode

These indicators are not recorded on discs.

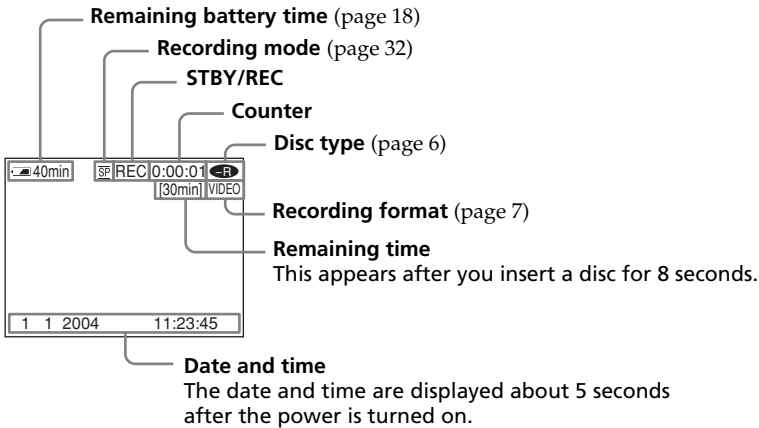

Notes

- The remaining battery time indicator shows the approximate continuous recording time remaining. The indicator may not be displayed accurately, depending on the conditions under which you are recording. When you close the LCD screen and open it again, it may take some time for the correct remaining battery time in minutes to be displayed.
- The recording data (date/time or various settings in effect when shooting) are not displayed while recording. However, they are recorded automatically onto the disc. To display the recording data, press DATA CODE on the Remote Commander during playback (page 59).

Selecting the recording mode

Your camcorder records in the HQ (high quality) mode, SP (standard play) mode, and the LP (long play) mode.

Your camcorder is set to SP mode as the default setting.

- 1 Set the mode dial to  (Movie).
- 2 Press SETUP.

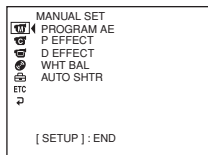

- 3 Use the multi-selector to select  (DISC SET).

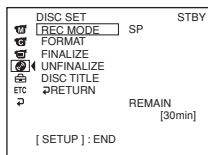

- 4 Use the multi-selector to select [REC MODE].

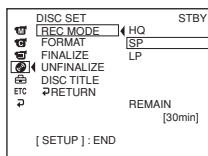

- 5 Use the multi-selector to select the desired recording mode.

Recording mode	Recording time*	Details
HQ	20 minutes	High quality
SP	30 minutes	Standard play
LP	60 minutes	Long play

- * •The numbers are for the reference.
 •The table shows approximate recording time and the above numbers apply to a single-sided disc, and it will be doubled for a double-sided disc.

- 6 Press SETUP.

The SETUP display disappears from the LCD display.

Notes

- You can record for a longer time in the LP mode, but the recording mode is degraded compared with the SP mode, and block noise may appear in scenes with quick movement.
- When you shoot an object that moves fast, the recording time may shorten.
- You cannot operate in the 16:9 Wide mode when you set the recording mode to [LP] in VIDEO mode.

Shooting movies

Using the zoom feature

Move the power zoom lever a little for a slower zoom. Move it further for a faster zoom. Using the zoom sparingly results in better-looking recordings.

W: For wide-angle (subject appears farther away)

T: For telephoto (subject appears closer)

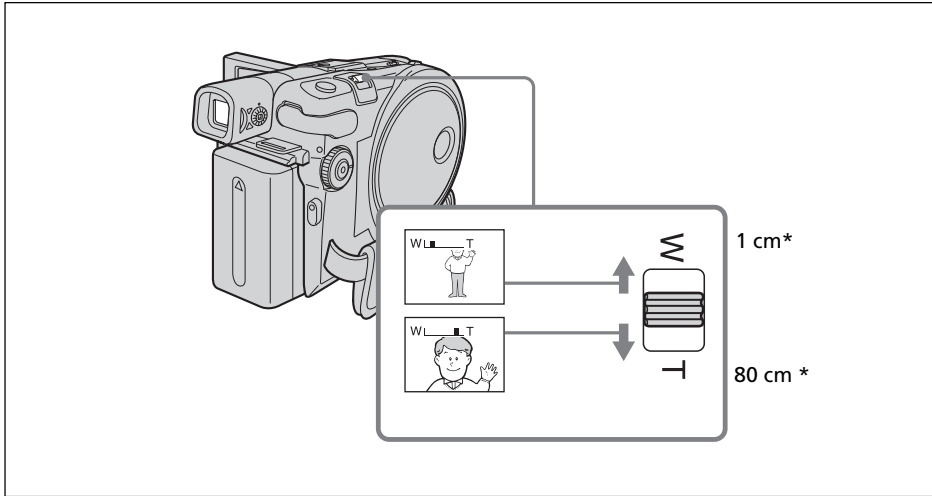

* The minimum distance required between your camcorder and the subject to get a sharp focus in that position of the lever.

To use zoom greater than 10 ×

Zoom greater than 10 × is performed digitally. Digital zoom can be set to 20 × or 120 ×. The picture quality deteriorates as you move the power zoom lever towards the “T” side.

To activate digital zoom, select the digital zoom power in  (CAMERA SET) – [D ZOOM] in the SETUP display (page 112). The digital zoom is set to [OFF] as the default setting.

The right side of the bar shows the digital zooming zone. The digital zooming zone appears when you select the digital zoom power in the SETUP display.

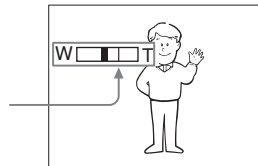

Tip

If you cannot get a sharp focus, move the power zoom lever to the “W” side until the focus is sharp.



Shooting movies

Shooting with the subject checking the image – Mirror mode

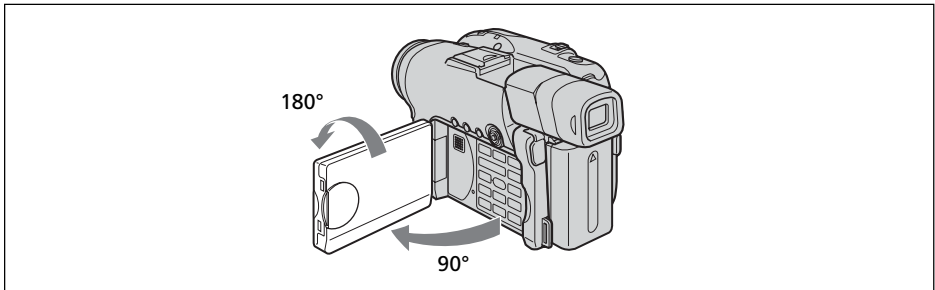
The picture on the LCD display is a mirror-image. However, the picture will be normal when recorded.



Open and rotate the LCD screen 180 degrees as shown above.

The ☺ indicator appears in the viewfinder and on the LCD display. When the mode dial is set to  (Movie),  appears in the standby mode, and  appears in the recording mode. Some indicators appear mirror-reversed and others are not displayed.

Shooting still images

Perform "Getting Started" from step 1 to 5 beforehand (page 15 to 27).
The following operation is common with VIDEO mode and VR mode.
You can record still images and movies on the same disc.

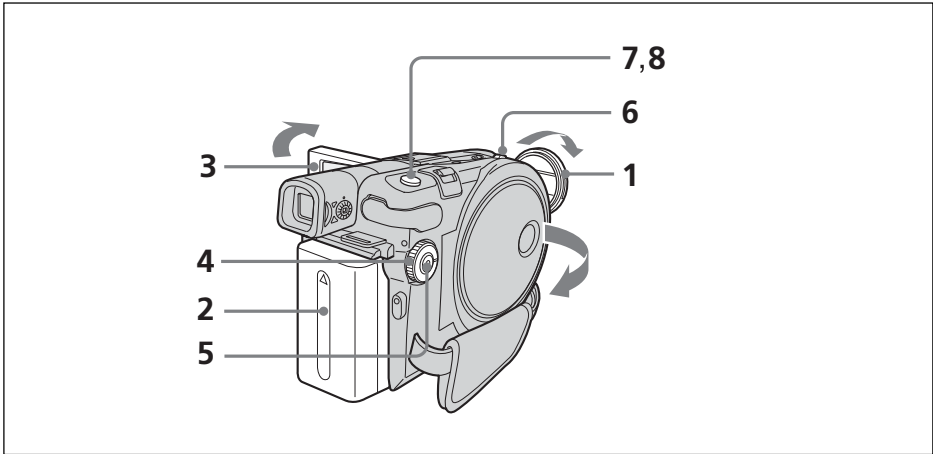

- 1** Remove the lens cap by pressing both knobs on the sides of the cap.

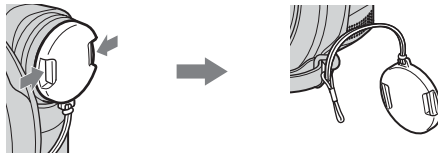

- 2** Install the battery pack or connect the AC adaptor (page 15).
- 3** Open the LCD screen.
The image is not displayed in the viewfinder when the LCD screen opens.
- 4** Set the mode dial to  (Still).
- 5** Turn the power on by pressing the POWER button for a few seconds.
- 6** Insert a disc (page 26).
This sets your camcorder to standby.

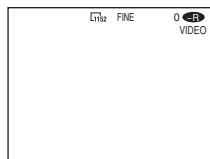

Shooting still images

- 7** Press and hold PHOTO down lightly, then check out the image.
When the AE/AF lock indicator (●) stops flashing and remains on, your camcorder is ready for shooting. The brightness of the image and focus are adjusted, are targeted for the middle of the image, and are set.

Number of recorded images

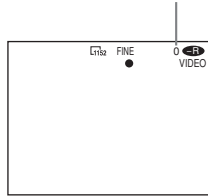

- 8** Press PHOTO all the way down.
[CAPTURE] appears after the shutter sounds. Recording is completed when the bar scroll indicator disappears.

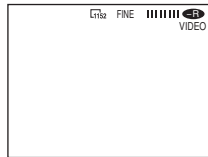

The image displayed when you pressed PHOTO all the way down in this step will be recorded.

When you press PHOTO of the Remote Commander, the image appearing on the LCD display at the moment is recorded.

Notes

- When the mode dial is set to  (Still), the following functions do not work.
 - 16:9 Wide mode
 - Digital zoom
 - SteadyShot
 - Super NightShot plus
 - Color Slow Shutter
 - Fader
 - Picture effect
 - Digital effect
 - The Sports lesson feature of [PROGRAM AE] (The indicator flashes.)
- When the ACCESS lamp lights on, data is being recorded on the disc. Take note of the following when data is being recorded, or the data and the disc may be damaged.
 - Do not shock or vibrate the camcorder.
 - Do not turn the power off.
 - Do not remove the battery pack or disconnect the AC adaptor.
 - Do not open the disc cover.
- When you press PHOTO lightly in step 7, the image momentarily flickers. This is not a malfunction.
- You can neither turn off the power nor press PHOTO while CAPTURE appears on the LCD display.
- The writing time to the disc for recording may vary depending on the still image size.



Tips

- The amount of recording data may vary depending on the settings for image quality and image size, and the type of images you are shooting.
- The recording data (date/time or various settings in effect when shooting) are not displayed while recording. However, they are recorded automatically onto the disc. To display the recording data, press DATA CODE on the Remote Commander during playback (page 59).
- The angle of view for still images is slightly wider compared with the angle of view of the movie (DCR-DVD201E only).
- If you leave your camcorder powered by battery for 5 minutes, your camcorder automatically turns off. This is to save battery power and to prevent battery wear. Turn the power on again by pressing the POWER button for a few seconds. You can cancel the automatic power-off by setting the  (SETUP MENU) – [A.SHUT OFF] menu item to [NEVER] in the SETUP display.
- The image size is not displayed with DCR-DVD91E/DVD101E.

Selecting the still image quality and size

To select the still image quality

You can select the image quality from [FINE] or [STANDARD] for still image recording. The default setting is [FINE].

- 1 Set the mode dial to  (Still).
- 2 Press SETUP.
- 3 Use the multi-selector to select  (CAMERA SET).

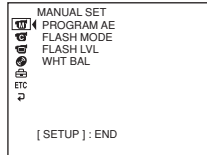

- 4 Use the multi-selector to select [QUALITY].

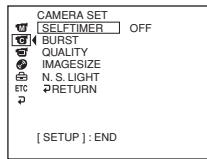

- 5 Use the multi-selector to select the desired image quality.
The amount of recording data varies depending on the settings for image quality.

Image quality settings

FINE (FINE):

Use this mode when you want to record high quality images. The images are compressed to about 1/4.

STANDARD (STD):

This is the standard image quality level for your camcorder. The images are compressed to about 1/10.

- 6 Press SETUP.
The SETUP display disappears from the LCD display.

Shooting still images

To select the still image size (DCR-DVD201E only)

You can select either of 2 image sizes, 1152 × 864 or 640 × 480.
The default setting is 1152 × 864.

1 Set the mode dial to  (Still).

2 Press SETUP.

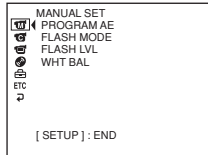

3 Use the multi-selector to select  (CAMERA SET).

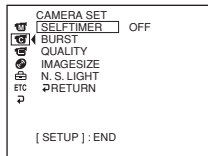

4 Use the multi-selector to select [IMAGESIZE].

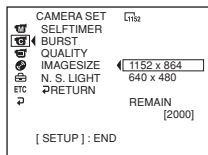

5 Use the multi-selector to select the desired image size.
The indicator changes as follows:



6 Press SETUP
The SETUP display disappears from the LCD display.

Tip

The image size is 640 × 480 for DCR-DVD91E/DVD101E.

Shooting still images

Number of still images recordable on a disc

Your camcorder compresses image data in JPEG format (extension .jpg).

Default image data file name is as following:

- 100-0001: This file name appears on the LCD display of your camcorder.
- DSC00001.jpg: This file name appears on the display of your personal computer.

Number may vary depending on the settings of the image quality, the image size and the type of images you are shooting.

Image quality	Image size	Recordable number*2		
		DVD-RW VIDEO	VR	DVD-R VIDEO
FINE	1152 × 864*1	2 250	2 250	2 150
	640 × 480	5 400	5 400	5 100
STANDARD	1152 × 864*1	4 300	4 350	4 100
	640 × 480	8 600	8 600	8 100

*1 DCR-DVD201E only.

*2 The table shows approximate recordable number and the above numbers apply to a single-sided disc, and it will be doubled for a double-sided disc.

File size of still images

Image quality	File size	
	640 × 480	1152 × 864*1
FINE	150 KB	500 KB
STANDARD	60 KB	200 KB

The table shows approximate file size.

*1 DCR-DVD201E only.

Shooting still images

Shooting images continuously (BURST, DCR-DVD201E only)

You can record still images continuously by setting [BURST].

NORMAL

Your camcorder shoots up to 4 still images in 1152 × 864 size or 12 still images in 640 × 480 size at about 0.7 sec intervals.

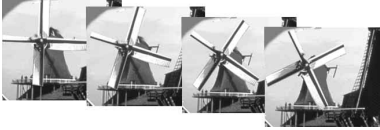

EXP BRKTG (Exposure bracketing)

Your camcorder automatically shoots 3 images at about 0.7 sec intervals at different exposures.



1 Set the mode dial to  (Still).

2 Press SETUP.

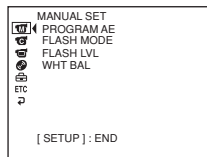

3 Use the multi-selector to select  (CAMERA SET).

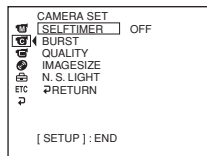

Shooting still images

- 4 Use the multi-selector to select [BURST].

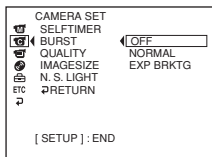

- 5 Use the multi-selector to select [NORMAL] or [EXP BRKTG].

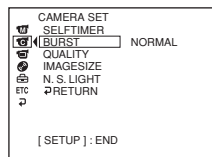

- 6 Press SETUP.

The SETUP display disappears from the LCD display.

- 7 Press PHOTO all the way down.

Images are recorded continuously as the settings specified above.

In the [NORMAL] settings, images are recorded continuously to the maximum number while pressing PHOTO.

Notes

- You may not be able to record continuous images up to the maximum number depending on the image size and the remaining capacity of the disc.
- The flash unit (optional) is disabled during continuous shooting.
- It takes longer to record continuous images to the disc compared to normal shooting. Shoot the next still image after the scroll bar indicator and the ACCESS lamp turns off.

Tips



- Shooting with the self-timer or the Remote Commander, images are automatically recorded up to the maximum number possible.
- The effect of exposure bracketing may be difficult to recognize on the LCD display. It is recommended that you connect your camcorder to a TV or a computer to see its effect.

Adjusting the exposure

Adjusting the exposure for backlit subjects – BACK LIGHT

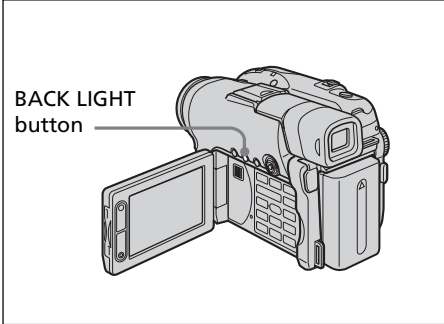
When you shoot a subject with the light source behind the subject or a subject with a light background, use the backlight.



- 1 Set the mode dial to  (Movie) or  (Still).
- 2 Press BACK LIGHT.
The  indicator appears on the LCD display.

To cancel BACK LIGHT

Press BACK LIGHT again.

Note



If you press EXPOSURE when shooting with BACK LIGHT, the backlight will be canceled.

Adjusting the exposure manually

Adjust the exposure manually in the following cases:

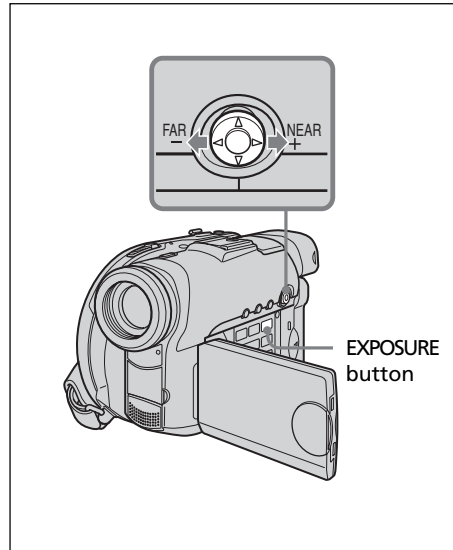
- when you need a fine adjustment for subjects against the light.
- when the subject is too bright against the background.
- when recording dark pictures (e.g. night scenes).



- 1 Set the mode dial to  (Movie) or  (Still).
- 2 Press EXPOSURE.
The exposure indicator appears.

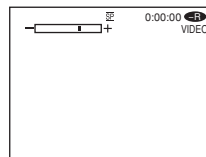

Adjusting the exposure

- 3** Use the multi-selector to adjust the brightness shown as below.
- : Get Darker
 - + : Get Brighter

To return to the automatic exposure

Press EXPOSURE again.

Notes

- When you adjust the exposure manually, the following functions do not work:
 - Color Slow Shutter
 - BACK LIGHT
- Your camcorder automatically returns to the automatic exposure setting:
 - if you change the PROGRAM AE effect.
 - if you slide the NIGHTSHOT PLUS switch to ON, while adjusting the exposure manually.

Shooting in the dark – NightShot plus, etc.

The functions using infrared rays, such as NightShot plus and Super NightShot plus, or Color Slow Shutter are useful when you shoot a subject at night or in a dark place. NightShot plus and Super NightShot plus enable you to shoot bright movies, and Color Slow Shutter enables you to shoot movies in realistic color.

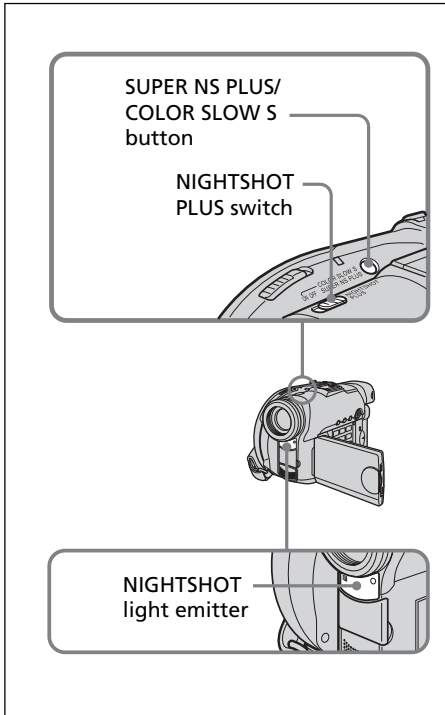

Using NightShot plus

- 1 Set the mode dial to (Movie) or (Still).
- 2 Slide the NIGHTSHOT PLUS switch to ON. The and ["NIGHTSHOT PLUS"] indicators flash on the LCD display.

To cancel the NightShot plus

Slide the NIGHTSHOT PLUS switch to OFF.

Notes

- Do not use the NightShot plus mode in bright places (e.g. outdoors in the daytime). This may cause your camcorder to malfunction.
- If focusing is difficult with the autofocus mode when using NightShot plus, focus manually.
- While recording using the NightShot Light, do not obstruct the Infrared rays (NightShot Light) emitter with your finger.
- While using NightShot plus, you cannot use the following functions:
 - Exposure
 - PROGRAM AE (The indicator flashes)
 - White balance

Using Super NightShot plus

The Super NightShot plus makes subjects more than 16 times brighter than those recorded in the NightShot plus.

- 1 Set the mode dial to (Movie).
- 2 Slide the NIGHTSHOT PLUS switch to ON.
- 3 Press SUPER NS PLUS. The and ["SUPER NIGHTSHOT PLUS"] indicators flash on the LCD display.

To cancel Super NightShot plus

Press SUPER NS PLUS again.

Notes

- You cannot use Super NightShot plus to record still images.
- While using Super NightShot plus, the shutter speed is automatically adjusted depending on the brightness. At this time, the motion of the picture may slow down.
- While using Super NightShot plus, you cannot use the following functions:
 - Fader
 - Exposure
 - Digital effect
 - PROGRAM AE
 - White balance

Shooting in the dark – NightShot plus, etc.

Using the NightShot Light

The picture will be clearer with the NightShot Light on.

NightShot Light rays are infrared and so are invisible. The maximum shooting distance using the NightShot Light is about 3 m.



To enable the NightShot Light, set  (CAMERA SET) – [N.S.LIGHT] to [ON] in the SETUP display.

The default setting is [ON].

Using Color Slow Shutter

Color Slow Shutter enables you to record color images in a dark place.

Color Slow Shutter may not work normally in total darkness.

- 1 Set the mode dial to  (Movie).
- 2 Slide the NIGHTSHOT PLUS switch to OFF.
- 3 Press COLOR SLOW S.
The  and [COLOR SLOW SHUTTER] indicators flash on the LCD display.

To cancel Color Slow Shutter

Press COLOR SLOW S again to make the  indicator disappear.

Notes

- You cannot use Color Slow Shutter to record still images.
- While using Color Slow Shutter, the shutter speed is automatically adjusted depending on the brightness. At this time, the motion of the picture may slow down.
- While using Color Slow Shutter, you cannot use the following functions:
 - Fader
 - Exposure
 - Digital effect
 - PROGRAM AE

Self-timer recording

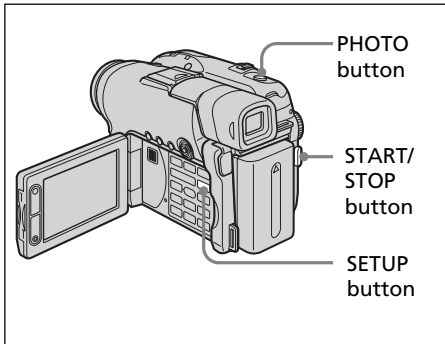

On shooting movies

- 1 Set the mode dial to (Movie).
- 2 Press SETUP.
- 3 Use the multi-selector to select (CAMERA SET).
- 4 Use the multi-selector to select [SELFTIMER].

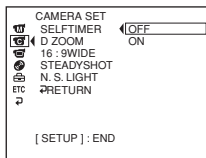

- 5 Use the multi-selector to select [ON].
- 6 Press SETUP.
The SETUP display disappears from the LCD display and the (self-timer) indicator appears.
- 7 Press START/STOP.
Self-timer starts counting down with a beep. In the last 2 seconds of the countdown, the beep gets faster, then recording starts automatically 10 seconds after pressing START/STOP.

On shooting still images

- 1 Set the mode dial to (Still), then perform Steps 2 to 6.
- 2 Press PHOTO all the way down.
Self-timer starts counting down with a beep. In the last 2 seconds of the countdown, the beep gets faster, then recording starts automatically 10 seconds after pressing PHOTO.

To cancel self-timer

Set (CAMERA SET) – [SELFTIMER] to [OFF] in the SETUP display during the standby.

Notes

- When the self-timer recording is finished, the self-timer is automatically cancelled.
- You can set self-timer during the standby only.
- You cannot stop the count-down on shooting still images by pressing PHOTO.

Tip

To stop the countdown when you shooting a movie, press START/STOP.
To restart the countdown, press START/STOP again.

Shooting for the wide-screen TV

– 16:9 Wide mode

You can record a 16:9 Wide picture to watch on a 16:9 wide-screen TV (16:9WIDE). Black bands appear on the LCD display during recording in 16:9 Wide mode **[a]**. The picture during playback on a normal TV **[b]** or on a wide-screen TV **[c]** is compressed in the longwise direction. If you set the screen mode of the wide-screen TV to the full mode, you can watch pictures of normal images **[d]**. Refer to the operating instructions of your TV for further information.

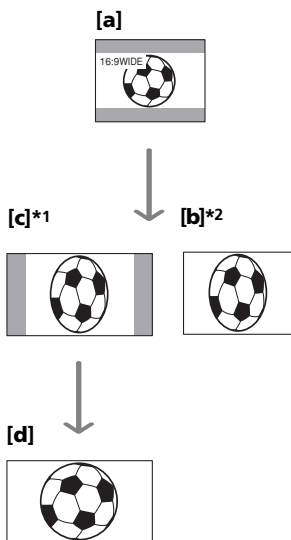

*1 When 16:9 Wide mode switches to full mode, the picture appears on the TV screen at the right ratio.

*2 When you play back in ordinary TV (4:3 mode), the picture may be compressed. When you play back in 16:9 Wide mode, the picture appears as you see it on the LCD display or in the viewfinder.

1 Set the mode dial to (Movie).

2 Press **SETUP**.

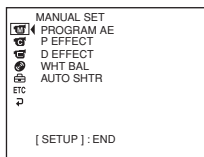

3 Use the multi-selector to select (CAMERA SET).

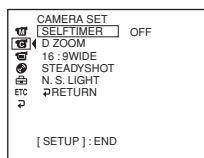

4 Use the multi-selector to select [16:9WIDE].

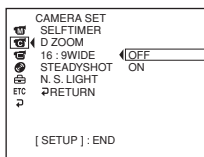

5 Use the multi-selector to select [ON].

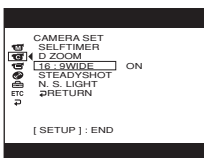

6 Press **SETUP**.

The **SETUP** display disappears from the LCD display.

To cancel the 16:9 Wide mode

Set [16:9WIDE] to [OFF] in step 5.

Shooting for the wide-screen TV – 16:9 Wide mode



Notes

- You cannot select [OLD MOVIE] (page 54) during recording in the 16:9 Wide mode.
- When you select VIDEO mode, setting the recording mode to [LP] cancels the 16:9 Wide mode.
- You cannot change a movie recorded in the 16:9 Wide mode to the normal aspect.

Adjusting the white balance manually

Normally white balance is adjusted automatically. Adjust manually in the following cases:

- When shooting in a place that the light condition changes often such as a party hall.
- When shooting a night scene and a neon sign.

1 Set the mode dial to  (Movie) or  (Still).

2 Press SETUP.

3 Use the multi-selector to select  (MANUAL SET).

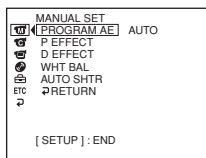

4 Use the multi-selector to select [WHT BAL].

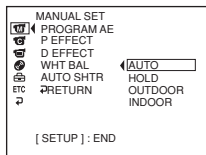

5 Select the desired white balance with the multi-selector.

HOLD :

When recording a single-colored subject or background

(OUTDOOR) :

- When recording a sunset/sunrise, just after sunset, just before sunrise
- When recording a neon signs, or fireworks
- Under a color-matching fluorescent lamp

(INDOOR) :

- Where the lighting condition changes quickly
- When recording in TV lighting in a studio
- Under sodium lamps or mercury lamps

6 Press SETUP.

The SETUP display disappears from the LCD display.

To return to the automatic white balance mode

Set  (MANUAL SET) – [WHT BAL] to [AUTO] in the SETUP display.

Notes

- In the [HOLD] white balance, set the white balance to [AUTO] and reset it to [HOLD] after a few seconds:
 - when you change the [PROGRAM AE] setting.
 - when you take your camcorder outdoors from inside a house, or vice versa.
- If you remove the power source longer than 5 minutes, the white balance returns to [AUTO] automatically.

Tips

- If the picture is being taken in a studio lit with a video light (optional), it is recommended that you record using [INDOOR].
- When you record under fluorescent lighting, use the [AUTO] or [HOLD]. Your camcorder may not adjust the white balance correctly when you use [INDOOR].
- In the automatic white balance mode, point your camcorder at a white subject for about 10 seconds after turning the power on to get a better adjustment:
 - after you replace the battery pack.
 - when you take your camcorder outdoors from inside a house while holding the exposure, or vice versa.
- When you slide the NIGHTSHOT PLUS switch to ON, white balance returns to [AUTO].

Shooting techniques to match your circumstances – PROGRAM AE

SPOTLIGHT*1

This effect prevents people's faces, for example, from appearing excessively white when shooting subjects lit by strong light.

PORTRAIT (soft portrait)

This effect brings out the subject while creating a soft background for subjects such as people or flowers.

SPORTS (sports lesson)*1

This effect minimizes camera-shake on fast-moving subjects such as in tennis or golf.

BEACH&SKI*1

This effect prevents people's faces from appearing dark in strong light or reflected light, such as at a beach in midsummer or on a ski slope.

SUNSETMOON (sunset & moon)*2

This effect allows you to maintain atmosphere when you are recording sunsets, general night views, fireworks displays and neon signs.



LANDSCAPE*2

This effect is for when you are recording distant subjects such as mountains, and prevents your camcorder from focusing on glass or metal mesh in windows when you are recording a subject behind glass or a screen.



*1 Your camcorder focuses only on subjects in the middle to far distance.

*2 Your camcorder focuses only on distant subject.

- 1 Set the mode dial to  (Movie) or  (Still).
- 2 Press SETUP.
- 3 Use the multi-selector to select  (MANUAL SET).
- 4 Use the multi-selector to select [PROGRAM AE].

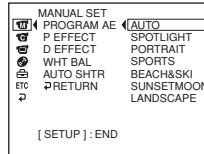

- 5 Use the multi-selector to select the desired effect.

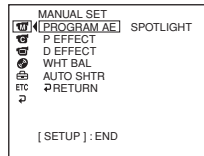

- 6 Press SETUP.
The SETUP display disappears from the LCD display.

To cancel PROGRAM AE

Set [PROGRAM AE] to [AUTO] in step 5.

Notes

- The following functions do not work with PROGRAM AE:
 - Color Slow Shutter
 - OLD MOVIE
- When NIGHTSHOT PLUS switch is set to ON, PROGRAM AE does not work. (The indicator flashes.)
- You cannot use [SPORTS] to record still images. (The indicator flashes.)

Focusing manually

You can adjust the focus manually according to the recording conditions.

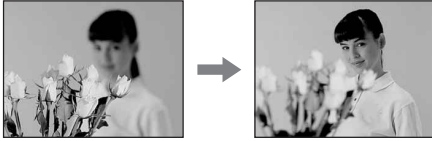

Use this function in the following cases.

- To record a subject behind a window covered with raindrops.
- To record horizontal stripes.
- To record a subject with little contrast between the subject and its background.
- When you want to focus on a subject in the background.

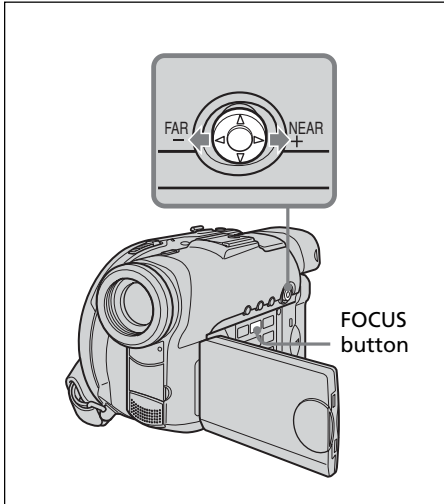

- To record a stationary subject using a tripod.



1 Set the mode dial to  (Movie) or  (Still).

2 Press FOCUS.

The  (manual focus) indicator appears.

3 Check the viewfinder or the LCD display and use the multi-selector to adjust the focus.

To return to the autofocus



Press FOCUS again.

To record distant subjects

Turn the dial to FAR until the  indicator appears.

The focus is fixed at the most distant position.

Tips

- It is easier to focus on subjects if you adjust the zoom to shoot at the “W” (wide-angle) position after adjusting the focus at the “T” (telephoto) position.
- When you shoot close to the subject, focus at the end of the “W” (wide-angle) position.
-  changes as follows:
 -  when recording a distant subject.
 -  when the subject is too close to focus on.

Shooting with special effects

Using fader (for movies only)

You can fade in or out to give your movie a more professional appearance.

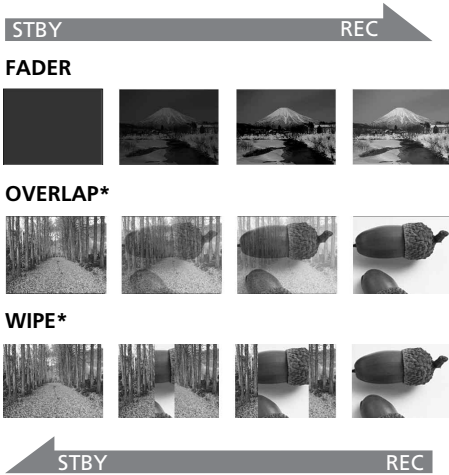

* Fade in only

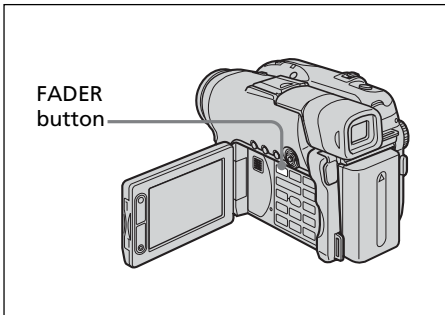

1 Set the mode dial to  (Movie).

2 When fading in

In the standby mode, press the FADER button until the desired fader indicator appears.

When fading out

In the recording mode, press FADER.

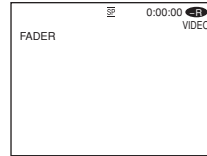

The indicator changes as follows:



The last selected fader mode is indicated first.

3 Press START/STOP.

The fader indicator stops flashing, then remains lit.

After fade in/out ends, the fader indicator disappears.

To cancel fader

In step 2, press FADER until the indicator disappears.

Notes

- You cannot use the following functions while using fader. Also you cannot use fader while using following function.
 - Digital effect
 - Super NightShot plus
 - Color Slow Shutter
- When the OVERLAP or WIPE indicator appears in the standby mode, your camcorder automatically stores the image recorded on a disc. While the image is being stored, the indicators flash fast, and the playback picture disappears temporarily.

Shooting with special effects

Using special effects – Picture effect/Digital effect

You can digitally process movies to obtain special effects like those in films or on TV.

Picture effect

- SEPIA:** The picture appears in sepia.
- B&W:** The picture appears in monochrome (black-and-white).
- PASTEL:** The picture appears like a pale pastel drawing.
- MOSAIC:** The picture appears mosaic-patterned.

PASTEL



MOSAIC



Digital effect

LUMI. (Luminance key):
You can swap a brighter area in a still image with a moving picture.



OLD MOVIE:

You can add an old movie-type atmosphere to pictures. Your camcorder automatically records pictures in the letterbox mode for all screen size, sepia in color, and at a slower shutter speed.

- 1 Set the mode dial to (Movie).
- 2 Press SETUP.

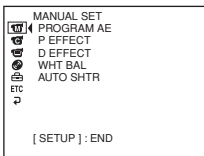

- 3 Use the multi-selector to select (MANUAL SET).

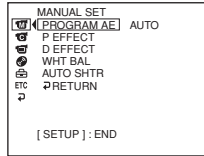

- 4 Use the multi-selector to select [P EFFECT] or [D EFFECT].

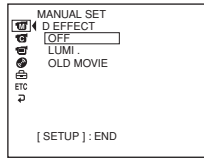

- 5 Use the multi-selector to select the desired effect.

In the [LUMI.] mode, the still image displayed when the multi-selector is pressed is recorded in the memory. Adjust the degree of the still image swapped by a movie with ◀ (reduce the degree)/▶ (increase the degree).

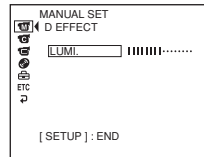

Bars: Displayed in LUMI. only.

- 6 Press SETUP.

The SETUP display disappears from the LCD display.

To cancel effect

Set [P EFFECT] or [D EFFECT] to [OFF] in step 5.

Notes

- The following functions do not work during digital effect:
 - Fader
 - Super NightShot plus
 - Color Slow Shutter
- While using picture effect, you cannot select OLD MOVIE.
- The following functions do not work in OLD MOVIE:
 - 16:9 Wide mode
 - Picture effect
 - PROGRAM AE

Checking/Deleting the last scene

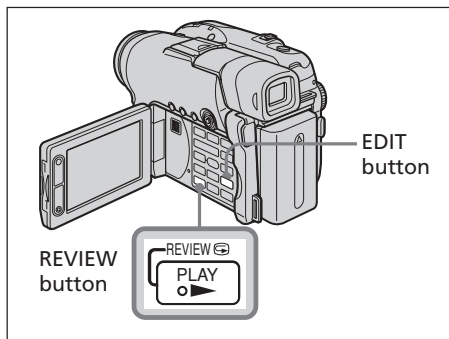

Checking the last scene – Review

You can check the last recorded scene quickly.

- 1 Set the mode dial to (Movie) or (Still).
 - 2 Press REVIEW .
- The playback of the latest scene starts.

To return to recording

Press REVIEW again.

Note

The recording data (DATA CODE) does not appear on the Review display.

Tip

When reviewing still images recorded continuously (BURST, DCR-DVD201E only), you can forward/backward the images with / .

Deleting the last scene (DVD-RWs only)

If the checked scene is unnecessary, you can delete it on the spot.

- 1 Press EDIT during the review.
A deletion confirmation display appears.



- 2 Select [EXEC.] with the multi-selector.
The latest scene is deleted.

To cancel the deletion

Select [RET.] in step 2.

Notes

- You can delete the latest scene only when it has been recorded on a DVD-RW. Data once recorded on DVD-Rs cannot be deleted.
- You can delete the scene which was recorded just before the operation. When you recorded in VR mode, you can delete any scenes. See “Deleting movies/still images” on page 89.
- When you delete the still images recorded continuously (BURST, DCR-DVD201E only), all the images are deleted at same time. You can delete a specific still image when you record in VR mode. See “Deleting movies/still images” on page 89.
- You cannot delete the last scene:
 - if you have moved the mode dial.
 - if you have turned the power off.
 - if you have ejected the disc.

Playing a disc on your camcorder

Choosing and viewing a recording – Visual Index

The recorded scenes are displayed as a list in the Visual Index display. You can find the desired scene quickly using this convenient index. If you close the LCD screen, you can monitor the playback picture in the viewfinder. You can control playback using the Remote Commander supplied with your camcorder.

Remove the insulation sheet to activate the Remote Commander (page 143).

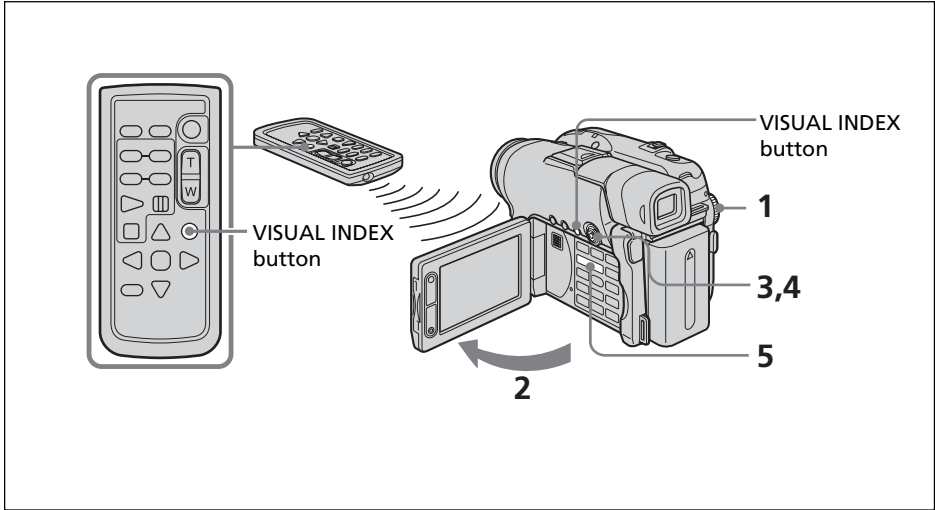



1 Set the mode dial to  (Play/Edit).

2 Open the LCD screen.

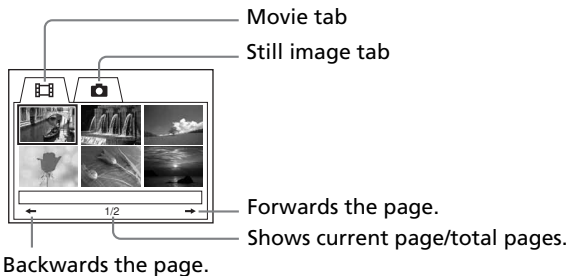
The Visual Index display appears.



Playing a disc on your camcorder

- 3** Select the  (Movie) tab or the  (Still) tab with the multi-selector according to the kind of scene you want to play back.
The thumbnail list screen appears.

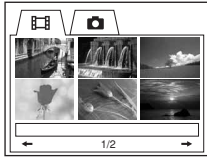

- 4** Use the multi-selector to select the desired scenes.
When you select a movie, playback starts and continues until the last scene of the movie. When you select a still image, the image appears in full screen mode.

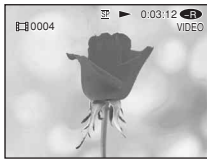

- 5** Adjust the volume when a movie is played back by pressing either +/- on VOL. The sound is muted when the LCD screen is closed.

Tip



When the Visual Index display does not appear in step 2, press VISUAL INDEX.

To return to the Visual Index display

Press VISUAL INDEX again.

To stop playback

Press .

Pressing  starts playback from the point which  was pressed.

Playing a disc on your camcorder

Various playback modes

Movies

The sound is muted in the various playback modes.

To pause playback (view a still image)

Press **II** during playback. To resume normal playback, press **II** again.

To advance the scene

Press **▶▶▶** during playback.

To return to the beginning of the scene

Press **◀◀◀** during playback.

To play a previous scene

Press **◀◀◀** repeatedly during playback.

To locate a scene while monitoring the picture

Press and hold **◀◀◀** or **▶▶▶** during playback. To resume normal playback, release the button.

On the Remote Commander, press **◀◀◀** or **▶▶▶**.*

Pressing **◀◀◀** or **▶▶▶** repeatedly switches the playback speed from 5 × and 10 ×.

To view the picture at slow speed (slow playback)

Press **◀◀◀** on the Remote Commander during playback pause.* For slow playback in the reverse direction, press **◀◀◀** on the Remote Commander.* The playback in the reverse direction moves in half a second step.

* To resume normal playback, press **▶▶▶**.

Still images

To display the next image

Press **▶▶▶**.

To display the previous image

Press **◀◀◀**.

[Marks on the buttons]

Marks on the buttons are different between the camcorder and the Remote Commander.

Marks of the camcorder:

▶	Playback
II	Pause
■	Stop
▶▶▶	Next
◀◀◀	Previous

Marks of the Remote Commander:

▶	Playback
II	Pause
■	Stop
▶▶▶	Next
◀◀◀	Previous
◀◀◀	Scan/Slow (forward)
▶▶▶	Scan/Slow (backward)

Note

It may take some time to switch the picture from playback to forwarding/reversing or vice versa.

Playing a disc on your camcorder

Displaying the indicators during playback – Display

Press DISPLAY/BATT INFO on your camcorder, or press DISPLAY on your Remote Commander.

The indicators switch on or off as you press the button.

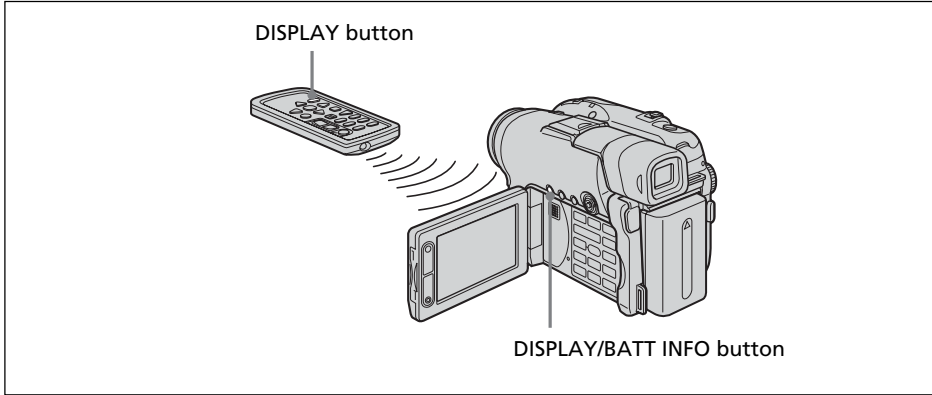

To display date/time and various settings

Your camcorder automatically records not only images on the disc but also the recording data (date/time and various settings when recorded) (**Data code**).

To display both the date/time and the data code, set $\overline{\text{ETC}}$ (OTHERS) – [DATA CODE] to [DATE/CAM] in the SETUP display.

To change date/time and various settings

Press DATA CODE on the Remote Commander during playback.

The display changes as follows:

date/time → various settings (SteadyShot, white balance, gain, shutter speed, aperture value, exposure) → no indicator

Date/time

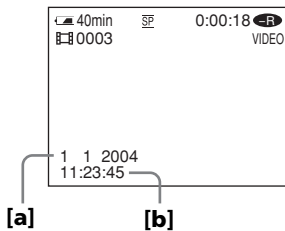

[a] date

[b] time

Playing a disc on your camcorder

Various settings (movie)

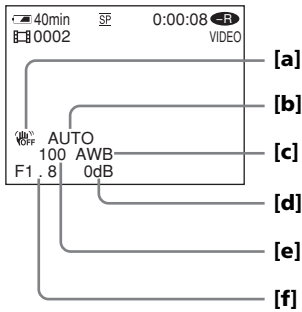

- [a] SteadyShot OFF
- [b] Exposure
- [c] White balance
- [d] Gain
- [e] Shutter speed
- [f] Aperture value

Various settings (still image)

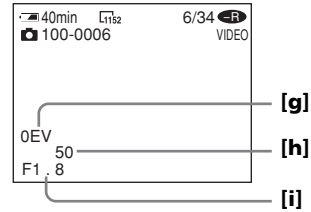

- [g] Exposure value
- [h] Shutter speed
- [i] Aperture value

Tips

- When you use data code during playback, bars (---) appear if:
 - the disc is unreadable due to damage or noise.
 - the disc was recorded through the AUDIO/VIDEO jack.
- The data code is displayed on the TV screen if you connect your camcorder to a TV.

Magnifying recorded images – PB ZOOM (Playback zoom)

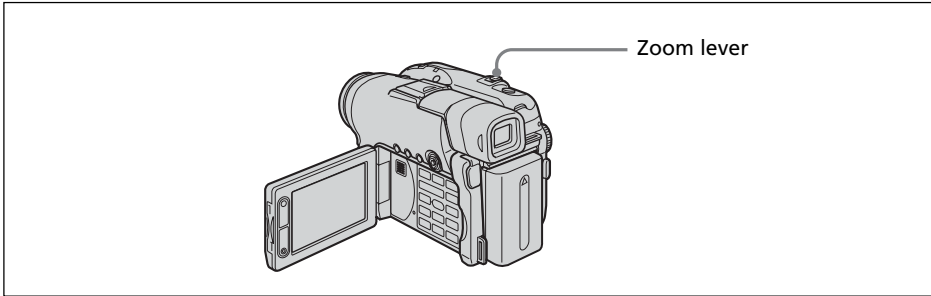

- 1** In the playback, playback pause or review, move the power zoom lever.
You can choose the magnification from approx. 1.1× to 5×.
W : Decreases the zoom ratio.
T : Increases the zoom ratio.
- 2** Move the enlarged image in the desired direction with the multi-selector.

To cancel PB ZOOM

Press the button in the center of the multi-selector.

You can also cancel PB ZOOM by moving the power zoom lever toward W as far as it will go.

Notes

- You cannot process externally input scenes using PB ZOOM of your camcorder.
- You cannot move a magnified circumferential image to the center of the display.

Tips

- You cannot record images on a disc in your camcorder when you have processed the image using PB ZOOM. However, you can record images on a VCR using your camcorder as a player.
- You can operate PB ZOOM in fast forward, fast backward and slow playback.
- PB ZOOM is canceled when you change the scene with ◀◀ / ▶▶.

Playing a disc on your camcorder

Playing still images automatically – Slide Show

You can see the automatic playback of all the still images recorded on the disc.

- 1 Set the mode dial to  (Play/Edit).
- 2 Press SETUP.

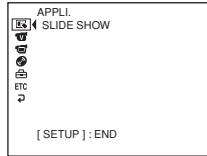

- 3 Use the multi-selector to select  (APPLI).

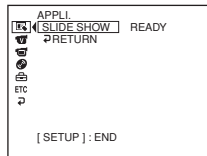



- 4 Use the multi-selector to select [SLIDE SHOW].



- 5 Press the button in the center of the multi-selector.
Still images play back in sequence. Playback stops when all the images are played back.

To start a slide show from a particular image

Select the desired image with  /  after step 4.

The slide show starts from the selected image and stops after all the images have been shown.

To cancel a slide show

Press SETUP.

To pause a slide show

Press the button in the center of the multi-selector. Press it again to restart the slide show.

Viewing recordings on TV

Connect your camcorder to your TV with the A/V connecting cable supplied with your camcorder to watch playback pictures on the TV screen. You can operate the video control buttons in the same way as when you monitor playback pictures on the LCD display. When monitoring playback pictures on the TV screen, it is recommended that you power your camcorder from a wall socket using the AC adaptor (page 18). Refer to the operating instructions of your TV.

Open the jack cover. Connect your camcorder to the TV using the A/V connecting cable supplied with your camcorder. Then, set the TV/VCR selector on the TV to VCR.

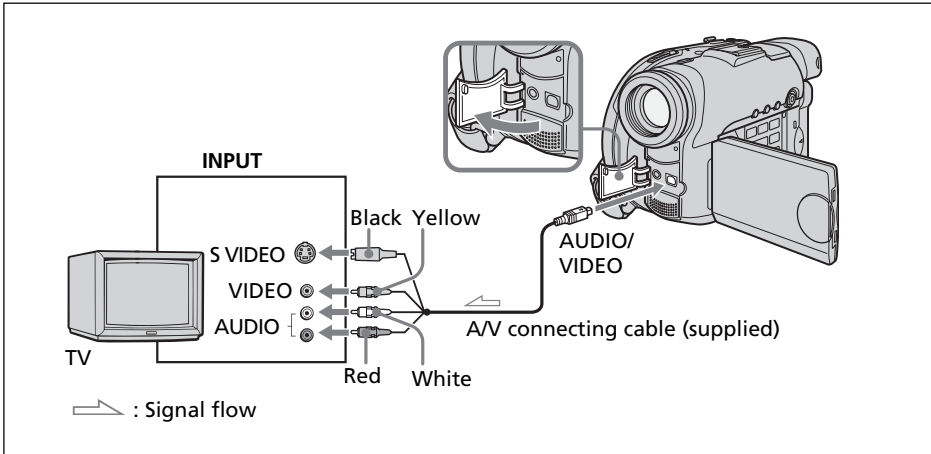

The supplied A/V connecting cable is equipped with an S video plug and a video plug. Use either the S video plug or the video plug depending on the TV or VCR.

If your TV is already connected to a VCR

Connect your camcorder to the LINE IN input on the VCR using the A/V connecting cable supplied with your camcorder. Set the input selector on the VCR to LINE.

If your TV or VCR is a monaural type

Connect the yellow plug of the A/V connecting cable to the video input jack and the white or the red plug to the audio input jack on the VCR or the TV. If you connect the white plug, the sound comes from the L (left) signal. If you connect the red plug, the sound comes from the R (right) signal.

If your TV or VCR has a 21-pin connector (EUROCONNECTOR)

Use the 21-pin adaptor supplied with your camcorder. This adaptor is exclusive to an output.

The models with **CE** mark printed on their bottom surfaces only.

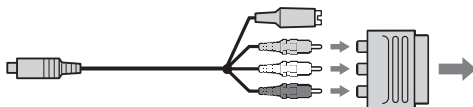

Viewing recordings on TV

Tips

- Connecting via an S video jack reproduces pictures more faithfully. When there is an S video jack on the device to be connected, connect the S video plug to that jack instead of using the yellow video plug. The audio will not be output when you connect via the S video plug alone.
- To turn off the indicators on the TV, set [DISPLAY] to [V-OUT/LCD] in ETC (OTHERS) in the SETUP display (page 116). Then press DISPLAY/BATT INFO on your camcorder. To display the indicators, press DISPLAY/BATT INFO on your camcorder again.

Finalizing a disc

You have to finalize the disc before you can play a recorded disc on other players. Finalizing makes the recorded disc DVD-Video compatible, and you can play the disc on equipments such as DVD players.

Note that you cannot record additional materials on finalized discs in VIDEO mode. But you can record on a disc again if you unfinalize the disc when you use DVD-RWs. Some players cannot play discs recorded in the VR mode. Make sure of playback compatibility with your players in advance of recording. For details, see the operating instructions supplied with your player.

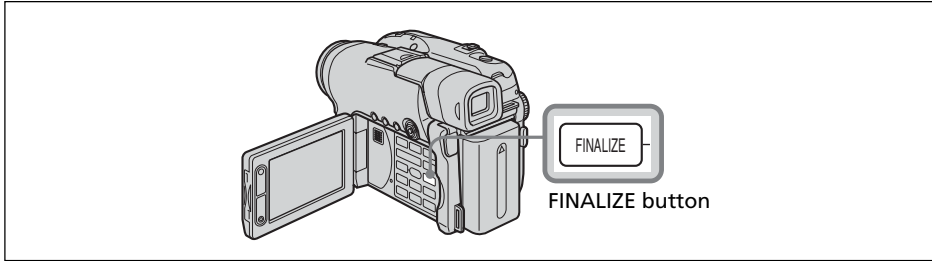

Notes

- Do not apply shock or vibration to your camcorder during finalizing.
- Do not disconnect the AC adaptor during finalizing or the disc may be damaged. When you need to disconnect the AC adaptor, make sure that the power of your camcorder is set to off and disconnect the adaptor after the POWER/CHG lamp goes off. Finalizing restarts when you connect the AC adaptor and turn on your camcorder again. You cannot remove the disc until the finalizing operation is completed.

Place your camcorder in a stable position. It takes about a minute to a few hours for finalizing. The shorter the amount of material recorded, the longer it takes for finalizing.

- 1** Connect the AC adaptor to the DC IN jack on your camcorder, then connect the mains lead to the wall socket.
- 2** Turn the power on by pressing the POWER button for a few seconds.
- 3** Press the FINALIZE button.

The [FINALIZE] display appears on the LCD display.

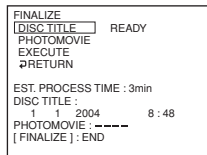

When you want to change a disc title, use the multi-selector to select [DISC TITLE], and press the button in the center to confirm your selection, then start the procedure from step 4 on page 68.

Finalizing a disc

- 4** When still images are included on a disc recorded in VIDEO mode, use the multi-selector to select [PHOTOMOVIE], then select [CREATE]. Proceed to step 5 in VR mode.

To play back still images on players such as DVD players, still images must be converted to a MPEG format. Converted still images are played back in sequence as a movie. The original still images remain as JPEG files.

When still images are recorded in VR mode, perform the operation in “Converting all the still images on a disc to a movie file – Photomovie” (page 79).

- 5** Use the multi-selector to select [EXECUTE].
The confirmation display appears.

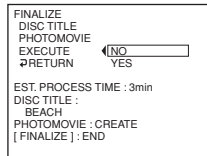

- 6** Use the multi-selector to select [YES], and press the button in the center of the multi-selector to confirm your selection.
Finalizing starts. In VIDEO mode, the menu display for the playback on DVD players appears temporarily.

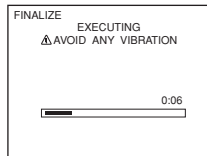

- 7** Press FINALIZE when [COMPLETED] appears.

The finalizing completion display disappears from the LCD display.

To cancel finalizing



Press FINALIZE or SETUP in any step from 3 to 6.

Finalizing a disc

Notes

- A Photomovie created in this section is used to view still images on other players. You cannot view the Photomovie on your camcorder in VIDEO mode. Use the slide show feature to play back still images in sequence on your camcorder (page 62).
- If you set [PHOTOMOVIE] to [CREATE] during finalizing, it may take some time for finalizing. The more still images recorded on the disc, the more time it takes to create a Photomovie.
- Still images which are not compatible with your camcorders, such as ones shot using a digital still camera and then copied to a computer can not be converted from still images to a movie using [PHOTOMOVIE].
- Playback may pause between the scenes in some players.

Tips

- You can also display the FINALIZE display by pressing SETUP and selecting  (DISC SET) – [FINALIZE] with the multi-selector.
- When the finalized disc is inserted in your camcorder, the disc format display on the upper-right corner is shown as below:
 - VIDEO mode: VIDEO
 - VR mode: VR
- Still images converted to a movie are shown with .

Finalizing a disc

Changing the disc title

By pressing the SETUP button, you can make a title on each disc. As the default, the date when the disc was first used is added as a disc title.

To change a disc title on the finalize display, select [DISC TITLE] with the multi-selector and start from step 4 on this page.

- 1 Press SETUP.

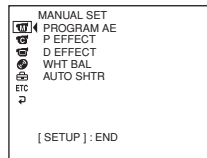

- 2 Use the multi-selector to select (DISC SET).

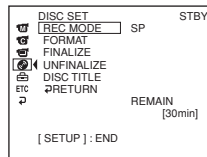

- 3 Use the multi-selector to select [DISC TITLE].

The DISC TITLE display appears.

- 4 Delete unnecessary characters by selecting [←] with the multi-selector.

Characters are deleted from the end.

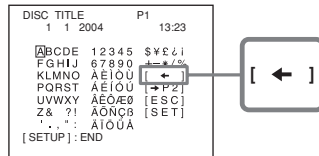

- 5 Use the multi-selector to select the desired character.

Up to 20 characters can be registered.

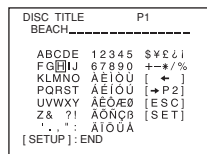

Finalizing a disc

- 6** Use the multi-selector to select [SET].
The disc title is set and the display returns to the SETUP display.

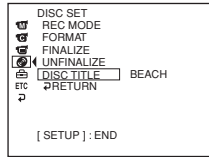

- 7** Press SETUP.
The SETUP display disappears from the LCD display.

To cancel editing the disc title

In any step from 4 to 5, use the multi-selector to select [ESC].

Note

When you change a disc title already set by other devices, the 21st and subsequent characters are deleted.

Tips

- You can add a space by selecting [] between [&] and [?].
- When you press SETUP in step 6, the disc title is set and the SETUP display disappears from the LCD display.

Finalizing a disc

Playing back a disc on a DVD player, etc.

To play back a disc recorded in VIDEO mode

You can play back a finalized disc recorded in VIDEO mode on players that can play back DVD-Rs or DVD-RWs.

When the disc is finalized in VIDEO mode, a menu display is provided similar to the Visual Index display. In menu display, 6 scenes are listed per page (200 pages in maximum).

Select the scene to be played back in menu display on the DVD player.

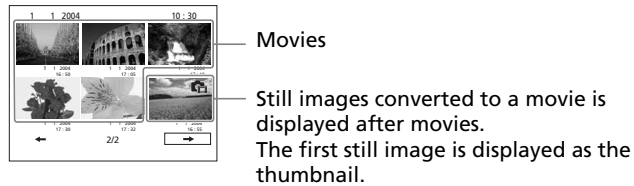
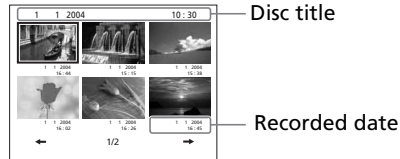

To play back still images

Still images are played back as a Photomovie swapping images in every 3 seconds. Pressing ◀◀/▶▶ during playback skips 10 images.

To play back a disc recorded in VR mode

You can play back a finalized disc recorded in VR mode on players which is compatible with DVD-RWs in VR mode.

Select the scene to be played back in menu display on the DVD player.

To play back still images

The operation is different depending on your player. See operating instructions of your player.

Notes

- Make sure that the vertical-shaped DVD player with a DVD drive are placed in a horizontal position when playing back.
- Do not use the 8 cm CD adaptor with an 8 cm DVD as it may cause malfunctions.
- The disc may not be played back on some players.
- Some functions, such as playback of still images, may be disabled on some players.
- To play back still images on other players, the still images must be converted into a Photomovie (page 79).
- Still images converted to a Photomovie may not be played back clearly, as the resolution (pixels) of the converted Photomovie is lower than that of the original still images.

Playing back a disc on a computer with a DVD drive installed

The display and the operation may vary depending on the operating system of your computer.

To play back movies

- 1 Turn on your computer.
- 2 Insert the finalized disc to the DVD drive of your computer.
A DVD playback application starts and the movie is played back.
When the DVD playback application does not start automatically, start the application from the [Start] menu of your computer.

To play back still images

- 1 Turn on your computer.
- 2 Insert the finalized disc to the DVD drive of your computer.
When a DVD playback application starts, close the application.
- 3 Click [Start] → [My Computer].
Or, double-click the [My Computer] icon on the desktop.
[My Computer] screen appears.

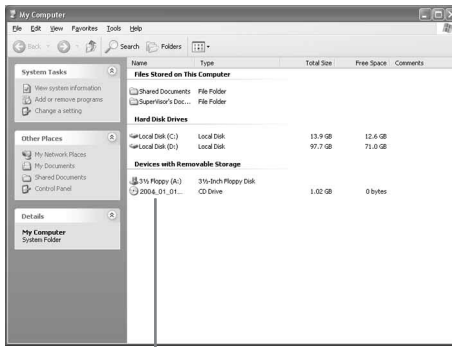

The date the disc was first used is recorded on the volume label of the disc.
When the disc was first used at 6:00 pm on January 1st 2004:
2004_01_01_06H00M_PM

- 4 Right-click the DVD drive with the disc inserted, then click [Open].
Folders in the disc appear.
- 5 Click [DCIM] → [100MSDCF].
The list of still images recorded on the disc appears.
- 6 Double-click the file to be shown.
The selected still image appears on the screen.

Finalizing a disc

Structures and file names of movies and still images

Movies and still images are stored in the following folders on the disc.

Movies: VIDEO_TS folder (on VIDEO mode)

DVD_RTAV folder (on VR mode)

Still images: DCIM\100MSDCF folder

Windows XP display

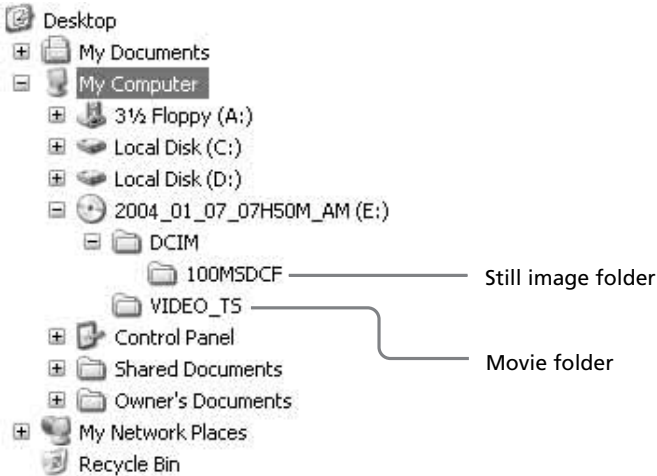

Notes

- Use the DVD drive compatible with 8 cm discs.
- A DVD playback application must have been installed on your computer.
- When playing back movies from the disc, the movie and sound may pause. In this case, copy the data to the hard disk drive of your computer.
- The disc may not be played back on some computers. For details, see operating instructions of your computer.

Tip

You can play back the disc on a computer without a DVD drive, by connecting your camcorder to your computer using a USB cable (page 99, DCR-DVD101E/DVD201E only).

Recording on a finalized disc – Unfinalizing (VIDEO mode DVD-RWs only)

You can record on finalized DVD-RWs by unfinalizing them. This operation is valid in VIDEO mode only. You do not have to unfinalize a VR mode disc. Insert a finalized DVD-RW into your camcorder beforehand.

- 1 Press SETUP.
- 2 Use the multi-selector to select  (DISC SET).
- 3 Use the multi-selector to select [UNFINALIZE].

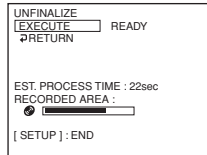

- 4 Use the multi-selector to select [EXECUTE].
The confirmation display appears.

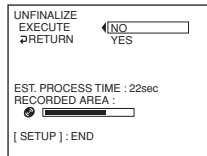

- 5 Use the multi-selector to select [YES].
Unfinalizing starts.

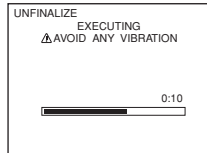

- 6 Press SETUP when the [COMPLETED] appears.
The message disappears from the LCD display and you can record on the disc again.

To cancel unfinalizing

Press SETUP in any step from 2 to 4.

Notes

- Make sure that the power of your camcorder is supplied from a wall socket using the AC adaptor.
- If you disconnect the AC adaptor while unfinalizing a disc, the disc may not be unfinalized correctly and it cannot be used to record additional material.
- Do not apply shock or vibration to your camcorder during unfinalizing.
- You can unfinalize DVD-RWs only. You cannot unfinalize a DVD-R disc.

Tip

It takes about 20 seconds for unfinalizing.

Recording again on a used disc – Formatting (DVD-RWs only)

You can format recorded DVD-RWs and make them new discs. Note that formatting erases all the data recorded on the disc.

Insert a recorded DVD-RW into your camcorder beforehand.

- 1 Press **SETUP**.
- 2 Use the multi-selector to select **[DISC SET]**.
- 3 Use the multi-selector to select **[FORMAT]**.

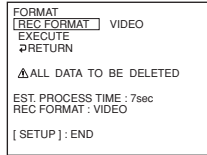

- 4 Use the multi-selector to select **[REC FORMAT]**.

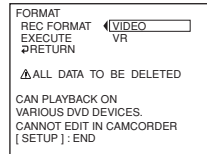

- 5 Use the multi-selector to select **[VIDEO]** or **[VR]**.

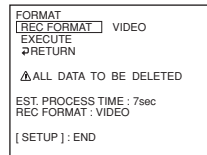

- 6 Use the multi-selector to select **[EXECUTE]**.
The confirmation display appears.

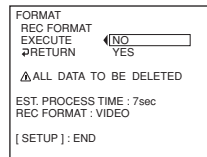

- 7 Use the multi-selector to select **[YES]**.
Formatting starts.

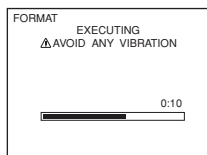

Recording again on a used disc – Formatting (DVD-RWs only)

- 8** Press SETUP when [COMPLETED] appears on the LCD display.
The FORMAT display disappears from the LCD display. The disc is formatted and you can record on the disc again.

To cancel formatting

Press SETUP in any step from 2 to 6.

Notes

- Make sure that the power of your camcorder is supplied from a wall socket using the AC adaptor.
- If you disconnect the AC adaptor during formatting, the disc may not be formatted correctly or damaged, and can not be recorded.
- Do not apply shock or vibration to your camcorder during formatting.
- You can format DVD-RWs only. You cannot delete any recorded data from DVD-Rs.

Tips

- It takes about 10 seconds to format a DVD-RW in VIDEO mode, and about 40 seconds to format a DVD-RW in VR mode.
- When you format a finalized disc, you will have a disc in one of the following conditions:
 - VIDEO mode: unfinalized
 - VR mode: finalized.You can record additional scenes or edit a disc finalized in VR mode.

Selecting the playing order on your camcorder – Playlist

You can edit the Playlist on your DVD-RWs recorded in VR mode. The Playlist is a list used to change the playback order of scenes to suit your own preference. The original scenes do not have any change even though you edit or delete the scenes in the Playlist.

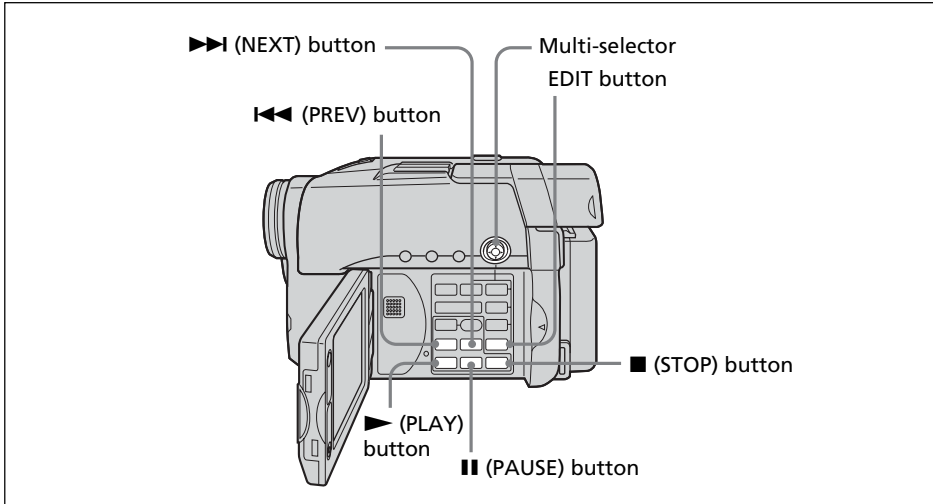

Notes

- The Playlist is usable in VR mode only.
- Do not remove the battery pack or the AC adaptor from your camcorder while editing. It may damage the disc.

Registering movies or still images in the Playlist

Insert a DVD-RW recorded in VR mode into your camcorder.

1 Set the mode dial to  (Play/Edit).

2 Press EDIT.

The display to select editing object appears.

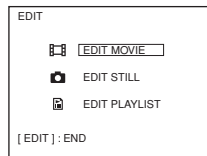

3 Use the multi-selector to select [EDIT PLAYLIST].

The Playlist edit display appears.

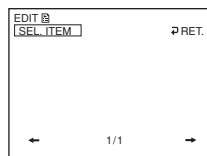

Selecting the playing order on your camcorder – Playlist

- 4 Use the multi-selector to select [SEL.ITEM].

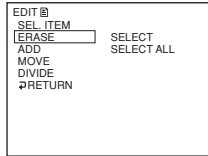

- 5 Use the multi-selector to select [ADD].

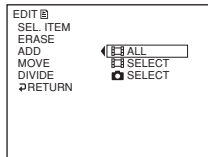

- 6 Use the multi-selector to select [SELECT] (movies) or [SELECT] (still images).
A thumbnail list of movies or still images on the disc appears.

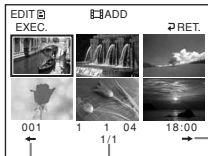

Forwards the page.

Shows current page/total pages.

Backwards the page.

- 7 Use the multi-selector to select the scene to be added to the Playlist.
The selected scene is marked with ✓.
Repeat this step to select multiple scenes.

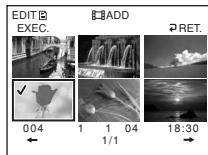

Pressing ► starts playback of the selected scene. Press ■ to return to the display to select other scenes.

- 8 Use the multi-selector to select [EXEC.].
The confirmation display appears.

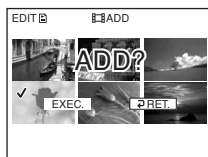

Selecting the playing order on your camcorder – Playlist

9 Use the multi-selector to select [EXEC.].

The selected movies or still images are registered in the Playlist. When a still image is added to a Playlist, it is converted and registered as a new movie in the movie folder. It returns to the Playlist edit display when the registration is completed.

To register all movies at the same time

Select  ALL] in step 6.

To register all still images at the same time

See “Converting all the still images on a disc to a movie file – Photomovie” on page 79.

To cancel the registration

Press EDIT in any step from 3 to 8.

Tips

- You can register up to 999 scenes in the Playlist.
- You can register only MPEG format movies in the Playlist. Still images recorded in JPEG format are converted to MPEG format when you register them in the Playlist. The original still image remains in the JPEG format.
- Still images converted to a movie are shown with .

Selecting the playing order on your camcorder – Playlist

Converting all the still images on a disc to a movie file – Photomovie

All the still images in a disc are saved as a single movie when you make a Photomovie. Saving still images as a single movie allows you to register more scenes in the Playlist. Insert a DVD-RW with still images recorded into your camcorder.

- 1 Set the mode dial to  (Play/Edit).
- 2 Press EDIT.
The display to select editing object appears.

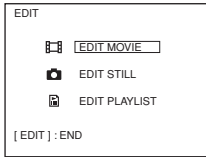

- 3 Use the multi-selector to select [EDIT MOVIE].
The movie edit display appears.

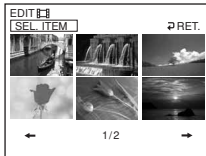

- 4 Use the multi-selector to select [SEL. ITEM].

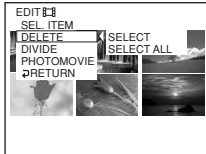

- 5 Use the multi-selector to select [PHOTOMOVIE].
The confirmation display appears.



- 6 Use the multi-selector to select [EXEC.].
All the still images on the disc are saved to a single movie file.
Still images saved as a movie are shown with .
It returns to the item selection display when the saving is completed.

To cancel the saving

Press EDIT in any step from 3 to 5.

Selecting the playing order on your camcorder – Playlist

Erasing unnecessary scenes from the Playlist

Erasing unnecessary scenes from the Playlist does not affect the actual recorded data on the disc.

Insert a Playlist-registered DVD-RW into your camcorder.

1 Set the mode dial to  (Play/Edit).

2 Press EDIT.

The display to select editing object appears.

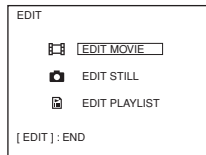

3 Use the multi-selector to select [EDIT PLAYLIST].

The Playlist edit display appears.



4 Use the multi-selector to select [SEL. ITEM].

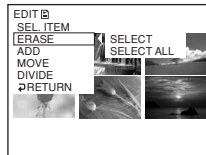

5 Use the multi-selector to select [ERASE].

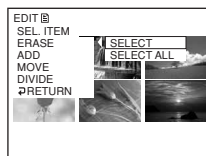

6 Use the multi-selector to select [SELECT].

A thumbnail list of scenes registered in the Playlist appears.

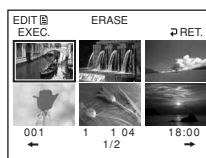

Selecting the playing order on your camcorder – Playlist

- 7** Use the multi-selector to select the scene to be erased.
The selected scene is marked with ✓.
Repeat this step to erase multiple scenes.

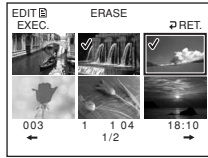

Pressing ► starts playback of the selected scene. Press ■ to return to the display to select other scenes.

- 8** Use the multi-selector to select [EXEC.].
The confirmation display appears.

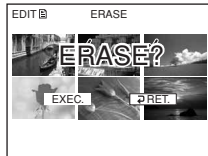

- 9** Use the multi-selector to select [EXEC.].
The selected scenes are erased from the Playlist. It returns to the Playlist edit display when the erasing is completed.

To erase all the scenes at the same time

Select [SELECT ALL] in step 6 then perform step 9.

To cancel erasing

Press EDIT in any step from 3 to 8.

Tip

Still images registered in a Playlist are converted to an MPEG format movie file. If you erase still images from a Playlist, the converted movie file made from the still images still remains. To delete a converted movie file from the movie folder, see “Deleting movies/still images” (page 89).

Selecting the playing order on your camcorder – Playlist

Changing the order within the Playlist

Insert a Playlist-registered DVD-RW into your camcorder.

- 1 Set the mode dial to  (Play/Edit).
- 2 Press EDIT.
The display to select editing object appears.

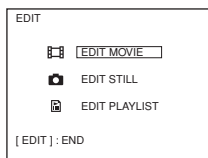

- 3 Use the multi-selector to select [EDIT PLAYLIST].
The Playlist edit display appears.

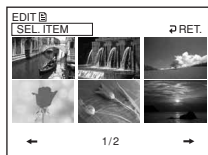

- 4 Use the multi-selector to select [SEL. ITEM].

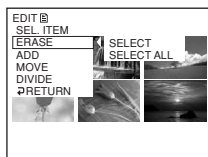

- 5 Use the multi-selector to select [MOVE].
A thumbnail list of the scenes registered to the Playlist appears.

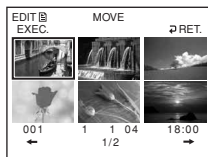

Selecting the playing order on your camcorder – Playlist

- 6** Use the multi-selector to select the scene to be moved.
The selected scene is marked with ✓.
Repeat this step if you want to move multiple scenes.

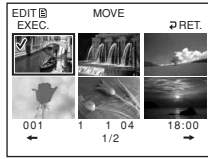

Pressing **▶** starts playback of the selected scene. Press **■** to return to the display to select other scenes.

- 7** Use the multi-selector to select [EXEC.].
The move destination display appears.

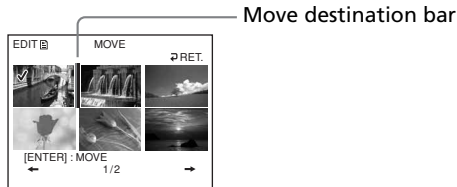

- 8** Use the multi-selector to place the move destination bar where you want to move the scenes.
The confirmation display appears.



- 9** Use the multi-selector to select [EXEC.].
The selected scene in step 6 is moved to the designated position. When you have selected multiple scenes, the scenes are moved following the order displayed in the Playlist.
It returns to the Playlist edit display when the moving is completed.

To cancel changing the order

Press EDIT in any step from 3 to 8.

Selecting the playing order on your camcorder – Playlist

Dividing a movie within the Playlist

You can divide a movie into 2 scenes. Dividing movies into scenes within the Playlist does not affect the actual recorded data on the disc.
Insert a Playlist-registered DVD-RW into your camcorder.

Note

You cannot divide a movie converted from still images.

1 Set the mode dial to  (Play/Edit).

2 Press EDIT.

The display to select editing object appears.

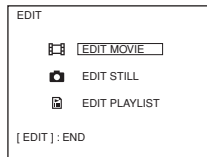

3 Use the multi-selector to select [EDIT PLAYLIST].

The Playlist edit display appears.

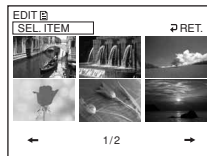

4 Use the multi-selector to select [SEL. ITEM].

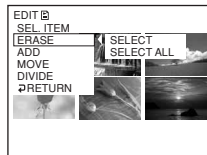

5 Use the multi-selector to select [DIVIDE].

A thumbnail list of the scenes registered in the Playlist appears.

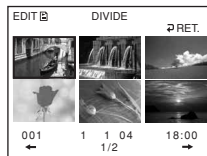

Selecting the playing order on your camcorder – Playlist

- 6** Use the multi-selector to select the scene to be divided.
The playback of the selected scene starts.

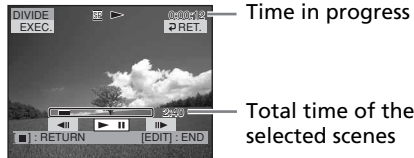

- 7** Press the button in the center of the multi-selector at the point at which you want to divide the movie into scenes.
The movie pauses.



Note

A slight difference may occur from the point where you press <||/||> and the actual dividing point, as your camcorder selects the dividing point based on half-second increments.

- 8** Use the multi-selector to select [EXEC.].
The confirmation display appears.

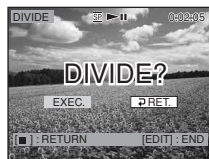

- 9** Use the multi-selector to select [EXEC.] again.
Dividing of the movie starts. It returns to the Playlist edit display when the dividing is completed.

To cancel dividing

Press EDIT in any step from 3 to 8.

Selecting the playing order on your camcorder – Playlist

Playing the Playlist

Insert a Playlist-registered DVD-RW into your camcorder.

- 1 Set the mode dial to  (Play/Edit).

The Visual Index display appears.

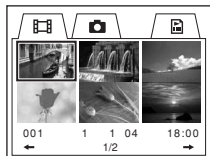

- 2 Use the multi-selector to select  (Playlist) tab.
A thumbnail list of the scenes registered to the Playlist appears.

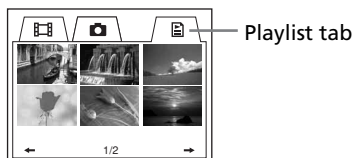

- 3 Press .
A playback of the Playlist starts. On still images, they are displayed on the LCD screen for a while. It returns to the Visual Index display when all the registered scenes are played back.

To start playback from a particular scene

Use the multi-selector to select the scene.
Playback starts from the selected scene.

To display another scene during playback

Press / .

To pause the scene

Press .

To cancel playback

Press .

Editing the original data

Original data stand for the actual recorded movies and still images data on the disc. You can edit the original data of DVD-RW recorded in VR mode. Editing the original data affects the actual recorded data.

Dividing a movie

Note that this operation actually divides the original recorded data on the disc. Insert a movie recorded DVD-RW into your camcorder.

Notes

- You cannot divide still images and still images converted to a movie.
- When the movie is registered in the Playlist, dividing the original movie does not affect the movie in the Playlist.

1 Set the mode dial to  (Play/Edit).

2 Press EDIT.

The display to select editing object appears.

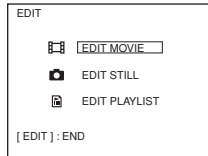

3 Use the multi-selector to select [EDIT MOVIE].

The Movie edit display appears.

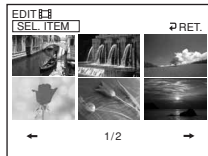

4 Use the multi-selector to select [SEL. ITEM].



5 Use the multi-selector to select [DIVIDE].

A thumbnail list of movies on the disc appears.

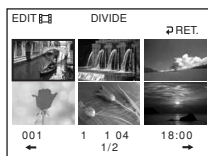

Editing the original data

- 6** Use the multi-selector to select the scene to be divided.
The playback of the selected movie starts.



- 7** Press the center of the multi-selector at the point at which you want to divide the movie into scenes.
The movie pauses.



Note

A slight difference may occur from the point where you press <||/> and the actual dividing point, as your camcorder selects the dividing point based on half-second increments.

- 8** Use the multi-selector to select [EXEC.].
The confirmation display appears.

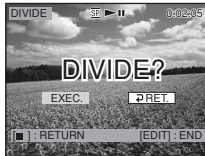

- 9** Use the multi-selector to select [EXEC.] again.
Dividing of the movie starts. It returns to the movie edit display when the dividing is completed.

To cancel dividing

Press EDIT in any step from 3 to 8.

Editing the original data

Deleting movies/still images

Note that this operation actually deletes recorded data from the disc.
Insert a recorded DVD-RW into your camcorder.

Notes

- When you delete movies, the movies registered to the Playlist are also deleted.
- Deleting scenes may not provide enough space to record movies or still images additionally.

- 1 Set the mode dial to  (Play/Edit).
- 2 Press EDIT.
The display to select editing object appears.

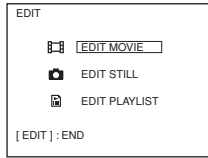

- 3 Use the multi-selector to select [EDIT MOVIE] or [EDIT STILL].
The movie or still images edit display appears.

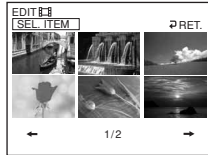

- 4 Use the multi-selector to select [SEL. ITEM].

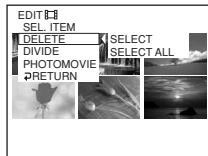

- 5 Use the multi-selector to select [DELETE].

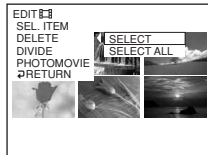

Editing the original data

- 6 Use the multi-selector to select [SELECT].

A thumbnail list of the movies or still images recorded on the disc appears.

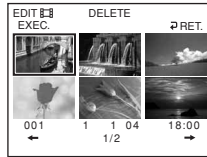

- 7 Use the multi-selector to select a scene.

The selected scene is marked with ✓.

Repeat this step to select multiple movies or still images.

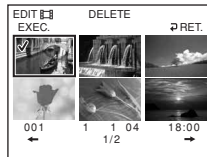

Pressing ► starts playback of the selected scene. Press ■ to return to the display to select others.

- 8 Use the multi-selector to select [EXEC.].

The confirmation display appears.

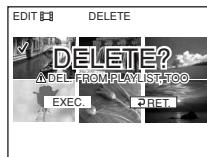

- 9 Use the multi-selector to select [EXEC.].

The selected movies or still images are deleted from the disc. It returns to the item selection display when the deletion is completed.

To delete all movies/still images in the folder at the same time

Select [SELECT ALL] in step 6.

To cancel the deletion

Press EDIT in any step from 3 to 8.

Tip

To delete all the movies and still images on the disc, perform formatting (page 74).

Connecting your camcorder to your computer – Introduction

A USB driver and application software installation is required to connect your camcorder to your computer.

The USB driver along with the application software required for editing scenes can be found on the CD-ROM supplied with your computer. You can enjoy the following with your camcorder by connecting the camcorder to your computer using the USB cable:

- Copying recorded scenes to your computer
- Viewing scenes on your computer
- Editing scenes copied to your computer
- Duplicating a disc
- Making an original DVD using recorded scenes stored on your computer.

Notes

- Scenes may not be transferred correctly depending on your computer. If this happens, set [USB SPEED] to [FULL-SPEED] in  (SETUP MENU) in the SETUP display.
- Depending on your application software, the file size may increase when you open a still image file.
- Communications between your camcorder and your computer may not recover properly even after your computer recovers from Suspend/Resume, or from Sleep status.
- The software in the supplied CD-ROM does not work with a Mac OS or Mac OSX.

Tips

- Your camcorder is compatible with Hi-Speed USB (the USB 2.0 Specification). You can transfer data at a faster rate using a computer compatible with Hi-Speed USB.
- When you connect a USB interface not compatible with Hi-Speed USB, the data transfer ratio will be that of USB 1.1 (USB full speed).

System requirements

OS:

Microsoft Windows Me, Microsoft Windows 2000 Professional, Microsoft Windows XP Home Edition or Microsoft Windows XP Professional. The above OS must be installed at the factory. Operations are not guaranteed in an environment upgraded to the operating systems described above or in a multi-boot environment.

CPU:

Minimum: 500 MHz Intel Pentium III or faster (1 GHz Intel Pentium III or faster recommended)

Application:

DirectX 8.0a or later

Sound system:

16 bit stereo sound card and stereo speakers

Memory:

64 MB or more

Hard disk:

Available free space required for installation: at least 250 MB

Available hard disk space recommended: at least 2 GB (depending on the size of the files edited)

Display:

Video card with 4 MB or more of VRAM, Minimum 800 × 600 Hi color (16 bit color, 65 000 colors), DirectDraw display driver capability (At 800 × 600 or less, 256 colors and less, this product will not operate correctly.)

USB port:

Must be provided as standard.

Consult the computer manufacturer for the details on connectors and editing software of your computer.

Connecting your camcorder to your computer – Introduction

Installing the USB driver

Start the following operation before connecting the USB cable to your computer.

Install the USB driver to control your camcorder from your computer.

If you are using Windows 2000 Professional or Windows XP Home Edition/Professional Log on as administrator.

- 1 Turn on your computer and allow Windows to load.
When your computer is already turned on, close all the software.
- 2 Insert the supplied CD-ROM into the CD-ROM drive of your computer.
The installation menu window appears.



If the menu window does not appear, double-click [My Computer], then [ImageMixer] (CD-ROM Drive). The menu window appears after a while.

- 3 Move the cursor to [USB Driver] and click.

InstallShield Wizard program starts up.



- 4 Click [Next].

The USB driver installation starts.
[InstallShield Wizard Complete] dialog box appears after a while.



- 5 Click [Finish].

The USB driver installation is completed.

Note

If you connect the USB cable before USB driver installation is complete, the USB driver will not be properly installed. Install the USB driver again following the steps in “If you cannot install the USB driver” (page 98).

Connecting your camcorder to your computer – Introduction

Installing software

Install the ImageMixer Ver.1.5 for Sony DVD Handycam (hereinafter referred to as ImageMixer) software that manages movies and still images transferred from your camcorder on your computer, and the WINASPI software that manages writing data on CD-Rs/CD-RWs.

- 1 When the USB driver installation is completed, click [ImageMixer] on the menu window.
Install Wizard program starts up and the [Choose Setup Language] window appears.
If the menu window does not appear, double-click [My Computer], then [ImageMixer] (CD-ROM Drive). The menu window appears after a while.



- 2 Select the language to be used and click [OK].



- 3 Follow the instructions given in the on-screen messages. When the [Setup Type] window appears, make sure that [PAL] is selected and continue the procedure. The [InstallShield Wizard Complete] dialog box appears.

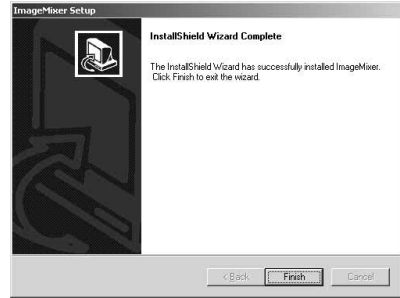

- 4 Click [Finish].
The installation of ImageMixer is completed. The installation dialog box of WINASPI appears.



- 5 Click [OK], and follow the instructions given in the on-screen messages.
- 6 When The [InstallShield Wizard Complete] dialog box appears, click [Finish].
- 7 Take out the CD-ROM from the CD-ROM drive after the computer restarts.

Note

On a computer without DirectX 8.0a or later, DirectX installation starts. Follow the instructions given in the on-screen messages and restart the computer after the installation is complete.

About WINASPI

To be able to use the ImageMixer CD writing function, you need to install WINASPI. If a different writing application was previously installed, its writing function may not work correctly. If that happens, reinstall the original application and replace WINASPI. Note that the ImageMixer CD writing function may not work properly.



Connecting your camcorder to your computer – Introduction

Connecting your camcorder to the computer

Notes

- Install the USB driver before connecting the camcorder to your computer. If you connect the camcorder to the computer first, you will not be able to install the USB driver correctly.
- You can connect only one camcorder to every single computer.
- Operations are not guaranteed if you connect your camcorder via a USB hub or to the USB port not equipped with your computer at default.
- Operations are not guaranteed on all the recommended environments.

For Microsoft Windows XP users

- 1 Connect the AC adaptor to your camcorder.
- 2 Set the mode dial to  (Play/Edit).
- 3 Turn the power on your camcorder by pressing the POWER button for a few seconds.
- 4 Connect the  (USB) jack of the camcorder and the  (USB) port of the computer using the USB cable supplied with your camcorder.

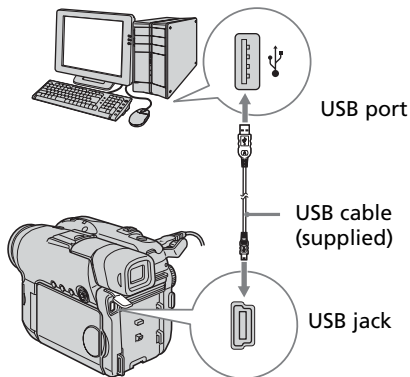

Your computer recognizes the camcorder, and the [Found New Hardware Wizard] starts.



- 5 Select [Install the software automatically (Recommended)] and click [Next].

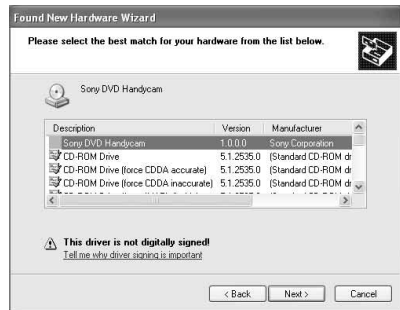

- 6 Make sure that [Sony DVD Handycam] is selected as the best match and click [Next]. Click [Sony DVD Handycam] if it is not selected. [Completing the Found New Hardware Wizard] dialog box appears.



Connecting your camcorder to your computer – Introduction

7 Click [Finish].

The connection between your camcorder and the computer is completed.

To confirm the USB driver installation

- 1 Click [Start] → [Control Panel].
- 2 Click [Performance and Maintenance] → [System].
[System Properties] window appears.
- 3 Click [Hardware] tab.
- 4 Click [Device Manager].
[Device Manager] window appears.
- 5 Make sure that [SONY DDX-A1010 USB Device] appears in [DVD/CD-ROM drives], [Generic volume] in [Storage volumes], and [USB Mass Storage Device] in [Universal Serial Bus controllers] respectively.

When all the devices appear, the USB driver is installed correctly. If any of these devices are not shown, install the USB driver again following “If you cannot install the USB driver” (page 98).

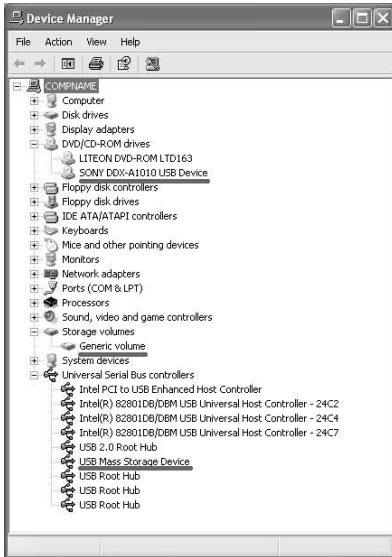

For Microsoft Windows 2000 users

- 1 Connect the AC adaptor to your camcorder.
- 2 Set the mode dial to (Play/Edit).
- 3 Turn the power on your camcorder by pressing the POWER button for a few seconds.
- 4 Connect the (USB) jack of the camcorder and the (USB) port of the computer using the USB cable supplied with your camcorder.

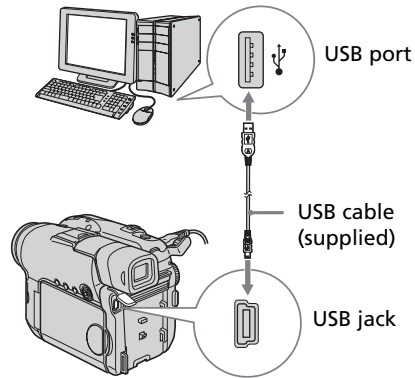

Your computer recognizes the camcorder, and the [Found New Hardware] dialog box appears.



- 5 Follow the instructions given in the on-screen messages.
The connection between your camcorder and the computer is completed.

Viewing/duplicating discs/editing the recordings on your computer (DCR-DVD101E/DVD201E only)

Connecting your camcorder to your computer – Introduction



To confirm the USB driver installation

- 1 Click [Start] → [Settings] → [Control Panel].
- 2 Click [System].
[System Properties] window appears.
- 3 Click [Hardware] tab.
- 4 Click [Device Manager].
[Device Manager] window appears.
- 5 Make sure that [SONY DDX-A1010 USB Device] appears in [DVD/CD-ROM drives], [Generic volume] in [Storage volumes], and [USB Mass Storage Device] in [Universal Serial Bus controllers] respectively.

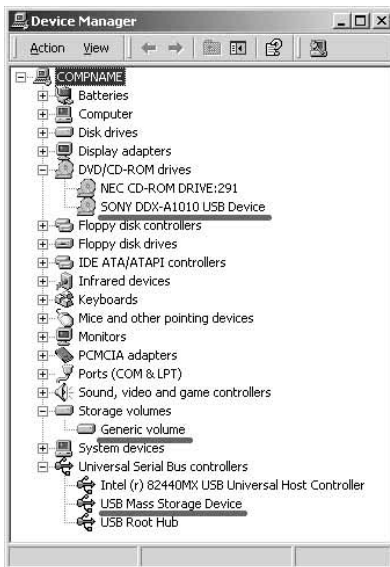
When all the devices appear, the USB driver is installed correctly. If any of these devices are not shown, install the USB driver again following “If you cannot install the USB driver” (page 98).



For Microsoft Windows Me users

- 1 Connect the AC adaptor to your camcorder.
- 2 Set the mode dial to  (Play/Edit).
- 3 Turn the power on your camcorder by pressing the POWER button for a few seconds.
- 4 Connect the  (USB) jack of the camcorder and the  (USB) port of the computer using the USB cable supplied with your camcorder.

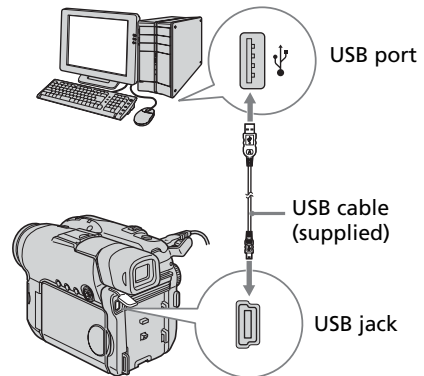

Your computer recognizes the camcorder, and the [New Hardware Found] dialog box appears.



- 5 Follow the instructions given in the on-screen messages and restart your computer.
The connection between your camcorder and the computer is completed.

Connecting your camcorder to your computer – Introduction

To confirm the USB driver installation

- 1 Click [Start] → [Settings] → [Control Panel].
- 2 Click [System].
[System Properties] window appears.
- 3 Click [Device Manager].
[Device Manager] window appears.
- 4 Make sure that [SONY DDX-A1010] appears in [CDROM], [Sony DVD Handycam] in [Storage device], and [USB Mass Storage Device] in [Universal Serial Bus controllers] respectively.
When all the devices appear, the USB driver is installed correctly. If any of these devices are not shown, install the USB driver again following “If you cannot install the USB driver” (page 98).

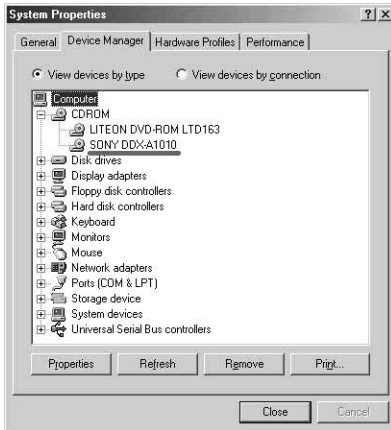
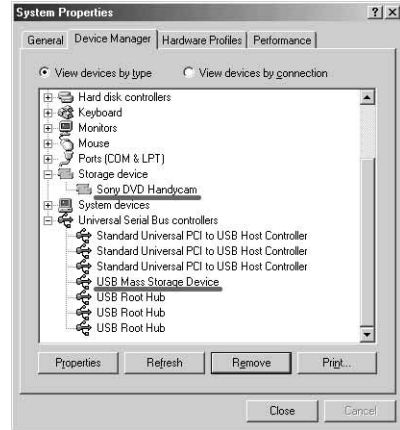

To disconnect the USB cable

- 1 Move the cursor to the [Unplug or Eject Hardware] icon on the Task Tray and click to cancel the applicable drive.



- 2 After the [Safe to Remove Hardware] dialog box appears, disconnect the USB cable and turn off your camcorder.

Notes

- Be sure to turn off your camcorder after disconnecting the USB cable from your computer. Turning off your camcorder keeping connection to the computer may prevent from normal disconnection.
- Never disconnect the USB cable when the ACCESS lamp is lit in red. It may cause a damage to the disc.

Viewing/duplicating discs/editing the recordings on your computer (DCR-DVD101E/DVD201E only)

If you cannot install the USB driver

The USB driver has been registered incorrectly as your camcorder was connected to your computer before the installation of the USB driver was completed. The incorrect data of the USB driver will be deleted when you re-install the driver correctly. Do the following steps to install the USB driver.

- 1 Disconnect your camcorder from the computer following “To disconnect the USB cable” (page 97).
- 2 Install the USB driver again following “Installing the USB driver” (page 92).
- 3 After “InstallShield Wizard complete” dialog box disappears, restart your computer.
- 4 Connect your camcorder to the computer following “Connecting your camcorder to the computer” (page 94). The USB driver installation and the connection between your camcorder and the computer is completed.

Consulting the on-line help

An ImageMixer on-line help is available where you can find detailed operating instructions for ImageMixer software.

- 1 Click  located at the top right of the window.
Or, click [Start] → [Programs] ([All Programs] in Windows XP) → [PIXELA] → [ImageMixer] → [Help]. The ImageMixer Help window appears.
- 2 Find the information you need from the table of contents.

To close the on-line help

Click the  button at the top right of the window.

If you have any questions about ImageMixer

ImageMixer is a product of PIXELA Corporation. For details, refer to the operating instructions of the CD-ROM supplied with your camcorder.



Viewing scenes recorded on your computer

You must install the USB driver and the ImageMixer software to view scenes recorded on a disc with your computer (page 92, 93).

If you are using Windows 2000 Professional or Windows XP Home Edition/Professional, log in as administrator.

Viewing scenes on the disc

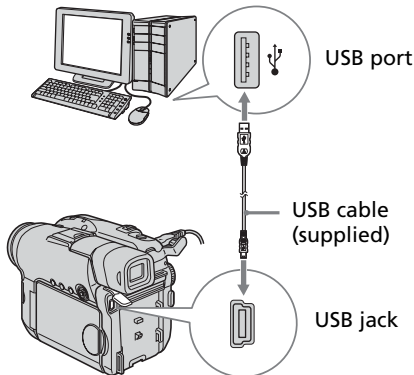

You can view scenes recorded on the disc without finalizing on your computer, by inserting a recorded disc into your camcorder and connecting it to your computer.

- 1 Turn on your computer and allow Windows to load.
- 2 Connect the AC adaptor to your camcorder.
- 3 Set the mode dial to  (Play/Edit).
- 4 Turn the power on your camcorder by pressing the POWER button for a few seconds.
- 5 Insert a recorded disc into your camcorder.
- 6 Connect the  (USB) jack of the camcorder and the  (USB) port of the computer using the USB cable supplied with your camcorder.





- 7 Double-click [ImageMixer Ver.1.5 for Sony DVD Handycam] icon on the Windows desktop.
Or, click [Start] → [Programs] ([All Programs] in Windows XP) → [PIXELA] → [ImageMixer] → [PIXELA ImageMixer Ver.1.5 for Sony DVD Handycam] on your computer.
The ImageMixer software starts and the title dialog box appears.



- 8 Click  on the left of the window. The thumbnails of the scenes recorded on the disc appear. When the thumbnails do not appear, click , then click .



- Click  to view movies and click  to view still images.

Viewing/duplicating discs/editing the recordings on your computer (DCR-DVD101E/DVD201E only)

Viewing scenes recorded on your computer

- 9** Double-click the scene to view from the thumbnails.

The selected scene is temporarily copied to your computer and is displayed in the preview window.

To return to the thumbnails list, click

 below right of the window.

To save the scene on your computer

- 1 Click the thumbnail of the scene to save.

- 2 Click .

The selected scene is saved on your computer.

To view the album

- 1 Click .

- 2 Double-click the scene to view from the thumbnails.

The selected scene is displayed. When you have selected a movie, click  and start playback.

To return to the thumbnails list, click

 at the top right of the window.

Notes

- If you connect the USB cable before USB driver installation is complete, the USB driver will not be properly registered. Install the USB driver again following the steps in “If you cannot install the USB driver” (page 98).
- It may take some time to save the scene to the computer depending on the recording mode (page 32) and the length of the movie.
- You cannot remove the disc from your camcorder during displaying the thumbnails on your computer display.
- When anything goes wrong with the operation, close all the software and restart the computer.



Tips

- An album is a unit to register and to manage the saved movies and still images saved from your camcorder to your computer.
- Still images converted to a movie are not displayed.



Making a disc copy – Disc Duplicating

Making a disc copy

You can make a copy of a finalized disc.

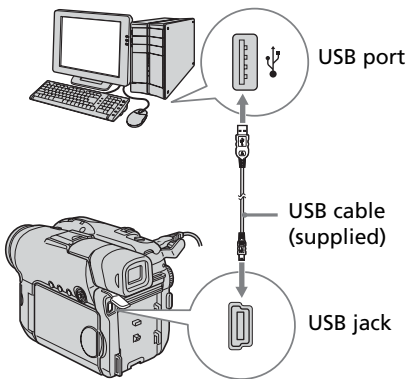
- 1 Turn on your computer and allow Windows to load.
- 2 Connect the AC adaptor to your camcorder.
- 3 Set the mode dial to  (Play/Edit).
- 4 Turn the power on your camcorder by pressing the POWER button for a few seconds.
- 5 Insert a recorded and finalized disc into your camcorder.
- 6 Connect the  (USB) jack of the camcorder and the  (USB) port of the computer using the USB cable supplied with your camcorder.



- 7 Start the ImageMixer software on your computer.
- 8 Click  on the left of the window.
- 9 Click .
The confirmation dialog box appears.

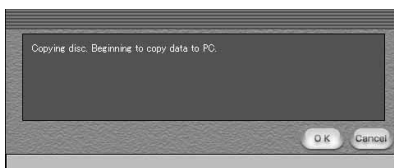

- 10 Click [OK].
- 11 When the copy completion message appears, remove the disc and insert a new disc into your camcorder.
- 12 Click [OK].
Copying of data from your computer to the new disc starts. When the disc copy operation is completed, a dialog box asking if you want to make an additional copy appears.
- 13 If you want to make an additional copy, click [OK].
The making of an additional copy starts. If you do not want to make an additional copy, click [Cancel] to end the procedure.
- 14 Remove the disc following the instructions given in the on-screen messages.

Notes

- It may take some time to save the scene depending on the recording mode (page 32) and the length of the movie.
- You cannot make a copy of an unfinalized disc.
- You cannot copy a DVD-RW recorded in VR mode to a DVD-R. Use another DVD-RW.
- The ACCESS lamp lights up when duplicating a disc. During the duplication, you cannot remove the disc.
- Using DVD-RWs for the copied media prevents you from unfinalizing and making additional recordings on your camcorder because the format of copied media is different from that of your camcorder. You must format the DVD-RW to record additional material on the disc.

Tip

To use the disc with other DVD authoring applications, a file exporting procedure is required. For details, see the ImageMixer on-line help.

Editing and saving scenes

Editing movies

You can combine multiple scenes into a single scene.

- 1 Click  on the title window.
The window switches to the [Movie Editing Environment] and thumbnails appear.



- 2 Drag and drop the thumbnails on the storyboard in the order you want to edit them.

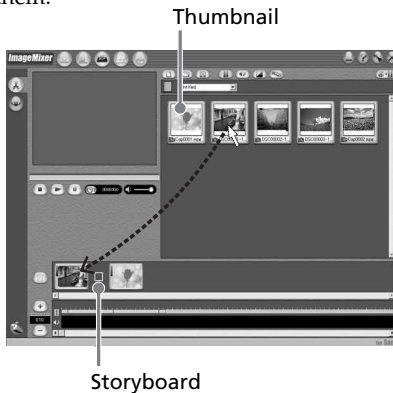

When you want to delete a specific scene, click the scene, then click .

Saving the movie on your computer

When the editing of the movie is completed, you can save the data on your computer. The following procedure shows an example of saving data in the [My Documents] folder.

- 1 Click  on the right of the window.
The [Output Format Settings] dialog box appears.
- 2 Click [OK].
- 3 Select the [My Documents] folder as the saving destination, then name the file and click [OK] to save it.
When the movie is saved, it is also saved as a new file in the album.

Note

It takes some time for saving the file in the following cases:

- when the file includes both movies and still images.
- when the file includes multiple recording modes (HQ/SP/LP).
- when some effects such as faders are added.

To view the saved file

Double-click the saved file (stored in the [My Documents] folder in this procedure). Windows Media Player starts and the file is played back.

Creating an original disc

You can edit the scenes registered to the album and make an original DVD.

Making a menu

A menu is required to play a disc recorded on your camcorder on a DVD player.

- 1 Click  on the title window. The [Layout mode] window appears.



- 2 Click the  tab and select a background.
- 3 Drag and drop thumbnails of the scenes to record on the disc, onto the background. The thumbnails change into icons and the selected scenes are registered to contents. You can register an album as a single title by dragging and dropping the album onto the background. You can also joint scenes from multiple albums and display them as a single title.

Album menu:
Click to change the displayed album.

Disc title

Title

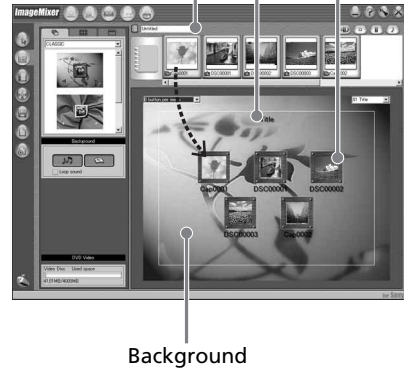

Background

- 4 When you want to change the names and designs of icons, click the  tab. Click the icon and change the settings.



Viewing/duplicating discs/editing the recordings on your computer (DCR-DVD101E/DVD201E only)

Creating an original disc

- 5** When you want to change the disc title shown on the menu, click the  tab. Change the settings such as the name and the font.



Tip

When you create a DVD on the DVD drive installed with your computer, you can change the “Disc Type” from [1.4G] to [4.7G] by clicking  at the top right of the window. Selecting [4.7G] enables you to record data in 12 cm DVD-R/DVD-RW at its maximum capacity.

Editing the contents

You can edit the contents by adding/deleting scenes, changing the order of scenes, and selecting an image used for the thumbnail.

- 1** Click the icon of the contents to edit, then click  on the left of the window. The [Album mode] window appears.



- 2** Drag and drop the contents to add and change the order. To delete the contents, click the contents, then click . Note that image selected as a thumbnail cannot be deleted.





Creating an original disc

Recording on a disc

Check the menu and view the contents on a preview window, then record the contents on a disc.

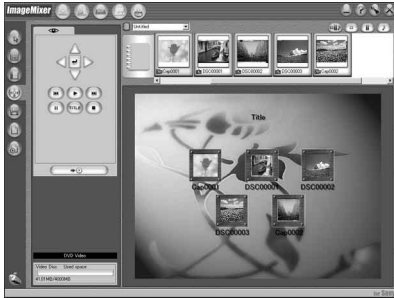
- 1 Click  on the left of the window. The [Writing mode] window appears.



- 2 Click the button on the  (Preview panel) box on the upper left of the window, and preview the contents.

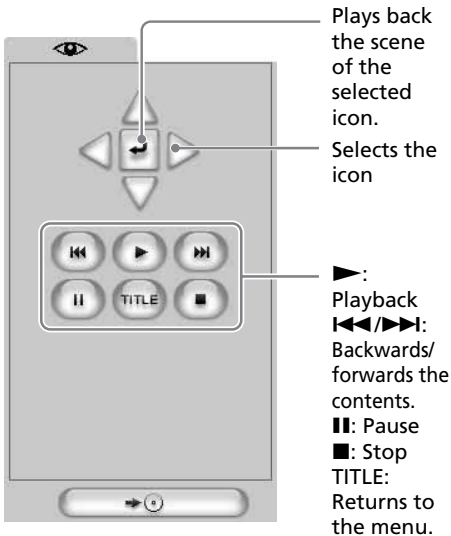

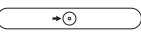
- 3 When you have checked that all the contents are right, connect your camcorder to the computer with the USB cable, then insert a blank disc into your camcorder.
- 4 Click . The [DVD Video Output] window appears.

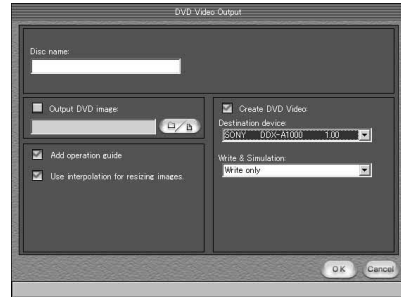

- 5 Click [OK]. Recording on the disc starts. When the operation is completed, a dialog box asking if you want to make an additional copy appears.
- 6 If you want to make an additional copy, click [OK]. The making of an additional copy starts. If you want to finish the procedure, click [Cancel].
- 7 Remove the disc following the instructions given in the on-screen messages.

Notes

- It may take some time to save the scene depending on the recording mode or recording time.
- The ACCESS lamp lights up when recording on a disc. During the recording, you cannot remove the disc.

Viewing/duplicating discs/editing the recordings on your computer (DCR-DVD101E/DVD201E only)

Dubbing a disc to a tape

You can dub movies recorded in a disc using a VCR connected to your camcorder, using your camcorder as a player.

Connecting your camcorder to a VCR

Connect your camcorder to the VCR using the A/V connecting cable supplied with your camcorder.

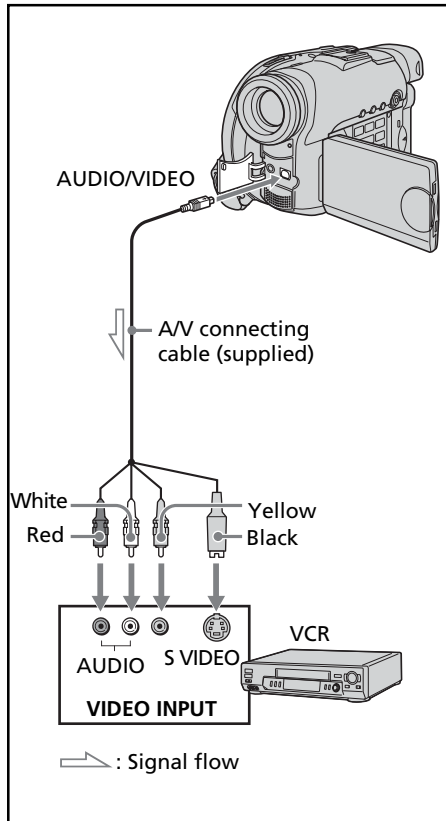

Tips

- You can edit on VCRs that support the following systems:
8 8 mm, **Hi8** Hi8, **VHS** VHS, **S-VHS** S-VHS, **VHS-C** VHS-C, **S-VHS-C** S-VHS-C, **B** Betamax, **Mini DV** mini DV, **DV** DV, **D** Digital8, **MICRO MV** MICRO MV
- If your VCR is a monaural type, connect the yellow plug of the A/V connecting cable to the video input jack and the white or the red plug to the audio input jack on the VCR. When the white plug is connected, the left channel audio is output, and when the red plug is connected, the right channel audio is output.
- Connecting via an S video jack reproduces pictures more faithfully. When there is an S video jack on the device to be connected, connect the S video plug to that jack instead of using the yellow video plug. The audio will not be output when you connect via the S video plug alone.

Dubbing a disc to a tape

Dubbing to a tape

Before operation

- Set [DISPLAY] in **ETC** (OTHERS) to [LCD] in the SETUP display (the default setting is [LCD]).
- Press the following buttons to make the indicators disappear so that they will not be superimposed on the edited tape:
 - DISPLAY/BATT INFO
 - DISPLAY on the Remote Commander
 - DATA CODE on the Remote Commander

- 1** Insert the recorded disc into your camcorder.
- 2** Prepare the VCR for recording.
Insert a blank tape (or a tape you want to record over) into the VCR.
Set the input selector to LINE.
Refer to the operating instructions of the VCR.
- 3** Start recording on the VCR.
- 4** Play back the recorded disc on your camcorder.

When you have finished dubbing

Stop recording on the VCR, then press ■ on your camcorder.

Dubbing a TV program or video tape onto a disc (DCR-DVD101E/DVD201E only)

You can record a disc from another VCR or a TV program. Use your camcorder as a recorder.

Connecting your camcorder to a TV or a VCR

Connect your camcorder to the TV/VCR using the A/V connecting cable supplied with your camcorder.

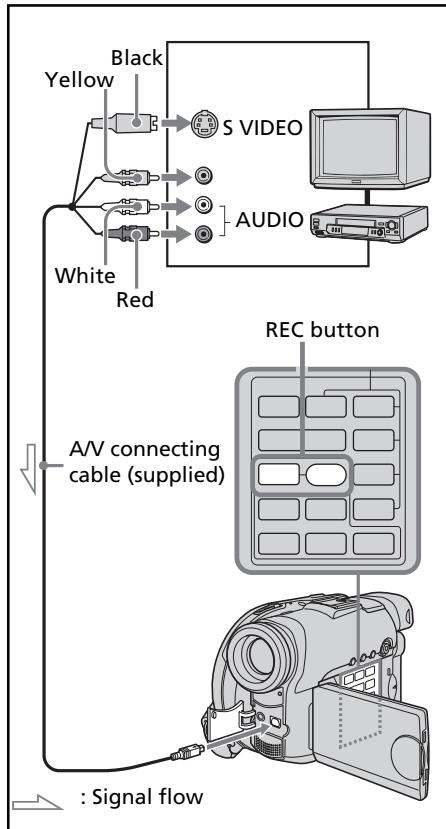

Selecting the Video jack to be used on the TV or the VCR

The supplied A/V connecting cable is equipped with an S video plug and a video plug depending on the TV or the VCR. Use either the S video plug or the video plug depending on the TV or the VCR. Set [DISPLAY] in [ETC] (OTHERS) to [LCD] in the SETUP display (the default setting is [LCD]).

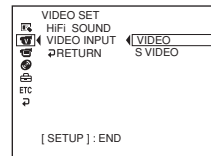

- 1 Set the mode dial to (Play/Edit) on your camcorder.
- 2 Press SETUP.
The SETUP display appears.
- 3 Use the multi-selector to select (VIDEO SET).
- 4 Use the multi-selector to select [VIDEO INPUT].



- 5 Use the multi-selector to select [VIDEO] or [S VIDEO].
- 6 Press SETUP.
The SETUP display disappears from the LCD display.

Dubbing a TV program or video tape onto a disc (DCR-DVD101E/DVD201E only)

Dubbing onto a disc

- 1** Prepare the TV/VCR.
If you are recording a tape from the VCR, insert a recorded tape into the VCR.
- 2** Set the mode dial to  (Play/Edit) on your camcorder.
- 3** Insert a blank disc (or a disc you want to record additionally) into your camcorder.
The [FORMAT] display appears when you insert a new DVD-RW. Format the disc in VIDEO mode or in VR mode (page 7) following the instructions on the display.
- 4** Press VISUAL INDEX on your camcorder.
The Visual Index display disappears, and the image from the LINE appears.
- 5** Playback the tape on the VCR if you are recording a tape from a VCR. Select a TV program if you are recording from a TV. The picture from the VCR or TV appears on the LCD display or in the viewfinder.
- 6** Press REC  and the adjacent button at the same time on your camcorder at the scene where you want to start recording. Dubbing starts.

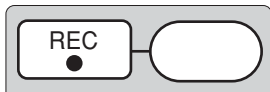

When you have finished dubbing

Press  on your camcorder to stop recording and stop the playback on the VCR.

Note

There may be time difference between the point when you press REC and the actual point that the recording starts/stops.

Tips



- To change the recording mode, see page 32.
- If your VCR is a monaural type, connect the yellow plug of the A/V connecting cable to the video output jack and the white or the red plug to the audio output jack on the VCR or the TV. If you connect the white plug, the sound is from the L (left) signal. If you connect the red plug, the sound is from the R (right) signal.
- Connecting via an S video jack reproduces pictures more faithfully. When there is an S video jack on the device to be connected, connect the S video plug to that jack instead of using the yellow video plug. The audio will not be output when you connect via the S video plug alone.

Changing the SETUP display

You can change the default settings by selecting the options in the SETUP display with the multi-selector.



Select the item in the following order:
 SETUP display → icon → menu item
 → option

Menu items are displayed as the following icons. The displayed icons are different depending on the mode dial position.

-  APPLI.
-  MANUAL SET
-  VIDEO SET
-  PLAYER SET
-  CAMERA SET
-  LCD/VF SET
-  DISC SET
-  SETUP MENU
-  OTHERS

1 Turn the power on by pressing the POWER button for a few seconds.

2 Press the SETUP button.

One of the following screens appears depending on the position of the mode dial. Set the mode dial to  (Movie),  (Still), or  (Play/Edit), then press SETUP.

 (Movie)

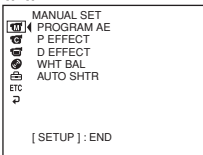

 (Still)

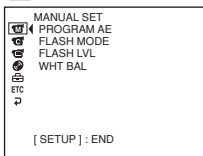

 (Play/Edit)

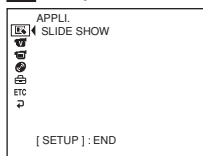

3 Use the multi-selector to select the desired icon.

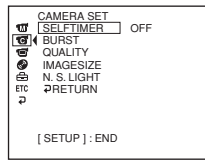

4 Use the multi-selector to select the desired item.

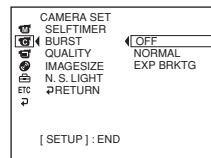

5 Use the multi-selector to select the desired mode.

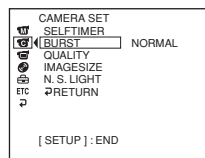

6 If you want to change other items, select [↻RETURN] using the multi-selector and press the button in the center of the multi-selector to confirm your selection, then repeat steps 3 to 5.

To return to step 3, select [↻RETURN].

For details, see "Selecting the option of each item" on the next page.













To make the SETUP display disappear
 Press SETUP.

Changing the SETUP display

Selecting the option of each item

Menu items differ depending on the position of the mode dial. The display shows only the items that are currently in effect or that you can operate at the moment.

● is the default setting.

Icon/Item	Option	Meaning	Mode dial
 MANUAL SET			
PROGRAM AE	—	To suit your specific shooting requirement (page 51).	 Movie  Still
P EFFECT	—	To add special effects like those in films or on TV to images (page 54).	 Movie
D EFFECT	—	To add special effects using the various digital functions (page 54).	 Movie
FLASH MODE*1	● ON	To fire the flash (optional), regardless of the brightness of the surroundings.	 Still
	ON  *3	To fire the flash (optional), regardless of the brightness of the surroundings. Pre-flashes before recording to reduce the red-eye phenomenon.	
	AUTO	To fire the flash (optional) automatically.	
	AUTO  *3	To fire the flash (optional) automatically. Pre-flashes before recording to reduce the red-eye phenomenon.	
FLASH LVL*1*2	HIGH	To make the flash (optional) level higher than normal setting.	 Still
	● NORMAL	Normal setting.	
	LOW	To make the flash (optional) level lower than normal setting.	
WHT BAL	—	To adjust the white balance (page 50).	 Movie  Still
AUTO SHTR	● ON	To automatically activate the electronic shutter*4 when shooting in bright conditions.	 Movie
	OFF	To not automatically activate the electronic shutter*4 in bright conditions.	











*1 You cannot adjust [FLASH MODE] and [FLASH LVL] if an external flash (optional) is not connected.

*2 You cannot adjust [FLASH LVL] if the external flash (optional) used is not compatible with the flash level.

*3 You cannot adjust these settings if the external flash (optional) used is not compatible with the red-eye reduction.

*4 An electronic shutter is the function used to adjust the shutter speed electronically.

Changing the SETUP display

Icon/Item	Option	Meaning	Mode dial
 CAMERA SET			
SELFTIMER	● OFF	To disable self-timer.	 Movie
	ON	To use self-timer (page 47).	 Still
D ZOOM	● OFF	To deactivate the digital zoom. Only up to 10X optical zoom is performed.	 Movie
	20 X	To activate the digital zoom. From 10X to 20X zoom is performed digitally (page 33).	
	120 X	To activate the digital zoom. From 10x to 120X zoom is performed digitally.	
16:9WIDE	● OFF	Not to record 16:9 Wide picture.	 Movie
	ON	To record a 16:9 Wide picture (page 48).	
STEADYSHOT	● ON	To compensate for camera-shake.	 Movie
	OFF	To cancel SteadyShot. Natural pictures are produced when shooting a stationary object with a tripod.	
BURST*	● OFF	To disable the Burst.	 Still
	NORMAL	To record up to 4 (in 1152 X 864 size) or 12 (in 640 X 480 size) still images continuously fast (page 41).	
	EXP BRKTG	To record 3 images continuously with different exposures.	
QUALITY	● FINE	To record still images in the fine image quality (page 38).	 Still
	STANDARD	To record still images in the standard image quality.	
IMAGESIZE*	● 1152 X 864	To record still images in 1152 X 864 size (page 39).	 Still
	640 X 480	To record still images in 640 X 480 size.	
N.S.LIGHT	● ON	To use NightShot Light (page 45).	 Movie
	OFF	To cancel NightShot Light .	 Still

* DCR-DVD201E only

Notes















On SteadyShot

- SteadyShot will not correct excessive camera shake.
- Attachment of a conversion lens (optional) may influence SteadyShot.

Tip

If you cancel SteadyShot, the SteadyShot off indicator  appears. Your camcorder prevents excessive compensation for camera-shake.

Changing the SETUP display

Icon/Item	Option	Meaning	Mode dial
 LCD/VF SET			
LCD BRIGHT	—	To adjust the brightness on the LCD screen with -/+.	 Movie  Still  Play/Edit
		 Darker ← → Brighter	
LCD B.L.	● BRT NORMAL	To set the brightness on the LCD screen to normal.	 Movie  Still  Play/Edit
	— BRIGHT	To brighten the LCD screen.	
LCD COLOR	—	To adjust the color on the LCD screen with -/+.	 Movie  Still  Play/Edit
		 To get low-intensity color To get high-intensity color	
VF B.L.	● BRT NORMAL	To set the brightness on the viewfinder screen to normal.	 Movie  Still  Play/Edit
	— BRIGHT	To brighten the viewfinder screen.	



Notes

On LCD B.L. and VF B.L.





- When you select [BRIGHT], battery life is reduced a little during recording.
- When you use power supplies other than the battery pack, [BRIGHT] is automatically selected.

Tip

















Even if you adjust [LCD BRIGHT], [LCD B.L.], [LCD COLOR], and/or [VF B.L.], the recorded picture will not be affected.

Icon/Item	Option	Meaning	Mode dial
 APPLI.			
SLIDE SHOW	—	To play back still images continuously (page 62).	 Play/Edit

Changing the SETUP display

Icon/Item	Option	Meaning	Mode dial
 VIDEO SET (DCR-DVD101E/DVD201E)			
 PLAYER SET (DCR-DVD91E)			
HiFi SOUND	<input checked="" type="radio"/> STEREO	To play back a stereo disc or dual sound track disc with main and sub sound.	 Play/Edit
	1	To play back a stereo disc with the left sound or a dual sound track disc with main sound.	
	2	To play back a stereo disc with the right sound or a dual sound trackdisc with sub sound.	
VIDEO INPUT*1	<input checked="" type="radio"/> VIDEO	To use the A/V connecting cable to connect your camcorder and a player.	 Play/Edit
	S VIDEO	To use the S VIDEO cable to connect your camcorder and a player.	

*1 DCR-DVD101E/DVD201E only













Icon/Item	Option	Meaning	Mode dial
 DISC SET			
REC MODE*1	HQ	To record in the HQ (High Quality) mode.	 Movie  Play/Edit
	<input checked="" type="radio"/> SP	To record in the SP (Standard Play) mode.	
	LP	To record in the LP (Long Play) mode.	
FORMAT*2	—	To format a disc (page 74).	 Movie  Still  Play/Edit
FINALIZE	—	To prohibit further recording on the disc, and make it compatible with other DVD players (page 65).	 Movie  Still  Play/Edit
UNFINALIZE*2*3	—	To make the finalized disc recordable again (page 73).	 Movie  Still  Play/Edit
DISC TITLE	—	To add an original title to the disc (page 68).	 Movie  Still  Play/Edit
FILE NO.	<input checked="" type="radio"/> SERIES	To assign numbers to files in sequence even if the disc is changed.	 Still
	RESET	To reset the file numbering each time the disc is changed.	

*1 You cannot change this option when the mode dial is set to  (Play/Edit) in DCR-DVD91E.

*2 DVD-RWs only

*3 VIDEO mode only







Changing the SETUP display

Icon/Item	Option	Meaning	Mode dial
 SETUP MENU			
CLOCK SET	—	To set the date or time (page 23).	 Movie  Still  Play/Edit
A. SHUT OFF	<input checked="" type="radio"/> 5 min	To turn the power off automatically if no operation have taken place for 5 minutes when powered by the battery pack.	 Movie  Still  Play/Edit
	<input type="radio"/> NEVER	To remain the power on even if no operation last.	
LTR SIZE	<input checked="" type="radio"/> NORMAL	To display selected menu items in normal size.	 Movie  Still  Play/Edit
	<input type="radio"/> 2 ×	To display selected menu items at twice the normal size.	
USB SPEED*1	<input checked="" type="radio"/> AUTO	To send data corresponding with the connected computer.	 Play/Edit
	<input type="radio"/> FULL-SPEED	To send data corresponding with USB 1.1 (full speed transfer).	
DEMO MODE	<input checked="" type="radio"/> ON	To make the demonstration appear.	 Movie
	<input type="radio"/> OFF	To cancel the demonstration mode.	

















*1 DCR-DVD101E/DVD201E only

Notes

On DEMO MODE

- You cannot select [DEMO MODE] when a disc is inserted in your camcorder.
- When NIGHTSHOT PLUS switch is set to ON, the ["NIGHTSHOT PLUS"] indicator appears on the LCD display and you cannot select [DEMO MODE] in the SETUP display.
- The following operations cancel the demonstration:
 - When the mode dial is set to  (Still) or  (Play/Edit).
 - When you press SETUP.
 - When the NIGHTSHOT PLUS switch is set to ON.
 - When you slide the disc cover OPEN switch.
- When [DEMO MODE] default setting is standby, the demonstration starts about 10 minutes after you have set the mode dial to  (Movie) without a disc inserted.
To cancel the demonstration, insert a disc, set the mode dial to  (Still) or  (Play/Edit), or set [DEMO MODE] to [OFF]. To set the camcorder to standby again, leave the [DEMO MODE] at [ON] in the menu settings, press the POWER button to OFF (CHG), and then return the POWER button to ON and the mode dial to  (Movie).

Changing the SETUP display

Icon/Item	Option	Meaning	Mode dial
ETC OTHERS			
DATA CODE (operation on the Remote Commander)	● DATE/CAM	To change the display in the order of the date and time → the camera data → the display each time pressing DATA CODE (page 59).	▢ Play/Edit
	DATE	Press DATA CODE on the Remote Commander to display date and time during playback.	
AREA SET	—	To set your local area.	 Movie  Still  Play/Edit
DST SET	● OFF	To cancel the use of daylight savings time.	 Movie  Still  Play/Edit
	ON	To use the daylight savings time.	
BEEP	● MELODY	To output a melody when you start/stop recording or when an unusual condition occurs on your camcorder.	 Movie  Still  Play/Edit
	NORMAL	To output the beep instead of the melody.	
	OFF	To cancel the melody, beep sound and shutter sound.	
COMMANDER	● ON	To activate the Remote Commander supplied with your camcorder.	 Movie  Still  Play/Edit
	OFF	To deactivate the Remote Commander to avoid erroneous remote control operation caused by other equipments' remote control.	
DISPLAY	● LCD	To show the display on the LCD screen and in the viewfinder.	 Movie  Still  Play/Edit
	V-OUT/LCD	To show the display also on the TV screen.	
REC LAMP	● ON	To light up the camera recording lamp on the front of your camcorder during recording.	 Still  Movie
	OFF	To turn the camera recording lamp off so that the subject is not aware of the recording.	

Changing the SETUP display

Icon/Item	Option	Meaning	Mode dial
ETC OTHERS			
REMAIN	AUTO	<p>To display the remaining capacity of the disc in the following cases for example:</p> <ul style="list-style-type: none"> • For 8 seconds after setting the power on and the mode dial to (Movie) or (Still). • For 8 seconds after recognizing the inserted disc into your camcorder in (Movie) or (Still). • For 8 seconds when set the display to on by pressing DISPLAY/BATT INFO in (Movie) or (Still). • When the remaining capacity of the disc is less than 5 minutes in (Movie) or 20 in (Still) • For 8 seconds when starting recording from the line input (DCR-DVD101E/DVD201E only). 	Movie Still Play/Edit
	ON	To always display the remaining capacity of the disc.	

Notes

- If you press DISPLAY/BATT INFO with [DISPLAY] set to [V-OUT/LCD] in the SETUP display, the picture from a TV or VCR will not appear on the LCD display even when your camcorder is connected to outputs on the TV or VCR.
- If more than 5 minutes passes after removing the power source, the [PROGRAM AE], [FLASH LVL], [WHT BAL], [COMMANDER], and [HiFi SOUND] settings are returned to their factory settings. Other settings are held in memory even when the battery is removed.



Tip

When recording a close subject, if [REC LAMP] is set to [ON], the red camera recording lamp on the front of the camcorder may reflect on the subject. In this case, it is recommended to set [REC LAMP] to [OFF].

Types of trouble and corrective action

If you run into problems using your camcorder, use the following table to troubleshoot the problem. If the problem persists, disconnect the power source and contact your Sony dealer or local authorized Sony service facility. If "C:□□:□□" appears on the LCD display, the self-diagnosis display function is working. See page 125.

About overall operations

Symptom	Cause and/or Corrective Actions
The power does not turn on.	<ul style="list-style-type: none"> The battery pack is not installed, or is exhausted or nearly exhausted. <ul style="list-style-type: none"> → Install a charged battery pack. (page 15) The AC adaptor is not connected to a wall socket. <ul style="list-style-type: none"> → Connect the AC adaptor to a wall socket. (page 18)
Your camcorder vibrates.	<ul style="list-style-type: none"> Vibration occurs depending on the condition of the disc. This is not a malfunction.
The  indicator flashes.	<ul style="list-style-type: none"> Moisture condensation has occurred. <ul style="list-style-type: none"> → Turn off your camcorder and leave it for at least an hour to acclimatize it. (page 132)
The  indicator flashes.	<ul style="list-style-type: none"> The temperature of your camcorder is extremely high. <ul style="list-style-type: none"> → Turn off your camcorder and leave it for a while in a cool place.
A motor sound is heard from your camcorder periodically.	<ul style="list-style-type: none"> The sound is caused by the disc. This is not a malfunction.
A vibration is felt in your hand or a faint sound is heard during operation.	<ul style="list-style-type: none"> This is caused by the disc drive. This is not a malfunction.
Your camcorder gets hot during use for a long period.	<ul style="list-style-type: none"> This is not a malfunction.
The Remote Commander supplied with your camcorder does not work.	<ul style="list-style-type: none"> [COMMANDER] is set to [OFF] in  (OTHERS) in the SETUP display. <ul style="list-style-type: none"> → Set it to [ON]. (page 116) Something is blocking the infrared rays. <ul style="list-style-type: none"> → Remove the obstacle. The battery is inserted in the battery holder with the +/- polarities incorrectly matching the +/- marks. <ul style="list-style-type: none"> → Insert the battery correctly. (page 143) The battery is dead. <ul style="list-style-type: none"> → Replace with new ones. (page 143)
No functions work although the power is on.	<ul style="list-style-type: none"> The temperature of your camcorder is extremely high. <ul style="list-style-type: none"> → Turn off your camcorder and leave it for a while in a cool place. Your camcorder was applied a strong shock or vibration. <ul style="list-style-type: none"> → Your camcorder may be damaged. Contact your Sony dealer or local authorized Sony service facility. → Remove the power sources such as the AC adaptor or the battery pack, and turn on the power again about 1 minute later. When you still can not operate your camcorder, push the RESET button using an object with the point sharpened, it releases all the setting includes date and time to the default.



Types of trouble and corrective action

About the power source

Symptom	Cause and/or Corrective Actions
The battery pack is quickly discharged.	<ul style="list-style-type: none">• The operating temperature is too low.• The battery pack is not fully charged. → Charge the battery pack fully again. (page 16)• The battery pack is completely dead, and cannot be recharged. → Replace with a new battery pack. (page 15)
The battery remaining time indicator does not indicate the correct time.	<ul style="list-style-type: none">• You have used the battery pack in an extremely hot or cold environment for a long time.• The battery pack is completely dead, and cannot be recharged. → Replace it with a new battery pack. (page 15)• The battery pack is exhausted. → Install a fully charged battery pack. (page 15)• A problem has occurred in the display of the remaining battery time. → Charge the battery pack fully again so that the indication on the remaining battery time indicator is correct. (page 16)
You cannot charge the battery pack.	<ul style="list-style-type: none">• The POWER is on. → Turn it off (CHG) by pressing the POWER button for a few seconds. (page 19)
The power goes off although the remaining battery time indicator indicates that the battery pack has enough power to operate.	<ul style="list-style-type: none">• A problem has occurred in the display of the remaining battery time. → Charge the battery pack fully again so that the indication on the remaining battery time indicator is correct. (page 16)• Battery pack performance decreases in low-temperature surroundings and recording may not be possible even though the battery time remaining may be as much as 20 minutes. → Recharge the battery pack fully. (page 16)
While charging the battery pack, POWER/CHG lamp does not light.	<ul style="list-style-type: none">• The battery charge is completed.• The battery pack is not properly installed. → Install it properly. (page 15)
While charging the battery pack, the POWER/CHG lamp flashes.	<ul style="list-style-type: none">• The battery pack is not properly installed. → Install it properly. (page 15)• Something is wrong with the battery pack. → If the symptom persists, disconnect the plug from the wall socket as soon as possible to cut off the power, and contact your Sony dealer or local authorized Sony service facility.

Types of trouble and corrective action

About the disc





Symptom	Cause and/or Corrective Actions
Remaining disc space indicator is not displayed.	<ul style="list-style-type: none">• The [ REMAIN] item is set to [AUTO] in  (OTHERS) in the SETUP display.<ul style="list-style-type: none">→ Set it to [ON] to always display the remaining disc space indicator. (page 117)
The disc cannot be ejected.	<ul style="list-style-type: none">• The battery pack or the AC adaptor are not installed/connected.<ul style="list-style-type: none">→ Install/connect the power source correctly.• The battery pack is exhausted.<ul style="list-style-type: none">→ Install a charged battery pack.• Moisture condensation has occurred.<ul style="list-style-type: none">→ Turn off your camcorder and leave it for at least an hour to acclimatize it. (page 132)• Finalizing is interrupted by turning off your camcorder.<ul style="list-style-type: none">→ Turn on your camcorder and eject the disc after finalizing is completed.• The temperature of your camcorder is extremely high.<ul style="list-style-type: none">→ Turn off your camcorder and leave it for a while in a cool place.
The disc cannot be recorded additionally on other devices.	<ul style="list-style-type: none">• The disc recorded on your camcorder may not be recorded additionally on other devices.

About the LCD display or the viewfinder



Symptom	Cause and/or Corrective Actions
An unknown picture is displayed on the LCD display.	<ul style="list-style-type: none">• If 10 minutes elapse after you set the mode dial to  (Movie) without a disc inserted, your camcorder automatically starts the demonstration.<ul style="list-style-type: none">→ Insert a disc and the demonstration stops. You can also cancel DEMO MODE. (page 115)
The image on the viewfinder screen is not clear.	<ul style="list-style-type: none">• The viewfinder lens is not adjusted.<ul style="list-style-type: none">→ Adjust the viewfinder lens. (page 22)
The picture does not appear in the viewfinder.	<ul style="list-style-type: none">• The LCD screen is open.<ul style="list-style-type: none">→ Close the LCD screen.
Characters on the LCD display turn over.	<ul style="list-style-type: none">• When using the mirror mode, characters turn over on the LCD display and on the TV monitor connected with the AUDIO/VIDEO jack. This is not a malfunction.
A image is left on the LCD display.	<ul style="list-style-type: none">• It will occurs when you remove the battery pack or unplug the DC plug when the power of your camcorder is on. This is not a malfunction.

Types of trouble and corrective action



During recording

Symptom	Cause and/or Corrective Actions
Pressing START/STOP or PHOTO does not record movies/still images.	<ul style="list-style-type: none">• The mode dial is set to  (Play/Edit). → Set it to  (Movie) or  (Still). (page 29, 35)• The disc has run out of space. → Use a new disc or format the disc. (DVD-RW only, page 74)• The disc has been finalized. → Unfinalize the disc (DVD-RW only) or use a new disc. (page 73)• Shooting by swapping movies and still images frequently reduces the remaining capacity of the disc and may prevent you from shooting movies.
The power goes off.	<ul style="list-style-type: none">• Your camcorder powered by the battery pack turns off for more than 5 minutes with no operations performed. → Press the POWER button for a few seconds. → Set [A. SHUT OFF] to [NEVER] in  (SETUP MENU) in the SETUP display. (page 115)• The battery pack is exhausted or nearly exhausted. → Install a charged battery pack. (page 15)
SteadyShot does not work.	<ul style="list-style-type: none">• [STEADYSHOT] is set to [OFF] in  (CAMERA SET) in the SETUP display. → Set it to [ON]. (page 112)
Autofocus does not work.	<ul style="list-style-type: none">• The setting is set to manual focus. → Press FOCUS to set the autofocus. (page 52)• Shooting conditions are not suitable for autofocus. → Adjust the focus manually. (page 52)
A vertical band appears when you shoot a subject such as lights or a candle flame against a dark background.	<ul style="list-style-type: none">• The contrast between the subject and background is too high. This is not a malfunction.
A vertical band appears when you shoot a very bright subject.	<ul style="list-style-type: none">• This is not a malfunction.
Some tiny white, red, blue or green spots appear on the display.	<ul style="list-style-type: none">• Super NightShot plus or Color Slow Shutter is activated. This is not a malfunction.

Types of trouble and corrective action

Symptom	Cause and/or Corrective Actions
The picture flickers and the color changes incorrectly.	<ul style="list-style-type: none"> PROGRAM AE is set to [PORTRAIT] or [SPORTS] lesson under the fluorescent lamp, the sodium lamp and the mercury lamp. → Cancel PROGRAM AE. (page 51)
The picture is recorded in incorrect or unnatural colors.	<ul style="list-style-type: none"> NIGHTSHOT PLUS switch is set to ON. → Set it to OFF. (page 45)
The picture appears too bright, and the subject does not appear on the LCD display.	<ul style="list-style-type: none"> NIGHTSHOT PLUS switch is set to ON in a bright place. → Set it to OFF. (page 45) BACK LIGHT (☀) is activated. → Deactivate it. (page 43)
The click of the shutter does not sound.	<ul style="list-style-type: none"> [BEEP] is set to [OFF] in  (OTHERS) in the SETUP display. → Set it to [MELODY] or [NORMAL]. (page 116)
Black bands appear when you record a TV or computer screen.	<ul style="list-style-type: none"> → Set [STEADYSHOT] to [OFF] in  (CAMERA SET) in the SETUP display. (page 112)
The recording stops.	<ul style="list-style-type: none"> The temperature of your camcorder is extremely high. → Turn off your camcorder and leave it for a while in a cool place.

During playback on your camcorder



Symptom	Cause and/or Corrective Actions
The disc cannot be played back.	<ul style="list-style-type: none"> There is no disc inserted in the camcorder. → Insert a disc. (page 26) The disc is inserted upside down. → Insert the disc correctly. The mode dial is set to  (Movie) or  (Still). → Set the mode dial to  (Play/Edit). The incompatible disc is inserted. → Check out the disc compatibility. (page 6) The disc recorded in other devices is inserted. → The disc recorded in other devices may not be played back on your camcorder.
The playback picture is distorted.	<ul style="list-style-type: none"> The disc may be dirty. → Clean the disc using the cleaning cloth (supplied). (page 129)
No sound or only a low sound is heard when playing back a disc.	<ul style="list-style-type: none"> The volume is turned to minimum. → Turn up the volume. (page 56) The LCD screen is closed. → Open the LCD screen.

Types of trouble and corrective action

During playback of a disc on other players

Symptom	Cause and/or Corrective Actions
Can not be played back or the disc can not be recognized.	<ul style="list-style-type: none"> The disc may be dirty. → Clean it with the supplied cleaning cloth. The disc is not finalized. → Finalize it. (page 65) You are trying to play back a disc recorded in VR mode with an equipment which is not compatible with the VR mode. → You cannot playback the disc with this equipment.
The picture is distorted.	<ul style="list-style-type: none"> The disc may be dirty. → Clean it with supplied cleaning cloth.
Playback freezes for an instant between the scenes.	<ul style="list-style-type: none"> The image may freeze for an instant between scenes depending on the DVD player being used.
Playback does not move to the previous scene when you press ◀◀ .	<ul style="list-style-type: none"> If playback crosses 2 titles made automatically by your camcorder when ◀◀ is pressed, playback may not move to the previous scene. → Select the desired scene from the menu screen. Refer to the instruction manual for further information.

During editing

Symptom	Cause and/or Corrective Actions
The edit display is not displayed even though you press EDIT.	<ul style="list-style-type: none"> The mode dial is set to  (Movie) or  (Still). → Set the mode dial to  (Play/Edit). A DVD-R is inserted. → DVD-R cannot be edited. Insert DVD-RW. The inserted DVD-RW is formatted in VIDEO mode. → Format the DVD-RW in VR mode. Note that all the recorded data are deleted if you format the disc.
Scenes cannot be registered in the Playlist.	<ul style="list-style-type: none"> The registered scenes exceed 999. → Delete unnecessary scenes or register all the still images by converting them to a movie. (page 79, 80) The disc is full. → Delete unnecessary scenes. (page 89)
A movie cannot be divided.	<ul style="list-style-type: none"> A movie that is too short cannot be divided. Still images converted to a movie cannot be divided. A movie protected on another device cannot be divided. → Cancel the protection of the movie on the device used to protect the movie.
A scene cannot be deleted.	<ul style="list-style-type: none"> A scene protected on another device cannot be deleted. → Cancel the protection of the scene on the device used to protect the scene.
Editing is disabled.	<ul style="list-style-type: none"> Another device was used for editing the disc. → Another device may not be able to edit a disc recorded on your camcorder.

Types of trouble and corrective action

Others

Symptom	Cause and/or Corrective Actions
The disc title cannot be changed.	<ul style="list-style-type: none">• The disc has been finalized. → Unfinalize the disc (DVD-RW only). You cannot record a disc title on a finalized DVD-R.• The disc title has been made by another device. → The disc title may not be changed on your camcorder if the disc title has been made by another device.
Still images cannot be converted to a movie.	<ul style="list-style-type: none">• When too many still images are recorded, the remaining of the disc is reduced and still images cannot be converted to a movie. → Delete unnecessary scenes in the disc. (page 89)
The picture from a TV or VCR does not appear even when your camcorder is connected to output on the TV or VCR.	<ul style="list-style-type: none">• [DISPLAY] is set to [V-OUT/LCD] in  (OTHERS) in the SETUP display. → Set it to [LCD]. (page 116)• The Visual Index display is displayed. → Press VISUAL INDEX. The display disappears.
The melody or beep sounds for 5 seconds.	<ul style="list-style-type: none">• Moisture condensation has occurred. → Turn off your camcorder and leave it for at least an hour to acclimatize it. (page 132)• Some problems have occurred in your camcorder. → Remove the disc and insert it again, then operate your camcorder again.
Scene can not be saved in the computer using the USB connection.	<ul style="list-style-type: none">• The USB cable was connected before installation of the USB driver was completed. → Install the USB driver again. (page 98)

Self-diagnosis display

Your camcorder has a self-diagnosis display function.

This function displays the current state of your camcorder as a 5-digit code (a combination of a letter and figures), on the LCD display or in the viewfinder. If a 5-digit code is displayed, check the following list of codes. The last 2 digits (indicated by □□) differ depending on the state of your camcorder.

LCD display or viewfinder

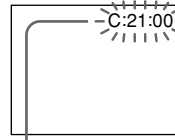

Self-diagnosis display

- C:□□:□□
You can service your camcorder yourself.
- E:□□:□□
Contact your Sony dealer or local authorized Sony service facility.

5-digit display	Cause and/or Corrective Actions
C:04:□□	<ul style="list-style-type: none"> • You are using a battery pack that is not an "InfoLITHIUM" battery pack. → Use an "InfoLITHIUM" battery pack. (page 16, 130)
C:13:□□	<ul style="list-style-type: none"> • The disc is faulty. → Use a compatible disc with your camcorder. (page 6)
C:21:□□	<ul style="list-style-type: none"> • Moisture condensation has occurred. → Turn off your camcorder and leave your camcorder for at least an hour to acclimatize it. (page 132)
C:31:□□ C:32:□□	<ul style="list-style-type: none"> • A malfunction that you can service yourself other than those above has occurred. → Remove the disc and insert it again, then operate your camcorder again. → Disconnect the mains lead of the AC adaptor or remove the battery pack. After reconnecting/reinstalling the power supply, operate your camcorder.
E:20:□□ E:61:□□ E:62:□□ E:93:□□ E:94:□□	<ul style="list-style-type: none"> • A malfunction that you cannot service has occurred. → Contact your Sony dealer or local authorized Sony service facility and inform them of the 5-digit code. (example: E:61:10)

If you are unable to rectify the problem even if you try the suggested corrective actions a few times, contact your Sony dealer or local authorized Sony service facility.

Warning indicators

If indicators appear on the LCD display or in the viewfinder, check the following:
See the page in parentheses “()” for more information.

100-0001 **Warning indicator referring to a file**

Slow flashing:

- The file is corrupted.
- The file is unreadable on your camcorder.



C:21:00 **Self-diagnosis display** (page 125)

Warning indicator referring to the disc

Slow flashing:

- A disc is not inserted.*
- The remaining time for recording movies is less than 5 minutes.
- The remaining amount of space for recording still images will be accommodated fewer than 20 images.
- The disc recorded in the different TV color system from your camcorder is inserted.*

Fast flashing:

- An unrecognizable disc is inserted.*
- A finalized disc is inserted in VIDEO mode when the mode dial is set to  (Movie) or  (Still).
- The disc is fully recorded.*
- A disc containing copy protection signals is inserted.*
- A disc that cannot be read or written is inserted, such as the single-sided disc inserted inside out.

You need to eject the disc*

Fast flashing:

- An unrecognizable disc is inserted.
- The disc is fully recorded.
- A disc containing copy protection signals is inserted.
- The disc recorded in the different TV color system from your camcorder is inserted.

Warning indicator referring to the disc

Fast flashing:

- An unrecognizable disc is inserted.

The battery pack is dead or nearly dead

Slow flashing:

- The battery pack is exhausted.
Depending on the operating conditions, or the environment and battery condition, the  indicator may flash even if there are approximately 20 minutes remaining.

Fast flashing:

- The battery error occurs.

Moisture condensation has occurred*

Fast flashing:

- Moisture condensation has occurred with the disc.
Turn off your camcorder and leave it for at least an hour to acclimatize it. (page 132)

Warning indicator referring to the temperature rise

Fast flashing:

- The temperature of your camcorder is extremely high.*

Slow flashing:

- The temperature of your camcorder is getting higher.

Warning indicator referring to the flash (optional)

Slow flashing:









- The flash is charging.*

Fast flashing:



- There is a problem with the flash (optional).

* You hear the melody or beep sound.

Warning messages

Message	Cause and/or Corrective Actions
FOR "InfoLITHIUM" BATTERY ONLY	<ul style="list-style-type: none"> • Use an "InfoLITHIUM" battery pack.
	<ul style="list-style-type: none"> • Install a charged battery pack. • The battery pack is completely dead, and cannot be recharged. <ul style="list-style-type: none"> → Replace it with a new battery pack.
 *1	<ul style="list-style-type: none"> • Moisture condensation has occurred. <ul style="list-style-type: none"> → Turn off your camcorder and leave it for at least an hour to acclimatize it. (page 132)
 CANNOT OPEN TRY LATER*1	<ul style="list-style-type: none"> • Moisture condensation is occurred. <ul style="list-style-type: none"> → Turn off your camcorder and leave it for at least an hour to acclimatize it, then remove the disc.
 *1	<ul style="list-style-type: none"> • The temperature of your camcorder is extremely high. <ul style="list-style-type: none"> → Turn off your camcorder and leave it for a while in a cool place.
 CANNOT OPEN TRY LATER*1	<ul style="list-style-type: none"> • The temperature of your camcorder is extremely high. <ul style="list-style-type: none"> → Turn off your camcorder and leave it in a cool place for at least an hour to acclimatize it, then remove the disc.
REC. DISABLE*1	<ul style="list-style-type: none"> • A malfunction has occurred with the disc and you cannot record any movies or still images on the disc.
CAPACITY FULL FOR MOVIE*1	<ul style="list-style-type: none"> • The disc is full for recording movies. <ul style="list-style-type: none"> → Use a new disc.
SCENE NUMBER FULL*1	<ul style="list-style-type: none"> • Your camcorder can record up to 98 titles of movies in VIDEO mode and up to 999 chapters in VR mode per disc. • Your camcorder can record up to 9999 still images per disc.
  DISC FULL*1	<ul style="list-style-type: none"> • The disc has run out of space. <ul style="list-style-type: none"> → Use a new disc.
PLAYBACK PROHIBITED*1	<ul style="list-style-type: none"> • You cannot playback a incompatible disc with your camcorder.
EDIT DISABLE*1	<ul style="list-style-type: none"> • A blank disc cannot be edited.
DISC IS ALREADY FINALIZED*1	<ul style="list-style-type: none"> • The disc is already finalized.
FINALIZED DISC, USE ANOTHER DISC*1	<ul style="list-style-type: none"> • A finalized DVD-R cannot be recorded.
NEED TO UNFINALIZE*1	<ul style="list-style-type: none"> • To record on the finalized DVD-RW in VIDEO mode, unfinalize it.
 CLOSE DISC COVER	<ul style="list-style-type: none"> • The disc cover is open. <ul style="list-style-type: none"> → Close the disc cover.
 NO DISC	<ul style="list-style-type: none"> • There is no disc inserted. <ul style="list-style-type: none"> → Insert a disc. • The disc is not set correctly. <ul style="list-style-type: none"> → Set the disc correctly. (page 26)
CANNOT RECOVER DATA*1*2	<ul style="list-style-type: none"> • The data cannot be recovered. <ul style="list-style-type: none"> → Use a new disc.
NEED TO FORMAT DISC*1*2	<ul style="list-style-type: none"> • The data cannot be recovered. <ul style="list-style-type: none"> → Format the disc (DVD-RW only).

Warning messages



Message	Cause and/or Corrective Actions
DISC PROTECTED*1	<ul style="list-style-type: none">• A disc protected on another device cannot be edited. → Cancel the protection of the disc on the device used to protect the disc.
COPY INHIBIT*1	<ul style="list-style-type: none">• Copyright protected movies and sounds cannot be recorded on your camcorder.
  DISC ERROR*1	<ul style="list-style-type: none">• The incompatible disc with your camcorder is inserted.• Your camcorder cannot recognize the disc because of malfunctions such as scratches.• The disc is not set correctly. → Set the disc correctly. (page 26)
FORMAT ERROR*1	<ul style="list-style-type: none">• The disc recorded in the different format code from your camcorder. → Formatting the disc may enable you to use the disc on your camcorder (DVD-RW only).
ACCESS ERROR*1	<ul style="list-style-type: none">• An error occurred during reading or writing the disc.
 NOW CHARGING*1	<ul style="list-style-type: none">• You cannot operate your camcorder during charging the flash.

*1 You hear the beep sound when the message appears.

*2 If the data is not recorded correctly, your camcorder automatically recovers data when turn on the power.

About the disc

Usable discs

You can use 8 cm DVD-R and 8 cm DVD-RW discs only. Use the discs with  or .

Note

We recommend you to use the Sony discs which is confirmed compatibility with your camcorder. Refer to page 6 about the recommended discs.

Notes on use

- Hold the disc by its edge while supporting the center hole lightly. Do not touch the recording side (the opposite of the printed side) of a disc.

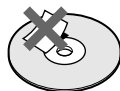

- Before shooting, be sure to remove dust and fingerprints from the disc with the cleaning cloth supplied with your camcorder. Otherwise you may not be able to record or play normally in some situation using that disc.
- When you set the disc to your camcorder, press firmly until it clicks. When the message [C:13:□□] appears on the LCD screen, open the disc cover and set the disc again.
- Do not attach any adhesive material such as a sticker on the surface of a disc. If you do so, the disc may become unbalanced, and this may cause a malfunction of the disc or your camcorder.

Care and storage of the discs

- Keep the disc clean, or the quality of the audio and video output is lessend.
- Clean the disc with a supplied cleaning cloth. Wipe the disc from the center out. For dirt, clean the disc with a soft cloth slightly moistened in water, then remove the moisture with a soft, dry cloth. Do not use solvents such as benzine, cleaners intended for vinyl LPs or antistatic splay, as they may cause a malfunction to the disc.



- Do not expose the disc to direct sunlight or leave it in a humid place.
- When you carry or store the disc, put it in its case.
- You can write only on a printed side using an oil-based marker with a felt-tip, and do not touch the ink until it dries. Do not heat the disc or use a sharp-pointed tool, such as ball point pen. Do not dry the surface by heating.

About the “InfoLITHIUM” battery pack

This unit is compatible with the “InfoLITHIUM” battery pack (M series). Your camcorder operates only with the “InfoLITHIUM” battery pack. “InfoLITHIUM” M series battery packs have the  mark.

What is the “InfoLITHIUM” battery pack?

The “InfoLITHIUM” battery pack is a lithium-ion battery pack that has functions for communicating information related to operating conditions between the battery pack and an AC adaptor/charger (optional). The “InfoLITHIUM” battery pack calculates the power consumption according to the operating conditions of your camcorder, and displays the remaining battery time in minutes.

With an AC adaptor/charger (optional), the remaining battery time and charging time are displayed.

Charging the battery pack

- Be sure to charge the battery pack before you start using your camcorder.
- It is recommended to charge the battery pack in an ambient temperature of between 10°C to 30°C until POWER/CHG (Charge) lamp turns off. If you charge the battery pack outside of this temperature range, you may not be able to efficiently charge the battery pack.
- After charging is completed, either disconnect the cable from the DC IN jack on your camcorder or remove the battery pack.

Effective use of the battery pack

- Battery pack performance decreases in low-temperature surroundings and recording may not be possible even though the battery time remaining may be as much as 20 minutes. We recommend the following to ensure longer battery pack use:
 - Put the battery pack in a pocket close to your body to warm it up, and insert it in your camcorder immediately before you start taking shots.
 - Use a large capacity battery pack (NP-QM71/QM71D/QM91/QM91D, optional).
- Frequently using the LCD screen or frequently operating playback, fast forward or backward wears out a battery pack faster. It is recommended that you use the large capacity battery pack (NP-QM71/QM71D/QM91/QM91D, optional).

- Be sure to press the POWER button for a few seconds and turn off the power when not shooting or playing back on your camcorder. The battery pack is also consumed when your camcorder is in the standby mode or playback is paused.
- Have spare battery packs handy for 2 or 3 times the expected recording time, and make a trial recording on DVD-RW before the actual recording.
- Do not expose the battery pack to water. The battery pack is not water-resistant.

Remaining battery time indicator

- If the power goes off even though the remaining battery time indicator indicates that the battery pack has enough power to operate, charge the battery pack fully again so that the indication on the remaining battery time indicator is correct. Note, however, that the correct battery indication sometimes will not be restored if the battery is used in high temperatures for a long time or left in a fully charged state, or the battery pack is used frequently. Regard the remaining battery time indication as the approximate shooting time.
- The  mark indicating that there is little remaining battery time sometimes flashes depending on the operating conditions or ambient temperature and environment even if the remaining battery time is approximately 20 minutes.

How to store the battery pack

- If the battery pack is not used for a long time, perform the following procedure once per year to maintain proper battery function.
 1. Fully charge the battery pack.
 2. Discharge it using your camcorder.
 3. Remove the battery from the camcorder and store it in a dry, cool place.
- To use the battery pack up on your camcorder, leave your camcorder in the recording standby without a disc inserted with the [A. SHUT OFF] to [NEVER] in the  (SETUP MENU) in the SETUP display until the power goes off.

Battery life

- The battery life is limited. Battery capacity drops little by little as you use it more and more, and as time passes. When the available battery time is shortened considerably, a probable cause is that the battery pack has reached the end of its life. Buy a new battery pack.
- The battery life varies according to how it is stored, the operating conditions, and the environment in which each battery pack is used.

Using your camcorder abroad

You can use your camcorder with the AC adaptor supplied with it in any area with 100 V to 240 V AC, 50/60 Hz power standards.

Your camcorder is a PAL system-based camcorder. If you want to view the playback picture on a TV, it must be a PAL system-based TV with the AUDIO/VIDEO input jack. The following lists show TV color systems used overseas.

PAL system

Australia, Austria, Belgium, China, Czech Republic, Denmark, Finland, Germany, Holland, Hong Kong, Hungary, Italy, Kuwait, Malaysia, New Zealand, Norway, Poland, Portugal, Singapore, Slovak Republic, Spain, Sweden, Switzerland, Thailand, United Kingdom, etc.

PAL-M system

Brazil

PAL-N system

Argentina, Paraguay, Uruguay

SECAM system

Bulgaria, France, Guiana, Iran, Iraq, Monaco, Russia, Ukraine, etc.

NTSC system

Bahama Islands, Bolivia, Canada, Central America, Chile, Colombia, Ecuador, Guyana, Jamaica, Japan, Korea, Mexico, Peru, Samoa, Surinam, Taiwan, the Philippines, the U.S.A., Venezuela, etc.

Maintenance information and precautions

Moisture condensation

If your camcorder is brought directly from a cold place to a warm place, moisture may condense inside your camcorder, on the surface of the disc, or on the lens. This may cause a malfunction to your camcorder. If there is moisture inside your camcorder, the following indicator appears for 5 seconds.

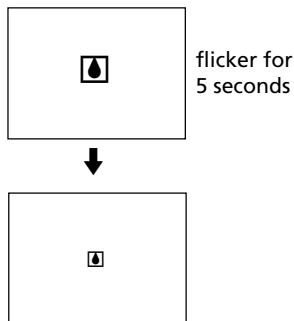

If moisture condensation has occurred

Turn off your camcorder, and leave it for about an hour.

Note on moisture condensation

Moisture may condense when you bring your camcorder from a cold place into a warm place (or vice versa) or when you use your camcorder in a hot place as follows:

- You bring your camcorder from a ski slope into a place warmed up by a heating device.
- You bring your camcorder from an air-conditioned car or room to a hot place outside.
- You use your camcorder after a squall or a shower.
- You use your camcorder in a hot and humid place.

You may not use the recording and playback functions correctly in the above cases.

How to prevent moisture condensation

When you bring your camcorder from a cold place into a warm place, put your camcorder in a plastic bag and tightly seal it. Remove the bag when the air temperature inside the plastic bag has reached the surrounding temperature (after about an hour).

Precautions

Camcorder operation

- Operate your camcorder on 7.2 V (battery pack) or 8.4 V (AC adaptor) power.
- For DC or AC operation, use the accessories recommended in these operating instructions.
- If any solid object or liquid gets inside the casing, unplug your camcorder and have it checked by a Sony dealer before operating it any further.
- Avoid rough handling or mechanical shock. Be particularly careful of the lens.
- Keep the POWER to off when you are not using your camcorder.
- Do not wrap your camcorder with a towel, for example, and operate it. Doing so might cause heat to build up inside.
- Do not touch the LCD display with your fingers or a sharp-pointed object.
- If your camcorder is used in a cold place, a residual image may appear on the LCD display. This is not a malfunction.
- While using your camcorder, the back of the LCD screen may heat up. This is not a malfunction.

On placement

Regardless of whether it is in use or not, avoid leaving your camcorder in the following locations. Doing so may cause a malfunction.

- In locations subject to extremely high temperatures.
Under the hot sun or inside a car when the windows are closed in summer, your camcorder may be subjected to too much heat, and this may cause the outer casing to lose its shape, or cause the camcorder to malfunction.
- Under direct sunlight or near a heater
This may cause the outer casing to lose its shape, or cause the camcorder to malfunction.
- In locations subject to strong vibration and magnetic fields.
- In locations subject to strong electric wave and radio wave.
The recording may not be done correctly.

Maintenance information and precautions

- Near a AM receivers and video equipment.
Noise may occur.
- In sandy or dusty places
Sand or dust may cause your camcorder to malfunction, and sometimes this malfunction cannot be repaired.
- Avoid exposing the viewfinder and the LCD screen to direct sunlight
The internal mechanisms of the viewfinder and the LCD display may be damaged.

If your camcorder is not to be used for a long time

Remove the disc. Periodically turn on the power, operate the movie and still images functions and play back a disc for about 3 minutes.

On the LCD display

- Do not press the LCD display firmly. Blurs appear and it causes a malfunction of the LCD display.
- When you use the camcorder in a cold place, the picture may seem to be trailed. This is not malfunction.
- The temperature around the LCD display may get higher while you use the camcorder. This is not malfunction.
- If fingerprints or dust make the LCD display dirty, use the cleaning cloth (supplied) to clean the LCD display.
When using the LCD Cleaning Kit (optional), do not pour the cleaning liquid directly on the LCD display, but pour the liquid on a sheet of cleaning paper and wipe the LCD display gently.

On cleaning the casing

- Clean the camcorder body with a soft cloth lightly moistened with water or tepid water, and finish with a dry cloth.
- To prevent the camcorder body from being damaged, avoid followings;
 - To use the chemical products such as thinner, benzine, alcohol, chemical cloth, volatile material like an insecticide for cleaning.
 - To operate your camcorder by the hand with the above materials.
 - To leave the case in contact with rubber or vinyl objects for a long period of time.

On the pickup lens

- Do not touch the lens inside the disc cover.
Keep the disc cover closed except when inserting and ejecting the disc, to keep dust out.

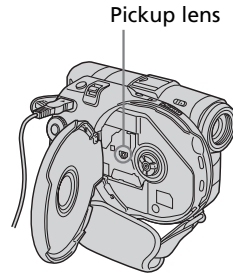

- When the camcorder does not work because the pickup lens is dirty, clean it with a blower (not supplied). Do not touch the pickup lens directly during cleaning because this may cause the camcorder to malfunction.

Care and storage of the camera lens

- Wipe the surface of the lens clean with a soft cloth in the following instances:
 - When there are fingerprints on the lens surface.
 - In hot or humid locations.
 - When the lens is exposed to salty air such as at the seaside.
- Store in a well-ventilated location subject to little dirt or dust.
- To prevent molds periodically clean the lens as described above.

It is recommended you operate your camcorder about once a month to keep it in an optimum state for a long time.

AC adaptor

- Unplug the unit from the wall socket when you are not using it for a long time. To disconnect the mains lead, pull it out by the plug. Never pull the mains lead itself.
- Do not operate the unit with a damaged cord or if the unit has been dropped or damaged.
- Do not bend the mains lead forcibly, or place a heavy object on it. This will damage the cord and may cause fire or electric shock.
- Prevent metallic objects from coming into contact with the metal parts of the connecting section. If this happens, a short may occur and the unit may be damaged.
- Always keep metal contacts clean.
- Do not disassemble the unit.
- Do not apply mechanical shock or drop the unit.
- While the unit is in use, particularly during charging, keep it away from AM receivers and video equipment. AM receivers and video equipment disturb AM reception and video operation.
- The unit becomes warm during use. This is not a malfunction.
- Do not place the unit in locations that are:
 - extremely hot or cold.
 - dusty or dirty.
 - very humid.
 - vibrating.

Rechargeable battery pack

- Use only the specified charger or video equipment with the charging function.
- To prevent an accident from a short circuit, do not allow metal objects to come into contact with the battery terminals.
- Keep the battery pack away from fire.
- Never expose the battery pack to temperatures above 60°C, such as in a car parked in the sun or under direct sunlight.
- Keep the battery pack dry.
- Do not expose the battery pack to any mechanical shock.
- Do not disassemble or modify the battery pack.
- Attach the battery pack to the video equipment securely.

Charging the built-in rechargeable battery in your camcorder

A built-in rechargeable battery is installed in your camcorder to retain the date and time, etc., regardless of the setting of the POWER button. The built-in rechargeable battery is always charged as long as you are using your camcorder. The battery, however, will become discharged gradually if you do not use your camcorder. It will be completely discharged in **about 3 months** if you do not use your camcorder at all. Even if the built-in rechargeable battery is not charged, it will not affect camcorder operation. To retain the date, time, and other information, charge the battery if it is discharged.

Charging the built-in rechargeable battery:

- Connect your camcorder to a wall socket using the AC adaptor supplied with your camcorder, and leave your camcorder with the POWER button turned off for more than 24 hours.
- Or, install a fully charged battery pack in your camcorder, and leave your camcorder with the POWER button turned off for more than 24 hours.

Specifications

Video camera recorder

System

Video recording format

DVD-Video
DVD-VR (DVD-RW only)

Audio recording system

2ch Dolby* Digital

Video signal

PAL color, CCIR standards

Usable discs

8 cm DVD-R and DVD-RW

Video compression format

MPEG2/JPEG (Still images)

Recording/playback time

HQ: Approx. 20 minutes

SP: Approx. 30 minutes

LP: Approx. 60 minutes

Viewfinder

Electric viewfinder (color)

Image device

DCR-DVD91E/DVD101E:

3.0 mm (1/6 type) CCD (Charge

Coupled Device)

Number of Pixels

Gross: Approx. 800 000 pixels

Effective :

Approx. 400 000 pixels

DCR-DVD201E:

3.6 mm (1/5 type) CCD (Charge

Coupled Device)

Number of Pixels

Gross: Approx. 1 070 000 pixels

Effective (for still images) :

Approx. 1 000 000 pixels

Effective (for movies):

Approx. 690 000 pixels

Lens

Carl Zeiss Vario-Tessar

Filter diameter:

25 mm

10× (Optical), 120× (Digital)

DCR-DVD91E/DVD101E:

F = 1.7 – 2.3

DCR-DVD201E:

F = 1.8 – 2.3

Focal length

DCR-DVD91E/DVD101E:

2.3 – 23 mm

When converted to a 35 mm still camera

43 – 430 mm

DCR-DVD201E:

3.2 – 32 mm

When converted to a 35 mm still camera

For movies:

46 – 460 mm

For still images:

38 – 380 mm

Color temperature

Auto, HOLD (Hold),  Indoor

(3 200 K),  Outdoor (5 800 K)

Minimum illumination

DCR-DVD91E/DVD101E:

5 lx (lux) (F 1.7)

0 lx (lux) (in the NightShot plus mode)*

DCR-DVD201E:

7 lx (lux) (F 1.8)

0 lx (lux) (in the NightShot plus mode)*

* Objects unable to be seen due to the dark can be shot with infrared lighting.

Input/Output connectors

AUDIO/VIDEO input/output

(DCR-DVD101E/DVD201E)

AUDIO/VIDEO output

(DCR-DVD91E)

AV MINI JACK,

input/output autoswitch (DCR-DVD101E/DVD201E)

Video : 1 V_{p-p}, 75 Ω (ohms), unbalanced

Audio : 327 mV, (at output impedance of more than 47 kΩ (kilohms))

Output impedance of less than 2.2 kΩ (kilohms)

Input impedance of more than 47 kΩ (kilohms) (DCR-DVD101E/DVD201E)

USB jack (DCR-DVD101E/DVD201E only)

mini-B

REMOTE jack

Stereo mini-minijack (ø 2.5 mm)

MIC jack

Stereo minijack (ø 3.5 mm)

LCD display

Picture

6.2 cm (2.5 type)

Total number of pixels

123 200 (560 × 220)

General

Power requirements

7.2 V (battery pack)

8.4 V (AC adaptor)

Average power consumption (when using the battery pack)

During camera recording using LCD

DCR-DVD91E/DVD101E: 3.9 W

DCR-DVD201E: 4.4 W

Viewfinder

DCR-DVD91E/DVD101E: 3.6 W

DCR-DVD201E: 4.1 W

Operating temperature

0°C to 40°C

Storage temperature

-20°C to +60°C

Dimensions (Approx.)

50.5 × 88 × 136 mm

(w/h/d)

Mass (approx.)

DCR-DVD91E/DVD101E

490 g

main unit only

595 g

including the battery pack,

disc and lens cap

DCR-DVD201E

500 g

main unit only

605 g

including the battery pack,

disc and lens cap

Supplied accessories

See page 14.

* Manufactured under license from Dolby Laboratories. "Dolby" and the double-D symbol are trademarks of Dolby Laboratories.

Specifications

AC adaptor AC-L15A/L15B

Power requirements

100 – 240 V AC, 50/60 Hz

Current consumption

0,35 – 0.18 A

Power consumption

18 W

Output voltage

DC OUT: 8.4 V, 1.5 A in the operating mode

Operating temperature

0°C to 40°C

Storage temperature

-20°C to + 60°C

Dimensions (approx.)

56 × 31 × 100 mm

(w/h/d) excluding projecting parts

Mass (approx.)

190 g

excluding mains lead

Rechargeable battery pack NP-FM50

Maximum output voltage

DC 8.4 V

Output voltage

DC 7.2 V

Capacity

8.5 Wh (1 180 mAh)

Dimensions (approx.)

38.2 × 20.5 × 55.6 mm

(w/h/d)

Mass (approx.)

76 g

Operating temperature

0°C to 40°C

Type

Lithium ion

Design and specifications are subject to change without notice.

Identifying parts and controls

Camcorder

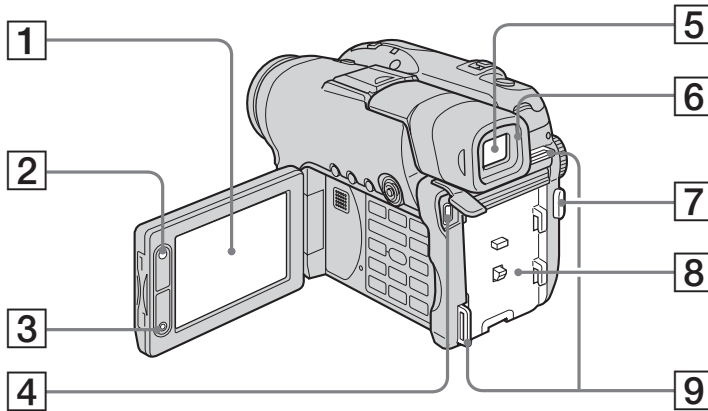

1 LCD screen (page 20)

2 LCD BACKLIGHT button (page 20)

3 REC START/STOP button

4 USB jack (page 94, DCR-DVD101E/
DVD201E only)

5 Viewfinder (page 22)

6 Eye cup

7 START/STOP button (page 30)

8 Battery attachment (page 15)

9 Hooks for shoulder strap

Note on the Carl Zeiss lens

Your camcorder is equipped with a Carl Zeiss lens which can reproduce fine images. The lens for your camcorder was developed jointly by Carl Zeiss, in Germany, and Sony Corporation. It adopts the MTF* measurement system for video cameras and offers the same quality as a Carl Zeiss lens.

* MTF stands for Modulation Transfer Function.

The value number indicates the amount of light from a subject coming into the lens.

Identifying parts and controls

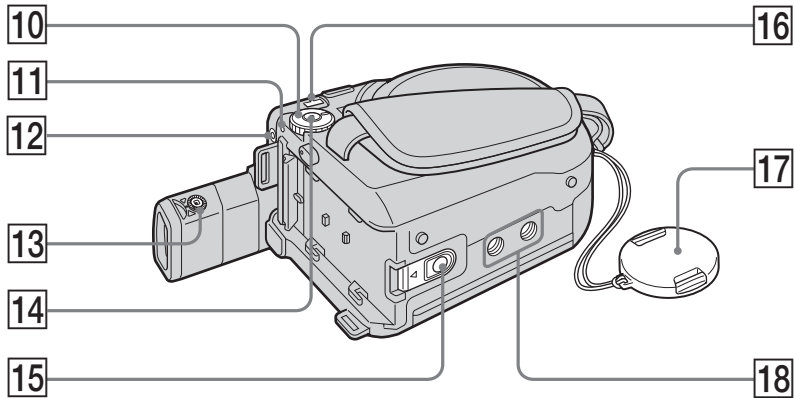

10 Mode dial (page 19)

11 POWER/CHG lamp (page 16)

12 REMOTE jack
Use to connect to optional accessories.

13 Viewfinder lens adjustment dial
(page 22)

14 POWER button (page 19)

15 BATT (battery) release button (page 15)

16 DC IN jack (page 16)

17 Lens cap (page 28)

18 Tripod receptacle
Make sure that the length of the tripod screw is less than 5.5 mm. Otherwise, you cannot attach the tripod securely, and the screw may damage your camcorder.

Identifying parts and controls

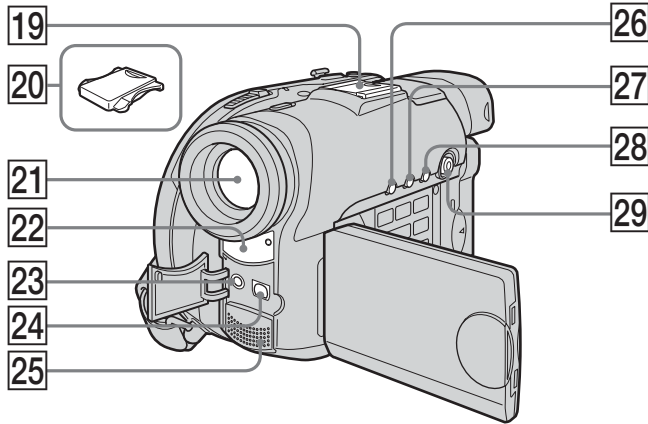

19 Intelligent accessory shoe

20 Shoe cover

21 Lens

22 Remote sensor/Infrared ray emitter

23 **MIC (PLUG IN POWER) jack**
Connect an external microphone (optional). This jack also accepts a “plug-in-power” microphone. When an external microphone is connected, it is preferred for an audio input source.

24 **AUDIO/VIDEO jack** (page 63)

25 **Microphone**

26 **DISPLAY/BATT INFO button** (page 18)

27 **BACK LIGHT button** (page 43)

28 **VISUAL INDEX button** (page 56)

29 **Multi-selector** (page 23)



Notes on the intelligent accessory shoe

- When you use the intelligent accessory shoe, extend the viewfinder and detach the shoe cover.
- The intelligent accessory shoe supplies power to optional accessories such as a microphone.
- The intelligent accessory shoe is linked to the POWER button, allowing you to turn the power supplied by the shoe on and off. Refer to the operating instructions of the accessory for further information.
- The intelligent accessory shoe has a safety device for fixing the installed accessory securely. To connect an accessory, press down and push it to the end, and then tighten the screw.
- To remove an accessory, loosen the screw, and then press down and pull out the accessory.

Identifying parts and controls

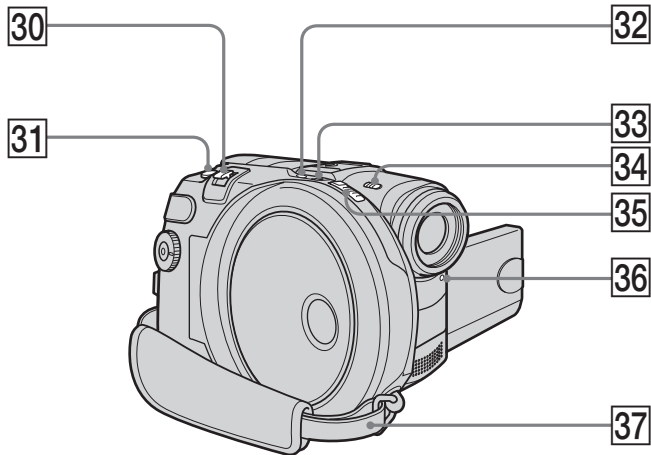

30 Power zoom lever (page 33)

31 PHOTO button (page 35)

32 SUPER NS PLUS/COLOR SLOW S button (page 45)

33 ACCESS lamp (page 26)

34 NIGHTSHOT PLUS switch (page 45)

35 Disc cover OPEN switch (page 26)

36 Recording lamp (page 29)

37 Grip belt (page 28)

Attaching the shoulder strap

Attach the shoulder strap supplied with your camcorder to the hooks for the shoulder strap.

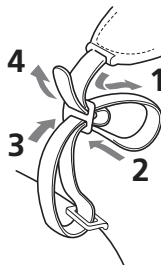

Identifying parts and controls

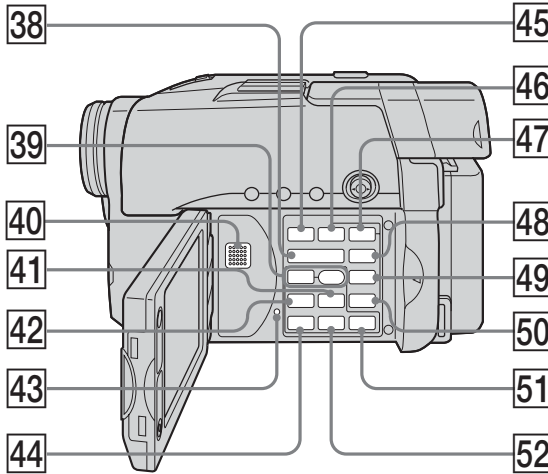

38 VOL buttons (page 56)

39 ● REC buttons (page 109, DCR-DVD101E/DVD201E only)

40 Speaker

41 ►► NEXT (next) button (page 58)

42 ◀◀ PREV (previous) button (page 58)

43 RESET button

44 ► PLAY (playback)/REVIEW Ⓜ button (page 55, 56)

45 FADER button (page 53)

46 FOCUS button (page 52)

47 EXPOSURE button (page 43)

48 SETUP button (page 110)

49 FINALIZE button (page 65)

50 EDIT button (page 76)

51 ■ STOP button (page 57)

52 || PAUSE button (page 58)

Identifying parts and controls

Remote Commander

The buttons that have the same name on the Remote Commander as on your camcorder function identically to the buttons on your camcorder.

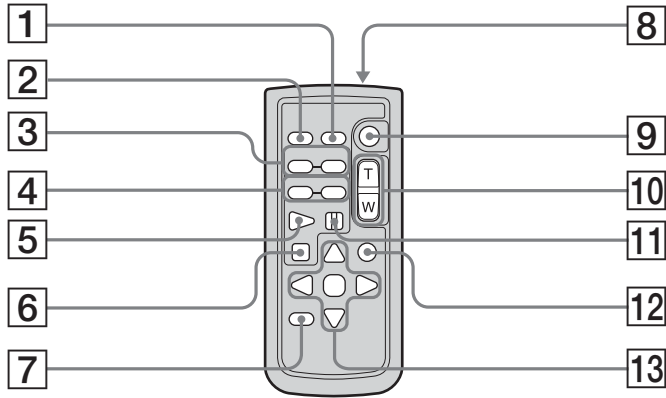

- | | |
|--|---|
| 1 DATA CODE button (page 59) | 8 Transmitter |
| 2 PHOTO button (page 35) | 9 START/STOP button (page 30) |
| 3 ◀◀/▶▶ SCAN/SLOW buttons (page 58) | 10 Power zoom buttons (page 33) |
| 4 ◀◀ PREV/▶▶ NEXT buttons (page 58) | 11 PAUSE button (page 58) |
| 5 ▶▶ PLAY button (page 56) | 12 VISUAL INDEX button (page 56) |
| 6 ■ STOP button (page 57) | 13 ◀/▶/▲/▼/ENTER buttons |
| 7 DISPLAY button (page 59) | |

Identifying parts and controls

To prepare the Remote Commander

Remove the insulation sheet as illustrated to activate the Remote Commander.

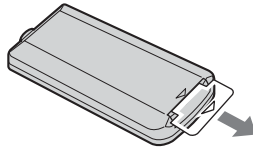

To replace the button-type battery of the Remote Commander

Insert CR2025 lithium battery by matching the + and - on the battery to the + and - terminals in the battery compartment.

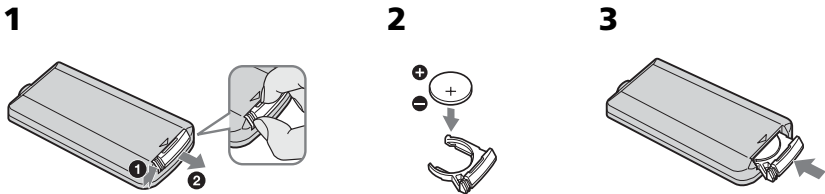

WARNING

Battery may explode if mistreated. Do not recharge, disassemble or dispose of in fire.

CAUTION

Danger of explosion if battery is incorrectly replaced.
Replace only with the same or equivalent type recommended by the manufacturer.
Discard used batteries according to the manufacturer's instructions.

Notes

On the Remote Commander

- The button-type battery CR2025 is used in the Remote Commander. Do not use a battery other than the CR2025.
- Point the remote sensor away from strong light sources such as direct sunlight or overhead lighting. Otherwise, the Remote Commander may not function properly.
- Your camcorder works in the DVD 2 Commander mode. Commander modes 1, 2 and 3 are used to distinguish your camcorder from other Sony DVD players to avoid erroneous remote control operation. If you use another Sony DVD player in the DVD 2 Commander mode, it is recommended that you change the Commander mode of the DVD player or cover the sensor of the DVD player with black paper.

Identifying parts and controls

Operation indicators

LCD display and viewfinder

On shooting

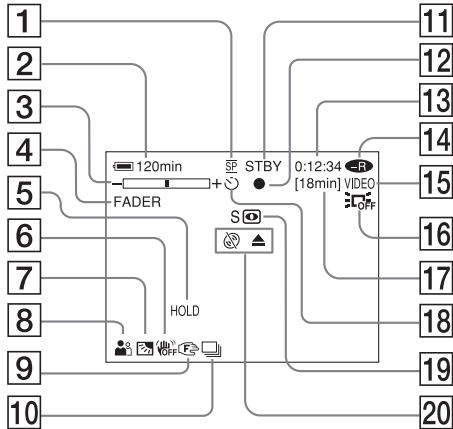

- 1 Recording mode (page 32, 114), Image size (page 39, 112)
- 2 Remaining battery time (page 18)
- 3 Zoom (page 33), Exposure (page 43)
- 4 FADER (page 53), 16:9WIDE (page 48), Effect (page 54)
- 5 White balance (page 50)
- 6 SteadyShot off (page 112)
- 7 Backlight (page 43)
- 8 PROGRAM AE (page 51)
- 9 Manual focus (page 52)
- 10 Burst (page 41, 112), Video flash ready (page 111), Reducing red-eye phenomenon (page 111)
- 11 STBY, REC (page 29), Image quality (page 38, 112)
- 12 AE/AF lock (page 36)
- 13 Counter, Number of recorded still images, Self-diagnosis (page 125)
- 14 Disc type (page 6)
- 15 Recording format (page 7)

On playback

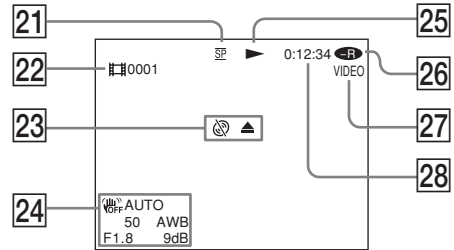

- 16 LCD BACK LIGHT OFF (page 21)
- 17 Remaining time (page 117), Recordable number of still images (page 40)
- 18 Self-timer (page 47)
- 19 NightShot plus, Super NightShot plus, Color Slow Shutter (page 45)
- 20 Warning (page 126, 127)
- 21 Recording mode (page 32, 114), Image size (page 39, 112)
- 22 Scene number (page 57), File number (page 114)
- 23 Warning (page 126, 127)
- 24 Data code (page 59), Date and time (page 23)
- 25 Playback mode (page 58)
- 26 Disc type (page 6)
- 27 Recording format (page 7)
- 28 Counter, Number of played back still images/Number of recorded still images, Self-diagnosis (page 125)

Index

A, B

AC adaptor 16
Adjusting viewfinder 22
A/V connecting cable 14, 63
BACK LIGHT 43
BATTERY INFO 18
Battery pack 15, 130
BEACH & SKI 51
Beep 26, 47, 116
BURST 41
B & W 54

C, D

Charging the battery 16
Charging the built-in
rechargeable battery 134
Clock set 23
Color slow shutter 46
Continuous still images
shooting 41
Counter 31
Data code 59
Date/time display 31, 59
Daylight savings time 24, 116
Delete 55, 89
DEMO 115
Digital effect 54
Digital zoom 33
Disc dubbing 106
Disc title 68
Disc 6
DISPLAY 59
Divide 84, 87
DVD-R 6
DVD-RW 6

E

EXP BRKTG 41
EXPOSURE 43

F, G, H

FADER 53
Fade in/out 53
Finalize 65
FINE 38
Flash 111
Folder 72
FOCUS 52
Format 74
Full charge 17
Grip belt 28
HiFi SOUND 114

HQ 32

I, J, K, L

ImageMixer 93, 99
Image quality 38, 112
Image size 39, 112
"InfoLITHIUM" battery 130
Infrared ray emitter 139
Intelligent accessory shoe 139
JPEG 40
LANDSCAPE 51
LCD screen 20
LP 32
LUMI. (Luminance key) 54

M, N

Manual focus 52
MIC (PLUG IN POWER)
jack 139
Mirror mode 34
Moisture condensation 132
MOSAIC 54
Move 82
NightShot Light 46
NightShot plus 45
NORMAL 41, 111, 112

O, P, Q

OLD MOVIE 54
Operation indicators 144
Operation sound See Beep
OVERLAP 53
PAL system 12, 93, 131
PASTEL 54
PB ZOOM 61
Photomovie 67, 79
Picture effect 54
Playback pause 58
Playing time 17
Playlist 76
PORTRAIT 51
PROGRAM AE 51

R

Recording format 7
Recording time 17
Remaining battery time
indicator 31
Remaining time 117
Remote Commander 142
REMOTE jack 138

RESET 114, 141
Review 55

S

Self-diagnosis display 125
Self-timer recording 47
SEPIA 54
SETUP display 110
Shoulder strap 137, 140
Slide show 62
Slow playback 58
SP 32
SPORTS 51
SPOTLIGHT 51
STANDARD 38
STEADYSHOT 112
SUNSETMOON 51
Super NightShot plus 45
S video jack 63, 106, 109

T, U, V

Telephoto 33
Time difference 25
Title 68
TV 48, 63, 108
TV color systems 12, 131
Unfinalize 73
USB jack 94
VCR 106
VIDEO mode 7
Viewfinder 22
Viewfinder lens
adjustment 22
Visual Index 56
VR mode 7

W, X, Y, Z

Warning indicators 126
Warning messages 127
White balance 50
Wide-angle 33
Wide mode 48
WIPE 53
Zoom 33, 61

On trademarks

- DVD-VIDEO, DVD-RW, and the DVD-R logo are trademarks.
- InfoLITHIUM is a trademark of Sony Corporation.
- PlayStation is a registered trademark of Sony Computer Entertainment Inc.
- Microsoft and Windows are trademarks or registered trademarks of Microsoft Corporation in the United States and/or other countries.
- Pentium is a trademark or a registered trademark of Intel Corporation.
- Macintosh is a trademark or registered trademark of Apple Computer, Inc.

All other product names mentioned herein may be the trademarks or registered trademarks of their respective companies. Furthermore, TM and ® are not mentioned in each case in this manual.

<http://www.sony.net/>



Printed on 100% recycled paper using VOC
(Volatile Organic Compound)-free vegetable
oil based ink.

Printed in Japan



3089914140