

SONY

SONY®

HANDYCAM

Digital Video Camera Recorder

HANDYCAM®

Operating Guide

**DCR-DVD106E/DVD108E/
DVD109E/DVD306E/DVD308E/
DVD608E/DVD708E**

GB

Enjoying with your camcorder 10

Getting Started 19

Recording/Playback 29

Editing 46

Utilizing recording media 55

Customizing your camcorder 60

Using a Computer 78

Troubleshooting 83

Additional Information 96

Quick Reference 110

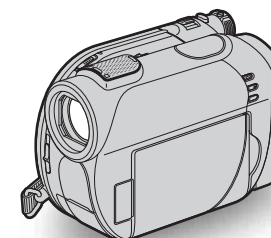

Additional information on this product and answers to frequently asked questions can be found at our Customer Support Website.

<http://www.sony.net/>



Printed on 70% or more recycled paper using VOC (Volatile Organic Compound) -free vegetable oil based ink.

Printed in China



Read this before operating your camcorder

Before operating the unit, please read this manual thoroughly, and retain it for future reference.

WARNING

To reduce fire or shock hazard, do not expose the unit to rain or moisture.



CAUTION

The use of optical instruments with this product will increase eye hazard. Use of controls or adjustments or performance of procedures other than those specified herein may result in hazardous radiation exposure.

Replace the battery with the specified type only. Otherwise, fire or injury may result.

FOR CUSTOMERS IN THE UNITED KINGDOM

A moulded plug complying with BS1363 is fitted to this equipment for your safety and convenience.

Should the fuse in the plug supplied need to be replaced, a fuse of the same rating as the supplied one and approved by ASTA or BSI to BS1362 (i.e., marked with  or  mark) must be used.

If the plug supplied with this equipment has a detachable fuse cover, be sure to attach the fuse cover after you change the fuse. Never use the plug without the fuse cover. If you should lose the fuse cover, please contact your nearest Sony service station.

FOR CUSTOMERS IN EUROPE

CLASS 1 LASER PRODUCT
LASER KLASSE 1
LUOKAN 1 LASERLAITE
KLASS 1 LASERAPPARAT

ATTENTION

The electromagnetic fields at the specific frequencies may influence the picture and sound of this unit.

This product has been tested and found compliant with the limits set out in the EMC Directive for using connection cables shorter than 3 meters (9.8 feet).

Notice

If static electricity or electromagnetism causes data transfer to discontinue midway (fail), restart the application or disconnect and connect the communication cable (USB, etc.) again.



Disposal of Old Electrical & Electronic Equipment (Applicable in the European Union and other European countries with separate collection systems)

This symbol on the product or on its packaging indicates that this product shall not be treated as household waste. Instead it shall be handed over to the applicable collection point for the recycling of electrical and electronic equipment. By ensuring this product is disposed of correctly, you will help prevent potential negative consequences for the environment and human health, which could otherwise be caused by inappropriate waste handling of this product. The recycling of materials will help to conserve natural resources.

For more detailed information about recycling of this product, please contact your local Civic Office, your household waste disposal service or the shop where you purchased the product.

Applicable Accessory: Remote Commander (DCR-DVD306E/DVD308E/DVD708E)

For customers in the U.S.A.

If you have any questions about this product, you may call:

Sony Customer Information Center
1-800-222-SONY (7669).

The number below is for the FCC related matters only.

Regulatory Information

Declaration of Conformity

Trade Name: SONY

Model No.: DCR-DVD608E

Responsible Party: Sony Electronics Inc.

Address: 16530 Via Esprillo, San Diego, CA
92127 U.S.A.

Telephone No.: 858-942-2230

This device complies with Part 15 of the FCC Rules. Operation is subject to the following two conditions: (1) This device may not cause harmful interference, and (2) this device must accept any interference received, including interference that may cause undesired operation.

Declaration of Conformity

Trade Name: SONY

Model No.: DCR-DVD708E

Responsible Party: Sony Electronics Inc.

Address: 16530 Via Esprillo, San Diego, CA
92127 U.S.A.

Telephone No.: 858-942-2230

This device complies with Part 15 of the FCC Rules. Operation is subject to the following two conditions: (1) This device may not cause harmful interference, and (2) this device must accept any interference received, including interference that may cause undesired operation.

CAUTION

You are cautioned that any changes or modifications not expressly approved in this manual could void your authority to operate this equipment.

Note

This equipment has been tested and found to comply with the limits for a Class B digital device, pursuant to Part 15 of the FCC Rules.

These limits are designed to provide reasonable protection against harmful interference in a residential installation. This equipment generates, uses, and can radiate radio frequency energy and, if not installed and used in accordance with the instructions, may cause harmful interference to radio communications.

However, there is no guarantee that interference will not occur in a particular installation. If this equipment does cause harmful interference to radio or television reception, which can be determined by turning the equipment off and on, the user is encouraged to try to correct the interference by one or more of the following measures:

- Reorient or relocate the receiving antenna.
- Increase the separation between the equipment and receiver.
- Connect the equipment into an outlet on a circuit different from that to which the receiver is connected.
- Consult the dealer or an experienced radio/TV technician for help.

The supplied interface cable must be used with the equipment in order to comply with the limits for a digital device pursuant to Subpart B of Part 15 of FCC Rules.

Battery pack

This device complies with Part 15 of the FCC Rules. Operation is subject to the following two conditions:

- (1) This device may not cause harmful interference, and (2) this device must accept any interference received, including interference that may cause undesired operation.

Notes on use

Your camcorder is supplied with two kinds of operations guides.

- "Operating Guide" (This manual)
- "First Step Guide" for using your camcorder with the computer connected (stored on the supplied CD-ROM)

Types of the disc you can use in your camcorder

You can use the following discs only.

Read this before operating your camcorder (Continued)

- 8cm DVD-RW
- 8cm DVD+RW
- 8cm DVD-R
- 8cm DVD+R DL

Use the discs with marks listed below. See page 12 for details.



For reliability durability of recording / playback, we recommend that you use Sony discs or discs with an  for VIDEO CAMERA™ *(for VIDEO CAMERA) mark for your camcorder.

Note

- Using a disc other than above may cause the unsatisfactory recording/playback or you may not be able to remove the disc from your camcorder.
- * Depending on the place you bought, the disc has  for VIDEO CAMERA™ mark.

Types of “Memory Stick” you can use in your camcorder

You can use “Memory Stick Duo” marked with MEMORY STICK DUO or MEMORY STICK PRO DUO (p. 99).

“Memory Stick Duo”
(This size can be used with your camcorder.)



“Memory Stick”
(You cannot use it in your camcorder.)



- You cannot use any type of memory card except “Memory Stick Duo.”
- “Memory Stick PRO” and “Memory Stick PRO Duo” can be used only with

“Memory Stick PRO” compatible equipment.

- Do not attach a label or the like on a “Memory Stick Duo” or a Memory Stick Duo Adaptor.

When using a “Memory Stick Duo” with “Memory Stick” compatible equipment

Be sure to insert the “Memory Stick Duo” into the Memory Stick Duo Adaptor.

Memory Stick Duo Adaptor



Using the camcorder

- Do not hold the camcorder by the following parts.



Viewfinder



LCD screen

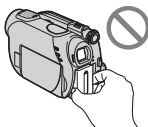

Battery

- The camcorder is not dustproofed, dripproofed or waterproofed. See “About handling of your camcorder” (p. 102).
- To prevent discs from being broken or recorded images from being lost, do not do the following when either of the respective lamps of the POWER switch (p. 23) or the access lamps (p. 26, 27) is on:
 - to remove the battery pack or AC Adaptor from the camcorder.
 - to apply mechanical shock or vibration to the camcorder.

- When connecting your camcorder to another device with a USB cable, be sure to insert the connector plug in the correct way. Pushing the plug forcibly into the terminal will damage the terminal and may result in a malfunction of your camcorder.

About menu items, LCD panel, viewfinder, and lens

- A menu item that is grayed out is not available under the current recording or playback conditions.
- The LCD screen and the viewfinder are manufactured using extremely high-precision technology, so over 99.99% of the pixels are operational for effective use. However, there may be some tiny black points and/or bright points (white, red, blue, or green in color) that appear constantly on the LCD screen and the viewfinder. These points are normal results of the manufacturing process and do not affect the recording in any way.

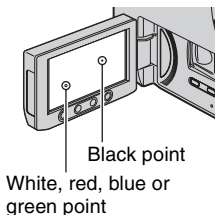

- Exposing the LCD screen, the viewfinder, or the lens to direct sunlight for long periods of time may cause malfunctions.
- Do not aim at the sun. Doing so might cause your camcorder to malfunction. Take images of the sun only in low light conditions, such as at dusk.

On recording

- Before starting to record, test the recording function to make sure the image and sound are recorded without any

problems. You cannot delete images once you record them on a DVD-R/DVD+R DL. Use a DVD-RW/DVD+RW for trial recording (p. 12).

- Compensation for the contents of recordings cannot be provided, even if recording or playback is not possible due to a malfunction of the camcorder, storage media, etc.
- TV color systems differ depending on the countries/regions. To view your recordings on a TV, you need a PAL system-based TV.
- Television programs, films, video tapes, and other materials may be copyrighted. Unauthorized recording of such materials may be contrary to the copyright laws.

About language setting

The on-screen displays in each local language are used for illustrating the operating procedures. Change the screen language before using your camcorder if necessary (p. 24).

About this manual

- The LCD screens and the viewfinder images and indicators shown in this manual were taken with a digital still camera, and may look different from what you actually see.
- Design and specifications of recording media and other accessories are subject to change without notice.
- The illustration used in this manual are based on the model DCR-DVD308E.
- Disc in this Operating Guide refers to 8cm DVD discs.

About the Carl Zeiss lens

Your camcorder is equipped with a Carl Zeiss lens, which was developed jointly by Carl Zeiss, in Germany, and Sony Corporation, and produces superior images. It adopts the MTF measurement system for video cameras and offers a quality typical of a Carl Zeiss lens.

Read this before operating your camcorder (Continued)

MTF= Modulation Transfer Function. The number value indicates the amount of light from a subject coming into the lens.

About the marks used in this manual

- The operations available depend on the disc used. The following marks are used to indicate the type of disc you can use for a particular operation.

DVD
-R

DVD
-RW



DVD
+RW

DVD
+R DL

Table of Contents

Read this before operating your camcorder	2
Subject examples and solutions	9

Enjoying with your camcorder

What you can do with your camcorder	10
Choosing a disc	12
Using your camcorder	14
“  HOME” and “  OPTION” - Taking advantage of two types of menus	16

Getting Started

Step 1: Checking supplied items	19
Step 2: Charging the battery pack	20
Step 3: Turning the power on, and setting the date and time	23
Changing the language setting	24
Step 4: Preparing for recording	25
Step 5: Inserting a disc or a “Memory Stick Duo”	26

Recording/Playback

Recording and playing back with ease (Easy Handycam)	29
Recording	32
Zooming	34
Recording sound with more presence (5.1ch surround recording) (DCR-DVD 109E/DVD306E/DVD308E/DVD708E)	34
Recording in dark places (NightShot plus)	35
Adjusting the exposure for backlit subjects	35
Recording in mirror mode	35

Selecting the aspect ratio (16:9 or 4:3) (DCR-DVD306E/DVD308E/DVD708E)	35
--	----

Playback	37
Using PB zoom	39
Playing back a series of still images (Slide show)	39
Playing the picture on a TV	40

Making the disc compatible with playback on other devices or DVD drives (Finalizing)	42
--	----

Editing

 (OTHERS) category	46
Deleting images	46
Dividing the image	48
Creating the Playlist	49
Dubbing to VCR or DVD/HDD recorders	52
Printing recorded images (PictBridge compliant printer)	53

Utilizing recording media

 (MANAGE DISC/MEMORY) category	55
Playing a disc on other devices	55
Finding the right disc (DISC SELECT GUIDE)	56
Deleting all scenes on the disc (Formatting)	57
Recording additional scenes after finalizing	58

Customizing your camcorder





What you can do with the  (SETTINGS) category of the HOME MENU	60
Using the HOME MENU	60

Table of Contents (Continued)

List of the  (SETTINGS) category items	61
MOVIE SETTINGS	62
(Items for recording movies)	
PHOTO SETTINGS	64
(Items for recording still images)	
VIEW IMAGES SET	65
(Items to customize the display)	
SOUND/DISP SET	67
(Items to adjust beep and the screen)	
OUTPUT SETTINGS	68
(Items for when connecting other devices)	
CLOCK/LANG	69
(Items to set clock and language)	
GENERAL SET	70
(Other setup items)	
Activating functions using the  OPTION MENU	71
Using the OPTION MENU	71
Recording items on the OPTION MENU	72
Viewing items on the OPTION MENU	72
Functions set in the OPTION MENU	73

Using a Computer

What you can do with Windows computer	78
Installing the “First Step Guide” and software	79
Viewing “First Step Guide”	81
Using a Macintosh computer	82

Troubleshooting

Troubleshooting	83
Warning indicators and messages	92

Additional Information

Using your camcorder abroad	96
Maintenance and precautions	98
Specifications	106

Quick Reference

Identifying parts and controls	110
Indicators displayed during recording/playback	114
Glossary	117
Index	118

Subject examples and solutions

Shooting

Flowers in close-up



- ▶ PORTRAIT 75
- ▶ FOCUS 73
- ▶ TELE MACRO 73

A child on the stage under a spot light



- ▶ SPOTLIGHT 75

Focusing on the dog on the left side of the screen



- ▶ FOCUS 73
- ▶ SPOT FOCUS 73

Fireworks with all its splendor



- ▶ FIREWORKS 74
- ▶ FOCUS 73

Getting a good shot of a ski slope or beach



- ▶ BACK LIGHT 35
- ▶ BEACH 75
- ▶ SNOW 75

A sleeping child under dim light



- ▶ NightShot plus 35
- ▶ COLOR SLOW SHTR 76

Checking your golf swing



- ▶ SPORTS 75

What you can do with your camcorder

Your camcorder records image data on 8cm DVD*.
It is more convenient than video tape and far more versatile.

Taking beautiful shots easily

No rewinding to start recording (p.29, 32)

Recorded images are stored in empty areas on the disc so there is no risk that valuable recordings are accidentally overwritten.

Since no rewinding is necessary prior to recording, you can start shooting any time you desire.

Notes

- Still images can be recorded only on "Memory Stick Duo."

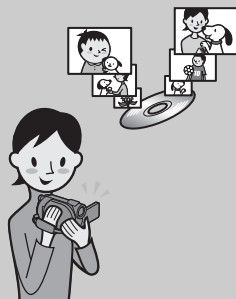

You can find a scene quickly using a VISUAL INDEX screen (p.30, 37)

The VISUAL INDEX screen allows you to check recorded at a glance. All you have to do is touch the scene you want to view.

The disc does not wear out no matter how many times you play it back. The precious moments you have captured on disc last for a long time.



Records widescreen format and 5.1ch surround sound (p.34, 35)

You can record high quality widescreen images on a wide LCD screen that shows the same 16:9 angle of view as a wide TV. Realistic 5.1ch surround sound can also be directly recorded onto the disc.



Notes

- Some models may not support wide screen and 5.1 ch surround recording.

* DVD (Digital Versatile Disc) is a high-capacity optical disc.

A recorded disc can be played back on a variety of devices

Playback on a DVD device or DVD drive (p.42)

You can play back recorded and finalized** discs on a home DVD device, DVD recorder or DVD drive of a computer that supports 8cm disc.

When finalizing the disc, you can create DVD menus to enable quick access to scenes you want to view.



Playback on widescreen TV and home theater (p.40)

Images recorded in widescreen format can be played back on a wide TV with complete panoramic effect. Discs are also recorded with 5.1ch surround sound to provide full sound on a home theater.



Notes

- Some models may not support wide screen and 5.1 ch surround recording.

Connecting camcorder to a computer

High-speed image transfer (p.78)

Image data can be quickly transferred to a computer without requiring playback. Computers with Hi-Speed USB (USB 2.0) provide even faster image transfer.



Using the supplied software to edit and copy (p.78)

Picture Motion Browser, the software supplied with your camcorder allows you to edit movies or still images stored in your computer to create your original DVD. Copying discs could not be easier enabling you to share your precious moments with family and friends.

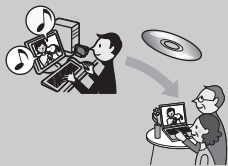

** Finalizing: a process to make it possible to play back recorded DVD on other DVD devices (p.42).

Choosing a disc

Your camcorder is compatible with 8cm DVD-RW, DVD+RW, DVD-R and DVD+R DL. It does not support 12cm discs.

Recording time

Expected recordable time on one side of the disc.

The recordable time varies depending on type of discs or recording mode.

Recording mode	Approximate recordable time () : the minimum recording time			
	DVD -RW	DVD +RW	DVD -R	DVD +R DL
9M (HQ) (high quality)		20 (18)		35 (32)
6M (SP) (standard quality)		30 (18)		55 (32)
3M (LP) (long play)		60 (44)		110 (80)



Tips

- Figures such as 9M and 6M in the table show the average bit rate. M stands for Mbps.
- If you use a double-sided disc, you can record on both sides of the disc (p.98).

Your camcorder uses the VBR (Variable Bit Rate) format to automatically adjust image quality to suit the recording scene. This technology causes fluctuations in the recording time of a disc. Movies containing quickly moving and complex images are recorded at a higher bit rate, and this reduces the overall recording time.

Recording format for DVD-RW









When you use a DVD-RW, you can choose the recording format from VIDEO mode or VR mode. In this manual, VIDEO mode is indicated as  and VR mode as .

	A recording format that is compatible with most DVD devices, especially after finalizing. In VIDEO mode, only the most recent image can be erased.
	A recording format that enables editing with your camcorder (deleting and rearranging the order of images). A finalized disc can be played back in DVD devices that support VR mode.

VIDEO mode and VR mode  Glossary (p.117)

Disc format features

Figures in parentheses () indicate page numbers.

Disc types and symbols	DVD-RW		DVD+RW	DVD-R	DVD+R DL
					
Symbols used in this manual					
	VIDEO	VR			
Both 16:9 (wide) and 4:3 movie can be recorded on the same disc (35)	●	●	—	●	●
Deleting the most recent recording (47)	●	●	●	—	—
Deleting or editing recordings on your camcorder (46)	—	●	—	—	—
Using a disc repeatedly even if the disc becomes full by formatting*2 (57)	●	●	●	—	—
Finalizing required to play on other devices (42)	●	●*1	—*3	●	●
Creating the DVD menu when you finalize the disc (45)	●	—	●	●	●
Making longer recordings on a side of a disc	—	—	—	—	●

*1 Refer to the instruction manual of your DVD device to see whether it supports the VR mode of DVD-RW.

*2 Formatting deletes all recordings and returns the recording medium to its original empty state (p.57). Even when using a new disc, format it with your camcorder (p.26).

*3 Finalizing is required to play the disc in a DVD drive on a computer. A DVD+RW that is not finalized may cause the computer to malfunction.

Using your camcorder

① Preparing

(See page 19 to 28.)



Select the disc that best suits your needs.

Do you want to delete or edit images on your camcorder?

Yes

No

Do you want to delete images and reuse the disc?

Yes

No

For long recording

DVD
-RW

VR

DVD
-RW

VIDEO

DVD
+RW

DVD
+R DL

DVD
-R

* Select the recording format and format the disc on your camcorder (p.26).

💡 Tips

- You can select the disc from [DISC SELECT GUIDE] (p.56).

② Recording, playback, editing

(See pages 32, 37, and 46.)

What you can do with your camcorder depends on the type of disc (p.13).

③ Viewing on your camcorder

(See pages 30 and 37)

You can also connect it to a TV for viewing (p.40).

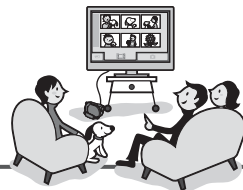

Continued on the next page

④ Viewing on another DVD device

(See pages 42, 55.)

To view a disc recorded on your camcorder on other DVD devices, you need to finalize it first.



🔍 Notes

- The less the recording volume of the disc is, the more it takes time to finalize the disc.

The features of a finalized disc depend on disc type.

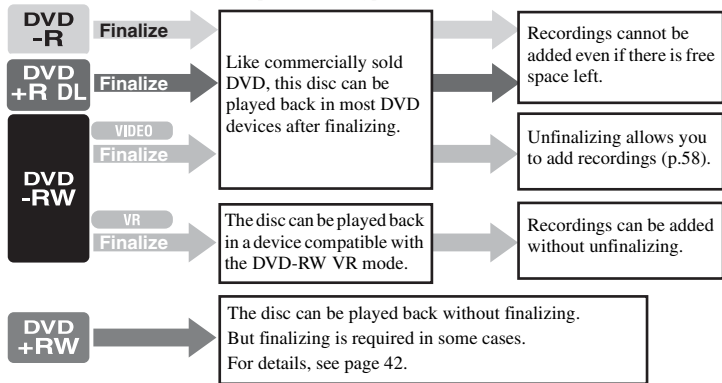

Playback compatibility

Playback compatibility with any DVD device is not guaranteed. Refer to the instruction manual supplied with your DVD device or consult your dealer.

“HOME” and “OPTION”

- Taking advantage of two types of menus

“HOME MENU” - the starting point for operations with your camcorder

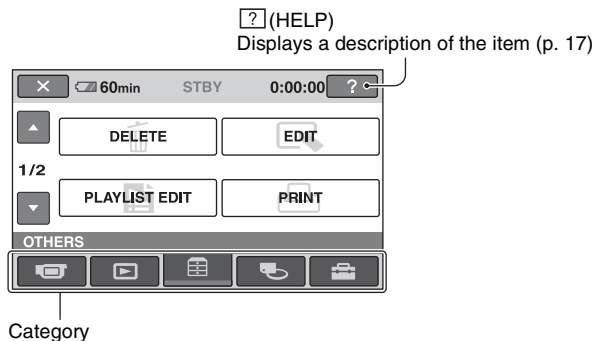

► Categories and items of the HOME MENU

(CAMERA) category

Items	Page
MOVIE*	33
PHOTO*	33

(VIEW IMAGES) category

Items	Page
VISUAL INDEX*	37
PLAYLIST	49

(OTHERS) category

Items	Page
DELETE*	46
EDIT	48
PLAYLIST EDIT	49
PRINT	53
COMPUTER	78

(MANAGE DISC/MEMORY) category

Items	Page
FINALIZE*	42
DISC SELECT GUIDE	56
FORMAT*	57
FORMAT*	58
UNFINALIZE	58
DISC INFO	55

(SETTINGS) category

To customize your camcorder (p. 60).

* You can also set these items during Easy Handycam operation (p. 29). For items available in the (SETTINGS) category, see page 61.

Using the HOME MENU

- 1 Turn the POWER switch to turn on your camcorder.

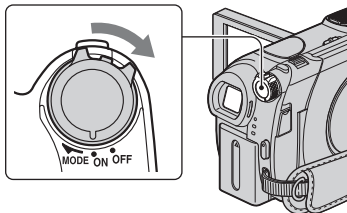

- 2 Press **↑** (HOME) **[A]** (or **[B]**).

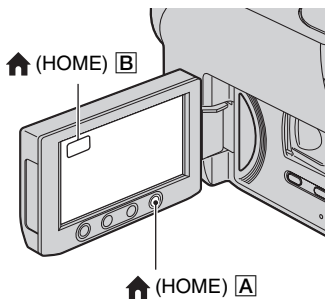

- 3 Touch the category you want to use.

Example: **[OTHERS]** category



- 4 Touch the item you want to use.

Example: [EDIT]

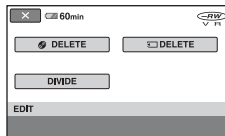

- 5 Continue operation by following the guidance on the screen.

To hide the HOME MENU screen

Touch **[X]**.

When you want to know something about the function of each item on the HOME MENU - HELP

- 1 Press **↑** (HOME).
The HOME MENU appears.



- 2 Touch **[?]** (HELP).
The bottom of the **[?]** (HELP) button turns orange.



“HOME” and “OPTION” (Continued)

- ③ Touch the item you want to know the content.



When you touch an item, its explanation appears on the screen.

To apply the option, touch [YES], otherwise, touch [NO].

To deactivate the HELP

Touch [?] (HELP) again in step 2.

Using the OPTION MENU

Just a touch on the screen during recording or playback displays the functions available at that moment. You will find it easy to make various settings. See page 71 for further details.

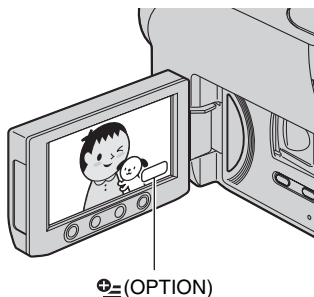

Step 1: Checking supplied items

Make sure that you have the following items supplied with your camcorder. The number in the parentheses indicates the number of that item supplied.

AC Adaptor (1) (p. 20)

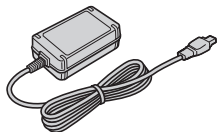

Mains lead (1) (p. 20)



A/V connecting cable (1) (p. 40, 52)



USB cable (1) (p. 53)

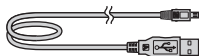

Wireless Remote Commander (DCR-DVD306E/DVD308E/DVD708E) (1) (p. 113)



A button-type lithium battery is already installed.

Rechargeable battery pack NP-FH40 (1) (p. 20)

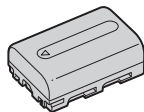

CD-ROM "Handycam Application Software" (1) (p. 78)

Operating Guide (This manual) (1)

Step 2: Charging the battery pack

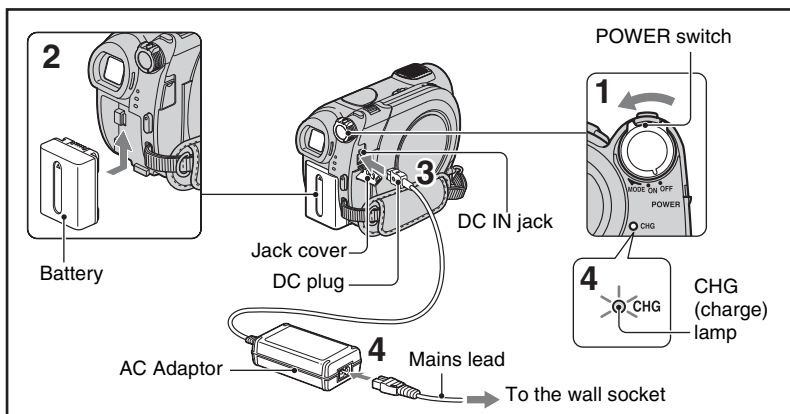

You can charge the “InfoLITHIUM” battery pack (H series) (p. 101) after attaching it to your camcorder.

Notes

- You can use only “InfoLITHIUM” battery pack H series.

1 Turn the **POWER** switch in the direction of the arrow to **OFF (CHG)** (The default setting).

2 Attach the battery pack by sliding it in the direction of the arrow until it clicks.

3 Connect the **AC Adaptor** to the **DC IN jack** of your camcorder.

Open the jack cover, and connect the DC plug of the AC Adaptor.

Match the ▲ mark on the DC plug with the ▲ mark on your camcorder.

4 Connect the mains lead to the **AC Adaptor** and the wall socket.

The CHG (charge) lamp lights up and charging starts. The CHG (charge) lamp turns off when the battery is fully charged.

5 Disconnect the **AC Adaptor** from the **DC IN jack** on your camcorder.

Notes

- Disconnect the AC Adaptor from the DC IN jack holding both the camcorder and the DC plug.

To remove the battery pack

Turn the **POWER** switch to **OFF(CHG)**. Slide the **BATT** (battery) release lever and remove the battery pack.

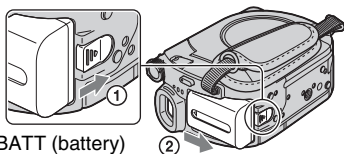

BATT (battery)
release lever

Notes

- When you remove the battery pack or the AC Adaptor, make sure that the (Movie) lamp/
 (Still) lamp (p. 23) is turned off.

When storing the battery pack

Fully discharge the battery before storing it for an extended period.

To use an outside power source

Make the same connections as you do when charging the battery pack. The battery pack will not lose its charge in this case.

To check the remaining battery (Battery Info)

Set the POWER switch to OFF (CHG), then press DISP/BATT INFO.

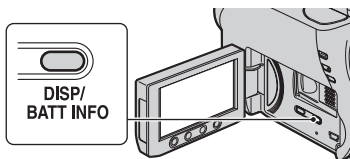

After a while, the approximate recordable time and battery information appear for about 7 seconds. You can view the battery information for up to 20 seconds by pressing DISP/BATT INFO again while the information is displayed.

Remaining battery (approx.)

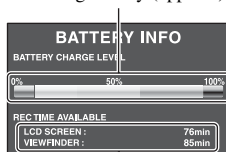

Recording capacity (approx.)

Charging time

Approximate time (min.) required when you fully charge a fully discharged battery pack.

Battery pack	Charging time
NP-FH40 (supplied)	125
NP-FH50	135
NP-FH70	170
NP-FH100	390

Recording time

Approximate time (min.) available when you use a fully charged battery pack.

DCR-DVD106E/DVD108E/DVD608E

Battery pack	Continuous recording time	Typical recording time*
NP-FH40 (supplied)	95	45
	100	50
NP-FH50	110	50
	120	55
NP-FH70	235	110
	255	120
NP-FH100	545	260
	590	285

Step 2: Charging the battery pack (Continued)

DCR-DVD109E

Battery pack	Continuous recording time	Typical recording time*
NP-FH40 (supplied)	90	45
	100	50
NP-FH50	105	50
	115	55
NP-FH70	230	110
	245	115
NP-FH100	525	250
	565	270

DCR-DVD306E/DVD308E/DVD708E

Battery pack	Continuous recording time	Typical recording time*
NP-FH40 (supplied)	85	40
	95	45
	95	45
NP-FH50	100	50
	110	50
	110	50
NP-FH70	215	105
	235	110
	235	110
NP-FH100	495	235
	545	260
	545	260

* Typical recording time shows the time when you repeat recording start/stop, turning the power on/off and zooming.

Notes

- All times measured with recording mode [SP] under the following conditions:
Top: When the LCD backlight turns on.
Middle: When the LCD backlight turns off (DCR-DVD306E/DVD308E/DVD708E).
Bottom: Recording time when recording with the viewfinder while the LCD panel is closed.

Playing time

Approximate time (min.) available when you use a fully charged battery pack.

DCR-DVD106E/DVD108E/DVD608E

Battery pack	LCD panel opened	LCD panel closed
NP-FH40 (supplied)	120	135
	140	155
NP-FH50	300	330
NP-FH70	695	760

DCR-DVD109E



Battery pack	LCD panel opened	LCD panel closed
NP-FH40 (supplied)	110	125
	130	145
NP-FH50	280	315
NP-FH70	635	725

DCR-DVD306E/DVD308E/DVD708E

Battery pack	LCD panel opened*	LCD panel closed
NP-FH40 (supplied)	110	125
	130	145
NP-FH50	280	315
NP-FH70	635	725

* When the LCD backlight is on.

On the battery pack

- Before changing the battery pack, Turn the POWER switch to OFF (CHG) and turn off the  (Movie) lamp/ (Still) lamp (p. 23).
- The CHG (charge) lamp flashes during charging, or Battery Info (p. 21) will not be correctly displayed under the following conditions:
 - The battery pack is not attached correctly.
 - The battery pack is damaged.
 - The battery pack is worn-out (For Battery Info only).

- The power will not be supplied from the battery as long as the AC Adaptor is connected to the DC IN jack of your camcorder, even when the mains lead is disconnected from the wall socket.
- When attaching an optional video light, it is recommended that you use an NP-FH70/NP-FH100 battery pack (DCR-DVD306E/DVD308E/DVD708E).
- We do not recommend using an NP-FH30, which only allows short recording and playback times, with your camcorder.

On the charging/recording/playback time

- Times measured when using the camcorder at 25 °C (77 °F) (10 °C to 30 °C (50 °F to 86 °F) is recommended).
- The recording and playback time will be shorter when you use your camcorder in low temperatures.
- The recording and playback time will be shorter depending on the conditions under which you use your camcorder.

On the AC Adaptor

- Use the nearby wall socket when using the AC Adaptor. Disconnect the AC Adaptor from the wall socket immediately if any malfunction occurs while using your camcorder.
- Do not use the AC Adaptor placed in a narrow space, such as between a wall and furniture.
- Do not short-circuit the DC plug of the AC Adaptor or battery terminal with any metallic objects. This may cause a malfunction.
- Even if your camcorder is turned off, AC power (mains) is still supplied to it while connected to the wall socket via the AC Adaptor.

Step 3: Turning the power on, and setting the date and time

Set the date and time when using this camcorder for the first time. If you do not set the date and time, the [CLOCK SET] screen appears every time you turn on your camcorder or change the POWER switch position.

POWER switch

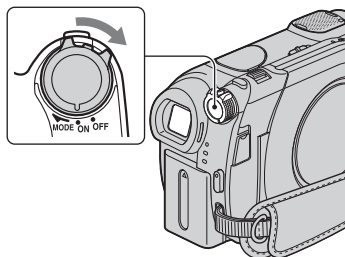

- 1 While pressing the green button, turn the POWER switch repeatedly in the direction of the arrow until the respective lamp lights up.

 (Movie): To record movies

 (Still): To record still images

The [CLOCK SET] screen appears.

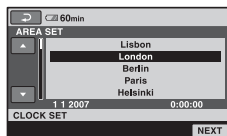

- 2 Select the desired geographical area with ▲/▼, then touch [NEXT].

- 3 Set [SUMMERTIME], then touch [NEXT].

Step 3: Turning the power on, and setting the date and time (Continued)

4 Set [Y] (year) with ▲/▼.

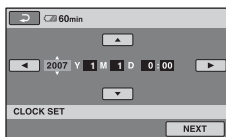

5 Select [M] with ◀/▶, then set the month with ▲/▼.

6 Set [D] (day), hour and minute in the same way, then touch [NEXT].

7 Make sure that the clock is correctly set, then touch [OK].

The clock starts.

You can set any year up to the year 2037.

camcorder without any operation attempted for approximately 5 minutes, to save battery power ([A.SHUT OFF], p. 70).

💡 Tips

- The date and time does not appear during recording, but they are automatically recorded on the disc, and can be displayed during playback (see page 65 for [DATA CODE]).
- Refer to page 97 for information concerning “World time difference.”
- If the buttons on the touch panel do not work correctly, adjust the LCD screen ([CALIBRATION], p. 103).

Changing the language setting

You can change the on-screen displays to show messages in a specified language.

Touch (HOME) →

(SETTINGS) → [CLOCK/ LANG] → [LANGUAGE SET], then select the desired language.

To turn off the power

Turn the POWER switch to OFF (CHG).

To reset the date and time

Select (HOME) → (SETTINGS) → [CLOCK/ LANG] → [CLOCK SET], and set the date and time.

🔔 Notes

- If you do not use your camcorder for **about 3 months**, the built-in rechargeable battery gets discharged and the date and time settings may be cleared from the memory. In that case, charge the rechargeable battery and then set the date and time again (p. 105).
- It takes a few seconds for your camcorder to be ready to shoot after the power is turned on. You cannot operate your camcorder during this time.
- In the setting at the time of purchase, the power turns off automatically if you leave your

Step 4: Preparing for recording

Opening the lens cover

Slide the LENS COVER switch to OPEN.

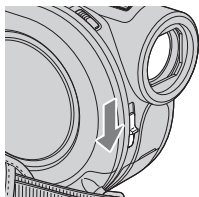

After recording, set the LENS COVER switch to CLOSE to close the lens cover.

LCD panel

Open the LCD panel 90 degrees to the camcorder (①), then rotate it to the best angle to record or play (②).

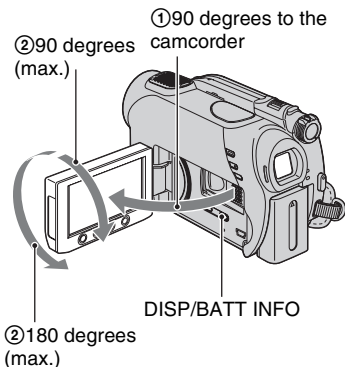

To turn off the LCD backlight to make the battery last longer (DCR-DVD306E/DVD308E/DVD708E)

Press and hold DISP/BATT INFO for a few seconds until BATT INFO appears. This setting is practical when you use your camcorder in bright conditions or you want to save battery power. The recorded image will not be affected by the setting. To turn on the LCD backlight, press and hold DISP/

BATT INFO for a few seconds until BATT INFO disappears.

Notes

- Do not press the buttons on the LCD frame when you open or adjust the LCD panel.

Tips

- If you open the LCD panel 90 degrees to the camcorder, then rotate it 180 degrees to the lens side, you can close the LCD panel with the LCD screen facing out. This is convenient during playback operations.
- On the HOME MENU, touch [SETTINGS] → [SOUND/DISP SET] → [LCD BRIGHT] (p. 67) to adjust the brightness of the LCD screen.
- The information is displayed or hidden (display ↔ no display) each time you press DISP BATT/INFO.

Viewfinder

You can view images using the viewfinder to avoid wearing down the battery, or when the image seen on the LCD screen is poor.

Viewfinder

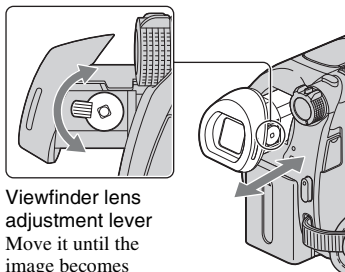

Tips

- You can adjust the brightness of the viewfinder backlight by selecting [SETTINGS] → [SOUND/DISP SET] → [VF B.LIGHT] on the HOME MENU (p. 67).

Step 5: Inserting a disc or a “Memory Stick Duo”

Disc

A new 8 cm DVD-RW, DVD+RW, DVD-R, or DVD+R DL is required for recording (p. 12).

Notes

- Remove dust or fingerprints from the disc beforehand, using a soft cloth (p.99).

1 Check that the power of your camcorder is on.

2 Turn the disc cover OPEN switch in the direction of the arrow (OPEN ►).

[PREPARING TO OPEN] appears on the LCD screen.

The disc cover slightly opens automatically.

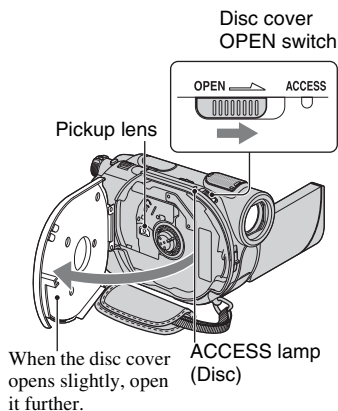

3 Set the disc with the recording side facing your camcorder, then press the center of the disc until it clicks.

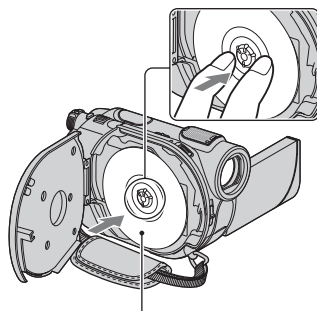

Set the disc with the label side facing out when using a single-sided disc.

4 Close the disc cover.

[DISC ACCESS] appears on the LCD screen.

It may take some time for the camcorder to recognize the disc.

■ DVD-RW/DVD+RW

A screen appears to ask whether you will use [DISC SELECT GUIDE]. Using [DISC SELECT GUIDE] lets you format the disc by following the guidance on the screen. If you do not want to use it, proceed to step 5.

■ DVD-R/DVD+R DL

You can start recording immediately after [DISC ACCESS] disappears from the LCD screen. You do not need to proceed to steps after step 5.

5 Touch the option that is right for you on the screen.

■ DVD-RW

Select the recording format, [VIDEO] or [VR] (p. 12), then touch [OK].

■ DVD+RW

Select the aspect ratio of the movie, [16:9 WIDE] or [4:3], then touch **[OK]**.

6 Touch **[YES]**.

7 Touch **[OK]** when **[Completed.]** is displayed.

When the formatting is completed, you can start recording on the disc.

💡 Tips

- When you use a DVD-RW while the Easy Handycam operation (p. 29) is set, the recording format is fixed to VIDEO mode.

To remove the disc

- ① Perform steps **1** and **2** to open the disc cover.
- ② Press the disc holder in the center of the disc compartment, and remove the disc by holding the edge.

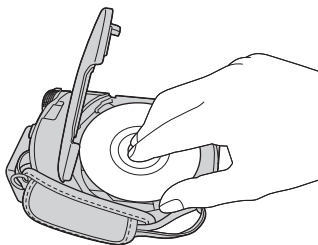

⚠ Notes

- Be careful not to obstruct the operation with your hand or other objects, etc., when opening or closing the disc cover. Move the belt to the bottom of the camcorder, then open or close the disc cover.

- If you catch the belt when closing the disc cover, it may cause your camcorder to malfunction.
- Do not touch the disc with the recording side or pickup lens (p.104).
When using a double-sided disc, take care not to smudge the surface with fingerprints.
- If you close the disc cover with the disc set incorrectly, it may cause your camcorder to malfunction.
- Do not disconnect the power sources during formatting.
- Do not apply shock or vibration to your camcorder:
 - while the ACCESS lamp is on
 - while the ACCESS lamp is flashing
 - while [DISC ACCESS] or [PREPARING TO OPEN] is displayed on the LCD screen
- It may take some time to remove the disc depending on the disc condition or recorded materials.
- It may take up to 10 minutes to remove a disc if it is damaged or is dirty with fingerprints, etc. In that case, the disc might be damaged.

💡 Tips

- You can remove the disc when a power source is connected to your camcorder even when your camcorder is turned off. However, the disc recognition process (step **4**) does not start.
- To delete all of the previously recorded images from a DVD-RW/DVD+RW, then to use it again to record new images, see “Deleting all scenes on the disc (Formatting)” on page 57.
- You can check the right disc using [DISC SELECT GUIDE] on the HOME MENU (page 56).

“Memory Stick Duo”

You can use only a “Memory Stick Duo” marked with **MEMORY STICK DUO** or **MEMORY STICK PRO DUO** (p. 99).

💡 Tips

- The number of recordable images vary, depending on the image quality or the image size. For details, see page 64.

Step 5: Inserting a disc or a “Memory Stick Duo” (Continued)

1 Open the LCD panel.

2 Insert the “Memory Stick Duo” into the “Memory Stick Duo” slot in the right direction until it clicks.

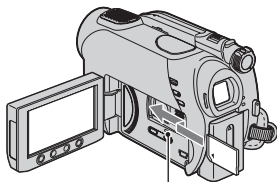

Access lamp
(“Memory Stick Duo”)

To eject a “Memory Stick Duo”

Lightly push the “Memory Stick Duo” in once and then slide it out of the slot.

⚡ Notes

- Do not try to force the “Memory Stick Duo” out. Doing so may result in damage.
- When the access lamp is lit or flashing, your camcorder is reading/writing data. Do not shake or knock your camcorder, turn the power off, eject the “Memory Stick Duo,” or remove the battery pack. Otherwise, image data may be damaged.
- If you insert the “Memory Stick Duo” into the slot in the wrong direction, the “Memory Stick Duo,” the “Memory Stick Duo” slot, or image data may be damaged.



Recording and playing back with ease (Easy Handycam)

Easy Handycam operation makes nearly all settings automatic so that you can perform recording or playing back operation without detailed settings. It also makes screen font size larger for easy viewing.

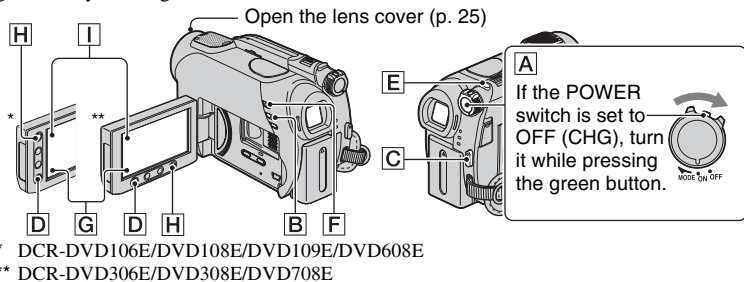

Movies



- 1 Turn the POWER switch **A** until the  (Movie) lamp turns on.



- 2 Press EASY **B**.



EASY appears on the LCD screen.

- 3 Press START/STOP **C** or **D** to start recording*.

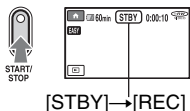

To stop recording, press START/STOP again.

Still Images



- 1 Turn the POWER switch **A** until the  (Still) lamp turns on.



- 2 Press EASY **B**.



EASY appears on the LCD screen.

- 3 Press PHOTO **E** to record a still image**.

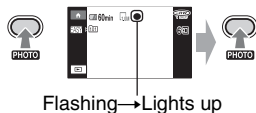

Press PHOTO **E** lightly to adjust the focus.

Press PHOTO **E** fully to record the still image.

* Movies are recorded in the [SP] recording mode.

** Still images are recorded with the [FINE] quality on the "Memory Stick Duo."

Viewing recorded movies/still images

1 Turn the POWER switch **A** to turn on your camcorder.

2 Press **VIEW IMAGES** **F** (or **G**).

The VISUAL INDEX screen appears on the LCD screen. (It may take some time to display the VISUAL INDEX screen.)

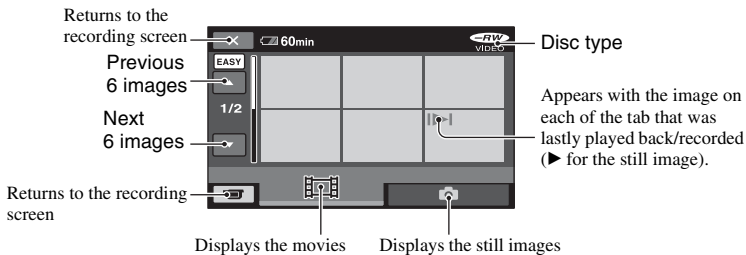

3 Start playing back.

Movies:

Touch **MOVIE**, then touch the movie you want to view.

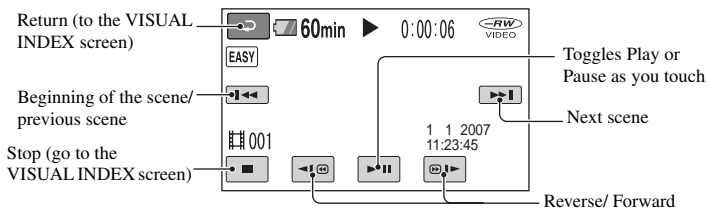





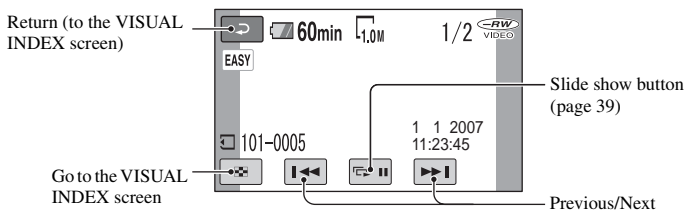

Still images:

Touch , then touch the still image you want to view.





* [DATA CODE] is fixed to [DATE/TIME] (p. 65).



Tips

- The screen returns to the VISUAL INDEX screen when the movies from the one you selected through the one at the end of the list are all played back.
- You can slow down the playback speed by touching   during pause.
- You can adjust volume by selecting  (HOME) →  (SETTINGS) → [SOUND SETTINGS] → [VOLUME], then with  / .

To cancel Easy Handycam operation

Press EASY  again.  disappears from the screen.

Menu settings during Easy Handycam operation

Press  (HOME)  (or ) to display the menu items available for setup changes (p.16, 60).

Notes

- You can neither delete nor edit movies on the disc during Easy Handycam operation.
- Most of the menu items automatically return to the default settings. The settings of some menu items are fixed. For more details, see page 83.
- DVD-RW are formatted in VIDEO mode (p. 12).
-  (OPTION) will not appear.
- Cancel Easy Handycam operation if you want to add effects to images or change settings.

Invalid buttons during Easy Handycam operation

You cannot use some buttons/functions during Easy Handycam operation since they are automatically set (p. 83). [Invalid during Easy Handycam operation.] may appear if operations not available during Easy Handycam operation are attempted.

To view movies on a disc on other devices (Finalize)

To view movies stored on a disc on a DVD device or a computer, you need to "finalize" the disc. For details on finalize operation, see page 42.

Notes

- For DVD-R, DVD+R DL, you cannot reuse the disc or record additional movies onto the disc once you finalize the disc even if the disc has free space.
- During Easy Handycam operation, the DVD menu is fixed to [STYLE1].
- You cannot record additional scenes on a finalized disc during Easy Handycam operation (p. 58).

Recording

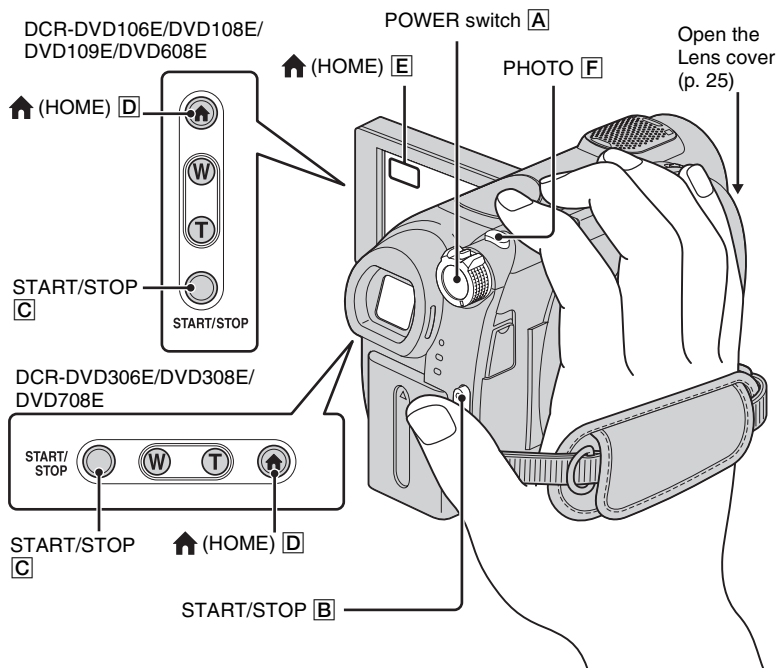

Adjusting the grip belt

Adjust and fasten the grip belt as illustrated, and hold your camcorder properly.

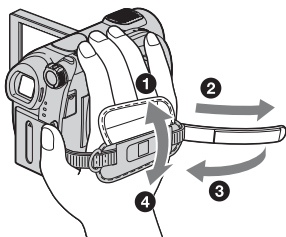

Notes

- If the access lamps (page 26, 27) is on after recording is finished, it means data is still being written onto the disc or "Memory Stick Duo." Do not apply shock or vibration to your camcorder, and do not disconnect the battery or AC Adaptor.

Movies



Movies are recorded on the disc. For recordable time, see page 12.

- 1 Turn the POWER switch **A** until the (Movie) lamp turns on.



- 2 Press START/STOP **B** (or **C**).

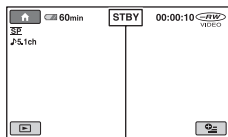

To stop recording, press START/STOP again.

Still Images



Still images are recorded on the “Memory Stick Duo.” For the number of recordable still images, see page 64.

- 1 Turn the POWER switch **A** until the (Still) lamp turns on.



- 2 Press PHOTO **F**.

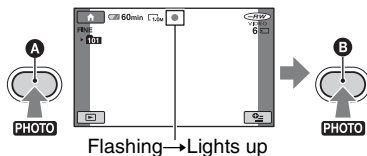

Press slightly to focus

Press full to record

appears next to . When disappears, the image has been recorded.

To switch to the movie recording mode using the (HOME) button **D** (or **E**)

Touch (CAMERA) of HOME MENU → [MOVIE] or [PHOTO].

Zooming

You can zoom in up to the magnifications shown in the following table.

	(optical zoom)
DCR-DVD106E/DVD108E/ DVD109E/DVD608E	40 ×
DCR-DVD306E/DVD308E/ DVD708E	25 ×

You can adjust the magnification with the zoom lever or the zoom button on the LCD frame.

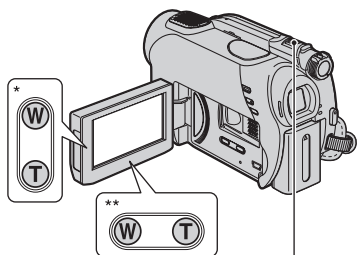

Wider range of view:
(Wide angle)

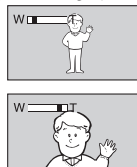

Close view: (Telephoto)

* DCR-DVD106E/DVD108E/DVD109E/
DVD608E

** DCR-DVD306E/DVD308E/DVD708E

Move the power zoom lever slightly for a slower zoom. Move it further for a faster zoom.

Notes

- [STEADYSHOT] may not reduce image blurring as desired when the power zoom lever is set to the T (Telephoto) side.

- Be sure to keep your finger on the power zoom lever. If you move your finger off the power zoom lever, the operation sound of the power zoom lever may also be recorded.
- You cannot change the zoom speed with the zoom buttons on the LCD frame.
- The minimum possible distance between camcorder and subject while maintaining sharp focus is about 1 cm (about 13/32 in.) for wide angle and about 80 cm (about 2 5/8 feet) for telephoto.

Tips

- Using [DIGITAL ZOOM] (p. 63) let you zoom in further than the magnification shown in the table.

Recording sound with more presence (5.1ch surround recording) (DCR-DVD109E/DVD306E/DVD308E/DVD708E)

Sound picked up by the built-in microphone is converted to 5.1ch surround sound and recorded.

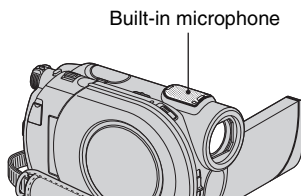

Your camcorder has Dolby Digital 5.1 Creator installed for recording 5.1ch surround sound. Enjoy realistic sound when playing the disc on devices that support 5.1ch surround sound.

Dolby Digital 5.1 Creator, 5.1ch surround sound
 Glossary (p.117)

Notes

- 5.1ch sound is converted to 2ch when played back on your camcorder.
- 5.1ch is displayed on the screen during 5.1ch recording/playback.

Recording in dark places (NightShot plus)

Infrared port



Set the NIGHTSHOT PLUS switch to ON. (☑ appears.)

Notes

- The NightShot plus and Super NightShot plus functions use infrared light. Therefore, do not cover the infrared port with your fingers or other objects, and remove the conversion lens (optional).
- Adjust the focus manually ([FOCUS], p. 73) when it is hard to focus automatically.
- Do not use the NightShot plus and Super NightShot plus functions in bright places. This may cause a malfunction.

Tips

- To record an image brighter, use Super NightShot plus function (p. 76). To record a movie more faithfully to the original colors, use Color Slow Shutter function (p. 76).

Adjusting the exposure for backlit subjects

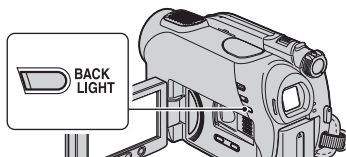

To adjust the exposure for backlit subjects, press BACK LIGHT to display ☑. To cancel the back light function, press BACK LIGHT again.

Recording in mirror mode

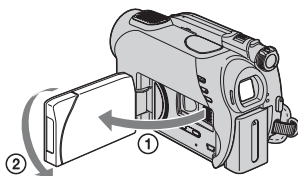

Open the LCD panel 90 degrees to the camcorder (①), then rotate it 180 degrees to the lens side (②).

Tips

- A mirror-image of the subject appears on the LCD screen, but the image will be normal when recorded.
- When recording in mirror mode, the images is not displayed in the viewfinder.

Selecting the aspect ratio (16:9 or 4:3) (DCR-DVD306E/DVD308E/DVD708E)

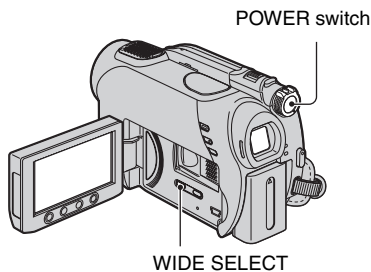

To select the aspect ratio of the movies

- ① Turn the POWER switch until the  (Movie) lamp turns on.
- ② Press WIDE SELECT repeatedly to select the desired screen aspect ratio.

Recording (Continued)

Tips

- Differences in the angle of view between 16:9 (wide) and 4:3 vary depending on the zoom position.
- When you view the movie on a TV, set [TV TYPE] to [16:9] or [4:3] according to your TV (16:9/4:3) (p. 40, 68).
- When viewing 16:9 (wide) pictures with [TV TYPE] set to [4:3], pictures may appear rough depending on subjects (p. 40).

To select the aspect ratio of the still images

- ① Turn the POWER switch until the  (Still) lamp turns on.
The aspect ratio of the picture switches to 4:3.
- ② Press WIDE SELECT repeatedly to select the desired screen aspect ratio.

Notes

- The size of still images is [0.7M] (16:9) or [1.0M] (4:3) at the maximum.

Tips

- See page 64 for the number of recordable still images.
- With the DCR-DVD106E/DVD108E/DVD109E/DVD608E, you can change the aspect ratio of movies in the HOME MENU.
For details, see page 62.

Playback

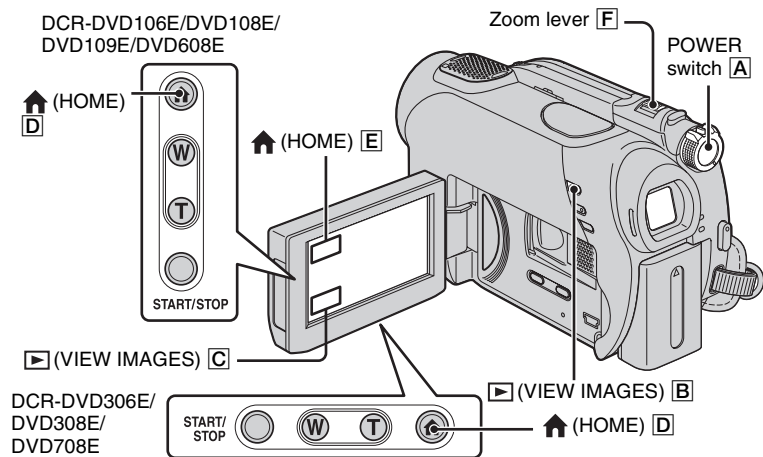

1 Turn the **POWER switch [A]** to turn on your camcorder.

2 Press **[VIEW IMAGES] [B]** (or **[C]**).

The VISUAL INDEX screen appears on the LCD screen. (It may take some time to display the VISUAL INDEX screen.)

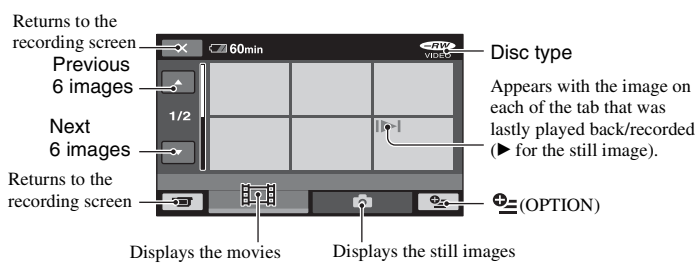

Tips

- Moving the zoom lever **[F]** let you select whether to display 6 or 12 images on the VISUAL INDEX screen. To fix this number, touch **[SETTINGS]** in the HOME MENU → [VIEW IMAGES SET] → [**DISPLAY**] (p. 66).

3 Start playing back

Movies



Touch tab and the movie to be played back.

The VISUAL INDEX screen reappears when playback from the selected movie until the last movie is completed.

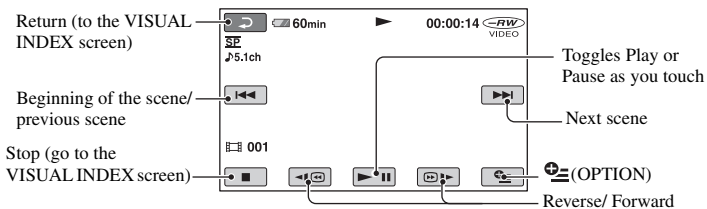

Still Images



Touch tab and the still image to be played back.

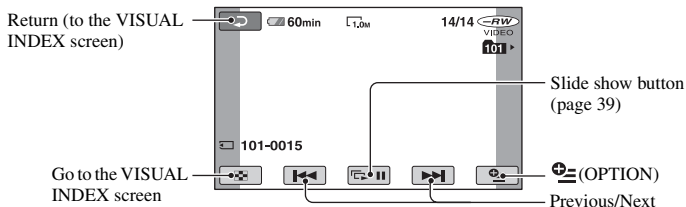

To switch to the playback mode using the (HOME) button (or)

Touch (VIEW IMAGES) → [VISUAL INDEX]

To adjust the movie volume

Touch (OPTION) → tab → [VOLUME], then adjust it with / .

Tips

- Touch / during pause to play back movie slowly.

- One touch makes the reverse/fast forward approximately 5 times faster, two touches makes it approximately 10 times* faster.
- * Approximately 8 times faster using a DVD+RW

Using PB zoom

You can magnify still images from about 1.1 to 5 times the original size. Magnification can be adjusted with the power zoom lever or the zoom buttons on the LCD frame.

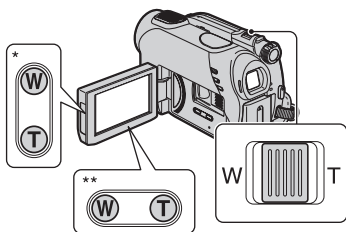

* DCR-DVD106E/DVD108E/DVD109E/DVD608E

** DCR-DVD306E/DVD308E/DVD708E

- 1 Play back the still images you want to magnify.
- 2 Magnify the still image with T (Telephoto).
The screen is framed.
- 3 Touch the screen at the point you want to display in the center of the displayed frame.
- 4 Adjust the magnification with W (Wide angle)/T (Telephoto).

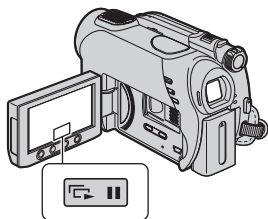

To cancel, touch .

Playing back a series of still images (Slide show)



Touch  on the still image playback screen.



The slide show begins from the selected image.

Touch  to stop the slide show. To restart, touch  again.

Notes

- You cannot operate playback zoom during slide show.

Tips

- You can set continuous slide show playback using [SLIDE SHOW SET] on  (OPTION) →  tab. The default setting is [ON] (continuous playback).

Playing the picture on a TV

Connect your camcorder to the input jack of TV or VCR using A/V connecting cable **1** or A/V connecting cable with S VIDEO **2**. Connect your camcorder to the wall socket using the supplied AC Adaptor for this operation (p.20). Refer also to the instruction manuals supplied with the devices to be connected.

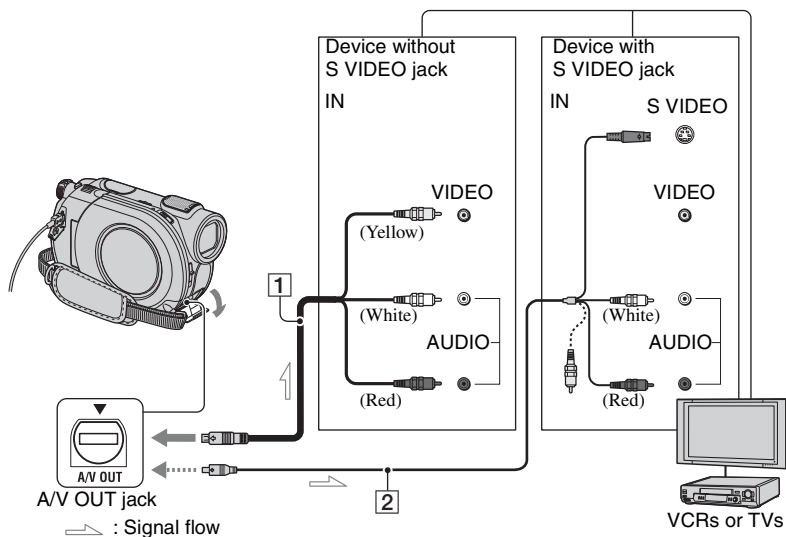

1 A/V connecting cable (supplied)

Connect to the input jack of the other device.

2 A/V connecting cable with S VIDEO (optional)

When connecting to another device via the S VIDEO jack, by using an A/V connecting cable with an S VIDEO cable (optional), higher quality pictures can be produced than with an A/V connecting cable. Connect the white and red plug (left/right audio) and the S VIDEO plug (S VIDEO channel) of the A/V connecting cable with an S VIDEO cable (optional). The yellow plug connection is not necessary. S VIDEO connection only will not output audio.

When your TV is connected to a VCR

Connect your camcorder to the LINE IN input on the VCR. Set the input selector on the VCR to LINE (VIDEO 1, VIDEO 2, etc.), if the VCR has an input selector.

To set the aspect ratio according to the connected TV (16:9/4:3)

Change the setting according to the screen aspect ratio of the TV you will view pictures on.

- 1 Turn the POWER switch to turn on your camcorder.
- 2 Touch **HOME** → **SETTINGS** → [OUTPUT SETTINGS] → [TV TYPE] → [16:9] or [4:3] → **OK**.

Notes

- When you set [TV TYPE] to [4:3], the image quality may deteriorate. Also, when the recorded picture's aspect ratio switches between 16:9 (wide) and 4:3, the image may jitter.

- When you play back a picture recorded in 16:9 (wide) aspect ratio on a 4:3 TV not compatible with the 16:9 (wide) signal, set [TV TYPE] to [4:3].

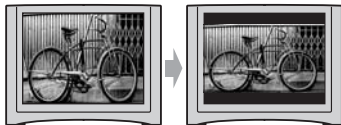

When your TV is monaural (When your TV has only one audio input jack)

Connect the yellow plug of the A/V connecting cable to the video input jack and connect the white (left channel) or the red (right channel) plug to the audio input jack of your TV or VCR.

💡 Tips

- You can display the counter on the TV screen by setting [DISP OUTPUT] to [V-OUT/PANEL] (p. 69).

If your TV/VCR has a 21-pin adaptor (EUROCONNECTOR)

Use a 21-pin adaptor (optional) to view playback picture.

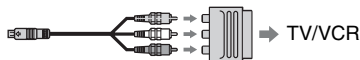

Making the disc compatible with playback on other devices or DVD drives (Finalizing)

Finalizing makes the recorded disc compatible for playback with other devices and DVD drives of computers.

Before finalizing, you can select the style of the DVD menu which displays the image list (p. 45).

Whether finalizing is required depends on the type of disc.

DVD-RW/DVD-R/DVD+R DL require finalizing.

DVD+RW do not require finalizing except in the following cases:

- ① To create a DVD menu
- ② To play back on a computer DVD drive
- ③ If the disc has a short total recording time (less than 5 min in HQ mode, 8 min in SP mode, or 15 min in LP mode)

Notes

- Playback compatibility with all device is not guaranteed.
- No DVD menu is created for DVD-RW (VR mode).

Operation flow

 To play back a disc in a DVD device for the first time (p.44)

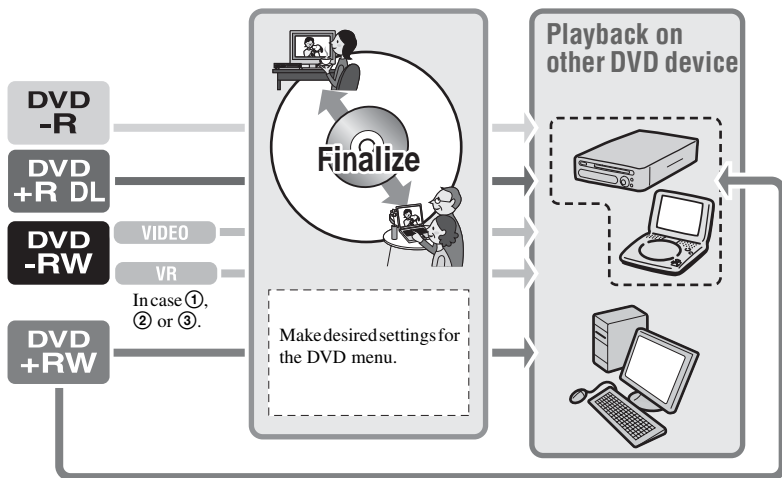

To add recordings to a finalized disc (p.58)

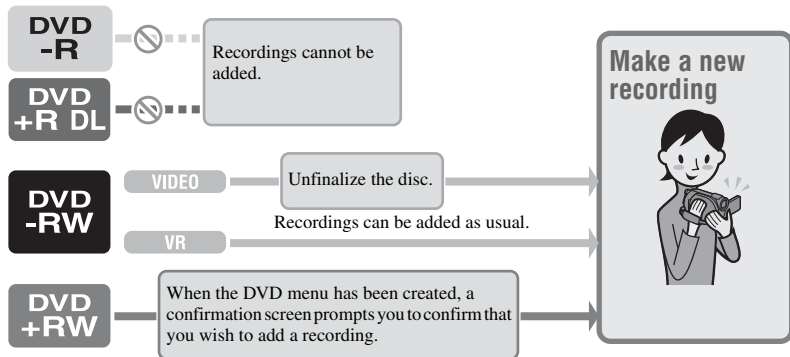

Notes

- Even when you are using a DVD-RW or DVD+RW, you cannot record additional movies onto the disc after finalizing the disc during Easy Handycam operation. To do so, cancel Easy Handycam operation (p. 31).

To play back a disc in a DVD device after adding a recording (p.44)

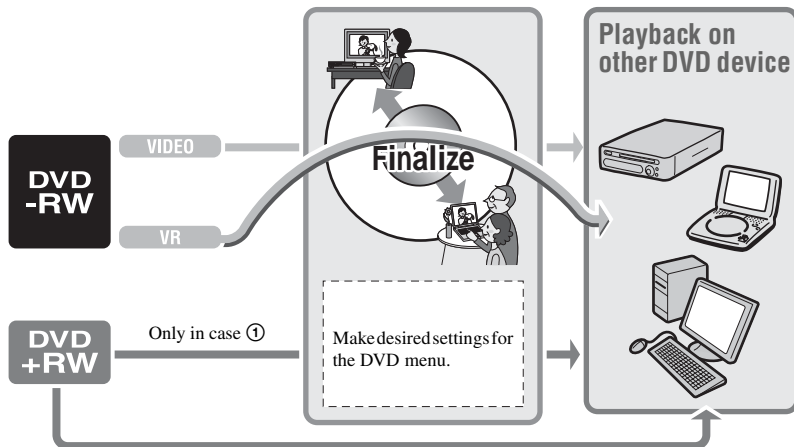

Making the disc compatible with playback on other devices or DVD drives (Finalizing) (Continued)

Finalizing a disc



Notes

- It takes from a minute to a maximum of several hours to finalize a disc. The shorter the amount of material recorded on the disc, the longer it takes for finalizing.
- Use the AC Adaptor as the power source to prevent your camcorder from running out of power during finalizing.
- When you finalize a double-sided disc, you must finalize each side of the disc individually.

1 Place your camcorder in a stable position, and connect the AC Adaptor to the DC IN jack on your camcorder.

2 Turn on the power by turning the POWER switch.

3 Insert the disc that you want to finalize.

4 Touch  (MANAGE DISC/MEMORY) of the  (HOME) menu → [FINALIZE].

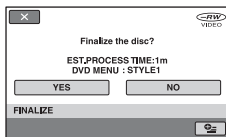

To select a DVD menu style, touch  (OPTION) → [DVD MENU] (p. 45).





Go to step **5** if you want to finalize the disc using [STYLE1] (default setting).

5 Touch [YES] → [YES].

Finalizing starts.

6 When [Completed.] appears, touch .

Notes

- Do not apply shock or vibration to your camcorder, and do not disconnect the AC Adaptor during finalizing. When you need to disconnect the AC Adaptor, make sure that the power of your camcorder is set to off and disconnect the AC Adaptor after the  (Movie) or  (Still) lamp goes off. Finalizing restarts when you connect the AC Adaptor and turn on your camcorder again. You cannot remove the disc until the finalizing operation is completed.
- When using the discs other than DVD-RW (VR mode),   flashes after finalizing is completed on the recording standby screen of your camcorder. Remove the disc from your camcorder.

Tips

- When you set to create a DVD menu and finalize the disc, the DVD menu appears for a few seconds while finalizing the disc.
- After the disc is finalized, the disc type/recording format indicator changes as shown below:

DVD-RW (VIDEO mode)



DVD-RW (VR mode)



DVD+RW



DVD-R



DVD+R DL



To select a DVD menu style



- ① In step 4, touch  (OPTION) → [DVD MENU].
- ② Select the desired style from 4 types of pattern with [←]/[→].

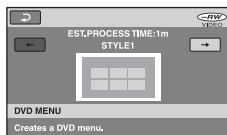

Select [NO MENU] if you do not create a DVD menu.

- ③ Touch [OK].

Notes

- The DVD menu style is fixed to [STYLE1] during the Easy Handycam operation.

(OTHERS) category

This category enables you to edit or print images on a disc or "Memory Stick Duo," or copy them onto your computer for viewing, editing or creating an original DVD.



 (OTHERS) category

Item list

DELETE

You can delete images on a disc or a "Memory Stick Duo" (p.46).

EDIT

You can edit the images on a disc or a "Memory Stick Duo" (p. 48).

PLAYLIST EDIT

You can create and edit a Playlist (p. 49).

PRINT

You can print still images on a connected PictBridge printer (p. 53).

COMPUTER

You can connect your camcorder to a computer (p. 78).

Deleting images



You can delete the images recorded on a disc or a "Memory Stick Duo" using your camcorder.

Insert a recorded disc or "Memory Stick Duo" into your camcorder.

Notes



- You cannot retrieve the deleted images.
- You cannot delete movies during Easy Handycam operation. Cancel the Easy Handycam operation first.

Tips

- You can select up to 100 images at once.
- You can delete images on the playback screen from [DELETE] under  (OPTION) →  tab.

Deleting the movies on the disc



1 Touch  (OTHERS) of the  (HOME) menu → [DELETE].

2 Touch [ DELETE].



3 Touch [ DELETE].

4 Touch the image that you want to delete.





The selected image is marked with . Press and hold the image on the LCD screen to confirm the image.

Touch  to return to the previous screen.

5 Touch  → [YES] → .



To delete all movies on the disc at one time



In step 3, touch [ DELETE ALL] → [YES] → [YES] → .

To delete the most recently recorded movie



In step 3, touch [ LAST SCENE DEL] →  → [YES] → .



Notes

- Do not remove the battery pack or the AC Adaptor from your camcorder while editing images. It may damage the disc.
- If the deleted movie is included in the Playlist (p. 49), the movie is deleted also from the Playlist.
- Even if you delete unnecessary images from the disc, the remaining disc capacity may not increase as much as you can make additional recording.
- To delete all images recorded in the disc and restore the original capacity of the disc, format the disc (page 57).

Tips

- The images recorded by this camcorder and stored onto a disc are called "original."

Deleting the still images in the "Memory Stick Duo"



1 Touch  (OTHERS) of the  (HOME) menu → [DELETE].

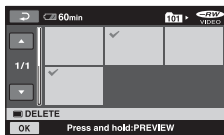

2 Touch [ DELETE].

3 Touch [ DELETE].

4 Touch the still image that you want to delete.



The selected still image is marked with . Press and hold the still image on the LCD screen to confirm the still image. Touch  to return to the previous screen.

5 Touch  → [YES] → .

To delete all still images on the "Memory Stick Duo"

In step 3, touch [ DELETE ALL] → [YES] → [YES] → .

Notes

- You cannot delete still images in the following cases:
 - "Memory Stick Duo" is write-protected.

Deleting images (Continued)

- write-protection is set to the still images by the other device.

Tips

- To delete all images recorded on the “Memory Stick Duo,” format the “Memory Stick Duo” (p. 58).



Dividing the image

DVD
-RW

VR

Notes

- You cannot divide movies during Easy Handycam operation. Cancel the Easy Handycam operation first.

1 Touch  (OTHERS) of the  (HOME) menu → [EDIT].

2 Touch [DIVIDE].

3 Touch the movie that you want to divide.

The selected movie starts playing.

4 Touch  at the point where you want to divide the movie into the scenes.

The movie pauses.

Adjusts the dividing point more precisely after the dividing point has been selected with .

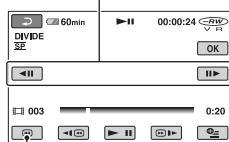

Returns to the beginning of the selected movie.

Play and pause toggles as you press



5 Touch [OK] → [YES] → [OK].

Creating the Playlist

Notes

- Movies cannot be restored once they are divided.
- Do not remove the battery pack or the AC Adaptor from your camcorder while editing images. It may damage the disc.
- Even if the divided movie is included in the Playlist, the movie is not divided in the Playlist.
- A slight difference may occur from the point where you touch  and the actual dividing point, as your camcorder selects the dividing point based on about half-second increments.

DVD
-RW



VR

A Playlist is a list showing thumbnails of the movies that you have selected. The original scenes are not changed even though you edit or delete the scenes in the Playlist.

Make sure to insert the recorded disc into your camcorder.

Notes



- You cannot add or edit movies during Easy Handycam operation. Cancel the Easy Handycam operation first.

1 Touch  (OTHERS) of the  (HOME) menu → [PLAYLIST EDIT].

2 Touch  [ADD].

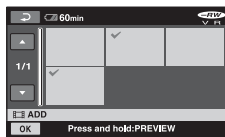
3 Touch the scene that you want to add to the Playlist.



The selected scene is marked with . Press and hold the image on the LCD screen to confirm the image. Touch  to return to the previous screen.

4 Touch [OK] → [YES] → [OK].

Creating the Playlist (Continued)



To add all the movies on the disc in the Playlist

In step 2, touch [ ADD ALL] → [YES] → [YES] → [OK].

Notes

- Do not remove the battery pack or the AC Adaptor from your camcorder while editing the Playlist. It may damage the disc.

Tips

- You can add a maximum of 999 movies to the Playlist.
- You can add a movie when viewing it using [ ADD] on [ (OPTION)] → [ tab.

Playing the Playlist

Make sure to insert the disc on which the Playlist is added into your camcorder.

1 Touch [(VIEW IMAGES) of the [(HOME) menu] → [PLAYLIST].



The images added to the Playlist are displayed on the screen.



2 Touch the scene from which you want to play back.

The Playlist is played back from the selected scene to the end, then the screen returns to the Playlist screen.

To erase added images from the Playlist at a time

- 1 Touch [ (OTHERS) of the [ (HOME) menu] → [PLAYLIST EDIT].

- 2 Touch [ERASE].

To erase all images at a time, touch [ERASE ALL] → [YES] → [YES] → [OK].

- 3 Touch the image that you want to erase from the Playlist.

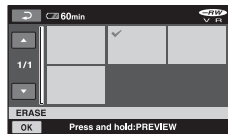

The selected image is marked with ✓.

Press and hold the image on the LCD screen to confirm the image.



Touch [] to return to the previous screen.

- 4 Touch [OK] → [YES] → [OK].

Tips

- The original images are not changed even if you erase the images from the Playlist.

Changing the order within the Playlist

- 1 Touch [ (OTHERS) of the [ (HOME) menu] → [PLAYLIST EDIT].
- 2 Touch [MOVE].
- 3 Select the image that you want to move.

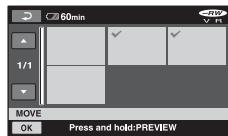

The selected scene is marked with ✓.

Press and hold the image on the LCD screen to confirm the image.

Touch [] to return to the previous screen.

- 4 Touch [OK].

- ⑤ Select the destination with [←]/[→].

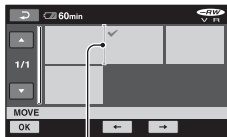

Destination bar

Press and hold the image on the LCD screen to confirm the image.

- ⑥ Touch [OK] → [YES] → [OK].

💡 Tips

- When you select multiple images, the images are moved following the order appeared in the Playlist.

Dividing a movie within the Playlist

- ① Touch (OTHERS) of the (HOME) menu → [PLAYLIST EDIT].
- ② Touch [DIVIDE].
- ③ Select the movie that you want to divide.
The playback of the selected movie starts.
- ④ Touch at the point where you want to divide the movie into scenes.
The movie pauses.

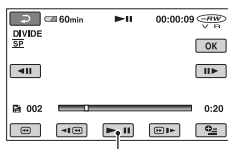

Play and pause toggles as you press



- ⑤ Touch [OK] → [YES] → [OK].

⚡ Notes

- A slight difference may occur from the point where you touch and the actual dividing point, as your camcorder selects the dividing point based on about half-second increments.

Dubbing to VCR or DVD/HDD recorders

You can dub images played back on your camcorder to other recording devices, such as VCRs or DVD/HDD recorders. Connect the device in either of the following ways.

Connect your camcorder to the wall socket using the supplied AC Adaptor for this operation (p. 20). Refer also to the instruction manuals supplied with the devices to be connected.

Notes

- Since dubbing is performed via analog data transfer, the image quality may deteriorate.

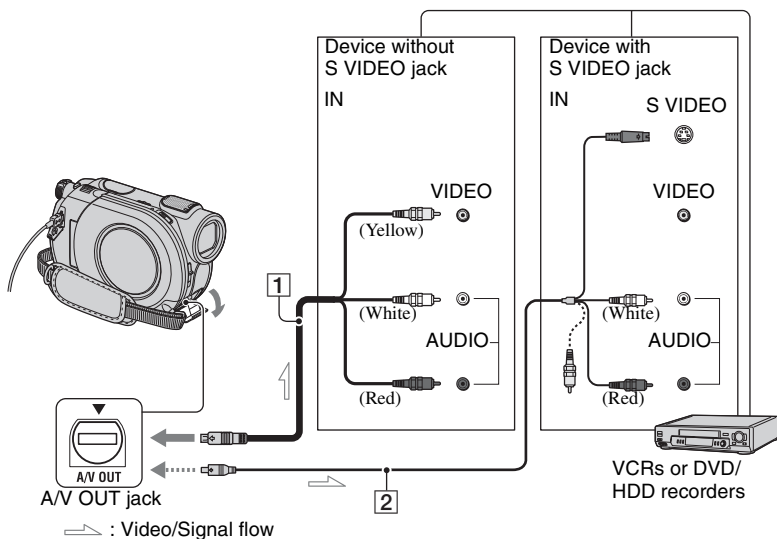

1 A/V connecting cable (supplied)

Connect to the input jack of the other device.

2 A/V connecting cable with S VIDEO (optional)

When connecting to another device via the S VIDEO jack, by using an A/V connecting cable with an S VIDEO cable (optional), higher quality images can be produced than with an A/V connecting cable. Connect the white and red plug (left/right audio) and the S VIDEO plug (S VIDEO channel) of the A/V connecting cable with an S VIDEO cable (optional). The yellow plug connection is not necessary. S VIDEO connection only will not output audio.

Notes

- To hide the screen indicators (such as a counter, etc.) on the screen of the monitor device connected, set (SETTINGS) → [OUTPUT SETTINGS] → [DISP OUTPUT] → [LCD PANEL] (the default setting) on the HOME MENU (p. 69).
- To record the date/time and camera settings data, display them on the screen (p. 65).
- When you are connecting your camcorder to a monaural device, connect the yellow plug of the A/V connecting cable to the video input jack, and the red (right channel) or the white (left channel) plug to the audio input jack on the device.

1 Insert the recorded disc into your camcorder.

2 Turn on your camcorder, and press  (VIEW IMAGES).

Set [TV TYPE] according to the display device (p. 40, 68).

3 Insert the recording media in the recording device.

If your recording device has an input selector, set it to the input mode.

4 Connect your camcorder to the recording device (VCR or DVD/HDD recorder) with the A/V connecting cable (supplied) **1** or an A/V connecting cable with S VIDEO (optional) **2**.

Connect your camcorder to the input jacks of the recording device.

5 Start the playback on your camcorder, and record it on the recording device.

Refer to the instruction manuals supplied with your recording device for details.

6 When dubbing is finished, stop the recording device, and then your camcorder.

Printing recorded images (PictBridge compliant printer)

You can print out still images using a PictBridge compliant printer, without connecting the camcorder to a computer.

PictBridge

Connect your camcorder to the AC Adaptor to obtain power from the wall socket (p. 20).

Insert the “Memory Stick Duo” containing still images into your camcorder and turn on the printer.

Connecting your camcorder to the printer

1 Turn on your camcorder.

2 Connect the  (USB) jack of your camcorder to the printer using the USB cable (p. 112).

[USB SELECT] appears on the screen automatically.

3 Touch  [PRINT].

When connection is complete,  (PictBridge connecting) appears on the screen.

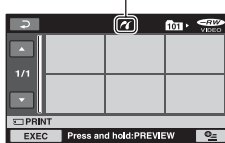

One of the still images stored on the “Memory Stick Duo” will be displayed.

Notes

- We can guarantee the operation of only models that are PictBridge compatible.

Printing

1 Touch the still image to be printed.

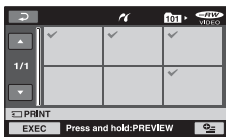

The selected image is marked with ✓.

Press and hold the image on the LCD screen to confirm the image.

Touch  to return to the previous screen.

2 Touch (OPTION), set the following options, then touch .

[COPIES]: Set number of copies of a still image to be printed. You can set up to 20 copies.

[DATE/TIME]: Select [DATE], [DAY&TIME], or [OFF] (no date/time printed).



[SIZE]: Select the paper size.

If you do not change the setting, go to step 3.



3 Touch [EXEC] → [YES] → .

The image selection screen appears again.

Notes

- Refer also to the instruction manual of the printer to be used.
- Do not attempt the following operations when  is on the screen. The operations may not be performed properly.
 - To operate the POWER switch.
 - To press  (VIEW IMAGES)
 - To disconnect the USB cable from the printer.
 - To remove the “Memory Stick Duo” from your camcorder
- If the printer stops working, disconnect the USB cable, turn the printer off and on again, and restart the operation from the beginning.
- You can select only the paper sizes that the printer can print.
- On some printer models, the top, bottom, right, and left edges of images may be trimmed. If you print a still image recorded in a 16:9 (wide) ratio, the left and right ends of the image may be trimmed widely.
- Some printer models may not support the date printing function. Refer to your printer’s instruction manual for details.
- You may not be able to print the following:
 - images edited by a computer
 - images recorded by other devices
 - images of 3MB or more
 - images with a pixel size larger than 2848×2136

Tips

- PictBridge is an industry standard established by the Camera & Imaging Products Association (CIPA). You can print still images without using a computer by connecting a printer directly to a digital video camera or digital still camera, regardless of model or manufacturer.
- You can print a still image when viewing it using  tab → [PRINT] on .

To finish printing

Touch  on the image selection screen.

(MANAGE DISC/ MEMORY) category

This category enables you to use a disc or a “Memory Stick Duo” for various purposes.



 (MANAGE DISC/MEMORY) category

Item list

FINALIZE

You can enable discs to be played on other devices by finalizing them (p. 42).

DISC SELECT GUIDE

Your camcorder advises you of the right disc for your purpose (p. 56).

FORMAT

You can format and use the disc again (p. 57).

UNFORMAT

You can format and use the “Memory Stick Duo” again (p. 58).

UNFINALIZE

You can unfinalize a disc and record more images on it (p. 58).

DISC INFO

You can display the disc information.

Playing a disc on other devices

Playing a disc on other devices

Finalizing a disc (p. 42) let you view movies recorded by your camcorder on other DVD devices. However, we do not guarantee proper playback on all devices. DVD+RW do not require finalization to be played back on other devices.

Notes

- Do not use an 8 cm CD adaptor with an 8 cm DVD as it may cause a malfunction.
- Make sure that a vertically installed device is placed in a position such as that the disc can be placed horizontally.
- Some discs cannot be played back, may freeze for an instant between scenes. Some functions may be disabled on some devices.

Tips

- Devices that support subtitles can display the recording date and time where the subtitles normally appear (p. 63). Refer to the instruction manual of your device.
- If you have created a DVD menu (p. 45), you can select the desired scene in the menu.

Playing a disc on a computer

You can play a disc on a computer if a DVD playback application is installed on the computer.

Insert the finalized disc into the DVD drive on your computer, and play back the disc using a DVD playback application.

Notes

- Even when you use a DVD+RW, you must finalize the disc (p. 42). Otherwise, it may cause a malfunction.
- Make sure that the DVD drive of the computer can play an 8 cm DVD.
- Do not use an 8 cm CD adaptor with an 8 cm DVD as it may cause a malfunction.
- The disc may not be played back, or the movies may not be played smoothly on some computers.

Playing a disc on other devices (Continued)

- Movies stored on a disc cannot be copied directly onto a computer to be played back or edited.

Tips

- For details on operations and procedures, see the “First Step Guide” on the supplied CD-ROM (p. 78).

The volume label of the disc

The date when the disc was first used is recorded (the default setting is 0:00AM January 1, 2007).

<e.g.>

When the disc was first used at 0:00 pm on January 1st 2007:

2007_01_01_00H00M_AM

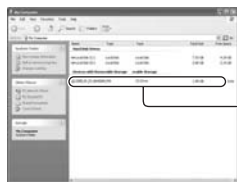



Volume
label

Tips

- Images on discs are stored in the following folders:
 - DVD-RW (VR mode)
DVD_RTAV folder
 - Other discs and modes
VIDEO_TS folder

Finding the right disc (DISC SELECT GUIDE)

Select the option that is right for you on the screen, then you will be informed of the appropriate disc for your purposes.

- 1** Touch  (MANAGE DISC/MEMORY) of the  (HOME).



- 2** Touch [DISC SELECT GUIDE].

- 3** Touch the option that is right for you on the screen.

When you answer all the questions, you will be informed of the right disc for you.

If you insert the same type of disc as indicated in [DISC SELECT GUIDE], you can format it with your selected settings.

Deleting all scenes on the disc (Formatting)



Formatting the disc



Formatting makes the recorded disc new and reusable by deleting all the data recorded on the disc. The recording capacity of the disc is recovered by formatting it.

A DVD-R/DVD+R DL cannot be formatted. Replace it with a new disc.

If you format a finalized disc



- A DVD-RW (in VIDEO mode) returns to the unfinalized state. The disc must be finalized again to view its contents on other devices.
- In the case of a DVD-RW (VR mode)/DVD+RW, formatting deletes all images on a finalized disc. One of the following icons,  or , appears on the screen, but there is no need to finalize the disc again before playing the disc on other devices.*

* To create the DVD menu on a DVD+RW, finalize the disc again (p. 42).

1 Connect the AC Adaptor to the DC IN jack on your camcorder, then connect the mains lead to the wall socket.

2 Turn on your camcorder.

3 Insert the disc that you want to format into your camcorder.

4 Touch  (MANAGE DISC/MEMORY) of the  (HOME) → [ FORMAT].

- Perform the following steps if your disc is DVD-RW or DVD+RW.

■ DVD-RW

Select [VIDEO] or [VR] for the recording format (p. 12), then touch .

■ DVD+RW

Select the aspect ratio of the movie, [16:9 WIDE] or [4:3], then touch .

5 Touch [YES].

6 Touch  when [Completed.] is displayed.

Notes

- Use the AC Adaptor as the power source to prevent your camcorder from running out of power during formatting.
- Do not apply shock or vibration to your camcorder, and do not disconnect the AC Adaptor during formatting.
- When you use a double-sided disc, formatting is required on each side. You can format each side in the different recording format.
- In the case of DVD+RW, you cannot change the movie aspect ratio midway. Format the disc again to change the aspect ratio.
- You cannot format a disc that has been protected on other devices. Cancel the protection with the original device, and then format it.

Tips



- When you use a DVD-RW while the Easy Handycam operation (p. 29) is set, the recording format is fixed to the VIDEO mode.

Deleting all scenes on the disc (Formatting) (Continued)

Formatting the “Memory Stick Duo”

Formatting deletes all images on a “Memory Stick Duo.”

- 1 Turn on your camcorder.
- 2 Insert the “Memory Stick Duo” that you want to format into your camcorder.

- 3 Touch  (MANAGE DISC/MEMORY) → [ FORMAT]

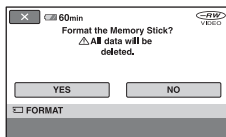

- 4 Touch [YES] → [YES].
- 5 When [Completed.] appears, touch .

Notes



- Even the still images protected with another device against accidental deletion are also deleted.
- Do not attempt the following operations when [Executing...] is on the screen:
 - To operate the POWER switch or buttons
 - To remove the “Memory Stick Duo”

Recording additional scenes after finalizing



You can record additional movies on the finalized DVD-RWs/DVD+RWs after the following steps, if the disc has free space. **When using the finalized DVD-RW (VR mode), you can record additional movies on the disc without an additional steps.**

When using a DVD-RW (VIDEO mode)(Unfinalizing)

- 1 Connect the AC Adaptor to the DC IN jack on your camcorder, then connect the mains lead to the wall socket.
- 2 Turn on your camcorder.
- 3 Insert the finalized disc into your camcorder.
- 4 Touch  (MANAGE DISC/MEMORY) of the  (HOME) → [UNFINALIZE].
- 5 Touch [YES] → [YES], then touch  when [Completed.] appears.

When using DVD+RW

If you have created a DVD menu (p. 45) during finalizing, you must perform the following steps prior to recording additional movies.

1 Connect the AC Adaptor to the DC IN jack on your camcorder, then connect the mains lead to the wall socket.

2 Turn the POWER switch to turn on the  (Movie) lamp.

3 Insert the finalized disc into your camcorder.

A confirmation screen appears to prompt you to confirm that you wish to record additional scenes.

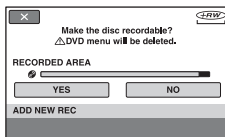

4 Touch [YES] → [YES].

5 When [Completed.] appears, touch .

Notes

- Use the AC Adaptor as power source to prevent your camcorder from running out of power during the operation.
- Do not apply shock or vibration to your camcorder, and do not disconnect the AC Adaptor during the operation.
- A DVD menu created during finalizing are deleted.
- For a double-sided disc, perform these steps for each side of the disc.
- You cannot record additional scenes on the DVD-R/DVD+R DL.

- You cannot record additional material on the disc during the Easy Handycam operation. Cancel the Easy Handycam operation.

What you can do with the (SETTINGS) category of the HOME MENU

You can change the recording functions and the operating settings for your convenience.

Using the HOME MENU

- 1 Turn on your camcorder, then press  (HOME).

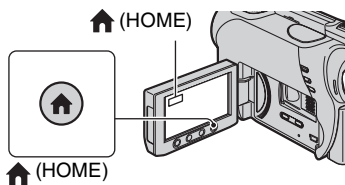

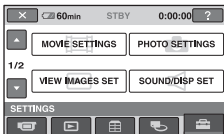

 (SETTINGS) category

- 2 Touch  (SETTINGS).



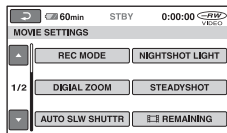

- 3 Touch the desired setup item.

If the item is not on the screen, touch  /  to change the page.



- 4 Touch the desired item.

If the item is not on the screen, touch  /  to change the page.

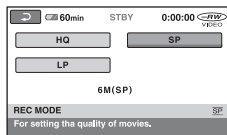

- 5 Change the setting, then touch .

List of the (SETTINGS) category items

MOVIE SETTINGS (p. 62)





Items	Page
REC MODE	62
NIGHTSHOT LIGHT	62
WIDE SELECT* ¹	62
DIGITAL ZOOM	63
STEADYSHOT	63
AUTO SLW SHUTTR	63
 REMAINING	63
SUB-T DATE	63

PHOTO SETTINGS (p. 64)

Items	Page
 IMAGE SIZE* ^{2*3}	64
 QUALITY	64
FILE NO.	64
NIGHTSHOT LIGHT	62
FLASH LEVEL* ²	65
REDEYE REDUC* ²	65

VIEW IMAGES SET (p. 65)

Items	Page
DATA CODE	65
 DISPLAY	66

SOUND/DISP SET*⁴ (p. 67)

Items	Page
VOLUME* ³	67
BEEP* ³	67
LCD BRIGHT	67
LCD BL LEVEL	67
LCD COLOR	67
VF B.LIGHT	67

OUTPUT SETTINGS (p. 68)

Items	Page
TV TYPE	68
DISP OUTPUT	69

CLOCK/ LANG (p. 69)

Items	Page
CLOCK SET* ³	23
AREA SET	69
SUMMERTIME	69
 LANGUAGE SET* ³	69

GENERAL SET (p. 70)

Items	Page
DEMO MODE	70
CALIBRATION	103
A.SHUT OFF	70
REMOTE CTRL* ²	70

*1 DCR-DVD106E/DVD108E/DVD109E/DVD608E

*2 DCR-DVD306E/DVD308E/DVD708E

*3 Also available during Easy Handycam operation.

*4 Only [SOUND SETTINGS] is available during Easy Handycam operation.

MOVIE SETTINGS

(Items for recording movies)

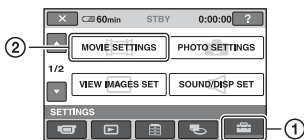

Touch ①, then ②.

If the item is not on the screen, touch ▲/▼ to change the page.

How to set

🏠 (HOME MENU) → page 60

⊕ (OPTION MENU) → page 71

The default settings are marked with ▶.

REC MODE (Recording mode)



You can select an image quality of the movie from three levels.

HQ

Records in high quality mode.
(9M (HQ))

▶ SP

Records in standard quality mode.
(6M (SP))

LP

Increases the recording time (Long Play).
(3M (LP))

⚙ Notes

- If you record in the LP mode, the quality of scenes may be degraded, or scenes with quick movements may appear with a block noise when you play back the disc.

💡 Tips

- See page 12 on the expected recording time of each recording mode.

NIGHTSHOT LIGHT



When using the NightShot plus (p. 35) or [S. NIGHTSHOT PLS] (p. 76) function to record, you can record clearer images by setting [NIGHTSHOT LIGHT], which emits infrared light (invisible), to [ON] (the default setting).

⚙ Notes

- Do not cover the infrared port with your fingers or other objects (p. 111).
- Remove the conversion lens (optional).
- The maximum shooting distance using [NIGHTSHOT LIGHT] is about 3 m (10 feet).

WIDE SELECT (DCR-DVD106E/DVD108E/DVD109E/DVD608E)



You can select the aspect ratio according to the TV connected. Refer also to the instruction manuals supplied with your TV.

▶ 4:3

Records images to the full screen on a 4:3 TV screen.

16:9 WIDE (16:9)

Records images to the full screen on a 16:9 (wide) TV screen.

⚙ Notes

- Set [TV TYPE] correctly according to the TV connected for playback (p. 68).

DIGITAL ZOOM



You can select the maximum zoom level in case you want to zoom greater than optical zoom magnification (p. 34). Note that the image quality decreases when you use the digital zoom.

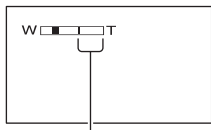

The right side of the bar shows the digital zooming factor. The zooming zone appears when you select the zooming level.

For DCR-DVD106E/DVD108E/DVD109E/DVD608E

▶ OFF

Up to 40× zoom is performed optically.

80×

Up to 40× zoom is performed optically, and after that up to 80× zoom is performed digitally.

2000×

Up to 40× zoom is performed optically, and after that, up to 2,000× zoom is performed digitally.

For DCR-DVD306E/DVD308E/DVD708E

▶ OFF

Up to 25× zoom is performed optically.

50×

Up to 25× zoom is performed optically, and after that up to 50× zoom is performed digitally.

2000×

Up to 25× zoom is performed optically, and after that, up to 2,000× zoom is performed digitally.

STEADYSHOT



You can compensate for camera shake (the default setting is [ON]). Set [STEADYSHOT] to [OFF] (🚫) when using a tripod (optional), then the image becomes natural.

AUTO SLW SHUTTR (Auto slow shutter)



When this is set to [ON] (the default setting), the shutter speed is automatically reduced to 1/25 second when recording in dark conditions.

REMAINING



▶ AUTO

Displays the remaining disc indicator for about 8 seconds in situations such as those described below.

- When your camcorder recognizes the remaining disc capacity with the POWER switch set to (Movie).
- When you press DISP/BATT INFO to switch the indicator from off to on with the POWER switch set to (Movie).
- When you select the movie recording mode on the HOME MENU.

ON

Always displays the remaining disc indicator.

🔔 Notes

- When the remaining recordable time for movies is less than 5 minutes, the indicator stays on the screen.

SUB-T DATE



Select [ON] (the default setting) to display the recording date and time when you play back a disc on a device with a subtitle display function. Also refer to the instruction manual of the playback device.

PHOTO SETTINGS

(Items for recording still images)



Touch ①, then ②.

If the item is not on the screen, touch ▲/▼ to change the page.

How to set

🏠 (HOME MENU) → page 60

⊕ (OPTION MENU) → page 71

The default settings are marked with ▶.

IMAGE SIZE (DCR-DVD306E/DVD308E/DVD708E)

▶ 1.0M (1.0M)

Records still images clearly.

VGA (0.3M) (VGA)

Allows for the maximum number of images to be recorded.

Notes

- When the picture ratio is changed to 16:9, the image size is changed to [0.7M] (0.7M) (p. 36).
- You can only select the image size for still images.

Tips

- The image size of DCR-DVD106E/DVD108E/DVD109E/DVD608E is set to [VGA (0.3M)](VGA).

Number of still images recordable on a “Memory Stick Duo” (approx.)

	1.0M 1152 × 864 1.0M	0.7M 1152 × 648 0.7M	VGA (0.3M) 640 × 480 VGA
64MB	120 325	160 390	390 980
128MB	245 650	325 780	780 1970

	1.0M 1152 × 864 1.0M	0.7M 1152 × 648 0.7M	VGA (0.3M) 640 × 480 VGA
256MB	445 1150	590 1400	1400 3550
512MB	900 2400	1200 2850	2850 7200
1GB	1800 4900	2450 5900	5900 14500
2GB	3750 10000	5000 12000	12000 30000
4GB	7400 19500	9500 23500	23500 59000

Notes

- All numbers measured at the following settings:
Top: [FINE] is selected for image quality.
Bottom: [STANDARD] is selected for image quality.
- When using the “Memory Stick Duo” made by Sony Corporation. The number of recordable still images varies depending on the recording environment.

QUALITY

▶ FINE (FINE)

Records still images at the fine image quality level.

STANDARD (STD)

Records still images at the standard image quality level.

FILE NO. (File number)

▶ SERIES

Assigns file numbers in sequence even if the “Memory Stick Duo” is replaced with another one.

RESET

Assigns file numbers for each “Memory Stick Duo.”

NIGHTSHOT LIGHT

See page 62.

FLASH LEVEL (DCR-DVD306E/DVD308E/DVD708E)



You can set this function when you use an external flash (optional) that is compatible with your camcorder.

HIGH(⚡+)

Makes the flash level higher.

► NORMAL(⚡)

LOW(⚡-)

Makes the flash level lower.

REDEYE REDUC (Redeye reduction) (DCR-DVD306E/DVD308E/DVD708E)



You can set this function when you use an external flash (optional) that is compatible with your camcorder.

You can prevent redevye by activating the flash before recording.

Set [REDEYE REDUC] to [ON] to use this function.

🔊 Notes

- The redevye reduction may not produce the desired effect due to individual differences and other conditions.

VIEW IMAGES SET

(Items to customize the display)



Touch ①, then ②.

If the item is not on the screen, touch ▲/▼ to change the page.

How to set

🏠 (HOME MENU) → page 60

⊕ (OPTION MENU) → page 71

The default settings are marked with ►.

DATA CODE



During playback, displays the information (data code) recorded automatically at the time of recording.

► OFF

Data code is not displayed.

DATE/TIME

Displays the date and time.

CAMERADATA (below)

Displays camera setting data.

DATE/TIME

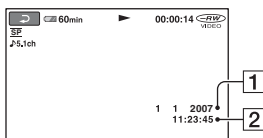

1 Date

2 Time

CAMERADATA

Movie

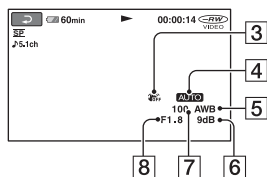

Still image

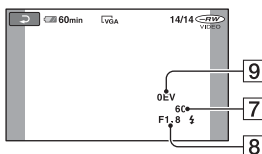

- 3 SteadyShot off
- 4 Brightness
- 5 White balance
- 6 Gain
- 7 Shutter speed
- 8 Aperture value
- 9 Exposure

💡 Tips

- appears in the following cases:
 - during displaying still images recorded using an external flash (DCR-DVD306E/DVD308E/DVD708E).
 - during displaying still images recorded by another device using a flash.
- The data code is displayed on the TV screen if you connect your camcorder to a TV.
- The indicator toggles through the following sequences as you press DATA CODE on the Remote Commander: [DATE/TIME] → [CAMERADATA] → [OFF] (no indication)(DCR-DVD306E/DVD308E/DVD708E).
- Depending on the disc condition, bars [---:--:--] appear.

DISPLAY



You can select the number of thumbnails that appear on the VISUAL INDEX screen.

► ZOOM LINK

Change the number of thumbnails (6 or 12) with the zoom lever on your camcorder.*

6IMAGES

Displays thumbnails of 6 images.

12IMAGES

Displays thumbnails of 12 images.

* You can operate with the zoom buttons on the LCD frame or on the Remote Commander (For DCR-DVD306E/DVD308E/DVD708E).

SOUND/DISP SET

(Items to adjust beep and the screen)



Touch ①, then ②.
If the item is not on the screen, touch ▲/▼
to change the page.

How to set

🏠 (HOME MENU) → page 60
⊕ (OPTION MENU) → page 71

The default settings are marked with ▶.

VOLUME



Touch / to adjust the volume
(p. 38).

BEEP



▶ ON

A melody sounds when you start/stop recording, or operate the touch panel.

OFF

Cancels the melody and shutter sound.

LCD BRIGHT



You can adjust the brightness of the LCD screen.

- Adjust the brightness with /.
- Touch .

💡 Tips

- This adjustment does not affect the recorded images in any way.

LCD BL LEVEL (LCD backlight level)



You can adjust the brightness of the LCD screen's backlight.

▶ NORMAL

Standard brightness.

BRIGHT

Brightens the LCD screen.

💡 Notes

- When you connect your camcorder to outside power sources, [BRIGHT] is automatically selected for the setting.
- When you select [BRIGHT], battery life is slightly reduced during recording.
- If you open the LCD panel 180 degrees to face the screen outside and close the LCD panel to the camcorder body, the setting becomes [NORMAL] automatically.

💡 Tips

- This adjustment does not affect the recorded images in any way.

LCD COLOR



You can adjust the color of the LCD screen with /.



Low intensity ← High intensity

💡 Tips

- This adjustment does not affect the recorded images in any way.

VF B. LIGHT (Viewfinder brightness)



You can adjust the brightness of the viewfinder.

▶ NORMAL

Standard brightness.

BRIGHT

Brightens the viewfinder screen.

💡 Notes

- When you connect your camcorder to outside power sources, [BRIGHT] is automatically selected for the setting.
- When you select [BRIGHT], battery life is slightly reduced during recording.

OUTPUT SETTINGS

(Items for when connecting other devices)

Tips

- This adjustment does not affect the recorded images in any way.

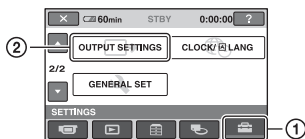

Touch ①, then ②.

If the item is not on the screen, touch ▲/▼ to change the page.

How to set

🏠 (HOME MENU) → page 60

☰ (OPTION MENU) → page 71

The default settings are marked with ▶.

TV TYPE

You need to convert the signal depending on the TV connected when playing back the image. The recorded images are played back as following illustrations.

16:9

**(Default setting for DCR-DVD306E/
DVD308E/DVD708E)**

Select to view your images on a 16:9 (wide) TV.

Wide (16:9)
images

4:3 images



4:3

**(Default setting for DCR-DVD106E/
DVD108E/DVD109E/DVD608E)**

Select to view your images on a 4:3 standard TV.

Wide (16:9)
images

4:3 images



CLOCK/LANG

(Items to set clock and language)

DISP OUTPUT

► LCD PANEL

Shows displays such as the time code on the LCD screen and in the viewfinder.

V-OUT/PANEL

Shows displays such as the time code on the TV screen, LCD screen, and in the viewfinder.

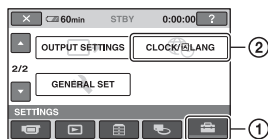

Touch ①, then ②.

If the item is not on the screen, touch ▲/▼ to change the page.

How to set

 (HOME MENU) → page 60

 (OPTION MENU) → page 71

CLOCK SET

See page 23.

AREA SET

You can adjust a time difference without stopping the clock.

Set your local area using ▲/▼ when using your camcorder overseas.

Refer to the world time difference on page 97.

SUMMERTIME

You can change this setting without stopping the clock.

Set to [ON] to move the time forward 1 hour.

LANGUAGE SET

You can select the language to be used on the LCD screen.

Tips

- Your camcorder offers [ENG[SIMP]] (simplified English) for when you cannot find your native tongue among the options.

GENERAL SET

(Other setup items)

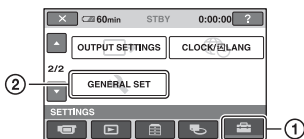

Touch ①, then ②.

If the item is not on the screen, touch ▲/▼ to change the page.

How to set

🏠 (HOME MENU) → page 60

⊕ (OPTION MENU) → page 71

The default settings are marked with ▶.

DEMO MODE



The default setting is [ON], allowing you to view the demonstration in about 10 minutes, after you turn the POWER switch to (Movie).

💡 Tips

- The demonstration will be suspended in situations such as those described below.
 - When you press START/STOP.
 - When you touch the screen during the demonstration (The demonstration starts again after about 10 minutes).
 - When you slide the disc cover open switch.
 - When you remove or insert a “Memory Stick Duo.”
 - When you set the POWER switch to (Still).
 - When you press 🏠 (HOME)/ (VIEW IMAGES).

CALIBRATION



See page 103.

A.SHUT OFF (Auto shut off)



▶ 5min

The camcorder is automatically turned off when you do not operate your camcorder for more than approximately 5 minutes.

NEVER

The camcorder is not automatically turned off.

🔊 Notes

- When you connect your camcorder to a wall socket, [A.SHUT OFF] is automatically set to [NEVER].

REMOTE CTRL (Remote control) (DCR-DVD306E/DVD308E/DVD708E)



The default setting is [ON], allowing you to use the supplied Remote Commander (p. 113).

💡 Tips

- Set to [OFF] to prevent your camcorder from responding to a command sent by another VCR remote control unit.

Activating functions using the OPTION MENU

The OPTION MENU appears just like the pop-up window that appears when you right-click the mouse on a computer. Various functions are displayed in the context of the operation.

Using the OPTION MENU

- 1 While using your camcorder, touch  (OPTION) on the screen.

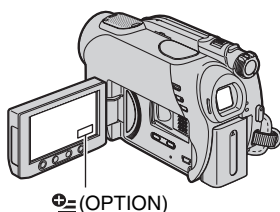

Tab

- 2 Touch the desired item.

If you cannot find the desired item, touch another tab to change the page.

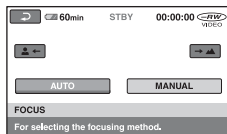

- 3 Change the setting, then touch .

When the item you want is not on the screen



Touch another tab. If you cannot find the item anywhere, the function does not work under the situation.



Notes





- The tabs and items that appear on the screen depend on the recording/playback status of your camcorder at the time.
- Some items appear without a tab.
- The OPTION MENU cannot be used during Easy Handycam operation.

Recording items on the OPTION MENU

See page 71 for setting operation.

Items	 *	Page
 tab		
FOCUS	-	73
SPOT FOCUS	-	73
TELE MACRO	-	73
EXPOSURE	-	74
SPOT METER	-	74
SCENE SELECTION	-	74
WHITE BAL.	-	75
COLOR SLOW SHTR	-	76
S. NIGHTSHOT PLS	-	76

Items	 *	Page
 tab		
FADER	-	76
D.EFFECT	-	77
PICT.EFFECT	-	77



Items	 *	Page
 tab		
REC MODE	○	62
MICREF LEVEL	-	77
 IMAGE SIZE**	○	64
 QUALITY	○	64
SELF-TIMER	-	77
FLASH MODE**	-	77

* Items that are included also in the HOME MENU.





** DCR-DVD306E/DVD308E/DVD708E

Viewing items on the OPTION MENU

See page 71 for setting operation.

Items	 *	Page
 tab		
DELETE	○	46
DELETE ALL	○	47
 tab		
DIVIDE	○	48
ERASE	○	50
ERASE ALL	○	50
MOVE	○	50

-- (A tab depends on the situation)

 ADD	○	50
 ADD ALL	○	50
PRINT	○	53
SLIDE SHOW	-	39
VOLUME	○	67
DATA CODE	○	65
SLIDE SHOW SET	-	39
 ADD	○	49
 ADD ALL	○	50

-- (No tab)

COPIES	-	54
DATE/TIME	-	54
SIZE	-	54
DVD MENU	-	45

* Items that are included also in the HOME MENU.

Functions set in the OPTION MENU

Items you can set only on the OPTION MENU will be described below.

How to set

🏠 (HOME MENU) → page 60

☰ (OPTION MENU) → page 71

The default settings are marked with ▶.

FOCUS

You can adjust the focus manually. You can select this function also when you want to focus on a certain subject intentionally.



① Touch [MANUAL].

☞ appears.

② Touch [] (focusing on close subjects)/

[] (focusing on distant subjects) to sharpen the focus. 👤 appears when the focus cannot be adjusted any closer, and ▲ appears when the focus cannot be adjusted farther away.

③ Touch [OK].

To adjust the focus automatically, touch [AUTO] → [OK] in step ①.

Notes

- The minimum possible distance between camcorder and subject while maintaining sharp focus is about 1 cm (about 13/32 in.) for wide angle and about 80 cm (about 2 5/8 feet) for telephoto.

Tips

- It is easier to focus on the subject by moving the power zoom lever towards T (telephoto) to adjust the focus, then towards W (wide angle) to adjust the zoom for recording. When you want to record a subject at close range, move the power zoom lever to W (wide angle), then adjust the focus.
- The focal distance information (the distance at which the subject is focused on, for when it is dark and hard to adjust focus) appears for a few seconds in the following cases. (It will not be

displayed correctly if you are using a conversion lens (optional).)

- When the focus mode is switched from automatic to manual.
- When you set focus manually

SPOT FOCUS

You can select and adjust the focal point to aim it at a subject not located at the center of the screen.

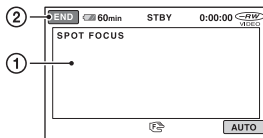

① Touch the subject on the screen.

☞ appears.

② Touch [END].

To adjust the focus automatically, touch [AUTO] → [END] in step ①.

Notes

- If you set [SPOT FOCUS], [FOCUS] is automatically set to [MANUAL].

TELE MACRO

This is useful to shoot small subjects, such as flowers or insects. You can blur out backgrounds and the subject stands out clearer.

When you set [TELE MACRO] to [ON] (T), the zoom (p. 34) moves to the top of the T (telephoto) side automatically and allows recording subjects at a close distance as follows;

DCR-DVD106E/DVD108E/DVD109E/
DVD608E

down to about 43 cm (17 in.)

DCR-DVD306E/DVD308E/DVD708E
down to about 38 cm (15 in.)



Functions set in the OPTION MENU (Continued)

To cancel, touch [OFF], or zoom to wide-angle (W side).

🔊 Notes

- When recording a distant subject, focusing may be difficult and can take some time.
- Adjust the focus manually ([FOCUS], p. 73) when it is hard to focus automatically.

EXPOSURE



You can fix the brightness of an image manually. Adjust [EXPOSURE] when the subject is too bright or too dark relative to the background.

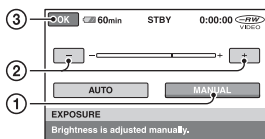

- 1 Touch [MANUAL].

↔ appears.

- 2 Adjust the exposure by touching [−] / [+] .

- 3 Touch [OK].

To return the setting to automatic exposure, touch [AUTO] → [OK] in step ①.

SPOT METER (Flexible spot meter)



You can adjust and fix the exposure to the subject, so that it is recorded in suitable brightness even when there is strong contrast between the subject and the background, such as subjects in the spotlight on stage.

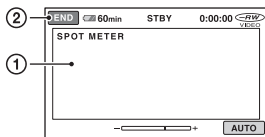

- 1 Touch the point where you want to fix and adjust the exposure on the screen.

↔ appears.

- 2 Touch [END].

To return the setting to automatic exposure, touch [AUTO] → [END] in step ①.

🔊 Notes

- If you set [SPOT METER], [EXPOSURE] is automatically set to [MANUAL].

SCENE SELECTION



You can record images effectively in various situations with the [SCENE SELECTION] function.

▶ AUTO

Select this to automatically record images effectively without the [SCENE SELECTION] function.

TWILIGHT* (🌙)

Select this to take night view without losing the mood.



CANDLE (🕯)



Select this to take scene without losing candle mood.

SUNRISE&SUNSET* (🌅)



Select this to reproduce the atmosphere of scenes such as sunsets or sunrises.

FIREWORKS* (💣)



Select this to take spectacular shots of fireworks.

LANDSCAPE* (🏞️)



Select to shoot distant subjects clearly. This setting also prevents your camcorder from focusing on glass or metal mesh in windows that comes in between the camcorder and the subject.

PORTRAIT (👤)



Select to bring out the subject such as people or flowers while creating a soft background.

SPOTLIGHT** (💡)



Select to prevent people's faces from appearing excessively white when subjects are lit by strong light.

SPORTS** (Sports lesson) (🏊)



Select to minimize shake when shooting fast moving subjects.

BEACH** (🏖️)



Select to take the vivid blue of the ocean or a lake.

SNOW** (❄️)



Select to take bright pictures of a white landscape.

* Your camcorder is set to focus only on distant subjects.

** Your camcorder is set not to focus on nearby subjects.

🔔 Notes

- The [WHITE BAL.] setting is cleared when you set [SCENE SELECTION].

WHITE BAL. (White balance)



You can adjust the color balance to the brightness of the recording environment.

▶ AUTO

The white balance is adjusted automatically.

OUTDOOR (☀️)

The white balance is adjusted to be appropriate for the following recording conditions:

- Outdoors
- Night views, neon signs and fireworks
- Sunrise or sunset
- Under daylight fluorescent lamps

INDOOR (💡)

The white balance is adjusted to be appropriate for the following recording conditions:

- Indoors
- At party scenes or studios where the lighting conditions change quickly
- Under video lamps in a studio, or under sodium lamps or incandescent-like color lamps

ONE PUSH (📷)





The white balance will be adjusted according to the ambient light.

- ① Touch [ONE PUSH].
- ② Frame a white object such as a piece of paper, to fill the screen under the same lighting conditions as you will shoot the subject.
- ③ Touch [📷].

📷 flashes quickly. When the white balance has been adjusted and stored in the memory, the indicator stops flashing.

Functions set in the OPTION MENU (Continued)

🔊 Notes

- Set [WHITE BAL.] to [AUTO] or adjust the color in [ONE PUSH] under white or cool white fluorescent lamps.
- While  is flashing quickly during [ONE PUSH] setting, continue to frame a white object until  stops flashing.
-  flashes slowly if [ONE PUSH] could not be set.
- When [ONE PUSH] was selected, if  keeps flashing after touching [OK], set [WHITE BAL.] to [AUTO].
- If you set [WHITE BAL.], [SCENE SELECTION] is automatically set to [AUTO].

💡 Tips

- If you change the battery pack with [AUTO] selected, or take your camcorder outdoors after inside use (or vice versa), select [AUTO] and aim your camcorder at a nearby white object for about 10 seconds for better color balance adjustment.
- If you change the [SCENE SELECTION] settings or move your camcorder outdoors during white balance setting with [ONE PUSH], you need to repeat the [ONE PUSH] operation.

COLOR SLOW SHTR (Color Slow Shutter)



When you set [COLOR SLOW SHTR] to [ON], you can record an image brighter in color even in dark places.

 appears on the screen.

To cancel [COLOR SLOW SHTR], touch [OFF].

🔊 Notes

- Adjust the focus manually ([FOCUS], p. 73) when it is hard to focus automatically.
- The shutter speed of your camcorder changes depending on the brightness, which may result in a slowdown of the motion of the image.

S. NIGHTSHOT PLS (Super NightShot plus)



The image will be recorded at a maximum of 16 times the sensitivity of NightShot plus recording if you set [S. NIGHTSHOT PLS]

to [ON] while the NIGHTSHOT PLUS switch (p. 35) is also set to ON.  appears on the screen.

To return to the normal setting, set [S. NIGHTSHOT PLS] to [OFF].

🔊 Notes

- Do not use [S. NIGHTSHOT PLS] in bright places. This may cause a malfunction.
- Do not cover the infrared port with your fingers or other objects (p. 111).
- Adjust the focus manually ([FOCUS], p. 73) when it is hard to focus automatically.
- The shutter speed of your camcorder changes depending on the brightness, which may result in a slowdown of the motion of the image.

FADER



You can record a transition with the following effects adding to the interval between scenes.

- ① Select the desired effect in [STBY] (during fading in) or [REC] (during fading out) mode, then touch [OK].
- ② Press START/STOP.

The fader indicator stops flashing and disappears when the fade is complete.

To cancel the fader before starting the operation, touch [OFF] in step ①. If you press START/STOP, the setting is canceled.



WHITE FADER



BLACK FADER



D.EFFECT (Digital effect)



When [OLD MOVIE] is selected,  appears on the screen and you can record with an old movie-type atmosphere to your movies.

To cancel [D.EFFECT], touch [OFF].

PICT.EFFECT (Picture effect)



You can add special effects to an image during recording or playback.  appears.

► OFF

Does not use [PICT.EFFECT] setting.

SEPIA

Images appear in sepia.

B&W

Images appear in black and white.

PASTEL



Images appear as a pale pastel drawing.

MICREF LEVEL



You can select the microphone level for recording sound.

Select [LOW] when you want to record exciting and powerful sound in a concert hall, etc.

► NORMAL

Records various surround sounds, converting them into the certain level.

LOW (⇓)

Records surround sound faithfully. This setting is not suitable for recording conversations.

SELF-TIMER



The self-timer records a still image about 10 seconds after being set.

Press PHOTO to record still images when [SELF-TIMER] is set to [ON] and  appears.

To cancel the count down, touch [RESET].
To cancel the self-timer, select [OFF].

💡 Tips

- You can also operate by pressing PHOTO on the Remote Commander (p. 113) (DCR-DVD306E/DVD308E/DVD708E).

FLASH MODE (DCR-DVD306E/DVD308E/DVD708E)



You can set this function when you use an external flash (optional) that is compatible with your camcorder.

Attach the external flash to the Active Interface Shoe (p. 111).

► ON (⚡)

Flashes every time.

AUTO

Flashes automatically.

What you can do with Windows computer

When you install the “Picture Motion Browser” on a Windows computer from the supplied CD-ROM, you can enjoy the following operations.

🔔 Tips

- See page 82 when you use a Macintosh computer.

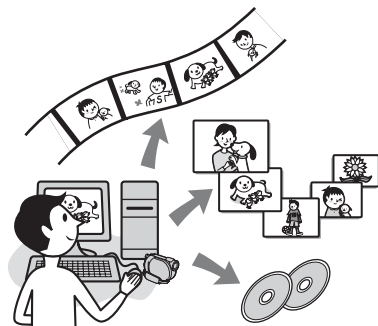

Main functions

■ Importing movies taken with your camcorder

■ Viewing movies imported to a computer

You can manage movies and still images by date and time of shooting, and select movies or still images you want to view as thumbnails. These thumbnails can be enlarged and played in a slide show.

■ Editing images imported to a computer

■ Creating an original DVD

You can create an original DVD from image data imported from your camcorder.

■ Copying a disc → Video Disc Copier

You can copy all the images on a disc taken with your camcorder.

About “First Step Guide”

The “First Step Guide” is an instruction manual you can refer to on your computer. This describes basic operations, from initial hookup of your camcorder and computer and making settings, to general operation the first time you use the software “Picture Motion Browser” stored on the CD-ROM (supplied).

Referring to “Installing the “First Step Guide”” (p. 79), start the “First Step Guide”, then follow the instructions.

About the help function of the software

The Help guide explains all the functions of all the software applications. Refer to the Help guide for further detailed operations after reading the “First Step Guide” thoroughly.

To display the Help guide, click the  mark on the screen.

System requirements

When using “Picture Motion Browser”

OS: Microsoft Windows 2000 Professional, Windows XP Home Edition, Windows XP Professional or Windows XP Media Center Edition

Standard installation is required.

Operation is not assured if the above OS has been upgraded or in a multi-boot environment.

CPU: Intel Pentium III 1 GHz or faster.

Application: DirectX 9.0c or later (This product is based on DirectX technology. It is necessary to have DirectX installed.)

Sound system: Direct Sound compatible sound card

Memory: 256 MB or more

Hard disk:

Disc volume required for installation:
Approximately 600 MB (5 GB or more
may be necessary when creating DVD
videos.)

Display: DirectX 7 or later-compatible video
card, Minimum 1024 × 768 dots, High
Color (16 bit color)

Others: ⚡ USB port (this must be provided
as standard, Hi-Speed USB (USB 2.0
compatible) is recommended), Disc drive
that can burn DVDs (CD-ROM drive
required for software installation)

When playing still images recorded on a “Memory Stick Duo” on a computer

OS: Microsoft Windows 2000 Professional,
Windows XP Home Edition, Windows XP
Professional or Windows XP Media Center
Edition
Standard installation is required.
Operation is not assured if the above OS
has been upgraded.

CPU: MMX Pentium 200 MHz or faster

Others: ⚡ USB port (this must be provided
as standard)

📌 Note

- Operations are not guaranteed on all the recommended environments. For example, other open or background applications running on currently may limit product performance.

💡 Tips

- If your computer has a Memory Stick slot, insert the “Memory Stick Duo” on which still images are recorded into the Memory Stick Duo Adaptor (optional), then insert it into the Memory Stick slot on your computer to copy still images to the computer.
- When using a “Memory Stick PRO Duo” and your computer is not compatible with it, connect your camcorder with the USB cable instead of using the Memory Stick slot on the computer.

Installing the “First Step Guide” and software

You need to install the “First Step Guide” and software to your Windows computer **before connecting your camcorder to the computer**. The installation is required only for the first time. Contents to be installed and procedures may differ depending on your OS.

💡 Tips

- See page 82 when you use a Macintosh computer.

Installing the “First Step Guide”

1 Confirm that your camcorder is not connected to the computer.

2 Turn on the computer.

📌 Notes

- Log on as Administrators for installation.
- Close all applications running on the computer before installing the software.

3 Place the supplied CD-ROM in the disc drive of your computer.

The installation screen appears.



If the screen does not appear

- ① Click [Start], then click [My Computer]. (For Windows 2000, double-click [My Computer].)
- ② Double-click [SONYPICTUTIL (E:)] (CD-ROM) (disc drive).*

* Drive names (such as (E:)) may vary depending on the computer.

4 Click [FirstStepGuide].

5 Select the desired language and the model name of your camcorder from the pull-down menu.



6 Click [FirstStepGuide(HTML)].

Installation starts.

When [Save is complete] appears, click [OK] to finish the installation.

To install the “First Step Guide” in PDF

In step **6**, click [FirstStepGuide(PDF)].

To install the software “Adobe Reader” to display the PDF file

In step **6**, click [Adobe(R) Reader(R)].

Installing the software

1 Perform steps 1 to 3 in “Installing the “First Step Guide”” (p. 79).

2 Click [Install].

3 Select the language for the application to be installed, then click [Next].

4 Check your area and country/region, then click [Next].

The software is set up for your selected country/region.

5 Read [License Agreement], select [I accept the terms of the license agreement] when you agree, then click [Next].

6 Connect your camcorder to your computer via a USB cable, then click [Next] on the connection confirmation screen.



Notes

- Even if a screen prompting you to restart your computer appears, you do not need to restart it at this time. Restart your computer after completing the installation.

7 Follow the on-screen instructions to install the software.

Depending on the computer, you may need to install third party software (shown below). If the installation screen appears, follow the instructions to install the required software.

■ Sonic UDF Reader

Software required to recognize a DVD-RW (VR mode)

Viewing “First Step Guide”

■ Windows Media Format 9 Series Runtime (Windows 2000 only)

Software required to create a DVD

■ Microsoft DirectX 9.0c

Software required to handle movies

Restart the computer if required to complete the installation.

The short-cut icons, such as [] (Picture Motion Browser), appear on the desktop.

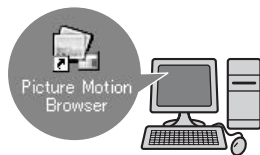

8 Remove the CD-ROM from the disc drive of your computer.

💡 Tips

- Refer to the “First Step Guide” for how to remove the USB cable.



After you install the software, a shortcut icon for the customers registration website is created on the desktop.

- Once you register on the website, you can get secure and useful customer support.
<http://www.sony.net/registration/di/>

- For the information about Picture Motion Browser, visit the following URL:
<http://www.sony.net/support-disoft/>

💡 Tips

- See page 82 when you use a Macintosh computer.

To view “First Step Guide” on your computer, Microsoft Internet Explorer Ver.6.0 or later is recommended.

Double-click the shortcut of “First Step Guide” on the desktop.

💡 Tips

- You can also start this program by selecting [Start] → [Programs] ([All Programs] for Windows XP) → [Sony Picture Utility] → [First Step Guide] → folder with model name of your camcorder → HTML version of “First Step Guide.”
- To view “First Step Guide” in HTML without installing, copy the desired language folder from the [FirstStepGuide] folder on the CD-ROM, and then double-click [Index.html].
- Refer to the PDF version of “First Step Guide” in the following cases:
 - When printing the desired topics of “First Step Guide”
 - When “First Step Guide” is not displayed correctly due to the browser setting even in recommended environment.
 - When the HTML version of “First Step Guide” cannot be installed.

Using a Macintosh computer

You can copy the still images from the “Memory Stick Duo” to the Macintosh. Install “First Step Guide” in the supplied CD-ROM.

🔗 Notes

- The supplied software “Picture Motion Browser” does not operate on Mac OS.
- Refer to “First Step Guide” for the details on connecting your camcorder to the computer and copying the still images.

System requirements

To copy still images from a “Memory Stick Duo”

OS: Mac OS 9.1/9.2 or Mac OS X (v10.1/v10.2/v10.3/v10.4).

Others: 🗑️ USB port (this must be provided as standard)

About “First Step Guide”

The “First Step Guide” is an instruction manual you can refer to on your computer. This describes basic operations, from initial hookup of your camcorder and computer and making setting.

Referring to “Installing the “First Step Guide,”” start the “First Step Guide,” then follow the instructions.

Installing “First Step Guide”

Copy “FirstStepGuide(PDF),” stored in the desired language in the [FirstStepGuide] folder, to your computer.

Viewing “First Step Guide”

Double-click “FirstStepGuide(PDF).”

If no software for viewing PDF files is installed on your computer, you can download Adobe Reader from the following website:
<http://www.adobe.com/>

Troubleshooting

If you run into any problems using your camcorder, use the following table to troubleshoot the problem. If the problem persists, disconnect the power source and contact your Sony dealer.

- Overall operations/Easy Handycam operation/
Remote Commander83
- Batteries/Power sources84
- LCD screen/viewfinder85
- Discs/"Memory Stick Duo"85
- Recording86
- Playing back on your camcorder88
- Playing back a disc on other devices89
- Editing movies on the disc89
- Dubbing/Editing/Connecting to other devices
.....90
- Connecting to a computer90
- Functions that cannot be used simultaneously
.....90

Overall operations/Easy Handycam operation/Remote Commander

The power does not turn on.

- Attach a charged battery pack to the camcorder (p. 20).
- Connect the plug of the AC Adaptor to the wall socket (p. 20).

The camcorder does not operate even when the power is set to on.

- It takes a few seconds for your camcorder to be ready to shoot after the power is turned on. This is not a malfunction.
- Disconnect the AC Adaptor from the wall socket or remove the battery pack, then reconnect it after about 1 minute. If the functions still do not work, press the RESET button (p. 112) using a sharp-pointed object. (If you press the RESET button, all settings, including the clock setting, are reset.)
- The temperature of your camcorder is extremely high. Turn off your camcorder and leave it for a while in a cool place.

Buttons do not work.

- During Easy Handycam operation, the following buttons/functions are not available.
 - BACK LIGHT button (p.35)
 - Playback zoom (p.39)
 - Turning the LCD backlight on and off (pressing and holding the DISP BATT/INFO button for a few seconds) (p.25)



The (OPTION) button is not displayed.

- The OPTION MENU cannot be used during Easy Handycam operation.

The menu settings have been changed.

- Most menu items automatically return to their default settings during Easy Handycam operation.
- The following menu items are fixed during Easy Handycam operation:
 - Movie recording mode: [SP]
 - [] QUALITY] for still images: [FINE]
 - [DATA CODE]: [DATE/TIME]
 - Recording format for DVD-RW: [VIDEO]
- The following menu items return to their default settings if the POWER switch is set to OFF (CHG) for more than 12 hours:
 - [FOCUS]
 - [SPOT FOCUS]
 - [EXPOSURE]
 - [SPOT METER]
 - [SCENE SELECTION]
 - [WHITE BAL.]
 - [MICREF LEVEL]

Even if you press EASY, menu settings do not switch to their defaults automatically.

- Following menu settings remain as they were set even during Easy Handycam operation.
 - [FILE NO.]
 - [VOLUME]
 - [TV TYPE]
 - [ DISPLAY]
 - [BEEP]
 - [SUB-T DATE]
 - [CLOCK SET]
 - [AREA SET]
 - [SUMMERTIME]
 - [WIDE SELECT]*
 - [DEMO MODE]
 - [FLASH MODE]**
 - [ LANGUAGE SET]

* DCR-DVD106E/DVD108E/DVD109E/DVD608E

** DCR-DVD306E/DVD308E/DVD708E

Your camcorder vibrates.

- Vibration occurs depending on the condition of the disc. This is not a malfunction.
-

A vibration is felt in your hand or a faint sound is heard during operation.

- This is not a malfunction.
-

A motor sound is heard in the camcorder when the disc cover is closed without a disc.

- Your camcorder is trying to recognize the disc. This is not a malfunction.
-

Your camcorder gets warm.

- This is because the power has been turned on for a long time. This is not a malfunction. Turn off your camcorder and leave it for a while in a cool place.
-

The supplied Remote Commander does not function (DCR-DVD306E/DVD308E/DVD708E).

- Set [REMOTE CTRL] to [ON] (p. 70).
 - Insert a battery into the battery holder with the +/- polarities correctly matching the +/- marks (p. 113).
 - Remove any obstructions between the Remote Commander and the remote sensor.
 - Point the remote sensor away from strong light sources such as direct sunlight or overhead lighting. Otherwise, the Remote Commander may not function properly.
-

Another DVD device malfunctions when you use the supplied Remote Commander (DCR-DVD306E/DVD308E/DVD708E).

- Select a commander mode other than DVD 2 for your DVD device, or cover the sensor of your DVD device with black paper.
-

Batteries/Power sources

The power abruptly turns off.

- When approximately 5 minutes have elapsed while you do not operate your camcorder, the camcorder is automatically turned off (A.SHUT OFF). Change the setting of [A.SHUT OFF] (p. 70), or turn on the power again, or use the AC Adaptor.
 - Charge the battery pack (p. 20).
-

The CHG (charge) lamp does not light while the battery pack is being charged.

- Turn the POWER switch to OFF (CHG) (p. 20).
 - Attach the battery pack to the camcorder correctly (p. 20).
 - Connect the mains lead to the wall socket properly.
 - The battery charge is completed (p. 20).
-

The CHG (charge) lamp flashes while the battery pack is being charged.

- Attach the battery pack to the camcorder correctly (p. 20). If the problem persists, disconnect the AC Adaptor from the wall socket and contact your Sony dealer. The battery pack may be damaged.

The remaining battery time indicator does not indicate the correct time.

- The temperature of the environment is too high or too low. This is not a malfunction.
- The battery pack has not been charged enough. Fully charge the battery again. If the problem persists, replace the battery pack with a new one (p. 20).
- The indicated time may not be correct depending on the environment of use.

The battery pack is quickly discharged.

- The temperature of the environment is too high or low. This is not a malfunction.
- The battery pack has not been charged enough. Fully charge the battery again. If the problem persists, replace the battery pack with a new one (p. 20).

LCD screen/viewfinder

The buttons do not appear on the touch panel.

- Touch the LCD screen lightly.
- Press DISP/BATT INFO on your camcorder (or DISPLAY on the Remote Commander for DCR-DVD306E/DVD308E/DVD708E) (p. 25).

The buttons on the touch panel do not work correctly or do not work at all.

- Adjust the touch panel ([CALIBRATION]) (p. 103).

Menu items are grayed out.

- You cannot select grayed items in the current recording/playback status.
- Some functions cannot be used simultaneously (p. 90).

The image in the viewfinder is not clear.

- Move the viewfinder lens adjustment lever until the image appears clearly (p. 25).

The image in the viewfinder has disappeared.

- Close the LCD panel. No image is displayed in the viewfinder when the LCD panel is open (p. 25).

A dotted line appears on the LCD screen.

- This is not malfunction and does not affect recorded images.

Discs/"Memory Stick Duo"

The disc cannot be removed.

- Make sure the power source (battery pack or AC Adaptor) is connected correctly (p. 20).
- The disc is damaged or is dirty with fingerprints, etc. In this case, it may take up to 10 minutes to remove the disc.
- The temperature of your camcorder is extremely high. Turn off your camcorder and leave it for a while in a cool place.
- Finalizing is interrupted by turning off your camcorder. Turn on your camcorder and remove the disc after finalizing is completed (p. 44).

Images cannot be deleted.

- The maximum number of images that you can delete on the index screen at one time is 100.
- Images cannot be deleted depending on the type and recording format of a disc (p. 13, 46).

Remaining disc space indicator is not displayed.

- Set [REMAINING] to [ON] to always display the remaining disc space indicator (p. 63).

The indicators of the disc type and the recording format on the LCD screen are grayed out.

- The disc may have been created other than your camcorder. You can play back with your camcorder, but you cannot record additional scenes.

You cannot operate functions using the “Memory Stick Duo.”

- If you use a “Memory Stick Duo” formatted on a computer, format it again on your camcorder (p. 58).

You cannot delete or format the “Memory Stick Duo.”

- The maximum number of images that you can delete on the index screen at one time is 100.
- You cannot delete still images that have write-protection set by another device.

Data file name is incorrect or flashing

- The file may be corrupted.
- The file format may not be supported by your camcorder. Use the supported file format (p. 99).

Recording

Refer also to “Discs/Memory Stick Duo” (p. 85).

Pressing START/STOP does not record movies on the disc.

- The playback screen is displayed. Set your camcorder to recording standby (p. 33).
- Your camcorder is recording the scene you have just shot on the disc.
- The disc has run out of space. Use a new disc or format the disc (DVD-RW/DVD+RW only, p. 57). Or delete the unnecessary images (p. 46).
- When you are using one of the following discs after finalizing it, make the disc to be able to record additional scenes (p.58). Or use a new disc.
 - DVD-RW (VIDEO mode)
 - DVD+RW
- The temperature of your camcorder is extremely high. Turn off your camcorder and leave it for a while in a cool place.
- Moisture condensation has occurred with the disc. Turn off your camcorder and leave it for about 1 hour in a cool place (p. 103).

You cannot record a still image.

- The playback screen is displayed. Set your camcorder to recording standby (p. 33).
- The “Memory Stick Duo” has run out of space. Use a new “Memory Stick Duo” or format the “Memory Stick Duo” (p. 58). Or delete the unnecessary images (p. 47).
- You cannot record a still image on a disc on your camcorder.

The ACCESS lamp lights up even when you stop recording.

- Your camcorder is recording the scene you have just shot on the disc.

The recording angle looks different (DCR-DVD306E/DVD308E/DVD708E).

- The recording angle may look different depending on the mode of your camcorder. This is not a malfunction.

The actual recording time for movie is less than the expected approximate recording time of a disc.

- Depending on an object, such as a fast moving object, the time available for recording may shorten (p. 12).

The recording stops.

- The temperature of your camcorder is extremely high. Turn off your camcorder and leave it for a while in a cool place.
- Moisture condensation has occurred with the disc. Turn off your camcorder and leave it about 1 hour in a cool place (p. 103).

There is a time difference between the point where you press START/STOP and the point that the recorded movie starts/stops.

- On your camcorder, there may be a slight time difference between the point where you press START/STOP and the actual point that recording movie starts/stops. This is not a malfunction.

The movie aspect ratio (16:9/4:3) cannot be changed. (DCR-DVD306E/DVD308E/DVD708E)

- You cannot change the movie aspect ratio if your disc is DVD+RW.

The auto focus does not function.

- Set [FOCUS] to [AUTO] (p. 73).
- The recording conditions are not suitable for auto focus. Adjust the focus manually (p. 73).

[STEADYSHOT] does not function.

- Set [STEADYSHOT] to [ON] (p. 63).
- [STEADYSHOT] may not be able to compensate for excessive vibrations.

The BACK LIGHT function does not function.

- The BACK LIGHT function cannot be used during Easy Handycam operation.

Tiny spots in white, red, blue, or green appear on the screen.

- The spots appear when you are recording with [S. NIGHTSHOT PLS] or [COLOR SLOW SHTR]. This is not a malfunction.

The color of the image is not correctly displayed.

- Set the NIGHTSHOT PLUS switch to OFF (p. 35).

The screen image is bright, and the subject does not appear on the screen.

- Set the NIGHTSHOT PLUS switch to OFF (p. 35).

The screen image is dark, and the subject does not appear on the screen (DCR-DVD306E/DVD308E/DVD708E).

- Press and hold DISP/BATT INFO for a few seconds to turn on the backlight (p. 25).

Undesirable flicker occurs.

- This occurs when recording images under a fluorescent lamp, sodium lamp, or mercury lamp. This is not malfunction.

A vertical band appears when recording candlelight or electric light in the dark.

- This occurs when the contrast between the subject and the background is too high. This is not a malfunction.

A vertical white line may appear on an image taken in bright light.

- This phenomenon is called the smear effect. This is not a malfunction.

Black bands appear when you record a TV screen or computer screen.

- Set [STEADYSHOT] to [OFF] (p. 63).

[S. NIGHTSHOT PLS] cannot be operated.

- Set the NIGHTSHOT PLUS switch to ON (p. 35).

[COLOR SLOW SHTR] does not operate correctly.

- [COLOR SLOW SHTR] may not operate correctly in total darkness. Use NightShot plus or [S. NIGHTSHOT PLS].

You cannot adjust [LCD BL LEVEL].



- You cannot adjust [LCD BL LEVEL] when:
 - The LCD panel is closed on your camcorder with the LCD screen facing out.
 - The power is supplied from the AC Adaptor.

You cannot use [WIDE SELECT] (DCR-DVD106E/DVD108E/DVD109E/DVD608E).

- You cannot use [WIDE SELECT] if your disc is DVD+RW.

Playing back on your camcorder

You cannot play back a disc.

- Turn the POWER switch to turn on your camcorder and press  (VIEW IMAGES).
- On the HOME MENU, touch  (VIEW IMAGES), then [VISUAL INDEX].
- Check out the disc compatibility (p. 12).
- Insert a disc with the recording side facing your camcorder (p.26).
- The disc that was recorded, formatted, of finalized on other devices may not be played back on your camcorder.

The playback image is distorted.

- Clean the disc using a soft cloth (p. 99).

Still images stored on a “Memory Stick Duo” cannot be played back.

- Still images cannot be played back if you have modified files or folders, or have edited the data on a computer. (The file name flashes in that case.) This is not a malfunction (p. 100).
- Still images recorded on other devices may not be played back. This is not a malfunction (p. 100).

“?” is indicated on an image in the VISUAL INDEX screen.

- Loading of the data may have failed. It may be indicated correctly when you turn off the power and then turn it on again, or repeat removing and inserting the “Memory Stick Duo” a couple of times.
- This may appear on still images recorded on other devices, edited on a computer, etc.

No sound or only a quiet sound is heard when playing back a disc.

- Turn up the volume (p. 38).
- Sound is not output when the LCD screen is closed. Open the LCD screen.
- When you record sound with [MICREF LEVEL] (p. 77) set to [LOW], the recorded sound may be difficult to hear.

Playing back a disc on other devices

You cannot play back the disc, or the disc is not recognized.

- Clean the disc using a soft cloth (p. 99).
- Finalize the disc (p. 42).
- A disc recorded in VR mode cannot be played back on a device that does not support VR mode. Check the compatibility in the instruction manual of the playback device.

The playback image is distorted.

- Clean the disc using a soft cloth (p. 99).

“?” is indicated on an image in the DVD menu.

- Loading of the data may have failed when the disc was finalized. For the following discs, make the disc capable of additional recording (p. 58), then remake the DVD menu by finalizing the disc again (p. 45). The DVD menu may be displayed correctly.
 - DVD-RW (VIDEO mode)
 - DVD+RW

Playback freezes for an instant between the scenes.

- The image may freeze for an instant between scenes depending on the device being used. This is not a malfunction.
- In case of a DVD+R DL, the image may freeze for an instant when the recording layer changes. This is not a malfunction.

Playback does not move to the previous scene when you press ◀◀.

- If playback crosses 2 titles made automatically by your camcorder when ◀◀ is pressed, playback may not move to the previous scene. Select the desired scene from the menu screen. Refer to the instruction manual of the playback device for further information.

Editing movies on the disc

Unable to edit.

- Your disc may not be configured for editing data (p. 13).
- There are no images recorded on the disc.
- Unable to edit because of the condition of the image.
- You cannot edit an image protected on another device.
- You cannot copy or move the images between a disc and a “Memory Stick Duo.”

Scenes cannot be added in the Playlist.

- The disc is full, or the added scenes exceed 999. Delete unnecessary scenes (p. 50).
- You cannot add still images in the Playlist.

A movie cannot be divided.

- A movie that is too short cannot be divided.
- A movie protected on another device cannot be divided.

A scene cannot be deleted.

- Your disc may not be configured for deleting data (p. 13).
- You cannot delete movie during the Easy Handycam operation.
- A scene protected on another device cannot be deleted.

Troubleshooting (Continued)

Unable to copy the images from a disc to a “Memory Stick Duo.”

- You cannot copy a movie from a disc to a “Memory Stick Duo” as a still image during playback on your camcorder.

Unable to finalize.

- Battery is running out during finalizing. Use the AC Adaptor.
- The disc has already been finalized. In the case of following discs, follow the required procedure to record additional material (p. 58):
 - DVD-RW (VIDEO mode)
 - DVD+RW

Unable to [UNFINALIZE].

- [UNFINALIZE] is not available for the following types of disc:
 - DVD-RW (VR mode)
 - DVD+RW
 - DVD-R
 - DVD+R DL

You cannot edit or record additional material on a disc using other devices.

- You may not be able to edit a disc recorded on your camcorder using other devices.

Dubbing/Editing/Connecting to other devices

You cannot hear the sound.

- When you are using the S VIDEO plug, make sure the red and white plugs of the A/V connecting cable are connected (p. 40).

The aspect ratio of the playback is not correct when connecting your camcorder to the TV.

- Set [TV TYPE] depending on your TV (p. 40, 68).

You cannot dub correctly.

- The A/V connecting cable is not connected properly. Make sure that the A/V connecting cable is connected to the proper jack, i.e. to the input jack of another device for dubbing a image from your camcorder (p. 52).

Connecting to a computer

When using the movies on a disc, a computer does not recognize your camcorder.

- Install Picture Motion Browser (p. 80).
- Disconnect the USB device other than the keyboard, the mouse, and the camcorder from the computer.
- Disconnect the cable from the computer and camcorder, restart the computer, then connect them again correctly.

Cannot use the supplied software, Picture Motion Browser, on the Macintosh computer.

- You cannot use Picture Motion Browser on a Macintosh.

Functions that cannot be used simultaneously

- The following list shows examples of unworkable combinations of functions and menu items.

Cannot use	Because of following settings
BACK LIGHT	[SPOT METER], [FIREWORKS], [MANUAL] in [EXPOSURE]
WIDE SELECT*	[OLD MOVIE]
[SCENE SELECTION]	NightShot plus, [S. NIGHTSHOT PLS], [COLOR SLOW SHTR], [OLD MOVIE], [TELE MACRO]
[SPOT FOCUS]	[SCENE SELECTION]

Cannot use	Because of following settings
[SPOT METER]	NightShot plus, [S. NIGHTSHOT PLS]
[EXPOSURE]	NightShot plus, [S. NIGHTSHOT PLS]
[WHITE BAL.]	NightShot plus, [S. NIGHTSHOT PLS]
[S. NIGHTSHOT PLS]	[FADER], [D.EFFECT]
[COLOR SLOW SHTR]	[FADER], [D.EFFECT], [SCENE SELECTION]
[FADER]	[S. NIGHTSHOT PLS], [COLOR SLOW SHTR], [D.EFFECT], [CANDLE], [FIREWORKS]
[D.EFFECT]	[S. NIGHTSHOT PLS], [COLOR SLOW SHTR], [FADER]
[OLD MOVIE]	[SCENE SELECTION], [PICT.EFFECT]
[PICT.EFFECT]	[OLD MOVIE]
[TELE MACRO]	[SCENE SELECTION]
[AUTO SLW SHUTTR]	[S. NIGHTSHOT PLS], [SCENE SELECTION], [COLOR SLOW SHTR], [D.EFFECT]
[WIDE SELECT]**	[OLD MOVIE]

* DCR-DVD306E/DVD308E/DVD708E

** DCR-DVD106E/DVD108E/DVD109E/
DVD608E

Warning indicators and messages

Self-diagnosis display/Warning indicators

If indicators appear on the LCD screen or in the viewfinder, check the following. Some symptoms you can fix by yourself. If the problem persists even after you have tried a couple of times, contact your Sony dealer or local authorized Sony service facility.

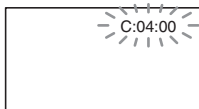

C:(or E:) □□:□□ (Self-diagnosis display)

C:04:□□

- The battery pack is not an “InfoLITHIUM” battery pack. Use an “InfoLITHIUM” battery pack (p.101).
- Connect the DC plug of the AC Adaptor to the DC IN jack of your camcorder securely (p.20).

C:13:□□

- The disc is faulty. Use a compatible disc with your camcorder (p.12).
- The disc is dirty or has scratches on it. Clean the disc with the supplied cleaning cloth (p.99).

C:32:□□

- Symptoms that are not described above have occurred. Remove the disc and insert it again, then operate your camcorder again.
- Remove the power source. Reconnect it again and operate your camcorder again.
- Turn on your camcorder again.

E:20:□□ / E:31:□□ / E:61:□□ /
E:62:□□ / E:91:□□ / E:94:□□

- A malfunction that you cannot service has occurred. Contact your Sony dealer or local authorized Sony service facility. Inform them of the 5-digit code, which starts from “E.”

101-0001 (Warning indicator pertaining to files)

Slow flashing

- The file is damaged.
- The file is unreadable.

(Warning indicator pertaining to discs)

Slow flashing

- A disc is not inserted.*
- Less than 5 minutes remains for recording movies.
- A disc that cannot be read or written is inserted, such as the single-sided disc inserted inside out.

Fast flashing

- An unrecognizable disc is inserted.*
- A finalized DVD-RW (VIDEO mode)/DVD+RW is inserted into your camcorder during recording standby.
- The disc is fully recorded.*
- The disc recorded in the different TV color system from your camcorder is inserted when  (Movie) is selected.*

(You need to remove the disc)*

Fast flashing

- An unrecognizable disc is inserted.
- The disc is fully recorded.
- An error might have occurred with the disc drive in your camcorder.
- A finalized disc is inserted.

 **(Battery level warning)**

Slow flashing

- The battery pack is nearly used up.
- Depending on the operating, environment, or battery conditions,  may flash, even if there are approximately 20 minutes remaining.

 **(High temperature warning)**

Slow flashing

- The temperature of your camcorder is getting higher. Turn off your camcorder and leave it for a while in a cool place.

Fast flashing*

- The temperature of your camcorder is extremely high. Turn off your camcorder and leave it for a while in a cool place.

 **(Warning indicator pertaining to “Memory Stick Duo”)**

- No “Memory Stick Duo” is inserted (p. 27).

 **(Warning indicators pertaining to “Memory Stick Duo” formatting)***

- The “Memory Stick Duo” is damaged.
- The “Memory Stick Duo” is not formatted correctly (p. 58, 99).

 **(Warning indicator pertaining to incompatible “Memory Stick Duo”)***

- An incompatible “Memory Stick Duo” is inserted (p. 99).

 **(Warning indicator pertaining to the write-protect of the “Memory Stick Duo”)***

- The write-protect tab on the “Memory Stick Duo” is set to lock (p. 100).
- Access to the “Memory Stick Duo” was restricted on another device.

 **(Warning indicator pertaining to the flash)**

Fast flashing

- There is something wrong with the flash.

 **(Warning indicator pertaining to camera-shake warning)**

- The amount of lights is not sufficient, so camera-shake easily occurs. Use the flash.
- The camcorder is unsteady, so camera-shake easily occurs. Hold the camcorder steady with both hands and shoot the image. However, note that the camera-shake warning indicator does not disappear.

* You hear a melody when the warning indicators appear on the screen (p. 67).

Description of warning messages

If messages appear on the screen, follow the instructions.

■ Disc

 **▲Recording on disc disabled.**

- A malfunction has occurred with the disc and the disc cannot be used.

Playback prohibited.

- You are trying to play back an incompatible disc with your camcorder.
- You are trying to play back an image recorded with a copyright protection signal.

 **▲ Need to unfinalize disc.**

- To record on the finalized DVD-RW (VIDEO mode), unfinalize it (p. 58).

 **▲ Disc error. Remove disc.**

- Your camcorder cannot recognize the disc, because the disc is incompatible or has scratches.

 **▲ Disc error. Unsupported format.**

- The disc recorded in the different format code from your camcorder. Formatting the disc may enable you to use the disc on your camcorder (DVD-RW/DVD+RW only) (p.57).

■ “Memory Stick Duo”

 **Reinsert the Memory Stick.**

- Reinsert the “Memory Stick Duo” a few times. If even then the indicator flashes, the “Memory Stick Duo” could be damaged. Try with another “Memory Stick Duo.”

 **This Memory Stick is not formatted correctly.**

- Check the format, then format the “Memory Stick Duo” with your camcorder if necessary (p. 58, 99).

Memory Stick folders are full.

- You cannot create folders exceeding 999MSDCF. You cannot create or delete created folders using your camcorder.
- You will have to format the “Memory Stick Duo” (p. 58), or delete them using your computer.

■ PictBridge compliant printer

Not connected to PictBridge compatible printer.

- Switch off the printer and switch it on again, then disconnect the USB cable and reconnect it.

Cannot print. Check the printer.

- Switch off the printer and switch it on again, then disconnect the USB cable and reconnect it.

■ Others

No further selection is possible.

- You can select up to 100 images only when:
 - deleting images
 - editing the playlist
 - printing still images

Data protected.

- The disc has been protected with another device.

Cannot divide.

- You cannot divided a movie that is extremely short.

Recovering data ▲ Avoid any vibration.

- Your camcorder tries to recover data automatically if the data writing was not performed properly.

Cannot recover data on disc.

- Writing data to the disc has failed. Attempts were made to recover the data, but they were unsuccessful.

Please wait.

- This is displayed if the disc removal process takes time. Turn on the camcorder and leave it for about 10 minutes, preventing vibration.
-

Using your camcorder abroad

Power supply

You can use your camcorder in any countries/regions using the AC Adaptor supplied with your camcorder within the AC 100 V to 240 V, 50/60 Hz range.

To view images, you need a PAL-system-based TV with AUDIO/VIDEO input jacks. An A/V connecting cable must be connected.

On TV color systems

Your camcorder is a PAL-system-based camcorder. If you want to view the playback image on a TV, it must be a PAL-system-based TV with an AUDIO/VIDEO input jack.

System	Used in
PAL	Australia, Austria, Belgium, China, Czech Republic, Denmark, Finland, Germany, Holland, Hong Kong, Hungary, Italy, Kuwait, Malaysia, New Zealand, Norway, Poland, Portugal, Singapore, Slovak Republic, Spain, Sweden, Switzerland, Thailand, United Kingdom, etc.
PAL - M	Brazil
PAL - N	Argentina, Paraguay, Uruguay.
NTSC	Bahama Islands, Bolivia, Canada, Central America, Chile, Colombia, Ecuador, Guyana, Jamaica, Japan, Korea, Mexico, Peru, Surinam, Taiwan, the Philippines, the U.S.A., Venezuela, etc.
SECAM	Bulgaria, France, Guiana, Iran, Iraq, Monaco, Russia, Ukraine, etc.

Setting to the local time

You can easily set the clock to the local time by setting a time difference when using your camcorder abroad. Set **⚙️** (SETTINGS) → [CLOCK/**🌐** LANG] → [AREA SET] and [SUMMERTIME] on the HOME MENU (p. 69).

World time difference

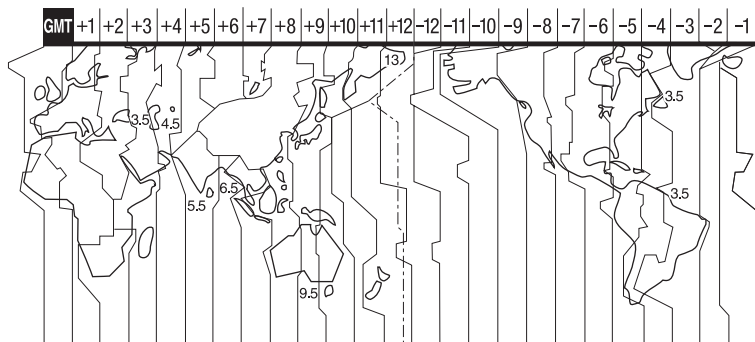

Time-zone differences	Area setting
GMT	Lisbon, London
+01:00	Berlin, Paris
+02:00	Helsinki, Cairo, Istanbul
+03:00	Moscow, Nairobi
+03:30	Tehran
+04:00	Abu Dhabi, Baku
+04:30	Kabul
+05:00	Karachi, Islamabad
+05:30	Calcutta, New Delhi
+06:00	Almaty, Dhaka
+06:30	Rangoon
+07:00	Bangkok, Jakarta
+08:00	Hong Kong, Singapore, Beijing
+09:00	Seoul, Tokyo
+09:30	Adelaide, Darwin
+10:00	Melbourne, Sydney

Time-zone differences	Area setting
+11:00	Solomon Is.
+12:00	Fiji, Wellington
-12:00	Eniwetok, Kwajalein
-11:00	Midway Is., Samoa
-10:00	Hawaii
-09:00	Alaska
-08:00	Los Angeles, Tijuana
-07:00	Denver, Arizona
-06:00	Chicago, Mexico City
-05:00	New York, Bogota
-04:00	Santiago
-03:30	St. John' s
-03:00	Brasilia, Montevideo
-02:00	Fernando de Noronha
-01:00	Azores, Cape Verde Is.

Maintenance and precautions

About the Disc

See page 12 for the details of discs which you can use with your camcorder.

Notes on use

- Hold the disc by its edge while supporting the center hole lightly. Do not touch the recording side (the opposite of the printed side when using a single-sided disc).



- Before shooting, be sure to remove dust and fingerprints from the disc with a soft cloth. Otherwise you may not be able to record or play normally in some situations using that disc.
- When you set the disc in your camcorder, press firmly until it clicks. When the message [C:13:□□] appears on the LCD screen, open the disc cover and set the disc again.
- Do not attach any adhesive material such as a sticker on the surface of a disc. If you do so, the disc may become unbalanced, and this may cause a malfunction of the disc or your camcorder.



Use of double-sided discs

Double-sided discs allow you to record both sides of a disc.

■ Recording on the A side

Place the disc in your camcorder with the side with the **A** symbol at the center facing outwards until it clicks.

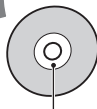
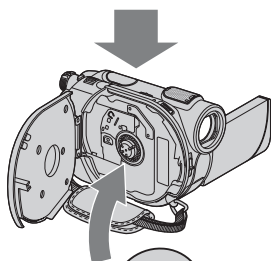
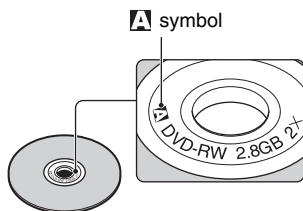

Place the **A** symbol facing outwards.

Recording is made on the rear side.

- When using a double-sided disc, take care not to smudge the surface with fingerprints.
- When a double-sided disc is used in your camcorder, recording/playback are performed on that side only. You cannot switch to record on or play back the other side with the disc set to the camcorder. When recording/playback of one side is complete, remove the disc and turn it over to access the other side.
- Perform the following operations on each side of a double-sided disc:
 - Finalizing (p. 42)
 - Unfinalizing (p. 58)
 - Formatting (p. 57)

Care and storage of the discs

- Keep the disc clean, or the image quality of the audio and video output may deteriorate.
- Clean the disc with a soft cloth. Wipe the disc from the center out. For dirt, clean the disc with a soft cloth slightly moistened in water, then remove the moisture with a soft, dry cloth. Do not use solvents such as benzene, cleaners intended for vinyl LPs or antistatic spray, as they may cause a malfunction to the disc.



- Do not expose the disc to direct sunlight or leave it in a humid place.
- When you carry or store the disc, put it in its case.
- When you want to write letters or marks, etc. on a single-sided disc, write only on the printed side using an oil-based marker with a felt-tip, and do not touch the ink until it dries. Do not heat the disc or use a sharp-pointed tool, such as ball point pen. Do not dry the surface by heating. You cannot write, or mark, on double-sided discs.

About the “Memory Stick”

A “Memory Stick” is a compact, portable IC recording medium with a large data capacity. You can use only a “Memory Stick Duo,” which is about the half size of a standard “Memory Stick,” with your camcorder.

However, we do not guarantee the operation of all types of “Memory Stick Duo” on your camcorder.

Types of “Memory Stick”	Recording/Playback
“Memory Stick” (without MagicGate)	–
“Memory Stick Duo” ^{*1} (without MagicGate)	○
“MagicGate Memory Stick”	–
“Memory Stick Duo” ^{*1} (with MagicGate)	○ ^{*2*3}
“MagicGate Memory Stick Duo” ^{*1}	○ ^{*3}
“Memory Stick PRO”	–
“Memory Stick PRO Duo” ^{*1}	○ ^{*2*3}

^{*1} A “Memory Stick Duo” is about half the size of a standard “Memory Stick.”

^{*2} The types of “Memory Stick” that support high speed data transfer. The speed of data transfer varies depending on the device to be used.

^{*3} “MagicGate” is a copyright protection technology that records and transfers the contents in an encrypted format. Note that data that uses “MagicGate” technology cannot be recorded or played on your camcorder.

- Still image format: Your camcorder compresses and records image data in the JPEG (Joint Photographic Experts Group) format. The file extension is “.JPG.”
- File names of still images:
 - 101-0001: This file name appears on the screen of your camcorder.
 - DSC00001.JPG: This file name appears on the display of a computer.
- A “Memory Stick Duo” formatted by a computer (Windows OS/Mac OS) does not have guaranteed compatibility with your camcorder.

Maintenance and precautions (Continued)

- Data read/write speed may vary depending on the combination of the “Memory Stick” and “Memory Stick” compliant product you use.

On a “Memory Stick Duo” with a write-protect tab

You can prevent accidental erasure of images when you slide the write-protect tab on the “Memory Stick Duo” with a small tapered object, to the write-protect position.

Notes on use

Damaged or lost image data will not be compensated for, and may occur in the following cases:

- If you eject the “Memory Stick Duo,” turn the power off on your camcorder, or remove the battery pack for replacement while your camcorder is reading or writing image files on the “Memory Stick Duo” (while the access lamp is lit or flashing).
- If you use the “Memory Stick Duo” near magnets or magnetic fields.

It is recommended you make a back-up of important data on the hard disk of a computer.

■ On handling a “Memory Stick”

Keep the following in mind when handling a “Memory Stick Duo.”

- Be careful not to apply excessive force when writing on a memo area on a “Memory Stick Duo.”
- Do not attach a label or the like on a “Memory Stick Duo” or a Memory Stick Duo adaptor.
- When you carry or store a “Memory Stick Duo,” put it in its case.
- Do not touch, or allow metallic objects to come into contact with the terminals.
- Do not bend, drop or apply strong force to the “Memory Stick Duo.”
- Do not disassemble or modify the “Memory Stick Duo.”
- Do not let the “Memory Stick Duo” get wet.
- Be careful to keep “Memory Stick Duo” media out of the reach of small children. There is danger that a child might swallow it.

- Do not insert anything other than a “Memory Stick Duo” into the “Memory Stick Duo” slot. Doing so may cause a malfunction.

■ On a location for use

Do not use or keep the “Memory Stick Duo” in the following locations:

- Places subject to extremely high temperature, such as a car parked outside in the summer.
- Places under direct sunlight.
- Places with extremely high humidity or subject to corrosive gases.

■ On the Memory Stick Duo adaptor

After inserting a “Memory Stick Duo” into the Memory Stick Duo adaptor, you can use it with a standard “Memory Stick” compliant device.

- When using a “Memory Stick Duo” with a “Memory Stick” compliant device, be sure to insert the “Memory Stick Duo” into a Memory Stick Duo adaptor.
- When inserting a “Memory Stick Duo” into a Memory Stick Duo adaptor, make sure the “Memory Stick Duo” is inserted facing in the correct direction, then insert it all the way in. Note that improper use may cause a malfunction. Also, if you force the “Memory Stick Duo” into the Memory Stick Duo adaptor in the wrong direction, it may be damaged.
- Do not insert a Memory Stick Duo adaptor without a “Memory Stick Duo” attached. Doing so may result in malfunctions of the unit.

■ On a “Memory Stick PRO Duo”

The maximum memory capacity of a “Memory Stick PRO Duo” that can be used on your camcorder is 4 GB.

On image data compatibility

- Image data files recorded on a “Memory Stick Duo” by your camcorder conform to the “Design rule for Camera File system” universal standard established by the JEITA (Japan Electronics and Information Technology Industries Association).
- On your camcorder, you cannot play back still images recorded on other devices (DCR-TRV900E or DSC-D700/D770) that do not conform to the universal standard. (These models are not sold in some regions.)

- If you cannot use a “Memory Stick Duo” that has been used with another device, format it with your camcorder (p. 58). Note that formatting erases all information on the “Memory Stick Duo.”
- You may not be able to play back images with your camcorder:
 - When playing back image data modified on your computer.
 - When playing back image data recorded with other devices.

About the “InfoLITHIUM” battery pack

Your camcorder operates only with an “InfoLITHIUM” battery pack (H series). “InfoLITHIUM” H series battery packs have the  mark.

What is an “InfoLITHIUM” battery pack?

An “InfoLITHIUM” battery pack is a lithium-ion battery pack that has functions for communicating information related to operating conditions between your camcorder and an optional AC Adaptor/charger.

The “InfoLITHIUM” battery pack calculates the power consumption according to the operating conditions of your camcorder, and displays the remaining battery time in minutes.

With an AC Adaptor/charger, the remaining battery time and charging time appear.

To charge the battery pack

- Be sure to charge the battery pack before you start using your camcorder.
- We recommend charging the battery pack in an ambient temperature of between 10 °C to 30 °C (50 °F to 86 °F) until the CHG (charge) lamp turns off. If you charge the battery pack outside of this temperature range, you may not be able to charge it efficiently.
- After charging is complete, disconnect the cable from the DC IN jack on your camcorder or remove the battery pack.

To use the battery pack effectively

- Battery pack performance decreases when the surrounding temperature is 10 °C (50 °F) or below, and the length of time you can use the battery pack becomes shorter. In that case, do one of the following to use the battery pack for a longer time.
 - Put the battery pack in a pocket to warm it up, and insert it in your camcorder right before you start taking shots.
 - Use a large capacity battery pack: NP-FH70/ NP-FH100 (optional).
- Frequent use of the LCD screen or a frequent playback, fast forward or rewind operation wears out the battery pack faster. We recommend using a large capacity battery pack: NP-FH70/NP-FH100.
- Be sure to set the POWER switch to OFF (CHG) when not recording or playing back on your camcorder. The battery pack is also consumed when your camcorder is in recording standby or playback pause.
- Have spare battery packs ready for two or three times the expected recording time, and make trial recordings using a DVD-RW/DVD+RW before making the actual recording.
- Do not expose the battery pack to water. The battery pack is not water resistant.

About the remaining battery time indicator

- When the power goes off even though the remaining battery time indicator indicates that the battery pack has enough power to operate, charge the battery pack fully again. Remaining battery time will be indicated correctly. Note, however, that the battery indication will not be restored if it is used in high temperatures for a long time, or if left in a fully charged state, or when the battery pack is frequently used. Use the remaining battery time indication as a rough guide only.
- The  mark that indicates low battery flashes even if there are still 5 to 10 minutes of battery time remaining, depending on the operating conditions or ambient temperature.

About storage of the battery pack

- If the battery pack is not used for a long time, fully charge the battery pack and use it up on your camcorder once a year to maintain proper function. To store the battery pack, remove it from your camcorder and put it in a dry, cool place.
- To discharge the battery pack on your camcorder completely, touch  (SETTINGS) → [GENERAL SET] → [A.SHUT OFF] → [NEVER] on the HOME MENU and leave your camcorder in recording standby until the power goes off (p. 70).

About battery life

- Battery capacity decreases over time and through repeated use. If decreased usage time between charges becomes significant, it is probably time to replace it with a new one.
- Each battery's life is governed by storage, operating and environmental conditions.

About handling of your camcorder

On use and care

- Do not use or store the camcorder and accessories in the following locations:
 - Anywhere extremely hot or cold. Never leave them exposed to temperatures above 60 °C (140 °F), such as under direct sunlight, near heaters or in a car parked in the sun. They may malfunction or become deformed.
 - Near strong magnetic fields or mechanical vibration. The camcorder may malfunction.
 - Near strong radio waves or radiation. The camcorder may not be able to record properly.
 - Near AM receivers and video equipment. Noise may occur.
 - On a sandy beach or anywhere dusty. If sand or dust gets in your camcorder, it may malfunction. Sometimes this malfunction cannot be repaired.
 - Near windows or outdoors, where the LCD screen, the viewfinder, or the lens may be exposed to direct sunlight. This damages the inside of the viewfinder or the LCD screen.
 - Anywhere very humid.
- Operate your camcorder on DC 6.8 V/7.2 V (battery pack) or DC 8.4 V (AC Adaptor).

- For DC or AC operation, use the accessories recommended in these operating instructions.
- Do not let your camcorder get wet, for example, from rain or sea water. If your camcorder gets wet, it may malfunction. Sometimes this malfunction cannot be repaired.
- If any solid object or liquid gets inside the casing, unplug your camcorder and have it checked by a Sony dealer before operating it any further.
- Avoid rough handling, disassembling, modifying, physical shock, or impact such as hammering, dropping or stepping on the product. Be particularly careful of the lens.
- Keep the POWER switch setting to OFF (CHG) when you are not using your camcorder.
- Do not wrap your camcorder with a towel, for example, and operate it. Doing so might cause heat to build up inside.
- When disconnecting the mains lead, pull it by the plug and not the cord.
- Do not damage the mains lead such as by placing anything heavy on it.
- Keep metal contacts clean.
- Keep the Remote Commander and button-type battery out of children's reach. If the battery is accidentally swallowed, consult a doctor immediately.
- If the battery electrolytic liquid has leaked:
 - consult your local authorized Sony service facility.
 - wash off any liquid that may have contacted your skin.
 - if any liquid gets in your eyes, wash with plenty of water and consult a doctor.

■ When not using your camcorder for a long time

- Periodically turn it on and let it run such as by playing back discs or recording for about 3 minutes.
- Remove a disc from your camcorder.
- Use up the battery pack completely before storing it.

Moisture condensation

If your camcorder is brought directly from a cold place to a warm place, moisture may condense inside your camcorder, on the surface of the disc, or on the pickup lens. This may cause a malfunction to your camcorder.

■ If moisture condensation has occurred

Leave your camcorder for about 1 hour without turning it on.

■ Note on moisture condensation

Moisture may condense when you bring your camcorder from a cold place into a warm place (or vice versa) or when you use your camcorder in a humid place as follows:

- You bring your camcorder from a ski slope into a place warmed up by a heating device.
- You bring your camcorder from an air conditioned car or room into a hot place outside.
- You use your camcorder after a squall or a shower.
- You use your camcorder in a hot and humid place.

■ How to prevent moisture condensation

When you bring your camcorder from a cold place into a warm place, put your camcorder in a plastic bag and seal it tightly. Remove the bag when the air temperature inside the plastic bag has reached the surrounding temperature (after about 1 hour).

LCD screen



- Do not exert excessive pressure on the LCD screen, as it may cause damage.
- If your camcorder is used in a cold place, a residual image may appear on the LCD screen. This is not a malfunction.
- While using your camcorder, the back of the LCD screen may heat up. This is not a malfunction.

■ To clean the LCD screen

If fingerprints or dust make the LCD screen dirty, it is recommended you use a soft cloth to clean it. When you use the LCD Cleaning Kit (optional), do not apply the cleaning liquid directly to the LCD screen. Use cleaning paper moistened with the liquid.

■ On adjustment of the touch panel (CALIBRATION)

The buttons on the touch panel may not work correctly. If this happens, follow the procedure below. It is recommended that you connect your camcorder to the wall socket using the supplied AC Adaptor during the operation.

- ① Turn on your camcorder, then press  (HOME).
- ② Touch  (SETTINGS) → [GENERAL SET] → [CALIBRATION].

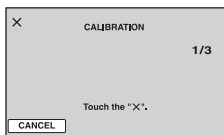

- ③ Touch "x" displayed on the screen with the corner of the "Memory Stick Duo" or the like. The position of "x" changes. Touch [CANCEL] to cancel.

If you did not press the right spot, try the calibration again.

⚡ Notes

- Do not use a sharp-pointed object for calibration. Doing so may damage the LCD screen.
- You cannot calibrate the LCD screen if it is rotated, or closed with the screen facing out.

Maintenance and precautions (Continued)

On handling the casing

- If the casing is soiled, clean the camcorder body with a soft cloth lightly moistened with water, and then wipe the casing with a dry soft cloth.
- Avoid the following to avoid damage to the finish:
 - Using chemicals such as thinner, benzene, alcohol, chemical cloths, repellent, insecticide and sunscreen.
 - Handling the camcorder with above substances on your hands.
 - Leaving the casing in contact with rubber or vinyl objects for a long period of time.

On the pickup lens

- Do not touch the lens inside the disc cover. Keep the disc cover closed except when inserting and removing the disc, to keep dust out.
- When your camcorder does not work because the pickup lens is dirty, clean it with a blower (not supplied). Do not touch the pickup lens directly during cleaning because this may cause the camcorder to malfunction.

Pickup lens

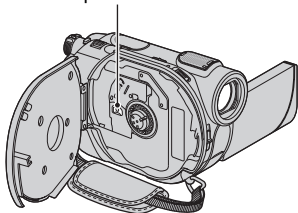

About care and storage of the lens

- Wipe the surface of the lens clean with a soft cloth in the following instances:
 - When there are fingerprints on the lens surface.
 - In hot or humid locations
 - When the lens is exposed to salty air such as at the seaside.
- Store in a well-ventilated location subject to little dirt or dust.
- To prevent mold, periodically clean the lens as described above. It is recommended that you

operate your camcorder about once a month to keep it in optimum state for a long time.

Cleaning inside the viewfinder

Remove any dust from inside the viewfinder by following the steps below.

- ① Pull out the viewfinder.
- ② While pushing in the tab on the side with a fine-tipped object such as a ball point pen, pull the eyecup block in the direction of the arrow to remove.

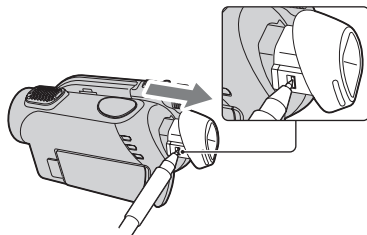

- ③ Remove dust from the eyecup block with a camera blower, etc.

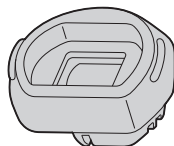

- ④ Press the viewfinder onto the body of the camcorder.
- ⑤ Remove dust from the inside area where the eyecup block was attached with a camera blower, etc.

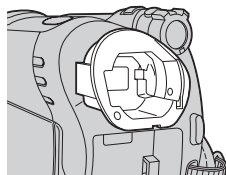

- ⑥ Attach the eyecup block to the viewfinder, pushing it straight on until it clicks.

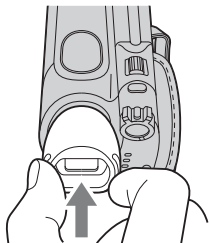

⚡ Notes

- The eyecup block is a precision part. Do not disassemble it further.
- Do not touch the lens of the eyecup block.
- If you turn the viewfinder lens adjustment lever after removing the eyecup block from your camcorder, the lever and lens may come out of the eyecup block. If this happens, replace them as follows:

- ① Attach the lever to the eyecup block in the position illustrated. Do not turn the lever before fitting the lens in place.

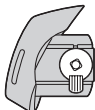

- ② Place the lens in the eyecup block so that the three projections fit into the respective grooves.

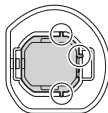

- ③ Turn the lever in the direction of the arrow to insert the lens fully into the eyecup block.



On charging the pre-installed rechargeable battery

Your camcorder has a pre-installed rechargeable battery to retain the date, time, and other settings even when the POWER switch is set to OFF (CHG). The pre-installed rechargeable battery is always charged while your camcorder is connected to the wall socket via the AC Adaptor or while the battery pack is attached. The rechargeable battery will be fully discharged in about **3 months** if you do not use your camcorder at all. Use your camcorder after charging the pre-installed rechargeable battery.

However, even if the pre-installed rechargeable battery is not charged, the camcorder operation will not be affected as long as you are not recording the date.

■ Procedures

Connect your camcorder to a wall socket using the supplied AC Adaptor, and leave it with the POWER switch set to OFF (CHG) for more than 24 hours.

Specifications

System

Video compression format

MPEG2/JPEG (Still images)

Audio compression format

DCR-DVD106E/DVD108E/DVD608E

Dolby Digital 2ch

Dolby Digital Stereo Creator

DCR-DVD109E/DVD306E/DVD308E/
DVD708E

Dolby Digital 2/5.1ch

Dolby Digital 5.1 Creator

Video signal

PAL color, CCIR standards

Usable discs

8 cm DVD-RW/DVD+RW/DVD-R/
DVD+R DL

Recording format

Movie

DVD-RW: DVD-VIDEO (VIDEO mode),
DVD-Video Recording
(VR mode)

DVD+RW: DVD+RW Video

DVD-R/DVD+R DL: DVD-VIDEO

Still image

Exif* Ver.2.2

Recording time

DVD-RW/DVD+RW/DVD-R

HQ: Approx. 20 min

SP: Approx. 30 min

LP: Approx. 60 min

DVD+R DL

HQ: Approx. 35 min

SP: Approx. 55 min

LP: Approx. 110 min

Viewfinder

Electric viewfinder (color)

Image device

DCR-DVD106E/DVD108E/DVD109E/
DVD608E

3 mm (1/6 type) CCD (Charge Coupled Device)

Gross:

Approx. 800 000 pixels

Effective (Movie):

Approx. 400 000 pixels

Effective (Still):

Approx. 400 000 pixels

DCR-DVD306E/DVD308E/DVD708E

3mm (1/6 type) CCD (Charge Coupled Device)

Gross:

Approx. 1 070 000 pixels

Effective (Movie,16:9)

Approx. 670 000 pixels

Effective (Movie,4:3)

Approx. 690 000 pixels

Effective (Still, 4:3)

Approx. 1 000 000 pixels

Effective (Still, 16:9)

Approx. 750 000 pixels

Lens

Carl Zeiss Vario-Tessar

DCR-DVD106E/DVD108E/DVD109E/
DVD608E

Optical:40x, Digital:80x, 2 000x

DCR-DVD306E/DVD308E/DVD708E

Optical:25x, Digital:50x, 2 000x

Filter diameter: 30mm (1 3/16 in.)

Focal length

DCR-DVD106E/DVD108E/DVD109E/
DVD608E

F=1, 8-4,1

f=1.9 - 76.0mm (3/32 - 3 in.)

When converted to a 35 mm still camera

For movies:

36 - 1 440mm (1 7/16 - 56 3/4 in.)

For still images:

36 - 1 440mm (1 7/16 - 56 3/4 in.)

DCR-DVD306E/DVD308E/DVD708E

F=1, 8-3,2

f=2.5 - 62.5mm (1/8 - 2 1/2 in.)

When converted to a 35 mm still camera

For movies:

41 - 1 189mm (1 5/8 - 46 7/8 in.) (16:9)**

43 - 1 075mm (1 3/4 - 42 3/8 in.) (4:3)

For still images:

36 - 900mm (1 7/16 - 35 1/2 in.) (4:3)

39 - 975mm (1 9/16 - 38 1/2 in.) (16:9)

Color temperature

[AUTO], [ONE PUSH], [INDOOR] (3 200 K),

[OUTDOOR] (5 800 K)

Minimum illumination

DCR-DVD106E/DVD108E/DVD109E/
DVD608E

3 lx (lux) (AUTO SLW SHUTTR ON, Shutter
speed 1/25 second)

0 lx (lux) (during NightShot plus function)

DCR-DVD306E/DVD308E/DVD708E

4 lx (lux) (AUTO SLW SHUTTR ON, Shutter
speed 1/25 second)

0 lx (lux) (during NightShot plus function)

* "Exif" is a file format for still images, established by the JEITA (Japan Electronics and Information Technology Industries Association). Files in this format can have additional information such as your camcorder's setting information at the time of recording.

**In 16:9 mode, the focal length figures are actual figures resulting from wide angle pixel readout.

- Manufactured under license from Dolby Laboratories.

Input/Output connectors

Audio/Video output

- 10 pin connector
- Video signal: 1 V_{p-p}, 75 Ω (ohms)
- Luminance signal: 1 V_{p-p}, 75 Ω (ohms)
- Chrominance signal: 0.3 V_{p-p}, 75 Ω (ohms)
- Audio signal: 327 mV (at Load impedance 47 kΩ (kilohms)), Output impedance less than 2.2 kΩ (kilohms)

USB jack

- mini-B
(DCR-DVD106E/DVD109E/DVD306E:
output only)

REMOTE jack (DCR-DVD306E/ DVD308E/DVD708E)

- Stereo mini-minijack (Ø 2.5 mm)

LCD screen

Picture

- DCR-DVD106E/DVD108E/DVD109E/
DVD608E
- 6.2 cm (2.5 type)
- DCR-DVD306E/DVD308E/DVD708E
- 6.9 cm (2.7 type, aspect ratio 16:9)

Total number of pixels

- 123 200 (560 × 220)

General

Power requirements

- 6.8 V/7.2 V (battery pack)
- 8.4 V (AC Adaptor)

Average power consumption

- DCR-DVD106E/DVD108E/DVD608E
LCD : 2.9W
Viewfinder : 2.7W
- DCR-DVD109E
LCD : 3.0W
Viewfinder : 2.8W
- DCR-DVD306E/DVD308E/DVD708E
LCD : 3.2W
(When the LCD backlight is on)
Viewfinder : 2.9W

Operating temperature

- 0°C to +40°C (32°F to 104°F)

Storage temperature

- 20°C to +60°C (-4°F to +140°F)

Dimensions (Approx.)

- 54.5 × 89 × 130.5 mm (2 1/4 × 3 5/8 × 5 1/4 in.) (w × h × d) including the projecting parts

- 54.5 × 89 × 130.5 mm (2 1/4 × 3 5/8 × 5 1/4 in.) (w × h × d) including the projecting parts with supplied battery pack NP-FH40 attached

Mass (Approx.)

- DCR-DVD106E/DVD108E/DVD109E/
DVD608E
- 390 g (13 oz) main unit only
- 440 g (15 oz) including the NP-FH40
rechargeable battery pack and disc
- DCR-DVD306E/DVD308E/DVD708E
- 400 g (14 oz) main unit only
- 450 g (15 oz) including the NP-FH40
rechargeable battery pack and disc

Supplied accessories

- See page 19.

AC Adaptor AC-L200/L200B

Power requirements

- AC 100 - 240 V, 50/60 Hz

Current consumption

- 0.35 - 0.18 A

Power consumption

- 18W

Output voltage

- DC 8.4V*

Operating temperature

- 0°C to +40°C (32°F to 104°F)

Storage temperature

- 20°C to +60°C (-4°F to +140°F)

Dimensions (Approx.)

- 48 × 29 × 81 (1 15/16 × 1 3/16 × 3 1/4 in.)
(w × h × d) excluding the projecting parts

Mass (Approx.)

- 170 g (6 oz) excluding the mains lead

- * See at the label of AC Adaptor for other specifications.

Rechargeable battery pack NP-FH40

Maximum output voltage

- DC8.4V

Output voltage

- DC7.2V

Capacity

- 4.9 wh (680 mAh)

Dimensions (Approx.)

- 31.8 × 18.5 × 45.0 mm
(1 5/16 × 3/4 × 1 13/16 in.) (w × h × d)

Mass (Approx.)

- 45 g (1.6 oz)

Specifications (Continued)

Operating temperature

0°C to +40°C (32°F to 104°F)

Type

Li-ion

Design and specifications are subject to change without notice.

On trademarks

- “Handycam” and **HANDYCAM** are registered trademarks of Sony Corporation.
- “Memory Stick,”  “Memory Stick Duo,” **MEMORY STICK DUO**,” “Memory Stick PRO Duo,” **MEMORY STICK PRO DUO**,” “MagicGate,” **MAGICGATE**,” “MagicGate Memory Stick” and “MagicGate Memory Stick Duo” are trademarks of Sony Corporation.
- “InfoLITHIUM” is a trademark of Sony Corporation.
- DVD-RW, DVD+RW, DVD-R, and DVD+R DL logo are trademarks.
- Dolby and the double-D symbol are trademarks of Dolby Laboratories.
- Dolby Digital 5.1 Creator is a trademark of Dolby Laboratories.
- Microsoft, Windows, and Windows Media are either registered trademarks or trademarks of Microsoft Corporation in the United States and/or other countries.
- Macintosh and Mac OS are registered trademarks of Apple Computer, Inc in the U.S. and other countries.
- Pentium is a trademark or registered trademark of Intel Corporation.
- Adobe, the Adobe logo, and Adobe Acrobat are either registered trademarks or trademarks of Adobe Systems Incorporated in the United States and/or other countries.

All other product names mentioned herein may be the trademarks or registered trademarks of their respective companies. Furthermore, ™ and “®” are not mentioned in each case in this manual.

Notes on the License

ANY USE OF THIS PRODUCT OTHER THAN CONSUMER PERSONAL USE IN ANY MANNER THAT COMPLIES WITH THE MPEG-2 STANDARD FOR ENCODING VIDEO INFORMATION FOR PACKAGED MEDIA IS EXPRESSLY PROHIBITED WITHOUT A LICENSE UNDER APPLICABLE PATENTS IN THE MPEG-2 PATENT PORTFOLIO, WHICH LICENSE IS AVAILABLE FROM MPEG LA, L.L.C., 250 STEELE STREET, SUITE 300, DENVER, COLORADO 80206.

“C Library,” “Expat,” “zlib,” and “libjpeg” software are provided in your camcorder. We provide this software based on license agreements with their owners of copyright. Based on requests by the owners of copyright of these software applications, we have an obligation to inform you of the following. Please read the following sections.

Read “license1.pdf” in the “License” folder on the CD-ROM. You will find licenses (in English) of “C Library,” “Expat,” “zlib,” and “libjpeg” software.

On GNU GPL/LGPL applied software

The software that is eligible for the following GNU General Public License (hereinafter referred to as “GPL”) or GNU Lesser General Public License (hereinafter referred to as “LGPL”) are included in the camcorder.

This informs you that you have a right to have access to, modify, and redistribute source code for these software programs under the conditions of the supplied GPL/LGPL.

Source code is provided on the web. To download, go to the following website and select HDR-UX1/HDR-SR1.

<http://www.sony.net/Products/Linux/>

We would prefer you do not contact us about the contents of source code.

Read “license2.pdf” in the “License” folder on the CD-ROM. You will find licenses (in English) of “GPL,” and “LGPL” software.



To view the PDF, Adobe Reader is needed. If it is not installed on your computer, you can download it from the Adobe Systems web page:

<http://www.adobe.com/>

Identifying parts and controls

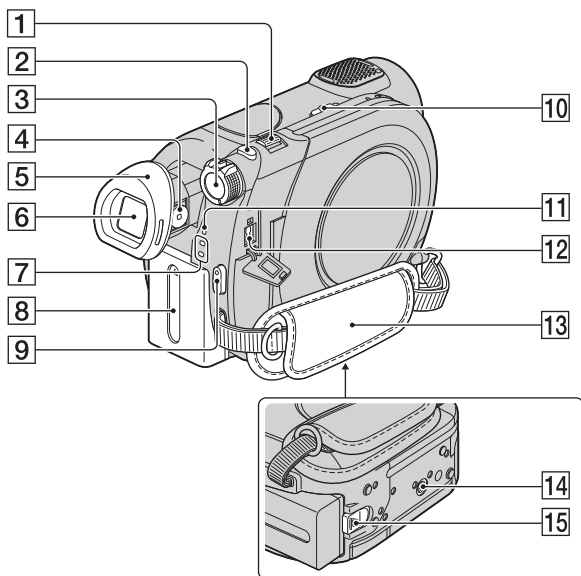
The numbers in () are reference pages.



- 1** Power zoom lever (34, 39)
- 2** PHOTO button (29, 33)
- 3** POWER switch (23)
- 4** Viewfinder lens adjustment lever (25)
- 5** Eyecup (104)
- 6** Viewfinder (25)
- 7**  (Movie)/  (Still) mode lamps (23)
- 8** Battery pack (20)
- 9** START/STOP button (29, 33)
- 10** NIGHTSHOT PLUS switch (35)
- 11** CHG (charge) lamp (20)
- 12** DC IN jack (20)
- 13** Grip belt (32)
- 14** Tripod receptacle
Attach the tripod (optional: the length of the screw must be less than 5.5 mm (7/32 in.)) to the tripod receptacle using a tripod screw.
- 15** BATT (battery) release lever (20)

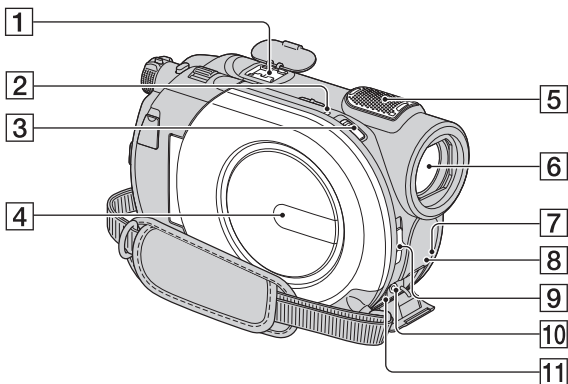

1 Active Interface Shoe Active Interface Shoe*

The Active Interface Shoe supplies power to optional accessories such as a video light, a flash, or a microphone. The accessory can be turned on or off as you operate the POWER switch on your camcorder. Refer to the operating instructions supplied with your accessory for details.

The Active Interface Shoe has a safety device for fixing the installed accessory securely. To connect an accessory, press down and push it to the end, and then tighten the screw. To remove an accessory, loosen the screw, and then press down and pull out the accessory.

- When you are recording movies with an external flash (optional) connected to the accessory shoe, turn off the power of the external flash to prevent charging noise being recorded.
- When an external microphone (optional) is connected, it takes precedence over the internal microphone (p. 34).

2 ACCESS lamp (Disc) (26)

3 Disc cover OPEN switch (26)

4 Disc cover (26)

5 Internal microphone (34)

An Active Interface Shoe compatible microphone (optional) will take precedence when connected (DCR-DVD306E/DVD308E/DVD708E).

6 Lens (Carl Zeiss Lens) (5)

7 Remote sensor*

Point the Remote Commander (p. 113) towards the remote sensor to operate your camcorder.

8 Infrared port (62)

9 LENS COVER switch (25)

10 REMOTE jack*



Connect other optional accessories.

11 A/V OUT jack (40, 52)

* DCR-DVD306E/DVD308E/DVD708E

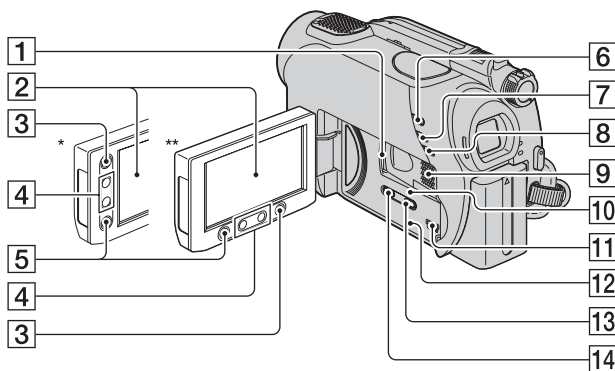
Identifying parts and controls (Continued)



- 1** “Memory Stick Duo” slot (27)
- 2** LCD screen/touch panel (17, 25)
- 3**  (HOME) button (17, 60)
- 4** Zoom buttons (34, 39)
- 5** START/STOP button (29, 33)
- 6**  (VIEW IMAGES) button (30, 37)
- 7** EASY button (29)
- 8** BACK LIGHT button (35)
- 9** Speaker
Playback sounds come out from the speaker. For how to adjust the volume, see page 38.
- 10** Access lamp (“Memory Stick Duo”) (27)
- 11**  (USB) jack (53)
(DCR-DVD106E/DVD109E/
DVD306E: output only)
- 12** RESET button
Initializes all the settings, including the setting of the date and time.

- 13** DISP/BATT INFO button (21)
- 14** WIDE SELECT button** (35)

* DCR-DVD106E/DVD108E/DVD109E/
DVD608E

** DCR-DVD306E/DVD308E/DVD708E

Remote Commander (DCR-DVD306E/ DVD308E/DVD708E)

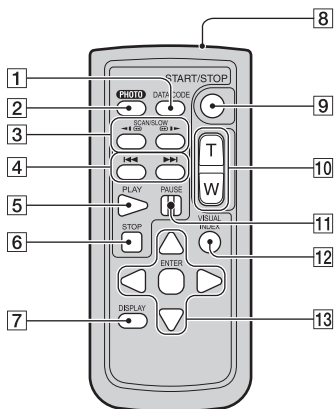

- 1** DATA CODE button (65)
Displays the date and time or camera setting data of the recorded images when you press this during playback.
- 2** PHOTO button (29, 33)
The on-screen image when you press this button will be recorded as a still image.
- 3** SCAN/SLOW buttons (30, 38)
- 4** ◀◀ ▶▶ (Previous/Next) buttons (30, 38)
- 5** PLAY button (30, 38)
- 6** STOP button (30, 38)
- 7** DISPLAY button (21)
- 8** Transmitter
- 9** START/STOP button (29, 33)
- 10** Power zoom buttons (34, 39)
- 11** PAUSE buttons (30, 38)
- 12** VISUAL INDEX button (30, 37)
Displays a VISUAL INDEX screen when you press this during playback.
- 13** ◀/▶/▲/▼/ENTER buttons
When you press any button on the VISUAL INDEX screen or Playlist, the orange frame appears on the LCD screen. Select a desired

button or an item with ◀/▶/▲/▼, then press ENTER to enter.

Notes

- Remove the insulation sheet before using the Remote Commander.

Insulation sheet

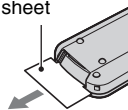

- Point the Remote Commander towards the remote sensor to operate your camcorder (p. 111).
- When no commands have been sent from the Remote Commander in a certain period, the orange frame disappears. When you press any of ◀/▶/▲/▼, or ENTER again, the frame appears at the position where it was displayed last.
- You cannot select some buttons on the LCD screen using ◀/▶/▲/▼.

To change the battery of the Remote Commander

- 1** While pressing on the tab, inset your fingernail into the slit to pull out the battery case.
- 2** Place a new battery with the + side facing up.
- 3** Insert the battery case back into the Remote Commander until it clicks.

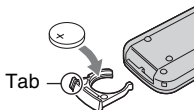

WARNING

Battery may explode if mistreated. Do not recharge, disassemble or dispose of in fire.

- When the lithium battery becomes weak, the operating distance of the Remote Commander may shorten, or the Remote Commander may not function properly. In this case, replace the battery with a Sony CR2025 lithium battery. Use of another battery may present a risk of fire or explosion.

Indicators displayed during recording/playback

Recording movies

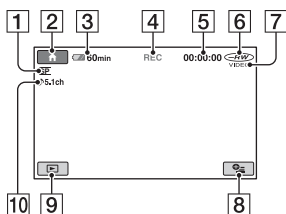

- 1 Recording mode (HQ/SP/LP) (62)
- 2 HOME button (17, 60)
- 3 Remaining battery (approx.) (21)
- 4 Recording status ([STBY] (standby) or [REC] (recording))
- 5 Counter (hour/minute/second)
- 6 Disc type (12)
- 7 Recording format (12)
Appears for DVD-RW only.
- 8 OPTION button (18, 71)
- 9 VIEW IMAGES button (30, 37)
- 10 5.1ch surround recording (34)

Recording still images

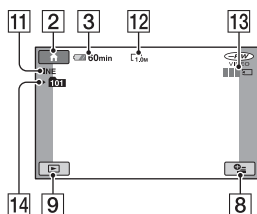

- 11 Quality ([FINE] / [STD]) (64)
- 12 Image size (64)
- 13 Appears while a still image is being saved.
- 14 Recording folder

💡 Tips

- As the number of still images recorded in "Memory Stick Duo" increases, new folders are automatically created to store them.

Viewing movies

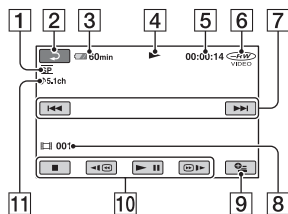

- 1** Recording mode (HQ/SP/LP) (62)
- 2** Return button
- 3** Remaining battery (approx.) (21)
- 4** Playback mode
- 5** Counter (hour/minute/second)
- 6** Disc type (12)
- 7** Previous/Next button (30, 38)
- 8** Scene number
- 9** OPTION button (18, 71)
- 10** Video operation buttons (30, 38)
- 11** 5.1ch surround recording (34)

Viewing still images

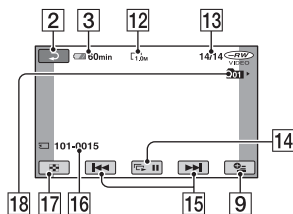

- 12** Image size (64)
- 13** Current still image number / Total number of recorded still images
- 14** Slide show button (39)
- 15** Previous/Next button (31, 38)
- 16** Data file name
- 17** VISUAL INDEX button (30, 37)
- 18** Playback folder

Indicators displayed during recording/playback (Continued)

Indicators when you made changes

Following indicators appear during recording/playback to indicate the settings of your camcorder.

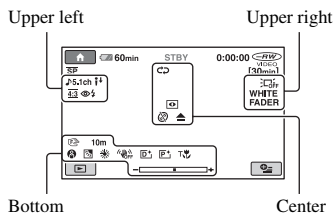

Upper left

Indicator	Meaning
	5.1ch surround recording/playback (34)
	Self-timer recording (77)
	MICREF LEVEL low (77)
	Flash (65, 77)
	[WIDE SELECT] (62)
	WIDE SELECT (35)

Upper right

Indicator	Meaning
	Fader (76)
	LCD backlight off (25)

Center

Indicator	Meaning
	NightShot plus (35)
	Super NightShot plus (76)
	Color Slow Shutter (76)
	Slide show set (39)

Indicator	Meaning
	PictBridge connecting (53)
	Warning (92)

Bottom

Indicator	Meaning
	Picture effect (77)
	Digital effect (77)
	Manual focus (73)
	SCENE SELECTION (74)
	Backlight (35)
	White balance (75)
	SteadyShot off (63)
	EXPOSURE (74)/ SPOT METER (74)
	Tele macro (73)

Data code during recording

The date, time, and camera setting data of the recorded images are recorded automatically on the disc and “Memory Stick Duo.” They are not displayed while recording. However, you can check them as [DATA CODE] during playback (p. 65). You can view the recording date and time on another device, etc. ([SUB-T DATE], p. 63).

Glossary

■ 5.1ch surround sound

A system that plays back sound on 6 speakers, 3 at the front (left, right and center) and 2 at the rear (right and left) with an additional low-pass subwoofer counted as a 0.1 channel for frequencies of 120 Hz or lower.

■ DVD menu

A menu screen that enables you to select a particular scene from a disc being played back on another device.

■ Dolby Digital

An audio encoding (compression) system developed by Dolby Laboratories Inc.

■ Dolby Digital 5.1 Creator

Sound compression technology developed by Dolby Laboratories Inc. which compresses audio efficiently while preserving high sound quality. It enables recording of 5.1ch surround sound while using disc space more efficiently. Discs created by Dolby Digital 5.1 Creator can be played back on a device compatible with the disc created on your camcorder.

■ MPEG

MPEG stands for Moving Picture Experts Group, the group of standards for the coding (image compression) of video (movie) and audio. There are MPEG1 and MPEG2 formats. Your camcorder records movies with SD (standard definition) image quality in MPEG2 format.

■ Thumbnail

Reduced-size images which enable you to view many images at the same time. "VISUAL INDEX" and "DVD MENU" use a thumbnail display system.

■ VIDEO mode

One of the recording formats you can select when using a DVD-RW. VIDEO mode provides excellent compatibility with other DVD devices.

■ VR mode

One of the recording formats you can select when using a DVD-RW. VR mode enables editing (deleting or sequence rearrangement) with your camcorder. Finalizing the disc lets you play it back on a VR mode compatible DVD device.

■ VISUAL INDEX

This function displays images of movies and still images you have recorded so that you can select those scenes you want to play back.

Index

Numeric

16:9.....	35, 68
16:9 WIDE.....	62
21-pin adaptor.....	41
4:3.....	35, 62, 68
5.1 ch surround recording.....	34
8cm DVD.....	10

A

AC Adaptor.....	20
Active Interface Shoe.....	111
Additional recording.....	58
AREA SET.....	69
Aspect ratio.....	35, 40, 62
AUTO SLW SHUTTR (Auto slow shutter).....	63, 91
A.SHUT OFF (Auto shut off).....	70
A/V connecting cable.....	40, 52

B

BACK LIGHT.....	35, 87
Battery.....	20, 113
Battery Info.....	21
BEACH.....	75
BEEP.....	67
BLACK FADER.....	76
Button-type lithium battery.....	113
B&W.....	77

C

CALIBRATION.....	103
CAMERA DATA.....	65
CANDLE.....	74
CD-ROM.....	78
Charging time.....	21
CLOCK SET.....	23
CLOCK/LANG.....	69
COLOR SLOW SHTR (Color Slow Shutter).....	76, 91

Computer.....	78
Copyright.....	5, 109

D

DATA CODE.....	65
DATE/TIME.....	24, 65, 116
DC IN jack.....	20
DC plug.....	20
DELETE	
Disc.....	46
"Memory Stick Duo".....	47
DEMO MODE.....	70
DIGITAL ZOOM.....	63
Disc.....	26, 98
Disc cover OPEN switch.....	26
DISC INFO.....	55
Disc remaining.....	63
DISC SELECT GUIDE.....	56
DISP OUTPUT.....	69
DISPLAY.....	66
Display indicators.....	114
DIVIDE	
Original.....	48
Playlist.....	51

Dolby Digital 5.1 Creator.....	34, 117
Double-sided disc.....	98
Dubbing.....	52
DVD drive.....	55
DVD menu.....	45
DVD-R.....	13
DVD-RW.....	13
DVD+R DL.....	13
DVD+RW.....	13
D.EFFECT (Digital effect).....	77, 91

E

Easy Handycam.....	29
EDIT.....	48
EXPOSURE.....	74, 91

F

FADER.....	76, 91
FILE NO. (File number).....	64
Finalize.....	42
FIREWORKS.....	74
First Step Guide.....	78, 81, 82
FLASH LEVEL.....	65
FLASH MODE.....	77
FOCUS.....	73, 87
FORMAT	
Disc.....	57
"Memory Stick Duo".....	58

G

GENERAL SET.....	70
Glossary.....	117
Grip belt.....	32

H

HOME MENU.....	16, 60
CLOCK/LANG.....	69
GENERAL SET.....	70
MOVIE SETTINGS.....	62
OUTPUT SETTINGS.....	68
PHOTO SETTINGS.....	64
SOUND/DISP SET.....	67
VIEW IMAGES SET.....	65
HQ.....	62

I

Icon.....	See Display indicators
IMAGE SIZE.....	64
Indicators.....	116
INDOOR.....	75
InfoLITHIUM.....	101
Install.....	79
Insulation sheet.....	113

J

JPEG.....	99
-----------	----

L

LANDSCAPE.....	75
LANGUAGE SET.....	69
LCD backlight.....	25
LCD BL LEVEL (LCD back light level).....	67, 88
LCD BRIGHT.....	67
LCD COLOR.....	67
Lens cover.....	25
LP.....	62

M

Macintosh.....	82
Mains lead.....	20
Maintenance.....	98
MANAGE DISC/MEMORY category.....	55
“Memory Stick Duo”.....	27, 99
Memory Stick Duo adaptor	100
MICREF LEVEL.....	77
Mirror mode.....	35
Moisture condensation.....	103
MOVIE SETTINGS.....	62
MPEG.....	117

N

NIGHTSHOT LIGHT.....	62
NightShot plus.....	35
NTSC.....	96

O

ONE PUSH.....	75
OPTION MENU.....	71
Original	
DELETE.....	46
DIVIDE.....	48
OTHERS category.....	46
OUTDOOR.....	75
OUTPUT SETTINGS.....	68

P

PAL.....	96
PASTEL.....	77
PHOTO SETTINGS.....	64
Pickup lens.....	104
PictBridge.....	53
Picture Motion Browser.....	78
PICT.EFFECT (Picture effect)	77, 91
Playback.....	30, 37
Playback zoom.....	39
Playing time.....	22
Playlist	
Creating.....	49
Playback.....	50
PORTRAIT.....	75
Pre-installed rechargeable battery.....	105
Preparation.....	20
Print.....	53

Q

QUALITY.....	64
--------------	----

R

REC MODE (Recording mode)	62
Recording.....	29, 32
Recording format.....	12
Recording time.....	12, 21
REDEYE REDUC.....	65
REMAINING.....	63
Remaining battery	21, 114, 115
Remote Commander.....	113
REMOTE CTRL.....	70
RESET button.....	112

S

SCENE SELECTION	74, 90
Self-diagnosis display.....	92

SELF-TIMER.....	77
SEPIA.....	77
SETTINGS category.....	60
Slide show.....	39
SNOW.....	75
Software.....	79
SOUND/DISP SET.....	67
SP.....	62
Specifications.....	106
SPORTS (Sports lesson).....	75
SPOT FOCUS.....	73
SPOT METER (Flexible spot meter).....	74, 91
SPOTLIGHT.....	75
STEADYSHOT.....	63
Still Images.....	29, 33
SUB-T DATE.....	63
SUMMERTIME.....	69
SUNRISE&SUNSET.....	74
Supplied items.....	19
System requirements.....	78
S.NIGHTSHOT PLS (Super NightShot plus).....	76, 91

T

TELE MACRO.....	73, 91
Telephoto.....	34
Thumbnail.....	117
Tripod.....	110
TV.....	40, 68
TV color system.....	96
TV TYPE.....	40, 68
TWILIGHT.....	74

U

UNFINALIZE.....	58, 90
Using abroad.....	96

V

VBR.....	12
----------	----

Index (Continued)

VCR or DVD/HDD recorders	52
VF B.LIGHT (Viewfinder brightness)	67
VIDEO mode	12, 117
VIEW IMAGES SET	65
Viewfinder	25
Viewing	30
VISUAL INDEX	30, 37, 117
VOLUME	38, 67
Volume label	56
VR mode	12, 117

W

Warning indicators	92
Warning messages	93
WHITE BAL. (White balance)	75, 91
WHITE FADER	76
Wide angle	34
WIDE SELECT	62, 88
Windows	78
World time difference	97
Write-protect tab	100

Z

Zoom	34
------------	----

