

# Digital Still Camera

---

## Operating Instructions

Before operating the unit, please read this manual thoroughly, and retain it for future reference.

## Owner's Record

The model and serial numbers are located on the bottom. Record the serial number in the space provided below. Refer to these numbers whenever you call upon your Sony dealer regarding this product.

Model No. \_\_\_\_\_

Serial No. \_\_\_\_\_

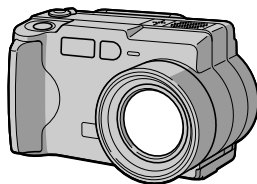

DSC-S50

**Cyber-shot**  
Digital Still Camera



InfoLITHIUM



  
MEMORY STICK™

## DSC-S30/S50

## WARNING

To prevent fire or shock hazard, do not expose the unit to rain or moisture.

## For the Customers in the U.S.A.

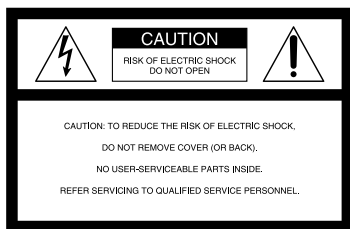

This symbol is intended to alert the user to the presence of uninsulated “dangerous voltage” within the product’s enclosure that may be of sufficient magnitude to constitute a risk of electric shock to persons.



This symbol is intended to alert the user to the presence of important operating and maintenance (servicing) instructions in the literature accompanying the appliance.

Never expose the battery pack to temperature above 140°F (60°C), such as in a car parked in the sun or under direct sunlight.

If you have any questions about this product, you may call:

Sony Customer Information Center  
1-800-222-SONY (7669)

or write to:

Sony Customer Information Center  
1 Sony Drive, Mail Drop #T1-11, Park Ridge, NJ 07656

## CAUTION

You are cautioned that any changes or modifications not expressly approved in this manual could void your authority to operate this equipment.

### Declaration of Conformity

Trade Name: SONY  
Model No.: DSC-S30  
Responsible Party: Sony Electronics Inc.  
Address: 1 Sony Drive, Park Ridge, NJ 07656 USA  
Telephone No.: 201-930-6972

This device complies with Part 15 of the FCC Rules. Operation is subject to the following two conditions: (1) This device may not cause harmful interference, and (2) this device must accept any interference received, including interference that may cause undesired operation.

### Declaration of Conformity

Trade Name: SONY  
Model No.: DSC-S50  
Responsible Party: Sony Electronics Inc.  
Address: 1 Sony Drive, Park Ridge, NJ 07656 USA  
Telephone No.: 201-930-6972

This device complies with Part 15 of the FCC Rules. Operation is subject to the following two conditions: (1) This device may not cause harmful interference, and (2) this device must accept any interference received, including interference that may cause undesired operation.

**Note:**

This equipment has been tested and found to comply with the limits for a Class B digital device, pursuant to Part 15 of the FCC Rules. These limits are designed to provide reasonable protection against harmful interference in a residential installation. This equipment generates, uses, and can radiate radio frequency energy and, if not installed and used in accordance with the instructions, may cause harmful interference to radio communications. However, there is no guarantee that interference will not occur in a particular installation. If this equipment does cause harmful interference to radio or television reception, which can be determined by turning the equipment off and on, the user is encouraged to try to correct the interference by one or more of the following measures:

- Reorient or relocate the receiving antenna.
- Increase the separation between the equipment and receiver.
- Connect the equipment into an outlet on a circuit different from that to which the receiver is connected.
- Consult the dealer or an experienced radio/TV technician for help.

The shielded interface cable recommended in this manual must be used with this equipment in order to comply with the limits for a digital device pursuant to Subpart B of Part 15 of FCC Rules.

**DISPOSAL OF LITHIUM ION BATTERY.****LITHIUM ION BATTERY.  
DISPOSE OF PROPERLY.**

You can return your unwanted lithium ion batteries to your nearest Sony Service Center or Factory Service Center.

**Note:**

In some areas the disposal of lithium ion batteries in household or business trash may be prohibited.

For the Sony Service Center nearest you call 1-800-222-SONY (United States only)  
For the Sony Factory Service Center nearest you call 416-499-SONY (Canada only)

**Caution:**



Do not handle damaged or leaking lithium ion battery.

**For the Customers in Canada****CAUTION**

TO PREVENT ELECTRIC SHOCK, DO NOT USE THIS POLARIZED AC PLUG WITH AN EXTENSION CORD, RECEPTACLE OR OTHER OUTLET UNLESS THE BLADES CAN BE FULLY INSERTED TO PREVENT BLADE EXPOSURE.

**NOTICE FOR THE CUSTOMERS IN THE UNITED KINGDOM**

A moulded plug complying with BS 1363 is fitted to this equipment for your safety and convenience.

Should the fuse in the plug supplied need to be replaced, a 5 AMP fuse approved by ASTA or BSI to BS 1362, (i.e. marked with  or  mark) must be used.

If the plug supplied with this equipment has a detachable fuse cover, be sure to attach the fuse cover after you change the fuse. Never use the plug without the fuse cover. If you should lose the fuse cover, please contact your nearest Sony service station.

**For the Customers in Germany**

Directive: EMC Directive 89/336/EEC.92/31/EEC

This equipment complies with the EMC regulations when used under the following circumstances:

- Residential area
  - Business district
  - Light-industry district
- (This equipment complies with the EMC standard regulations EN55022 Class B.)

## Attention

The electromagnetic fields at the specific frequencies may influence the picture and sound of this camera.

## “Memory Stick”



## For the Customers in CANADA

This Class B digital apparatus complies with Canadian ICES-003.

## For the Customers in the U.S.A.

This device complies with Part 15 of the FCC Rules. Operation is subject to the following two conditions: (1) This device may not cause harmful interference, and (2) this device must accept any interference received, including interference that may cause undesired operation.

## Be sure to read the following before using your camera

- **This Owner's Manual is for the two models of the DSC-S30 and the DSC-S50. Check to make sure which model you have purchased before you use your camera.**
- **The illustrations in this manual show the DSC-S50.**

### Trial recording

Before you record one-time events, you may want to make a trial recording to make sure that the camera is working correctly.

### No compensation for contents of the recording

Contents of the recording cannot be compensated for if recording or playback is not possible due to a malfunction of your camera, etc.

## Notes on image data compatibility

- This camera conforms with the Design Rules for Camera File Systems universal standard established by the JEIDA (Japan Electronic Industries Development Association). You cannot play back on your camera still images recorded on other equipment (DCR-TRV890E/TRV900/TRV900E, DSC-D700, DSC-D770) that does not conform with this universal standard. (These models are not sold in some areas.)
- Playback of images recorded with your camera on other equipment and playback of images recorded or edited with other equipment on your camera are not guaranteed.

## Precaution on copyright

Television programs, films, video tapes, and other materials may be copyrighted. Unauthorized recording of such materials may be contrary to the provision of the copyright laws.

## Do not shake or strike the camera

In addition to malfunctions and inability to record images, this may render the “Memory Stick” unusable or image data breakdown, damage or loss may occur.

## LCD screen and lens

- The LCD screen is manufactured using high-precision technology. However, there may be some tiny black points and/or bright points (red, blue or green in color) that constantly appear on the LCD screen. These points are normal in the manufacturing process and do not affect the recording in any way. Over 99.99% of the pixels are operational for effective use.
- Be careful when placing the camera near a window or outdoors. Exposing the LCD screen or the lens to direct sunlight for long periods may cause malfunctions.

## Do not get the camera wet

When taking pictures outdoors in the rain or under similar conditions, be careful not to get the camera wet. If moisture condensation occurs, refer to page 54 and follow the instructions on how to remove it before using the camera.

## Back up recommendation

To avoid the potential risk of data loss, always copy (back up) data to a disk.

# Table of contents

## Getting started

Identifying the parts .....	6
Preparing the power supply .....	8
Setting the date and time .....	13
Inserting the “Memory Stick” .....	15

## Basic operations

### ► Recording

Recording still images .....	16
Recording moving images (DSC-S50 only) .....	20

### ► Playback

Playing back still images .....	21
Playing back moving images .....	22
Viewing images using a personal computer .....	24
Image file storage destinations and image files .....	28

## Advanced operations

### Before performing advanced operations

How to use the MODE selector .....	29
How to use the control button .....	29
How to change the menu settings .....	31
Menu settings .....	32

### ► Various recording

Rotating the LCD screen — Face-to-Face recording .....	37
Setting the image size (IMAGE SIZE) .....	37
Recording still images for e-mail (E-MAIL) .....	38
Adding audio files to still images (VOICE) (DSC-S50 only) .....	39
Recording text documents (TEXT) .....	39
Recording uncompressed images (TIFF) .....	40
Recording images in macro .....	41
Setting the distance to the subject .....	41

Using the PROGRAM AE function .....	42
Adjusting the exposure (EXPOSURE) .....	43
Adjusting the white balance (WHITE BALANCE) .....	43
Recording the date and time on the still image (DATE/TIME) .....	44
Enjoying picture effects (P.EFFECT) .....	44

### ► Various playback

Playing back six images at once (INDEX) .....	45
Enlarging a part of the still image (Zoom and trimming) .....	46
Rotating a still image (ROTATE) .....	47
Playing back the images in order (SLIDE SHOW) .....	47
Viewing images on a TV screen .....	48

### ► Editing

Preventing accidental erasure (PROTECT) .....	49
Deleting images (DELETE) .....	50
Changing the recorded still image size (RESIZE) .....	51
Copying images (COPY) .....	51
Selecting still images to print (PRINT MARK) .....	53

## Additional information

Precautions .....	54
On “Memory Sticks” .....	55
Using your camera abroad .....	56
Troubleshooting .....	57
Warning and notice messages .....	61
Self-diagnosis display .....	62
Specifications .....	63
LCD screen indicators .....	64
Index .....	66

## Identifying the parts

See the pages in parentheses for details of operation.

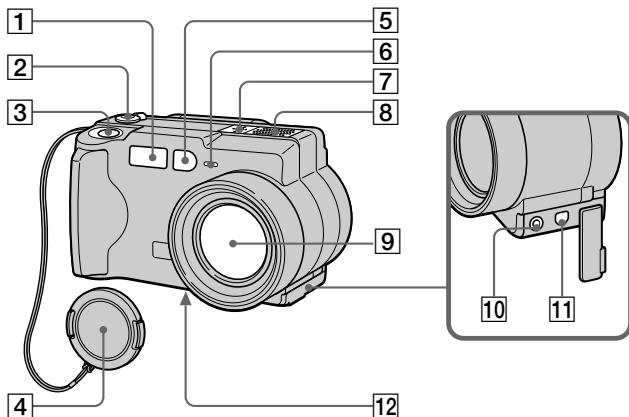

- |  |   |
|--|---|
| <p><b>1 Flash (19)</b></p> <p><b>2 MODE selector (29)</b></p> <p><b>3 Shutter button (16) (20)</b></p> <p><b>4 Lens cap</b></p> <p><b>5 Photocell window for flash</b><br/>Do not block while recording.</p> <p><b>6 Self-timer/recording lamp</b></p> <p><b>7 Built-in microphone (DSC-S50 only)</b><br/>Do not touch while recording.</p> <p><b>8 Speaker (DSC-S50 only)</b></p> | <p><b>9 Lens</b></p> <p><b>10 A/V OUT jack (DSC-S50 only) (48)</b><br/>Audio output is monaural.<br/><b>VIDEO OUT jack (DSC-S30 only) (48)</b></p> <p><b>11 USB jack (25) (26)</b></p> <p><b>12 Tripod receptacle (bottom surface)</b><br/>Use a tripod with a screw length of less than 9/32 inch (6.5 mm). You will be unable to firmly secure the camera to tripods having longer screws, and may damage the camera.</p> |
|--|---|

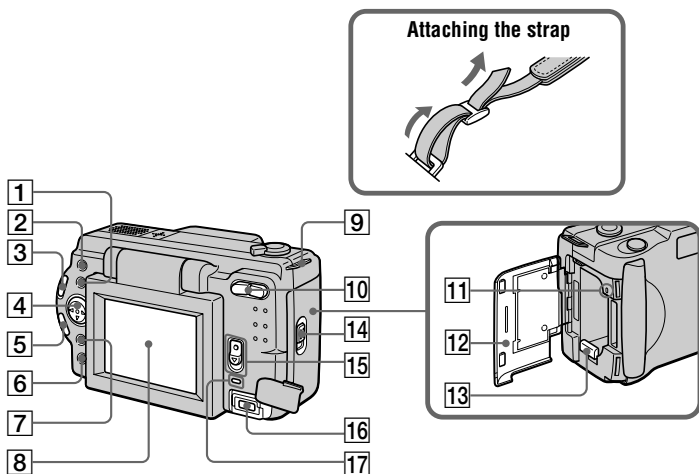

- |  |   |
|--|---|
| <b>1</b> Flash button  | <b>7</b> DISPLAY button                           |
| <b>2</b> FOCUS button (41)   | <b>8</b> LCD screen                               |
| <b>3</b> LCD BACKLIGHT BRIGHT/<br>NORMAL switch  | <b>9</b> Hook for lens cap/strap                  |
| Usually set to NORMAL. When<br>you use the camera outdoors or in<br>other bright places, setting this to<br>BRIGHT makes the LCD screen<br>bright and easy to see, but also<br>uses up the battery faster. | <b>10</b> Zoom button                             |
| <b>4</b> Control button  | <b>11</b> Access lamp (15)                        |
| <b>5</b> PROGRAM AE +/- button<br>VOLUME +/- button  | <b>12</b> Battery/"Memory Stick" cover            |
| <b>6</b> PROGRAM AE button (42)  | <b>13</b> Battery eject lever (8)                 |
|  | <b>14</b> OPEN switch                             |
|  | <b>15</b> POWER switch                            |
|  | <b>16</b> DC IN jack (9) (12)                     |
|  | <b>17</b> POWER lamp/BATT CHARGE<br>lamp (9) (13) |

# Preparing the power supply

## Installing the battery pack

Your camera operates only with the “InfoLITHIUM” NP-FM50 battery pack\* (M series). You cannot use any other battery pack.

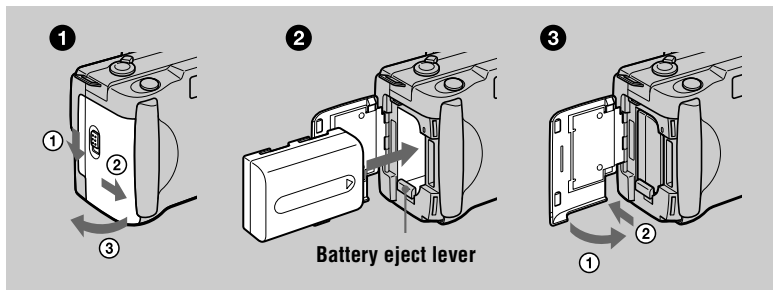

- 1 Open the battery/“Memory Stick” cover.**  
Open the cover while sliding the OPEN switch in the direction of the arrow.
- 2 Install the battery pack.**  
Insert the battery pack with the ▶ mark facing toward the battery compartment as illustrated.
- 3 Close the battery/“Memory Stick” cover.**

## To remove the battery pack

Open the battery/“Memory Stick” cover. Slide the battery eject lever downward, and remove the battery pack.

Be careful not to drop the battery pack when removing it.

### \* What is “InfoLITHIUM”?

“InfoLITHIUM” is a lithium ion battery pack which can exchange information such as battery consumption with compatible video equipment. This unit is compatible with the “InfoLITHIUM” battery pack (M series). “InfoLITHIUM” M series battery packs have the  mark. “InfoLITHIUM” is a trademark of Sony Corporation.



## Charging the battery pack

You cannot charge the battery pack while your camera is turned on. Be sure to turn off your camera before charging.

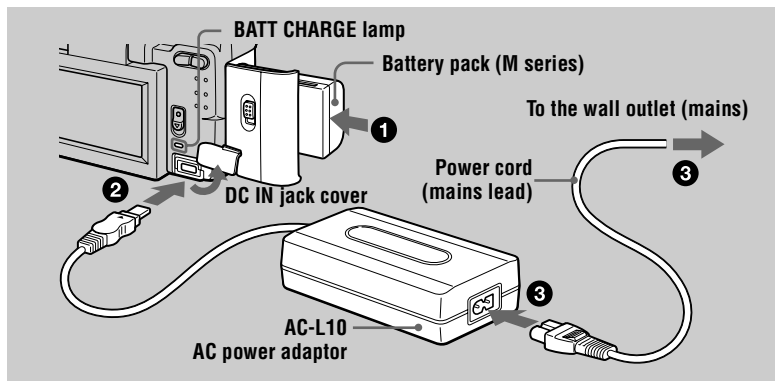

- 1** Insert the battery pack into your camera.
- 2** Open the DC IN jack cover and connect the DC connecting cable to the DC IN jack of your camera with the ▲ mark facing up.
- 3** Connect the power cord (mains lead) to the AC power adaptor and then to a wall outlet (mains).

The BATT CHARGE lamp lights orange when charging begins. When the BATT CHARGE lamp goes off, **normal charge** is completed. For **full charge**, which allows you to use the battery longer than usual, leave the battery pack inserted for about one hour after normal charge is completed.

### Battery remaining indicator

The LCD screen on the camera shows the remaining time for which you can still record or play back images.

This indication may not be entirely accurate depending on the conditions of use and the operating environment.

### Auto power-off function

If you do not operate the camera for about three minutes during recording, the camera turns off automatically to prevent wearing down the battery. To use the camera again, slide down the POWER switch to turn on the camera again.

## Charging time

Battery pack	Full charge (min.)	Normal charge (min.)
NP-FM50 (supplied)	150	90

Approximate time to charge a completely discharged battery pack using the AC-L10 AC power adaptor.

## Battery life and number of images that can be recorded/played back

### STILL mode recording\*

#### DSC-S50

LCD BACKLIGHT	Battery life (min.)	Number of images
BRIGHT	140 (130)	2300 (2100)
NORMAL	150 (140)	2500 (2300)

#### DSC-S30

LCD BACKLIGHT	Battery life (min.)	Number of images
BRIGHT	140 (130)	2800 (2600)
NORMAL	150 (140)	3000 (2800)

### STILL mode playback\*\* (DSC-S50/S30)

LCD BACKLIGHT	Battery life (min.)	Number of images
BRIGHT	170 (160)	3400 (3200)
NORMAL	220 (210)	4400 (4200)

Approximate battery life and number of images that can be recorded/played back with a fully charged battery pack at a temperature of 77°F (25°C), 640×480 image size and in NORMAL recording mode. Numbers in parentheses indicate the time when you use a normally charged battery pack.

\* Recording at about 5-second intervals

\*\* Playing back single images in order at about 3-second intervals

### MOVIE mode recording (DSC-S50 only)

LCD BACKLIGHT	Battery life (min.)
BRIGHT	140 (130)
NORMAL	150 (140)

Approximate time that can be recorded with a fully charged battery pack at a temperature of 77°F (25°C) and 160×112 image size. Numbers in parentheses indicate the time when you use a normally charged battery pack.

**Notes**

- The battery life and number of images will be decreased if you use your camera at low temperatures, use the flash, repeatedly turn the power on/off or use the zoom.
- The capacity of the “Memory Stick” is limited. The above figures are a guide when you continuously record/play back while replacing the “Memory Stick.”
- If sufficient battery remaining time is indicated but the power runs out soon, fully charge the battery so that the correct battery remaining time appears.
- Do not short the DC plug of the AC power adaptor with a metallic object, as this may cause malfunction.
- Do not expose the battery pack to water.

## Using the AC power adaptor

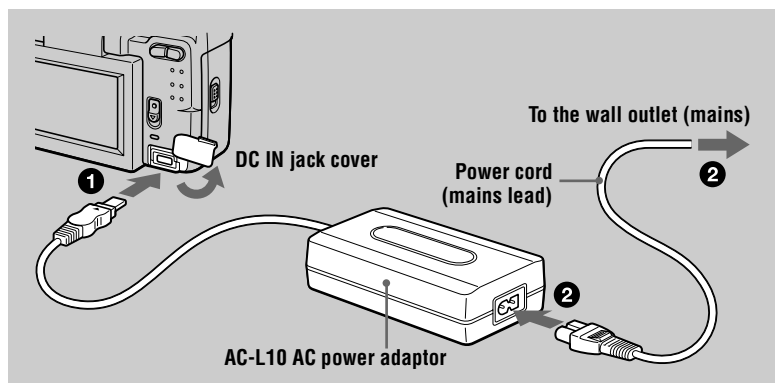

- 1** Open the DC IN jack cover and connect the DC connecting cable to the DC IN jack of your camera with the ▲ mark facing up.
- 2** Connect the power cord (mains lead) to the AC power adaptor and then to a wall outlet (mains).

## Using a car battery

Use Sony DC adaptor/charger.

# Setting the date and time

When you first use your camera, set the date and time. If these are not set, the CLOCK SET screen appears whenever you turn on your camera for recording.

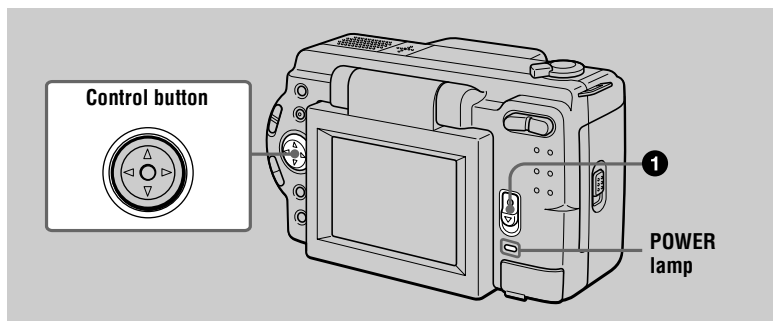

- 1 Slide down the POWER switch to turn on the power.**  
The POWER lamp lights up.

- 2 Press ▲ on the control button.**  
The menu bar appears on the LCD screen.

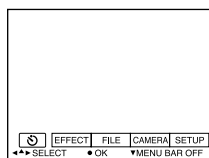

- 3 Select [SETUP] with ► on the control button, then press the center ●.**

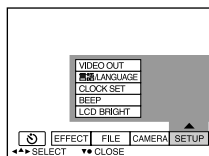

- 4 Select [CLOCK SET] with ▲/▼ on the control button, then press the center ●.**

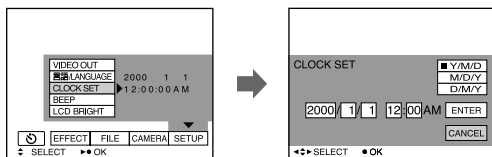

- 5** Select the desired date display format with ▲/▼ on the control button, then press the center ●.

Select from [Y/M/D] (year/month/day), [M/D/Y] (month/day/year) or [D/M/Y] (day/month/year).

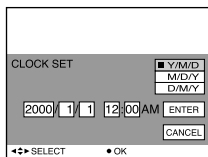

- 6** Select the year, month, day, hour or minute item you want to set with ◀/▶ on the control button.

The item to be set is indicated with ▲/▼.

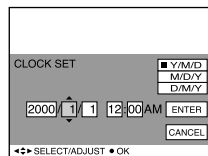

- 7** Set the numeric value with ▲/▼ on the control button, then press the center ● to enter it.

After entering the number, ▲/▼ moves to the next item.

If you selected [D/M/Y] in step 5, set the time on a 24-hour cycle.

- 8** Select [ENTER] with ▶ on the control button, then press the center ● at the desired moment to begin clock movement.

The date and time are entered.

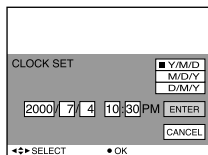

### To cancel the date and time setting

Select [CANCEL] with ▲/▼/◀/▶ on the control button, then press the center ●.

## Inserting the “Memory Stick”

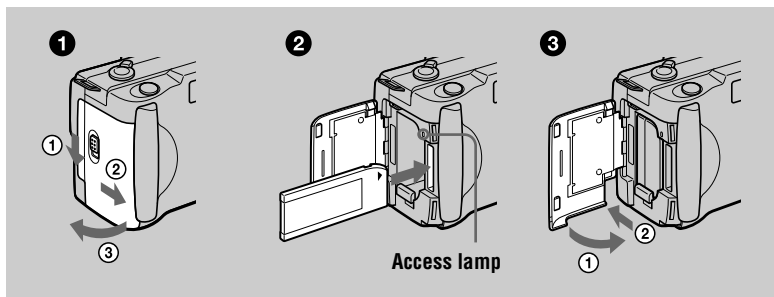

- 1** **Open the battery/“Memory Stick” cover.**  
Open the cover while sliding the OPEN switch in the direction of the arrow.
- 2** **Insert the “Memory Stick.”**  
Insert the “Memory Stick” with the ► mark facing toward the battery compartment as illustrated until it clicks.
- 3** **Close the battery/“Memory Stick” cover.**

### Removing the “Memory Stick”

Open the battery/“Memory Stick” cover, then press the “Memory Stick” once lightly.

#### Notes

- Insert the “Memory Stick” firmly until it clicks, otherwise a message such as “MEMORY STICK ERROR” will be displayed.
- Never remove the “Memory Stick” or turn off the power while the access lamp is lit up.
- You cannot record or edit images on a “Memory Stick” if the erasure prevention switch is set to the LOCK position.

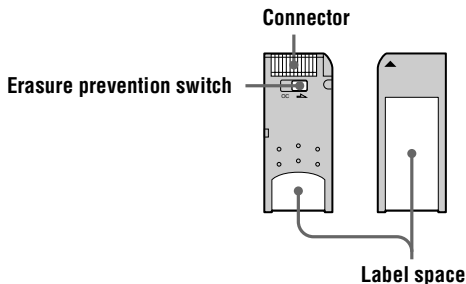

## Recording still images

Still images are recorded in JPEG format.

To record still images, slide the POWER switch down to turn on the power and insert a “Memory Stick.”

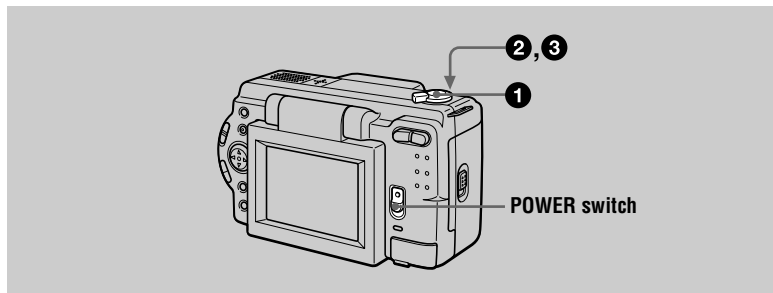

**1** Set the MODE selector to STILL.

**2** Press and hold the shutter button halfway down and check the image.

While the AE lock indicator ● (green) is flashing, the image freezes momentarily, but is not yet recorded. When the camera finishes the automatic adjustments\*, the AE lock indicator ● lights up and the camera is ready for recording.

To cancel the recording, release the shutter button.

Remaining memory capacity indicator

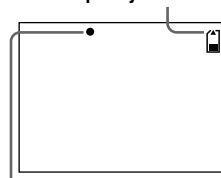

AE lock indicator

**3** Press the shutter button fully down.

The shutter sounds and the image is recorded on the “Memory Stick.” When “REC” disappears, you can record the next image.

\* Exposure and focus are automatically adjusted.

### The number of images you can record on a “Memory Stick”

See pages 37 to 40.

#### Notes

- While the image is being recorded on the “Memory Stick,” do not shake or strike the camera. Also, do not turn the power off, or remove the battery pack or “Memory Stick.”
- When recording a bright subject, the LCD screen color may change after AE lock, but this does not affect the recorded image.



## Checking the last recorded image (Quick Review)

You can check the last recorded image by clearing the menu bar from the screen (page 31) and pressing ◀ on the control button. To return to the normal recording mode, press lightly on the shutter button or select [RETURN] with ◀/▶ on the control button and then press the center ●. You can also delete the image first by selecting [DELETE] on the Quick Review screen with ◀/▶ on the control button and pressing the center ●, and then selecting [OK] with ▲/▼ on the control button and pressing the center ●.

## Using the zoom feature

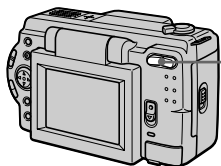

### Zoom button

W side: for wide-angle (subject appears farther away)

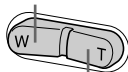

T side: for telephoto (subject appears closer)

## Minimum focal distance to the subject

W side: About 9 7/8 inches (25 cm) or more

T side: About 23 5/8 inches (60 cm) or more

To record even closer subjects, see page 41.

## Digital zoom function

This camera has a digital zoom function.

Digital zoom enlarges the image by digital processing and it starts to function when zoom exceeds 3×.

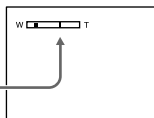

The T side of the bar shows the digital zooming zone.

## Using digital zoom

- The maximum zoom magnification is 6×.
- Digital zooming deteriorates the picture quality. When digital zoom is not necessary, set [DIGITAL ZOOM] to [OFF] in the menu settings (page 34).

### Note

Digital zoom does not work for moving images.

## LCD screen indicators during recording

Press DISPLAY to turn on/off the indicators on the LCD screen.  
See page 64 for a detailed description of the indicated items.

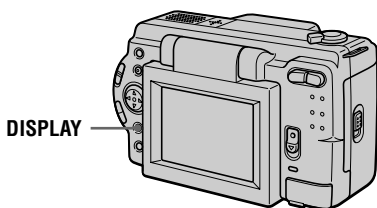







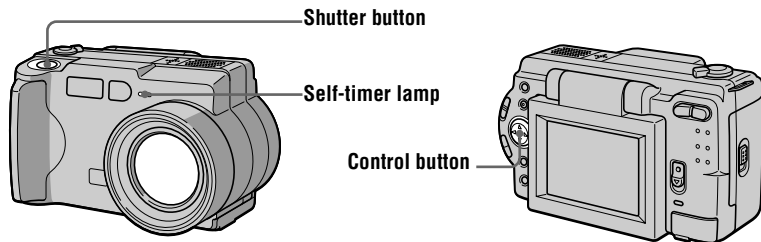

### Notes

- You cannot turn off the self-timer indicators and some of the indicators used in advanced operations.
- The indicators on the LCD screen are not recorded.

## Using the self-timer

When you use the self-timer function, the subject is recorded about 10 seconds after you press the shutter button.



Select  (self-timer) indicator on the LCD screen with /// on the control button, then press the center . The  (self-timer) indicator appears on the LCD screen, and about 10 seconds after you press the shutter button, the subject is recorded. The self-timer lamp flashes after you press the shutter button until the shutter is released.

## Recording images with the flash

The initial setting is auto (no indicator). In this mode, the flash automatically strobes when the surroundings become dark. When you change the flash mode, press the ⚡ (flash) repeatedly so that the flash mode indicator appears on the LCD screen.

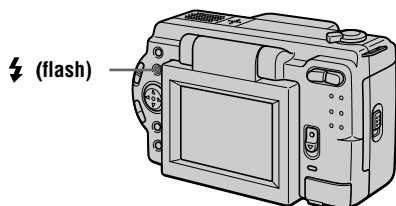

Each time you press the ⚡ (flash), the indicator changes as follows.

(No indicator) → ● → ⚡ → ☹ → (No indicator)

● Auto red-eye reduction: The flash strobes before recording to reduce the red-eye phenomenon.

⚡ Forced flash: The flash strobes regardless of the surrounding brightness.

☹ No flash: The flash does not strobe.

You can change the brightness of the flash (FLASH LEVEL) in the menu settings (page 34).

### Notes

- The recommended shooting distance using the built-in flash is 31/32 feet to 8 1/3 feet (0.3 m to 2.5 m).
- Attaching a conversion lens (not supplied) may block the light from the flash or cause the lens shadow to appear.
- Auto red-eye reduction may not produce the desired red-eye reduction effects depending on individual differences, the distance to the subject, if the subject does not see the pre-strobe, or other conditions. In addition, red-eye reduction effects are also difficult to obtain if you set the shutter to a slow speed in the PROGRAM AE shutter priority mode.
- The flash effect is not obtained easily when you use forced flash in a bright location.

# Recording moving images (DSC-S50 only)

Moving images with audio are recorded in MPEG format.

To record moving images, slide the POWER switch down to turn on the power and insert a “Memory Stick.”

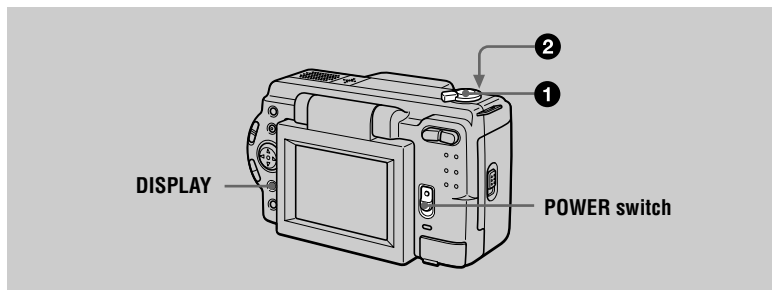

---

**1** Set the MODE selector to MOVIE.

---

**2** Press the shutter button fully down.

“REC” appears on the LCD screen, and the image and sound are recorded on the “Memory Stick.”

#### **If you press the shutter button momentarily**

The image and sound are recorded for five seconds. You can change the recording time to 10 or 15 seconds with [REC TIME SET] in the menu settings (page 33).

#### **If you hold the shutter button down**

The image and sound are recorded while the shutter button is held down for up to 60 seconds. However, when [IMAGE SIZE] in the menu setting is set to [320×240], the maximum recording time is 15 seconds (page 33).

---

### **Zooming or using the self-timer, etc.**

See pages 17 and 18.

### **LCD screen indicators during recording**

Press DISPLAY to turn on/off the indicators on the LCD screen.

These indicators are not recorded. See page 64 for a detailed description of the indicators.

# Playing back still images

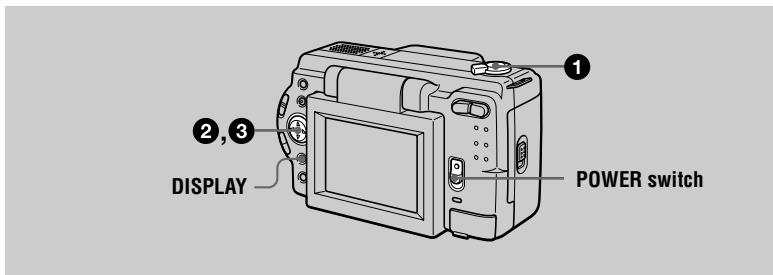

- 1 Set the MODE selector to PLAY.**  
 The last recorded image (still or moving) appears on the LCD screen.
- 2 Press ▲ on the control button to display the menu bar on the LCD screen.**
- 3 Select the desired still image with the control button.**  
 Press ▲/▼/◀/▶ on the control button to select ◀▶ on the LCD screen, then press ◀/▶ on the control button.  
 ◀: To display the preceding image.  
 ▶: To display the next image.

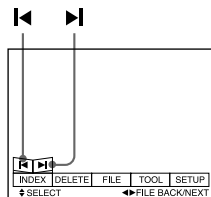

## When the menu bar is not displayed

You can directly select and play back the image with ◀/▶ on the control button.

### Notes

- You might not be able to correctly play back images recorded with this camera on other equipment.
- You cannot play back on this camera images larger than the maximum image size that can be recorded with this camera.

## LCD screen indicators during still image playback

Press DISPLAY to turn on/off the indicators on the LCD screen.  
 See page 64 for a detailed description of the indicators.

# Playing back moving images

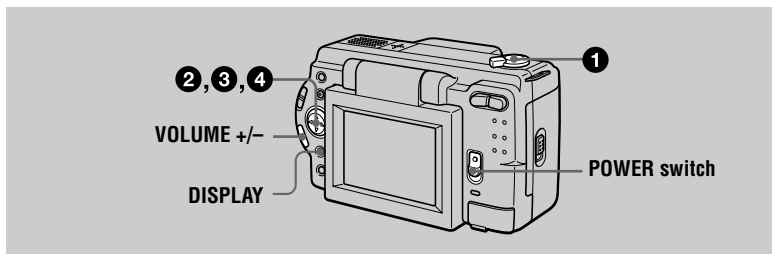

**1 Set the MODE selector to PLAY.**  
The last recorded image (still or moving) appears on the LCD screen.

**2 Press ▲ on the control button to display the menu bar on the LCD screen.**

**3 Select the desired moving image with the control button.**  
Moving images are displayed one-size smaller than still images.  
Press ▲/▼/◀/▶ on the control button to select ◀|▶ on the LCD screen, then press ◀/▶ on the control button.  
◀: To display the preceding image.  
▶: To display the next image.

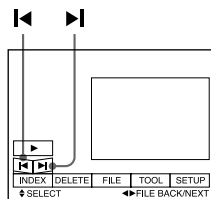

**4 Select ▶ (playback) on the LCD screen with ▲/▼/◀/▶ on the control button, then press the center ●.** ▶ (playback)/|| (pause)  
The moving image and sound\* are played back.  
During playback, ▶ (playback) changes to || (pause).

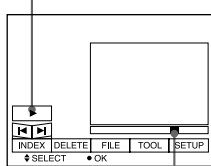

Playback bar

\* You can play back sound in DSC-S50 only.

## To pause playback

Select || (pause) on the LCD screen with ▲/▼/◀/▶ on the control button, then press the center ●.

### **When the menu bar is not displayed**

You can directly select the image with ◀/▶ on the control button, and play back the image and sound (DSC-S50 only) by pressing the center ●. When you press the center ● during playback, playback is paused.

### **Adjusting the volume (DSC-S50 only)**

Press VOLUME +/- to adjust the volume.

### **LCD screen indicators during moving image playback**

Press DISPLAY to turn on/off the indicators on the LCD screen.  
See page 64 for a detailed description of the indicators.

# Viewing images using a personal computer

You can view data recorded with your camera on a personal computer and attach it to e-mail. This section describes the method for installing the USB driver and viewing images on a personal computer. Be sure to also see the operation manuals for your personal computer and application software.

## Note

Data recorded with your camera is stored in the following formats. Make sure that applications that support these file formats are installed on your personal computer.

- Still images (other than TEXT and uncompressed modes): JPEG format
- Moving images/audio: MPEG format
- Uncompressed mode still images: TIFF format
- TEXT mode: GIF format

## Recommended computer environment

### Recommended Windows environment

OS: Microsoft Windows 98, Windows 98SE

Standard installation is required.

Operation is not assured in an environment upgraded from:

Windows 3.1, Windows 95 to Windows 98 or

Windows 98 to Windows 98SE.

CPU: MMX Pentium 200 MHz or faster

The USB connector must be provided as standard.

ActiveMovie Player (DirectShow) must be installed (to play back moving pictures).

### Recommended Macintosh environment

Macintosh computer with the Mac OS 8.5.1/8.6/9.0 standard installation

However, note that the update to Mac OS 9.0 should be used for the following models.

- iMac with the Mac OS 8.6 standard installation and a slot loading type CD-ROM drive
- iBook or G4 with the Mac OS 8.6 standard installation

The USB connector must be provided as standard.

QuickTime 3.2 or newer must be installed (to play back moving pictures).

## Notes

- Operations are not guaranteed for either the Windows or Macintosh environment if you connect two or more USB equipment to a single personal computer at the same time (except for the USB keyboard and mouse which are provided as standard), or when using a hub.
- Depending on the type of USB equipment that is used simultaneously, some equipment may not operate.
- Operations are not guaranteed for all the recommended computer environments mentioned above.



## Installing the USB driver

Before connecting your camera to your personal computer, install the USB driver to the computer. The USB driver is contained together with application software for viewing images on a CD-ROM which is supplied with your camera.

### For Windows 98 users

- 1 Turn on your personal computer and allow Windows 98 to load.
- 2 Insert the supplied CD-ROM in the CD-ROM drive of your personal computer.
- 3 Connect the USB jack on your camera with the USB connector on your personal computer using the supplied USB cable.

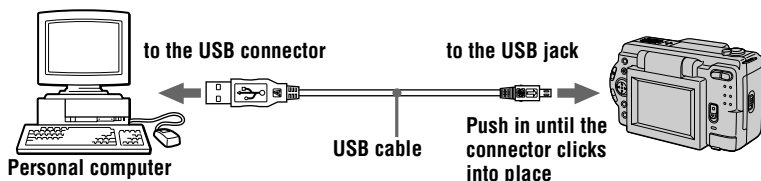

- 4 Insert a “Memory Stick” into your camera, connect the AC power adaptor and turn on your camera.  
“PC MODE” appears on the LCD screen of your camera and the camera is set to communication standby mode. Your personal computer recognizes the camera, and the Windows 98 Add Hardware Wizard starts.
- 5 Follow the on-screen messages to specify the CD-ROM drive and install the USB driver.  
The Add Hardware Wizard starts twice because two different USB drivers are installed. Be sure to allow the installation to complete without interrupting it.

### Note

Be sure to insert a “Memory Stick” into your camera before installing the USB driver. Otherwise, you will be unable to install the USB driver.

### For Macintosh users

- 1 Turn on your personal computer and allow the Mac OS to load.
- 2 Insert the supplied CD-ROM in the CD-ROM drive of your personal computer.

- 3** Double-click the CD-ROM drive icon to open the window.
- 4** Double-click the icon of the hard disk containing the OS to open the window.
- 5** Move the following two files from the window opened in step **3** to the “System Folder” icon in the window opened in step **4** (drag and drop).
  - Sony USB Driver
  - Sony USB Shim
- 6** When “Put these items into the Extensions folder?” appears, click “OK.”
- 7** Restart your personal computer.

## Viewing images

### For Windows 98 users

- 1** Turn on the power of your personal computer and allow Windows 98 to load.
- 2** Connect one end of the USB cable to the USB jack on the camera and the other end to the USB connector on your personal computer.

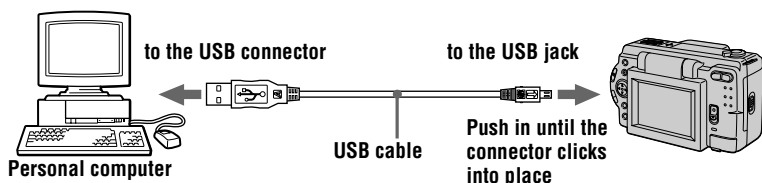

- 3** Insert a “Memory Stick” into your camera, and connect the AC power adaptor to your camera and then to a wall outlet (mains).
- 4** Turn on the power of your camera.  
“PC MODE” appears on the LCD screen of the camera.
- 5** Open “My Computer” on Windows 98 and double click the newly recognized drive. (Example: “Removable Disk (D:)”  
The folders inside the “Memory Stick” are displayed.

## 6 Select and double-click the desired image/sound file from the folder.

For the detailed folder and file name, see “Image file storage destinations and image files” (page 28).

Desired file type	Double-click in this order
Still image	“Dcim” folder → “100msdcf” folder → Image file
Moving image*	“Mssony” folder → “Moml0001” folder → Image file*
Audio*	“Mssony” folder → “Momlv100” folder → Audio file*
E-mail image TIFF image (uncompressed)	“Mssony” folder → “Imcif100” folder → Image file

\* Copying a file to the hard disk of your personal computer before viewing it is recommended. If you play back the file directly from the “Memory Stick”, the image and sound may break off.

## Notes on using your personal computer

### “Memory Stick”

- “Memory Stick” operations on your camera cannot be assured if the “Memory Stick” has been formatted on your personal computer.
- Do not optimize the “Memory Stick” on a Windows machine. This will shorten the “Memory Stick” life.
- Do not compress the data on the “Memory Stick.” Compressed files cannot be played back on your camera.

### Software

- Depending on your application software, the file size may increase when you open a still image file.
- When you load an image modified using the supplied retouch software from your personal computer to the camera or when you directly modify the image on the camera, the image format will differ so the “FILE ERROR” message may appear and you may be unable to open the file.

### Communications with your personal computer

Communications between your camera and your personal computer may not recover after recovering from Suspend, Resume, or Sleep.

- Windows and ActiveMovie, DirectShow are either registered trademarks or trademarks of Microsoft Corporation in the United States and/or other countries.
- Macintosh and Mac OS, QuickTime are trademarks of Apple Computer, Inc.
- All other product names mentioned herein may be the trademarks or registered trademarks of their respective companies. Furthermore, “™” and “®” are not mentioned in each case in this manual.

# Image file storage destinations and image files

Image files recorded with your camera are grouped in folders by recording mode. The meanings of the file names are as follows. □□□□ stands for any number within the range from 0001 to 9999.

## For Windows 98 users (The drive recognizing the camera is “D.”)

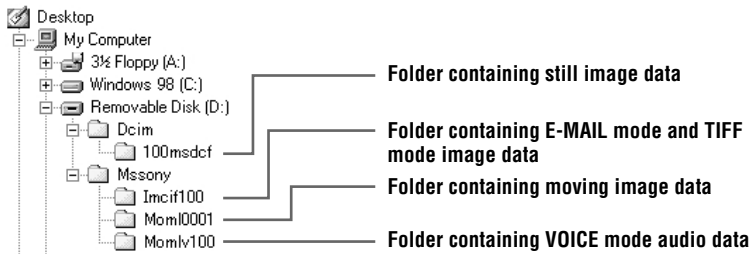

Folder	File	Meaning
100msdcf	DSC0□□□□.JPG	<ul style="list-style-type: none"> <li>• Still image file recorded normally</li> <li>• Still image file recorded in E-MAIL mode (page 38)</li> <li>• Still image file recorded in TIFF mode (page 40)</li> <li>• Still image file recorded in VOICE mode (page 39)</li> </ul>
	TXT0□□□□.GIF	<ul style="list-style-type: none"> <li>• Still image file recorded in TEXT mode (page 39)</li> </ul>
Imcif100	DSC0□□□□.JPG	<ul style="list-style-type: none"> <li>• Small-size image file recorded in E-MAIL mode (page 38)</li> </ul>
	DSC0□□□□.TIF	<ul style="list-style-type: none"> <li>• Uncompressed image file recorded in TIFF mode (page 40)</li> </ul>
Moml0001	MOV0□□□□.MPG	<ul style="list-style-type: none"> <li>• Moving image file recorded normally</li> </ul>
Momlv100	DSC0□□□□.MPG	<ul style="list-style-type: none"> <li>• Audio file recorded in VOICE mode (page 39)</li> </ul>

The numerical portions of the following files are the same.

- A small-size image file recorded in E-MAIL mode and its corresponding image file
- An uncompressed image file recorded in TIFF mode and its corresponding image file
- An audio file recorded in VOICE mode and its corresponding image file

## Before performing advanced operations

This section describes the basic control methods that are frequently used for “Advanced operations”.

### How to use the MODE selector

The MODE selector selects whether you can use your camera to record or to play back and edit images. Set the selector as follows before starting to operate your camera.

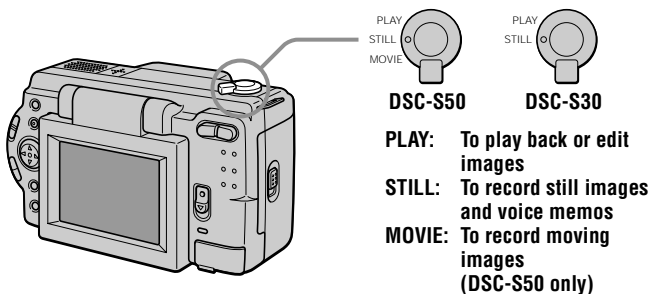

### How to use the control button

The control button is used to select the indicators, images and menus appearing on the LCD screen of your camera. The operation methods that are frequently used for “Advanced operations” are described below.

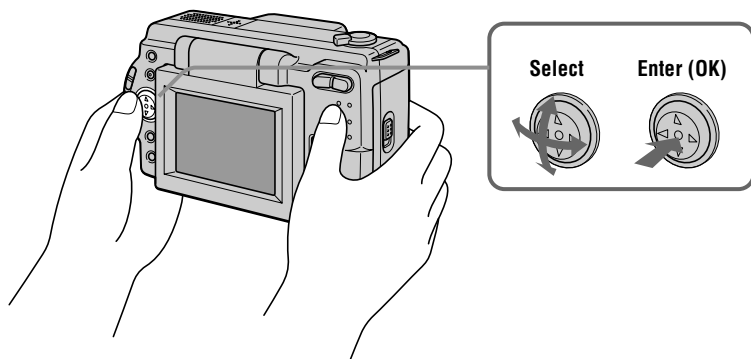

## Turning on/off the operation buttons (menu bar) on the LCD screen

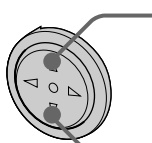

Press **▲** to display the menu bar on the LCD screen.



Press **▼** to clear the menu bar from the LCD screen.

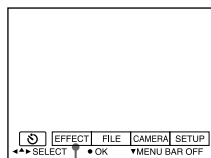

Menu bar

### Note

You cannot clear the menu bar during INDEX screen display (page 45).

## Selecting items and images on the LCD screen

- 1** Press **▲/▼/◀/▶** on the control button to select the item you want to set or the image you want to display.

The color of the selected item or the border of the selected image changes from blue to yellow.

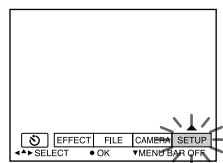

- 2** Press the center **●** to enter the item.

Repeat steps **1** and **2** to execute each function.

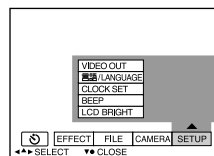

The “Advanced operations” section of this manual refers to selecting and entering items by the above procedure as “Select [(item name)].”

## How to change the menu settings

Some of the advanced operations for your camera are executed by selecting menu items displayed on the LCD screen with the control button.

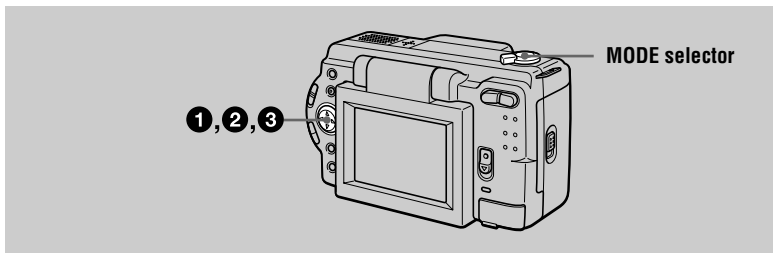

### 1 Press ▲ on the control button to display the menu bar.

The menu bar appears as follows according to the setting of the MODE selector.

#### MOVIE/STILL

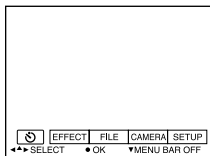

#### PLAY (single mode)

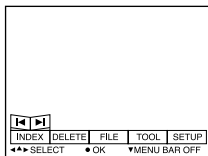

#### PLAY (INDEX mode)

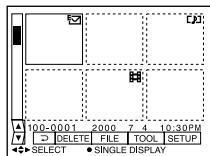

### 2 Select the desired item with ▲/▼/◀/▶ on the control button, then press the center ●.

The color of the selected item changes from blue to yellow, and when you press the center ●, the modes that can be set for that item are displayed.

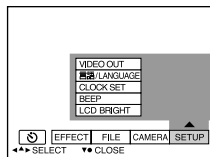

### 3 Select the desired mode with ▲/▼/◀/▶ on the control button, then press the center ●.

#### To clear the menu

Press ▼ on the control button until the LCD screen returns to the menu bar display in step 1. To clear the menu bar, press ▼ again.

## Menu settings

Menu items that can be modified differ depending on the setting of the MODE selector. The LCD screen shows only the items you can operate at the moment. Initial settings are indicated with ■.

### 🕒 (SELF TIMER)

Records with the self-timer (page 18).

### EFFECT

Item	Setting	Description	MODE selector
P.EFFECT	SOLARIZE B&W SEPIA NEG.ART ■ OFF	Sets the image special effects (page 44).	MOVIE STILL
DATE/ TIME	DAY&TIME DATE ■ OFF	Sets whether to insert the date and time into the image (page 44).	STILL

### FILE

Item	Setting	Description	MODE selector
FORMAT	OK	Formats a “Memory Stick.” Note that when formatting is performed, all data recorded on the “Memory Stick” including protected images is erased.	MOVIE STILL PLAY
	CANCEL	Cancels formatting of a “Memory Stick.”	
POS. SENSOR	ON  ■ OFF	Plays back images recorded with the camera on its side (vertical images) as horizontal images. This function does not work for images recorded in TEXT mode.  When this camera may be subject to vibration such as when you record images from inside a moving car, set this to OFF to prevent improper horizontal/vertical judgement.	STILL
FILE NUMBER	SERIES	Assigns numbers to files in sequence even if the “Memory Stick” is changed.	MOVIE STILL
	■ NORMAL	Resets the file numbering each time the “Memory Stick” is changed.	



Item	Setting	Description	MODE selector
IMAGE SIZE	<input checked="" type="checkbox"/> 1600×1200 1600 (3:2) 1024×768 640×480	Selects the image size when recording still images (DSC-S50 only).	STILL
	1472×1104 <input checked="" type="checkbox"/> 1280×960 1280 (3:2) 1024×768 640×480	Selects the image size when recording still images (DSC-S30 only).	STILL
	320×240 <input checked="" type="checkbox"/> 160×112	Selects the MPEG image size when recording moving images (DSC-S50 only).	MOVIE
REC MODE	TIFF  TEXT  VOICE  E-MAIL  <input checked="" type="checkbox"/> NORMAL	Records a TIFF (uncompressed) file in addition to the JPEG file.  Records a GIF file in black-and-white.  Records an audio file (with still image) in addition to the JPEG file (DSC-S50 only).  Records a small-size (320×240) JPEG file in addition to the selected image size.  Records a JPEG file in the selected image size.	STILL
REC TIME SET	15 sec 10 sec <input checked="" type="checkbox"/> 5 sec	Adjusts the recording time for moving images (DSC-S50 only).	MOVIE
ROTATE (in single mode only)	—	Rotates the still image.	PLAY
SLIDE SHOW (in single mode only)	INTERVAL <input checked="" type="checkbox"/> 3 sec/5 sec/10 sec/30 sec/1 min  REPEAT <input checked="" type="checkbox"/> ON/OFF  START  CANCEL	Sets the slide show interval.  Repeats the slide show.  Starts the slide show.  Cancels the slide show settings and execution.	PLAY
PRINT MARK	ON  <input checked="" type="checkbox"/> OFF	Marks the still images to be printed (page 53).  Unmarks the print mark of the still images.	PLAY

Item	Setting	Description	MODE selector
PROTECT	ON	Protects images against accidental erasure (page 49).	PLAY
	■ OFF	Releases protection of images against accidental erasure.	

## CAMERA

Item	Setting	Description	MODE selector
DIGITAL ZOOM	■ ON	Uses digital zoom.	STILL
	OFF	Does not use digital zoom.	
SHARPNESS	+2 to -2	Adjusts the sharpness of the image. <input type="checkbox"/> appears on the LCD screen except when set to 0.	STILL
WHITE BALANCE	IN DOOR OUT DOOR HOLD	Sets the white balance (page 43).	MOVIE STILL
	■ AUTO		
FLASH LEVEL	HIGH	Makes the flash level higher than normal.	STILL
	■ NORMAL	Normal setting.	
	LOW	Makes the flash level lower than normal.	
EXPOSURE	+2.0 EV to -2.0 EV	Adjusts the exposure.	MOVIE STILL

## TOOL

Item	Setting	Description	MODE selector
COPY	OK	Copies an image (page 51).	PLAY
	CANCEL	Cancels copying of the image.	
RESIZE (in single mode only)	1600×1200 1024×768 640×480 ■ CANCEL	Changes the recorded still image size (page 51) (DSC-S50 only).	PLAY
	1472×1104 1280×960 1024×768 640×480 ■ CANCEL	Changes the recorded still image size (page 51) (DSC-S30 only).	

**SETUP**

Item	Setting	Description	MODE selector
DEMO	<input checked="" type="checkbox"/> ON/STBY OFF	Displayed only when you use the AC power adaptor in MOVIE or STILL mode. When ON is selected, a demonstration will start if you do not operate your camera for about 10 minutes. To stop the demonstration, turn off your camera. Select ON to make the demonstration appear again.	MOVIE STILL
VIDEO OUT	NTSC  PAL	Sets the video output signal to NTSC mode (North American countries, Japan, etc.).  Sets the video output signal to PAL mode (European countries, etc.).	MOVIE STILL PLAY
言語/ LANGUAGE	<input checked="" type="checkbox"/> ENGLISH 日本語/JPN	Displays the menu items in English. Displays the menu items in Japanese.	MOVIE STILL PLAY
CLOCK SET	—	Sets the date and time (page 13).	MOVIE STILL PLAY
BEEP	SHUTTER  <input checked="" type="checkbox"/> ON  OFF	Turns off the beep only. (The shutter sound is heard when you press the shutter button.)  Turns on the beep/shutter sound (when you press the control button/shutter button).  Turns off the beep/shutter sound.	MOVIE STILL PLAY
LCD BRIGHT	■■■■●■■■	Adjusts the LCD screen brightness using the +/- buttons on the LCD screen. This has no effect on the recorded images.	MOVIE STILL PLAY

**INDEX\***

Displays six images at a time (PLAY (INDEX) mode) (page 45).

**DELETE**

Setting	Description	MODE selector
OK	Deletes the displayed image.	PLAY
CANCEL	Cancels deleting of the image.	

**▷ (RETURN)\*\***

Returns to PLAY (single) mode.

\* Displayed only in PLAY (single) mode.

\*\* Displayed only in PLAY (INDEX) mode.

## ► Various recording

### Rotating the LCD screen — Face-to-Face recording

You can record images with the lens facing you.

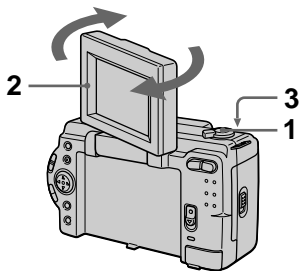

- 1 Set the MODE selector to MOVIE or STILL.**
- 2 Adjust the angle of the LCD screen.**  
Rotate the LCD screen by 180° for Face-to-Face recording.
- 3 Record the image.**  
The image appears on the LCD screen as a mirror image, but the recorded image is the same as the actual subject.

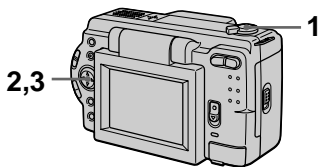

Image appearing on the LCD screen



Recorded image

### Setting the image size (IMAGE SIZE)



- 1 Set the MODE selector to MOVIE or STILL.**  
(MOVIE is for DSC-S50 only)
- 2 Select [FILE] and then [IMAGE SIZE] from the menu.**
- 3 Select the desired image size.**

#### DSC-S50:

##### Still image sizes

1600×1200, 1600 (3:2)\*,  
1024×768, 640×480

\* The image is recorded in 3:2 size to match the printing paper size ratio of 3:2.

##### Moving image sizes

320×240, 160×112

#### DSC-S30:

##### Still image sizes

1472×1104, 1280×960,  
1280 (3:2)\*, 1024×768, 640×480

\* The image is recorded in 3:2 size to match the printing paper size ratio of 3:2.

The number of images or the time that you can record on a “Memory Stick” (4 MB):

Image size	Number of images or time*
1600×1200	Approx. 4
1600 (3:2)	Approx. 4
1472×1104	Approx. 5
1280×960	Approx. 6
1280 (3:2)	Approx. 6
1024×768	Approx. 10
640×480	Approx. 57
320×240	Approx. 42 (15**) sec.
160×112	Approx. 169 (60**) sec.

\* When [REC MODE] is set to [NORMAL].

\*\* Numbers in parentheses indicate the maximum recording time during continuous recording.

## Recording still images for e-mail (E-MAIL)

E-MAIL mode records a small-size (320×240) image at the same time as a still image. Small-size images are convenient for e-mail transmission, etc.

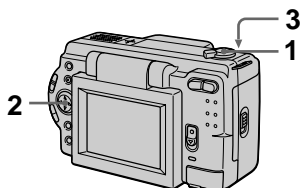

- 1 Set the **MODE** selector to **STILL**.
- 2 Select **[FILE]**, **[REC MODE]**, and then **[E-MAIL]** from the menu.
- 3 Record the image.

The number of images that you can record on a “Memory Stick” (4 MB) in E-MAIL mode.

Image size	Number of images
1600×1200	Approx. 3
1600 (3:2)	Approx. 3
1472×1104	Approx. 4
1280×960	Approx. 5
1280 (3:2)	Approx. 5
1024×768	Approx. 9
640×480	Approx. 46

### To return to normal recording mode

Select [NORMAL] in step 2.

## Adding audio files to still images (VOICE) (DSC-S50 only)

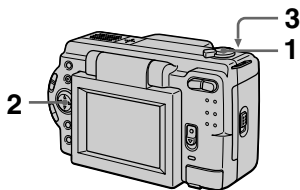

- 1 Set the MODE selector to STILL.
- 2 Select [FILE], [REC MODE], and then [VOICE] from the menu.
- 3 Record the image.

If you press and release the shutter button, sound is recorded for 5 seconds.

If you hold down the shutter button, sound is recorded until you release the shutter button for up to 40 seconds.

**The number of images that you can record on a “Memory Stick” (4 MB) in VOICE mode (when recording sound for five seconds):**

Image size	Number of images
1600×1200	Approx. 3
1600 (3:2)	Approx. 3
1024×768	Approx. 8
640×480	Approx. 28

### To return to normal recording mode

Select [NORMAL] in step 2.

### When using the DSC-S30

The DSC-S30 does not have a VOICE function. When you edit (delete, protect, or copy files, etc.) files recorded in VOICE mode on a different camera, the still image file is edited but the audio file is not.

## Recording text documents (TEXT)

Text is recorded in black and white GIF format to provide a clearer image.

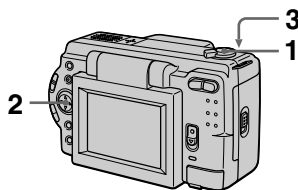

- 1 Set the MODE selector to STILL.
- 2 Select [FILE], [REC MODE], and then [TEXT] from the menu.
- 3 Record the image.

**The number of images that you can record on a “Memory Stick” (4 MB) in TEXT mode:**

Image size	Number of images
1600×1200	Approx. 12 to 87
1600 (3:2)	Approx. 14 to 97
1472×1104	Approx. 14 to 97
1280×960	Approx. 20 to 114
1280 (3:2)	Approx. 22 to 137
1024×768	Approx. 30 to 160
640×480	Approx. 80 to 363

### To return to normal recording mode

Select [NORMAL] in step 2.

### Notes

- If the subject is not evenly illuminated, you may be unable to record a clear image.
- Writing and reading data takes more time than in normal recording.

## Recording uncompressed images (TIFF)

This mode simultaneously records still images in both TIFF format (uncompressed) and JPEG format (compressed).

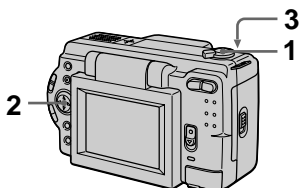

- 1 Set the MODE selector to STILL.
- 2 Select [FILE], [REC MODE], and then [TIFF] from the menu.
- 3 Record the image.

The number of images that you can record on a “Memory Stick” (16 MB) in TIFF mode:

Image size	Number of images
1600×1200	Approx. 2
1600 (3:2)	Approx. 2
1280×960	Approx. 3
1280 (3:2)	Approx. 3

### To return to normal recording mode

Select [NORMAL] in step 2.

### Notes

- JPEG images are recorded in the image size selected by the [IMAGE SIZE] menu. TIFF images are recorded in [1600×1200] size in DSC-S50, and [1280×960] size in DSC-S30 other than when [1600 (3:2)] or [1280 (3:2)] is selected.
- Writing data takes more time than in normal recording.
- The supplied “Memory Stick” (4 MB) does not have sufficient capacity to record uncompressed images.



## Recording images in macro



- 1 Set the **MODE** selector to **MOVIE** or **STILL**.
- 2 Press **FOCUS** repeatedly until the  (auto macro) indicator appears on the LCD screen.

You can record a subject as close as about 1 3/16 inches (3 cm) from the lens surface with the zoom set all the way to the W side.

### To return to normal recording mode

Press **FOCUS** repeatedly until  disappears from the LCD screen.



#### Notes

- You cannot record images in macro with the following PROGRAM AE modes.
  - Landscape mode
  - Panfocus mode
- You cannot record images in macro when  appears on the LCD screen.

## Setting the distance to the subject

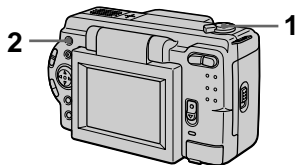
Normally the focus is automatically adjusted. This function is useful when the auto focus does not work well such as in dark places.



- 1 Set the **MODE** selector to **MOVIE** or **STILL**.
- 2 Press **FOCUS** repeatedly to achieve a sharp focus.  
The  (manual focus) indicator appears on the LCD screen. You can select from the following 7 focus settings: auto (no indicator), , 1 3/4 feet (0.5m), 3 1/4 feet (1.0m), 9 3/4 feet (3.0m), 23 feet (7.0m), ∞ (infinite)

### To reactivate auto focusing

Press **FOCUS** repeatedly until the indicator disappears in step 2.

#### Note

These setting distances are approximate, and should be used as a reference.

## Using the PROGRAM AE function

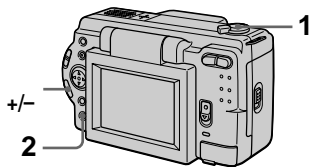

- 1 Set the MODE selector to MOVIE or STILL.
- 2 Press PROGRAM AE repeatedly to select the desired PROGRAM AE mode.

### Aperture priority mode

Makes the subject stand out against an unclear background or makes both the subject and the background stand out clearly. Press +/- repeatedly to select an aperture value in 9 steps from F2.8 to F11.

### Shutter speed priority mode

Records a sharp picture of a fast-moving subject or the flow of motion of a moving subject. Press +/- repeatedly to select a shutter speed in 18 steps from 8" to 1/725 when recording a still image and in 12 steps from 1/8 to 1/725 when recording a moving image.

### Twilight mode

Suppresses the washed-out color of a bright subject in a dark place so that you can record the subject without losing the dark atmosphere of the surroundings.

### Twilight plus mode

Increases the effectiveness of the twilight mode function.

### Landscape mode

Focuses only on a distant subject to record landscapes, etc.

### Panfocus mode

Changes the focus quickly and simply from a close subject to a distant subject.

### Spot light-metering mode

Select this mode when there is backlight or when there is strong contrast between the subject and the background, etc. Position the point you want to record on the spot light-metering cross hair.

#### LCD screen

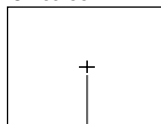

Spot light-metering cross hair

### To cancel PROGRAM AE

Press PROGRAM AE repeatedly until the indicator on the LCD screen goes out.

#### Notes

- You cannot select F2.8 in aperture priority mode, and the indication may differ from the actual aperture value when the zoom is set to the T side.
- You can focus only on distant subjects in Landscape mode.
- In Panfocus mode, the zoom position and focus are fixed.
- When you record in the Twilight plus mode, we recommend that you use a tripod to prevent shaking.
- Set the forced flash  when you use the flash in the following modes:
  - Twilight mode
  - Twilight plus mode
  - Landscape mode
- You cannot use the PROGRAM AE function when [REC MODE] is set to [TEXT].
- If the setting is not appropriate in aperture priority mode and shutter priority mode, the setting value indicator on the LCD screen flashes when you press the shutter button. In this case, reset the value.
- If you set a slow shutter speed in twilight plus mode and shutter speed priority mode, the noise may increase.

## Adjusting the exposure (EXPOSURE)

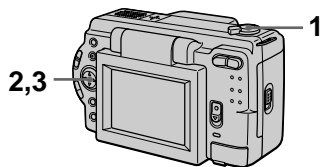

- 1 Set the **MODE** selector to **MOVIE** or **STILL**.
- 2 Select **[CAMERA]** and then **[EXPOSURE]** from the menu.
- 3 Select the desired exposure value.

Adjust the exposure value while checking the brightness of the background. You can select values ranging from +2.0 EV to -2.0 EV in steps of 1/3 EV.

### Note

The exposure may not be adjusted properly when the subject is extremely bright or dark, or when using the flash.

## Adjusting the white balance (WHITE BALANCE)

Normally the white balance is automatically adjusted.

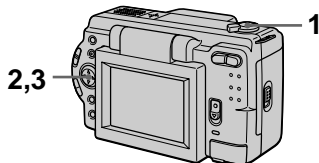

- 1 Set the **MODE** selector to **MOVIE** or **STILL**.
- 2 Select **[CAMERA]** and then **[WHITE BALANCE]** from the menu.
- 3 Select the desired white balance setting.

### IN DOOR (☀️)

- Places where the lighting condition changes quickly
- Under bright lighting such as photography studios
- Under sodium or mercury lamps

### OUT DOOR (🌅)

Recording a sunrise/sunset, night scene, neon signs, or fireworks

### HOLD

Recording a single-colored subject or background

### AUTO (No indicator)

Adjusts the white balance automatically

## To reactivate auto adjustment

Select **[AUTO]** in step 3.

### Note

Select **[AUTO]** when recording under fluorescent lighting.

## Recording the date and time on the still image (DATE/TIME)

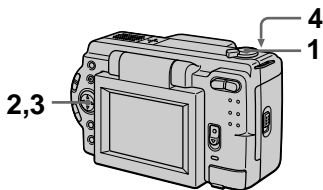

- 1 Set the MODE selector to STILL.
- 2 Select [EFFECT] and then [DATE/TIME] from the menu.
- 3 Select the date and time setting.

### DAY&TIME

The date, hour and minutes are imposed onto the image.

### DATE

The year, month and day are imposed onto the image.

### OFF

The date and time are not imposed onto the image.

- 4 Record the image.

The date and time are not displayed during recording. The date and time are displayed when playing back images.



## Enjoying picture effects (P.EFFECT)

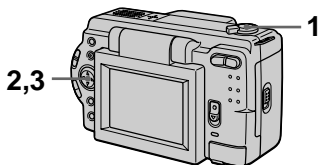

- 1 Set the MODE selector to MOVIE or STILL.
- 2 Select [EFFECT] and then [P.EFFECT] from the menu.
- 3 Select the desired mode.

### SOLARIZE

The light contrast is clearer and the picture looks like an illustration.

### B&W

The picture is monochrome (black and white).

### SEPIA

The picture is colored like an old picture.

### NEG.ART

The color and brightness of the picture are reversed.

### To cancel picture effect

Select [OFF] in step 3.

## ► Various playback

### Playing back six images at once (INDEX)

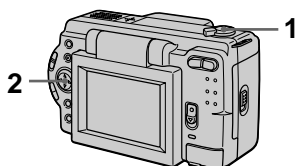

**1** Set the MODE selector to PLAY.

**2** Select [INDEX] on the LCD screen.

Six images are displayed at once (index screen).

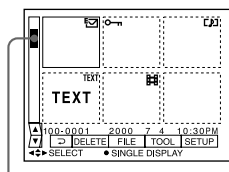

This shows the position of the currently displayed images relative to all the recorded images.

The following marks are displayed on each image according to the image type and settings.

: Moving image file

: Voice memo file

: E-mail file

: Print mark

: Protect mark

TEXT: Text mark

TIFF: TIFF mark

(No mark): Normal recording (no settings)

### To display the next (previous) index screen

Select ▲/▼ at the lower left of the LCD screen.

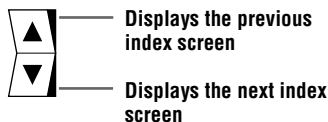

### To return to normal playback (single image)

- Select the desired image with the control button.
- Select [↵] (RETURN).

#### Note

You cannot display images recorded in TEXT mode on the INDEX screen.

## Enlarging a part of the still image (Zoom and trimming)

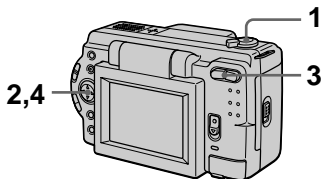

- 1 Set the MODE selector to PLAY.**
- 2 Display the image to be enlarged.**
- 3 Zoom in/out the image with the zoom button.**

The zoom scaling indicator appears on the LCD screen.
- 4 Press the control button repeatedly to select the desired part of the image.**
  - ▲: The image moves downward
  - ▼: The image moves upward
  - ◀: The image moves rightward
  - ▶: The image moves leftward

### To return to the normal size

Zoom in with the zoom button until the zoom scaling indicator ( $\text{Q} \times 1.1$ ) disappears from the screen, or simply press **●**.

### To record an enlarged image (trimming)

- ① Enlarge the image.
- ② Press the shutter button. The image is recorded at 640×480 size, then the display returns to the image display before enlargement.

### Notes

- You cannot trim images recorded in TEXT mode or uncompressed images.
- The maximum zoom magnification is 5× the original image, regardless of the image size.
- The picture quality of trimmed images may deteriorate.
- The original picture remains even after trimming.
- The trimmed image is recorded as the newest file.

## Rotating a still image (ROTATE)

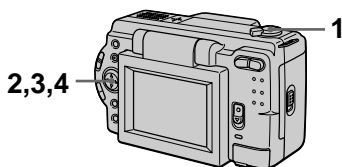

- 1 Set the MODE selector to **PLAY**.
- 2 Display the image to rotate.
- 3 Select **[FILE]** and then **[ROTATE]** from the menu.
- 4 Rotate the image clockwise ↻ or counterclockwise ↶, then select **[RETURN]**.

### Notes

- You may not be able to rotate protected images or images recorded with other equipment.
- Also, when viewing images on a personal computer, the image rotation information may not be reflected depending on the application software.
- You cannot rotate protected or uncompressed images, or images recorded in **TEXT** mode.

## Playing back the images in order (SLIDE SHOW)

This function is useful for checking the recorded images or for presentations, etc.

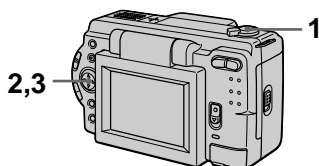

- 1 Set the MODE selector to **PLAY**.
- 2 Select **[FILE]** and then **[SLIDE SHOW]** from the menu.  
Set the following items.

### INTERVAL

1 min (one minute), 30 sec (30 seconds), 10 sec (10 seconds), 5 sec (5 seconds), 3 sec (3 seconds)

### REPEAT

**ON:** Plays back images in a continuous loop until **[RETURN]** is selected.  
**OFF:** After all images have been played back, the slide show ends.

- 3 Select **[START]** with the control button.  
The slide show begins.

### To cancel the slide show

Select **[CANCEL]** in step 2 or 3.

### To skip to the next/previous image during slide show playback

Select **[◀/▶]** at the lower left of the LCD screen.

### Note

The [INTERVAL] setting time is approximate, and may vary depending on the played back image size or other factors.

## Viewing images on a TV screen

Before connecting your camera, be sure to turn off the TV. After connecting A/V connecting cable (DSC-S50) or VIDEO connecting cable (DSC-S30), turn on the TV.

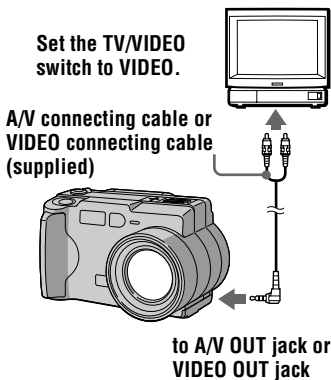

### 1 Connect your camera and the TV.

#### DSC-S50

Connect the A/V connecting cable to the A/V OUT jack of your camera and to the audio/video input jacks of the TV.

If your TV has stereo type audio input jacks, connect the audio plug of the A/V connecting cable to the Lch jack.

#### DSC-S30

Connect the video cable to the VIDEO OUT jack of your camera and to the video input jack of the TV.

### 2 Turn on the TV, then start playback on your camera.

The playback image appears on the TV screen.

### Note

You cannot use a TV that has an antenna (aerial) connector only.



## ► Editing

### Preventing accidental erasure (PROTECT)

The  (protect) indicator appears on protected images.

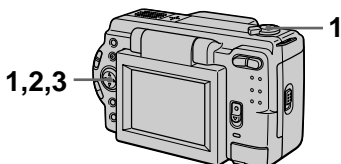

#### In single mode

- 1 Set the MODE selector to **PLAY**, then display the image to protect.
- 2 Select **[FILE]**, **[PROTECT]**, and then **[ON]** from the menu. The displayed image is protected and  appears.

#### To release protection

Select **[OFF]** in step 2.

#### In INDEX mode

- 1 Set the MODE selector to **PLAY**, then display the **INDEX** screen.
- 2 Select **[FILE]**, **[PROTECT]**, and then **[ALL]** or **[SELECT]** from the menu.
- 3 When you select **[ALL]**  
Select **[ON]**.  
All the images recorded in “Memory Stick” are protected.

#### When you select **[SELECT]**

Select all the images to protect with the control button, then select **[ENTER]**.

The selected images are protected.

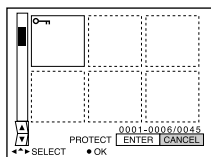

#### To release protection

If you selected **[ALL]** in step 2, select **[OFF]**. If you selected **[SELECT]** in step 2, select the images to unprotect with the control button, then select **[ENTER]**.

## Deleting images (DELETE)

You cannot delete protected files.

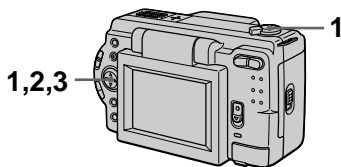

### In single mode

- 1 Set the MODE selector to PLAY, then display the image to delete.**
- 2 Select [DELETE] and then [OK] from the menu.**  
The image is deleted.

### In INDEX mode

- 1 Set the MODE selector to PLAY, then display the INDEX screen.**
- 2 Select [DELETE] and then [ALL] or [SELECT] from the menu.**
- 3 When you select [ALL]**  
Select [ENTER].  
All unprotected images are deleted.

#### When you select [SELECT]

Select all the images to delete with the control button, then select [ENTER].

The  (delete) indicator appears on the selected images and these images are deleted.

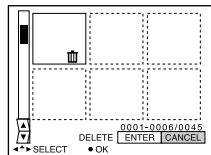

### To cancel deleting

Select [CANCEL] in step **2** or **3**.

#### Note

If there are files on the “Memory Stick” with names having the same last 4 digits as the file name of the image to be deleted, these files are also deleted at the same time.

## Changing the recorded still image size (RESIZE)

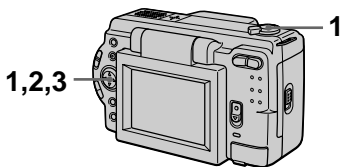

- 1 Set the **MODE** selector to **PLAY** and display the image to resize.
- 2 Select [**TOOL**] and then [**RESIZE**] from the menu.
- 3 Select the desired image size.

### DSC-S50

1600×1200, 1024×768, 640×480

### DSC-S30

1472×1104, 1280×960, 1024×768,  
640×480

The changed image is recorded, then the display returns to the image display before resizing.

### To return to the original size

Select [**CANCEL**] in step 3.

### Notes

- You cannot change the size of images recorded in **TEXT** mode or uncompressed images.
- When you change from a small size to a large size, the picture quality deteriorates.
- The original image is retained even after resizing.
- The resized image is recorded as the newest file.

## Copying images (COPY)

You can copy images to another “Memory Stick.”

### In single mode

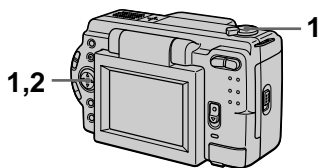

- 1 Set the **MODE** selector to **PLAY**, then display the image to copy.
- 2 Select [**TOOL**], [**COPY**], and then [**OK**] from the menu. “FILE ACCESS” appears.
- 3 When “**CHANGE MEMORY STICK**” appears, eject the “**Memory Stick**.” “INSERT MEMORY STICK” appears.
- 4 Insert the “**Memory Stick**” on which to copy the image. “**RECORDING**” appears. When copying is completed, “**COMPLETE**” appears. To end copying, select [**EXIT**].

### To copy the image to another “Memory Stick”

Select [**CONTINUE**] and repeat steps 3 and 4.

## In INDEX mode

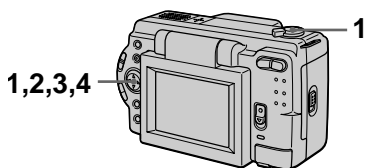

- 1 Set the MODE selector to PLAY, then display the INDEX screen.**
- 2 Select [TOOL], [COPY], and then [SELECT] from the menu.**
- 3 Select the image to copy.**  
The ✓ (select) indicator appears on the image.
- 4 Select [ENTER].**  
“MEMORY STICK ACCESS” appears.
- 5 When “CHANGE MEMORY STICK” is displayed, eject the “Memory Stick.”**  
“INSERT MEMORY STICK” appears.
- 6 Insert another “Memory Stick.”**  
“RECORDING” appears. When copying is completed, “COMPLETE” appears.  
To end copying, select [EXIT].

### To copy the image to another “Memory Stick”

Select [CONTINUE] and repeat steps 5 and 6.

### To cancel copying part-way

Change the MODE selector setting or turn off the power.

### Notes

- You cannot copy uncompressed images.
- You cannot copy images that are bigger than 1.4 MB at once. If “NOT ENOUGH MEMORY” appears or ✓ flashes on the INDEX screen, cancel some images to copy and try again.
- After “COMPLETE” appears, if you exchange the “Memory Stick” without selecting “EXIT,” the same image is copied again.

## Selecting still images to print (PRINT MARK)

You can mark a print mark on still images recorded with your camera. This mark is convenient when you have images printed at a shop that conforms with the DPOF (Digital Print Order Format) standard.

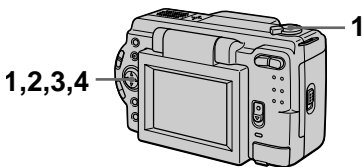

### In single mode

- 1 Set the **MODE** selector to **PLAY** and display the image you want to print.
- 2 Select **[FILE]**, **[PRINT MARK]**, and then **[ON]** from the menu. The  (print) mark is displayed on the image.

### To unmark the print mark

Select **[OFF]** in step 2.

### In INDEX mode

- 1 Set the **MODE** selector to **PLAY**, then display the **INDEX** screen.
- 2 Select **[FILE]**, **[PRINT MARK]**, and then **[SELECT]** from the menu.
- 3 Select the images to mark with the control button.

## 4 Select **[ENTER]**.

 of the selected images change from green to white.

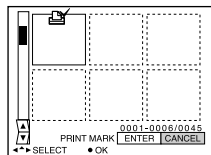

## To unmark selected print marks

Select the images to unmark in step 3 with the control button, then select **[ENTER]**.

## To unmark all the print marks

Select **[FILE]**, **[PRINT MARK]**, **[ALL]** and then **[OFF]** from the menu.  of all images are unmarked.

### Notes

- You cannot mark moving images or images recorded in **TEXT** mode.
- If you mark an image recorded in **TIFF** mode with a print mark, only the uncompressed image is printed, and the **JPEG** image recorded at the same time is not printed.

### Precautions

#### On cleaning

##### Cleaning the LCD screen

Wipe the screen surface with a cleaning cloth (not supplied) or a LCD cleaning kit (not supplied) to remove fingerprints, dust, etc.

##### Cleaning the camera surface

Clean the camera surface with a soft cloth slightly moistened with water, then wipe the surface dry. Do not use any type of solvent such as thinner, alcohol or benzene as this may damage the finish or the casing.

##### After using your camera at the seashore or other dusty locations

Clean your camera carefully. Otherwise, the salty air may corrode the metal fittings or dust may enter the inside of your camera, causing a malfunction.

#### Note on operating temperature

Your camera is designed for use between the temperatures of 32°F and 104°F (0°C and 40°C). Recording in extremely cold or hot places that exceed this range is not recommended.

#### On moisture condensation

If the camera is brought directly from a cold to a warm location, or is placed in a very damp room, moisture may condense inside or outside the camera. Should this occur, the camera will not operate properly.

##### Moisture condensation occurs easily when:

- The camera is brought from a cold location such as a ski slope into a warmly heated room.
- The camera is taken from an air-conditioned room or car interior to the hot outdoors, etc.

#### How to prevent moisture condensation

When bringing the camera from a cold place to a warm place, seal the camera in a plastic bag and allow it to adapt to conditions at the new location over a period of time (about an hour).

##### If moisture condensation occurs

Turn off the camera and wait about an hour for the moisture to evaporate. Note that if you attempt to record with moisture remaining inside the lens, you will be unable to record clear images.

#### On AC power adaptor

- Unplug the unit from the wall outlet (mains) when you are not using the unit for a long time.
- To disconnect the power cord (mains lead), pull it out by the plug. Never pull the power cord (mains lead) itself.
- Do not operate the unit with a damaged cord or if the unit has been dropped or damaged.
- Do not bend the power cord (mains lead) forcibly, or place a heavy object on it. This will damage the cord and may cause fire or electrical shock.
- Prevent metallic objects from coming into contact with the metal parts of the connecting section. If this happens, a short may occur and the unit may be damaged.
- Always keep metal contacts clean.
- Do not disassemble the unit.
- Do not apply mechanical shock or drop the unit.
- While the unit is in use, particularly during charging, keep it away from AM receivers and video equipment. AM reception and video operation are disturbed.
- The unit becomes warm during use. This is not a malfunction.
- Do not place the unit in locations that are:
  - Extremely hot or cold
  - Dusty or dirty
  - Very humid
  - Vibrating

## On battery pack

- Use only the specified charger with the charging function.
- To prevent accident from a short circuit, do not allow metal objects to come into contact with the battery terminals.
- Keep the battery pack away from fire.
- Never expose the battery pack to temperatures above 140°F (60°C), such as in a car parked in the sun or under direct sunlight.
- Keep the battery pack dry.
- Do not expose the battery pack to any mechanical shock.
- Do not disassemble nor modify the battery pack.
- Install the battery pack to the camera securely.
- Charging while some capacity remains does not affect the original battery capacity.

If any problem occurs, unplug your camera and contact your nearest Sony dealer.

## On internal rechargeable button battery

This camera has an internal rechargeable button battery for maintaining the date and time and other settings regardless of whether the power is on or off. This rechargeable button battery is constantly charged as long as you are using the camera. However, if you use the camera for only short periods it discharges gradually, and if you do not use the camera at all for about half a year it becomes completely discharged. In this case, be sure to charge this rechargeable button battery before using the camera. However, even if this rechargeable button battery is not charged, you can still use the camera as long as you do not record the date and time.

### Charging method

Connect the camera to a wall outlet (mains) with the AC power adaptor, or install a charged battery pack, and leave the camera for 24 hours or more with the POWER switch set to OFF.

## On “Memory Sticks”

“Memory Stick” is a new compact, portable and versatile IC recording medium with a data capacity that exceeds a floppy disk. “Memory Stick” is specially designed for exchanging and sharing digital data among “Memory Stick” compatible products. Because it is removable, “Memory Stick” can also be used for external data storage.

There are two types of “Memory Sticks”: general “Memory Sticks” and “MagicGate Memory Sticks” that are equipped with the MagicGate\* copyright protection technology.

You can use both types of “Memory Stick” with your camera. However, because your camera does not support the MagicGate standards, data recorded with your camera is not subject to MagicGate copyright protection.

\* MagicGate is copyright protection technology that uses encryption technology.

### Notes

- Do not remove the “Memory Stick” while reading or writing data.
- Data may be damaged if:
  - you remove the “Memory Stick” or turn off your camera while reading or writing data.
  - you use the “Memory Stick” in a location subject to the effects of static electricity or noise.
- Do not attach any other material than the supplied label on the labeling position.
- Attach the label so that it does not stick out from the proper attachment location.
- When you carry or store the “Memory Stick,” put it in its supplied case.
- Do not touch the terminals of a “Memory Stick” with your hand or a metal object.
- Do not strike, bend or drop the “Memory Stick.”
- Do not disassemble or modify the “Memory Stick.”
- Do not allow the “Memory Stick” to get wet.

“Memory Stick”,  “MagicGate Memory Stick” and  are trademarks of Sony Corporation.

“MagicGate” and **MAGICGATE** are trademarks of Sony Corporation.

---

## Using your camera abroad

### Power sources

You can use your camera in any country or area with the supplied battery charger within 100 V to 240 V AC, 50/60 Hz. Use a commercially available AC plug adaptor **[a]**, if necessary, depending on the design of the wall outlet (mains) **[b]**.

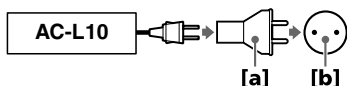

### Watching the playback picture on TV

If you want to view the playback picture on a TV, you need a TV having a video input jack and a video connecting cable.

The color system of the TV must be the same as that of your digital still camera. Check the following list:

#### NTSC system

Bahama Islands, Bolivia, Canada, Central America, Chile, Columbia, Ecuador, Jamaica, Japan, Korea, Mexico, Peru, Surinam, Taiwan, the Philippines, the U.S.A., Venezuela, etc.

#### PAL system

Australia, Austria, Belgium, China, Denmark, Finland, Germany, Great Britain, Holland, Hong Kong, Italy, Kuwait, Malaysia, New Zealand, Norway, Portugal, Singapore, Spain, Sweden, Switzerland, Thailand, etc.

#### PAL-M system

Brazil

#### PAL-N system

Argentina, Paraguay, Uruguay

#### SECAM system





Bulgaria, Czech Republic, France, Guiana, Hungary, Iran, Iraq, Monaco, Poland, Russia, Slovak Republic, Ukraine, etc.



## Troubleshooting

If you experience trouble with your camera, first check the following items. Should your camera still not operate properly after you have made these checks, consult your Sony dealer or local authorized Sony service facility. If code displays (C:□□:□□) appear on the LCD screen, the self-diagnosis display function is working (page 62).

Symptom	Cause and/or Solution
Your camera does not work.	<ul style="list-style-type: none"><li>• You are not using an “InfoLITHIUM” battery pack. → Use an “InfoLITHIUM” battery pack (page 8).</li><li>• The battery level is low (the <math>\text{⏻}</math> indicator appears on the LCD screen). → Charge the battery pack (page 9).</li><li>• The AC power adaptor is not connected securely. → Connect it firmly to the DC IN jack of your camera and a wall outlet (mains) (page 12).</li><li>• The built-in microcomputer is not working properly. → Disconnect and then reconnect all power sources after one minute. Then turn the power on by sliding the POWER switch down and check that the camera works properly.</li></ul>
Your camera cannot record images.	<ul style="list-style-type: none"><li>• The MODE selector is set to PLAY. → Set it to MOVIE or STILL (pages 16, 20).</li><li>• No “Memory Stick” has been inserted into your camera. → Insert a “Memory Stick” (page 15).</li><li>• The write-protect tab on the “Memory Stick” is set to LOCK. → Set it to the recording position.</li></ul>
The picture is out of focus.	<ul style="list-style-type: none"><li>• Your camera is not in macro recording mode when you shoot a subject that is about 1 3/16 to 9 7/8 inches (3 to 25 cm) away from the lens. → Set the macro recording mode (page 41). → Press the zoom button to set to the W side.</li></ul>
The resizing function does not work.	<ul style="list-style-type: none"><li>• You cannot resize moving images and text images.</li></ul>
You cannot display a print mark.	<ul style="list-style-type: none"><li>• You cannot display print marks on moving images and text images.</li></ul>
The picture is noisy.	<ul style="list-style-type: none"><li>• Your camera is placed near a TV or other equipment that uses strong magnets. → Move your camera away from the TV, etc.</li></ul>



Symptom	Cause and/or Solution
The picture is too dark.	<ul style="list-style-type: none"> <li>You are shooting a subject with a light source behind the subject.               <ul style="list-style-type: none"> <li>→ Adjust the exposure (page 43).</li> <li>→ Adjust the brightness of the LCD screen (page 35).</li> </ul> </li> </ul>
The flash does not work.	<ul style="list-style-type: none"> <li>The flash is set to .               <ul style="list-style-type: none"> <li>→ Set the flash to auto (no indicator),  or  (page 19).</li> </ul> </li> <li>PROGRAM AE is set to the Twilight, Twilight plus, or Panfocus mode.               <ul style="list-style-type: none"> <li>→ Cancel the mode (page 42) or set the flash to .</li> </ul> </li> <li>The MODE selector is set to MOVIE (DSC-S50 only).               <ul style="list-style-type: none"> <li>→ Set it to STILL.</li> </ul> </li> </ul>
The date and time are recorded incorrectly.	<ul style="list-style-type: none"> <li>The date and time are not set correctly.               <ul style="list-style-type: none"> <li>→ Set the correct date and time (page 13).</li> </ul> </li> </ul>
Vertical streaks appear when you are shooting a very bright subject.	<ul style="list-style-type: none"> <li>The smear phenomenon is happening.               <ul style="list-style-type: none"> <li>→ This is not a malfunction.</li> </ul> </li> </ul>
The battery life is short.	<ul style="list-style-type: none"> <li>You are recording/playing back images under extremely cold temperatures.</li> <li>The battery pack is not charged enough.               <ul style="list-style-type: none"> <li>→ Charge the battery pack fully.</li> </ul> </li> <li>The battery pack is dead.               <ul style="list-style-type: none"> <li>→ Replace the battery pack with a new one.</li> </ul> </li> </ul>
The battery remaining indicator is incorrect.	<ul style="list-style-type: none"> <li>You have used the camera for a long time in an extremely hot or an extremely cold location.</li> <li>The battery pack is dead.               <ul style="list-style-type: none"> <li>→ Replace the battery pack with a new one (page 8).</li> </ul> </li> <li>The battery pack is discharged.               <ul style="list-style-type: none"> <li>→ Install a charged battery pack (pages 8, 9).</li> </ul> </li> </ul>
Sufficient battery remaining indicator is displayed but the power runs out soon.	<ul style="list-style-type: none"> <li>→ Fully charge the battery pack (page 9).</li> </ul>
The zoom does not work.	<ul style="list-style-type: none"> <li>PROGRAM AE is set to the Panfocus mode.               <ul style="list-style-type: none"> <li>→ Cancel the Panfocus mode (page 42).</li> </ul> </li> </ul>
Digital zoom does not function.	<ul style="list-style-type: none"> <li>You cannot use digital zoom to record moving pictures.</li> </ul>

Symptom	Cause and/or Solution
Your camera cannot play back images.	<ul style="list-style-type: none"> <li>The MODE selector is set to STILL or MOVIE. → Set it to PLAY (page 21).</li> </ul>
The image and sound are interfered by noise when you play back an image on a personal computer.	<ul style="list-style-type: none"> <li>You are playing back the file directly from the "Memory Stick." → Copy the file to the hard disk of the personal computer and then play back the file from the hard disk (page 27).</li> </ul>
The image cannot be played back on a personal computer.	→ Consult the personal computer or software manufacturer.
Your camera cannot delete an image.	<ul style="list-style-type: none"> <li>The image is protected. → Cancel the protection (page 49).</li> </ul>
The power turns off suddenly.	<ul style="list-style-type: none"> <li>With the MODE selector set to STILL or MOVIE, if you do not operate the camera for about three minutes while the power is on, the camera turns off automatically to prevent wearing down the battery. → Turn on the camera.</li> <li>The battery is discharged. → Replace it with a charged battery.</li> </ul>
The image does not appear on the TV screen.	<ul style="list-style-type: none"> <li>The video output signal setting of your camera is incorrect. → Change the setting (page 48).</li> </ul>
A file error occurs when you play back a file.	<ul style="list-style-type: none"> <li>The image size is larger than 1600×1200. → Use an image size of 1600×1200 or smaller.</li> </ul>
The PROGRAM AE function does not work.	<ul style="list-style-type: none"> <li>The camera is set to TEXT mode. → Cancel TEXT mode (page 42).</li> </ul>
The LCD screen freezes momentarily.	<ul style="list-style-type: none"> <li>This is a characteristic of the system and is not a malfunction.</li> </ul>
The picture is monochrome (black and white).	<ul style="list-style-type: none"> <li>The camera is set to TEXT mode. → Cancel TEXT mode (page 39).</li> <li>PEFFECT is set to B&amp;W mode. → Cancel B&amp;W mode (page 44).</li> </ul>

Symptom	Cause and/or Solution
<p>Your personal computer does not recognize your camera.</p>	<ul style="list-style-type: none"> <li>• The camera is turned off. → Turn on the camera.</li> <li>• The battery level is low. → Use the AC power adaptor (page 12).</li> <li>• The USB cable is not connected firmly. → Disconnect the USB cable, and connect it again firmly. Make sure that “PC MODE” is displayed on the LCD screen (page 26).</li> <li>• The USB connectors on your personal computer are connected to other equipment besides the keyboard, the mouse, and your camera. → Disconnect the USB cables except for the ones connected to the keyboard, the mouse, and your camera (page 24).</li> </ul>

## Warning and notice messages

Various messages appear on the LCD screen. Check the corresponding descriptions in the following list.

Message	Meaning
NO MEMORY STICK	No “Memory Stick” has been inserted.
SYSTEM ERROR	Turn the power off and on again.
MEMORY STICK ERROR	The inserted “Memory Stick” cannot be used with your camera, or is damaged.
FORMAT ERROR	Failed to format the “Memory Stick.”
MEMORY STICK LOCKED	The write-protect tab on the “Memory Stick” is set to the LOCK position.
NO MEMORY SPACE	The capacity of the “Memory Stick” is full, and you cannot record or copy images.
NO FILE	No image has been recorded on the “Memory Stick.”
FILE ERROR	An error occurred while playing back the image.
FILE PROTECT	The image is protected against erasure.
for “InfoLITHIUM” battery only	The battery is not the “InfoLITHIUM” type.
NOT ENOUGH MEMORY	The images you want to copy are too big to copy with your camera.
DIRECTORY ERROR	A directory with the same name already exists.
IMAGE SIZE OVER	You are playing back an image of a size that cannot be played back with your camera.
INVALID OPERATION	You are playing back a file that was created on equipment other than your camera.
	The battery level is low or zero.
	The image is protected.

## Self-diagnosis display

Your camera has a self-diagnosis display. This function displays the camera condition on the LCD screen with a combination of a letter and four digits of numbers. If this occurs, check the following code chart. The code informs you of the camera's current condition. The last two digits (indicated by □□) will differ depending on the state of the camera.

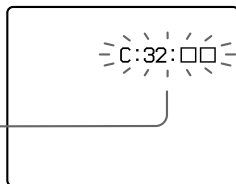

### Self-diagnosis display

- C:□□:□□

You can reverse the camera malfunction yourself.

- E:□□:□□

Contact your Sony dealer or local authorized Sony service facility.

First three digits	Cause and/or Corrective Action
C:32:□□	<ul style="list-style-type: none"><li>• There is trouble with your camera's hardware. → Turn the power off and on again.</li></ul>
C:13:□□	<ul style="list-style-type: none"><li>• An unformatted "Memory Stick" is inserted. → Format the "Memory Stick" (page 32).</li><li>• The inserted "Memory Stick" cannot be used with your camera, or is damaged. → Insert a new "Memory Stick" (page 15).</li></ul>
E:61:□□ E:91:□□	<ul style="list-style-type: none"><li>• A camera malfunction that you cannot reverse has occurred. → Contact your Sony dealer or local authorized Sony service facility and inform them of the 5-digit service code. (example: E:61:10)</li></ul>

**If you are unable to solve the problem even after trying the corrective actions a few times, contact your Sony dealer or local authorized Sony service facility.**

# Specifications

## System

### Image device

1/2.7 type color CCD

### Lens

3× zoom lens

f = 6.1 – 18.3 mm

(39 – 117 mm when converted into a 35 mm still camera)

F = 2.8 – 2.9

### Exposure control

Automatic exposure

### White balance

Automatic, Indoor, Outdoor, Hold

### Data system

Still: JPEG, GIF (in TEXT mode), TIFF

Movie (DSC-S50 only):

MPEG1

Audio with still image

(DSC-S50 only):

MPEG1 (Monaural)

### Recording medium

“Memory Stick”

### Flash

Recommended recording distance:

11 7/8 inches to 8 1/4 feet  
(0.3 m to 2.5 m)

### Output connector

#### A/V OUT (Monaural)

#### (DSC-S50 only)

Minijack

Video: 1 V<sub>p-p</sub>, 75 Ω

unbalanced, sync negative

Audio: 327 mV (at a 47 kΩ load)

Output impedance: 2.2 kΩ

#### VIDEO OUT

#### (DSC-S30 only)

Minijack

#### Digital I/O (USB)

Special minijack

### LCD screen

#### Used LCD panel

2 type TFT (Thin Film

Transistor active matrix) drive

### Total number of dots

123 200 (560×220) dots

## General

### Used battery pack

NP-FM50

### Power requirements

8.4 V

### Power consumption (during recording)

2.9 W

### Operation temperature

32°F to 104°F

(0°C to 40°C)

### Storage temperature

–4°F to +140°F

(–20°C to +60°C)

### Maximum dimensions

4 1/2×2 3/4×2 3/4 inches  
(113×68×69 mm) (w/h/d)

### Mass

Approx. 13 oz (370 g)

(including battery pack NP-FM50, “Memory Stick”, wrist strap and lens cap etc.)

### Built-in microphone

#### (DSC-S50 only)

Electret condenser microphone

### Built-in speaker

#### (DSC-S50 only)

Dynamic speaker

### AC-L10 AC power adaptor

#### Power requirements

100 to 240 V AC, 50/60 Hz

#### Rated output voltage

DC 8.4 V, 1.5 A in operating mode

#### Operation temperature

32°F to 104°F (0°C to 40°C)

#### Storage temperature

–4°F to +140°F

(–20°C to +60°C)

#### Maximum dimensions

5×1 9/16×2 1/2 inches  
(125×39×62 mm) (w/h/d)

#### Mass

Approx. 10 oz (280 g)

## NP-FM50 battery pack

### Used battery

Lithium ion battery

### Maximum voltage

DC 8.4 V

### Nominal voltage

DC 7.2 V

### Capacity

8.5 Wh (1 180mAh)

## Accessories

A/V connecting cable

(DSC-S50 only) (1)

VIDEO connecting cable

(DSC-S30 only) (1)

NP-FM50 battery pack (1)

AC-L10 AC power adaptor (1)

Power cord (1)

USB cable (1)

Lens cap (1)

Lens cap strap (1)

Wrist strap (1)

“Memory Stick” (4 MB) (1)

CD-ROM (1)

Operating Instructions (1)

Design and specifications are subject to change without notice.

## LCD screen indicators

### The indicators during recording

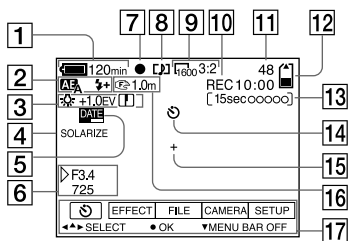

- |   |  |    |   |
|---|--|----|---|
| 1 | Battery remaining indicator                    | 10 | Self-diagnosis function/<br>recording time indicator          |
| 2 | PROGRAM AE/flash level/flash<br>mode indicator | 11 | Number of recorded images                                     |
| 3 | White balance/EV level/<br>sharpness indicator | 12 | Remaining memory capacity<br>indicator                        |
| 4 | Picture effect indicator                       | 13 | Moving image/VOICE recording<br>time indicator (DSC-S50 only) |
| 5 | Date/time indicator                            | 14 | Self-timer indicator  |
| 6 | Aperture/shutter speed<br>indicator            | 15 | Spot light-metering indicator                                 |
| 7 | AE lock/focus lock indicator                   | 16 | Focus/macro mode indicator                                    |
| 8 | Recording mode indicator                       | 17 | Menu bar and guide menu                                       |
| 9 | Image size indicator                           |    |   |

They appear by pressing ▲ on the control button and disappear by pressing ▼ of it.



## When playing back still images

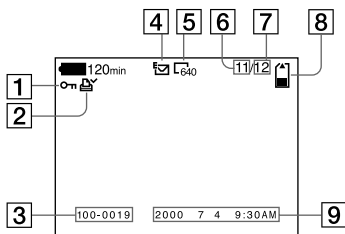

- |  |  |
|--|--|
| <ul style="list-style-type: none"> <li>1 Protect indicator</li> <li>2 Print mark indicator</li> <li>3 File name</li> <li>4 Recording mode indicator</li> <li>5 Image size indicator</li> <li>6 Image number</li> </ul> | <ul style="list-style-type: none"> <li>7 Number of stored images in "Memory Stick"</li> <li>8 Remaining memory capacity indicator</li> <li>9 Recording date of the playback image/menu bar and guide menu</li> </ul> |
|--|--|

## When playing back moving images

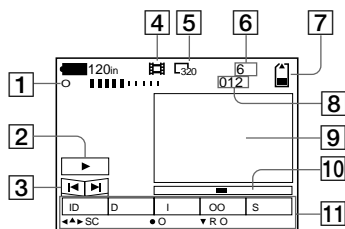

- |   |   |
|---|---|
| <ul style="list-style-type: none"> <li>1 VOL. (Volume) indicator (DSC-S50 only)</li> <li>2 Playback/pause buttons<br/>▶: during pause<br/>  : during playback</li> <li>3 Fast-forward/rewind buttons</li> <li>4 Recording mode indicator</li> <li>5 Image size indicator</li> </ul> | <ul style="list-style-type: none"> <li>6 Image number/number of stored images in "Memory Stick"</li> <li>7 Remaining memory capacity indicator</li> <li>8 Counter</li> <li>9 Playback image</li> <li>10 Play bar</li> <li>11 Menu bar and guide menu</li> </ul> |
|---|---|

# Index

## A

- A/V OUT .....48
- Adjusting the exposure ....43
- AE (Auto Exposure) .....16
- Aperture priority mode ....42
- Auto power-off function ....9
- Auto red-eye reduction ....19

## B

- Battery pack
  - battery life .....10
  - charging .....9
  - installing .....8
  - remaining battery indicator .....64
- BEEP .....35

## C

- Charging the battery pack ..9
- Cleaning .....54
- Control button .....29
- COPY .....51

## D

- DELETE .....50
- Digital zoom .....17
- Display window indicators .....64

## E

- Editing
  - COPY .....51
  - DELETE .....50
  - preventing accidental erasure .....49
- E-MAIL .....38
- Enlarging a part of the still image .....46

## F

- Face-to-face recording ....37
- File name .....28
- FLASH LEVEL .....19
- Focus .....41
- Focusing manually .....41
- FORMAT .....32
- Full charge .....9

## I

- IMAGE SIZE .....37
- INDEX mode .....45
- “InfoLITHIUM” battery pack .....8

## J

- JPEG .....16

## L

- LCD screen .....64
- LCD screen indicators .....64

## M

- “Memory Stick”
  - copying images .....51
  - formatting .....32
  - inserting .....15
  - number of images that you can record .....38
- Menu .....32
- MODE selector .....29
- Moisture condensation ....54
- Moving images
  - playing back .....22
  - recording .....20
- MPEG .....20

## N

- Normal charge .....9
- NTSC system .....56
- Number of images that you can record
  - by image size .....38
  - in E-MAIL mode .....38
  - in VOICE mode .....39

## P

- P.EFFECT .....44
- PAL system .....56
- Playing back
  - moving images .....22
  - still images .....21
- Playing back multiple images at once .....45
- Power supply
  - AC power adaptor .....12
  - battery pack .....9
- Preventing accidental erasure .....49
- PRINT MARK .....53
- PROGRAM AE .....53
- PROTECT .....49

## Q

- Quick Review .....17

## R

- REC MODE .....33
- Recording
  - images in macro .....41
  - moving images .....20
  - still images .....16
  - still images for e-mail .....38
  - with the flash .....19
- RESIZE .....51

## S

- SECAM system .....56
- Self-diagnosis display .....62
- Setting date and time .....13
- SHARPNESS .....34
- Shutter speed priority mode .....42
- Single mode .....31
- SLIDE SHOW .....47
- Still images
  - playback .....21
  - recording .....16

## T

- TEXT .....39
- TIFF .....40
- TV color system .....56

## U

- USB .....25
- Using the self-timer .....18
- Using your camera abroad .....56

## V

- Viewing images
  - on a TV screen .....48
  - using a personal computer .....24
- VOICE .....39

## W

- Warning and notice messages .....61
- WHITE BALANCE .....43

## Z

- Zoom .....17



