

Digital Still Camera

Operating Instructions

Before operating the unit, please read this manual thoroughly, and retain it for future reference.

Owner's Record

The model and serial numbers are located on the bottom. Record the serial number in the space provided below. Refer to these numbers whenever you call upon your Sony dealer regarding this product.

Model No. DSC-F707

Serial No. _____

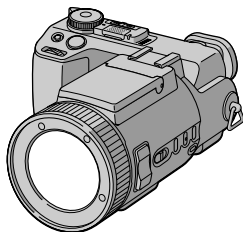

Cyber-shot
Digital Still Camera

i InfoLITHIUM™ **M**
SERIES



MEMORY STICK™

DSC-F707

WARNING

To prevent fire or shock hazard, do not expose the unit to rain or moisture.

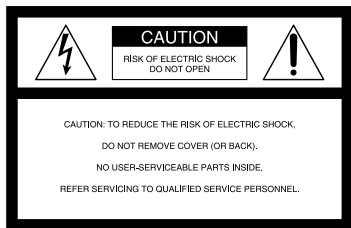
For the Customers in the U.S.A.



This symbol is intended to alert the user to the presence of uninsulated “dangerous voltage” within the product’s enclosure that may be of sufficient magnitude to constitute a risk of electric shock to persons.



This symbol is intended to alert the user to the presence of important operating and maintenance (servicing) instructions in the literature accompanying the appliance.

CAUTION

The use of optical instruments with this product will increase eye hazard. As the laser beam used in this camera is harmful to eyes, do not attempt to disassemble the cabinet. Refer servicing to qualified personnel only.

If you have any questions about this product, you may call:

Sony Customer Information Services Center
1-800-222-SONY (7669)

The number below is for the FCC related matters only.

Regulatory Information

Declaration of Conformity

Trade Name: SONY
Model No.: DSC-F707
Responsible Party: Sony Electronics Inc.
Address: 680 Kinderkamack
Road, Oradell, NJ
07649 USA
Telephone No.: 201-930-6972

This device complies with Part 15 of the FCC Rules. Operation is subject to the following two conditions: (1) This device may not cause harmful interference, and (2) this device must accept any interference received, including interference that may cause undesired operation.

CAUTION

You are cautioned that any changes or modifications not expressly approved in this manual could void your authority to operate this equipment.

Note:

This equipment has been tested and found to comply with the limits for a Class B digital device, pursuant to Part 15 of the FCC Rules. These limits are designed to provide reasonable protection against harmful interference in a residential installation. This equipment generates, uses, and can radiate radio frequency energy and, if not installed and used in accordance with the instructions, may cause harmful interference to radio communications. However, there is no guarantee that interference will not occur in a particular installation. If this equipment does cause harmful interference to radio or television reception, which can be determined by turning the equipment off and on, the user is encouraged to try to correct the interference by one or more of the following measures:

- Reorient or relocate the receiving antenna.
- Increase the separation between the equipment and receiver.

- Connect the equipment into an outlet on a circuit different from that to which the receiver is connected.
- Consult the dealer or an experienced radio/TV technician for help.

The supplied interface cable must be used with the equipment in order to comply with the limits for a digital device pursuant to Subpart B of Part 15 of FCC Rules.

About Ferrite Core

Be sure to attach the supplied ferrite core to the cable of the AC power adaptor. This ferrite core can reduce noises. Refer to the addendum for the details.

For the Customers in the U.S.A. and Canada

DISPOSAL OF LITHIUM ION BATTERY.

LITHIUM ION BATTERY.

DISPOSE OF PROPERLY.

You can return your unwanted lithium ion batteries to your nearest Sony Service Center or Factory Service Center.

Note:

In some areas the disposal of lithium ion batteries in household or business trash may be prohibited.

For the Sony Service Center nearest you call 1-800-222-SONY (United States only)
For the Factory Service Center nearest you call 416-499-SONY (Canada only)

Caution:



Do not handle damaged or leaking lithium ion battery.

CAUTION

TO PREVENT ELECTRIC SHOCK, DO NOT USE THIS POLARIZED AC PLUG WITH AN EXTENSION CORD, RECEPTACLE OR OTHER OUTLET UNLESS THE BLADES CAN BE FULLY INSERTED TO PREVENT BLADE EXPOSURE.

Notice for the Customers in the United Kingdom

A moulded plug complying with BS1363 is fitted to this equipment for your safety and convenience.

Should the fuse in the plug supplied need to be replaced, a 5 AMP fuse approved by ASTA or BSI to BS1362, (i.e., marked with  or  mark) must be used.

If the plug supplied with this equipment has a detachable fuse cover, be sure to attach the fuse cover after you change the fuse. Never use the plug without the fuse cover. If you should lose the cover, please contact your nearest Sony service station.

For the Customers in Germany

Directive: EMC Directive 89/336/EEC, 92/31/EEC

This equipment complies with the EMC regulations when used under the following circumstances:

- Residential area
- Business district
- Light-industry district

(This equipment complies with the EMC standard regulations EN55022 Class B.)

Attention for the Customers in Europe

This product has been tested and found compliant with the limits sets out on the EMC Directive for using connection cables shorter than 3 meters.

Attention

The electromagnetic fields at the specific frequencies may influence the picture and sound of this camera.

CLASS 1 LASER PRODUCT
LASER KLASSE 1
LUOKAN 1 LASERLAITE
KLASS 1 LASERAPPARAT



For the Customers in the U.S.A. and Canada

THIS DEVICE COMPLIES WITH PART 15 OF THE FCC RULES. OPERATION IS SUBJECT TO THE FOLLOWING TWO CONDITIONS:

- (1) THIS DEVICE MAY NOT CAUSE HARMFUL INTERFERENCE, AND
- (2) THIS DEVICE MUST ACCEPT ANY INTERFERENCE RECEIVED, INCLUDING INTERFERENCE THAT MAY CAUSE UNDESIRE OPERATION. THIS CLASS B DIGITAL APPARATUS COMPLIES WITH CANADIAN ICES-003.

Be sure to read the following before using your camera

Trial recording

Before you record one-time events, you may want to make a trial recording to make sure that the camera is working correctly.

No compensation for contents of the recording

Contents of the recording cannot be compensated for if recording or playback is not possible due to a malfunction of your camera or recording medium, etc.

Notes on image data compatibility

- This camera conforms with the Design rule for Camera File system universal standard established by the JEITA (Japan Electronics and Information Technology Industries Association). You cannot play back on your camera still images recorded on other equipment (DCR-TRV890E/TRV900/TRV900E, DSC-D700, DSC-D770) that does not conform with this universal standard. (These models are not sold in some areas.)

- Playback of images recorded with your camera on other equipment and playback of images recorded or edited with other equipment on your camera are not guaranteed.

Precaution on copyright

Television programs, films, video tapes, and other materials may be copyrighted.

Unauthorized recording of such materials may be contrary to the provision of the copyright laws.

Do not shake or strike the camera

In addition to malfunctions and inability to record images, this may render the “Memory Stick” unusable or image data breakdown, damage or loss may occur.

Do not aim the camera at the sun or other bright light

This may cause irrecoverable damage to your eyes.

LCD screen, LCD finder (only models with a finder) and lens

- The LCD screen and the LCD finder are manufactured using extremely high-precision technology so over 99.99% of the pixels are operational for effective use. However, there may be some tiny black points and/or bright points (white, red, blue or green in color) that constantly appear on the LCD screen and the LCD finder. These points are normal in the manufacturing process and do not affect the recording in any way.
- Be careful when placing the camera near a window or outdoors. Exposing the LCD screen, the finder or the lens to direct sunlight for long periods may cause malfunctions.

Do not get the camera wet

When taking pictures outdoors in the rain or under similar conditions, be careful not to get the camera wet. If moisture condensation occurs, refer to page 95 and follow the instructions on how to remove it before using the camera.

Back up recommendation

To avoid the potential risk of data loss, always copy (back up) data to a disk.

When the camera is used for long periods

Note that the camera body may become hot.

Notice

If static electricity or electromagnetism causes data transfer to discontinue midway (fail), restart the application or disconnect and connect the USB cable again.

About the Carl Zeiss lens

This camera is equipped with a Carl Zeiss lens which is capable of reproducing fine images. The lens for this camera uses the MTF* measurement system for cameras developed jointly by Carl Zeiss, in Germany, and Sony Corporation, and offers the same quality as other Carl Zeiss lenses.

* MTF is the abbreviation of Modulation Transfer Function, a numeric value indicating the amount of light from a specific part of the subject gathered at the corresponding position in the image.

Introduction

Check images after recording

Recording still images:

page 21

Playing back still images:

page 35

Deleting images (DELETE):

page 83

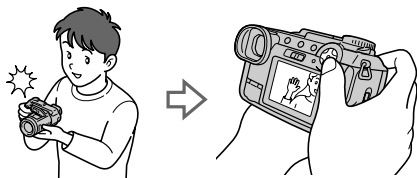

Capture images with your computer

You can copy images onto your computer and view and modify images or attach images to e-mail on your computer using the supplied USB cable and application software.

Viewing images using a computer: page 38

Recording still images for e-mail (E-MAIL): page 67

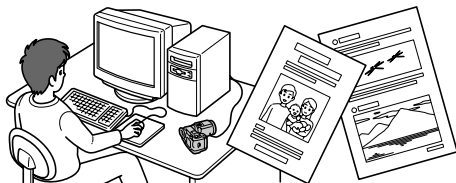

Record moving pictures (MPEG Movie or Clip Motion)

The digital still camera can record a moving

picture with audio (MPEG MOVIE):

page 32



Select from various recording modes

Adding audio files to still images (VOICE): page 68

Recording still images as uncompressed files (TIFF): page 69

Creating Clip Motion Files: page 70

Table of contents

Getting started

Identifying the parts	8
Preparing the power supply	11
Setting the date and time	16
Inserting the “Memory Stick”	18

Basic operations

Basic operations	19
How to use the mode dial	19
How to use the control button	19

► Recording

Recording still images	21
Recording moving images	32

► Playback

Playing back still images	35
Playing back moving images	36
Viewing images using a computer	38
Viewing images on Windows	39
Viewing images on Macintosh	48
Image file storage destinations and image files	51

Advanced operations

Before performing advanced operations

Changing the settings	53
How to use the jog dial	58
Setting the image size (IMAGE SIZE)	60

► Various recording

Recording with the exposure fixed (AE LOCK)	62
Recording with the manual adjustments	63
Recording images according to shooting conditions (Scene selection)	65
Recording three images continuously (BURST 3)	66
Recording three images with the exposure shifted (EXP BRKTG)	66
Recording still images for e-mail (E-MAIL)	67
Adding audio files to still images (VOICE)	68
Recording still images as uncompressed files (TIFF)	69

Creating Clip Motion Files	70
Focusing manually	72
Recording images at close range (MACRO)	73
Adjusting the exposure (EXPOSURE) ..	73
Adjusting the white balance (WHITE BALANCE)	74
Enjoying picture effects (P. EFFECT)	75
Recording the date and time on a still image (DATE/TIME)	76
Determining the exposure (Metering mode)	76

► Various playback

Playing back three or nine images at once	78
Enlarging a part of a still image (Zoom and trimming)	79
Playing back still images in order (SLIDE)	80
Rotating a still image (ROTATE)	81
Viewing images on a TV screen	82

► Editing

Deleting images (DELETE)	83
Preventing accidental erasure (PROTECT)	84
Changing the recorded still image size (RESIZE)	86
Copying images (COPY)	87
Selecting still images to print (PRINT)	88
Dividing a moving image file (DIVIDE)	90
Formatting the “Memory Stick” (FORMAT)	91
Changing the SET UP settings (SETUP)	92

Additional information

Precautions	95
On “Memory Sticks”	96
On “InfoLITHIUM” battery pack	97
Using your camera abroad	98
Troubleshooting	99
Warning and notice messages	105
Self-diagnosis display	107
Specifications	108
Finder/LCD screen indicators	109
Index	112

Identifying the parts

See the pages in parentheses for details of operation.

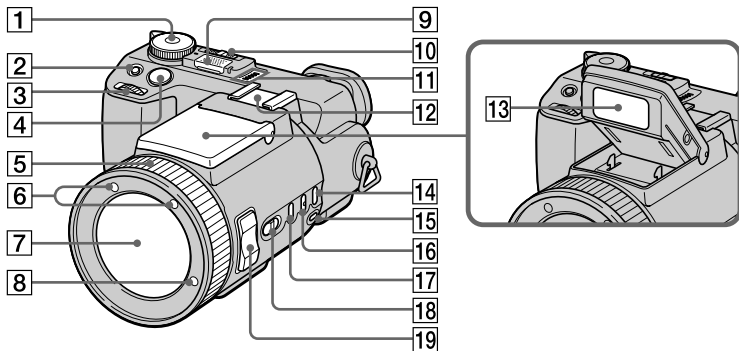

- | | |
|---|---|
| <p>1 Mode dial (19)
 : To record still images
 S: To record in the shutter speed priority mode
 A: To record in the aperture priority mode
 M: To record in the manual exposure mode
 SCN: To record in the scene selection mode
 SET UP: To set the SET UP items (92)
 : To record moving images or Clip Motion images
 : To playback or edit images</p> <p>2 (Exposure) button (73)</p> <p>3 Jog dial (58)</p> <p>4 Shutter button (21, 33)</p> <p>5 Focus ring (72)</p> <p>6 Infrared rays emitter (29)</p> <p>7 Lens</p> | <p>8 Hologram AF emitter (28)</p> <p>9 Built-in microphone
Do not touch while recording.</p> <p>10 NIGHTSHOT/NIGHTFRAMING switch (29, 30, 33)</p> <p>11 Speaker</p> <p>12 Accessory shoe</p> <p>13 Flash emitter (26)</p> <p>14 WHT BAL (white balance) button (74)</p> <p>15 (one-push white balance) button (74)</p> <p>16 (metering mode) button (76)</p> <p>17 AE LOCK button (62)</p> <p>18 FOCUS (AUTO/MANUAL) switch (72)</p> <p>19 ZOOM button (24)</p> |
|---|---|

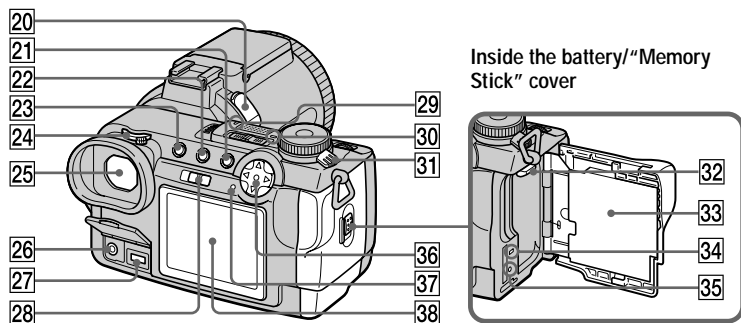

20 ACC (Accessory) jack

Used to connect the external flash (not supplied) or the remote control tripod (not supplied).

21 MENU button (20)

22  (Index) button (78)

23 DISPLAY button (25)

24 Finder adjustment dial (23)

25 Finder (23)

The finder eyepiece cannot be removed.

26 A/V OUT jack (82)

Audio output is monaural.

27 DC IN jack (12, 15)

28 FINDER/LCD switch (23)

29 Self-timer lamp (26, 33)

30 POWER lamp (16)

31 POWER switch (16)

32 Battery eject lever (11)

33 Battery/"Memory Stick" cover

34 Access lamp (18)

35 RESET button (99)

36 Control button (19)

37 CHG/  (Flash charge) lamp (12, 26)

38 LCD screen

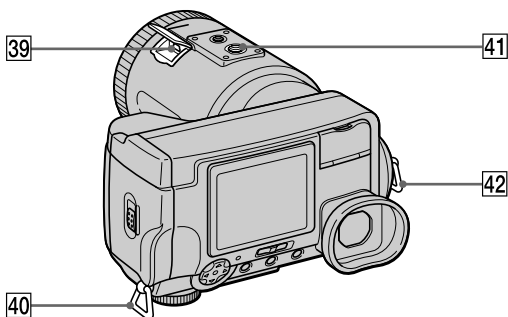

39 Ψ (USB) jack (43, 45)

40 Hook for shoulder strap

41 Tripod receptacle (bottom surface)

Use a tripod with a screw length of less than 5.5 mm (7/32 inch). You will be unable to firmly secure the camera to tripods having longer screws, and may damage the camera.

42 Hook for shoulder strap

Attaching the lens cap (supplied) and the shoulder strap (supplied).

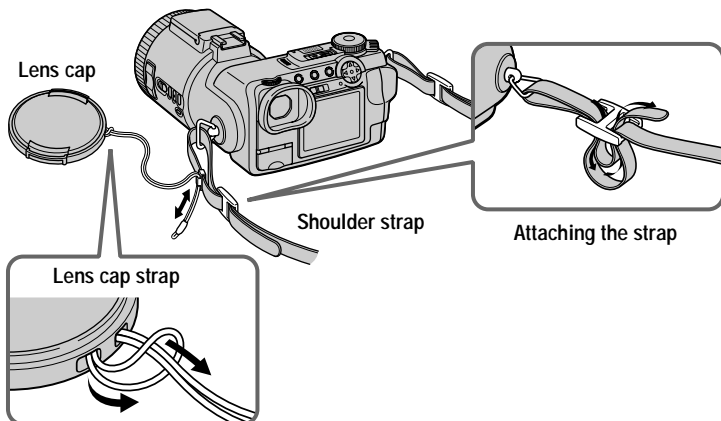

Preparing the power supply

Installing the battery pack

Your camera operates only with the “InfoLITHIUM” NP-FM50 battery pack* (M series) (supplied). You cannot use any other battery pack. See page 97 for more information about the “InfoLITHIUM” battery pack.

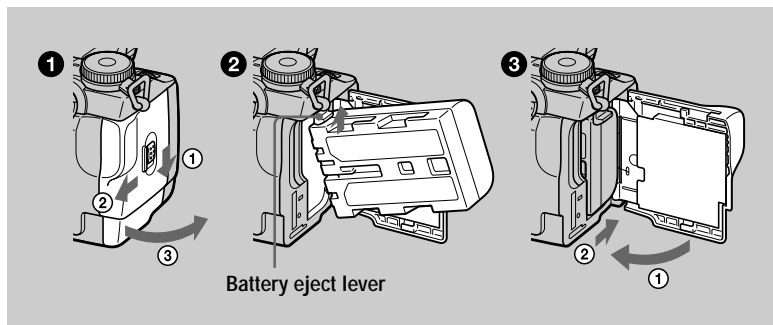

1 Open the battery/“Memory Stick” cover.

Slide the cover in the direction of the arrow.

2 Install the battery pack.

Insert the battery pack with the ▲ mark facing toward the battery compartment as illustrated.

3 Close the battery/“Memory Stick” cover.

To remove the battery pack

Open the battery/“Memory Stick” cover. Slide the battery eject lever upward, and remove the battery pack.

Be careful not to drop the battery pack when removing it.

* What is “InfoLITHIUM”?

“InfoLITHIUM” is a lithium ion battery pack which can exchange information such as battery consumption with compatible electronic equipment. This unit is compatible with the “InfoLITHIUM” battery pack (M series). “InfoLITHIUM” M series battery packs have the  mark. “InfoLITHIUM” is a trademark of Sony Corporation.

Charging the battery pack

You cannot charge the battery pack while your camera is turned on. Be sure to turn off your camera.

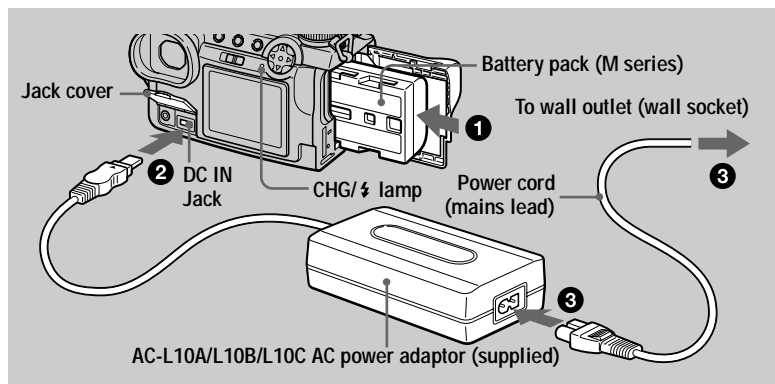

- 1** Insert the battery pack into your camera.
- 2** Open the jack cover and connect the DC connecting cable to the DC IN jack of your camera with the ▲ mark facing up.
- 3** Connect the power cord (mains lead) to the AC power adaptor and then to a wall outlet (wall socket).
The CHG/⚡ lamp lights up when charging begins. When the CHG/⚡ lamp goes off, charging is completed.

When using the AC power adaptor

Be sure to use it near the wall outlet (wall socket). If a malfunction occurs, disconnect the plug from the wall outlet (wall socket) at once.

After charging the battery pack

Disconnect the AC power adaptor from the DC IN jack of your camera.

Recommended charging temperature

We recommend charging the battery pack in an ambient temperature of between 10°C to 30°C (50°F to 86°F).

Using your camera abroad

For details, see page 98.

NP-FM50 battery pack

When you record images in an extremely cold location, the operating time becomes short. Place the battery pack in your pocket or other place to keep it warm, then insert the battery pack into the camera just before recording. When using a pocket heater, take care not to let the heater directly contact the battery.

Charging time

Battery pack	Full charge (min.)
NP-FM50 (supplied)	Approx. 150

Approximate time to charge a completely discharged battery pack using the AC-L10A/B/C AC power adaptor at a temperature of 25°C (77°F).

Battery life and number of images that can be recorded/played back

Still image recording*

	NP-FM50 (supplied)	
	Battery life (min.)	Number of images
with LCD	Approx. 150	Approx. 2500
with finder	Approx. 150	Approx. 2500

Still image playback**

	NP-FM50 (supplied)	
	Battery life (min.)	Number of images
with LCD	Approx. 330	Approx. 6600

Approximate battery life and number of images that can be recorded/played back with a fully charged battery pack at a temperature of 25°C (77°F), 640×480 image size, standard picture quality and in NORMAL recording mode.

* Recording at about 4-second intervals

** Playing back single images in order at about 3-second intervals

Moving image recording

	NP-FM50 (supplied)	
	with LCD (min.)	with finder (min.)
Continuous recording	Approx. 210	Approx. 210

Approximate recording time with a fully charged battery pack at a temperature of 25°C (77°F) and 160×112 image size.

■ Notes

- The battery life and number of images will be decreased in the following cases:
 - When you use your camera at low temperatures.
 - When you use the flash.
 - When you repeatedly turn the power on/off.
 - When you use the zoom.
 - When you set the LCD backlight or the EVF backlight to BRIGHT.
- The numbers of images shown on tables above are a guide. The actual numbers may be less depending on conditions.
- The capacity of the “Memory Stick” is limited. The figures on tables are a guide for when you continuously record/play back while replacing the “Memory Stick.”
- When you switch the FINDER/LCD switch, it takes about one minute for the correct battery remaining time to appear.
- If sufficient battery remaining time is indicated but the power runs out soon, fully charge the battery so that the correct battery remaining time appears.
- Do not short the DC plug of the AC power adaptor with a metallic object, as this may cause malfunction.

Using the AC power adaptor

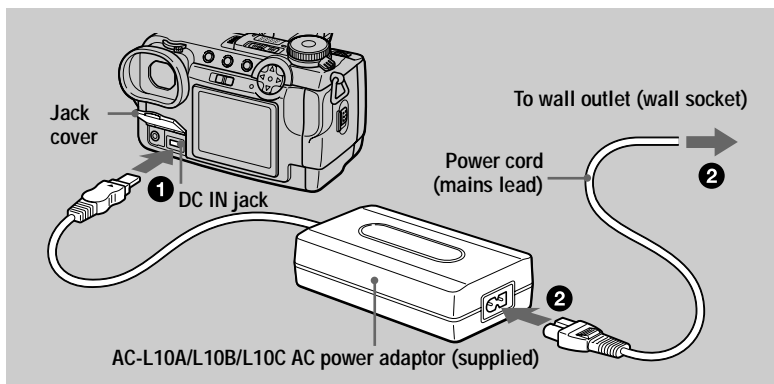

- 1** Open the jack cover and connect the DC connecting cable to the DC IN jack of your camera with the ▲ mark facing up.
- 2** Connect the power cord (mains lead) to the AC power adaptor and then to a wall outlet (wall socket).

Using a car battery

Use Sony DC adaptor/charger (not supplied).

Setting the date and time

When you first use your camera, set the date and time. If these are not set, the CLOCK SET screen will appear whenever you turn on your camera.

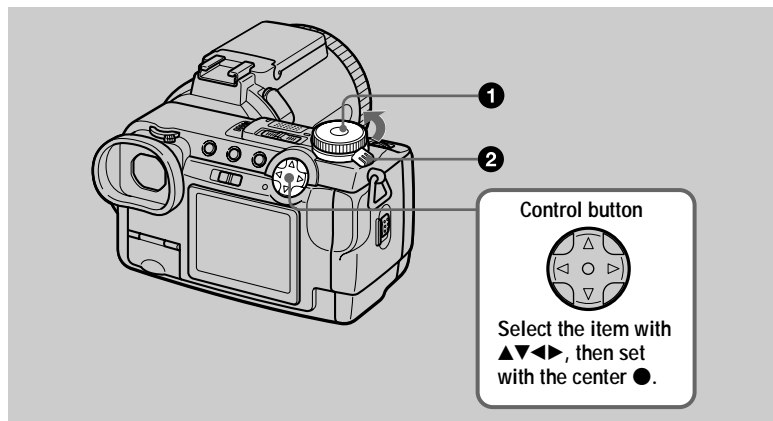

1 Set the mode dial to , S, A, M, SCN, , or .

2 Slide the POWER switch in the direction of the arrow to turn on the power.

The POWER lamp (green) lights up.

The CLOCK SET screen appears on the screen.

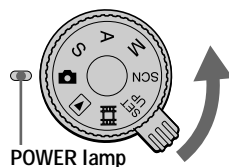

3 Select the desired date display format with ▲▼ on the control button, then press the center ●.

Select from [Y/M/D] (year/month/day), [M/D/Y] (month/day/year) or [D/M/Y] (day/month/year).

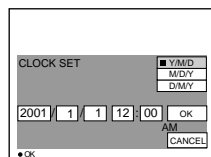

4 Select the year, month, day, hour or minute item you want to set with ◀▶ on the control button.

The item to be set is indicated with ▲▼.

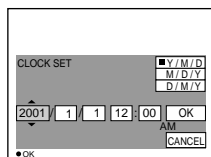

- 5** Set the numeric value with ▲/▼ on the control button, then press the center ● to enter it.

After entering the number, ▲/▼ moves to the next item.

If you selected [D/M/Y] in step 3, set the time on a 24-hour cycle.

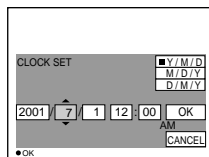

- 6** Select [OK] with ► on the control button, then press the center ● at the desired moment to begin clock movement.

The date and time are entered.

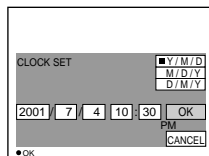

To cancel the date and time setting

Select [CANCEL] with ▲/▼/◀/▶ on the control button, then press the center ●.

To change the date and time

Set the mode dial to SET UP, and change the date and time on the CLOCK SET screen in  (SETUP 1) (page 93).

Note

If the rechargeable button battery is ever fully discharged (page 96), the CLOCK SET screen will appear again. When this happens, reset the date and time, by starting from step 3 above.

Inserting the "Memory Stick"

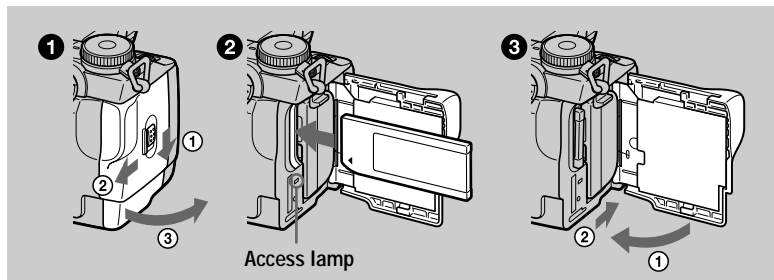

- 1 Open the battery/"Memory Stick" cover.**
Slide the cover in the direction of the arrow.
- 2 Insert the "Memory Stick."**
Insert the "Memory Stick" with the ◀ mark facing toward the battery compartment as illustrated until it clicks.
- 3 Close the battery/"Memory Stick" cover.**

Removing the "Memory Stick"

Open the battery/"Memory Stick" cover, then press the "Memory Stick" once lightly.

■ Notes

- Insert the "Memory Stick" firmly until it clicks, otherwise a message such as "MEMORY STICK ERROR" will be displayed.
- When the access lamp is lit up, it means data is being read or written. Never remove the "Memory Stick" or turn off the power at this time, as the data may become damaged.
- You cannot record or edit images on a "Memory Stick" if the erasure prevention switch is set to the LOCK position.
- You can use both types of "Memory Sticks": general "Memory Sticks" and "MagicGate Memory Sticks" with this camera (page 96).

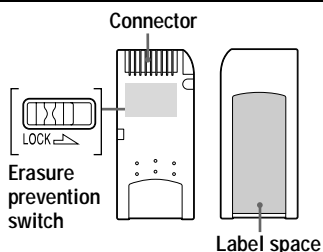

- * The position and shape of the erasure prevention switch may differ depending on the types of "Memory Stick" used.

Basic operations

How to use the mode dial

The mode dial switches the function which is used for recording, playback, or editing. Set the dial as follows before starting to operate your camera.

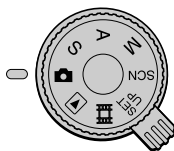

- : To record still images (page 21)
- S:** To record in the shutter speed priority mode (page 63)
- A:** To record in the aperture priority mode (page 63)
- M:** To record with the shutter speed and aperture set manually (page 64)
- SCN:** To record in the scene selection mode (page 65)
- SET UP:** To set the SET UP items (page 92)
- : To record moving images or Clip Motion images (pages 32, 70)
- : To play back or edit images (pages 35, 36, 78, 83)

How to use the control button

When the menu is not displayed

The control button is used to perform the following operations.

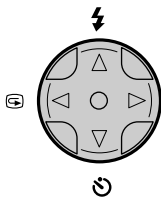

- (▲): Recording with flash (page 26)
- (▼): Recording with self-timer (pages 26, 33)
- (◀): Checking the last recorded image (page 23)
- (▶): Recording close subjects (page 73)

When the menu or SET UP screen is displayed

The control button is used to select the buttons, images and menu items displayed on the screen of your camera and modify the settings.



Turning on/off the operation buttons (menu) on the screen

Press MENU to display/
clear the menu on the
screen.*

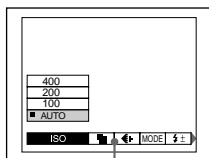
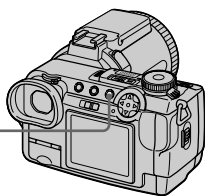

Menu

* Note that in these Operating Instructions, “on the screen” refers to both “in the finder” and “on the LCD screen”.

Recording still images

Still images are recorded in JPEG format.

To record still images, slide the **POWER switch** in the direction of the arrow to turn on the power and insert a “Memory Stick.”

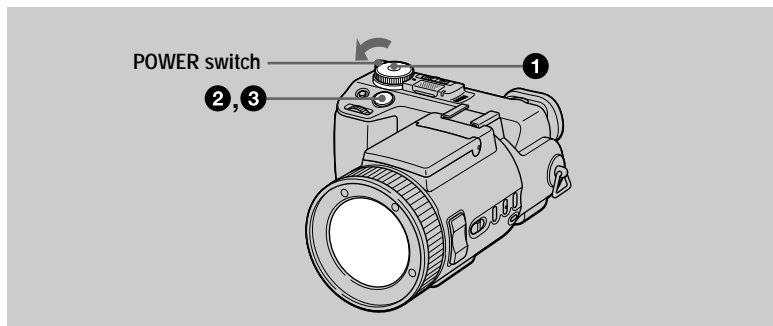

1 Set the mode dial to , **S**, **A**, **M** or **SCN**.

2 Press and hold the shutter button halfway down.

The beep sounds, but the image is not yet recorded. While the AE/AF lock indicator ● is flashing, the camera automatically adjusts the exposure and focus of the captured image. When the camera finishes the automatic adjustments, the AE/AF lock indicator ● changes from flashing to lighted up* and the camera is ready for recording.

If you release the shutter button, the recording will be canceled.

AF frame
Align the AF frame with the subject.

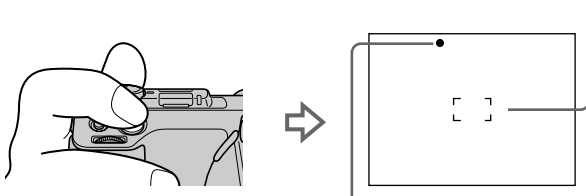

AE/AF lock indicator (green) flashes → lights up

* If the flashing AE/AF lock indicator changes to flashing slowly, the subject may be difficult to focus on (dark, poor contrast) or the subject may be extremely close. Release the shutter button, then focus again.

3 Press the shutter button fully down.

The shutter sounds.

“RECORDING” appears on the screen, and the image will be recorded on the “Memory Stick.” When “RECORDING” disappears, you can record the next image.

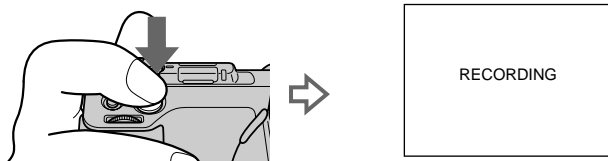

Auto power-off function

If you do not operate the camera for about three minutes during recording or playback, the camera turns off automatically to prevent wearing down the battery. To use the camera again, turn on the camera again with the POWER switch. The auto power-off function only operates when the camera is operating using a battery pack. The auto power-off also will not operate when playing back moving images or playing back a SLIDE SHOW (page 80), or when a connector is plugged into the USB jack, the DC IN jack or the A/V OUT jack.

The number of images you can record on a “Memory Stick” (16 MB)

See pages 61 and 67 to 71.

Notes

- The following phenomena may occur when AE/AF is locked, but this does not affect the recorded image.
 - When recording a bright subject, the screen color may change.
 - When recording a dark subject, the screen may brighten momentarily.
- If you press the shutter button fully down at once in step 2, the camera starts recording after the automatic adjustments are complete. However, the recording cannot be carried out while the CHG/⚡ lamp (page 26) is flashing. (During this time, the camera is charging the flash.)

Recording images with the finder

With the FINDER/LCD switch, you can choose to record either using the finder or the LCD screen. When you use the finder, the image does not appear on the LCD screen. Turn the finder adjustment dial until the image appears clearly within the finder, then record the image.

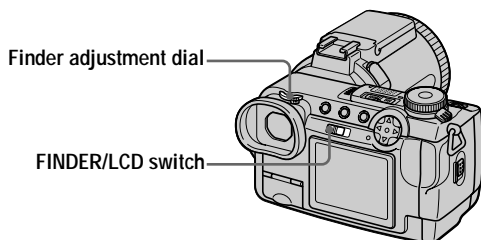

Checking the last recorded image (Quick Review)

You can check the last recorded image by clearing the menu from the screen (page 20) and pressing ◀ (Ⓢ) on the control button.

To delete the image:

1. Display the menu.
2. Select [DELETE] with ▶ on the control button, then press the center ●.
3. Select [OK] with ▲ on the control button, then press the center ●.

To return to the normal recording mode: press lightly on the shutter button or press ◀ (Ⓢ) again.

Using the zoom feature

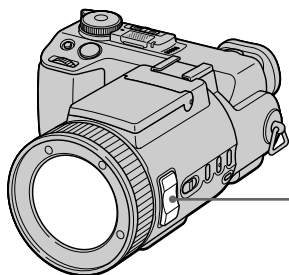

ZOOM button

W side: for wide-angle (subject appears farther away)



T side: for telephoto (subject appears closer)

Press the ZOOM button a little for a slower zoom.
Press it further for a faster zoom.

Minimum focal distance to the subject

W side: About 50 cm (19 3/4 inches) or more

T side: About 90 cm (35 1/2 inches) or more

To record even closer subjects, see page 73.

Digital zoom function

This camera has a digital zoom function.

Digital zoom enlarges the image by digital processing and it starts to function when zoom exceeds 5 \times .

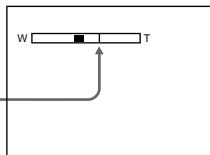

The T side of the bar shows the digital zooming zone.

Using digital zoom

- The maximum zoom magnification is 10 \times .
- Digital zooming deteriorates the picture quality. When digital zoom is not necessary, set [DIGITAL ZOOM] to [OFF] in the SET UP settings (page 92).

Notes

- Zoom does not work when [CONVERSION LENS] is set to [ON] in the SET UP settings (page 93).
- Digital zoom does not work for moving images.
- During digital zoom, the AF frame (page 21) does not appear on the screen.

Changing the lens orientation

You can adjust the angle by turning the lens part upward up to 77 degrees and downward up to 36 degrees.

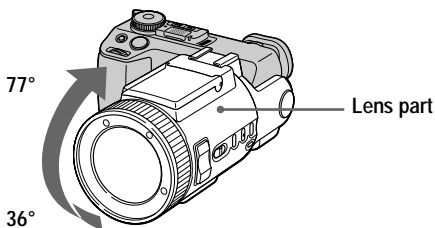

The indicators on the screen

Each time you press DISPLAY, the status of the screen changes as follows:

All indicators on
(All the available indicators are turned on.)



Indicators off
(Warning messages and manual adjustment items which are set using the jog dial are turned on.)

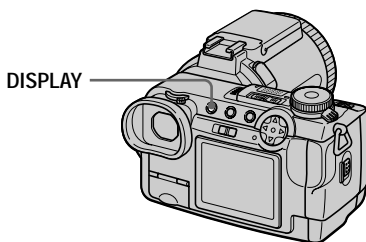

See page 109 for a detailed description of the indicated items.

Notes

- You cannot turn off the self-timer indicators and some of the indicators used in advanced operations.
- The indicators on the screen are not recorded.

Using the self-timer

When you use the self-timer function, the subject is recorded about 10 seconds after you press the shutter button.

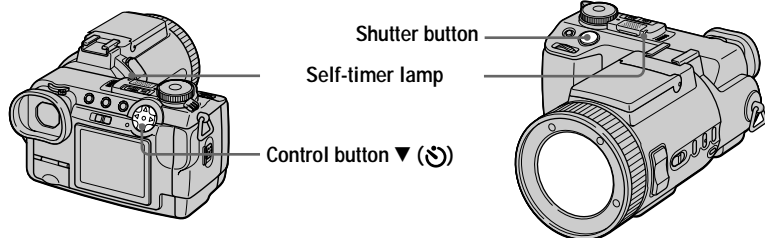

1. Turn off the menu (page 20).
2. Press the control button ▼ (⌚), then press the shutter button.

The ⌚ (self-timer) indicator appears on the screen, and about 10 seconds after you press the shutter button, the subject is recorded. The self-timer lamp flashes and a beep sounds after you press the shutter button until the shutter is released.

To cancel the self-timer recording

Press the control button ▼ (⌚) again.

Recording images with the flash

The flash automatically pops up and strobes when the surroundings are dark.

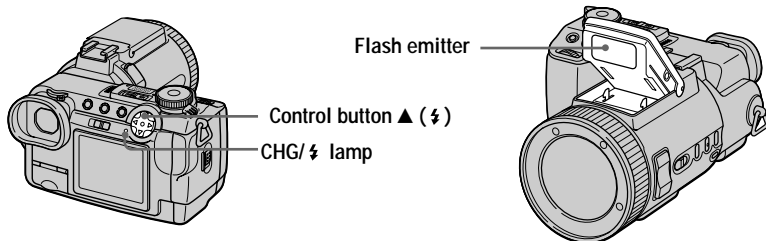

Turn off the menu (page 20), then press the control button ▲ (⚡) repeatedly so that the flash mode indicator appears on the screen.

Each time you press the control button ▲ (⚡), the indicator changes as follows.

(No indicator) → ⚡ → ⌚ → (No indicator)

⚡ Forced flash: The flash strobes regardless of the surrounding brightness.

⌚ No flash: The flash does not strobe.

“Auto (no indicator)” cannot be selected in some modes, depending on the mode dial setting.

Mode dial		Auto	⚡ Forced flash	⊘ No flash
		●	○	○
S		×	○	●
A		×	○	●
M		×	○	●
SCN	TWILIGHT	×	○	●
	LANDSCAPE	×	○	●
	PORTRAIT	●	○	○
(only for Clip Motion)		●	○	○

- : Default setting.
- : Can be selected.
- ×: Cannot be selected.

You can change the brightness of the flash with [⚡ ±] (FLASH LEVEL) in the menu settings (page 54).

To reduce the red-eye phenomenon

Set [RED EYE REDUCTION] to [ON] in the SET UP settings (page 92). The flash pre-strobes before recording to reduce the red-eye phenomenon. When [ON] is selected, appears on the screen.

Notes

- When [ISO] is set to [AUTO] in the menu settings, the recommended shooting distance using the built-in flash is 0.3 m to 4.5 m (11 7/8 inches to 177 1/4 inches). When it is not set to [AUTO], the flash may be ineffective even if the flash level is changed.
- Attaching a conversion lens (not supplied) blocks the light from the built-in flash or cause the lens shadow to appear.
- You cannot use an external flash (not supplied) and the built-in flash at the same time. When you mount an external flash, the weight makes it impossible to lock the lens portion. We recommend supporting the lens portion with your left hand or using a tripod for recording.
- Red-eye reduction may not produce the desired effects depending on individual differences, the distance to the subject, if the subject does not see the pre-strobe, or other conditions.
- The flash effect is not obtained easily when you use ⚡ forced flash in a bright location.
- While charging the flash, the CHG/⚡ lamp flashes. After the charging is complete, the lamp goes out.
- The flash does not function when recording moving images (MPEG movie) or recording in BURST 3 mode, in EXP BRKTG mode or in NightShot mode.
- ⚡ forced flash will be used when using the NightFraming function.

Recording images with the hologram AF

The hologram AF is fill light to focus on a subject easily. Set [HOLOGRAM AF] (page 92) to [AUTO] in the SET UP settings. **AF ON** appears on the screen and the hologram AF emits light when the shutter button is pressed halfway until the focus is locked.

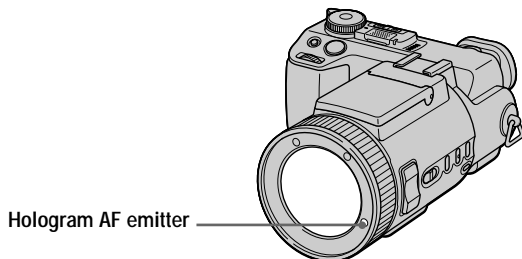

About Hologram AF

“Hologram AF (Auto-Focus),” an application of laser holograms, is a new AF optical system that enables still image shooting in dark places. Having gentler radiation than conventional high-brightness LEDs or lamps, the system satisfies Laser Class 1* specification and thus maintains higher safety for human eyes.

No safety problems will be caused by directly looking into the hologram AF emitter at a close range. However, it is not recommended to do so, because you may experience such effects like several minutes of image residual and dazzling, that you encounter after looking into a flashlight.

* Hologram AF satisfies Class 1 (time base 30,000 seconds), specified in all of JIS (Japan), IEC (EU), and FDA (US) industry standards. Complying with these standards identifies the laser product to be safe, under a condition that a human looks at the laser light either directly or even through a lens for 30,000 seconds.

Notes

- If hologram AF light does not reach the subject sufficiently or the subject has no contrast, focus will not be achieved. (An approximate distance of 4.5 m (177 1/4 inches) is recommended.)
- The hologram AF will not emit light in NightShot mode.
- In TWILIGHT mode of the scene selection function (page 65), the hologram AF will emit light only when the flash mode is set to  forced flash.
- The hologram AF will not emit light when the LANDSCAPE mode of the scene selection function (page 65) is selected or [CONVERSION LENS] is set to [ON] in the SET UP settings (page 93).
- Focus is achieved as long as hologram AF light reaches the subject even if its light is slightly out of the middle position of the subject.
- The hologram AF does not emit light when adjusting focus manually.
- Attaching a filter (not supplied) may interfere with the hologram AF light.
- If the hologram AF emitter is dirty, the hologram AF light may be dimmed and focus may not be achieved. In this case, wipe the hologram AF emitter with a dry cloth.

Shooting in the dark – NightShot

The NightShot function enables you to shoot a subject in a dark place such as camp scenes at night or for observation of nocturnal animals and plants.

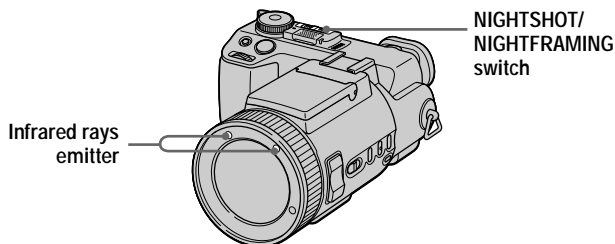

1 Set the mode dial to .

2 Set NIGHTSHOT/NIGHTFRAMING to NIGHTSHOT.

The  and “NIGHT SHOT” indicators light. The “NIGHT SHOT” indicator turns off after 5 seconds.

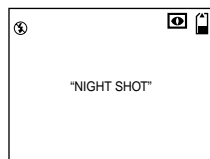

3 Press and hold the shutter button halfway down.

4 Press the shutter button fully down.



The image will be recorded on the “Memory Stick”.

To cancel the NightShot function
Set NIGHTSHOT/NIGHTFRAMING to .

While using the NightShot function, you cannot use the following functions:

- White balance
- Switching the metering mode
- AE LOCK
- Recording with hologram AF
- Recording with the flash

Notes

- Set the mode dial to . If the mode dial is set to any setting other than , the message “NIGHT SHOT IS INVALID” appears.
- Do not use the NightShot function in bright places (ex. outdoors in the daytime). This may cause your camera to malfunction.
- Images do not appear in the correct color while shooting with the NightShot function.
- If focusing is difficult with the auto focus mode when using the NightShot function, focus manually. The focus distance value does not appear.
- If you press an invalid key while using the NightShot function, the  indicator flashes, and the “NIGHT SHOT” indicator lights for 5 seconds.
- Filters (not supplied) may block the infrared rays. Be sure to use the recommended accessories.
- The recommended recording distance for the NightShot function is from 0.3 m to 4.5 m (11 7/8 inches to 177 1/4 inches).
- You cannot use the NightShot function when [CONVERSION LENS] is set to [ON] in the SET UP settings (page 93).

Shooting in the dark – NightFraming

The NightFraming function enables you to check a subject even at night and then record with natural colors using the flash.

1 Set the mode dial to .

2 Set NIGHTSHOT/NIGHTFRAMING to NIGHTFRAMING.

The  and “NIGHT FRAMING” indicators light. The “NIGHT FRAMING” indicator turns off after 5 seconds.

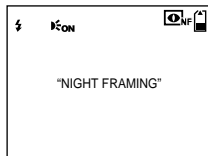

3 Press and hold the shutter button halfway down.

The hologram AF light (page 28) is emitted and the focus is automatically adjusted.

4 Press the shutter button fully down.

The shutter sounds, the flash strobes and the image is recorded.





To cancel the NightFraming function

Set NIGHTSHOT/NIGHTFRAMING to .

While using the NightFraming function, you cannot use the following functions:

- White balance
- Switching the metering mode
- AE LOCK
- Manual focus

■ Notes

- Set the mode dial to . If the mode dial is set to any setting other than , the message “NIGHT FRAMING IS INVALID” appears.
- When you press the shutter button halfway down you will hear a sound, but this is not the sound of the shutter releasing. The image is not recorded yet.
- You cannot use the NightFraming function to record moving images.
- The flash does not function when recording in BURST 3 and in EXP BRKTG modes.
- If you rotate the focus ring while using the NightFraming function, the  indicator flashes and “MANUAL FOCUS IS INVALID” appears on the screen.
- If you perform any other invalid operation while using the NightFraming function, the  indicator flashes and the “NIGHT FRAMING” indicator lights for 5 seconds.
- Filters (not supplied) may block the infrared rays. Be sure to use the recommended accessories.
- The recommended recording distance for the NightFraming function is from 0.3 m to 4.5 m (11 7/8 inches to 177 1/4 inches).
- You cannot use the NightFraming function when [CONVERSION LENS] is set to [ON] in the SET UP settings (page 93).

Recording moving images

Moving images with audio are recorded in MPEG format (page 52).

To record moving images, slide the **POWER** switch in the direction of the arrow to turn on the power and insert a “Memory Stick.”

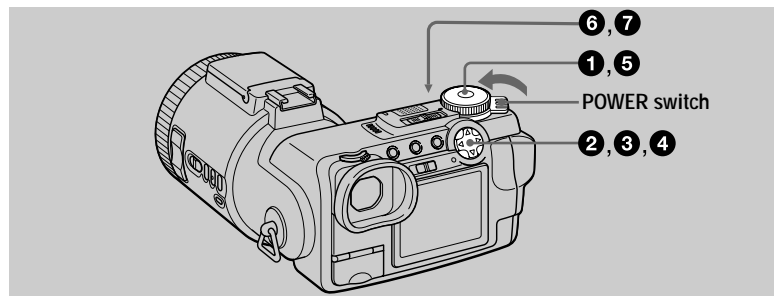

1 Set the mode dial to **SET UP**.

2 Select [**📷**] (**CAMERA**) with **▲/▼** on the control button, then press **▶**.

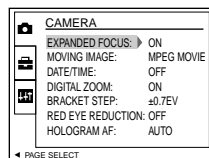

3 Select [**MOVING IMAGE**] with **▲/▼** on the control button, then press **▶**.

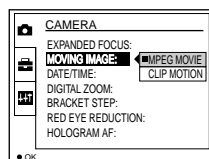

4 Select [**MPEG MOVIE**] with **▲/▼** on the control button, then press the center **●**.

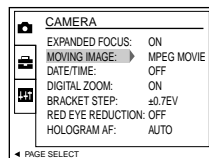

5 Set the mode dial to **📷**.

You are now ready to record moving images.

6 Press the shutter button fully down.
“REC” appears on the screen, and recording of the image and sound on the “Memory Stick” begins.

7 Press the shutter button fully down again to stop recording.
The recording stops.
When selecting the 320 (HQ) size: The recording stops in approximately 15 seconds.
When selecting the 320×240 or 160×112 sizes: The recording stops when the “Memory Stick” is full.
For details on the image size, see “Setting the image size (IMAGE SIZE)” on page 60.

Using the self-timer

When you use the self-timer function, recording starts about 10 seconds after you press the shutter button.

1. Turn off the menu (page 20).
2. Press the control button ▼ (⊙), then press the shutter button.
The ⊙ (self-timer) indicator appears on the screen, and the recording starts about 10 seconds after you press the shutter button. The self-timer lamp flashes and a beep sounds after you press the shutter button until the shutter is released.

To cancel the self-timer recording

Press the control button ▼ (⊙) again.

Shooting in the dark – NightShot

The NightShot function enables you to shoot a subject in a dark place such as camp scenes at night or for observation of nocturnal animals and plants.

Set NIGHTSHOT/NIGHTFRAMING switch to NIGHTSHOT.

The ⊠ and “NIGHT SHOT” indicators light. The “NIGHT SHOT” indicator turns off after 5 seconds.

To cancel the NightShot function

Set NIGHTSHOT/NIGHTFRAMING to ●.

While using the NightShot function, you cannot use the following functions:

- White balance
- Switching the metering mode
- AE LOCK

Notes

- Do not use the NightShot function in bright places (ex. outdoors in the daytime). This may cause your camera to malfunction.
- Images do not appear in the correct color while shooting with the NightShot function.
- If focusing is difficult with the auto focus mode when using the NightShot function, focus manually. The focus distance value does not appear.
- If you press an invalid key while using the NightShot function, the  indicator flashes, and the “NIGHT SHOT” indicator lights for 5 seconds.
- Filters (not supplied) may block the infrared rays. Be sure to use the recommended accessories.
- The recommended recording distance for the NightShot function is from 0.3 m to 4.5 m (11 7/8 inches to 177 1/4 inches).
- You cannot use the NightShot function when [CONVERSION LENS] is set to [ON] in the SET UP settings (page 93).

Indicators during recording

Each time you press DISPLAY, the status of the screen changes as follows:
all indicators on \longleftrightarrow indicators off.

These indicators are not recorded.

See page 110 for a detailed description of the indicators.

Note

When using the camera for long periods, use the AC power adaptor. If you remove the battery pack or otherwise turn off the power partway through a recording, the moving image recorded thus far is not saved. When the  mark appears while operating the camera, stop the recording at this point before the battery completely runs out.

Playing back still images

To play back still images, slide the **POWER** switch in the direction of the arrow to turn on the power and insert a “Memory Stick.”

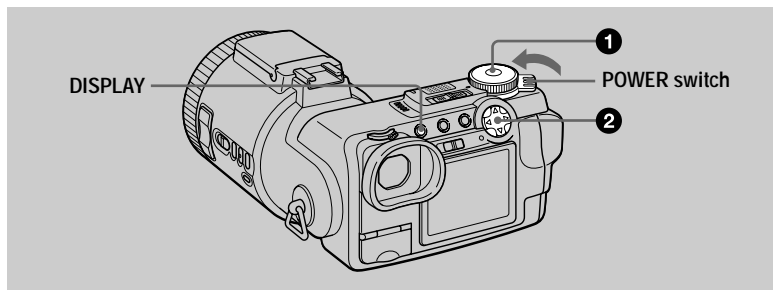

1 Set the mode dial to .

The last recorded image (still or moving) appears on the screen.

2 Select the desired still image with the control button / .

: To display the preceding image.

: To display the next image.

You can select the image with the jog dial (page 59).

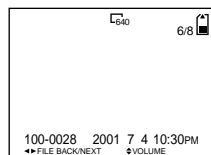

Notes

- You might not be able to correctly play back images recorded with this camera on other equipment.
- You cannot play back images on this camera which are larger than the maximum image size that can be recorded with this camera.
- A rough image is played back, followed by the normal image.

Indicators during still image playback

Each time you press **DISPLAY**, the status of the screen changes as follows:
all indicators on  indicators off.

See page 111 for a detailed description of the indicators.

Playing back moving images

To play back moving images, slide the **POWER** switch in the direction of the arrow to turn on the power and insert a “Memory Stick.”

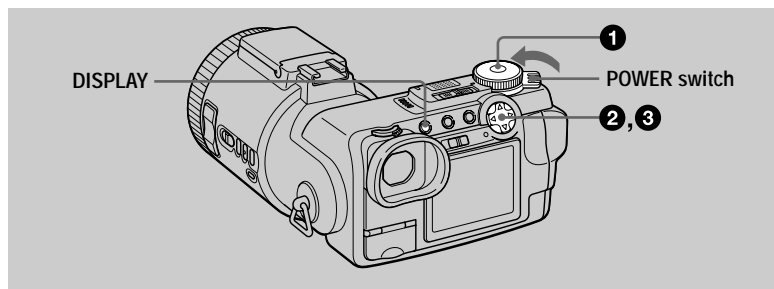



1 Set the mode dial to .

The last recorded image (still or moving) appears on the screen.

2 Select the desired moving image with the control button / .

Moving images are displayed one-size smaller than still images.

: To display the preceding image.

: To display the next image.

You can select the image with the jog dial (page 59).

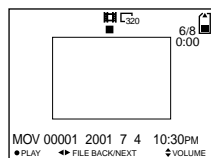

3 Press the center  on the control button to start the playback.

The moving image and sound are played back.

During playback,  (playback) appears on the screen.

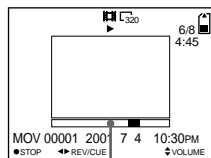



Playback bar

To pause playback

Press the center  on the control button to pause the playback.

To advance or rewind the moving image

Press the control button /  during playback.

To return to normal playback, press the center  on the control button.

Moving images recorded with the image of [320 (HQ)]
(page 60)

The images are displayed over the entire screen.

Adjusting the volume

Press the control button ▲/▼ to adjust the volume.

Indicators during moving image playback

Each time you press DISPLAY, the status of the screen changes as follows:
all indicators on ↔ indicators off.

See page 111 for a detailed description of the indicators.

Viewing images using a computer

You can view data recorded with your camera on a computer, and modify and attach it to e-mail using application software. This section describes the method for viewing images on a computer using the supplied USB cable.

The USB cable is used to connect the camera to a computer so that operations can be performed on image files recorded in a “Memory Stick” from the computer. In order to use the USB cable, a USB driver must be installed in the computer beforehand.

Be sure to also refer to the operation manuals for your computer and the application software.

There are two ways to make the USB connection, which are the normal connection and the PTP connection. This is set using [USB CONNECT] in the SET UP settings (page 94). The factory setting is [NORMAL].

This section describes the way using the [NORMAL] setting. Users will be informed at the Sony website when PTP connection is supported.

Viewing images on Windows: page 39

Viewing images on Macintosh: page 48

Notes on using your computer: page 50

Notes

- Data recorded with your camera is stored in the following formats. Make sure that applications that support these file formats are installed on your computer.
 - Still images (other than uncompressed mode): JPEG format
 - Moving images/audio: MPEG format
 - Uncompressed mode still images: TIFF format
 - Clip Motion: GIF format
- Depending on your application software, the file size may increase when you open a still image file.
- When you copy an image to the camera from your computer, which was modified with retouching software and was converted to another file format, the “FILE ERROR” message may appear and you may be unable to open the image.
- Depending on your application software, only the first frame of the Clip Motion file may be played back.
- **Communications with your computer (for Windows only)**
Communications between your camera and your computer may not recover after recovering from Suspend or Sleep.

- Microsoft, Windows and Windows Media are either registered trademarks or trademarks of Microsoft Corporation in the United States and/or other countries.
- Macintosh, Mac OS and QuickTime are either registered trademarks or trademarks of Apple Computer, Inc.
- All other product names mentioned herein may be the trademarks or registered trademarks of their respective companies. Furthermore, “™” and “®” are not mentioned in each case in this manual.

Viewing images on Windows

Recommended computer environment

- OS: Microsoft Windows 98, Windows 98SE, Windows 2000 Professional, Windows Millennium Edition
The above OS must be installed at the factory.
Operation is not assured in an environment upgraded to the operating systems described above.
- CPU: MMX Pentium 200 MHz or faster
The USB connector must be provided as standard.
Windows Media Player (recommended) must be installed (to play back moving pictures).

Notes

- If you connect two or more USB equipment to a single computer at the same time, some equipment may not operate depending on the type of USB equipment.
- Operations are not guaranteed when using a hub.
- Operations are not guaranteed for all the recommended computer environments mentioned above.

Installing the USB driver to the computer

Before connecting your camera to your computer, install the USB driver to the computer. The USB driver is included with the application software in the CD-ROM which is supplied with your camera.

Caution

Be sure to complete installation of the USB driver before connecting your camera to the computer. If you connect the USB cable first, you will be unable to install the USB driver properly.

See page 42 for corrective measures if the USB cable was connected before installing the driver and the driver software could not be installed correctly.

1 Turn on your computer and allow Windows to load.

Do not connect the USB cable in this step.

- Close down all applications running on the computer.

- 2** Insert the supplied CD-ROM in the CD-ROM drive of your computer.

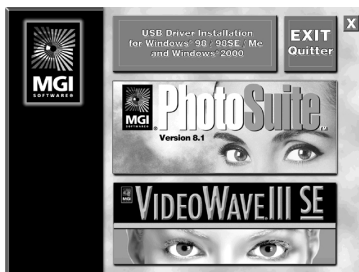

The title screen appears after a moment.

If the title screen does not appear

- 1 Double-click "My Computer."
- 2 Double-click the CD-ROM ("PhotoSuite (E:)*").

* The drive symbol ((E:), etc.) may differ depending on your computer.

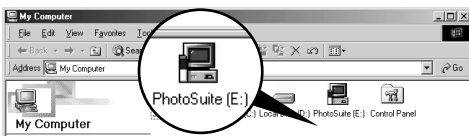

→ The title screen appears after a moment.

- 3** Move the arrow (mouse pointer) to "USB Driver Installation for Windows 98/98SE/Me and Windows 2000" in the title screen and click the left button of the mouse.

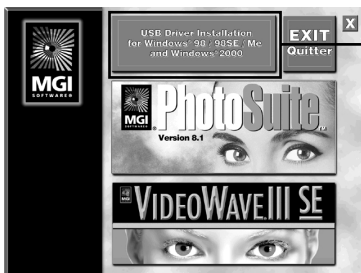

Left-click here.

→ The Install Wizard program starts and the "InstallShield Wizard" screen appears.

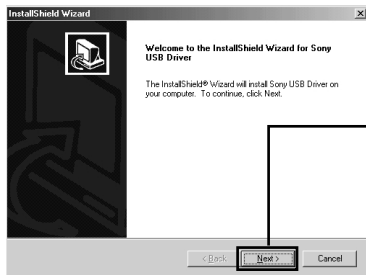
4 Left-click “Next.”

Left-click “Next.”

→ Installation starts. When installation finishes, a screen indicating that installation has been completed appears.

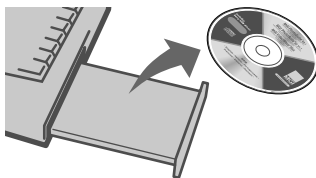
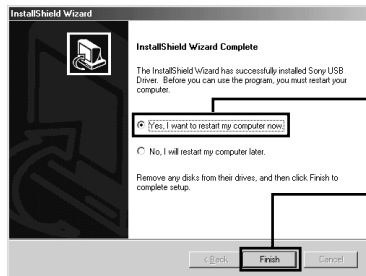
5 Eject the CD-ROM from the computer.**6** Follow the on-screen messages to quit the InstallShield Wizard.

① Select “Yes, I want to restart my computer now.”

② Left-click “Finish.”

→ The computer turns off and then immediately on again (restart). The USB driver is enabled after restarting.

If you cannot install the USB driver

Another USB driver may already be installed. Follow the procedure on page 44 to connect the camera and then try the following steps.

For Windows 98, Windows 98SE and Windows Me users:

The screens shown below are taken from Windows Me.

1 Display the “System Properties” screen.

The “System Properties” screen appears.

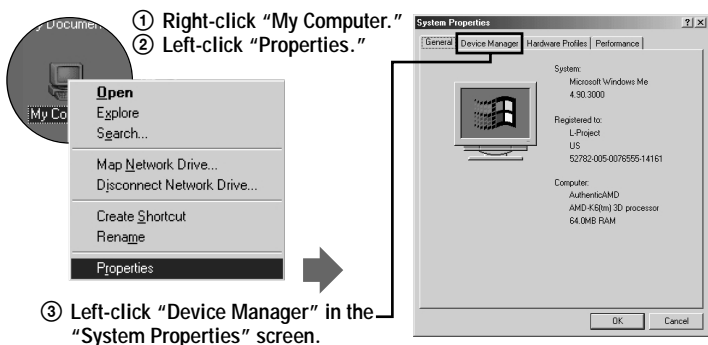

2 Check whether a USB driver is already installed.

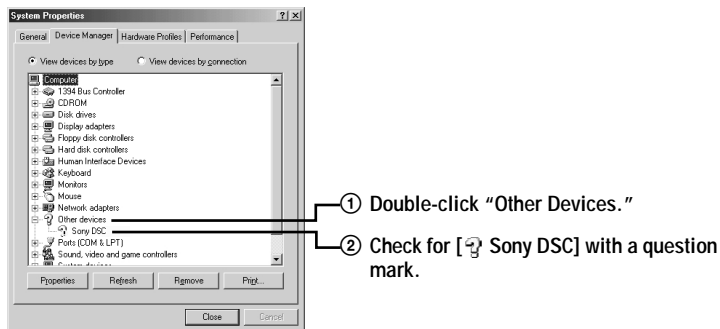

3 If a USB driver is installed, remove it.

If the check in step 2 shows [?] Sony DSC] in the “Other Devices” list, another USB driver is already installed in your computer. In this case, the driver must be removed and then installed again. The removal procedure is as follows.



1 Left-click [?] Sony DSC].

2 Left-click “Remove.” The “Confirm Device Removal” screen appears.

3 Left-click “OK” to remove the driver.

For Windows 2000 Professional users:

Log in with the permission of administrator.

- 1** Right-click “ My Computer,” then left-click “Properties”.
The “System Properties” screen appears.
- 2** Left-click “Hardware,” then left-click “Device Manager.”
- 3** Left-click “View” in “Device Manager,” then left-click “Devices by type.”
- 4** Right-click [ Sony DSC] in “ Other devices,” then left-click “Delete.”

Perform the operations starting over from step **1** (page 39) to reinstall the USB driver.

- 7** Open the jack cover on the camera and insert the USB cable connector into the USB jack (mini-B) as far as it will go.

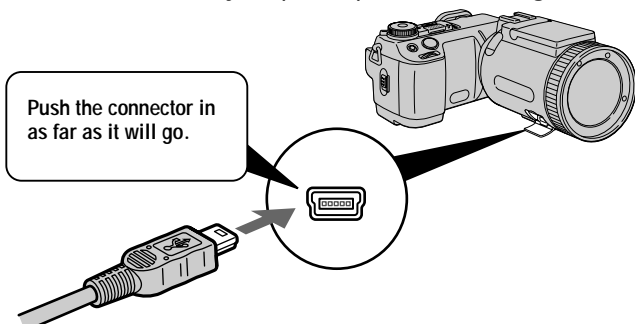

- 8** Connect the other USB cable connector to the USB jack on your computer.

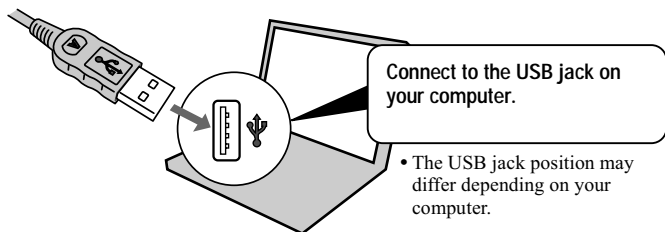

9 Prepare your camera.

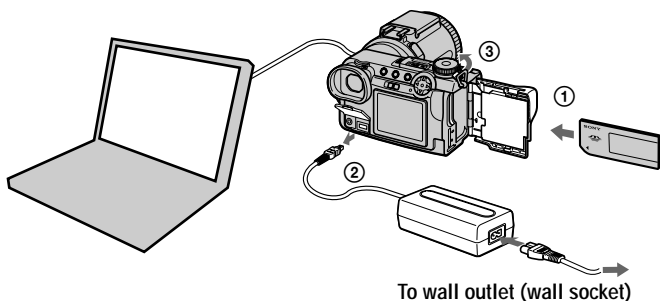

- ① Insert a “Memory Stick” into your camera.
- ② Connect the AC power adaptor to your camera.
- ③ Turn on your camera.

“USB MODE” appears on the screen of your camera.

When you first connect the camera, the Device Manager automatically starts twice in succession to allow your computer to recognize the camera. There is no need to operate either your computer or the camera during this period. Be sure to wait until the Device Manager has started twice.

- If “USB MODE” does not appear after finishing step ③, check [USB CONNECT] in the SET UP settings, and change the setting to [NORMAL] if it is different.

Notes

- Do not connect the USB cable before the USB driver installation is completed in step ⑥.
- In step ⑨, make sure that a “Memory Stick” is inserted into your camera before turning on the camera. Otherwise, your computer will be unable to recognize the camera.

Viewing images

When viewing moving images on a Windows system, Windows Media Player or other moving image playback applications must be installed.

Example: Viewing still images

The procedure is the same as for viewing moving images and other image data.

- ① Turn on your computer and allow Windows to load.

- 2** Open the jack cover on the camera and insert the USB cable connector into the USB jack (mini-B) as far as it will go.

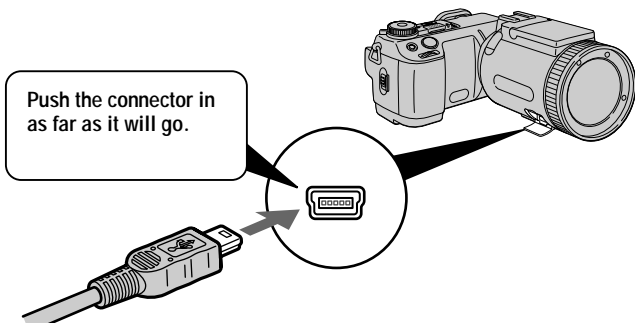

- 3** Connect the other USB cable connector to the USB jack on your computer.

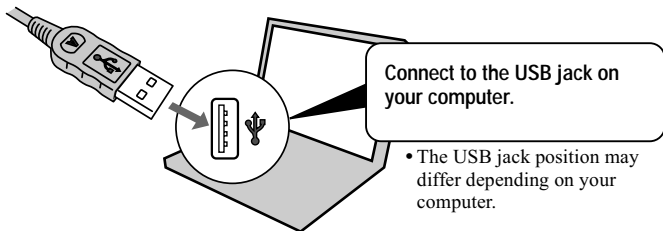

- 4** Insert a “Memory Stick” into your camera, and connect the AC power adaptor to your camera and then to a wall outlet (wall socket).

- 5** Turn on the power of your camera.
“USB MODE” appears on the screen of the camera.

- 6** Double-click “My Computer.”

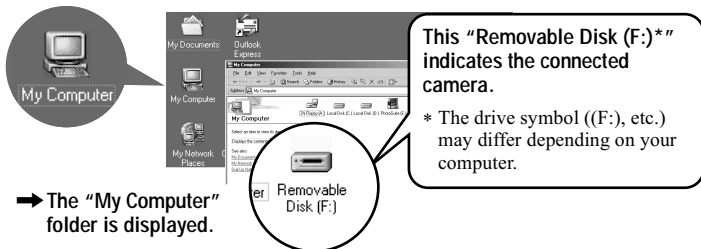

7 Double-click the newly recognized drive.

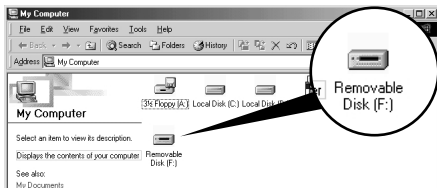

Double-click the "Removable Disk (F:)" folder.

→ The "Removable Disk (F:)" folder contents are displayed.

8 Double-click the "DCIM" folder.

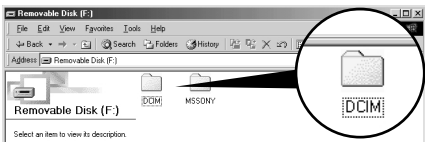

→ The "DCIM" folder contents are displayed.

9 Double-click the "100MSDCF" folder.

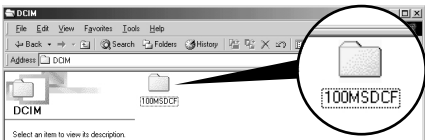

→ The "100MSDCF" folder contents are displayed.

10 Double-click the image.

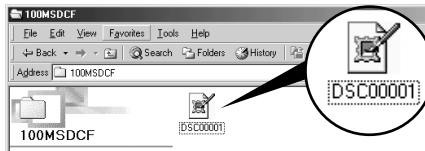

→ The image is displayed.

Desired file type	Double-click in this order
Still image	“Dcim” folder → “100msdcf” folder → Image file
Moving image*	“Mssony” folder → “Moml0001” folder → Image file*
Audio in Voice mode*	“Mssony” folder → “Momlv100” folder → Audio file*
Clip Motion image	“Dcim” folder → “100msdcf” folder → Image file
E-mail image TIFF image (uncompressed)	“Mssony” folder → “Imcif100” folder → Image file

* Copying a file to the hard disk of your computer before viewing it is recommended. If you play back the file directly from the “Memory Stick”, the image and sound may break off.

To copy the image data to your computer

Drag and drop the image data to the “My Documents” (example) folder.

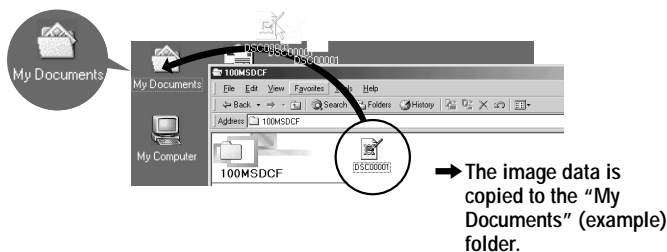

Viewing images on Macintosh

Recommended computer environment

OS: Mac OS 8.5.1/8.6/9.0/9.1, Mac OS X

The above OS must be installed at the factory.

However, note that the upgrade to Mac OS 9.0/9.1 should be used for the following models.

- iMac with the Mac OS 8.6 factory pre-installed and a slot loading type CD-ROM drive
- iBook or Power Mac G4 with the Mac OS 8.6 factory pre-installed

The USB connector must be provided as standard.

QuickTime 3.0 or newer must be installed (to play back moving pictures).

Notes

- If you connect two or more USB equipment to a single computer at the same time, some equipment may not operate depending on the type of USB equipment.
- Operations are not guaranteed when using a hub.
- Operations are not guaranteed for all the recommended computer environments mentioned above.

Installing the USB driver to the computer

For Mac OS 9.1, Mac OS X users

It is not necessary to install the USB driver. The Macintosh recognizes the camera as a drive simply by connecting it to the Macintosh with the USB cable.

For Mac OS 8.5.1/8.6/9.0 users

Follow the procedures below to install the driver.

- 1 Turn on your computer and allow the Mac OS to load.**
- 2 Insert the supplied CD-ROM in the CD-ROM drive of your computer.**
- 3 Double-click the CD-ROM drive icon to open the window.**
- 4 Double-click the icon of the hard disk containing the OS to open the window.**
- 5 Move the following two files from the window opened in step 3 to the "System Folder" icon in the window opened in step 4 (drag and drop).**
 - Sony USB Driver
 - Sony USB Shim

-
- 6 When “Put these items into the Extensions folder?” appears, click “OK.”
-
- 7 Restart your computer.
-

Viewing images

When viewing moving images on a Macintosh system, QuickTime 3.0 or later must be installed.

-
- 1 Turn on your computer and allow the Mac OS to load.
-
- 2 Open the jack cover on the camera and insert the USB cable connector into the USB jack (mini-B) as far as it will go.
-
- 3 Connect the other USB cable connector to the USB jack on your computer.
-
- 4 Insert a “Memory Stick” into your camera, and connect the AC power adaptor to your camera and then to a wall outlet (wall socket).
-
- 5 Turn on the power of your camera.
“USB MODE” appears on the screen of the camera.
-
- 6 Double click the newly recognized icon on the desktop.
The folders inside the “Memory Stick” are displayed.
-
- 7 Select and double-click the desired image/sound file from the folder.
-

Notes on using your computer

“Memory Stick”

- Operation is not guaranteed if you are using a “Memory Stick” that was formatted with a computer, or if you used a computer to format the “Memory Stick” in your camera through a USB connection.
- Do not optimize the “Memory Stick” on a Windows machine. This will shorten the “Memory Stick” life.
- Do not compress the data on the “Memory Stick.” Compressed files cannot be played back on your camera.

Software

- Depending on your application software, the file size may increase when you open a still image file.
- When you load an image modified using the supplied retouch software from your computer to the camera or when you directly modify the image on the camera, the image format will differ so the “FILE ERROR” message may appear and you may be unable to open the file.
- Depending on your application software, only the first frame of the Clip Motion file may be played back.

For Windows Me and Windows 2000 users

The following procedures are recommended when disconnecting the USB cable from your computer or ejecting the “Memory Stick” from the camera while it is connected to your computer.

- 1** Stop the drive by clicking on the “Unplug/Eject” icon in the task tray.
- 2** When the message appears confirming the safe removal of the hardware, disconnect the USB cable or eject the “Memory Stick.”

Communications with your computer (for Windows only)

Communications between your camera and your computer may not recover after recovering from Suspend or Sleep.

For Mac OS X users

Turn off your computer before disconnecting the USB cable from the computer or removing the “Memory Stick.”

Image file storage destinations and image files

Image files recorded with your camera are grouped in folders by recording mode. The meanings of the file names are as follows. □□□□ stands for any number within the range from 0001 to 9999.

For Windows Me users (The drive recognizing the camera is "F.")

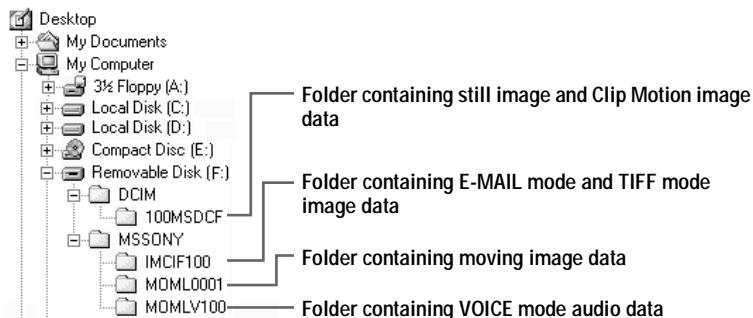

Folder	File	Meaning
100MSDCF	DSC0□□□□.JPG	<ul style="list-style-type: none"> • Still image file recorded normally • Still image file recorded in <ul style="list-style-type: none"> – E-MAIL mode (page 67) – TIFF mode (page 69) – VOICE mode (page 68) – BURST 3 mode (page 66)
	CLP0□□□□.GIF	• Clip Motion file recorded in NORMAL mode (page 70)
	CLP0□□□□.THM	• Index image file of Clip Motion file recorded in NORMAL mode
	MBL0□□□□.GIF	• Clip Motion file recorded in MOBILE mode (page 70)
	MBL0□□□□.THM	• Index image file of Clip Motion file recorded in MOBILE mode

Folder	File	Meaning
IMCIF100	DSC0□□□□.JPG	• Small-size image file recorded in E-MAIL mode (page 67)
	DSC0□□□□.TIF	• Uncompressed image file recorded in TIFF mode (page 69)
MOML0001	MOV0□□□□.MPG	• Moving image file recorded normally
MOMLV100	DSC0□□□□.MPG	• Audio file recorded in VOICE mode (page 68)

■ Notes

- The numerical portions of the following files are the same.
 - A small-size image file recorded in E-MAIL mode and its corresponding image file
 - An uncompressed image file recorded in TIFF mode and its corresponding image file
 - An audio file recorded in VOICE mode and its corresponding image file
 - An image file recorded with Clip Motion and its corresponding index image file
- Do not change folder and file names on your computer. If the name is changed, the camera may be unable to open that folder or file.

Tips

The digital still camera saves recorded images as digital data. The format of the saved data is called as the file format. The formats that can be used with this camera are as follows:

JPEG format

Most digital still cameras, computer operating systems, and browser software adopt this format. This format is able to compress files without appreciable deterioration. However, if the image is compressed and saved on repeated occasions, the image quality will deteriorate. This camera records still images using the JPEG format for normal recording.

GIF format

Using this format, the image quality will not deteriorate even if the image is compressed and saved on repeated occasions. This format limits the number of colors to 256 colors. This camera records still images using the GIF format in Clip Motion (page 70).

TIFF format

Stores shot images without compression, so the image quality does not deteriorate. Most operating systems and applications support this format. This camera records still images using the TIFF format for the TIFF mode (page 69).

MPEG format

This format is very typical for moving images. This camera records audio using the MPEG format for the moving image recordings and the VOICE mode (page 68).

Before performing advanced operations

The operation methods that are frequently used for “Advanced operations” are described below. For mode dial and control button usage, see page 19.

Changing the settings

Setting up the items in the SET UP

1 Set the mode dial to SET UP.

The SET UP screen appears.

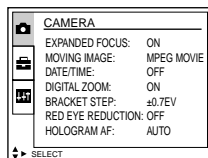

2 Press ▲/▼/◀/▶ on the control button to select the item you want to set up.

The selected item turns yellow.

3 Press the center ● on the control button to enter the item.

For the description of the SET UP items, see page 92.

Setting up the items in the menu

1 Set the mode dial to 📷, SCN, S, A, M, 📐 or ▶.

2 Press MENU.

The menu appears.

3 When the mode dial is set to ▶:

① Press ◀/▶ on the control button to select the item you want to set.

The selected setting turns yellow.

② Press the center ● on the control button to enter the item.

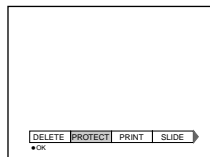

When the mode dial is set to 📷, SCN, S, A, M or 📐:

Press ▲/▼/◀/▶ on the control button to select the setting of the item.

The selected setting turns yellow and the setup is complete.

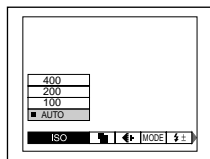





Menu settings

Menu items that can be modified differ depending on the positions of the mode dial. The screen shows only the items you can operate at the moment. Default settings are indicated with ■.

When the mode dial is set to /S/A/M

Item	Setting	Description
ISO	400 200 100 ■AUTO	Selects the ISO film speed. When recording under dark conditions or recording a fast-moving subject, use a high-number setting. To record high-quality images, use a low-number setting.
(IMAGE SIZE)	■2560×1920 2560 (3:2) 2048×1536 1280×960 640×480	Selects the image size when recording still images (page 60).
(P. QUALITY)	■FINE STANDARD	Selects the JPEG compression method. Select [FINE] for high-quality images.
MODE (REC MODE)	TIFF	Records a TIFF (uncompressed) file in addition to the JPEG file (page 69).
	VOICE	Records an audio file (with a still image) in addition to the JPEG file (page 68).
	E-MAIL	Records a small-size (320×240) JPEG file in addition to the selected image size (page 67).
	EXP BRKTG	Records three images with the exposure value of each image slightly shifted (page 66).
	BURST 3	Records three images continuously (page 66).
	■NORMAL	Records an image using the normal recording mode.
± (FLASH LEVEL)	HIGH	Makes the flash level higher than normal.
	■NORMAL	Normal setting.
	LOW	Makes the flash level lower than normal.
PFX (P. EFFECT)	SOLARIZE SEPIA NEG.ART ■OFF	Sets the image special effects (page 75).
(SHARPNESS)	+2 +1 ■ 0 -1 -2	Adjusts the sharpness of the image. The indicator appears (except when the setting is 0).





When the mode dial is set to SCN

Item	Setting	Description
SCN	<input checked="" type="checkbox"/> TWILIGHT LANDSCAPE PORTRAIT	Sets the scene selection mode (page 65).
 (IMAGE SIZE)	<input checked="" type="checkbox"/> 2560×1920 2560 (3:2) 2048×1536 1280×960 640×480	Selects the image size when recording still images (page 60).
 (P. QUALITY)	<input checked="" type="checkbox"/> FINE STANDARD	Selects the JPEG compression method. Select [FINE] for high-quality images.
MODE (REC MODE)	TIFF	Records a TIFF (uncompressed) file in addition to the JPEG file (page 69).
	VOICE	Records an audio file (with a still image) in addition to the JPEG file (page 68).
	E-MAIL	Records a small-size (320×240) JPEG file in addition to the selected image size (page 67).
	EXP BRKTG	Records three images with the exposure value of each image slightly shifted (page 66).
	BURST 3	Records three images continuously (page 66).
 (FLASH LEVEL)	HIGH	Makes the flash level higher than normal.
	<input checked="" type="checkbox"/> NORMAL	Normal setting.
	LOW	Makes the flash level lower than normal.
PFX (P. EFFECT)	SOLARIZE SEPIA NEG.ART <input checked="" type="checkbox"/> OFF	Sets the image special effects (page 75).
 (SHARPNESS)	+2 +1 <input checked="" type="checkbox"/> 0 -1 -2	Adjusts the sharpness of the image. The  indicator appears (except when the setting is 0).



When the mode dial is set to  (MOVING IMAGE is set to MPEG MOVIE in the SET UP settings.)

Item	Setting	Description
 (IMAGE SIZE)	320 (HQ) 320×240 ■ 160×112	Selects the MPEG image size when recording moving images (page 60).
PFX (P. EFFECT)	SOLARIZE SEPIA NEG.ART ■ OFF	Sets the image special effects (page 75).

When the mode dial is set to  (MOVING IMAGE is set to CLIP MOTION in the SET UP settings.)

Item	Setting	Description
 (IMAGE SIZE)	■ NORMAL MOBILE	Selects the Clip Motion image size (page 70).
 (FLASH LEVEL)	HIGH	Makes the flash level higher than normal.
	■ NORMAL	Normal setting.
	LOW	Makes the flash level lower than normal.
PFX (P. EFFECT)	SOLARIZE SEPIA NEG.ART ■ OFF	Sets the image special effects (page 75).
 (SHARPNESS)	+2 +1 ■ 0 -1 -2	Adjusts the sharpness of the image. The  indicator appears (except when the setting is 0).

When the mode dial is set to 

Item	Setting	Description
DELETE	OK	Deletes the displayed image (page 83).
	CANCEL	Cancels deleting of the image.
PROTECT	–	Protects images against accidental erasure (page 84).
PRINT	–	Marks the print mark on still images (page 88).
SLIDE*	INTERVAL	Sets the slide show interval. ■ 3 sec/5 sec/10 sec/30 sec/1 min
	REPEAT	■ ON/OFF
	START	Starts the slide show.
	CANCEL	Cancels the slide show.
COPY	OK	Copies an image (page 87).
	CANCEL	Cancels copying of the image.
RESIZE*	2560×1920 2048×1536 1280×960 640×480	Changes the recorded still image size (page 86).
	CANCEL	Cancels changing of the recorded image size.
ROTATE*	  OK	Rotates the still image 90° (page 81).
	CANCEL	Cancels rotation of a still image.
DIVIDE*	OK	Divides a moving image (page 90).
	CANCEL	Cancels division of a moving image.

* Only in single-image mode.

How to use the jog dial

The functions which are used frequently in recording are set up using the jog dial and the following direct buttons. The jog dial is used to change the value in manual adjustments.

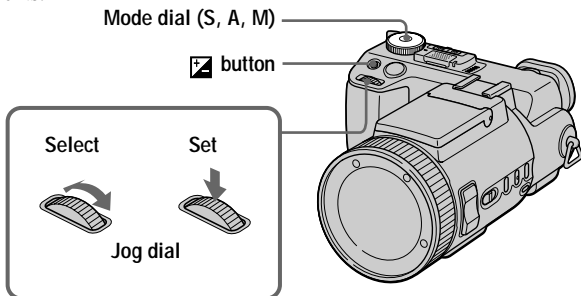

- 1 Set the mode dial to S, A, or M.**
The adjustable value appears at the right corner on the screen.
- 2 Turn the jog dial to select the item you want to adjust.**
Move the yellow indication ◀ to select the item.

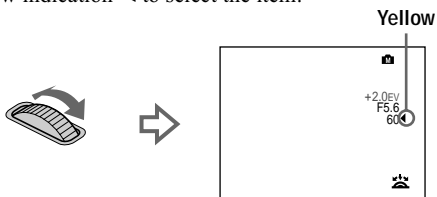

- 3 Press the jog dial.**
The value turns yellow.

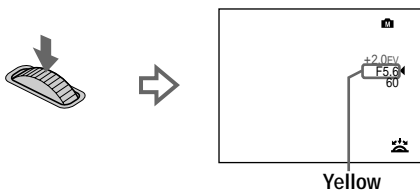

- 4 Turn the jog dial to select the value you want to set.**
When you adjust only the value, the adjustment is complete. If you want to change other items, press the jog dial, then select the item.

Viewing the next/previous image using the jog dial during playback

When the mode dial is set to , you can easily view the next/previous image by turning the jog dial.

Setting the image size (IMAGE SIZE)

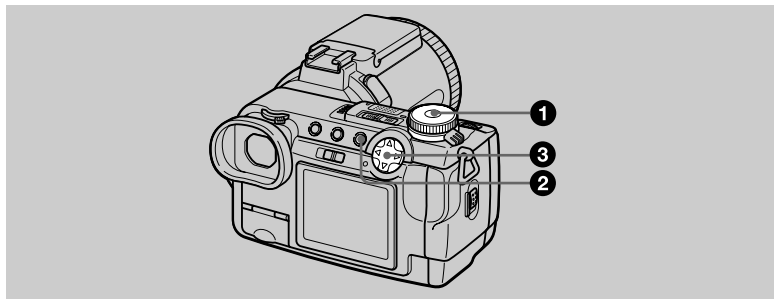

- 1** Set the mode dial to , SCN, S, A, M, or .
- 2** Press MENU.
The menu appears.
- 3** Select [] (IMAGE SIZE) with / , then select the desired image size with / .

Still image sizes:

2560×1920: 5.0 mega pixels

2560 (3:2)*

2048×1536: 3.0 mega pixels

1280×960: 1.3 mega pixels

640×480: 0.35 mega pixels

* The image is recorded in the ratio of three to two to fit the printing paper size. Using this image size, the margin of an image is not printed out. However, a slight amount of the upper and lower black portions are displayed on the screen.

The larger the numbers for the image size are, the larger the file will be, and the fewer images that can be recorded on one “Memory Stick.” For details on how many images can be recorded, refer to page 61.

Moving image (MPEG movie) sizes:

320 (HQ)*, 320×240, 160×112

* High Quality mode

Clip Motion sizes:

NORMAL (160×120), MOBILE (120×108)

Examples of use and the number of images* or the time that you can record on a “Memory Stick” (16 MB) for each image size**

Still images:

Image size	Usage	Quality	
		STANDARD	FINE
2560×1920	Modifying images (emphasis on image quality)	Approx. 11	Approx. 6
2560 (3:2)	Printing in 3:2 ratio	Approx. 11	Approx. 6
2048×1536	Modifying images	Approx. 18	Approx. 10
1280×960	Printing in post card size	Approx. 44	Approx. 24
640×480	Attaching to e-mail	Approx. 240	Approx. 96

Moving images:

Image size	Usage	Number of images or time
320 (HQ)	Viewing on TV	Approx. 40 sec.
320×240	Viewing on computer	Approx. 160 sec.
160×112	Attaching to e-mail	Approx. 640 sec.
MOBILE (120×108) (2 frames)	—	Approx. 450
NORMAL (160×120) (10 frames)	—	Approx. 80

* When [MODE] (REC MODE) is set to [NORMAL].

** The maximum recording time in continuous recording.

The number of recordable images or recordable time

The actual number of images or recordable time may differ depending on the recording conditions.

► Various recording



Recording with the exposure fixed (AE LOCK)

Mode dial:  / S / A / M / SCN / 

Once you press AE LOCK, the exposure, now captured, is fixed. For instance, this function is convenient in the following use:

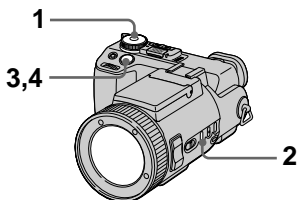
Measure the exposure of the desired portion of the subject using the spot metering function and fix its exposure value by pressing AE LOCK. Then, recompose the picture.



1 Set the mode dial to , S, A, M, SCN or .

2 Target the subject that has desired exposure value, then press AE LOCK.

The exposure is fixed and the AE-L mark appears.

3 Target the subject you want to record and press and hold the shutter button halfway down.

The focus is automatically adjusted.

Once you remove your finger from the shutter, AE LOCK is released.

4 Press down the shutter button.

Once you press the shutter button, AE LOCK is automatically released.

To release AE LOCK

Carry out one of the followings:

- Press AE LOCK again after step **2**.
- Release your finger from the shutter button after step **3**.

Recording with the manual adjustments

Mode dial: S/A/M

Shutter speed priority mode

Once the shutter speed is adjusted manually, the aperture will be automatically adjusted to the suitable value to attain correct exposure according to the brightness of the subject. Using the higher shutter speed, you can record a fast-moving subject with its motion frozen. And using the lower shutter speed, you can record the flow motion of a moving subject.

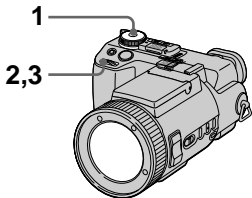

- 1 Set the mode dial to S.
- 2 Select a shutter speed with the jog dial, then press the jog dial.

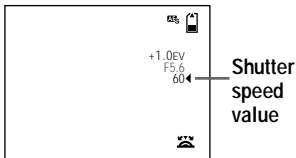

- 3 Select the desired shutter speed value, then press the jog dial.

The shutter speed can be selected from 30" to 1/1000.

If you select a shutter speed of 2.5 seconds or slower, NR is displayed before the shutter speed and the NR slow shutter mode is automatically activated.

NR slow shutter

The NR slow shutter function removes noise from recorded images to provide clean, crisp images. Using a tripod is recommended to prevent shaking.

Press the shutter button fully down.

↓
Exposure is performed for the set shutter speed time, the screen turns black, and "CAPTURING" is displayed.

↓
Processing is performed to reduce noise for the set shutter speed time, and "PROCESSING" is displayed. The shutter sounds.

↓
"RECORDING" is displayed. The image is recorded.

Aperture priority mode

Once the aperture is adjusted manually, the shutter speed will be automatically adjusted to the suitable value to attain correct exposure according to the brightness of the subject. Selecting a lower aperture value opens the lens iris. Using a lower aperture value, you can record a subject with its background unclear. And using a higher aperture value, you can record both the subject and the background stand out clearly.

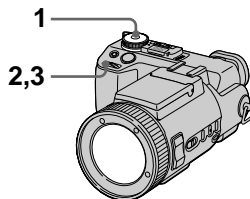

- 1 Set the mode dial to A.

- 2 Select an aperture value with the jog dial, then press the jog dial.

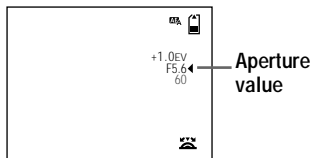

- 3 Select the desired aperture value with the jog dial, then press the jog dial.

The aperture value can be selected from F2 to F8.

Note

The range of values that can be selected varies, depending on the zoom position.

Manual exposure mode

You can manually adjust the shutter speed and aperture values to achieve the desired shooting condition according to your purpose. The exposure value appears on the screen (page 73). And you can also adjust the aperture value and the shutter speed value according to your taste. 0 EV is the most suitable value set by the camera.

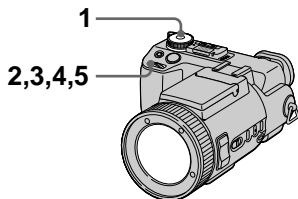

- 1 Set the mode dial to M.

- 2 Select the aperture value indication with the jog dial, then press the jog dial.

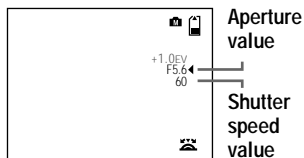

- 3 Select the aperture value with the jog dial, then press the jog dial.

- 4 Select the shutter speed value indication with the jog dial, then press the jog dial.

- 5 Select the shutter speed value with the jog dial, then press the jog dial.

For details on available values, see “Shutter speed priority mode” on page 63, or “Aperture priority mode” on page 63.

Note

- If the setting is not appropriate in aperture priority mode, shutter speed priority mode, or manual exposure mode, the setting value indicator on the screen flashes when the shutter button is pressed halfway. You can record in this setting, we, however, recommend that you adjust the flashed-value again.
- When shooting by manual adjustment, you cannot use the NightShot or NightFraming functions.

Tips

Under normal recording conditions, the camera automatically makes various adjustments, such as those for the focus, iris, exposure, and white balance, as it shoots. However, you may not be able to carry out your desired shooting depending on the shooting conditions. In this case you can set the near-optimum adjustments to suit your shooting situation by manual adjustment.

Recording images according to shooting conditions (Scene selection)

Mode dial: SCN

This camera has preset three scene selection modes. Each mode is suitable for the following situations; night scene, landscape, and portrait.

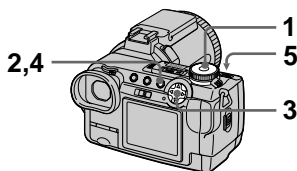

1 Set the mode dial to SCN.

2 Press MENU.

The menu appears.

3 Select [SCN] with ◀▶, the desired setting with ▲▼.

☾ TWILIGHT mode

Allows you to record bright subjects in dark places without losing the dark atmosphere of the surroundings. The shutter speed becomes slower, so we recommend that you use a tripod to prevent shaking.

🏔️ LANDSCAPE mode

Focuses only on a distant subject to record landscapes, etc.

👤 PORTRAIT mode

Suits for portrait recordings. Backgrounds blurred away, and the frontward person is sharpened.

4 Press MENU.

The menu disappears.

5 Record the image.

To cancel the scene selection function

Set the mode dial to other modes.

📌 Notes

- You can focus only on distant subjects in LANDSCAPE mode.
- Set ⚡ forced flash when you use the flash in the following modes:
 - TWILIGHT mode
 - LANDSCAPE mode
- When using the scene selection mode, the hologram AF (page 28) does not emit light in the following conditions:
 - TWILIGHT mode: when the flash mode is not set to ⚡ forced flash
 - LANDSCAPE mode

Recording three images continuously (BURST 3)

Mode dial: /S/A/M/SCN

You can continuously record three images.

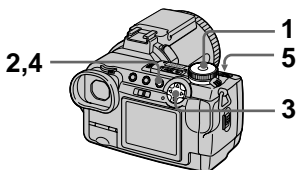

- 1 Set the mode dial to , S, A, M or SCN.
- 2 Press MENU.
The menu appears.
- 3 Select [MODE] (REC MODE) with / , [BURST 3] with / .
- 4 Press MENU.
The menu disappears.
- 5 Record the image.

To return to normal recording mode

Select [NORMAL] with / in step 3.

Notes

- You cannot use the flash in this mode.
- During recording in this mode, the image is not displayed on the screen. Make the composition before pressing the shutter button.
- The recording interval is approximately 0.5 seconds.
- You cannot select a shutter speed slower than 1".

Recording three images with the exposure shifted (EXP BRKTG)

Mode dial: /S/A/M/SCN

The camera continuously records three images with each exposure value shifted. The exposure compensation value can be set between $\pm 1.0\text{EV}$ from the correct exposure value by 1/3 step.

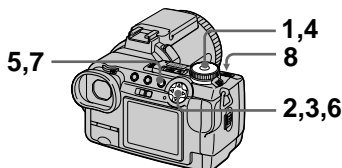

- 1 Set the mode dial to SET UP.
The SET UP screen appears.
- 2 Select [] (CAMERA) with / , [BRACKET STEP] with / / , then press .
- 3 Select the desired bracket step value, then press .
 $\pm 1.0\text{EV}$: Shifts the exposure value by plus or minus 1.0EV.
 $\pm 0.7\text{EV}$: Shifts the exposure value by plus or minus 2/3EV.
 $\pm 0.3\text{EV}$: Shifts the exposure value by plus or minus 1/3EV.
- 4 Set the mode dial to , S, A, M, or SCN.
- 5 Press MENU.
The menu appears.
- 6 Select [MODE] (REC MODE) with / , [EXP BRKTG] with / .
- 7 Press MENU.
The menu disappears.
- 8 Record the image.

To return to normal recording mode

Select [NORMAL] with ▲/▼ in step 6.

Notes

- You cannot use the flash in this mode.
- During recording, the image is not displayed on the screen. Make the composition before pressing the shutter button.
- Focus and white balance are adjusted for the first image and these settings are also used for the other images.
- When the exposure is manually adjusted, the adjusted value is used for the center value.
- The recording interval is approximate 0.5 seconds.
- You cannot select a shutter speed slower than 1".

Recording still images for e-mail (E-MAIL)

Mode dial:  /S/A/M/SCN

In the E-MAIL mode, a small-size image which is suitable for e-mail transmission is also recorded at the same time as recording a normal still image. (The size of the normal still image is set using [] (IMAGE SIZE) in the menu settings (page 60).)

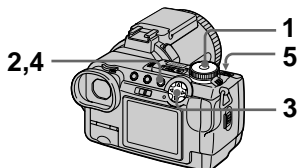

- 1** Set the mode dial to , S, A, M or SCN.
- 2** Press MENU.
The menu appears.
- 3** Select [MODE] (REC MODE) with ◀/▶, [E-MAIL] with ▲/▼.
- 4** Press MENU.
The menu disappears.
- 5** Record the image.

The number of images that you can record on a “Memory Stick” (16 MB) in E-MAIL mode

Image size	Quality	
	STANDARD	FINE
2560×1920	Approx. 11	Approx. 6
2560 (3:2)	Approx. 11	Approx. 6
2048×1536	Approx. 17	Approx. 9
1280×960	Approx. 42	Approx. 24
640×480	Approx. 192	Approx. 87

The number of recordable images

The actual number of images may differ depending on the recording conditions.

To return to normal recording mode

Select [NORMAL] with ▲/▼ in step 3.

Adding audio files to still images (VOICE)

Mode dial: /S/A/M/SCN

In the VOICE mode, the audio is also recorded at the same time as recording a still image. (The size of the normal still image is set using [] (IMAGE SIZE) in the menu settings (page 60).)

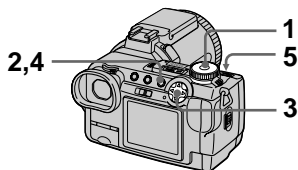

- 1 Set the mode dial to , S, A, M or SCN.**
- 2 Press MENU.**
The menu appears.
- 3 Select [MODE] (REC MODE) with ◀/▶, [VOICE] with ▲/▼.**
- 4 Press MENU.**
The menu disappears.
- 5 Record the image.**
If you press and release the shutter button, sound is recorded for five seconds.
If you hold down the shutter button, sound is recorded until you release the shutter button for up to 40 seconds.

The number of images that you can record on a “Memory Stick” (16 MB) in VOICE mode (when recording sound for five seconds)

Image size	Quality	
	STANDARD	FINE
2560×1920	Approx. 11	Approx. 6
2560 (3:2)	Approx. 11	Approx. 6
2048×1536	Approx. 16	Approx. 9
1280×960	Approx. 38	Approx. 22
640×480	Approx. 120	Approx. 68

The number of recordable images

The actual number of images may differ depending on the recording conditions.

To return to normal recording mode

Select [NORMAL] with ▲/▼ in step 3.

Recording still images as uncompressed files (TIFF)

Mode dial: /S/A/M/SCN

In this mode, a 2560×1920 size uncompressed image is recorded at the same time as a normal still image. (The size of the normal still image is set using [] (IMAGE SIZE) in the menu settings (page 60).) The image quality does not deteriorate. Images recorded in this mode are suitable for printing with a high-quality image.

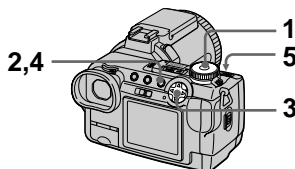

- 1 Set the mode dial to , S, A, M or SCN.
- 2 Press MENU.
The menu appears.
- 3 Select [MODE] (REC MODE) with ◀/▶, [TIFF] with ▲/▼.
- 4 Press MENU.
The menu disappears.
- 5 Record the image.

The number of images that you can record on a “Memory Stick” (16 MB) in TIFF mode

Image size	Quality	
	STANDARD	FINE
2560×1920	Approx. 0	Approx. 0
2560 (3:2)	Approx. 1	Approx. 1
2048×1536	Approx. 1	Approx. 0
1280×960	Approx. 1	Approx. 1
640×480	Approx. 1	Approx. 1

The number of recordable images

The actual number of images may differ depending on the recording conditions.

To return to normal recording mode

Select [NORMAL] with ▲/▼ in step 3.

Notes

- When [2560 (3:2)] is selected for the image size, the uncompressed image is recorded in the [2560 (3:2)] format.
- Some sizes cannot be recorded in TIFF mode because the “Memory Stick” (16 MB) does not have enough capacity.
- Writing data takes more time than in normal recording.

Creating Clip Motion Files

Mode dial:

Clip Motion is an animation function that plays back still images in succession. The images are stored in GIF format, which is convenient for creating home pages or attaching images to an e-mail.

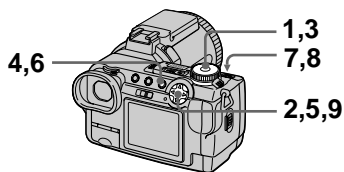

- 1 Set the mode dial to SET UP.**
The SET UP screen appears.
- 2 Select [] (CAMERA) with ▲/▼, [MOVING IMAGE] with ►/▲/▼, [CLIP MOTION] with ▲/▼, then press ●.**
- 3 Set the mode dial to .**
- 4 Press MENU.**
The menu appears.
- 5 Select [] (IMAGE SIZE) with ◀/▶, the desired mode with ▲/▼.**
NORMAL (160×120)
Clip Motion of up to 10 frames can be recorded. This is suitable for use on home pages, etc.
MOBILE (120×108)
Clip Motion of up to 2 frames can be recorded. This is suitable for use with portable data terminals.
- 6 Press MENU.**
The menu disappears.

7 Record the image for the first frame.

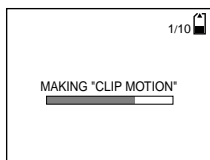

Before carrying out step 9, the images are temporarily stored in the memory. These images are not recorded on the “Memory Stick” yet.

8 Record the image for the next frame.

Image recording can be repeated up to the maximum number of recordable frames.

9 Press ●.

All the frame images are recorded on the “Memory Stick”.

To delete some or all of the frame images while making a Clip Motion recording

- 1 Press the control button ◀ (⊞) in step 7 or 8.

The recorded frame images are played back in turn and stop at the last image.

- 2 Press MENU, and select [DELETE LAST] or [DELETE ALL] with ◀/▶, then press ●.

- 3 Select [OK] with ▲/▼, then press ●.

When [DELETE LAST] is selected in step 2, each time you repeat steps 1 through 3, a recorded frame is deleted from the newest one.

The number of Clip Motion frames that you can record on a “Memory Stick” (16 MB)

Image size	Number of images
NORMAL (160×120)	Approx. 80*
MOBILE (120×108)	Approx. 450**

* When recording 10 frames per Clip Motion file

** When recording 2 frames per Clip Motion file

The number of recordable images

The actual number of images may differ depending on the recording conditions.

Notes



- You cannot change the image size partway through a Clip Motion recording.
- Reading and writing data take more time than normal image recording.
- Due to the limitations of the GIF format, the number of colors for Clip Motion images is reduced to 256 colors or less. Therefore, the picture quality may deteriorate for some images.
- The file size is reduced in MOBILE mode, so the picture quality deteriorates.
- GIF files not created on this camera may not be displayed correctly.
- All the frame images are immediately recorded on the “Memory Stick” if the mode dial is switched or the power is turned off.

Focusing manually

Mode dial: 

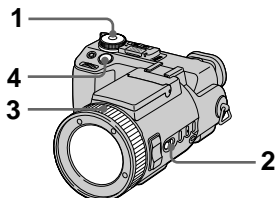
Normally the focus is automatically adjusted. This function is useful when the auto focus does not work well such as in dark places.



1 Set the mode dial to , S, A, M, SCN or .

2 Set FOCUS to MANUAL.
The  (manual focus) indicator appears on the screen.

3 Turn the focus ring to achieve a sharp focus.
If [EXPANDED FOCUS] in the SET UP settings is set to [ON], the image is zoomed to 2×* and the focus mode indicator is displayed when recording still images. When a sharp focus is achieved, the image returns to normal and the  (manual focus) indicator changes from yellow to white. When recording moving images, or [EXPANDED FOCUS] is set to [OFF], the image is not zoomed. You can adjust the focus distance from 2 cm (13/16 inches) to ∞ (infinite).

* When using digital zoom, the image is zoomed 1× to 2×, depending on the digital zoom magnification.

4 Record the image.

To reactivate auto focusing
Set FOCUS to AUTO.

Notes

- The focus mode indicator is approximate, and should be used as a reference.
- The focus distance value does not appear when NightShot is set and [CONVERSION LENS] is set to [ON] in the SET UP settings. When the  indicator flashes, the focus distance has reached 2 cm (13/16 inches) or ∞.
- You cannot focus manually when using the NightFraming function.

Recording images at close range (MACRO)

Mode dial: /S/A/M/SCN/

The macro recording mode is used when zooming up a small subject, such as flowers, insects.

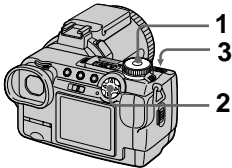

1 Set the mode dial to , S, A, M, SCN or .

2 Clear the menu, and press the control button .

The (macro) indicator appears on the screen.

You can record a subject as close as about 2 cm (13/16 inches) from the lens surface with the zoom set all the way to the W side, or about 90 cm (35 1/2 inches) with the zoom set all the way to the T side.

3 Record the image.

To return to normal recording mode

Press the control button again. The indicator disappears.

Notes

- You cannot record images in macro with the LANDSCAPE mode of the scene selection function.
- You cannot record images in macro when focusing manually.
- You cannot record images in macro when [CONVERSION LENS] is set to [ON] in the SET UP settings (page 93).

Adjusting the exposure (EXPOSURE)

Mode dial: /S/A/SCN/

This adjusts the exposure value which is set in the automatic adjustment.

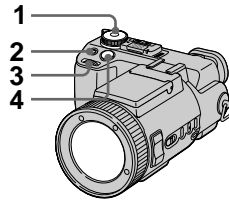

1 Set the mode dial to , S, A, SCN or .

2 Press .

3 Select the desired exposure value with the jog dial.

Adjust the exposure value while checking the brightness of the background.

You can select values ranging from +2.0 EV to -2.0 EV in steps of 1/3 EV.

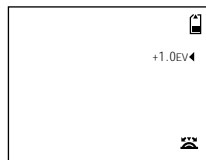

4 Record the image.

To reactivate auto exposure

Set the exposure value to 0 EV with the jog dial.

Note

If a subject is under extremely bright or dark conditions, or the flash is used, the exposure adjustment may not be effective.

Tips

Normally, the camera automatically adjusts the exposure. If the color of the image is too dark or bright as shown below, we recommend that you adjust the exposure manually. When recording a backlit subject or a subject in the snow, set the exposure toward +, and when recording a subject with extremely bright illumination such as a spotlight, set it toward -.

Set the exposure toward +



Set the exposure toward -

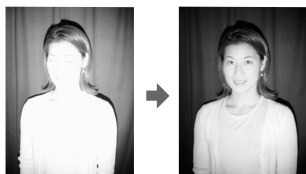

Adjusting the white balance (WHITE BALANCE)

Mode dial: /S/A/M/SCN/

Normally the white balance is automatically adjusted (AUTO). When you record with the shooting condition fixed or under a specific lighting condition, you can manually adjust the white balance.

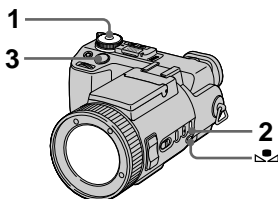

- 1 Set the mode dial to , S, A, M, SCN or .
- 2 Press WHT BAL repeatedly to select the desired white balance mode.

ONE PUSH ()

Adjusting the white balance depending on the light source

- ① Shoot a white object such as paper full under the same situation you will shoot.
- ② Press .

The indicator flashes quickly. When the white balance has been adjusted and stored in the memory, the indicator stops flashing.

OUT DOOR ()

Recording a sunrise/sunset, night scene, neon signs, or fireworks

IN DOOR ()

- Places where the lighting condition changes quickly
- Under bright lighting such as photography studios
- Under sodium or mercury lamps



AUTO (No indicator)

Adjusts the white balance automatically
Under fluorescent lighting

3 Record the image.

To reactivate auto adjustment
Select AUTO (no indicator) in step 2.

Notes

- The  indicator means:
Slow flashing: white balance is not set or was not able to be set.
Quick flashing: white balance is being adjusted.
Lit steady: white balance has been set.
- If the  indicator keeps flashing even when you press , record in automatic white balance mode.
- You cannot adjust the white balance when using the NightShot and NightFraming functions.

Tips

The image is susceptible to lighting conditions. The image looks blue under sunlight in the summer, and looks red under mercury lamps. Human eyes can resolve these problems. However, the camera cannot resolve the problem without making adjustments. Normally, the camera adjusts automatically, but if the image appears in strange colors, we recommend that you change the white balance mode.

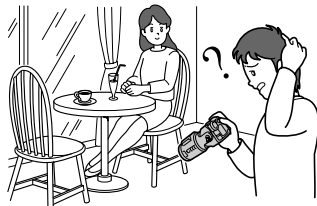



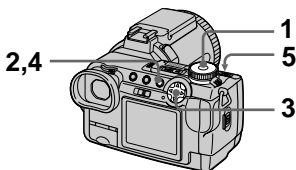

Enjoying picture effects (P. EFFECT)

Mode dial:  / S / A / M / SCN / 

You can digitally process images to obtain special effects.



- 1 Set the mode dial to , S, A, M, SCN or .
- 2 Press MENU.
The menu appears.
- 3 Select [PFX] (P. EFFECT) with , the desired mode with .

SOLARIZE

The light contrast is clearer and the picture looks like an illustration.

SEPIA

The picture is sepia-toned like an old photograph.

NEG.ART

The color and brightness of the picture are reversed as in a negative.

OFF

Does not use the picture effect function.

- 4 Press MENU.
The menu disappears.
- 5 Record the image.

To cancel picture effect
Select [OFF] with  /  in step 3.

Recording the date and time on a still image (DATE/TIME)

Mode dial: /S/A/M/SCN

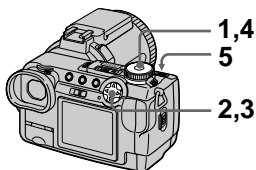

- 1 Set the mode dial to SET UP.**
The SET UP screen appears.
- 2 Select [] (CAMERA) with ▲/▼, [DATE/TIME] with ►/▲/▼, then press ►.**
- 3 Select the date and time setting with ▲/▼, then press ●.**

DAY & TIME

Superimposes the date, hour, and minute.

DATE

Superimposes the year, month, and day.

OFF

Does not superimpose the date and time.

- 4 Set the mode dial to , S, A, M, or SCN.**
- 5 Record the image.**

The date and time do not appear on the screen during shooting. These appear during playback only.

Notes

- If you select [DATE] in step 3, the date is superimposed onto the image in the order selected with “Setting the date and time” (page 16).
- The date and time are not superimposed onto moving images or Clip Motion images.

Determining the exposure (Metering mode)

Mode dial: /S/A/M/SCN/

This function enables you to select the metering mode to suit the shooting conditions and purpose. You can select from the three modes of multi-pattern, center-weighted or spot metering.

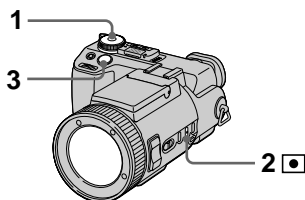

- 1 Set the mode dial to , S, A, M, SCN or .**
- 2 Press repeatedly to select the desired setting.**

Multi-pattern metering (No indicator)

The image is divided into multiple regions and metering is performed for each region. The camera judges the subject position and background brightness, and determines a well-balanced exposure.

The camera is set to multi-pattern metering as the default setting.

Center-weighted metering ()

Metering is performed with priority given to the center of the image. The camera determines the exposure based on the brightness of a subject near the center according to the recording aim.

Spot metering (☐)

Light is measured only for the specific region where the subject is located. This lets you adjust the exposure to the subject even when the subject is backlit or there is strong contrast between the subject and the background.

Position the spot metering cross hair with the point you want to record.

3 Record the image.

Press the shutter button halfway down, wait until the camera completes the automatic adjustments, then record the image.

Note

You cannot set the metering mode when using the NightShot and NightFraming functions.

► Various playback

Playing back three or nine images at once

Mode dial: 

You can display multiple images on the screen at one time by pressing .

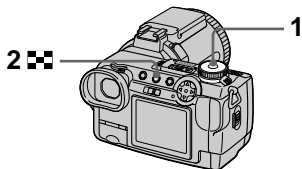

1 Set the mode dial to .

2 Press  repeatedly.

The screen display changes as follows:

- Single (single-image) screen

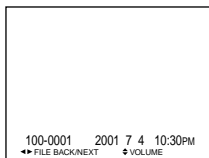

- Index (nine-image) screen

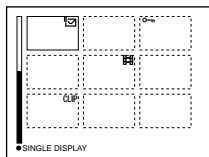

- Triple-image screen

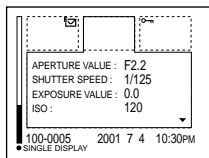

The image indicated by the yellow frame in the index screen is displayed in the middle of the triple-image screen with the recording information. To display the other information, press the control button .

The following marks are displayed on each image according to the image type and settings.

 : Moving image file

 : VOICE mode file

 : E-mail file

TIFF: TIFF file



CLIP: Clip Motion file

 : Print mark

 : Protect mark

(No mark): Normal recording (no settings)

To display the next (previous) index screen

Press the control button / .

To return to normal playback (single-image)

- Press  repeatedly.

- Press the control button .

Note

When viewing an image recorded in Clip Motion on the index screen, the image may appear different from the actual image. The recording information does not appear on the triple-image screen.

Tips



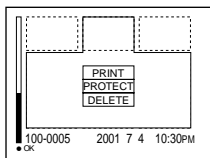

When the triple-image screen is displayed, pressing MENU opens the menu including [PRINT], [PROTECT], and [DELETE]. For details on these items, see pages 83, 84, or 88. To close the menu, press MENU again. The menu disappears and the recording information is indicated.

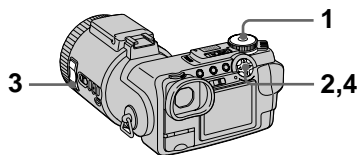

Enlarging a part of a still image (Zoom and trimming)





Mode dial: 



- 1 Set the mode dial to .
- 2 Display the image to be enlarged.
- 3 Zoom in/out the image with the ZOOM T/W buttons.
- 4 Move the image with , , , or  to select the desired portion of the image.

To return to the normal size
Press the control button .

To record an enlarged image (trimming)

- ① Press MENU after zooming.
- ② Select [TRIMMING] with , then press .
- ③ Select the image size with , , then press .

The image is recorded and the image on the screen returns to the normal size after recording.

Notes

- You cannot zoom moving images and Clip Motion images.
- Zoom scaling is up to 5× regardless of the original image size.
- The quality of enlarged images may be deteriorated.
- The original data is retained even if you enlarge the image.
- The enlarged image is recorded as the newest file.
- If you trim an image, the remaining “Memory Stick” capacity will be decreased.
- If the remaining “Memory Stick” capacity is not sufficient, you may be unable to trim an image.
- You cannot trim to an image size of 3:2.
- You cannot trim uncompressed (TIFF) images.

Playing back still images in order (SLIDE)

Mode dial: ►

This function is useful for checking the recorded images or for presentations, etc.

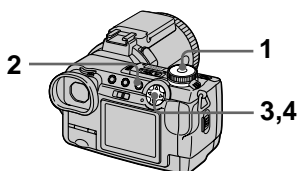

- 1 Set the mode dial to ►.**
- 2 Press MENU.**
The menu appears.
- 3 Select [SLIDE] with ◀▶, then press ●.**
Set the following items with ▲▼/◀▶.

INTERVAL

You can select from 1 min (one minute), 30 sec (30 seconds), 10 sec (10 seconds), 5 sec (5 seconds), or 3 sec (3 seconds).

REPEAT

ON: Plays back images in a continuous loop.
OFF: After all images have been played back, the slide show ends.

- 4 Select [START] with ▲▼, then press ●.**
The slide show begins.

To cancel the SLIDE SHOW setting

Select [CANCEL] with ▲▼/◀▶ in step 3, then press ●.

To stop the SLIDE SHOW playback

Press ●, select [EXIT] with ►, then press ●.

To skip to the next/previous image during the SLIDE SHOW

Press ► (next) or ◀ (previous).

Note

The interval setting time may vary depending on the image size.

Rotating a still image (ROTATE)

Mode dial: ►

You can rotate the image recorded in portrait orientation and change it in landscape orientation.

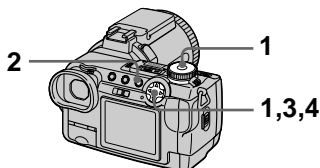

- 1** Set the mode dial to ►, and display the image to rotate.
- 2** Press MENU.
The menu appears.
- 3** Select [ROTATE] with ◀/►, then press ●.
- 4** Select [↶, ↷] with ▲/▼, then rotate the image with ◀/►. Select [OK] with ▲/▼, then press ●.

To cancel rotation

Select [CANCEL] with ▲/▼ in step 4, then press ●.

Notes

- You cannot rotate protected or uncompressed images.
- You may not be able to rotate images recorded with other equipment.
- Also, when viewing images on a computer, the image rotation information may not be reflected depending on the application software.

Viewing images on a TV screen

Mode dial: 

Before connecting your camera, be sure to turn off the TV.

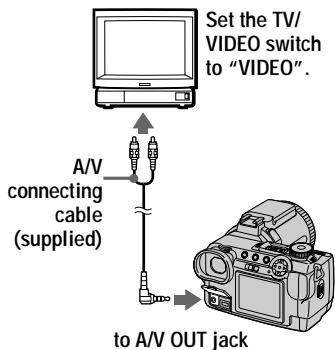

- 1 Set the mode dial to .**
- 2 Connect the A/V connecting cable to the A/V OUT jack of your camera and to the audio/video input jacks of the TV.**

If your TV has stereo type input jacks, connect the audio plug (black) of the A/V connecting cable to the Lch jack.

- 3 Turn on the TV and start playback on your camera.**

The image appears on the TV screen.

Notes

- You cannot use a TV that has an antenna (aerial) connector only.
- When viewing a still image on the TV, the black band may appear around the image.

► Editing

Deleting images (DELETE)

Mode dial: ►

You can delete unwanted files.

In single-image or triple-image mode

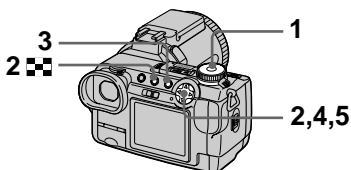



- 1 Set the mode dial to ►.
- 2 In single-image mode:
Display the image you want to delete with ◀▶.
In triple-image mode:
Press  twice in the single-image mode to turn to the triple-image mode. Display the image you want to delete with ◀▶.
- 3 Press MENU.
The menu appears.
- 4 Select [DELETE] with ◀▶ in single-image mode, or with ▲▼ in triple-image mode, then press ●.
- 5 Select [OK] with ▲▼, then press ●.
The displayed image (or the middle-positioned image in triple-image mode) is deleted.

To cancel deleting

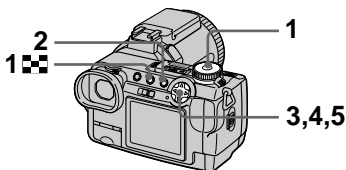

- Press MENU in step 4 or 5 so that the menu turns off.
- Select [CANCEL] with ▲▼ in step 5, then press ●.

In index mode



- 1 Set the mode dial to ►, then display the index screen with .
- 2 Press MENU.
The menu appears.
- 3 Select [DELETE] with ◀▶, then press ●.
- 4 Select [ALL] or [SELECT] with ◀▶, then press ●.
- 5 When you select [ALL]
Select [OK] with ◀▶, then press ●.
All the unprotected images are deleted.

When you select [SELECT]

- ① Select an image to be deleted with ▲▼/◀▶, then press ●.
The  (delete) indicator appears on the selected image. Repeat this step for all images that are to be deleted.
To cancel, press ● again.
The  indicator disappears.

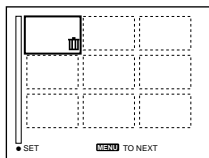

- ② Press MENU.
- ③ Select [OK] with ◀▶, then press ●.

To cancel deletion

Select [CANCEL] with ◀▶ in step 4 or [EXIT] with ◀▶ in step 5, then press ●.

Note

If there are files on the “Memory Stick” with names having the same last 4 digits as the file name of the image to be deleted, these files are also deleted at the same time.

Preventing accidental erasure (PROTECT)

Mode dial: ▶

This function protects images against accidental erasure.

Note

Formatting a “Memory Stick” (page 91) erases even protected images.

In single-image or triple-image mode

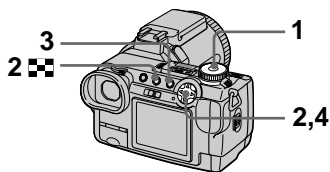

1 Set the mode dial to ▶.

2 In single-image mode

Display the image you want to protect with ◀▶.

In triple-image mode

Press ☒ twice in the single-image mode to turn to the triple-image mode.

Display the image you want to protect with ◀▶.

3 Press MENU.

The menu appears.

4 Select [PROTECT] with ◀▶ in single-image mode, or with ▲/▼ in triple-image mode, then press ●.

The displayed image (or the middle-positioned image in triple-image mode) is protected.

The  indicator appears on the image.

To release protection



Press ● again in step 4. The  indicator disappears.

To cancel protection

Press MENU in step 4 so that the menu turns off.

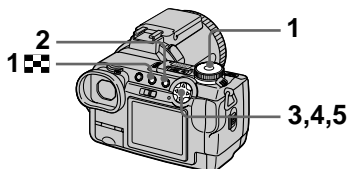
In index mode



1 Set the mode dial to , then display the index screen with .





2 Press MENU.
The menu appears.

3 Select [PROTECT] with , then press ●.

4 Select [ALL] or [SELECT] with , then press ●.

5 When you select [ALL]
Select [ON] with , then press ●.
All the images in the “Memory Stick” are protected.

When you select [SELECT]

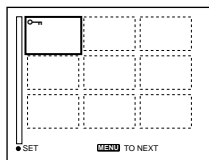

- ① Select an image to be protected with , , , then press ●.
The  (protect) indicator appears on the selected image. Repeat this step for all images that are to be protected.

To cancel, press ● again.
The  indicator disappears.







- ② Press MENU.
③ Select [OK] with , then press ●.

To release all protection



Select [ALL] with  in step 4, then press ●. Select [OFF] with , then press ●.

To release individual protection

Select [SELECT] in step 4, then:

- ① Select the images to be unprotected with , , , then press ●.
② Repeat ① for all images that are to be unprotected.
③ Press MENU, select [OK] with , and then press ●.

To cancel protection

Select [CANCEL] with  in step 4 or [EXIT] with  in step 5, then press ●.

Changing the recorded still image size (RESIZE)

Mode dial: 

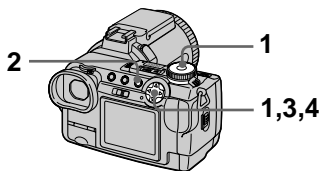

You can change the image size of a recorded image in single mode.



1 Set the mode dial to , then display the image of which you want to change the size.



2 Press MENU.
The menu appears.

3 Select [RESIZE] with , then press .

4 Select the desired size with , then press .

2560×1920, 2048×1536,
1280×960, 640×480

The resized image is recorded.

To cancel changing the size
Select [CANCEL] with , then press .

Notes

- The original image is retained even after resizing.
- You cannot change the size of moving images, uncompressed images, or Clip Motion images.
- The resized image is recorded as the newest file.
- If you resize an image, the remaining “Memory Stick” capacity will be decreased.
- When you change from a small size to a large size, the picture quality deteriorates.
- If the remaining “Memory Stick” capacity is not sufficient, you may not be able to resize an image.
- You cannot resize to an image size of 3:2.
- When you resize a 3:2 image, the upper and lower black portions are displayed on the screen.
- You cannot resize images in index mode or triple-image mode.





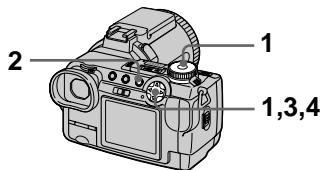

Copying images (COPY)

Mode dial: 

You can copy images to another “Memory Stick.”



In single mode



- 1 Set the mode dial to , then display the image you want to copy.
- 2 Press MENU.
The menu appears.
- 3 Select [COPY] with , then press .
- 4 Select [OK] with , then press .
“MEMORY STICK ACCESS” appears.
- 5 When “CHANGE MEMORY STICK” appears, eject the “Memory Stick.”
“INSERT MEMORY STICK” appears.
- 6 Insert the “Memory Stick” on which to copy the image.
“RECORDING” appears.
When copying is completed, “COMPLETE” appears.
To end copying, select [EXIT] with , then press .









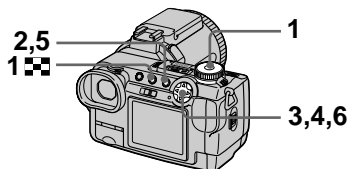

To copy the image to another “Memory Stick”
Select [CONTINUE] with , press , then repeat steps 5 and 6.

To cancel copying

Select [CANCEL] with  in step 4, or [EXIT] in step 5, then press .

In index mode



- 1 Set the mode dial to , then display the index screen with .
- 2 Press MENU.
The menu appears.
- 3 Select [COPY] with , then press . Select [SELECT] with , then press .
The frame of the selected image turns green.
- 4 Select the image to copy with , then press .
The  (select) indicator appears on the selected image. Repeat this step for all images that are to be copied.
To cancel, press  again. The  indicator disappears.

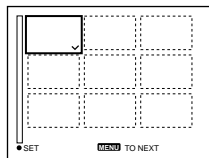

- 5 Press MENU.**
The menu appears.
- 6 Select [OK] with ◀▶, then press ●.**
“MEMORY STICK ACCESS” appears.
- 7 When “CHANGE MEMORY STICK” is displayed, eject the “Memory Stick.”**
“INSERT MEMORY STICK” appears.
- 8 Insert another “Memory Stick.”**
“RECORDING” appears.
When copying is completed, “COMPLETE” appears.
To end copying, select [EXIT] with ▲▼, then press ●.

To copy the image to another “Memory Stick”
Select [CONTINUE] with ▲▼ in step 3, press ●, then repeat steps 7 and 8.

To cancel copying
Select [CANCEL] with ◀▶ in step 3 or [EXIT] in steps 6 and 7, then press ●.

Notes

- You cannot copy uncompressed images.
- You cannot copy images that are bigger than 15 MB at once. If “NOT ENOUGH MEMORY” appears or ✓ flashes on the INDEX screen, cancel some images to copy and try again.
- If you do not select [EXIT] after “COMPLETE” appears and instead insert a new “Memory Stick,” the same image is copied again.

Selecting still images to print (PRINT)

Mode dial: ▶

You can mark a print mark on still images recorded with your camera. This mark is convenient when you have images printed at a shop that conforms with the DPOF (Digital Print Order Format) standard.

In single-image or triple-image mode

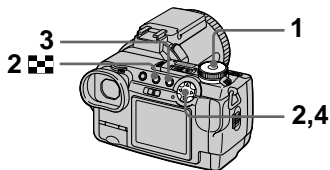

1 Set the mode dial to ▶.

2 In single-image mode
Display the image you want to print with ◀▶.

In triple-image mode
Press ◻ twice in the single-image mode to turn to the triple-image mode.
Display the image you want to print with ◀▶.

3 Press MENU.
The menu appears.

4 Select [PRINT] with ◀▶ in single-image mode, or with ▲▼ in triple-image mode, then press ●.
The ◻✓ (print) mark is marked on the displayed image (or the middle-positioned image in triple-image mode).



To unmark the print mark
Press ● again in step 4. The ◻✓ mark disappears.

To cancel marking the print mark

Press MENU in step 4 so that the menu turns off.

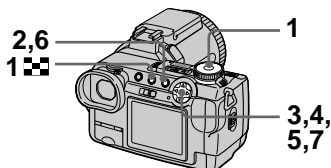

In index mode







1 Set the mode dial to , then display the index screen with .



2 Press MENU.
The menu appears.

3 Select [PRINT] with , then press .

4 Select [SELECT] with , then press .



The frame of the selected image turns green.
When marking the  mark, you cannot select [ALL].

5 Select the images to be marked with , , , then press .

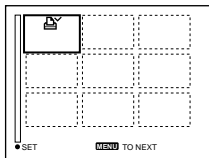
The  (print) mark appears on the selected image.
Repeat this step for all images that are to be marked.
To cancel, press  again. The  mark disappears.







6 Press MENU.
The menu appears.

7 Select [OK] with , then press .

To unmark selected print marks



Select the images to be unmarked in step 5 with the control button, then press .

To unmark all the print marks

Select [ALL] with , then press . Select [OFF] with , then press .

The  marks on all images are unmarked.

To cancel marking the print mark

Select [CANCEL] with , then select [EXIT] with , then press .

Notes







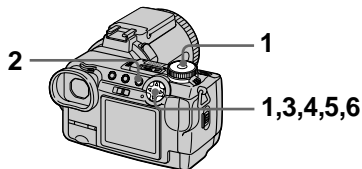

- You cannot mark moving images or Clip Motion images.
- If you mark an image recorded in TIFF mode with a print mark, only the uncompressed image is printed, and the JPEG image recorded at the same time is not printed.
- In E-mail mode, a print mark is marked on the normal size image that is recorded at the same time.

Dividing a moving image file (DIVIDE)



Mode dial: 

You can divide moving images recorded in MPEG MOVIE mode. This is convenient when there is not enough space on a “Memory Stick” or when attaching moving images to e-mails.

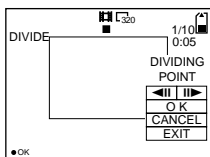

- 1 Set the mode dial to  and display the moving image you want to divide.**
- 2 Press MENU.**
The menu appears.
- 3 Select [DIVIDE] with , then press , then press , select [OK] with , then press .**
The moving image is played back.
- 4 Press  at the divide point.**
The following screen appears.
You can reselect the divide point with  as follows:







[ / ] (frame forward/
frame reverse)

You can finely adjust the divide point using .

[CANCEL]

Moving image playback restarts and you can reselect the divide point.

- 5 When you have decided the divide point, select [OK] with , then press .**
- 6 [OK], [CANCEL] and [EXIT] appear on the screen. Select [OK] with , then press .**
The moving image file is divided.

You cannot divide the following types of files:

- Clip Motion files
- Still image files
- Moving image files that are too short to divide

The file number changes as follows when you divide a file.

<eg.> If you divide the MOV00003.mpg file, the divided file numbers become MOV00004.mpg and MOV00005.mpg, and MOV00003.mpg is skipped. The divided files are saved as the latest files.

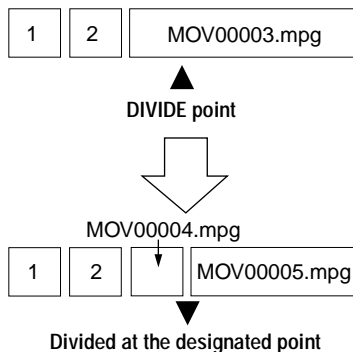

To cancel file division

Press [EXIT]. The image playback screen appears.

Notes

- You cannot recombine divided files.
- The original undivided file is not saved.

To delete unwanted portions of a moving image

<eg.> To delete the unwanted scenes A and B from the file MOV00002.mpg:

Step 1: Divide

- ① Divide the unwanted scene A.

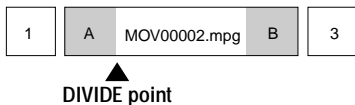

- ② Divide the unwanted scene B.

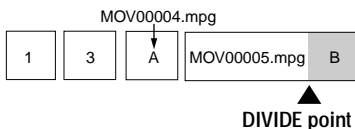

Step 2: Delete

- ① Delete the unwanted scenes A and B.

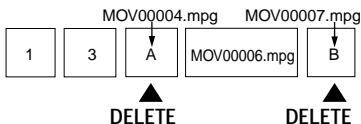

- ② Only the desired scene remains.

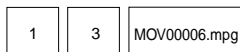

Formatting the "Memory Stick" (FORMAT)

Mode dial: SET UP

When you format a "Memory Stick", all data stored on the "Memory Stick" will be deleted. Check the contents of the "Memory Stick" before formatting.

Note

Even if images are protected, these images will be deleted.

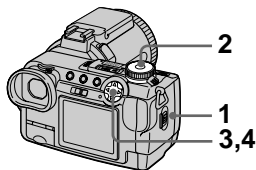

- 1 Insert the "Memory Stick" you want to format.
- 2 Set the mode dial to SET UP. The SET UP screen appears.
- 3 Select [SETUP 1] with ▲/▼, [FORMAT] with ►/▲/▼, then press ►.
- 4 Select [OK] with ▲/▼, then press ●.

To cancel formatting
Select [CANCEL] with ▲/▼ in step 4.

Notes

- Format the "Memory Stick" only using this camera. You cannot format the "Memory Stick" using a computer via the USB cable.
- When you format, be sure to use a fully charged battery pack or the AC power adaptor as the power source.

Changing the SET UP settings (SETUP)

The SET UP position changes the settings of infrequently-used items. Set the mode dial to SET UP. The SET UP screen appears. You can set up the following items with the control button. Default settings are indicated with ■.

CAMERA

Item	Setting	Description
EXPANDED FOCUS	■ ON OFF	When focusing manually, the image is enlarged to 2× (page 72).
MOVING IMAGE	■ MPEG MOVIE CLIP MOTION	Selects the recording mode of the moving image (pages 32, 70).
DATE/TIME	DAY & TIME DATE ■ OFF	Selects whether to superimpose the date or the time onto the image (page 76).
DIGITAL ZOOM	■ ON OFF	Uses digital zoom (page 24).
BRACKET STEP	±1.0EV ■ ±0.7EV ±0.3EV	Sets the exposure compensation value when recording three images with each exposure value shifted (page 66).
RED EYE REDUCTION	ON ■ OFF	Reduces the red-eye phenomenon (page 27).
HOLOGRAM AF	■ AUTO OFF	Uses when it is difficult to focus on the subject under dark conditions (page 28).

Notes on [DATE/TIME]

- The date and time do not appear on the screen during shooting. These appear only during playback.
- The date and time are not superimposed onto moving images and Clip Motion images.

SETUP 1

Item	Setting	Description
FORMAT	OK	Formats the “Memory Stick”. Note that formatting erases all the information recorded on the “Memory Stick”, including even erasure protected images (page 91).
	CANCEL	Cancels formatting of the “Memory Stick”.
FILE NUMBER	■ SERIES	Assigns numbers to files in sequence even if the “Memory Stick” is changed.
	RESET	Resets the file numbering each time the “Memory Stick” is changed.

Item	Setting	Description
CONVERSION LENS	ON ■ OFF	Sets to [ON] when using the VCL-MHG07A conversion lens (not supplied). At this time, the zoom function does not work. Use the step-down ring supplied with the conversion lens.
言語/ LANGUAGE	■ ENGLISH	Displays the menu items in English.
	日本語 /JPN	Displays the menu items in Japanese.
CLOCK SET	OK CANCEL	Sets the date and time (Perform the procedure from step ③ on page 16).

Note when using a conversion lens

When you mount the conversion lens VCL-MHG07A, the weight makes it impossible to lock the lens portion. We recommend supporting the lens portion with your left hand or using a tripod for recording.

SETUP 2

Item	Setting	Description
LCD BRIGHTNESS	BRIGHT ■ NORMAL DARK	Selects the LCD brightness. This has no effect on the recorded images.
LCD BACKLIGHT	BRIGHT ■ NORMAL	Displayed only when using your camera with the battery pack: Selects the brightness of the LCD backlight. Selecting [BRIGHT] makes the screen bright and easy to see when using the camera outdoors or in other bright locations, but also uses up the battery charge faster.
EVF BACKLIGHT	BRIGHT ■ NORMAL	Selects the brightness of the finder backlight. Selecting [BRIGHT] makes the screen bright and easy to see when using the camera outdoors or in other bright locations, but also uses up the battery charge faster.
BEEP	SHUTTER	Turns on the shutter sound only. (The shutter sound is heard when you press the shutter button.)
	■ ON	Turns on the beep/shutter sound (when you press the control button/shutter button).
	OFF	Turns off the beep/shutter sound.
VIDEO OUT	NTSC	Sets the video output signal to NTSC mode (e.g., Japan, USA) (page 98).
	PAL	Sets the video output signal to PAL mode (e.g., Europe) (page 98).

Item	Setting	Description
USB CONNECT	PTP <input checked="" type="checkbox"/> NORMAL	Switches the USB mode (page 38). Users will be informed at the Sony website when PTP connection is supported.
DEMO	<input checked="" type="checkbox"/> ON/STBY OFF	Displayed only when you use your camera with the AC power adaptor. [DEMO] is set to [STBY] as the default setting and the demonstration starts about 10 minutes after you have set the mode dial to  , S, A, M or SCN. To cancel the demonstration, turn off the power.

Note on DEMO mode

You can release the shutter in DEMO mode, but nothing is recorded.

Precautions

On cleaning

Cleaning the LCD screen

Wipe the screen surface with a cleaning cloth (not supplied) or a LCD cleaning kit (not supplied) to remove fingerprints, dust, etc.

Care and storage of the lens

- Wipe the surface of the lens clean with a soft cloth in the following instance:
 - When there are fingerprints on the lens surface
 - In hot or humid locations
 - When the lens is used in environments such as the seaside
- Store the lens in a well-ventilated location subject to little dirt or dust.

To prevent mold from occurring, periodically perform the above. We recommend turning on and operating the digital still camera about once per month to keep the digital still camera in an optimum state for a long time.

Cleaning the camera surface

Clean the camera surface with a soft cloth slightly moistened with water, then wipe the surface dry. Do not use any type of solvent such as thinner, alcohol or benzine as this may damage the finish or the casing.

After using your camera at the seashore or other dusty locations

Clean your camera carefully. Otherwise, the salty air may corrode the metal fittings or dust may enter the inside of your camera, causing a malfunction.

Note on operating temperature

Your camera is designed for use between the temperatures of 0°C and 40°C (32°F and 104°F). Recording in extremely cold or hot places that exceed this range is not recommended.

On moisture condensation

If the camera is brought directly from a cold to a warm location, or is placed in a very damp room, moisture may condense inside or outside the camera. Should this occur, the camera will not operate properly.

Moisture condensation occurs easily when:

- The camera is brought from a cold location such as a ski slope into a warmly heated room.
- The camera is taken from an air-conditioned room or car interior to the hot outdoors, etc.

How to prevent moisture condensation

When bringing the camera from a cold place to a warm place, seal the camera in a plastic bag and allow it to adapt to conditions at the new location over a period of time (about an hour).

If moisture condensation occurs

Turn off the camera and wait about an hour for the moisture to evaporate. Note that if you attempt to record with moisture remaining inside the lens, you will be unable to record clear images.

On AC power adaptor

- The unit is not disconnected from the AC power source (mains) as long as it is connected to the wall outlet (wall socket), even if the unit itself has been turned off.
- Unplug the unit from the wall outlet (wall socket) when you are not using the unit for a long time.
- To disconnect the power cord (mains lead), pull it out by the plug. Never pull on the power cord (mains lead) itself.
- Do not operate the unit with a damaged power cord (mains lead) or if the unit has been dropped or damaged.
- Do not bend the power cord (mains lead) forcibly, or place a heavy object on it. This will damage the cord (mains lead) and may cause fire or electrical shock.

- Prevent metallic objects from coming into contact with the metal parts of the connecting section. If this happens, a short may occur and the unit may be damaged.
- Always keep the metal contacts clean.
- Do not disassemble the unit.
- Do not apply mechanical shock or drop the unit.
- While the unit is in use, particularly during charging, keep it away from AM receivers and video equipment. AM reception and video operation will be disturbed.
- The unit becomes warm during use. This is not a malfunction.
- Do not place the unit in locations that are:
 - Extremely hot or cold
 - Dusty or dirty
 - Very humid
 - Vibrating

On battery pack

- Use only the specified charger with the charging function.
- To prevent accident from a short circuit, do not allow metal objects to come into contact with the battery terminals.
- Keep the battery pack away from fire.
- Never expose the battery pack to temperatures above 60°C (140°F), such as in a car parked in the sun or under direct sunlight.
- Keep the battery pack dry.
- Do not expose the battery pack to any mechanical shock.
- Do not disassemble or modify the battery pack.
- Install the battery pack in the camera securely.
- Charging while some capacity remains does not affect the original battery capacity.

If any problem occurs, unplug your camera and contact your nearest Sony dealer.

On internal rechargeable button battery

This camera has an internal rechargeable button battery for maintaining the date and time and other settings regardless of whether the power is on or off. This rechargeable button battery is constantly charged as long as you are using the camera. However, if you use the camera for only short periods it discharges gradually, and if you do not use the camera at all for about 1 month it becomes completely discharged. In this case, be sure to charge this rechargeable button battery before using the camera. However, even if this rechargeable button battery is not charged, you can still use the camera as long as you do not record the date and time.

Charging method

Connect the camera to a wall outlet (wall socket) with the AC power adaptor, or install a charged battery pack, and leave the camera for 24 hours or more with the power off.

On "Memory Sticks"

"Memory Stick" is a new compact, portable and versatile IC recording medium with a data capacity that exceeds a floppy disk. "Memory Stick" is specially designed for exchanging and sharing digital data among "Memory Stick" compatible products. Because it is removable, "Memory Stick" can also be used for external data storage.



There are two types of "Memory Sticks": general "Memory Sticks" and "MagicGate Memory Sticks" that are equipped with the MagicGate* copyright protection technology.

You can use both types of "Memory Stick" with your camera. However, because your camera does not support the MagicGate standards, data recorded with your camera is not subject to MagicGate copyright protection.

* MagicGate is copyright protection technology that uses encryption technology.

Notes

- Data may be damaged if:
 - you remove the “Memory Stick” or turn off your camera while reading or writing data.
 - you use the “Memory Stick” in a location subject to the effects of static electricity or noise.
- Do not attach any other material than the supplied label on the labeling position.
- Attach the label so that it does not stick out from the proper attachment location.
- When you carry or store the “Memory Stick,” put it in its supplied case.
- Do not touch the terminals of the “Memory Stick” with your hand or a metal object.
- Do not strike, bend or drop the “Memory Stick.”
- Do not disassemble or modify the “Memory Stick.”
- Do not allow the “Memory Stick” to get wet.

“Memory Stick”,  “MagicGate Memory Stick” and  are trademarks of Sony Corporation.

“MagicGate” and **MAGICGATE** are trademarks of Sony Corporation.

On “InfoLITHIUM” battery pack

What is the “InfoLITHIUM” battery pack?

The “InfoLITHIUM” battery pack is a lithium-ion battery pack that has functions for communicating information related to operating conditions between your camera and the AC power adaptor.

The “InfoLITHIUM” battery pack calculates the power consumption according to the operating conditions of your camera, and displays the remaining battery time in minutes.

Charging the battery pack

- Be sure to charge the battery pack before you start using your camera.
- We recommend charging the battery pack in an ambient temperature of between 10°C to 30°C (50°F to 86°F) until the CHG/⚡ lamp goes out, indicating that the battery pack is fully charged. If you charge the battery pack outside of this temperature range, you may not be able to efficiently charge the battery pack.
- After charging is completed, disconnect the AC power adaptor from the DC IN jack on your camera or remove the battery pack.

Effective use of the battery pack

- Battery performance decreases in low-temperature surroundings. So, the time that the battery pack can be used is shorter in cold places. We recommend the following to ensure longer battery pack use:
 - Put the battery pack in a pocket close to your body to warm it up, and insert it in your camera immediately before you start shooting.
- Frequently operating the zoom wears out the battery pack faster.
- Be certain to turn the POWER switch to off when not taking shots or playing back on your camera.
- We recommend having spare batteries handy for two or three times the expected shooting time, and making trial shots before taking the actual shots.
- Do not expose the battery pack to water. The battery pack is not water-resistant.

Remaining battery time indicator

- The power may go off although the battery remaining indicator shows there is enough power to operate. Charge the battery pack fully again so that the indication on the battery remaining indicator is correct. Note, however, that the correct battery indication sometimes will not be restored if it is used in high temperatures for a long time or left in a fully charged state, or the battery pack is frequently used. Regard the remaining battery time indication as the approximate shooting time.

How to store the battery pack

- Even if the battery pack will not be used for a long time, fully charge it and use it up once per year. Remove the battery pack from your camera, then store it in a dry, cool place. This is to maintain the battery pack's functions.
- To use the battery pack up on your camera, leave the POWER switch to on in slide show playback mode until the power goes off.

Battery life

- The battery life is limited. Battery capacity decreases little by little as you use it more and more, and as time passes. When the battery operating time is shortened considerably, a probable cause is that the battery pack has reached the end of its life. Please buy a new battery pack.
- The battery life varies according to how it is stored and operating conditions and environment for each battery pack.

Using your camera abroad

Power sources

You can use your camera in any country or area with the supplied battery charger within 100 V to 240 V AC, 50/60 Hz. Use a commercially available AC plug adaptor [a], if necessary, depending on the design of the wall outlet (wall socket) [b].

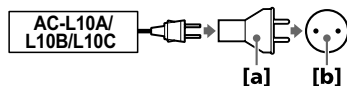

Watching the playback picture on TV

If you want to view the playback picture on a TV, you need a TV having a video input jack and a video connecting cable.

The color system of the TV must be the same as that of your digital still camera. Check the following list:

NTSC system

Bahama Islands, Bolivia, Canada, Central America, Chile, Colombia, Ecuador, Jamaica, Japan, Korea, Mexico, Peru, Surinam, Taiwan, the Philippines, the U.S.A., Venezuela, etc.

PAL system

Australia, Austria, Belgium, China, Czech Republic, Denmark, Finland, Germany, Holland, Hong Kong, Italy, Kuwait, Malaysia, New Zealand, Norway, Portugal, Singapore, Slovak Republic, Spain, Sweden, Switzerland, Thailand, United Kingdom, etc.

PAL-M system

Brazil

PAL-N system



Argentina, Paraguay, Uruguay

SECAM system







Bulgaria, France, Guiana, Hungary, Iran, Iraq, Monaco, Poland, Russia, Ukraine, etc.

Troubleshooting



If you experience trouble with your camera, first check the following items. Should your camera still not operate properly after you have made these checks, press the RESET button. (If you press the RESET button, all the settings including date and time are cleared.) Should your camera still not operate properly, consult your Sony dealer or local authorized Sony service facility. **If code displays (C:□□:□□) appear on the screen, the self-diagnosis display function is working (page 107).**

Symptom	Cause and/or Solution
Your camera does not work.	<ul style="list-style-type: none">• You are not using an “InfoLITHIUM” battery pack. →Use an “InfoLITHIUM” battery pack (page 11).• The battery level is low (the  indicator appears on the screen). →Charge the battery pack (page 12).• The AC power adaptor is not connected securely. →Connect it firmly to the DC IN jack of your camera and a wall outlet (wall socket) (pages 12, 15).• The built-in microcomputer is not working properly. →Disconnect and then reconnect all power sources after one minute. Then turn the power on by sliding the POWER switch and check that the camera works properly. If the function still do not work, press the RESET button located on the inside of the battery/“Memory Stick” cover using a sharp-pointed object. (If you press the RESET button, all setting including the date and time are cleared.)
Your camera cannot record images.	<ul style="list-style-type: none">• You cannot record images while charging the flash.• The mode dial is set to  or SET UP. →Set it to other modes (pages 21, 32).• No “Memory Stick” has been inserted into your camera. →Insert a “Memory Stick”.• The write-protect tab on the “Memory Stick” is set to LOCK. →Set it to the recording position.
The LCD screen does not light when the power is turned on.	<ul style="list-style-type: none">• The FINDER/LCD switch is set to FINDER. →Set it to LCD.

Symptom	Cause and/or Solution
An unexpected screen appears.	<ul style="list-style-type: none"> When using your camera with the AC power adaptor, a demonstration starts about 10 minutes after you have set the mode dial to , S, A, M or SCN. <ul style="list-style-type: none"> → Turn the power off and then on again. You can disable the demonstration under SET UP (page 94).
Recording takes a long time.	<ul style="list-style-type: none"> NR slow shutter is activated. <ul style="list-style-type: none"> → Set to a faster shutter speed than 2.5" (page 63).
The picture is out of focus.	<ul style="list-style-type: none"> Your camera is not in macro recording mode when you shoot a subject that is within 50 cm (19 3/4 inches) from the lens at the W side, or within 90 cm (35 1/2 inches) at the T side. <ul style="list-style-type: none"> → Set the macro recording mode (page 73). Manual focus mode is selected. <ul style="list-style-type: none"> → Set FOCUS to AUTO. The LANDSCAPE mode or PORTRAIT mode are selected for the scene selection function. <ul style="list-style-type: none"> → Cancel the function (page 65). [CONVERSION LENS] is set to [ON]. <ul style="list-style-type: none"> → Set it to [OFF] (page 93).
The resizing function does not work.	<ul style="list-style-type: none"> You cannot resize moving images, Clip Motion and uncompressed images.
You cannot display a print mark.	<ul style="list-style-type: none"> You cannot display print marks on moving images and Clip Motion images.
The picture is noisy.	<ul style="list-style-type: none"> Your camera is placed near a TV or other equipment that uses strong magnets. <ul style="list-style-type: none"> → Move your camera away from the TV, etc.
The picture is too dark.	<ul style="list-style-type: none"> You are shooting a subject with a light source behind the subject. <ul style="list-style-type: none"> → Adjust the exposure (page 73). The brightness of the LCD screen is too low. <ul style="list-style-type: none"> → Adjust the brightness of the LCD screen (page 93).
The picture is too bright.	<ul style="list-style-type: none"> You are shooting a spotlighted subject in a dark location such as on a stage. <ul style="list-style-type: none"> → Adjust the exposure (page 73). The LCD screen is too bright. <ul style="list-style-type: none"> → Adjust the brightness of the LCD screen (page 93).

Symptom	Cause and/or Solution
A sound is made if the NIGHTSHOT/ NIGHTFRAMING switch is changed.	<ul style="list-style-type: none"> The sound is made by the lens in operation.
The image colors are not correct.	<ul style="list-style-type: none"> NIGHTSHOT or NIGHTFRAMING is set. → Set to ●.
The lens makes a noise inside if the shutter button is lightly pressed while NIGHTFRAMING is set.	<ul style="list-style-type: none"> The sound is made by the AE/AF function in operation.
NightShot or NightFraming does not function.	<ul style="list-style-type: none"> The mode dial is set to SCN, S, A or M. → Set it to  or  (only for NightShot).
The flash does not work.	<ul style="list-style-type: none"> The flash is set to  no flash. → Set the flash to auto (no indicator) or  forced flash (page 26). The camera is in one of the following scene selection modes: TWILIGHT or LANDSCAPE. → Cancel the scene selection function (page 65) or set the flash to  forced flash. The mode dial is set to , SETUP or  (MPEG MOVIE). → Set it to other modes. [MODE] (REC MODE) is set to [BURST 3] or [EXP BRKTG] in the menu settings. → Set it to other settings. NightShot is activated. → Set NIGHTSHOT/NIGHTFRAMING to ● or NIGHTFRAMING.
The date and time are recorded incorrectly.	<ul style="list-style-type: none"> The date and time are not set correctly. → Set the correct date and time (page 16).
Vertical streaks appear when you are shooting a very bright subject.	<ul style="list-style-type: none"> The smear phenomenon is happening. → This is not a malfunction.

Symptom	Cause and/or Solution
The battery life is short.	<ul style="list-style-type: none"> • You are recording/playing back images under extremely cold temperatures. • The battery pack is not charged enough. →Charge the battery pack fully. • The battery pack is dead (page 98). →Replace the battery pack with a new one.
The battery remaining indicator is incorrect.	<ul style="list-style-type: none"> • You have used the camera for a long time in an extremely hot or an extremely cold location. • The battery pack is dead. →Replace the battery pack with a new one. • The battery pack is discharged. →Install a charged battery pack (pages 11, 12).
Sufficient battery remaining indicator is displayed but the power runs out soon.	<ul style="list-style-type: none"> • A deviation has occurred in the remaining battery time. →Fully charge the battery pack (page 12).
The CHG/⚡ lamp flashes during charging.	<ul style="list-style-type: none"> • The AC power adaptor is disconnected. →Firmly connect the power cord to the wall outlet (wall socket) (page 12). • The battery pack is not installed correctly. →Install the battery pack correctly (page 11). • The battery pack has malfunctioned. →Contact your Sony dealer or local authorized Sony service facility.
You cannot charge the battery.	<ul style="list-style-type: none"> • The camera is turned on. →Turn the camera off (page 12).
The zoom does not work.	<ul style="list-style-type: none"> • [CONVERSION LENS] in the SET UP setting is set to [ON]. →Set it to [OFF] (page 93).
Digital zoom does not function.	<ul style="list-style-type: none"> • The digital zoom cannot be used when recording a moving image. • [DIGITAL ZOOM] is set to [OFF]. →Set [DIGITAL ZOOM] to [ON] in the SET UP settings.







Symptom	Cause and/or Solution
Your camera cannot play back images.	<ul style="list-style-type: none"> The mode dial is set to , , M, A, S, SCN or SET UP. →Set it to  (pages 35, 36). Your camera cannot play back image files copied to the hard disk of your computer if the file name has been changed or the image has been modified.
The image and sound are interrupted by noise when you play back an image on a computer.	<ul style="list-style-type: none"> You are playing back the file directly from the “Memory Stick.” →Copy the file to the hard disk of the computer and then play back the file from the hard disk (page 47).
The image cannot be played back on a computer.	→Consult the computer or software manufacturer.
Your camera cannot delete an image.	<ul style="list-style-type: none"> The image is protected. →Release the protection (page 84).
The power turns off suddenly.	<ul style="list-style-type: none"> The auto-power off function (page 22) is activated. →Turn on the camera or use the AC power adaptor. The battery is discharged. →Replace it with a charged battery.
The image does not appear on the TV screen.	<ul style="list-style-type: none"> The video output signal setting of your camera is incorrect. →Change the setting (page 93).
A file error occurs when you play back a file.	<ul style="list-style-type: none"> Your camera cannot play back files with an image size larger than 2560×1920 or larger that were recorded by another camera.

Symptom	Cause and/or Solution
<p>Your computer does not recognize your camera.</p>	<ul style="list-style-type: none"> • The battery level is low. →Use the AC power adaptor (page 15). • The camera is turned off. →Turn on the camera. • The USB cable is not connected firmly. →Disconnect the USB cable, and connect it again firmly. Make sure that “USB MODE” is displayed on the screen (pages 44, 45). • [USB CONNECT] is set to [PTP] in the SET UP settings. →Set it to [NORMAL] (page 94). • The USB connectors on your computer are connected to other equipment besides the keyboard, the mouse, and your camera. →Disconnect the USB cables except for the ones connected to the keyboard, the mouse, and your camera. • The USB driver is not installed. →Install the USB driver (pages 39, 48). • Since the camera is connected to a computer with the USB cable before installing the USB driver, the drive is not recognized by the computer. →Delete the drive which is not recognized, then install the USB driver. For details, see the procedure on page 42.

Warning and notice messages

Various messages appear on the screen. Check the corresponding descriptions in the following list.

Message	Meaning
NO MEMORY STICK	No “Memory Stick” has been inserted.
SYSTEM ERROR	Turn the power off and on again.
MEMORY STICK ERROR	<ul style="list-style-type: none">• The inserted “Memory Stick” cannot be used with your camera, or is damaged.• The “Memory Stick” is not inserted correctly.
FORMAT ERROR	Failed to format the “Memory Stick.”
MEMORY STICK LOCKED	The write-protect tab on the “Memory Stick” is set to the LOCK position.
NO MEMORY SPACE	The capacity of the “Memory Stick” is full, and you cannot record or copy images.
NO FILE	No image has been recorded on the “Memory Stick.”
FILE ERROR	An error occurred while playing back the image.
FILE PROTECT	The image is protected against erasure.
for “InfoLITHIUM” battery only	The battery is not the “InfoLITHIUM” type.
NOT ENOUGH MEMORY	The images you want to copy are too big to copy with your camera.
COPY ERROR	Copying was not performed correctly, or the “Memory Stick” was removed during copying.
DIRECTORY ERROR	A directory with the same name already exists on the “Memory Stick”.
IMAGE SIZE OVER	You are playing back an image of a size that cannot be played back with your camera.

Message	Meaning
INVALID OPERATION	You are playing back a file that was created on equipment other than your camera.
	The battery level is low. Depending on the conditions of use or the type of battery pack, the indicator may flash even though there is still 5 to 10 minutes of remaining battery time left.
CANNOT DIVIDE	<ul style="list-style-type: none"> • The file is not long enough to be divided. • The file is not a moving image.
	The amount of lights is not sufficient or the shutter speed is too slow. (Mount the camera on a tripod or otherwise secure the camera in place.)
“NIGHT SHOT”	An operation that is not valid while NIGHTSHOT is set is attempted.
“NIGHT FRAMING”	An operation that is not valid while NIGHTFRAMING is set is attempted.
NIGHT SHOT IS INVALID	<ul style="list-style-type: none"> • The mode dial is set to a position other than  or  while NIGHTSHOT is set. • [CONVERSION LENS] in the SET UP settings is set to [ON].
NIGHT FRAMING IS INVALID	<ul style="list-style-type: none"> • The mode dial is set to a position other than  or  (Clip Motion) while NIGHTFRAMING is set. • [CONVERSION LENS] in the SET UP settings is set to [ON].
MANUAL FOCUS IS INVALID	The focus ring is turned while NIGHTFRAMING is set.

Self-diagnosis display

Your camera has a self-diagnosis display. This function displays the camera condition on the screen with a combination of a letter and four digits of numbers. If this occurs, check the following code chart. The code informs you of the camera's current condition. The last two digits (indicated by □□) will differ depending on the state of the camera.

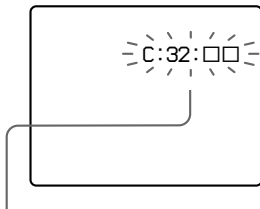

Self-diagnosis display

- C:□□:□□
You can reverse the camera malfunction yourself.
- E:□□:□□
Contact your Sony dealer or local authorized Sony service facility.

First three digits	Cause and/or Corrective Action
C:32:□□	<ul style="list-style-type: none">• There is trouble with your camera's hardware. → Turn the power off and on again.
C:13:□□	<ul style="list-style-type: none">• An unformatted "Memory Stick" is inserted. → Format the "Memory Stick" (page 91).• The inserted "Memory Stick" cannot be used with your camera, or is damaged. → Insert a new "Memory Stick" (page 18).• The camera cannot read or write data on the "Memory Stick". → Re-insert the "Memory Stick" several times.
E:61:□□ E:91:□□	<ul style="list-style-type: none">• A camera malfunction that you cannot reverse has occurred. → Contact your Sony dealer or local authorized Sony service facility and inform them of the 5-digit service code. (example: E:61:10)

If you are unable to solve the problem even after trying the corrective actions a few times, or if the camera is not reset even if you press the RESET button located on the inside of the battery/"Memory Stick" cover, contact your Sony dealer or local authorized Sony service facility.

Specifications

System

Image device

11 mm (2/3 type) color CCD

Effective pixels number of camera

Approx. 5 020 000 pixels

Lens

5× zoom lens

f = 9.7 – 48.5 mm (13/32 – 1 15/16 inches)

(38 – 190 mm (1 1/2 – 7 1/2 inches) when converted to a 35 mm still camera)

F = 2.0 – 2.4

Filter diameter: 58 mm (2 3/8 inches)

Exposure control

Automatic exposure, Shutter speed priority, Aperture priority, Manual exposure

White balance

Automatic, Indoor, Outdoor, One-push

Data system

Movie: MPEG1

Still: JPEG, GIF (in Clip Motion), TIFF

Audio with still image:

MPEG1 (Monaural)

Recording medium

“Memory Stick”

Flash

Recommended recording distance (ISO set to AUTO): 0.3 m to 4.5 m (11 7/8 inches to 177 1/4 inches)

Viewfinder

Electric viewfinder (color)

Output connector

A/V OUT (Monaural)

Minijack

Video: 1 Vp-p, 75 Ω,

unbalanced, sync negative

Audio: 327 mV (at a 47 kΩ load)

Output impedance: 2.2 kΩ

USB jack

mini-B

ACC (Accessory) jack

Minijack

LCD screen

Used LCD panel

4.6 cm (1.8 type) TFT (Thin Film Transistor active matrix) drive

Total number of dots

123 200 (560×220) dots

General

Used battery pack

NP-FM50

Power requirements

7.2 V

Power consumption

(during recording)

2.8 W

Operation temperature

0°C to 40°C

(32°F to 104°F)

Storage temperature

–20°C to +60°C

(–4°F to +140°F)

Maximum dimensions

119×69×151 mm

(4 3/4×2 3/4×6 inches)

(w/h/d) (excluding maximum protrusions)

Mass

Approx. 710 g (1 lb. 9 oz)

(including battery pack NP-FM50, “Memory Stick,” shoulder strap and lens cap etc.)

Built-in microphone

Electret condenser microphone

Built-in speaker

Dynamic speaker

AC-L10A/L10B/L10C

AC power adaptor

Power requirements

100 to 240 V AC, 50/60 Hz

Rated output voltage

DC 8.4 V, 1.5 A in operating mode

Operation temperature

0°C to 40°C (32°F to 104°F)

Storage temperature

–20°C to +60°C

(–4°F to +140°F)

Maximum dimensions

125×39×62 mm

(5×1 9/16×2 1/2 inches)

(w/h/d)

Mass

Approx. 280 g (10 oz)

NP-FM50 battery pack

Used battery

Lithium ion battery

Maximum voltage

DC 8.4 V

Nominal voltage

DC 7.2 V

Capacity

8.5 Wh (1 180 mAh)

Accessories

A/V connecting cable (1)

NP-FM50 battery pack (1)

AC-L10A/L10B/L10C AC

power adaptor (1)

Power cord (1)

USB cable (1)

Lens cap (1)

Lens cap strap (1)

Shoulder strap (1)

“Memory Stick” (16 MB) (1)

CD-ROM (USB driver SPVD-004) (1)

Operating Instructions (1)

Design and specifications are subject to change without notice.

Finder/LCD screen indicators

The indicators during recording still images

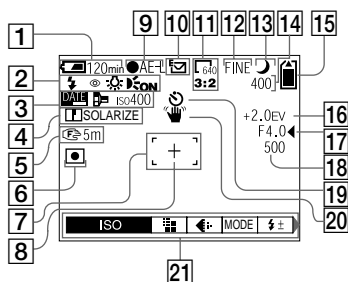

- 1 Battery remaining indicator
- 2 Flash mode/
Red eye reduction/
White balance/
Hologram AF indicator
- 3 Date/time/
Conversion lens/
ISO number indicator
- 4 Sharpness/
Picture effect indicator
- 5 Macro /focus distance
indicator
- 6 Metering modes indicator
- 7 AF frame
- 8 Spot light-metering cross hair
- 9 AE/AF lock indicator
- 10 Recording mode indicator
- 11 Image size indicator
- 12 Image quality indicator
- 13 Mode dial indicator/
NightShot/NightFraming
indicator
- 14 Remaining number of
recordable images indicator/
Self-diagnosis function
indicator
- 15 Remaining memory capacity
indicator
- 16 EV level indicator
- 17 Aperture value indicator
- 18 Shutter speed indicator
- 19 Self-timer indicator
- 20 Light amount warning indicator
- 21 Menu and guide menu
Pressing MENU switches the
menu on/off.

The indicators during recording moving images

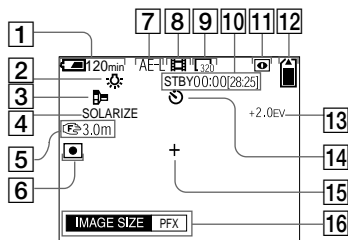

- | | |
|---|--|
| <p>1 Battery remaining indicator</p> <p>2 White balance indicator</p> <p>3 Conversion lens indicator</p> <p>4 Picture effect indicator</p> <p>5 Macro /focus distance indicator</p> <p>6 Metering modes indicator</p> <p>7 AE lock indicator</p> <p>8 Recording mode indicator</p> <p>9 Image size indicator</p> <p>10 Recording time [maximum recordable time] indicator/
Self-diagnosis function indicator</p> | <p>11 NightShot indicator</p> <p>12 Remaining memory capacity indicator</p> <p>13 EV level indicator</p> <p>14 Self-timer indicator</p> <p>15 Spot light-metering cross hair</p> <p>16 Menu and guide menu
Pressing MENU switches the menu on/off.</p> |
|---|--|

When playing back still images

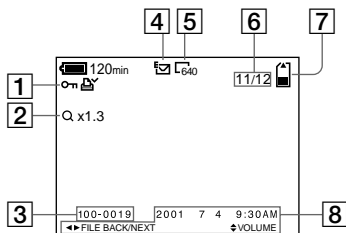

- | | |
|---|---|
| <p>1 Protect/print mark indicator</p> <p>2 Zoom scaling indicator</p> <p>3 File name</p> <p>4 Recording mode indicator</p> <p>5 Image size indicator</p> | <p>6 Image number/Number of stored images in "Memory Stick"</p> <p>7 Remaining memory capacity indicator</p> <p>8 Recording date of the playback image/menu and guide menu</p> |
|---|---|

When playing back moving images

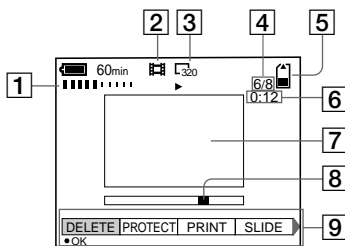

- | | |
|--|---|
| <p>1 VOL. (Volume) indicator</p> <p>2 Recording mode indicator</p> <p>3 Image size indicator</p> <p>4 Image number/Number of stored images in "Memory Stick"</p> | <p>5 Remaining memory capacity indicator</p> <p>6 Counter</p> <p>7 Playback image</p> <p>8 Play bar</p> <p>9 Menu and guide menu</p> |
|--|---|

Index

A

Adjusting the exposure ... 73
AE LOCK 62
AE/AF lock 21
AF frame 21
Aperture priority mode ... 63
Auto power-off function 22
Auto red-eye reduction
..... 27, 92

B

Battery pack
battery life 13
charging 12
BEEP 93
BRACKET 66
Brightness
finder 93
image 73
LCD 93
BURST 3 66

C

Center-weighted metering .. 76
Charging the battery pack... 12
Cleaning 95
Clip Motion 70
Control button 19
Conversion lens 93
COPY 87

D

DATE/TIME 76
DELETE 83
DEMO 94
Digital zoom 24
DIVIDE 90

E

E-MAIL 67
Enlarging a part of a still
image 79
EXP BRKTG 66
EXPANDED FOCUS
..... 72, 92

F

File name 51
Flash 26
FLASH LEVEL 27, 54
Focusing 72
Focusing manually 72
FORMAT 91

G

GIF 52, 70

H

Hologram AF 28

I

Image
deleting 83
print mark 88
protect 84
size 60
INDEX screen 78
"InfoLITHIUM" battery
pack 11, 97
ISO number 54

J

Jog dial 58
JPEG 21, 52

M

Macro recording 73
Manual exposure mode... 64
"Memory Stick" 18, 96
Menu 20
MOBILE mode 70
Mode dial 19
Moisture condensation... 95
Moving images
playing back 36
recording 32
MPEG 32, 52
MPEG MOVIE 32
Multi-pattern metering... 76

N

NightFraming 30
NightShot 29, 33
NR slow shutter 63
NTSC system 98
Number of recordable
images
Clip Motion 71
E-mail mode 68
Image size 61
TIFF mode 69
VOICE mode 69

P

PAL system 98
Picture effect 75
Playing back
moving images 36
still images 35
Power supply
AC power adaptor 15
battery pack 11
PRINT MARK 88
PROTECT 84

Q

Quick Review 23

R

REC MODE 54
Recording
moving images 32
still images 21
RESET button 9, 99
RESIZE 86
ROTATE 81

S

Scene selection 65
SCN 65
Screen indicators 109
SECAM system 98
Self-diagnosis display ... 107
Self-timer 26, 33
SET UP 92
Setting the date and time ... 16
SHARPNESS 54
Shutter speed priority mode
..... 63
Single-image screen 78
SLIDE SHOW 80
Spot metering 76
Still images
playing back 35
recording 21

T

TIFF 52, 69
Trimming 79
Triple-image screen 78
TV color system 98

U

USB 39, 48
Using your camera abroad
..... 98

V

VIDEO OUT 93
Viewing images
on a TV screen 82
using a computer 38
VOICE 68

W

Warning and notice
messages 105
WHITE BALANCE 74

Z

Zoom 24, 79

<http://www.world.sony.com/>

Printed on recycled paper

Sony Corporation Printed in Japan



307106412