

# *Video Cassette Recorder*

---

## Operating Instructions

The SmartFile function in this model meets the requirements of EU, EFTA,  
Central and Eastern Europe

**CE 0499** 



**Hi-Fi**

**SHOWVIEW<sup>®</sup>**

***SLV-SF950N***

## WARNING

To prevent fire or shock hazard, do not expose the unit to rain or moisture.

To avoid electrical shock, do not open the cabinet. Refer servicing to qualified personnel only.

Mains lead must only be changed at a qualified service shop.

## Precautions

### Safety

- This unit operates on 220 – 240 V AC, 50 Hz. Check that the unit's operating voltage is identical with your local power supply.
- If anything falls into the cabinet, unplug the unit and have it checked by qualified personnel before operating it any further.
- The unit is not disconnected from the mains as long as it is connected to the mains, even if the unit itself has been turned off.
- Unplug the unit from the wall outlet if you do not intend to use it for an extended period of time. To disconnect the cord, pull it out by the plug, never by the cord.

### Installing

- Allow adequate air circulation to prevent internal heat buildup.
- Do not place the unit on surfaces (rugs, blankets, etc.) or near materials (curtains, draperies) that may block the ventilation slots.
- Do not install the unit near heat sources such as radiators or air ducts, or in a place subject to direct sunlight, excessive dust, mechanical vibration or shock.
- Do not install the unit in an inclined position. It is designed to be operated in a horizontal position only.
- Keep the unit and cassettes away from equipment with strong magnets, such as microwave ovens or large loudspeakers.
- Do not place heavy objects on the unit.
- If the unit is brought directly from a cold to a warm location, moisture may condense inside the VCR and cause damage to the video head and tape. When you first install the unit, or when you move it from a cold to a warm location, wait for about three hours before operating the unit.

### Caution

Television programmes, films, video tapes and other materials may be copyrighted. Unauthorized recording of such material may be contrary to the provisions of the copyright laws. Also, use of this recorder with cable television transmission may require authorization from the cable television transmitter and/or programme owner.

## Compatible colour systems

This VCR is designed to record using the PAL (B/G or D/K) or MESECAM (B/G or D/K) colour system and playback using the PAL (B/G or D/K) or MESECAM (B/G or D/K) and NTSC 4.43 colour systems. Recording of video sources based on other colour systems cannot be guaranteed.

SHOWVIEW is a registered trademark of Gemstar Development Corporation. The SHOWVIEW system is manufactured under license from Gemstar Development Corporation.

SmartFile is a trademark of Sony Corporation.

# Table of contents

## Getting Started

- 4 Step 1 : Unpacking
- 5 Step 2 : Setting up the remote commander
- 9 Step 3 : Connecting the VCR
- 16 Step 4 : Tuning your TV to the VCR
- 19 Step 5 : Setting up the VCR with the Auto Set Up function
- 21 Step 6 : Setting the clock
- 25 Selecting a language
- 26 Presetting channels
- 30 Setting/changing the station names
- 32 Changing/disabling programme positions
- 36 Setting the PAY-TV/Canal Plus decoder

## Basic Operations

- 41 Playing a tape
- 44 Recording TV programmes
- 48 Recording TV programmes using the ShowView system
- 53 Setting the timer manually

## Additional Operations

- 56 Playing/searching at various speeds
- 58 Setting the recording duration time
- 59 Synchronized Recording
- 61 Checking/changing/cancelling timer settings
- 63 Recording stereo and bilingual programmes
- 65 Searching using the index function
- 66 Adjusting the picture
- 68 Changing menu options

## Editing

- 71 Connecting to a VCR or stereo system
- 73 Basic Editing

## SmartFile function

- 74 About the SmartFile function
- 76 Recording using the SmartFile function
- 81 Selecting and playing a programme
- 82 Checking the contents of a tape
- 84 Labelling a recorded programme and tape
- 92 Registering the contents of a recorded tape in the SmartFile label
- 94 Protecting a recorded programme
- 96 Erasing the data of an unwanted programme

## Additional Information

- 98 Troubleshooting
- 104 Specifications
- 105 Index to parts and controls
- 110 Menu chart

## Back cover

- Index

# Step 1 : Unpacking

Check that you have received the following items with the VCR:

- Remote commander

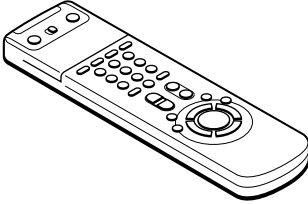

- Aerial cable



- R6 (size AA) batteries

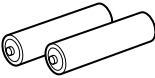

- SmartFile labels

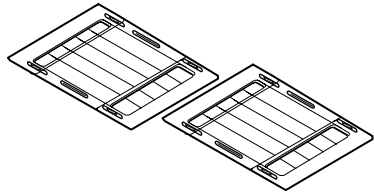

## Step 2 : Setting up the remote commander

### Inserting the batteries

Insert two R6 (size AA) batteries by matching the + and – on the batteries to the diagram inside the battery compartment.

Insert the negative (–) end first, then push in and down until the positive (+) end clicks into position.

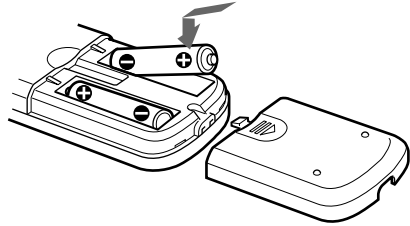

### Using the remote commander

You can use this remote commander to operate this VCR and a Sony TV. Buttons on the remote commander marked with a dot (•) can be used to operate your Sony TV. If the TV does not have the  symbol near the remote sensor, this remote commander will not operate the TV.

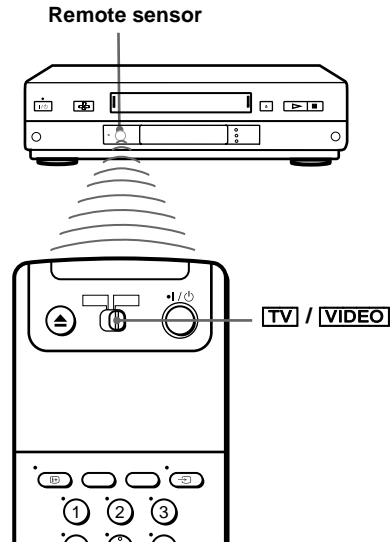

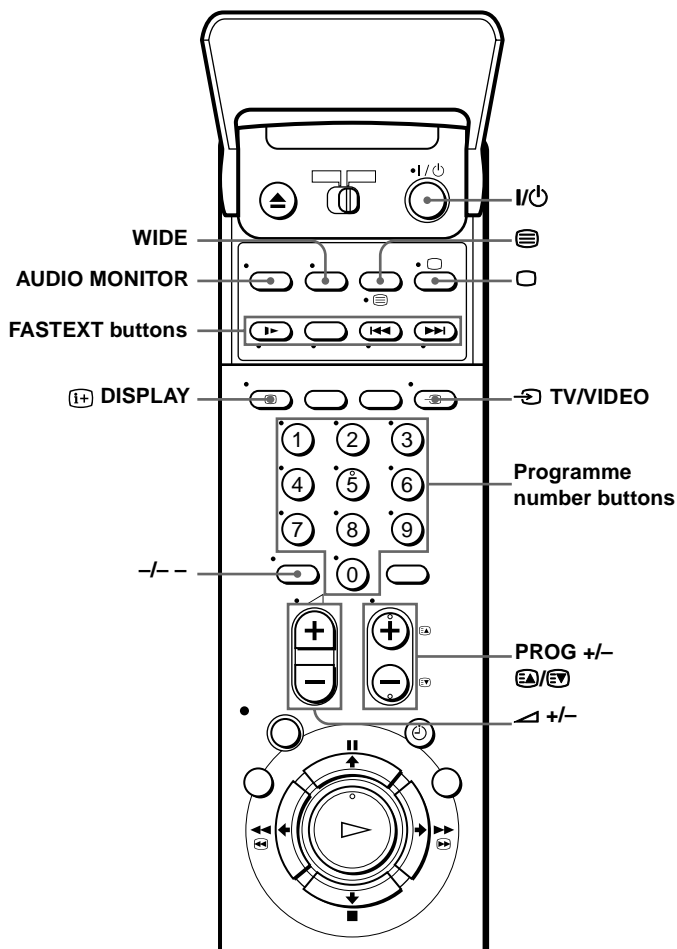

To operate	Set <b>TV / VIDEO</b> to
the VCR	<b>VIDEO</b> and point at the remote sensor on the VCR
a Sony TV	<b>TV</b> and point at the remote sensor on the TV

**continued**



### TV control buttons

To	Press
Set the TV to standby mode	I/O
Select an input source aerial in or line in	TV/VIDEO
Select the TV's programme position	Programme number buttons, -/--, PROG +/-
Adjust the TV's volume	+/-
Switch to TV (Teletext off)	(TV)
Switch to Teletext	(Teletext)
Select the sound	AUDIO MONITOR
Use FASTTEXT	FASTEXT buttons

To	Press
Call up the on-screen display	 DISPLAY
Change the Teletext page	
Switch to/from wide mode of a Sony wide TV (For other manufactures' wide TVs, see "Controlling other TVs with the remote commander".)	WIDE

### Notes

- With normal use, the batteries should last about three to six months.
- If you do not use the remote commander for an extended period of time, remove the batteries to avoid possible damage from battery leakage.
- Do not use a new battery with an old one together.
- Do not use different types of batteries together.
- Some buttons may not work with certain Sony TVs.







## Controlling other TVs with the remote commander

The remote commander is preprogrammed to control non-Sony TVs. If your TV is listed in the table below, set the appropriate manufacturer's code number.

**1** Set TV/VIDEO at the top of the remote commander to TV.

**2** Hold down I/⏻, and enter your TV's code number(s) using the programme number buttons. Then release I/⏻.

Now you can use the following TV control buttons to control your TV:

I/⏻, TV/VIDEO, programme number buttons, -- (ten's digit), PROG +/-,  +/-,  (TV),  (Teletext), FASTTEXT buttons, WIDE\*, MENU\*, \*/\*/\*/\*, and OK\*.

\* These buttons may not work with all TVs.

### Tip

- When you set your TV's code number correctly while the TV is turned on, the TV turns off automatically.

**continued**

## Code numbers of controllable TVs

If more than one code number is listed, try entering them one at a time until you find the one that works with your TV.

To switch to wide mode, see the footnotes below this table for the applicable code numbers.

Manufacturer	Code number	Manufacturer	Code number
Sony	01 <sup>*1</sup> , 02, 03, 04, 05	NEC	66
Aiwa	32	Nokia	15, 16, 69 <sup>*3</sup>
Akai	68	Nordmende	35, 42
Blaupunkt	10, 21	Orion	47, 48
Brionvega	40	Panasonic	17 <sup>*1</sup> , 49
C.G.M	09	Philips	06 <sup>*1</sup> , 07 <sup>*1</sup> , 08 <sup>*1</sup>
Colonad	03	Phonola	18, 19
Dual	44	Pioneer	26
Emerson	03, 04	Saba	12, 13
Fenner	30, 31	Samsung	22, 23
Ferguson	52	Sanyo	25
Goldstar	03, 04, 17	Schneider	46
Grundig	10 <sup>*1</sup> , 11 <sup>*1</sup>	Seleco	14
Hitachi	24	Sharp	29
Hyper	31	Siemens	39
Inno-Hit	41	Sinudyne	37
Irradio	20	TEAC	67
ITT	15, 16, 69 <sup>*3</sup>	Telefunken	36
JVC	33	Thomson	43 <sup>*2</sup>
Loewe	45	Toshiba	38
Mitsubishi	27 <sup>*1</sup> , 28 <sup>*1</sup> , 50 <sup>*1</sup> , 51 <sup>*1</sup>	White Westinghouse	34
Mivar	09		

\*1 Press WIDE to switch to the wide picture mode you want.

\*2 Press WIDE, then press  $\triangle$  +/- to select the wide picture mode you want.

\*3 Press WIDE. The menu appears on the TV screen. Then, press  $\uparrow/\downarrow/\leftarrow/\rightarrow$  to select the wide picture you want and press OK.

### Notes

- If the TV uses a different remote control system from the one programmed to work with the VCR, you cannot control your TV with the remote commander.
- If you enter a new code number, the code number previously entered will be erased.
- If you remove the batteries of the remote commander for more than a few minutes, the code number may be reset to 01 (Sony). In this case, reset the appropriate code number.



## Step 3 : Connecting the VCR

We recommend connecting your VCR to your TV using a Scart (EURO-AV) cable. You must still connect your VCR to your TV with an aerial cable as well.

If you use the Scart (EURO-AV) cable for connecting, you will improve the picture and sound quality playback of your VCR and make the setting up easier.

- Connection to TV with an aerial cable only, see page 12.
- Connection to TV and Set-Top Box, see page 13.
- Connection to TV and decoder, see page 36.

### Connection to your TV with a Scart (EURO-AV) connector

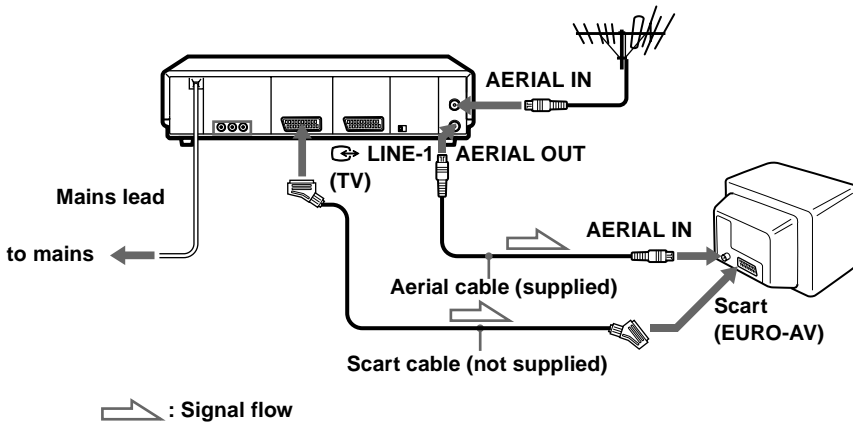

1

Disconnect the aerial cable from your TV and connect it to AERIAL IN on the rear panel of the VCR.

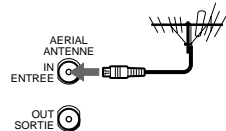

2

Connect AERIAL OUT of the VCR and the aerial input of your TV using the supplied aerial cable.

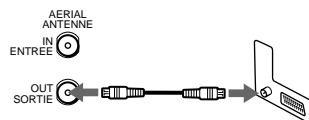

continued

---

# 3

Connect LINE-1 (TV) on the VCR and the Scart (EURO-AV) connector on the TV with the optional Scart cable.

This connection improves picture and sound quality. Whenever you want to watch the VCR picture, press  TV/VIDEO to display the VIDEO indicator in the display window.

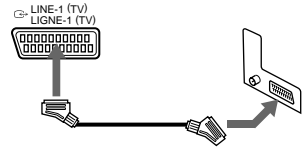

---

# 4

Connect the mains lead to the mains.

You can now tune your TV to the VCR, see page 18.

---

## Notes

- If the TV is connected to the LINE-1 (TV) connector, setting the RF channel to OFF is recommended (see page 18). In the OFF position, only the signal from the aerial is output through the AERIAL OUT connector.
- For correct SmartLink connection, please refer to your TV's instruction manual.

## About the SMARTLINK features

If the connected TV complies with SMARTLINK, NexTVView Link, MEGALOGIC<sup>\*1</sup>, EASYLINK/CinemaLink<sup>\*2</sup>, Q-Link<sup>\*3</sup> or T-V LINK<sup>\*</sup>, you can use the



SMARTLINK

SMARTLINK function after you complete the steps on the previous page (the SMARTLINK indicator appears in the VCR's display window when you turn on the TV). You can enjoy the following SMARTLINK features.

- **Preset Download**  
You can download your TV tuner preset data to this VCR and tune the VCR according to that data in Auto Set Up. This greatly simplifies the Auto Set Up procedure. Be careful not to disconnect the cables or exit the Auto Set Up function during the procedure. See "Setting up the VCR with the Auto Set Up function" on page 19.
- **TV Direct Rec**  
You can easily record what you are watching on the TV (other than tapes being played on this VCR). For details, see "Recording what you are watching on the TV (TV Direct Rec)" on page 47.
- **One Touch Play**  
With One Touch Play, you can start playback automatically without turning on the TV. For details, see "Starting playback automatically with one button (One Touch Play)" on page 43.
- **One Touch Menu**  
You can turn on the VCR and TV, set the TV to the video channel, and display the VCR's on-screen display automatically by pressing MENU on the remote commander.
- **One Touch Timer**  
You can turn on the VCR and TV, set the TV to the video channel, and display the timer recording menu (the TIMER METHOD menu, the TIMER menu or the SHOWVIEW menu) automatically by pressing  TIMER on the remote commander. You can set which timer recording menu is displayed using TIMER OPTIONS in the OTHER OPTIONS menu (see page 70).
- **Automatic Power off**  
You can have the VCR turn off automatically, if the VCR is not used for about 1 minute, after you turn off the TV.
- **NexTVView Download**  
You can easily set the timer by using the NexTVView Download function on your TV. Please refer to your TV's instruction manual.

<sup>\*1</sup> "MEGALOGIC" is a registered trademark of Grundig Corporation.

<sup>\*2</sup> "EASYLINK/CinemaLink" is a trademark of Philips Corporation.

<sup>\*3</sup> "Q-Link" is a trademark of Panasonic Corporation.

<sup>\*4</sup> "T-V LINK" is a trademark of JVC Corporation.

### Note

- Not all TVs respond to the functions above.

**continued**

## Connection to your TV with an aerial cable only

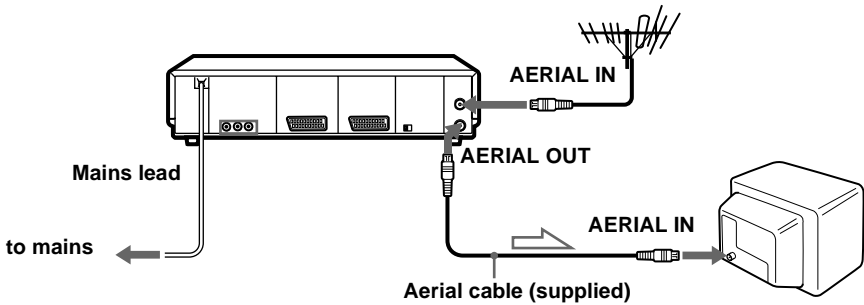

 : Signal flow

**1**

Disconnect the aerial cable from your TV and connect it to AERIAL IN on the rear panel of the VCR.

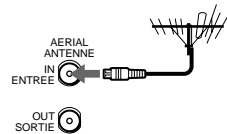

**2**

Connect AERIAL OUT of the VCR and the aerial input of your TV using the supplied aerial cable.

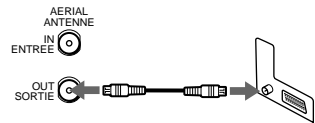

**3**

Connect the mains lead to the mains.

You can now tune your TV to the VCR, see page 16.

## Connection to your TV and Set-Top Box (STB)

If you don't use a STB, skip to page 16.

The illustration below shows an example of connecting the STB to LINE-3 IN.

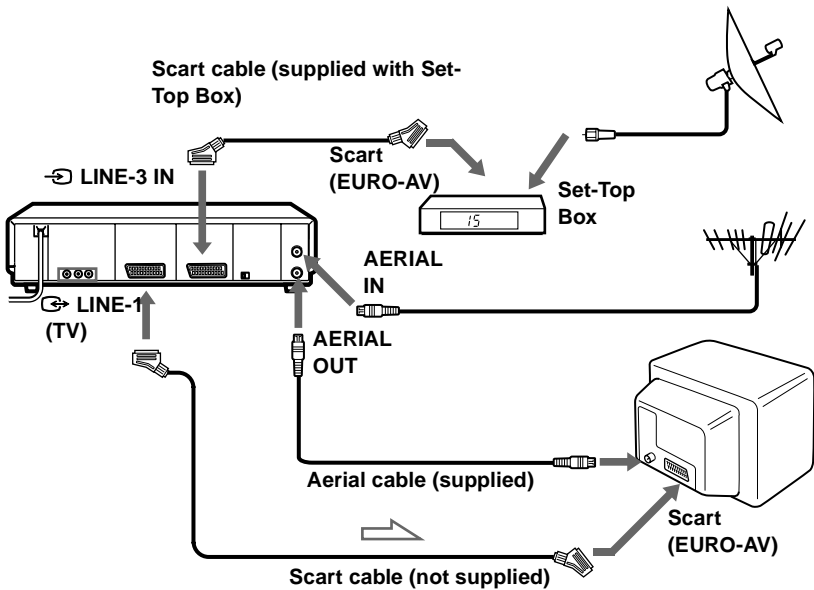

 :Signal flow

You can watch programmes from the Set-Top Box connected to this VCR on your TV even when the VCR is turned off using the Line Through function. When you turn on the STB, this VCR automatically sends the signal from the STB to the TV without turning itself on

- 1** Connect the STB to the DECODER/LINE-3IN connector as shown above.
- 2** Set DECODER/LINE-3 to LINE-3 in the OTHER OPTIONS menu.
- 3** Set POWER SAVE to OFF in the OTHER OPTIONS menu.
- 4** Turn off the VCR.  
To watch a programme from the STB, turn on the STB and your TV.

### Note

- You cannot watch programmes from your STB on the TV while recording unless you record a programme from your STB.

**continued**

# If your STB does not have a Scart (EURO-AV) connector

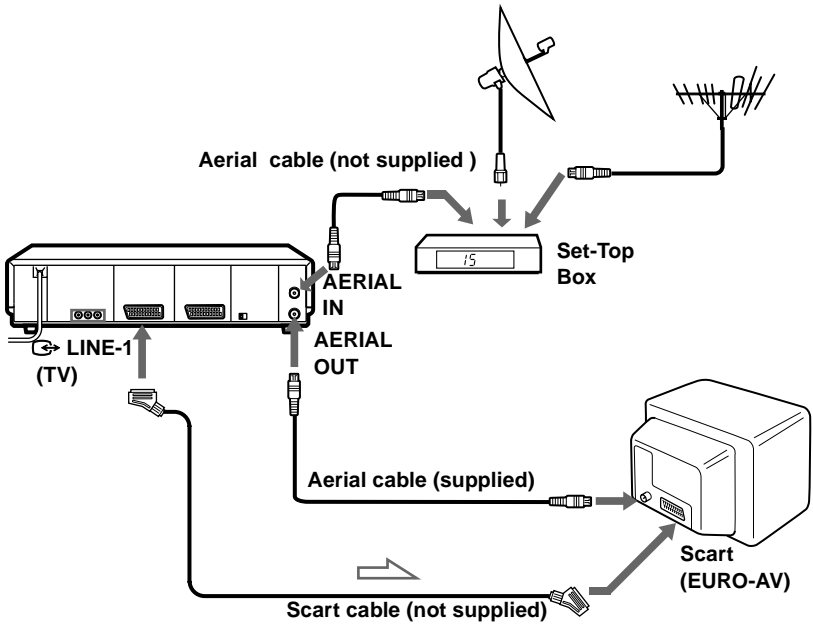

 :Signal flow

## Additional connections

### To a stereo system

You can improve sound quality by connecting a stereo system to the AUDIO OUT R/L jacks as shown on the right.

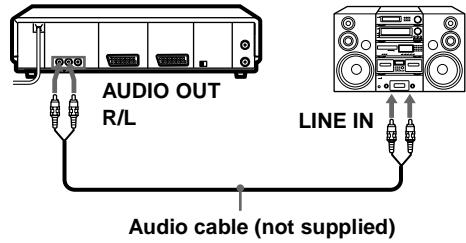

### To a TV that has phono type audio/video input jacks (only if you don't connect the VCR and your TV using a Scart connector)

This additional connection improves picture and sound quality. Connect the TV as shown on the right using a commercially available connecting cable like the Sony VMC-810. If your TV has only one audio input jack, use a connecting cable like the Sony VMC-910MS.

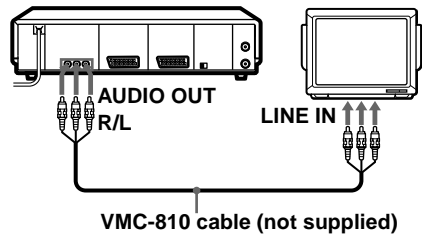

## Step 4 : Tuning your TV to the VCR

If you have connected the VCR to your TV using the Scart cable, skip to page 18.

### If you have connected the VCR to your TV with an aerial cable only

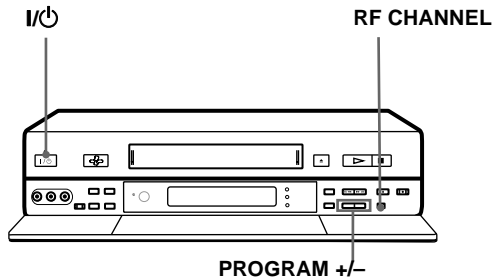

**1**

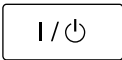

Turn on your TV and press I/⏻ (on/standby) to turn on the VCR.  
Pull down the drop down panel.

**2**

AUTO SET UP  
RF CHANNEL



Press briefly RF CHANNEL on the VCR.

The factory-preset RF (Radio Frequency) channel appears in the display window.

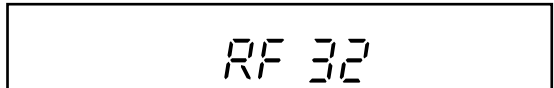

**3**

Turn on your TV and select an unused programme position for the VCR picture (for ex. programme position "0").

This programme position will be referred to as the video channel (for watching your VCR on the TV) after tuning is completed.



- 4** AUTO SET UP Press RF CHANNEL.  
 RF CHANNEL The TV system appears in the display window.

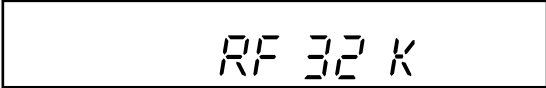

RF 32 K

- 5** Press PROGRAM +/- (repeatedly) to select the correct TV system. If you watch the system B/G, select "G". If you watch the system D/K, select "K".

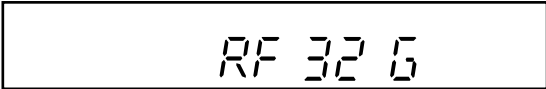

RF 32 G

- 6** Tune in the programme position you have selected (for ex. programme position "0") until the picture on the right appears clearly on the TV screen (background must be green).

Refer to your TV manual for tuning instructions.

If the picture does not appear clearly, see "To obtain a clear picture from the VCR" below.

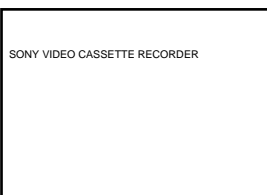

- 7** AUTO SET UP Press RF CHANNEL.  
 RF CHANNEL You have now tuned your TV to the VCR. From now on, whenever you want to play a tape, set the TV to the video channel (for ex. programme position "0").

### To check if the TV tuning is correct

Set the TV to the video channel (for ex. programme position "0") and press PROGRAM +/- on the VCR. If the TV screen changes to a different programme each time you press PROGRAM +/-, the TV tuning is correct.

### To obtain a clear picture from the VCR

If the picture does not appear clearly in step 6 above, go to step 7 to finish this procedure once. Then start from step 2. After pressing RF CHANNEL in step 2 to display the RF CHANNEL, press PROGRAM +/-, so that another RF channel appears. Then tune the TV to the new RF channel until a clear picture appears.

**continued**

## If you have connected your VCR to the TV with a Scart (EURO-AV) connector and an aerial cable as well

*In order to avoid any interferences with existing broadcasts, we recommend you to set RF channel to the OFF position.*

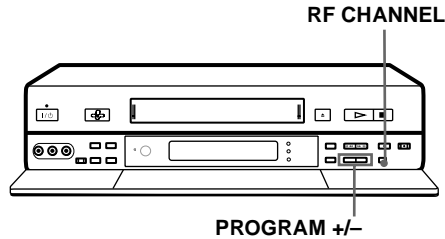

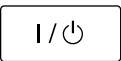
- 
- 1**  Turn on your TV and press I/⏻ (on/standby) to turn on the VCR. Pull down the drop down panel.

- 
- 2**  Press briefly RF CHANNEL on the VCR. The factory-preset RF (Radio Frequency) channel appears in the display window..

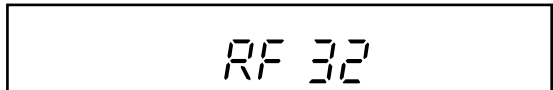

- 
- 3**  Press PROGRAM +/- until the OFF indication appears in the display window. The RF channel is then switched off.

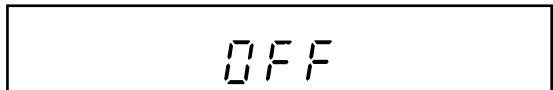

The picture shown below appears clearly on the TV screen (background must be green).



- 
- 4**  Press RF CHANNEL. You can now set the VCR with the Auto Set Up function (see page 19).

### Note

- If in step 3 the green screen does not appear, select the "AV/EXTERNAL" source on your TV (please refer to your TV instruction manual).

# Step 5 : Setting up the VCR with the Auto Set Up function

Before using the VCR for the first time, set up the VCR using the Auto Set Up function. With this function, you can set the language for the on-screen display, TV channels, guide channels for the ShowView system, and VCR clock automatically.

## Before you start ...

- Turn on the STB if it is connected to the VCR only by the aerial cable and not to the Scart cable.

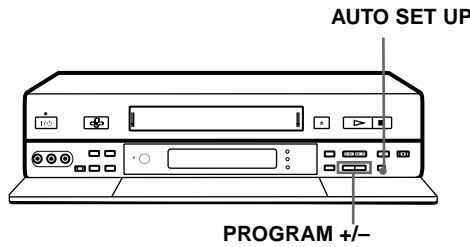

- 1** Hold down **AUTO SET UP** on the VCR for more than 3 seconds. The VCR automatically turns on, and the country abbreviation appears in the display window.

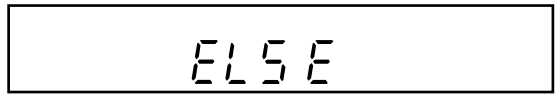
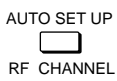

- 2** Press **PROGRAM +/-** to highlight the abbreviation of your country. For some countries, there is a selection of languages to choose from. The abbreviations of the countries and languages are as follows :

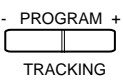

**continued**

Abbreviation	Country	Language
CZ	Czech	Czech
HUN	Hungary	Hungarian
PL	Poland	Polish
RUS	Russia	Russian
ELSE	Other countries	English

If your country does not appear in the list, select ELSE.

**3**

AUTO SET UP Press AUTO SET UP.



RF CHANNEL

The VCR starts searching for all of the receivable channels and presets them in the appropriate order for your local area.



If you use the SMARTLINK connection, the Preset Download function starts and the SMARTLINK indicator flashes in the display window during download.

After the search or download is complete, the current time appears in the display window for any stations that transmit a time signal.

### To cancel the Auto Set Up function

Press AUTO SET UP.

#### Tip

- If you want to change the language for the on-screen display from the one preset in the Auto Set Up function, see page 25.

#### Notes

- Do not cancel the Auto Set Up function during step 3. If you do, repeat Auto Set Up from the beginning.
- When you operate the Auto Set Up function, some of the settings (ShowView, timer etc...) will be reset. In this case, you have to set them again.

## Step 6 : Setting the clock

You must set the time and date on the VCR to use the timer recording features properly. If the VCR clock was not set in the Auto Set Up procedure, you need to set it manually.

The Auto Clock Set function works only if a station in your area is broadcasting a time signal. If the Auto Set Up function did not set the clock correctly for your local area, try another station for the Auto Clock Set function.

### Setting the clock manually

#### Before you start...

- Turn on the VCR and the TV.
- Set the TV to the video channel.

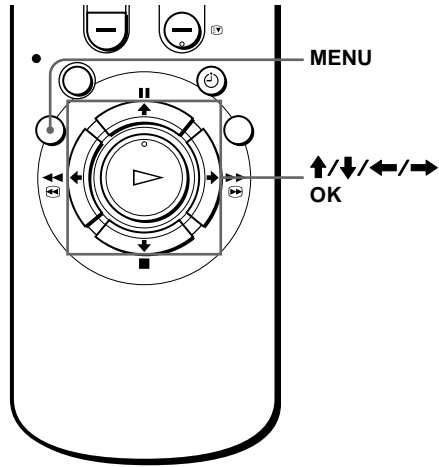

- 1** Press MENU, then press  $\uparrow/\downarrow$  to highlight SETTINGS and press OK.

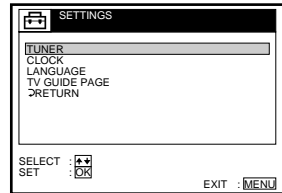
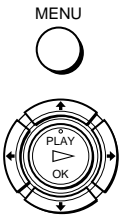

- 2** Press  $\uparrow/\downarrow$  to highlight CLOCK, then press OK.

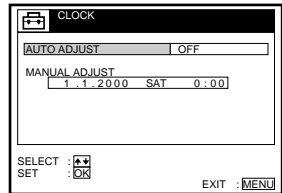

- 3** Press  $\uparrow/\downarrow$  to highlight MANUAL ADJUST, then press OK.

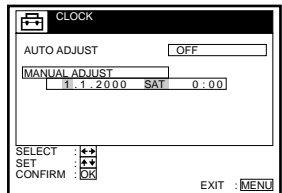

continued

4



Press **↑/↓** to set the date.

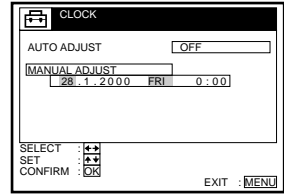

5



Press **→** to highlight the month and set the month pressing **↑/↓**.

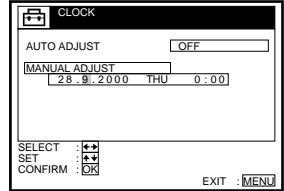

6



Set the year, hour, and minutes in sequence, pressing **→** to highlight the item to be set, and press **↑/↓** to select the digits.

The day of the week is set automatically.

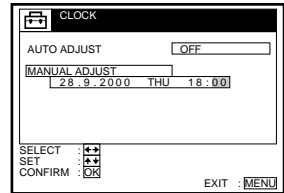

7



Press **OK** to confirm the setting and start the clock.

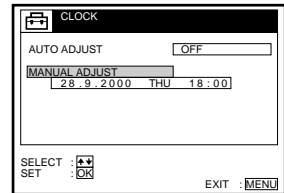

8



Press **MENU** to exit the menu.

**Tip**

- To change the digits while setting, press **←** to return to the item to be changed, and select the digits pressing **↑/↓**.

**Note**

- The menu disappears automatically if you don't proceed for more than a few minutes.

# Changing the station for the Auto Clock Set function

## Before you start...

- Turn on the VCR and the TV.
- Set the TV to the video channel.

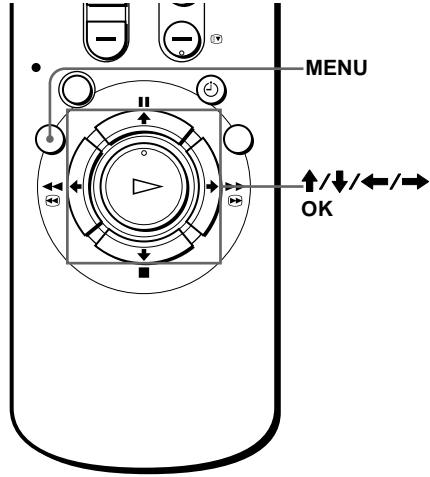

**1** Press MENU, then press  $\uparrow/\downarrow$  to highlight SETTINGS and press OK.

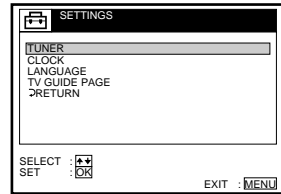
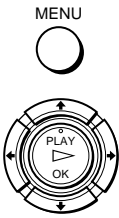

**2** Press  $\uparrow/\downarrow$  to highlight CLOCK, then press OK.



AUTO ADJUST is highlighted.

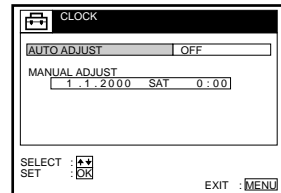

**3** Press OK.

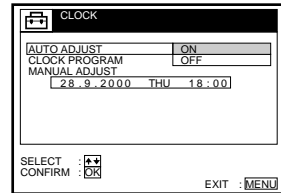

continued

**4**

Press **↑/↓** to highlight ON, then press OK.

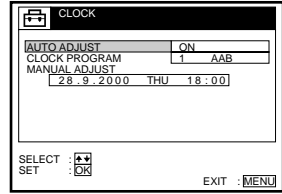
**5**

Press **↓** to highlight CLOCK PROGRAM, then press OK.

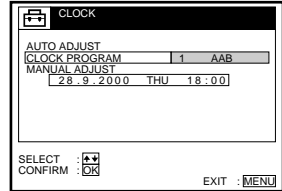
**6**

Press **↑/↓** until the programme position of the station that carries the time signal appears.

If the VCR does not receive the time signal from any station, AUTO ADJUST returns to OFF automatically.

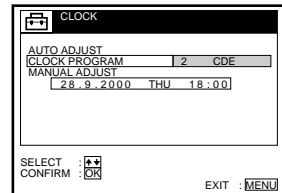
**7**

Press MENU to exit the menu.

### Tips

- To change the digits while setting, press **←** to return to the item to be changed, and select the digits using **↑/↓**.
- If you set AUTO ADJUST to ON, the Auto Clock Set function is activated whenever the VCR is turned off. The time is adjusted automatically by making reference to the time signal from the station whose programme position is displayed in the “CLOCK PROGRAM” row. If you do not need the Auto Clock Set function, select OFF.

### Note

- The menu disappears automatically if you don't proceed for more than a few minutes.



# Selecting a language

You can change the on-screen display language from the one you selected with the Auto Set Up function.

## Before you start...

- Turn on the VCR and the TV.
- Set the TV to the video channel.

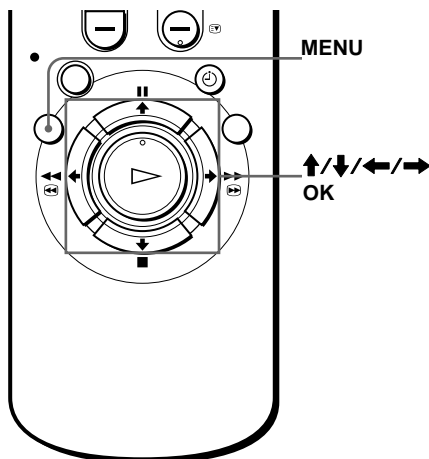

- 1** Press MENU, then press  $\uparrow/\downarrow$  to highlight SETTINGS and press OK.

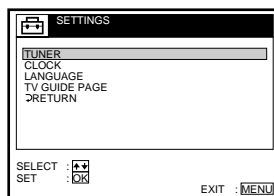
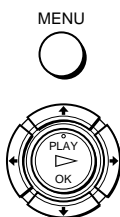

- 2** Press  $\uparrow/\downarrow$  to highlight LANGUAGE, then press OK.

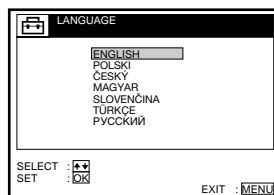

- 3** Press  $\uparrow/\downarrow/\leftarrow/\rightarrow$  to highlight the desired language, then press OK.



## Note

- The menu disappears automatically if you don't proceed for more than a few minutes.

# Presetting channels

If some channels could not be preset using the Auto Set Up function, you can preset them manually.

## Before you start...

- Turn on the VCR and the TV.
- Set the TV to the video channel.

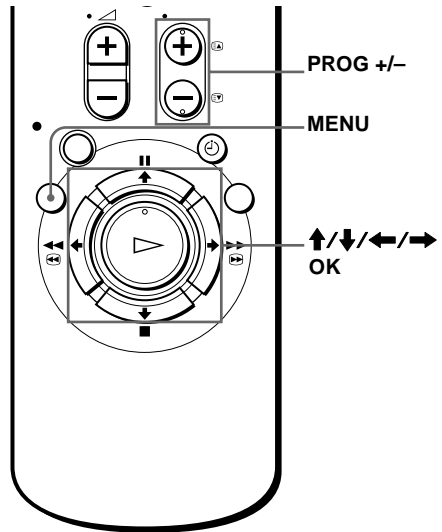

1

MENU

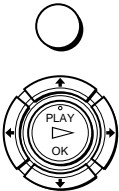

Press MENU, then press  $\uparrow/\downarrow$  to highlight SETTINGS and press OK.

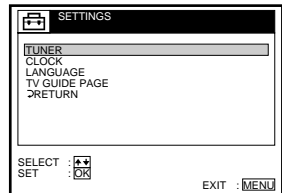

2



Press  $\uparrow/\downarrow$  to highlight TUNER, then press OK.

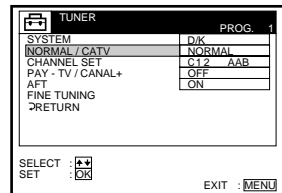

3



Press  $\uparrow/\downarrow$  to highlight NORMAL/CATV, then press OK.

Press  $\uparrow/\downarrow$  to highlight NORMAL, then press OK.

To preset CATV (Cable Television) channels, select CATV.

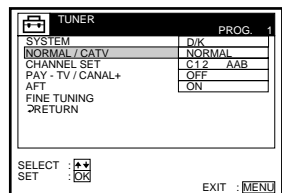

4



Press **↑/↓** to highlight CHANNEL SET.

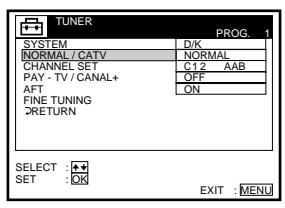

5



Press **PROG +/-** to select the programme position.

**Selected programme position**

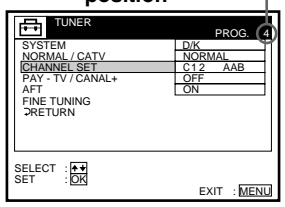

6



Press **OK** to highlight the channel number row, then press **↑/↓** to start tuning.

The VCR starts searching for a channel and displays the first one it finds on the TV screen. Press **↑/↓** repeatedly until the channel you want is displayed.

The channels are scanned in the following order:

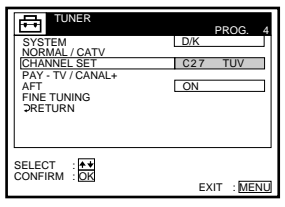

B/G TV system		D/K TV system	
Channel number in the CHANNEL SET field	Channel	Channel number in the CHANNEL SET field	Channel
C02	E2	C02	R1
C03	E3	C05	R6
C04	E4	C06	R7
C05	E5	C12	R12
C06	E6	C13	R2
C07	E7	C14	R3
C08	E8	C15	R4
C09	E9	C16	R5

**continued**

B/G TV system		D/K TV system	
Channel number in the CHANNEL SET field	Channel	Channel number in the CHANNEL SET field	Channel
C10	E10	C17	R8
C11	E11	C18	R9
C12	E12	C19	R10
C21-C69	E21-E69	C20	R11
CATV S01-S41	S01-S41	C21-C69	R21-R69
CATV S42-S46	S01-S05		

If you know the number of the channel you want, press the programme number buttons. For example, for channel 05, first press “0” and then press “5.”

7



If the sound is distorted or noisy, press OK then to highlight SYSTEM, then select B/G or D/K so that you can get the better sound. .

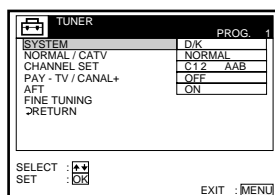

8



Press OK.

9

To allocate another channel to another programme position, repeat steps 4 to 8.

10



Press MENU to exit the menu.

## Disabling unwanted programme positions

After tuning the TV channels, you can disable unused programme positions. The disabled positions will be skipped later when you press the PROG +/- buttons. You can also disable unwanted programme positions using the CHANNEL LIST menu (see page 32).

- 1 In step 6 above, press programme number button “0” twice to display the number “00” beside CHANNEL SET.
- 2 Press OK to confirm the setting, then MENU to exit the menu.

## If the picture is not clear

Normally, the Auto Fine Tuning (AFT) function automatically tunes in channels clearly. If the picture is not clear, you may also use the manual tuning function.

- 1 Press PROG +/- or the programme number buttons to select the programme position for which you cannot obtain a clear picture.
- 2 Press MENU, then select SETTINGS and press OK.
- 3 Select TUNER, then press OK.
- 4 Select FINE TUNING.

The fine tuning meter appears.

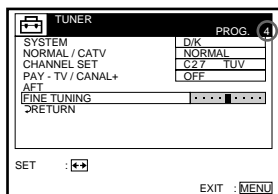

Selected programme position

- 5 Press ←/→ to get a clearer picture, then press MENU to exit the menu.  
Note that the AFT (Auto Fine Tuning) setting switches to OFF.

### Note

- The menu disappears automatically if you don't proceed for more than a few minutes.

# Setting/changing the station names

You can also set and change station names as you like up to 5 characters. The set station names are displayed on the TV screen when you change the programme position on the VCR.

## Before you start...

- Turn on the VCR and the TV.
- Set the TV to the video channel.

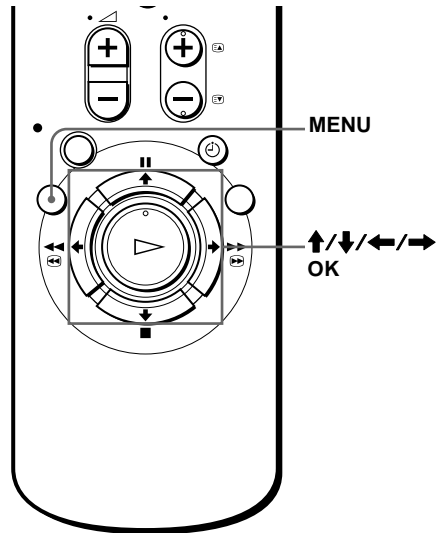

- 1** Press MENU, then press **↑/↓** to highlight LISTS and press OK.

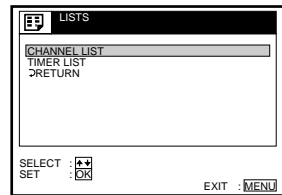
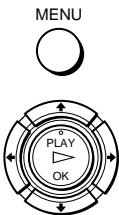

- 2** Press **↑/↓** to highlight CHANNEL LIST, then press OK.

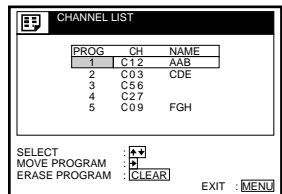

- 3** Press **↑/↓** to highlight the row on which you want to set or change the station name.



To display other pages for programme positions 6 to 60, press **↑/↓** repeatedly.

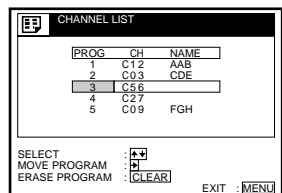

4



- If you want to set the station name, press **→** twice to highlight the station name column only.
- If you don't want to set the station name, go to step 7.

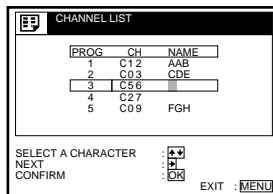

5



Enter the station name.

- 1 Press **↑/↓** to select a character.

Each time you press **↑**, the character changes as shown below.

A → B → ... → Z → a → b → ...  
 → z → 0 → 1 → ... → 9 →  
 (symbols) → (blank space) → A

- 2 Press **CURSOR→** to set the next character.

The next space is highlighted.

To correct a character, press **CURSOR←** until the character you want to correct is highlighted, then reset it.

You can set up to 5 characters for the station name.

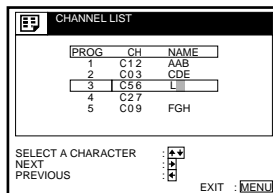

6

To change or to set the station name of another station, repeat steps 2 to 4.

7



Press **OK** to confirm the setting.

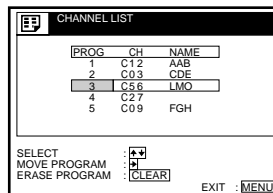

8

MENU



Press **MENU** to exit the menu.

### Note

- The menu disappears automatically if you don't proceed for more than a few minutes.

# Changing/disabling programme positions

After setting the channels, you can change the programme positions as you like. If any programme positions are unused or contain unwanted channels, you can disable them.

## Before you start...

- Turn on the VCR and the TV.
- Set the TV to the video channel.

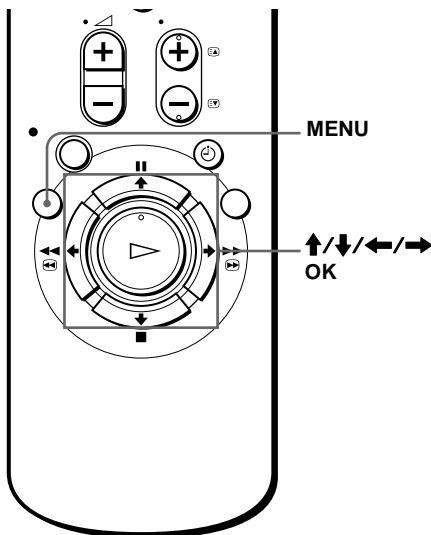

## Changing programme positions

1

MENU



Press MENU, then press  $\uparrow/\downarrow$  to highlight **LISTS** and press OK.

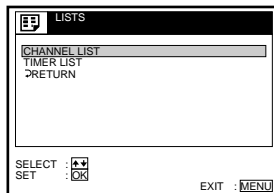

2



Press  $\uparrow/\downarrow$  to highlight **CHANNEL LIST**, then press OK.

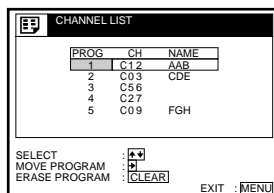



3



Press **↑/↓** to highlight the row on which you want to change the programme position, then press **→**.

To display other pages for programme positions 6 to 60, press **↑/↓** repeatedly.

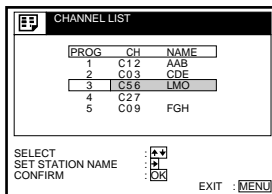

4



Press **↑/↓** until the selected channel row moves to the desired programme position.

The selected channel is inserted at the new programme position and the intermediate channels are displaced to fill the gap.

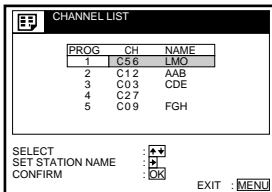

5



Press **OK** to confirm the setting.

6

To change the programme position of another station, repeat steps 3 to 5.

7



Press **MENU** to exit the menu.

**continued**

## Disabling unwanted programme positions

After presetting channels, you can disable unused programme positions. The disabled positions will be skipped later when you press the PROG +/- buttons.

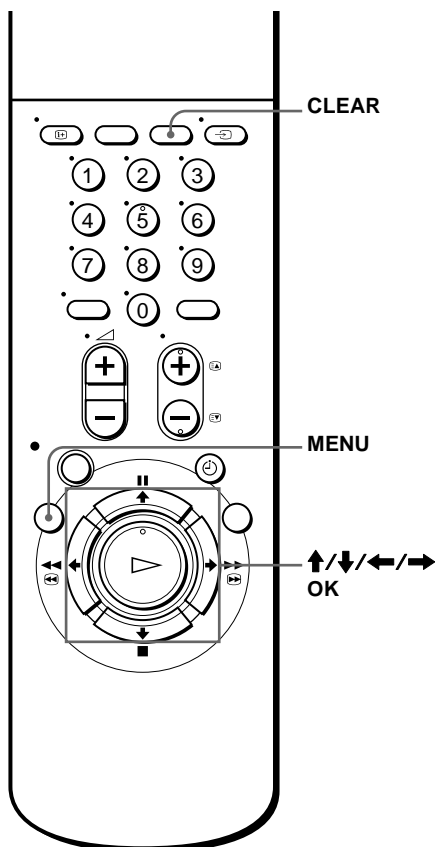

1

MENU

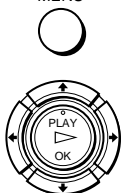

Press MENU, then press  $\uparrow/\downarrow$  to highlight **LISTS**, and press OK.

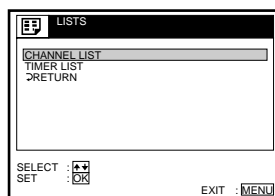

2



Press  $\uparrow/\downarrow$  to highlight **CHANNEL LIST**, then press OK.

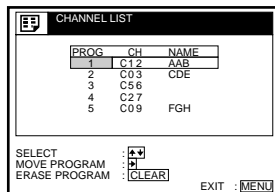

3



Press **↑/↓** to highlight the row which you want to disable.

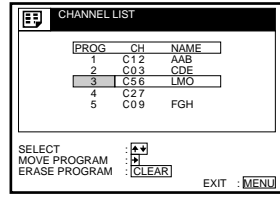

4



Press **CLEAR**.

The selected row will be cleared as shown on the right.

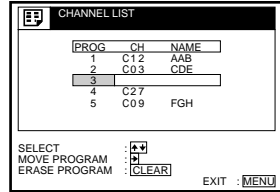

5

Repeat steps 3 and 4 for any other programme positions you want to disable.

6



Press **MENU** to exit the menu.

### Notes

- The menu disappears automatically if you don't proceed for more than a few minutes.
- Be sure to select the programme position you want to disable correctly. If you disable a programme position by mistake, you need to reset that channel manually.

# Setting the PAY-TV/Canal Plus decoder

You can watch or record PAY-TV/Canal Plus programmes if you connect a decoder (not supplied) to the VCR.

## Connecting a decoder

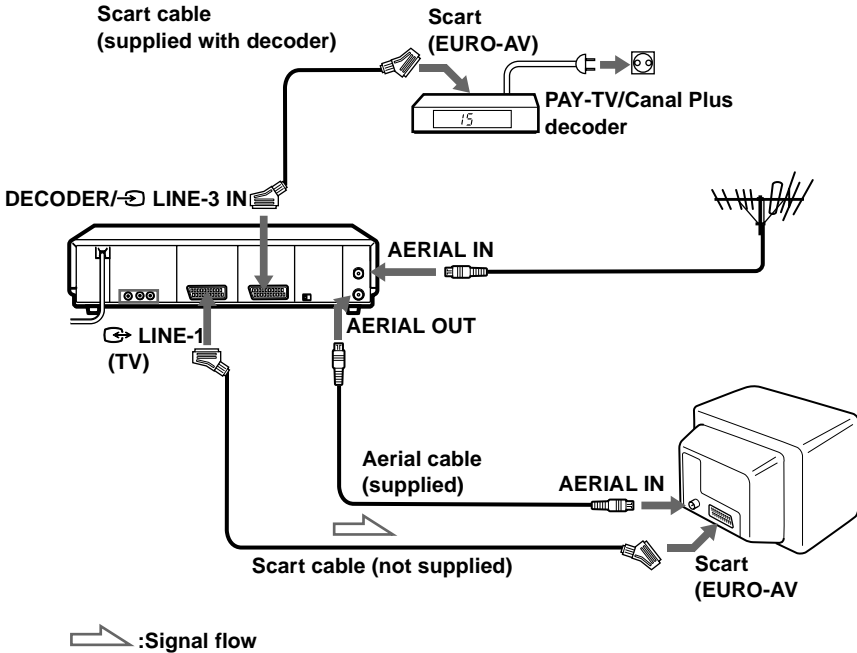

## Setting PAY-TV/Canal Plus channels

To watch or record PAY-TV/Canal Plus programmes, set your VCR to receive the channels using the on-screen display.

### Before you start...

- Turn on the VCR, the TV, and the decoder.
- Set the TV to the video channel.

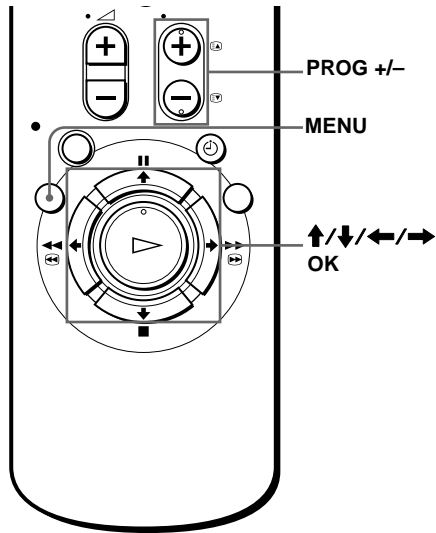

- 1** Press **MENU**, then press **↑/↓** to highlight **OPTIONS** and press **OK**.

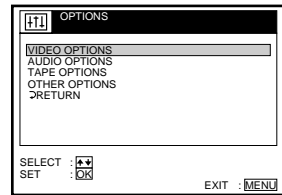
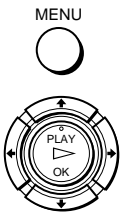

- 2** Press **↑/↓** to highlight **OTHER OPTIONS**, then press **OK**.

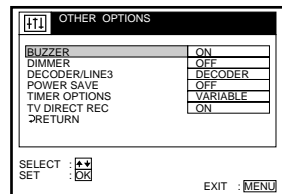

- 3** Press **↑/↓** to highlight **DECODER/LINE3**, then press **OK**.

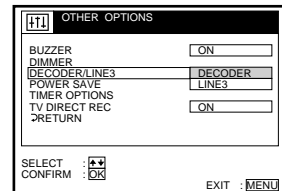

continued

4



Press **↑/↓** to highlight DEC., then press OK.

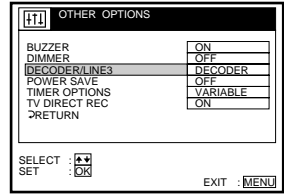

5



Press MENU to exit the menu.

6



Press MENU, then press **↑/↓** to highlight SETTINGS and press OK.

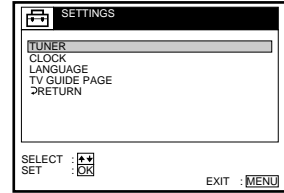

7



Press **↑/↓** to highlight TUNER, then press OK.

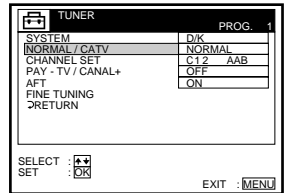

8



Press **↑/↓** to highlight NORMAL/ CATV, then press OK.

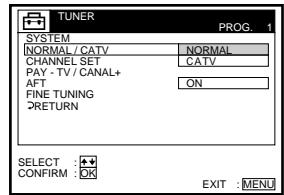

9



Press **↑/↓** to highlight **NORMAL**, then press **OK**.

To preset CATV (Cable Television) channels, select **CATV**.

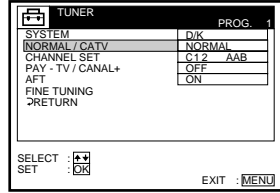

10

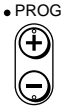

Press **PROG +/-** to select the desired programme position.

**Selected programme position**

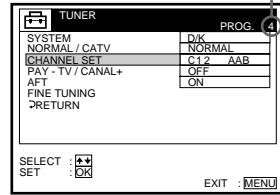

11



Press **↑/↓** to highlight **CHANNEL SET**, then press **OK**.

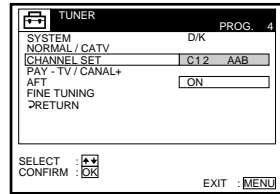

12



Press **↑/↓** to select the **PAY-TV/Canal Plus** channel.

When the desired channel is tuned, press **OK**.

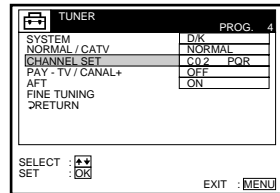

13



Press **↑/↓** to highlight **PAY-TV/CANAL+**, then press **OK**.

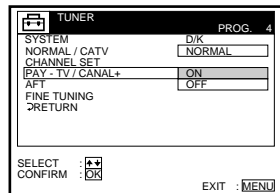

**continued**

14



Press **↑/↓** to highlight ON, then press OK.

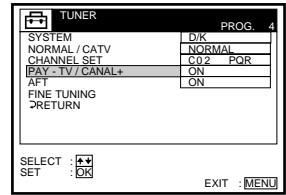

15



If the sound is distorted or noisy, press **↑/↓/ ←/→** to highlight SYSTEM, then select B/G or D/K so that you get the better sound.

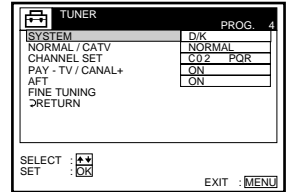

16

MENU



Press MENU to exit the menu.

**Notes**

- The menu disappears automatically if you don't proceed for more than a few minutes.
- To superimpose subtitles while watching PAY-TV/Canal Plus programmes, make both decoder-VCR and VCR-TV connections using 21-pin Scart cables that are compatible with the RGB signals. You cannot record subtitles on the VCR.
- Some PAY-TV/Canal Plus decoders may not work if you set the PAY-TV/CANAL + setting to ON. In this case, set it to OFF.



# Playing a tape

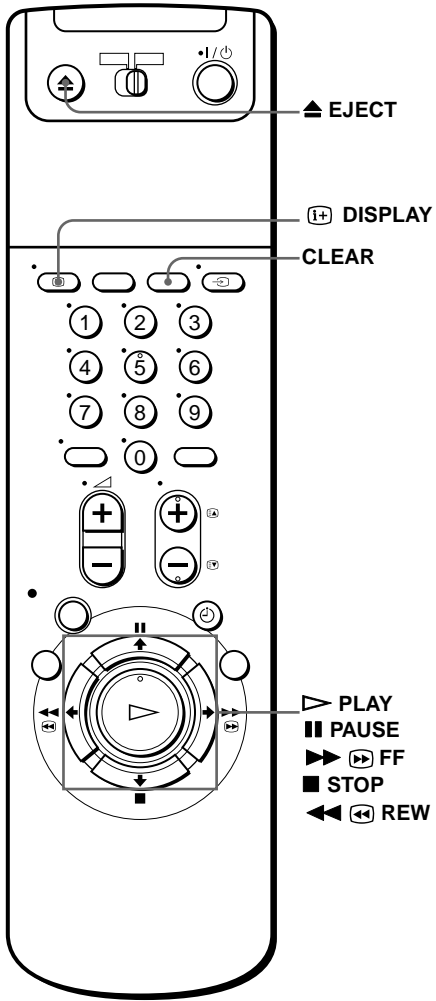
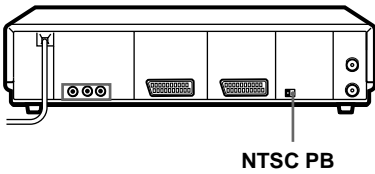

**1** Turn on your TV and set it to the video channel.

**2** Insert a tape.  
The VCR turns on and starts playing automatically if you insert a tape with its safety tab removed.

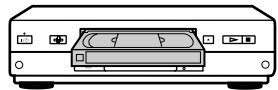

continued

**3**Press  PLAY.

When the tape reaches the end, it will rewind automatically.

**Additional tasks**

To	Press
Stop play	■ STOP
Pause play	PAUSE
Resume play after pause	PAUSE or  PLAY
Fast-forward the tape	▶▶ FF during stop
Rewind the tape	◀◀ REW during stop
Eject the tape	▲ EJECT

**To set the colour system**

If the playback picture has no colour or streaks appear during playback, set the COLOUR SYSTEM option in the VIDEO OPTIONS menu to conform to the system that the tape was recorded (see page 68). (Normally set the option to AUTO)

**To play an NTSC-recorded tape**

Set NTSC PB at the rear of the VCR according to the colour system of your TV.

When your TV is	Set NTSC PB to
PAL only	ON PAL TV
PAL and NTSC	NTSC 4.43

**To use the time counter**

Press CLEAR at the point on the tape that you want to find later. The counter in the display window resets to “0:00:00.” Search for the point afterwards by referring to the counter.

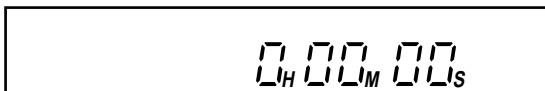

To display the counter on the TV screen, press  DISPLAY.

**Notes**

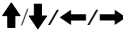
- The counter resets to “0:00:00” whenever a tape is reinserted.
- The counter stops counting when it comes to a portion with no recording.
- Depending on your TV, the following may occur while playing an NTSC-recorded tape:
  - The picture becomes black and white.
  - The picture shakes.
  - No picture appears on the TV screen.
  - Black streaks appear horizontally on the TV screen.
  - The colour density increases or decreases.
- If you playback a tape in LP or EP mode with the NTSC system, the sound is heard in monaural.
- While setting the menu on the TV screen, you cannot use  buttons for tape operation.

**Starting playback automatically with one button (One Touch Play)**

If you use the SMARTLINK connection, you can turn on the VCR and the TV, set the TV to the video channel, and start playback automatically with one button.

**1** Insert a tape.

The VCR automatically turns on.

If you insert a tape with its safety tab removed, the TV turns on and switches to the video channel. Playback starts automatically.

**2** Press  PLAY.

The TV turns on and switches to the video channel automatically. Playback starts.

**Tip**

- When there already is a tape in the VCR, the VCR and the TV turn on, the TV is set to the video channel, and playback starts automatically in one sequence when you press  PLAY.

**Note**

- When you use the One Touch Play function, leave the TV on or in the standby mode.

# Recording TV programmes

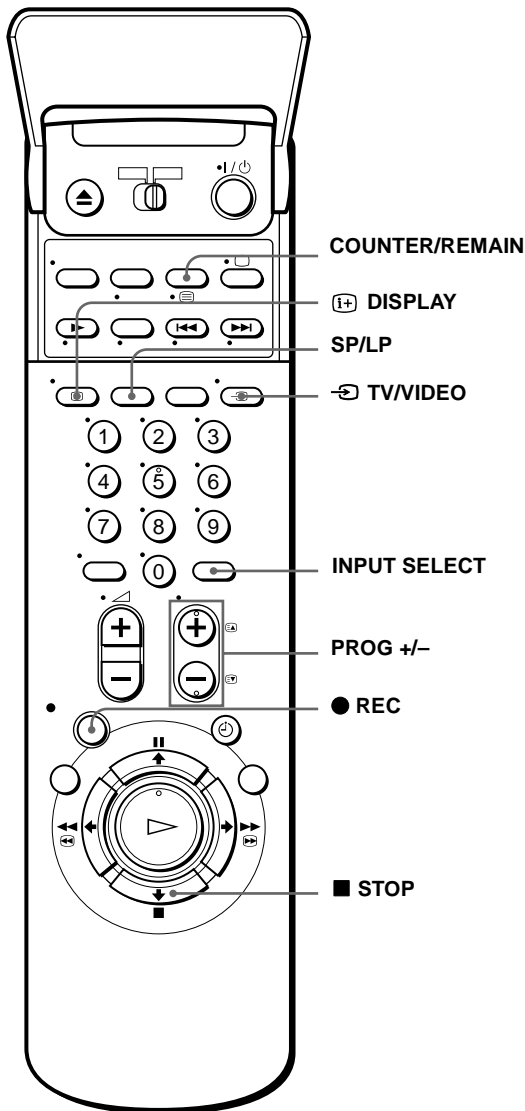

---

**1** Turn on your TV and set it to the video channel.  
To record from a decoder or other source, turn it on.

---

**2** Insert a tape with its safety tab in place.

---

3

• PROG

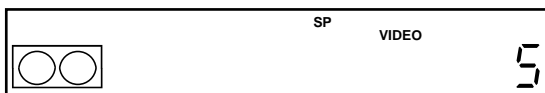

- To record a terrestrial channel.  
Press PROG +/- until the programme position number you want appears in the display window.

INPUT  
SELECT

- To record a video source from the LINE-1 (TV) or LINE-3 (Scart) connector, or the LINE-2IN jacks. Press INPUT SELECT until L1, L2 or L3 appears in the display window.

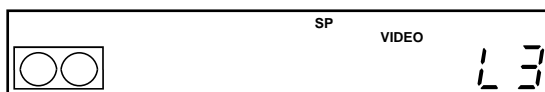

4

SP/LP



Press SP/LP to select the tape speed, SP or LP.

LP (Long Play) provides recording time twice as long as SP. However, SP (Standard Play) produces better picture and audio quality.

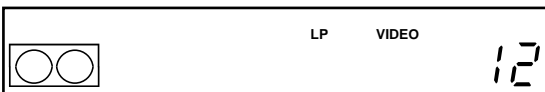

5

● REC



Press ● REC to start recording.

The recording indicator lights up red in the display window.

**Recording  
indicator**

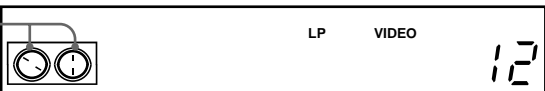

### To stop recording

Press ■ STOP.

continued

## To check the remaining time

Press **(i+)** DISPLAY. With the display on, press COUNTER/REMAIN to check the remaining time. Each time you press COUNTER/REMAIN, the time counter and the remaining time appear alternately. The **(i)** indicator indicates the remaining time.

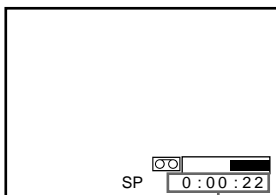

Time counter

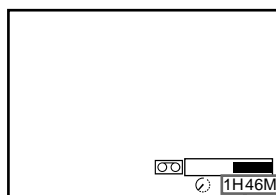

Remaining time

In order to get an accurate remaining time indication, be sure the TAPE LENGTH item in the TAPE OPTIONS menu is set according to the tape type you use (see page 68).

## To watch another TV programme while recording

- 1 Press **(TV)** TV/VIDEO on the remote commander to turn off the VIDEO indicator in the display window.
- 2 Select another programme position on the TV.

## To protect a recording

To prevent accidental erasure, break off the safety tab as illustrated. To record on a tape again, cover the tab hole with adhesive tape.

You can also protect a recording by using the SmartFile function (see page 94).

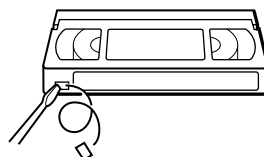

Safety tab

### Tips

- To select a programme position, you can use the programme number buttons on the remote commander. For two-digit numbers, press the **--** (ten's digit) button followed by the programme number buttons.
- The display appears on the TV screen indicating information about the tape, but the information won't be recorded on the tape.
- If you don't want to watch TV while recording, you can turn off the TV. When using a decoder or other source, make sure to leave it on.

### Notes

- If a tape has portions recorded in both PAL and NTSC systems, the time counter reading will not be correct. This discrepancy is due to the difference between the counting cycles of the two video systems.
- You cannot watch a PAY-TV/Canal Plus programme while recording another PAY-TV/Canal Plus programme.
- The remaining time is intended for rough measurement only.
- The remaining time will be displayed for only about 30 seconds after tape starts playback.

## Recording what you are watching on the TV (TV Direct Rec)

If you use the SMARTLINK connection, you can easily record what you are watching on the TV (other than tapes being played on the VCR).

- 1** Insert a tape with its safety tab in place.
- 2** Press ● REC while you are watching a TV programme or external source.  
The VCR automatically turns on, then the TV indicator lights up and the VCR starts recording what you are watching on the TV.

### Tips

- The TV indicator appears in the display window after you press ● REC in some situations such as:
  - when you are watching a source connected to the TV's line input, or
  - when the TV tuner preset data for the programme position is different from the data preset in the VCR tuner.
- If there already is a tape with its safety tab in place in the VCR, the VCR automatically turns on and starts recording what you are watching on the TV when you press ● REC.
- You can turn the TV Direct Rec function ON and OFF in the OTHER OPTIONS menu (see page 68).

### Notes

- You cannot record what you are watching using this method when the VCR is in the following modes : pause, timer standby, tuner preset, Auto Set Up, and recording.
- When the TV indicator is lit in the display window, do not turn off the TV nor change the TV programme position. When the TV indicator is not lit, the VCR continues recording the programme even if you change the TV programme position on the TV.

# Recording TV programmes using the ShowView system

The ShowView system is a feature that simplifies programming the VCR to make timer recordings. Just enter the ShowView number listed in the TV programme guide. The date, times, and programme position of that programme are set automatically. You can preset up to eight programmes at a time.

## Before you start . . .

- Check that the VCR clock is set to the correct time and date.
- Insert a tape with its safety tab in place. Make sure the tape is longer than the total recording time.
- Turn on your TV and set it to the video channel.
- If you insert a tape with the SmartFile function, make sure the total recording time doesn't overlap the protected programme. For details about the SmartFile function, see page 74.
- Set **TIMER OPTIONS** to **SHOWVIEW** or **VARIABLE** in the **OTHER OPTIONS** menu (see page 70).

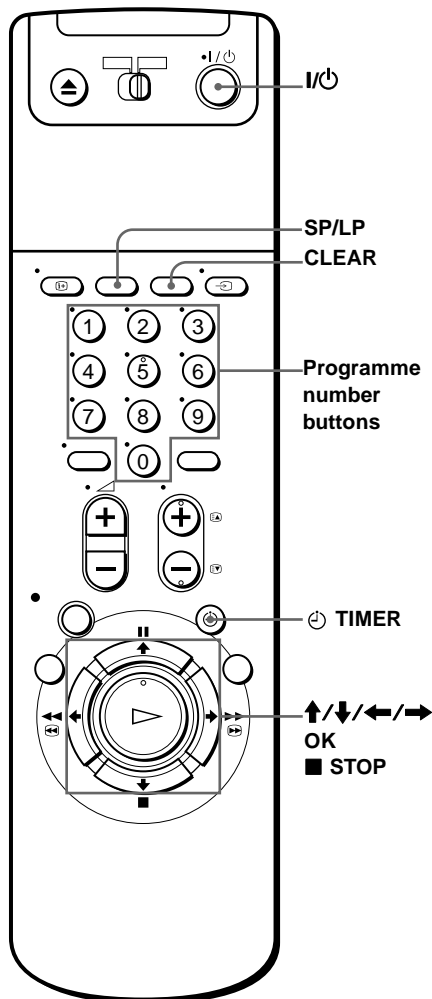



# 1

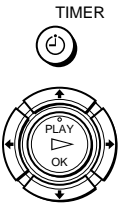

Press TIMER.

- When you set TIMER OPTIONS to VARIABLE:  
The **TIMER METHOD** menu appears on the TV screen. Press / to select **SHOWVIEW**, then press **OK**.
- When you set TIMER OPTIONS to **SHOWVIEW**:  
The **SHOWVIEW** menu appears on the TV screen.

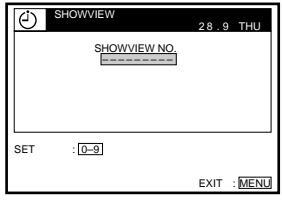
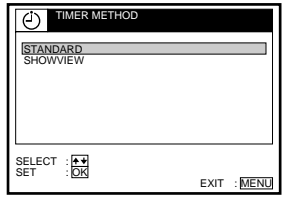

# 2

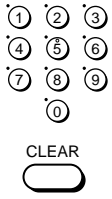

Press the programme number buttons to enter the ShowView number.  
If you make a mistake, press **CLEAR** and re-enter the correct number.

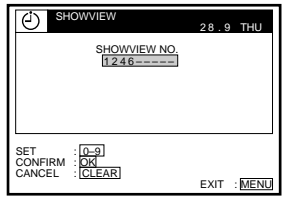

**continued**

3



Press OK.

The date, start and stop times, programme position, tape speed, and VPS/PDC setting appear on the TV screen.

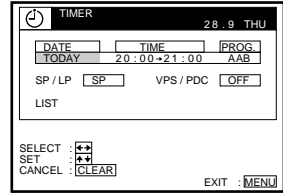

If “-” appears in the “PROG.” (programme) column (this may happen for local broadcasts), you have to set the appropriate programme position manually.

- To select a terrestrial channel.  
Press **↑/↓** to select the desired programme position.
- To select a video source from the LINE-1 (TV) or LINE-3 IN connector, or the LINE-2 IN jacks.  
Press INPUT SELECT to select the desired video source.

You will only have to do this operation once for the referred channel. The VCR will then store your setting.

For details about the VPS/PDC function, see “Timer recording with VPS/PDC signals” on page 51.



If the information is incorrect, press CLEAR to cancel the setting.

4



If you want to change the date, tape speed, and the VPS/PDC function setting:

- 1 Press **←/→** to highlight the item you want to change.
- 2 Press **↑/↓** to reset it.

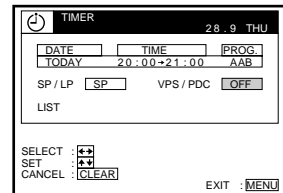

- To record the same programme every day or the same day every week, see “Daily/weekly recording” on page 51.
- To use the VPS/PDC function, set VPS/PDC to ON. For details about the VPS/PDC function, see “Timer recording with VPS/PDC signals” on page 51.
- To change the setting, press MENU, and highlight LIST, then select TIMER LIST and press OK. Then enter the new timer setting and press OK.



If the informations are not correct, press CLEAR to cancel the settings.

5



Press OK to confirm the setting.

6



Press I/⏻ to turn off the VCR.

The ⏻ indicator appears in the display window and the VCR stands by for recording.

### To stop recording

To stop the VCR while recording, press ■ STOP.

### Daily/weekly recording

In step 4 above, press ↓ to select the recording pattern. Each time you press ↓, the indication changes as shown below. Press ↑ to change the indication in reverse order.

**TODAY → SUN-SAT (Sunday to Saturday) → MON-SAT (Monday to Saturday) → MON-FRI (Monday to Friday) → SAT (every Saturday) ..... → MON (every Monday) → SUN (every Sunday) → 1 month later → (dates count down) → TOMORROW → TODAY**

### Timer recording with VPS/PDC signals

Some broadcast systems transmit VPS (Video Programme System) or PDC (Programme Delivery Control) signals with their TV programmes. These signals ensure that your timer recordings are made regardless of broadcast delays, early starts, or broadcast interruptions (when the VPS or PDC indicator in the display window is lit).

In step 4 above, press ↑/↓ to turn on/off the VPS/PDC indication after you set the recording date. If you do not want to set the VPS/PDC function, turn off the VPS/PDC indication.

You can also use the VPS/PDC function for a source connected to the LINE-1 (TV) and LINE-3 IN (Scart) connectors, or the LINE-2 IN jacks.

**continued**

## To use the VCR after setting the timer

To use the VCR before a timer recording begins, just press I/⏻. The ⏻ indicator turns off and the VCR switches on. Remember to press I/⏻ to reset the VCR after using the VCR.

You can also do the following tasks while the VCR is recording:

- Reset the counter.
- Display tape information on the TV screen.
- Check the timer settings (see “Setting the timer manually” on page 53).
- Watch another TV programme.

### Tips

- To set the programme position with a two digit number, press -- (ten's digit) button followed by the programme number button.
- To set the programme position, you can also use the PROG +/- or programme number buttons.
- To set the tape speed, you can also use the SP/LP button.
- When you are recording a programme in the SP mode and the remaining tape becomes shorter than the recording time, the tape speed is automatically changed to the LP mode. Note that some interference will appear on the picture at the point the tape speed is changed. If you want to keep the same tape speed, set AUTO LONG PLAY to OFF in the TAPE OPTIONS menu (see page 68).
- To check, change, or cancel the programme setting, press ◀/▶ to choose LIST, then press OK after step 4. For details, see step 3 in “Checking/changing/cancelling timer settings on page 61.

### Notes

- When setting the timer with VPS/PDC signals, enter the start and stop times exactly as indicated in the TV programme guide, otherwise the VPS/PDC function won't work and the recording won't start.
- If the VPS/PDC signal is too weak or the broadcasting station failed to transmit VPS/PDC signals, the VCR will start recording at the set time without using the VPS/PDC function.
- The ⏻ indicator flashes in the display window when you press I/⏻ with no tape inserted.
- The VPS/PDC function is automatically set to OFF for the timer recording of a satellite programme.
- When you set TIMER OPTIONS to STANDARD in the OTHER OPTIONS menu, the SHOWVIEW menu does not appear on the TV screen. Select SHOWVIEW or VARIABLE.



1



Press TIMER.

- When you set TIMER OPTIONS to VARIABLE:  
The TIMER METHOD menu appears on the TV screen. Press / to select STANDARD, then press OK.

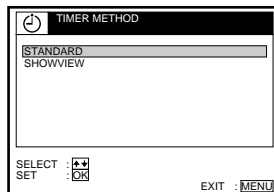

- When you set TIMER OPTIONS to STANDARD:  
The TIMER menu appears on the TV screen.

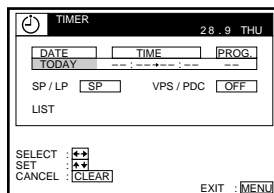

2



Set the date, start and stop times, programme position, tape speed, and VPS/PDC function:

- 1 Press to highlight each item in turn.
- 2 Press / to set each item.

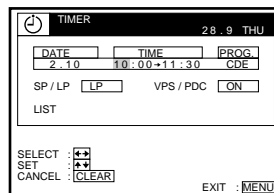

To correct a setting, press to return to that setting and reset it.

- To record the same programme every day or the same day every week, see “Daily/weekly recording” on page 55.
- To use the VPS/PDC function, set VPS/PDC to ON. For details about the VPS/PDC function, see “Timer recording with VPS/PDC signals” on page 51.
- To record from a decoder or other source connected to the LINE-1 (TV) or LINE-3 IN connectors, the LINE-2 IN jacks, press INPUT SELECT to display “L1,” “L2,” “L3” in the “PROG.” position.



3



Press OK to confirm the setting.



Press **I/⏻** to turn off the VCR.

The **⏻** indicator appears in the display window and the VCR stands by for recording.

To record from a decoder or other sources, leave the connected equipment switched on.

### To stop recording

To stop the VCR while recording, press **■ STOP**.

### Daily/weekly recording

In step 2 above, press **↓** to select the recording pattern. Each time you press **↓**, the indication changes as shown below. Press **↑** to change the indication in reverse order.

**TODAY → SUN-SAT (Sunday to Saturday) → MON-SAT (Monday to Saturday) → MON-FRI (Monday to Friday) → SAT (every Saturday) ..... → MON (every Monday) → SUN (every Sunday) → 1 month later → (dates count down) → TOMORROW → TODAY**

### Tips

- To set the programme position, you can also use the PROG +/- or programme number buttons.
- To set the tape speed, you can also use the SP/LP button.
- When you are recording a programme in the SP mode and the remaining tape becomes shorter than the recording time, the tape speed is automatically changed to the LP mode. Note that some interference will appear on the picture at the point the tape speed is changed. If you want to keep the same tape speed, set AUTO LONG PLAY to OFF in the TAPE OPTIONS menu (see page 68).
- Even if you set TIMER OPTIONS to SHOWVIEW in the OTHER OPTIONS menu, you can set the timer manually. Press MENU to select TIMER, then go to step 2.

### Notes

- When setting the timer with VPS/PDC signals, enter the start and stop times exactly as indicated in the TV programme guide, otherwise the VPS/PDC function won't work and the recording won't start.
- If the VPS/PDC signal is too weak or the broadcasting station failed to transmit VPS/PDC signals, the VCR will start recording at the set time without using the VPS/PDC function.
- The **⏻** indicator flashes in the display window when you press **I/⏻** with no tape inserted.

# Playing/searching at various speeds

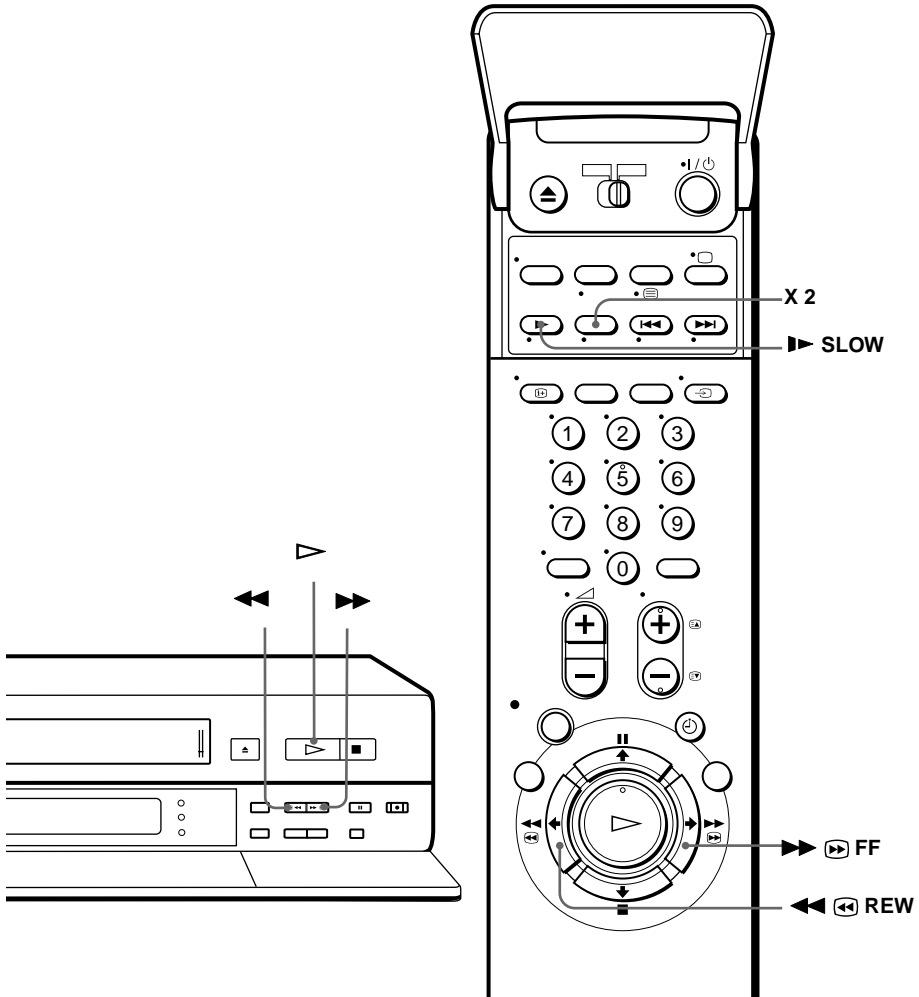

Playback options	Operation
Fast-forward /rewind	During stop, press ►► (fast-forward) or ◀◀ (rewind) and release.
View the picture during fast-forward or rewind	During fast-forward, hold ►► ◻ FF down. During rewind, hold ◀◀ ◻ REW down.
Play at high speed	<ul style="list-style-type: none"> <li>• During playback, press ►► ◻ FF down or ◀◀ ◻ REW <u>on the remote commander.</u></li> <li>• During playback, hold down ►► ◻ FF or ◀◀ ◻ REW. When you release the button, normal playback resumes.</li> </ul>
Play at twice the normal speed	During playback, press X2.



Playback options	Operation
Play in slow motion	During playback, press <b>▶▶ SLOW</b> .
Play frame by frame	<ul style="list-style-type: none"> <li>• During pause, press <b>▶▶</b> <b>⏮</b> FF down or <b>◀◀</b> <b>⏪</b> REW <u>on the remote commander</u>. Hold down <b>▶▶</b> <b>⏮</b> FF or <b>◀◀</b> <b>⏪</b> REW to play one frame each second.</li> </ul>
Rewind and start play	During stop, hold <b>◀◀</b> (rewind) down <u>on the VCR</u> and press <b>▷</b> (playback) <u>on the VCR</u> then release both.

### To resume normal playback

Press **▷** (playback).

### Tip

- Adjust the picture using the TRACKING +/- buttons if:
    - Streaks appear while playing in slow motion.
    - Bands appear at the top or bottom while pausing.
    - The picture shakes while pausing.
- To set tracking to the centre position, press both TRACKING +/- buttons at the same time.

### Notes

- The playback sound is muted during the operations in the above table.
- In the LP mode, noise may appear or there may be no colour.
- If the playback mode mark doesn't appear on the TV screen, press **Ⓡ** DISPLAY.

# Setting the recording duration time

After you start recording in the normal way, you can have the VCR stop recording automatically after a specified duration.

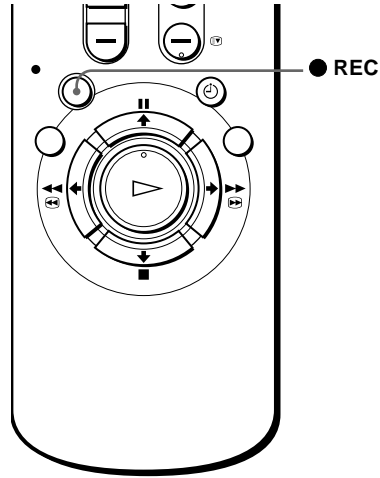

- 1 While recording, press ● REC.  
The ⏻ indicator appears in the display window.

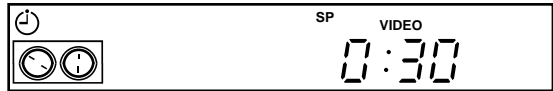

- 2 Press ● REC repeatedly to set the duration.  
Each press advances the time in increments of 30 minutes.

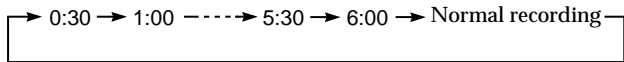

The tape counter decreases minute by minute to 0:00, then the VCR stops recording and turns off automatically.

## To extend the duration

Press ● REC repeatedly to set a new duration.

## To cancel the duration

Press ● REC repeatedly until the ⏻ indicator disappears and the VCR returns to normal recording mode.

## To stop recording

To stop the VCR while recording, press ■ STOP.

## Note

- You cannot display the current tape time in the display window when setting the recording duration.

# Synchronized Recording

You can set the VCR to automatically record programmes from equipment such as a programmable set top box by connecting the equipment to the LINE-3 IN connector. The connected equipment must have a timer function for this feature to work.

When the connected equipment turns on, the VCR also automatically turns on and starts recording a programme from LINE-3 IN.

## How to connect for Synchronized Recording.

Connect the LINE-3 IN of the VCR to the TV Scart connector of the Set-Top Box. Then connect the LINE-1 (TV) connector to the TV.

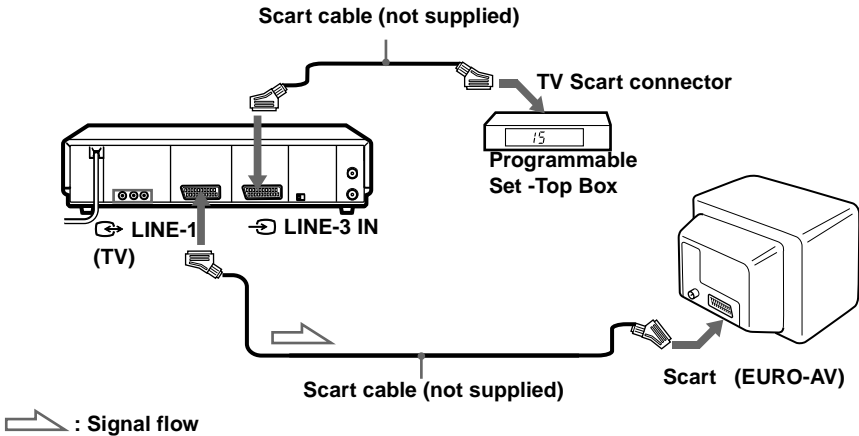

## Recording programmes using the Synchronized Recording function

### Before you start...

- Insert a tape with its safety tab in place.  
Make sure the tape is longer than the total recording time.

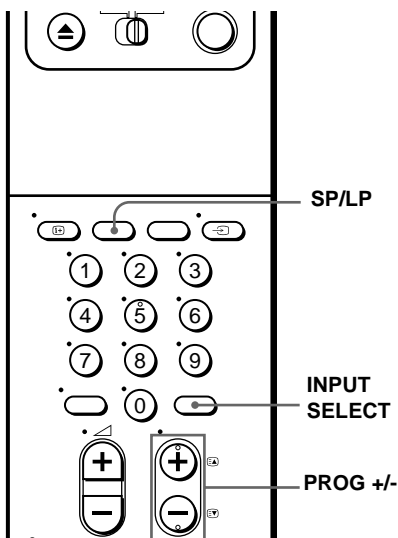
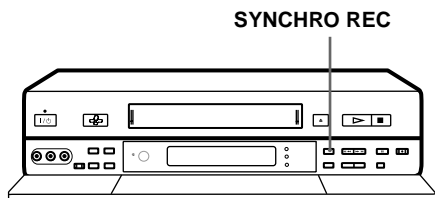

- 1** Set the timer on the STB to the time of the programme you want to record, then turn it off.
- 2** Press SP/LP to select the tape speed on the VCR.
- 3** Hold down SYNCHRO REC for more than two seconds.  
The SYNCHRO REC indicator lights up on the front panel and the VCR stands by for recording.  
The VCR automatically turns on and starts recording when it receives an input signal from the STB.  
The VCR automatically stops recording when the tape reaches the end or when the STB stops transmitting an input signal.

### To cancel the Synchronized Recording function

Press SYNCHRO REC. The SYNCHRO REC indicator turns off.

### To stop recording

Press ■ STOP while recording.

### Notes

- This function may not work with some types of satellite tuners.
- If the settings for timer recording and Synchronized Recording overlap, the programme that starts first has priority and the second programme starts recording only after the first programme has finished.
- The Auto Clock Set function does not work while the VCR stands by for Synchronized Recording.

# Checking/changing/cancelling timer settings

## Before you start...

- Turn on your TV and set it to the video channel.

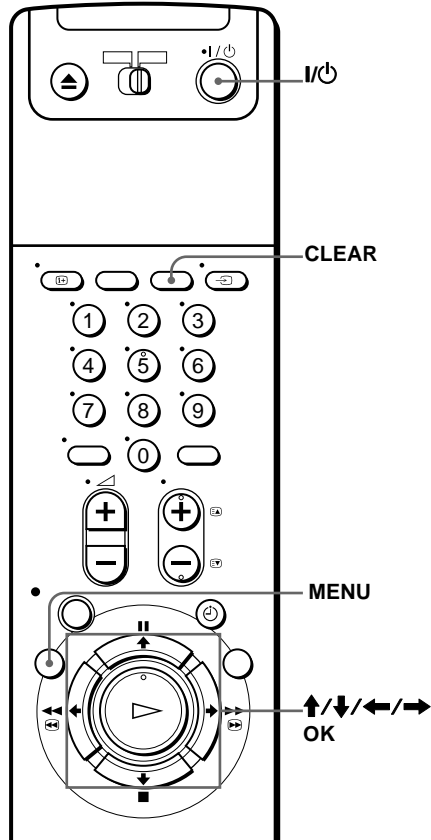

- 1 Press I/⏻ to turn on the VCR.
- 2 Press MENU, then press ↑/↓ to highlight LISTS and press OK.
- 3 Press ↑/↓ to highlight TIMER LIST, then press OK:

- If you want to change or cancel a setting, go on to the next step.
- If you do not need to change or cancel the settings, press MENU, then turn off the VCR to return to recording standby.

DATE	TIME	PROG.	20.9 THU
TODAY	20:00-21:00	AAB	SP
MON-FRI	14:00-15:00	FGH	LP
30.9	20:00-21:00	AAB	SP
SUN	6:30-7:00	IJK	LP
2.10	10:00-11:30	CDE	LP
---	---	---	---
---	---	---	---
---	---	---	---
---	---	---	---

[RETURN]    [OK]  
 [SET]        [OK]  
 [CANCEL]    [CLEAR]                      [EXIT]    [MENU]

**continued**

- 4 Press **↑/↓** to select the setting you want to change or cancel, then press **OK**.

The selected setting appears in the **TIMER** menu.

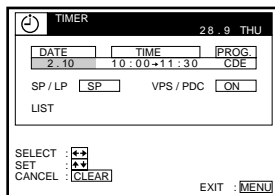

- 5 • To change the setting, press **←/→** to highlight the item you want to change, and press **↑/↓** to change it.
- To cancel the setting, press **CLEAR**.

- 6 Press **MENU**.

If any settings remain, turn off the **VCR** to return to recording standby.

### When the timer settings overlap

The programme that starts first has priority and the second programme starts recording only after the first programme has finished. If the programmes start at the same time, the programme listed first in the menu has priority.

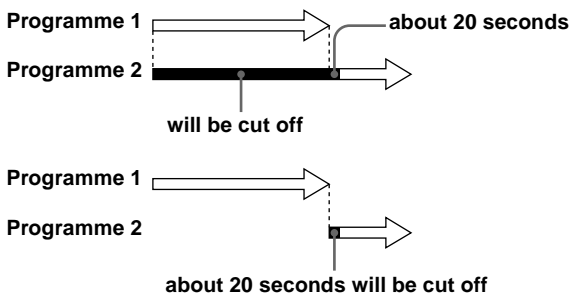

### Tip

- In step 5 above, you can check the **TIMER LIST** by selecting **LIST** and pressing **OK**. Press **MENU** to exit the **TIMER LIST**.

# Recording stereo and bilingual programmes

## In ZWEITON (German stereo) system

This VCR automatically receives and records stereo and bilingual programmes based on the ZWEITON system. When a stereo or bilingual programme is received, the STEREO indicator appears in the display window.

### To select bilingual sound while recording

Press AUDIO MONITOR to select the sound you want.

To listen to	On-screen display	Display window
Main	MAIN	STEREO
Sub	SUB	STEREO
Main and sub	MAIN/SUB	STEREO

## In NICAM system

This VCR receives and records stereo and bilingual programmes based on the NICAM system (the NICAM indicator appears). When a stereo or bilingual programme is received, the STEREO indicator appears in the display window.

To record a NICAM programme, HIFI AUDIO in the AUDIO OPTIONS menu should be set to NICAM (initial setting). To check the menu setting, see page 69 for details.

### To select the sound while recording

Press AUDIO MONITOR to select the sound you want.

#### Stereo programme

To listen to	On-screen display	Display window
Stereo	STEREO	STEREO
Standard sound*	No indicator	No indicator

\* Usually the mixed sound of left and right channels (monaural)

#### Bilingual programme

To listen to	On-screen display	Display window
Main	MAIN	STEREO
Sub	SUB	STEREO
Main and sub	MAIN/SUB	STEREO
Standard sound*	No indicator	No indicator

\* Usually the main sound (monaural)

**continued**

## Selecting the sound during playback

Press AUDIO MONITOR to select the sound you want.

To listen to	On-screen display	Display window
Stereo/main and sub (left and right channels)	STEREO	STEREO
Left channel/main	LCH	STEREO
Right channel/sub	RCH	STEREO
Standard sound	No indicator	No indicator

## How sound is recorded on a video tape

The VCR records sound onto two separate tracks. Hi-fi audio is recorded onto the main track along with the picture. Monaural sound is recorded onto the normal audio track along the edge of the tape.

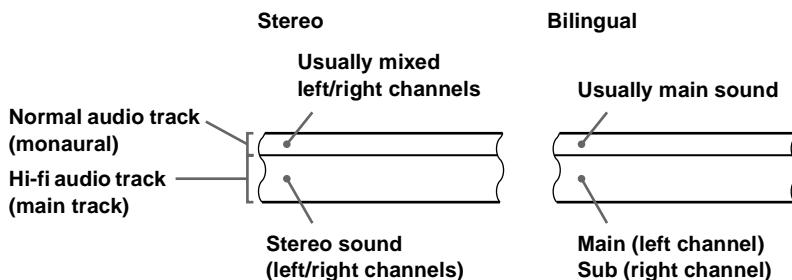

### Notes

- To listen to playback sounds in stereo, you must use the EURO-AV or AUDIO OUT connections.
- When you play a tape recorded in monaural, the sound is heard in monaural regardless of the AUDIO MONITOR setting.
- If the AUDIO MONITOR button does not function, check that AUDIO MIX in the AUDIO OPTIONS menu is set to OFF (see page 69).
- If HIFI AUDIO is set to STANDARD, the standard sound will be recorded on both the hi-fi and normal audio tracks. Pressing AUDIO MONITOR will not change the sound.



# Searching using the index function

The VCR marks the tape with an index signal at the point where each recording begins. Use these signals as references to find a specific recording. The VCR can search up to 99 index signals ahead or behind the current position.

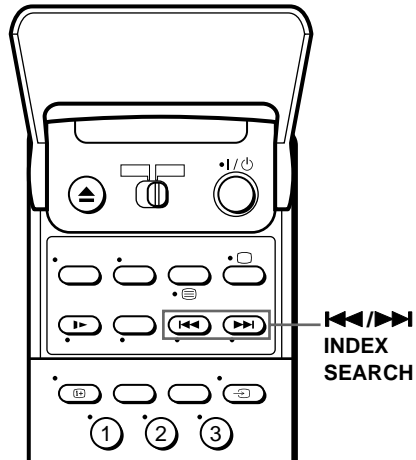

- 1 Insert an indexed tape into the VCR.
- 2 Press **◀◀/▶▶** INDEX SEARCH repeatedly to specify how many index signals ahead or behind you want to search :
  - To search ahead, press **▶▶** INDEX SEARCH.
  - To search backwards, press **◀◀** INDEX SEARCH.

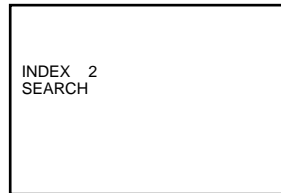

The VCR starts searching and the index number on the TV screen counts down to zero. Playback starts automatically from that point.

## To stop searching

Press **■** STOP.

## Note

- No index signal will be added when recording starts from recording pause. However, an index signal will be marked if you change the programme position during recording pause.

# Adjusting the picture

## Adjusting the tracking

Although the VCR automatically adjusts the tracking when playing a tape (the  indicator flashes in the display window, then goes off), distortion may occur if the tape was recorded in poor condition. In this case, manually adjust the tracking.

During playback, press TRACKING +/- to display the tracking meter. The distortion should disappear as you press one of the two buttons (the  indicator lights up). To resume automatic tracking adjustments, eject the tape and re-insert it. To set the tracking to the centre position, press TRACKING + and - buttons at the same time.

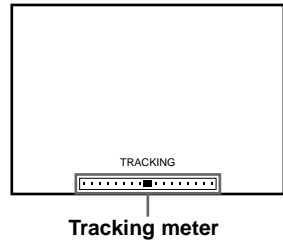

## About the Reality Regenerator (RR) function

The Reality Regenerator (RR) function automatically restores the picture to its original quality during playback.

To use the RR function, press REALITY REGENERATOR button. The REALITY REGENERATOR indicator lights up. You can set RR to HIGH or NORMAL in the VIDEO OPTIONS menu (see page 68).

To turn it off, press REALITY REGENERATOR. The REALITY REGENERATOR indicator lights off.

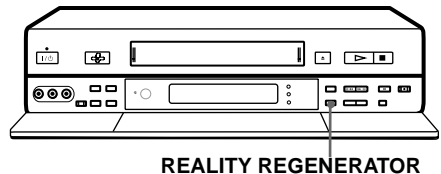

## About the Optimum Picture Control (OPC) function

The Optimum Picture Control (OPC) function automatically improves recording and playback quality by adjusting the VCR to the condition of the video heads and tape. To maintain better picture quality, we recommend that you set OPC to ON in the VIDEO OPTIONS menu (with the OPC indicator in the display window lit). For details, see page 68.

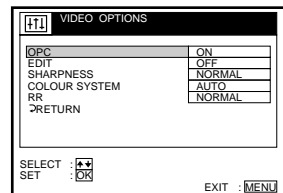

## OPC playback

The OPC function automatically works on all types of tapes, including rental tapes and tapes that were not recorded with OPC.

## OPC recording

Whenever you insert a tape and start recording for the first time, the VCR adjusts to the tape using the OPC function (the OPC indicator flashes rapidly). This adjustment is retained until the tape is ejected.

### To deactivate the OPC function

Set OPC to OFF in the VIDEO OPTIONS menu. The OPC indicator in the display window turns off.

### Notes

- With the Auto Long Play function ON, the OPC function will work only in SP mode. If the tape speed automatically switches from SP to LP, the OPC function turns off. However, if the entire programme is recorded in LP mode, the OPC function will work.
- There is a delay of about ten seconds before the VCR actually starts recording while the VCR analyses the tape. To avoid the delay, first set the VCR to recording pause (the OPC indicator flashes slowly) and press ● REC to have the VCR analyse the tape (the OPC indicator flashes rapidly) and returns to recording pause. After the OPC indicator stops flashing, press ■■ PAUSE to start recording immediately. If you want to start recording quickly without using the OPC function, first set the VCR to recording pause (the OPC indicator flashes slowly) and press ■■ PAUSE to start recording.

# Changing menu options

- 1 Press MENU, then select OPTIONS and press OK.

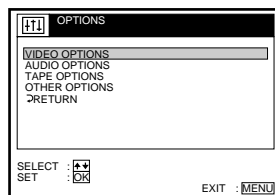

- 2 Press ↑/↓ to highlight the kind of option to change, VIDEO OPTIONS, AUDIO OPTIONS, TAPE OPTIONS or OTHER OPTIONS, then press OK
- 3 Press ↑/↓ to select the option, then press OK to enter the pop up menu.
- 4 Press ↑/↓ to select the desired setting, then press OK.
- 5 Press MENU to exit the menu.

## VIDEO OPTIONS menu

Initial settings are indicated in bold print.

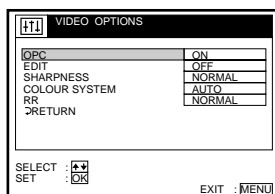

Menu option	Set this option to
OPC	<ul style="list-style-type: none"> <li>• <b>ON</b> to switch on the OPC (Optimum Picture Control) function and improve picture quality.</li> <li>• OFF to switch off OPC.</li> </ul>
EDIT	<ul style="list-style-type: none"> <li>• ON to minimize picture deterioration when editing.</li> <li>• <b>OFF</b> to turn off EDIT.</li> </ul>
SHARPNESS	<ul style="list-style-type: none"> <li>• LOW to playback a poor quality tape.</li> <li>• <b>NORMAL</b> to playback an average quality tape.</li> <li>• HIGH to playback a good quality tape.</li> </ul>
COLOUR SYSTEM	<ul style="list-style-type: none"> <li>• <b>AUTO</b> to detect automatically the colour system of a tape.</li> <li>• PAL to playback a tape recorded in the PAL system.</li> <li>• MESECAM to playback a tape recorded in the MESECAM system.</li> </ul>
RR	<ul style="list-style-type: none"> <li>• <b>NORMAL</b> for normal everyday use.</li> <li>• HIGH for well-used video tapes such as rented tapes. Select this option when NORMAL does not improve the picture quality.</li> </ul> <p>For details, see page 66.</p>

### Note

- When you playback with the EDIT function ON, the OPC and the SHARPNESS functions don't work.

- When you turn off your VCR or eject the tape, the colour system is set automatically to AUTO.

## AUDIO OPTIONS menu

Initial settings are indicated in bold print.

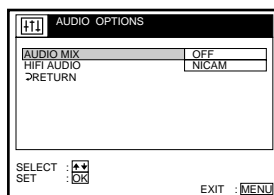

Menu option	Set this option to
AUDIO MIX	<ul style="list-style-type: none"> <li>• ON to listen to the hi-fi and normal audio tracks at the same time. The AUDIO MONITOR button will not function.</li> <li>• <b>OFF</b> to listen to the hi-fi and normal audio tracks separately. Select the sound using the AUDIO MONITOR button. For details, see page 63.</li> </ul>
HIFI AUDIO	<ul style="list-style-type: none"> <li>• STANDARD to record standard sound on the hi-fi audio track.</li> <li>• <b>NICAM</b> to record NICAM broadcasts on the hi-fi audio track. For details, see page 63.</li> </ul>

### Note

- If you eject the tape, AUDIO MIX is automatically set to OFF.

## TAPE OPTIONS menu

Initial settings are indicated in bold print.

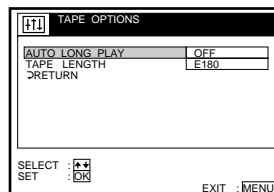





Menu option	Set this option to
AUTO LONG PLAY	<ul style="list-style-type: none"> <li>• ON to automatically record from SP (Standard Play) to LP (Long Play) when the tape length is not long enough.</li> <li>• <b>OFF</b> to normally record in SP (Standard Play).</li> </ul>
TAPE LENGTH	<ul style="list-style-type: none"> <li>• <b>E180</b> to use an E-180 or shorter tape type.</li> <li>• E195 to use an E-195.</li> <li>• E240 to use an E-240.</li> <li>• E300 to use an E-300.</li> </ul>

continued

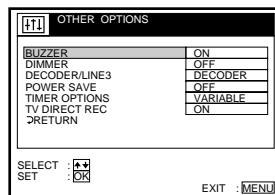
## OTHER OPTIONS menu

Initial settings are indicated in bold print.



Menu option	Set this option to
BUZZER	<ul style="list-style-type: none"> <li>• <b>ON</b> to output a beep sound.</li> <li>• <b>OFF</b> to deactivate it.</li> </ul>
DIMMER	<ul style="list-style-type: none"> <li>• <b>ON</b> to make the display window dim.</li> <li>• <b>OFF</b> to make it brighter.</li> </ul>
DECODER/LINE3	<ul style="list-style-type: none"> <li>• <b>DECODER</b> to use the DECODER/LINE-3 IN connector as the PAY-TV/Canal Plus decoder connector.</li> <li>• <b>LINE3</b> to use the DECODER/LINE-3 IN connector as a line input connector.</li> </ul>
POWER SAVE	<ul style="list-style-type: none"> <li>• <b>ON</b> to turn off the indicators in the display window to save the VCR power.</li> <li>• <b>OFF</b> to turn on the indicators in the display window while the VCR is standing by.</li> </ul>
TIMER OPTIONS	<ul style="list-style-type: none"> <li>• <b>VARIABLE</b> to display the TIMER METHOD menu for selecting STANDARD or SHOWVIEW when pressing the  TIMER button.</li> <li>• <b>STANDARD</b> to display only the TIMER menu when pressing the  TIMER button.</li> <li>• <b>SHOWVIEW</b> to display only the SHOWVIEW menu when pressing the  TIMER button.</li> </ul> <p>For details, see page 48 and 53.</p>
TV DIRECT REC	<ul style="list-style-type: none"> <li>• <b>ON</b> to activate the TV Direct Rec function.</li> <li>• <b>OFF</b> to deactivate it.</li> </ul>

### Note

- When you set a timer recording or a synchronized recording, the indicators in the display window remain on, even though POWER SAVE is set to ON.

# Connecting to a VCR or stereo system

## How to connect to record on your VCR

Connect the line outputs of the other VCR to the LINE IN connector or jacks of your VCR. Refer to the examples A or B and choose the connection that best suits your VCR.

### Example A

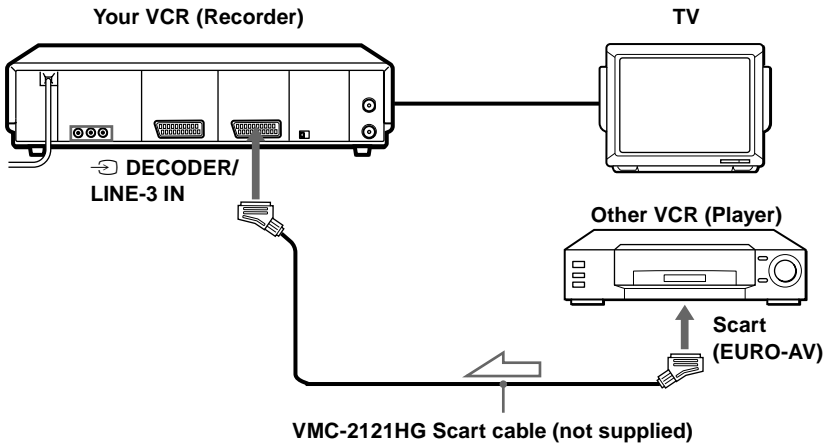

 : Signal flow

### Example B

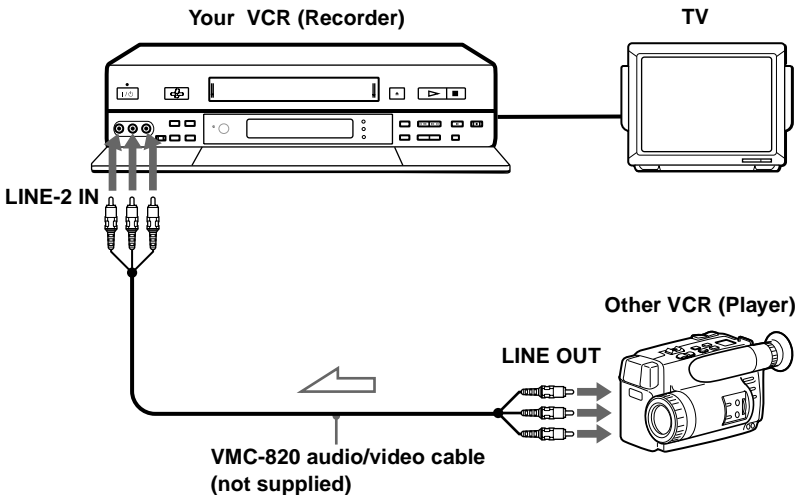

 : Signal flow

continued

**Tip**

You can also use the LINE-3 IN connector instead.

**Notes**

- Make sure you connect the plugs to jacks of the same colour.
- If the other VCR is a monaural type, leave the red plugs unconnected.
- If you connect your VCR to both the LINE IN and LINE OUT jacks of the other VCR, select the input correctly to prevent a humming noise.
- If the other VCR does not have a Scart (EURO-AV) connector, use the VMC-2106HG cable instead and connect the cable to the line out jacks of the other VCR.
- When you connect another VCR to the DECODER/LINE3 IN connector, set DECODER/LINE3 to LINE3 in the OTHER OPTIONS menu.

**How to connect to a stereo system**

Connect the LINE-2 IN AUDIO L/R jacks of your VCR to the audio output jacks on the stereo system, using the RK-C510HG audio cable (not supplied).



# Basic Editing

(when recording on your VCR)

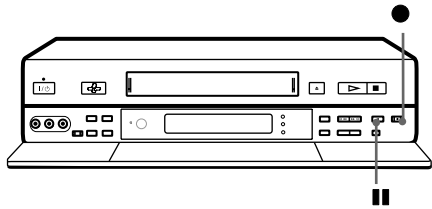

Before you start editing...

- Turn on your TV and set it to the video channel. Press INPUT SELECT to display “L2” (or “L1” or “L3”) in the display window.
- Press SP/LP to select the tape speed, SP or LP.
- On your VCR, set EDIT to ON in the VIDEO OPTIONS menu to display “EDIT” in the display window. If the other VCR has a similar feature, activate this one as well.

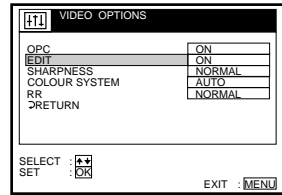

- 1** Insert a source tape with its safety tab removed into the other (playback) VCR. Search for the point to start playback and set it to playback pause.
- 2** Insert a tape with its safety tab in place into your (recording) VCR. Search for the point to start recording and press **||** (pause).
- 3** Press **●** (record) on your VCR to set it to recording pause.
- 4** To start editing, press the **||** (pause) buttons on both VCRs at the same time.

## To stop editing

Press the **■** (stop) buttons on both VCRs.

### Tip

- To cut out unwanted scenes while editing, press **||** (pause) on your VCR when an unwanted scene begins. When it ends, press **||** (pause) again to resume recording.

### Note

- If you start editing following the procedure above, the VCR won't start recording with the OPC function. To record a tape with the OPC function, press **●** (record) again during recording pause in step 3 so the VCR analyses the tape. Then press **||** (pause) after the OPC indicator stops flashing to start recording. If you press **||** (pause) before the OPC indicator stops flashing, the OPC function is cancelled.

# About the SmartFile function

SmartFile allows you to view the contents of your video tape (recording date, channel, name etc.) on the TV screen. It is no longer necessary to rewind, fast-forward, or playback a tape to find out what is recorded on it. You can also locate and start playback of a specific programme or find the place from which you want to start recording by using this list. Programme data is stored in the memory of the SmartFile label attached to the tape.

The following functions are possible using SmartFile :

## Recording using the SmartFile function (page 76)

To use the SmartFile function, attach the SmartFile label to the tape. If you record a programme on a tape with a SmartFile label, the contents will appear on the SmartFile search list. With the SmartFile list, you can also easily find the beginning of the available recording space.

### SmartFile search list

2 . 8 . 00 - 10 . 10 . 00		PAGE 1
BLANK TIME	SP 1H 55M	
10 . 10	SPORTS FESTIVAL	
SPORTS	CCB	SP 1H 30M
1 . 10	NEWS SEVEN	
		SP 0H 30M
30 . 9	SAT 7 : 00	PROG . 32
FILMS		SP 1H 30M
START		END
SELECT :	▲▼	
SEARCH :	OK	
		EXIT : MENU

## Selecting and playing a programme (page 81)

To playback a recorded programme, select the programme you want to watch using the SmartFile search list. The VCR locates the programme and playback starts automatically.

## Checking the contents of a tape (page 82)

When you bring the SmartFile label close to the SMARTFILE sensor on the VCR, a summary of the recorded programmes appears in the SmartFile check list. It is not necessary to insert the tape into the VCR and press ▷ PLAY to find out what is recorded on it. This feature allows you to easily find the programme you want to watch, or to quickly find a tape with enough recording space.

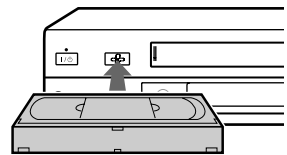

### SmartFile check list

2 . 8 . 00 - 10 . 10 . 00		PAGE 1
BLANK TIME	SP 1H 55M	
10 . 10	SPORTS FESTIVAL	
1 . 10	NEWS SEVEN	
30 . 9	SAT 7 : 00	PROG . 32
22 . 9	FRI 12 : 00	SARU
10 . 9	SUN 9 : 00	STB088
2 . 9	SAT 23 : 00	STB
NEXT :		□
		EXIT : MENU

## Labelling a recorded programme and tape (page 84)

You can attach an electronic "label" to the video tape and its programmes on the SmartFile list. Labelling the recorded programmes enables you to find a programme easily when you want to play it back. If TV guide pages are available in the Teletext, recorded programmes are labelled automatically. Also, once you label a programme which you set to record regularly (i.e everyday, same day of the week), the VCR recognizes the label and will automatically label all future recordings of the same programme.

## Registering the contents of a recorded tape in the SmartFile label (page 92)

You can register programmes recorded on a tape in the memory of a new SmartFile label.

## Protecting a recorded programme (page 94)

You can protect a recorded programme from accidental over-recording or erasure.

## Erasing the data of an unwanted programme (page 96)

By erasing a programme from the SmartFile list, the VCR will record over the unwanted programme.

## Running a demonstration

This VCR can give a demonstration of the various SmartFile functions. To run a demonstration, turn on the VCR and hold the SMARTFILE button for 3 seconds while no tape is inserted. To stop the demonstration, press any key.

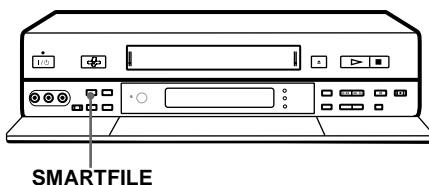

# Recording using the SmartFile function

To use the SmartFile function, attach the SmartFile label to the spine of the cassette. If you record a programme for more than 20 minutes in LP mode and 11 minutes in SP mode on a tape with a SmartFile label, programme data, such as the name, date and channel, is automatically stored in the memory of the SmartFile label. Some stations may not offer this service.

## Attaching the SmartFile label to the cassette

To use the SmartFile function, attach the supplied SmartFile label to the cassette. Remove any stains or dirt from the surface of the spine of the tape. Then, holding both edges of the SmartFile label so that it doesn't bend, attach it along the guide line to the spine of the cassette. This tape is henceforth referred to as a SmartFile tape.

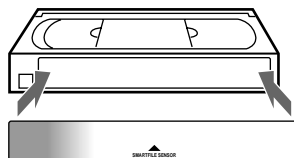

## Note on the purchase of SmartFile labels

- If you want to order additional SmartFile labels, contact your nearest Sony service facility.

## Notes

- The SmartFile label is equipped with a memory chip. The memory chip may be damaged and cannot be used when you:
  - twist or fold the SmartFile label.
  - remove the SmartFile label and re-attach it to a tape.
  - attach more than one SmartFile label to a tape.
  - attach metal, or sticker which has metal, to the SmartFile label.
  - write too strongly on the SmartFile label using a ballpoint pen or similar sharp instrument.
  - disassemble or remodel a label.
- Do not leave the SmartFile label in a place subject to excessive dust or dirt, direct sunlight, humidity, mildew, strong magnetism or near heat sources.
- If you attach the SmartFile label to a tape shorter than an E-30, the SmartFile function may not work correctly.

## Recording a programme on the SmartFile tape

When recording a programme on the SmartFile tape, no matter what method you use to record the programme (normal recording, showview recording, etc.), programme data (date, name, channel, recording start time, etc.) is stored in the memory of the SmartFile label. The SmartFile label can contain data for up to 12 programmes. When the number of stored programmes goes over 12, the oldest programme data is erased from the SmartFile list. However, a programme which lasts less than about 20 minutes in LP mode or about 11 minutes in SP mode cannot be stored in the memory. When you record a programme on a SmartFile tape which already contains programme data, see "Recording after locating the Blank Time space" on page 79.

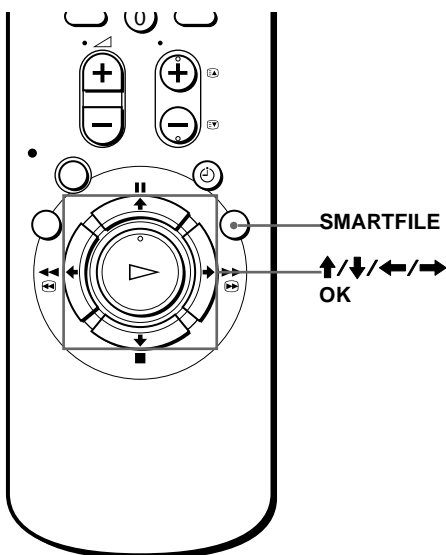

### Before you start...

- Turn on your TV and set it to the video channel
- Check that the VCR clock is set to the correct time and date.

**1** Insert a SmartFile tape with its safety tab in place. The SmartFile indicator lights up.

**2** Press SMARTFILE.  
The SmartFile search list appears on the TV screen.

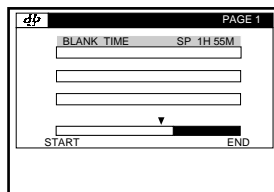

**3** Use **↑** to select BLANKTIME and press OK.  
The VCR starts searching for the longest blank part of the tape. The SmartFile search list disappears.

You can now start recording a programme.

### Tip

- You can protect a recorded programme from accidental over-recording or erasures (see page 94.)

### Note

- If you press the PAUSE button one or more times during recording, thereby creating short lengths of recorded time between such pauses, programme data may not be stored in the SmartFile label.

**continued**

## Checking the information of a recorded programme

Press SMARTFILE. The SmartFile search list appears. The recording day of the week, start time, programme position, date, name, recording time and tape speed appear on the list. The longest space which doesn't have any programme data (Blank Time space) appears as "BLANK TIME":

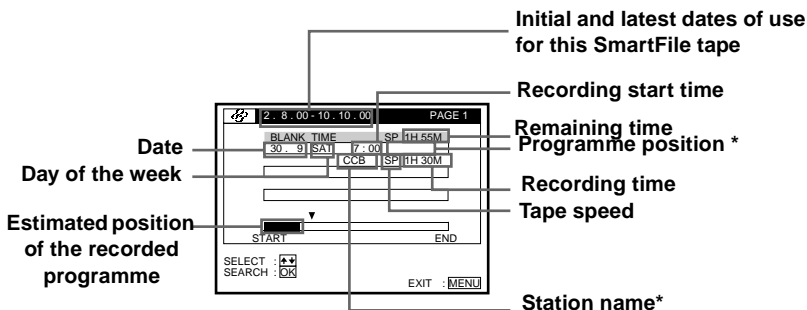

\* When the station name is not available, the programme position is displayed instead.

### Tip

- You can manually name a recorded programme and select the category. You can also name the SmartFile tape.

### Notes

- If you don't set the clock or the clock isn't set to the correct time and date, the recording start time won't be stored correctly on the Smartfile list. Also the programme label won't be stored correctly if the TV guide page information of Teletext is not set correctly (see page 76).
- When you set the AUTO LONG PLAY option to ON in the TAPE OPTIONS menu, and the tape speed automatically changes from SP to LP during recording, the VCR displays the entire recording time converted to SP mode in the SmartFile list.
- The recording time length in the SmartFile list is an estimation and may be slightly different from the actual recorded time length.

## Recording after locating the Blank Time space

The SmartFile function identifies not only the largest amount of available blank space, but also recorded material that doesn't have corresponding programme data stored in the SmartFile label. The longest available recording space (including programmes that are not stored on the SmartFile label) is referred to as "Blank Time space". You can locate the beginning of the Blank Time space for recording. If there is a recorded programme after the Blank Time space, the VCR will record over on that programme unless you stop recording. If there is a programme you want to prevent from being recorded over or erased, protect that programme before you start recording another programme see page 94.

### Before you start...

- Turn on your TV and set it to the video channel.

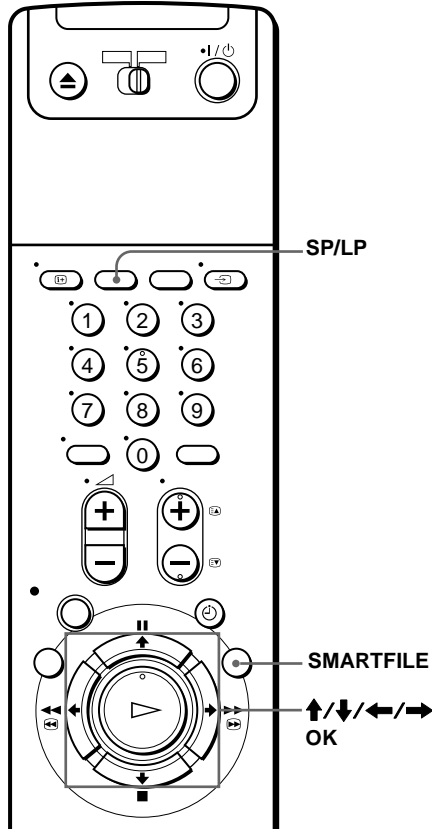

- 1 Insert a SmartFile tape with its safety tab in place. The SMARTFILE indicator lights up on the VCR.
- 2 Press SMARTFILE. The SmartFile search list appears on the TV screen. The Blank Time space appears in the "BLANK TIME" row. The Blank Time space also appears in the display window.

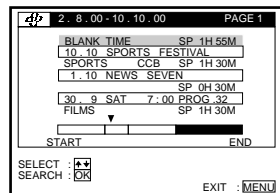

- 3 Press **↑** repeatedly to select BLANK TIME.

continued

**4** Press SP/LP to select the tape speed, SP or LP.

The BLANK TIME changes according to the selected tape speed. Select a tape speed that matches the length of the programme you want to record.

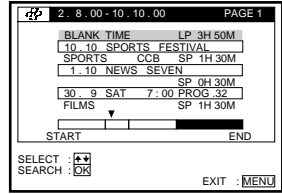

**5** Press OK.

The VCR goes to the beginning of the Blank Time space and stops.

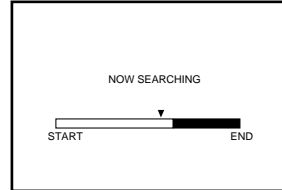

**6** Press PROG +/- to select the programme position you want to record.

**7** Press ● REC to start recording.

**Notes**

- You may not be able to locate the beginning of the Blank Time space correctly in the step 4 above when :
  - the SmartFile tape contains one or more short length (less than about 20 minutes in the LP mode and about 11 minutes in the SP mode) programmes for which programme data is not stored in the SmartFile label.
  - the SmartFile tape is damaged or dirty.
  - the SmartFile tape has a portion recorded in the NTSC system.
- If a newly recorded programme overlaps a stored programme, the stored programme information is erased from the SmartFile list as shown below when :
  - the remaining length of the stored programme becomes less than about 20 minutes in the LP mode and about 11 minutes in the SP mode.
  - the stored programme is over-recorded for more than 20 minutes in the LP mode and about 11 minutes in the SP mode.

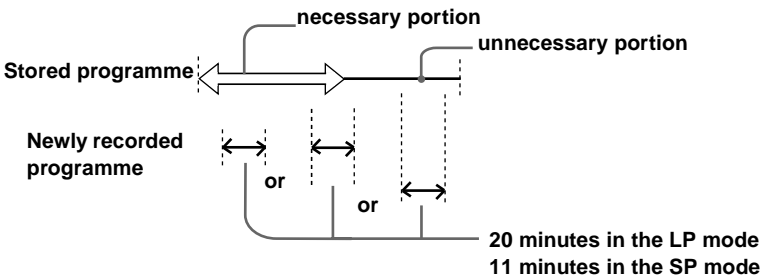



# Selecting and playing a programme

You can automatically locate and start playback of a programme recorded on the SmartFile tape. Select a programme in the SmartFile search list. The SmartFile search list can contain up to 12 programmes.

## Before you start...

- Turn on your TV and set it to the video channel.

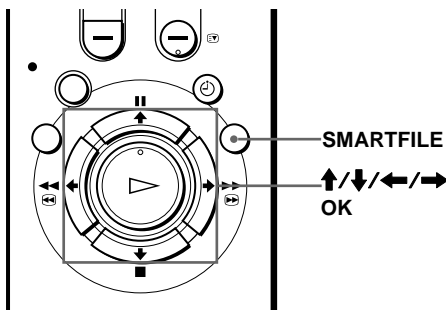

**1** Insert a SmartFile tape.  
The SMARTFILE indicator lights up on the VCR.

**2** Press SMARTFILE.  
The SmartFile search list appears on the TV screen.

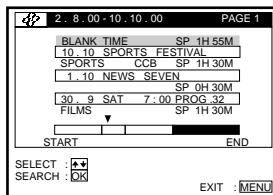

**3** Press **↑/↓** to select a programme.  
Press **↑/↓** repeatedly to turn the pages.

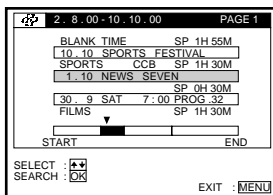

**4** Press OK.  
The VCR starts searching for the beginning of the selected programme.  
Playback starts automatically from that point.

## To stop searching

Press **■** STOP.

### Note

- You may not be able to locate the beginning of the selected programme correctly when :
  - the SmartFile tape contains one or more short length (less than about 20 minutes in the LP mode and about 11 minutes in SP mode) programmes for which programme data is not stored in the SmartFile label.
  - the SmartFile tape is damaged or dirty.
  - the SmartFile tape has a portion recorded in the NTSC system.

# Checking the contents of a tape

You can display the programme data list of a SmartFile tape on the TV screen. It is not necessary to insert the tape into the VCR. This feature allows you to quickly find a specific programme or to find a tape with enough recording space. The SmartFile check list can contain up to 12 programmes.

## Before you start...

- Turn on your TV and set it to the video channel.
- Turn on your VCR.

- 1 Hold the label side of the SmartFile tape close to the SmartFile sensor.

Slowly bring the center of the label within 3 cm of the SmartFile sensor.

There is a short beep, the SMARTFILE indicator lights up on the VCR, and the SmartFile check list appears. The BLANK TIME space also appears in the display window.

SmartFile sensor

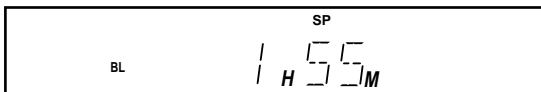
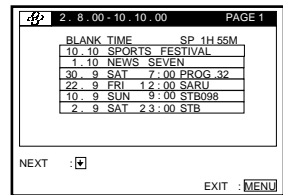
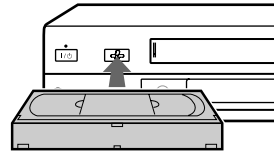
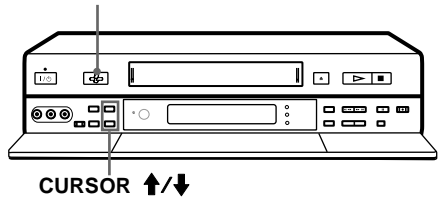

- 2 Press CURSOR ↑/↓ to turn the pages.

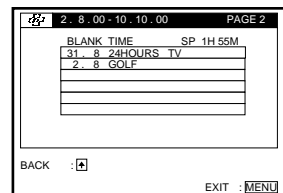

- 3 Press MENU to exit the SmartFile check list.

**Tip**

- If you press any button other than SP/LP or , the SmartFile check list disappears.

**Notes**

- You cannot display the SmartFile check list while :
  - you display the SmartFile list of a different SmartFile tape inserted into the VCR.
  - you display any other menu.
- If the SmartFile check list doesn't appear on the TV screen, try drawing the SmartFile tape at least 5 cm away from the SmartFile sensor, then bring it back to within 3 cm of the sensor.
- The menu disappears automatically if you don't proceed for more than a few minutes.

# Labelling a recorded programme and tape

Some broadcast systems ensure a Teletext service in which the complete programmes and their data (title, date, channel, recording start time etc.) are stored day by day. A TV guide page corresponds to each day of the week. When recording a programme, the VCR automatically takes the label information from the Teletext pages and stores it in the SmartFile label. The TV guide page numbers depend entirely on the broadcast itself and may be subject to change. If so, you may have to set those TV guide page numbers manually in the TV GUIDE PAGE menu.

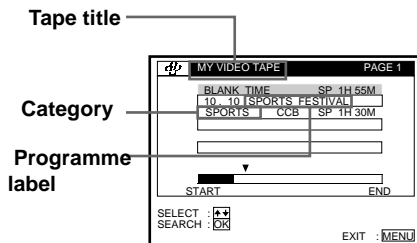

## Setting the TV guide page number

### Before you start...

- Turn on your TV and set it to the video channel.

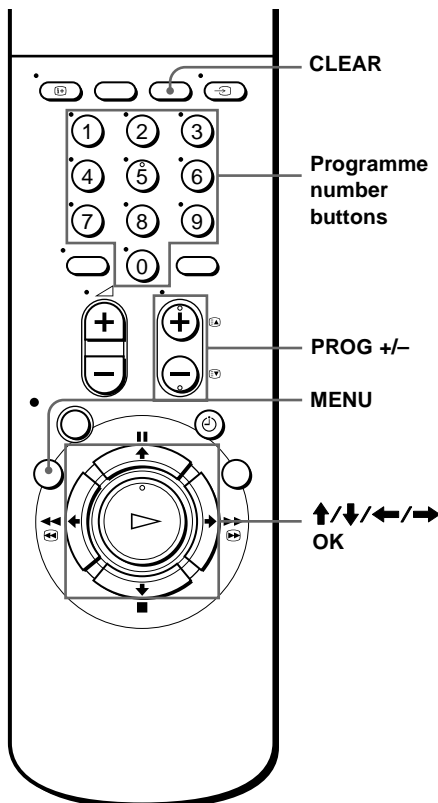

**1** Select the programme position for which you want to set or change the TV guide page.

**2** Press MENU, then press **↑/↓** to highlight SETTINGS and press OK.

**3** Press **↑/↓** to highlight TV GUIDE PAGE and press OK.

- The TV guide page numbers appear automatically when the VCR detects them (P301).
- If the VCR does not detect them (P---), you have to set the TV guide page number manually.

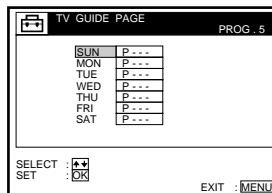
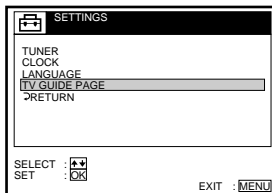

**4** Press **↑/↓** to select the TV guide page number you want to modify and press OK.

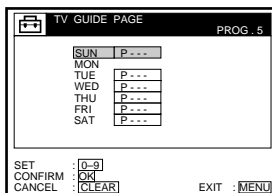

**5** Press the programme number buttons to enter the TV guide page number and press OK to confirm the setting.

If you make a mistake, press CLEAR to re-enter the correct number.

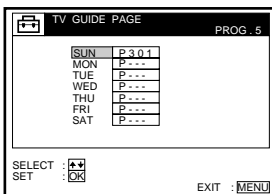

**6** To set or change another TV guide page number, repeat steps 3 and 4 above.

**7** Press MENU to exit the menu.

continued

## Notes

- In step 4 above, enter "000" if you don't want to use the TV guide page number for automatic labelling. The VCR will instead store default data (date, programme position, duration etc.) in the label.
- Refer to the Teletext information on your TV screen to get the TV guide page number with the programme titles and their start times.
- If the Teletext TV guide has a page which always shows the programmes for the current day, this page should be input for all days.
- If you start recording more than two minutes before the programme is scheduled to start, the correct label information may not be transferred. The VCR receives the label information two minutes after the recording starts.
- If you set a timer recording with VPS/PDC OFF, the title information will be transferred in the middle of the recording.
- Note that this function may not work correctly with programmes broadcast from some stations.
- If the Broadcast system updates the Teletext information at the moment recording starts, the title on the label may not correspond to the one of the recorded programme. In this case, you may have to manually enter the correct title using the SMARTFILE EDIT MENU.
- You cannot get the label information from sources connected to the LINE input or the satellite channels.

## Labelling a recorded programme manually

If Teletext data is not available, label and select the appropriate category of the recorded programme manually. Labelling manually takes priority over labelling automatically. You can also label the tape. Up to 18 characters can be input for a programme and tape label.

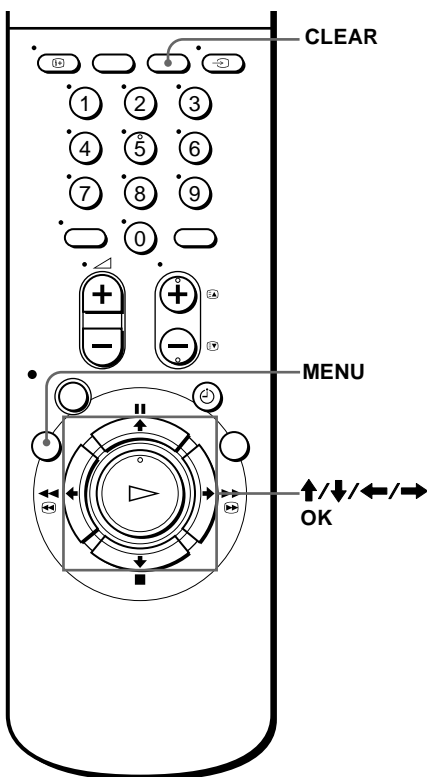

### Before you start...

- Turn on your TV and set it to the video channel.

- 1** Insert a SmartFile tape.  
The SMARTFILE indicator lights up on the VCR.
- 2** Press MENU and select SMARTFILE EDIT and press OK.  
The SMARTFILE EDIT menu appears.

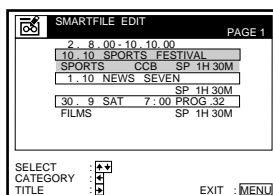

continued

3 Press **↑/↓** to select a programme.

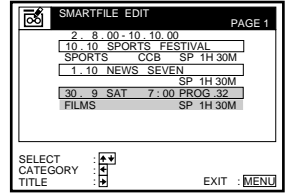

4 Press **→**.

The cursor moves to the programme label input position.

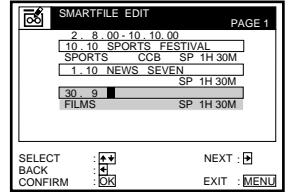

5 Label the programme.

1 Press **↑/↓** to select a character.

Each time you press **↑**, the character changes as shown below.

**A** → **B** → ... → **Z** → **special characters** →

**!** → **&** → **,** (comma) → **-** (hyphen) → **.**

**(period)** → **0** → **1** ... → **9** → **(blank space)**

You can also select a blank space by pressing CLEAR.

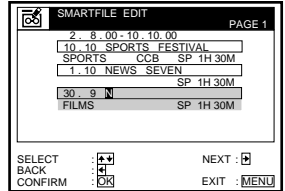

2 To set the next character, press **→**.

The cursor moves to the next position.

3 Repeat steps 1 and 2 to label the programme.

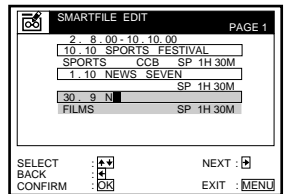

6 Press OK.

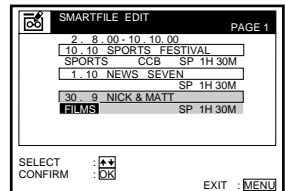



**7** Press  $\uparrow/\downarrow$  to select a category.

Each time you press  $\uparrow$ , the category changes as shown below.

**SPECIAL**  $\rightarrow$  **FILMS**  $\rightarrow$  **NEWS**  $\rightarrow$  **SHOW**  
**SPORTS**  $\rightarrow$  **CHILDREN**  $\rightarrow$  **MUSIC**  $\rightarrow$   
**ARTS**  $\rightarrow$  **SERIES**  $\rightarrow$  **EDUCATION**  $\rightarrow$   
**LEISURE**  $\rightarrow$  **SHOPPING**  $\rightarrow$  **VARIETY**  $\rightarrow$   
**(blank)**

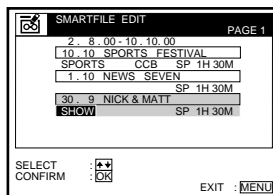

**8** Press OK.

The programme label and a selected category are stored.

**9** Press MENU to exit the menu.

### To erase the programme label

Press CLEAR after step 3 above. The programme label is erased and the default recording data reappear.

### To erase the selected category

Press CLEAR in step 7 above. The selected category is erased and the space becomes blank.

## To label a regularly scheduled timer-recorded programme

Once you label a programme which is set to record regularly (i.e everyday, same day of the week) in the ShowView system or timer recording mode, the VCR recognizes the label and will automatically label all future recordings of the same programme. The set label is assigned even when an information signal containing the programme name, category name or other information is broadcast with the programme. However, if you change the programme label and the category several times, the VCR may automatically assign the set label only to the last recorded programme for which the programme label and category were changed.

**continued**

# Labelling a tape

## Before you start...

- Turn on your TV and set it to the video channel.

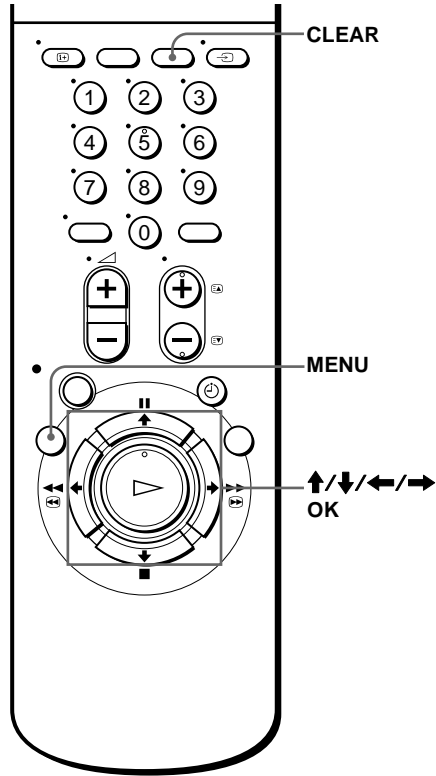

- 1** Insert a SmartFile tape.  
The SMARTFILE indicator lights up on the VCR.
- 2** Press MENU and select SMARTFILE EDIT, then press OK.  
The SMARTFILE EDIT menu appears.

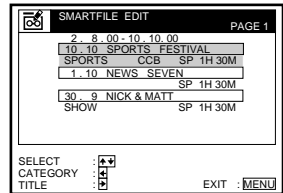

**3** Press **↑** to select the tape title.

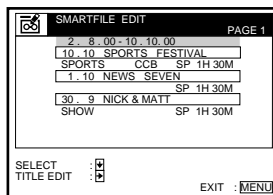

**4** Press **→**.  
The cursor moves to the title input position.

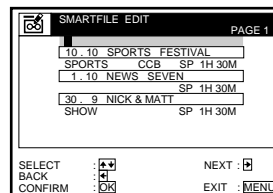

**5** Label the tape.

- Press **↑/↓** to select a character.  
Each time you press **↑**, the character changes as shown below.  
**A** → **B** → ... → **Z** → **special characters** → **! → & → , (comma) → - (hyphen) → . (period) → 0 → 1 ... → 9 → (blank space)**

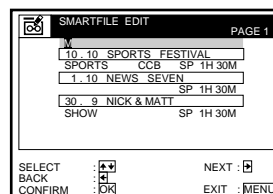

You can also select a blank space by pressing **CLEAR**.

- To set the next character, press **→**.  
The cursor moves to the next position.
- Repeat steps 1 and 2 to label the tape.

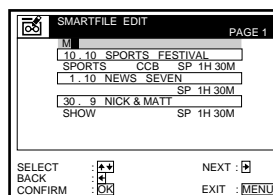

**6** Press **OK**.  
The tape title is stored.

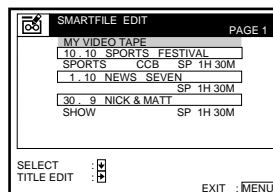

**7** Press **MENU** to exit the menu.

### To erase the tape title

Press **CLEAR** after step 3 above. The tape title is erased and the recording date reappears. When you want to erase the recording date from the tape title column, press **CLEAR** again.

# Registering the contents of a recorded tape in the SmartFile label

The VCR will register programmes recorded on a tape (even a non-SmartFile recorded tape) in the memory of a new SmartFile label by detecting the index signals indicating the start of recorded programmes. You can register up to the 12th programme from the start of the tape. The programmes appear from the bottom of the screen as PROGRAM NO. 1, PROGRAM NO.2, ... PROGRAM NO.12 in this order. The 13th and subsequent programmes are ignored. You can manually name the registered programme numbers and select the category (see page 84).

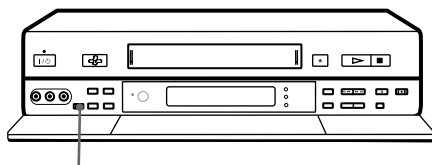

**SMARTFILE GENERATOR**

## Before you start...

- Turn on your TV and set it to the video channel.
- Turn on your VCR.

- 1** Attach the SmartFile label to the spine of the cassette as shown on the right and insert the tape.

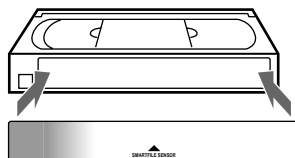

- 2** Press the SMARTFILE GENERATOR button on the VCR.

A message appears indicating that the recorded programmes are being registered. The index signals are detected from the start of the tape, and the registration stops when the end of the tape is reached. The message disappears when registration is complete.

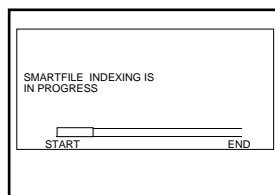

## To stop registration to the SmartFile label

Press SMARTFILE GENERATOR.

The data registered before the button is pressed remains in the SmartFile label. You can register the programmes again by pressing SMARTFILE GENERATOR again.

## To check the information of a registered programme

Press SMARTFILE.

The SmartFile search list appears. The registered programme number, registration date and recording time appear in this list. Note that the registration date differs from the recorded date.

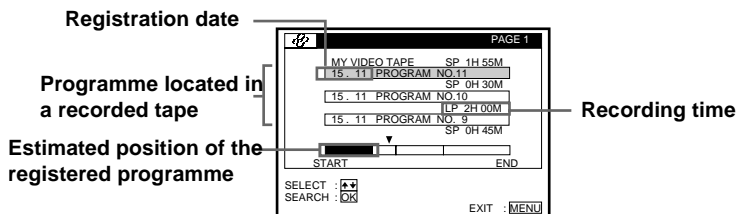

### Tips

- The programmes recorded on the tape can be registered again in a SmartFile label that already contains programme data. However, the recorded date and time, programme name and information input manually (such as the programme label and category) are replaced with "PROGRAM NO. XX".
- If the SmartFile label contains stored programme data that includes protected programmes, a message appears and the registration stops.

### Notes

- Programme data is not registered correctly in the SmartFile label when :
  - the programme length is about 20 minutes or less in LP mode or about 11 minutes in SP mode.
  - the programme does not have an index signal or the index signal has been recorded over and erased.
  - the tape is damaged or dirty.
- If you don't set the clock or the clock isn't set to the correct date, the registration date won't be stored correctly on the SmartFile list.
- After you press SMARTFILE GENERATOR and start registration, registration is interrupted if you press ■ STOP, ▷ PLAY, ►► FF, ◀◀ REW, I/O or ◀◀/►► INDEX SEARCH. In these cases as well, the data registered up to the point when registration was interrupted remains in the SmartFile label.
- When you set AUTO LONG PLAY to ON in the TAPE OPTIONS menu, and the tape speed automatically changes from SP to LP during recording, the VCR displays the entire recording time converted to SP mode in the SmartFile list.
- The estimated position of the registered programmes may not be correct if many short programmes are recorded on long tapes.

# Protecting a recorded programme

You can protect a recorded programme from accidental over-recording or erasure using the SmartFile function.

When you start recording from a position prior to the protected programme, the recording stops automatically before the protected programme.

## Before you start...

- Turn on your TV and set it to the video channel.

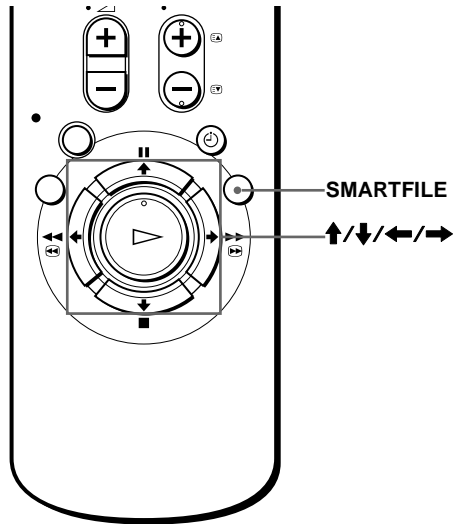

- 1 Insert a SmartFile tape.  
The SMARTFILE indicator lights up on the VCR.

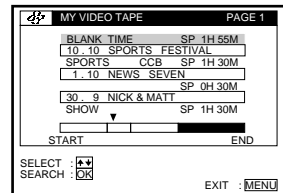

- 2 Press SMARTFILE.  
The SmartFile search list appears on the TV screen.

- 3 Press  $\uparrow/\downarrow$  to select the programme you want to protect.

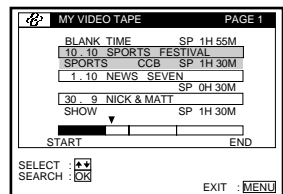

#### 4 Press →.

The  indicator appears to the left of the selected programme and the programme is now protected.

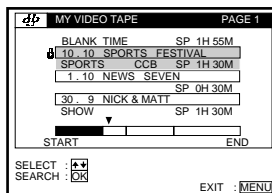

#### 5 Press SMARTFILE.

The SmartFile search list disappears.

### To unlock the protected programme

Press ← in step 4 above. The  indicator disappears and you can record over this programme.

#### Tips

- When you start recording from a position prior to the protected programme, the recording automatically stops no more than about four minutes in SP mode and about eight minutes in LP mode before the beginning of the protected programme. The BLANK TIME indicator flashes in the display window.
- If you protect a programme just after the Blank Time space, BLANK TIME is shortened by about four minutes in SP mode and about eight minutes in LP mode.
- If you try to record on a SmartFile tape containing a protected programme, a message indicating that there is a protected programme on this tape appears on the TV screen.

#### Notes

- When you record another programme just after a protected programme, locate the beginning of the Blank Time space by following the instructions in “Recording after locating the Blank Time space“ on page 79. Otherwise, if the recording start point overlaps the protected programme, the VCR may over-record the protected programme.
- If you insert a SmartFile tape which contains a protected programme or protect a programme for the first time on a new tape, the VCR will analyse the position of the protected programme for a few seconds. You cannot operate the VCR while the VCR is analysing the tape.
- If the SmartFile list contains 12 protected programmes, the next programme you record won't be stored in the SmartFile list.
- When you try to turn off the VCR after setting a ShowView or timer recording on the protected programme, the VCR automatically ejects the cassette.
- The protect function may not work with an NTSC-recorded tape.

# Erasing the data of an unwanted programme

You can erase an unwanted programme from the SmartFile list.

When you erase a programme from the list, that portion of tape becomes Blank Time space.

## Before you start . . .

- Turn on your TV and set it to the video channel.

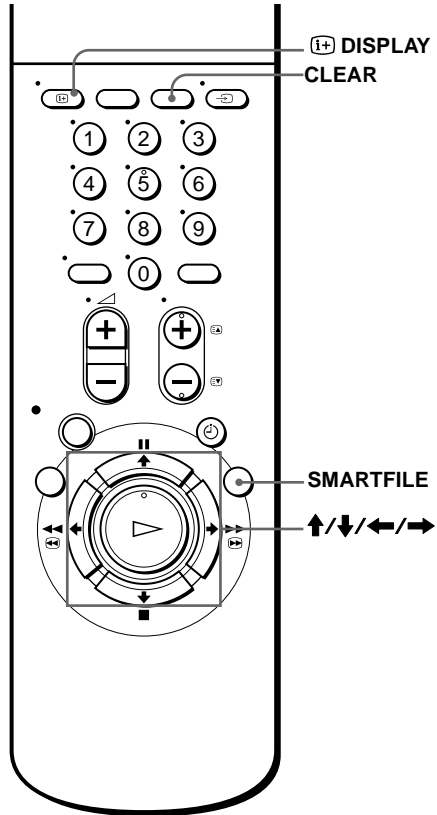

- 1 Insert a SmartFile tape.  
The SMARTFILE indicator lights up on the VCR.

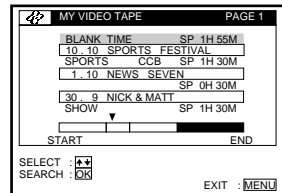

- 2 Press SMARTFILE.  
The SmartFile search list appears on the TV screen.



- 3** Press **↑/↓** to select a programme you want to erase from the list.

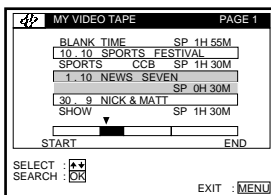

- 4** Press **CLEAR**.

The selected programme is erased from the SmartFile list.

If you erase a programme by mistake, press **[+] DISPLAY** to make the programme reappear.

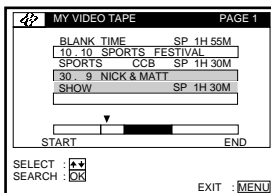

- 5** Press **SMARTFILE**.

The SmartFile search list disappears.

### Notes

- You cannot erase a protected programme from the SmartFile list. You have to first unlock the protected programme by following the instructions in “To unlock the protected programme” on page 95, then erase that programme from the list.
- The erased programme disappears from the SmartFile list, but it still remains on the tape.
- If the remaining length of a program is about 11 minutes or less in SP mode or about 20 minutes or less in LP mode, you cannot make the programme reappear by using the **[+] DISPLAY** button.

# Troubleshooting

If you have any questions or if your problems are not covered below, please consult your nearest Sony service facility.

## Problem summary

The following table summarizes the reference numbers for the problems you might face. In order to solve your problem, please refer to the corresponding reference (S1=symptom1, S2=symptom2 ...) in the right column below.

CATEGORY	REFER TO
<b>Picture</b> <ul style="list-style-type: none"> <li>• while watching broadcast tuned by the TV</li> <li>• while watching broadcast tuned by the VCR.</li> <li>• while playing a tape.</li> </ul>	<b>S2, S6</b> <b>S1, S6</b> <b>S3, S4, S5</b>
<b>Sound</b> <ul style="list-style-type: none"> <li>• while playing a tape.</li> </ul>	<b>S7, S8, S9</b>
<b>Functional</b> <ul style="list-style-type: none"> <li>• Playback</li> <li>• Normal recording</li> <li>• SmartFile</li> <li>• Timer recording</li> <li>• Synchronized Recording</li> <li>• Canal Plus</li> <li>• Line selection</li> <li>• Remote commander</li> <li>• Cleaning</li> <li>• Clock</li> <li>• Power</li> <li>• Tape</li> <li>• SMARTLINK</li> <li>• Set-Top Box</li> </ul>	<b>S4, S9, S10</b> <b>S11, S12</b> <b>S13, S14</b> <b>S15, S16</b> <b>S17, S18, S19</b> <b>S20, S21, S22</b> <b>S23</b> <b>S24, S25</b> <b>S26</b> <b>S27</b> <b>S28, S29, S30, S31, S32</b> <b>S33, S34</b> <b>S35</b> <b>S36</b>

<b>Picture</b>		
<b>S1</b>	The VCR picture does not appear on the TV screen.	<ul style="list-style-type: none"> <li>→ Make sure the TV is set to the video channel. If you are using a monitor, set it to video input.</li> <li>→ If the VCR is connected to the TV with a Scart cable, make sure the TV/VIDEO indicator is lit in the display window. Use the TV/VIDEO key on the remote commander to lit the TV/VIDEO indicator.</li> <li>→ If your VCR is connected to the TV with only anaerial cable, make sure the TV is correctly tuned to the VCR (see page 12).</li> </ul>
<b>S2</b>	The TV programme is not clear or has some interference.	<ul style="list-style-type: none"> <li>→ If your TV is connected to the VCR with a Scart and an aerial cables, make sure the RF MODULATOR is set to OFF (see page 18).</li> <li>→ If your VCR is connected to the TV with only an aerial cable, make sure the TV is correctly tuned to the VCR (see page 12).</li> </ul>
<b>S3</b>	The playback picture is not clear or has some interference.	<ul style="list-style-type: none"> <li>→ If your TV is connected to the VCR with a Scart and an aerial cables, make sure the RF MODULATOR is set to OFF (see page 18).</li> <li>→ Existing broadcasts may interfere with the VCR. Reset the RF MODULATOR output of your VCR (see page 18).</li> <li>→ Adjust the tracking with the TRACKING +/- buttons (see page 66).</li> <li>→ The video heads are dirty (see below). Clean the video heads using the Sony T-25CLD, E-25CLDR, or T-25CLW video head cleaning cassette. If these cleaning cassettes are not available in your area, have the heads cleaned at your nearest Sony service facility (a standard service charge will be required). Do not use a commercially available liquid type cleaning cassette other than Sony's, as it may damage the video heads.</li> <li>→ The video heads may have to be replaced. Consult your local Sony service facility for more information.</li> </ul>
<b>S4</b>	The tracking meter does not appear on the TV screen.	→ The recording condition of the tape is very poor and tracking cannot be adjusted.

### Symptoms caused by contaminated video heads

• Normal picture



• Rough picture



initial  
contamination

Unclear picture



• No picture (or black & white screen appears)



terminal

**continued**

<b>Picture</b>		
<b>S5</b>	The picture rolls vertically during picture search.	→ Adjust the vertical hold control on the TV or monitor.
<b>S6</b>	TV reception is poor.	→ Make sure the aerial cables are connected securely. → Adjust the TV aerial. → Make sure SYSTEM (B/G or D/K) in the TUNER menu is set to the system in your area.
<b>Sound</b>		
<b>S7</b>	The picture has no sound.	→ The tape is defective. Please use a new tape. → Make sure SYSTEM (B/G or D/K) in the TUNER menu is set to the system in your area.
<b>S8</b>	The sound is unstable or has an echo.	→ When you play a tape with the same sound recorded on both the hi-fi and normal sound tracks, make sure AUDIO MIX in the AUDIO OPTIONS menu is set to OFF (see page 69).
<b>S9</b>	You cannot select the left or the right channel while playing a tape	→ Make sure AUDIO MIX is set to OFF in the AUDIO OPTIONS menu (see page 69). → Make sure you are playing a hi-fi tape.
<b>Playback</b>		
<b>S10</b>	The tape starts playing as soon as it is inserted.	→ This is normal. When you insert a tape with no safety tab, the VCR starts playing automatically.
<b>Normal recording</b>		
<b>S11</b>	The tape is ejected when you press ● REC.	→ The safety tab has been removed. To record on this tape, cover the tab hole (see page 46).
<b>S12</b>	Nothing happens when you press ● REC.	→ Make sure the tape is not at its end. → If the BL indicator is flashing in the display window, the tape contains a programme protected by the SmartFile function (see page 94).
<b>SmartFile</b>		
<b>S13</b>	The programme label cannot be taken properly.	→ Make sure the clock and the date are set correctly. → Check the setting of the TV guide pages. Some stations may not offer this service (see page 84). → If you start recording more than two minutes before the beginning of the programme, the title on the label may not correspond to the one of the recorded programme. Manually enter the correct title using the SMARTFILE EDIT menu (see page 87). → If the TV reception is poor, the VCR will not be able to take the title correctly. Manually enter the correct title using the SMARTFILE EDIT menu (see page 87).
<b>S14</b>	Recording stops halfway.	→ If the tape contains a programme protected by the SmartFile function, recording automatically stops before the protected programme. Use another tape which has enough recording space.

<b>Timer recording</b>		
<b>S15</b>	The timer does not operate properly.	<ul style="list-style-type: none"> <li>→ Check that the clock is set.</li> <li>→ The clock stops if the VCR is disconnected from the mains for more than an hour. Reset the clock and the timer.</li> <li>→ Check that the safety tab has not been removed.</li> <li>→ If the timer recording overlaps a programme protected by the SmartFile function, the recording stops halfway (see page 94).</li> <li>→ The starting point of the recording overlaps a protected programme.</li> <li>→ Make sure the tape is not at its end.</li> <li>→ Make sure a tape has been inserted.</li> <li>→ Make sure the current time is not already past your timer settings .</li> <li>→ If you are recording a programme from a Set-Top Box, make sure the Set-Top Box is turned on.</li> </ul>
<b>S16</b>	The VPS/PDC function does not operate properly.	<ul style="list-style-type: none"> <li>→ Check that the clock and the date are set correctly.</li> <li>→ Check that the VPS/PDC time you set is the correct one (there might be a mistake in the TV guide programme). If the broadcast you wanted to record did not send the correct VPS/PDC information, the VCR will not start recording.</li> <li>→ If the reception is poor, the VPS/PDC signal might be altered and the VCR might not start recording.</li> </ul>
<b>Synchronized Recording</b>		
<b>S17</b>	The SYNCHRO REC indicator turns off while recording or does not go back to recording standby mode.	<ul style="list-style-type: none"> <li>→ The tape has reached its end. Insert a new tape and press SYNCHRO REC again.</li> </ul>
<b>S18</b>	The Synchronized Recording function does not work.	<ul style="list-style-type: none"> <li>→ The connected equipment was not turned off. Turn off the connected equipment and press SYNCHRO REC again.</li> <li>→ There was a power failure. Press SYNCHRO REC again.</li> </ul>
<b>S19</b>	The programme recorded with the Synchronized Recording function is incomplete.	<ul style="list-style-type: none"> <li>→ If the settings for timer recordings and Synchronized Recording overlap, the programme that starts first has priority and the second programme starts recording only after the first programme has finished.</li> <li>→ There was a power failure. Press SYNCHRO REC again.</li> </ul>
<b>Canal Plus</b>		
<b>S20</b>	You cannot set channels as PAY-TV/CANAL+ in the TUNER menu.	<ul style="list-style-type: none"> <li>→ Be sure that DECODER/LINE3 is set to DECODER in the OTHER OPTIONS menu (see page 70).</li> </ul>
<b>S21</b>	You cannot watch Canal Plus when the VCR is in standby mode.	<ul style="list-style-type: none"> <li>→ Be sure that DECODER/LINE3 is set to DECODER in the OTHER OPTIONS menu (see page 70).</li> <li>→ Make sure the Canal Plus Scart cable is plugged in securely.</li> </ul>

<b>Canal Plus</b>		
<b>S22</b>	PAY-TV/Canal Plus is always recorded scrambled.	<ul style="list-style-type: none"> <li>→ Make sure the Canal Plus Scart cable is plugged in securely.</li> <li>→ Be sure that DECODER/LINE3 is set to DECODER in the OTHER OPTIONS menu (see page 70).</li> <li>→ Be sure that this channel is set as PAY-TV/CANAL+ in the TUNER menu (see page 36).</li> </ul>
<b>Line selection</b>		
<b>S23</b>	You cannot select LINE3.	→ Be sure that DECODER/LINE3 is set to LINE3 in the OTHER OPTIONS menu (see page 70).
<b>Remote commander</b>		
<b>S24</b>	The remote commander does not operate.	<ul style="list-style-type: none"> <li>→ Make sure you are pointing the remote commander at the remote sensor on the VCR.</li> <li>→ Replace all of the batteries in the remote commander with new ones if they are weak.</li> <li>→ Make sure the TV/VIDEO remote control switch is set correctly.</li> </ul>
<b>S25</b>	You cannot control your TV.	→ Set your TV's code number. The code number may change when you replace the batteries for the remote commander (see page 8).
<b>Cleaning</b>		
<b>S26</b>	The VCR needs to be cleaned.	→ Clean the cabinet, panel and controls with a dry, soft cloth, or a soft cloth slightly moistened with a mild detergent solution. Do not use any type of solvent, such as alcohol or benzene.
<b>Clock</b>		
<b>S27</b>	The clock has stopped and “-:--” lights up in the display window.	→ The clock stops if the VCR is disconnected from the mains for more than one hour. Reset the clock and timer if needed (see page 21).
<b>Power</b>		
<b>S28</b>	The I/ON/STANDBY switch does not function.	→ Connect the mains lead to the mains securely.
<b>S29</b>	The power is turned on but the VCR does not operate.	→ Moisture condensation has occurred. Turn the power off, unplug the mains lead and leave the VCR to dry for over three hours.
<b>S30</b>	The tape is ejected when you press I/ON/STANDBY.	→ You have set a timer recording, but the tape on which you want to record is protected (or contains protected recordings). Unlock the protection or use another tape or replace the safety tab (see page 95).
<b>S31</b>	The display does not lit when the VCR is in standby mode.	→ The VCR is in power save mode. Set the POWER SAVE option to OFF in the OTHER OPTIONS menu (see page 70).
<b>S32</b>	POWER SAVE is set to ON but the display remains lit in standby mode.	→ The display is always lit if the VCR is in timer standby mode. For more details regarding the energy saving function, see page 70.

<b>Tape</b>		
<b>S33</b>	The tape is ejected when you press I/⏻ ON/STANDBY.	→ You have set a timer recording, but the tape on which you want to record is protected (or contains protected recordings). Unlock the protection or use another tape or replace the safety tab (see page 95).
<b>S34</b>	A tape cannot be inserted.	→ Check that a tape isn't already in the tape compartment.
<b>SMARTLINK</b>		
<b>S35</b>	The SMARTLINK function does not work properly.	<ul style="list-style-type: none"> <li>→ Check that your TV complies with SMARTLINK, NexTVView Link, MEGALOGIC, EASYLINK/CinemaLink, Q-Link or TV-LINK.</li> <li>→ Make sure you use the Scart cable, supplied with the VCR, to connect the VCR and your TV.</li> <li>→ Make sure the Scart cable is connected securely. Refer to your TV manual for instructions.</li> </ul>
<b>Set-Top Box</b>		
<b>S36</b>	You cannot watch the satellite tuner picture when the VCR is in standby mode or ● REC standby mode.	<ul style="list-style-type: none"> <li>→ Be sure that the DECODER/LINE-3 is set to LINE3- in the OTHER OPTIONS menu (see page 70).</li> <li>→ Make sure the POWER SAVE option is set to OFF in the OTHER OPTIONS menu (see page 70).</li> </ul>

# Specifications

## System

### Channel coverage

- PAL (D/K, B/G)
- VHF E2 to E12, R1-R12
- VHF Italian channel A to H
- UHF E21 to E69, R21-R69
- CATV S01 to S05, S1 to S41

### RF output signal

- UHF channels 21 to 69

### Aerial out

- 75-ohm asymmetrical aerial socket

### Tape speed

- SP: PAL/MESECAM 23.39 mm/s (recording/playback)
- NTSC33.35 mm/s (playback only)
- LP: PAL/MESECAM 11.70 mm/s (recording/playback)
- NTSC16.67 mm/s (playback only)
- EP:NTSC11.12 mm/s (playback only)

### Maximum recording/playback time

- 10 hrs. in LP mode (with E300 tape)

### Fast-forward and rewind time

- Approx. 1 min. (with E180 tape)

## Inputs and outputs

### ⇨LINE-1 (TV)

- 21-pin
- Video input: pin 20
- Audio input: pins 2 and 6
- Video output: pin 19
- Audio output: pins 1 and 3

### DECODER/⇨ LINE-3 IN

- 21-pin
- Video input: pin 20
- Audio input: pins 2 and 6

### LINE-2 IN

- VIDEO IN, phono jack (1)

Input signal: 1 Vp-p, 75 ohms, unbalanced, sync negative

AUDIO IN, phono jack (2)

Input level: 327 mVrms

Input impedance : more than 47 kilohms

### LINE-2 OUT

VIDEO OUT, phono jack (1)

Output signal: 1 Vp-p, 75 ohms, unbalanced, sync negative

AUDIO OUT, phono jack (2)

Rated output level: 327 mVrms

Load impedance: 47 kilohms

Output impedance: less than 10 kilohms

## General

### Power requirements

220 – 240 V AC, 50 Hz

### Power consumption

25 W (Normal)

2,7 W (POWER SAVE is set to ON, no decoder)

### Operating temperature

5°C to 40°C

### Storage temperature

-20°C to 60°C

### Dimensions

Approx. 430 × 100 × 330 mm (w/h/d)  
including projecting parts and controls

### Mass

Approx. 4.8 kg

## Supplied accessories

Remote commander (1)

R6 (size AA) batteries (2)

Aerial cable (1)

SmartFile labels (10)

Design and specifications are subject to change without notice.



# Index to parts and controls

Refer to the pages indicated in parentheses ( ) for details.

## Front panel

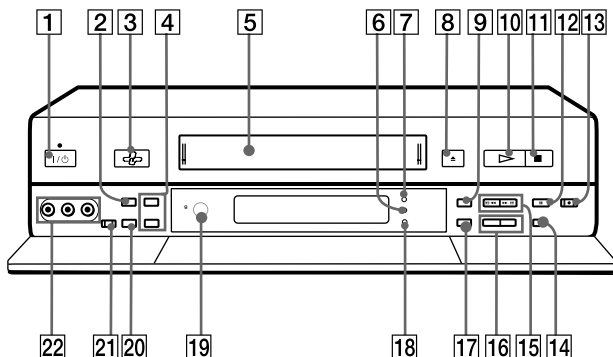

**1** I/⏻ (on/standby) button/indicator (6)

**2** SMARTFILE button (75)

**3** SMARTFILE sensor (82)

**4** CURSOR **↑/↓** buttons (82)

**5** Tape compartment

**6** REALITY REGENERATOR (RR) indicator (66)

**7** SYNCHRO REC indicator (60)

**8** **▲** (eject) button (42)

**9** SYNCHRO REC button (60)

**10** **▷** (playback) button (42)

**11** **■** (stop) button (42)

**12** **||** (pause) button (42)

**13** **●** (record) button (44),(73)

**14** AUTO SET UP (19)/  
RF (Radio Frequency) CHANNEL  
button(16)

**15** **▶▶** (fast-forward)  
**◀◀** (rewind) buttons (42)

**16** PROGRAM/TRACKING +/- buttons  
(16), (19), (66)

**17** REALITY REGENERATOR button (66)

**18** SMARTFILE indicator (82)

**19** Remote sensor (5)

**20** OK button

**21** SMARTFILE GENERATOR button

**22** LINE-2 IN VIDEO/AUDIO L/R jacks  
(71)

continued

## Display window

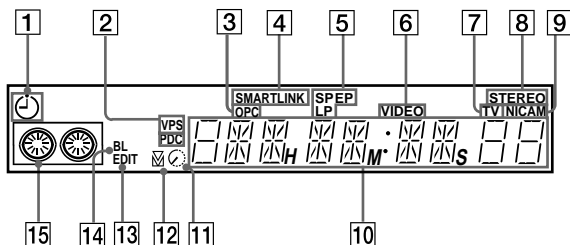

- |   |   |
|---|---|
| <b>1</b> Timer indicator (48), (53)   | <b>8</b> STEREO indicator (63)  |
| <b>2</b> VPS (Video Programme System)/PDC (Programme Delivery Control) indicator (51) | <b>9</b> NICAM indicator (63)   |
| <b>3</b> OPC (Optimum Picture Control) indicator (66)                                 | <b>10</b> Time counter/clock/line/programme position indicator (16), (42), (45) |
| <b>4</b> SMARTLINK indicator (11)   | <b>11</b> Remaining time indicator (46)   |
| <b>5</b> Tape speed indicators (45)   | <b>12</b> Tracking indicator (66)   |
| <b>6</b> VIDEO indicator (45)   | <b>13</b> EDIT indicator (73)   |
| <b>7</b> TV indicator (47)  | <b>14</b> BL (Blank Time space) indicator (82)                                  |
|   | <b>15</b> Tape/recording indicator (45)   |

## Rear panel

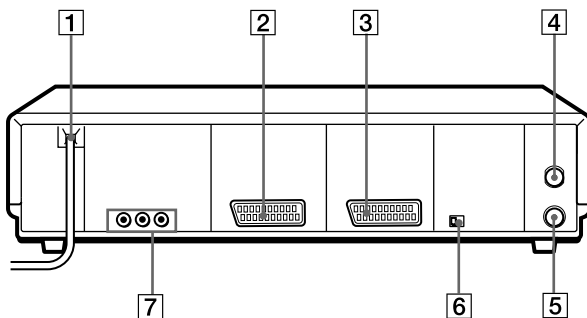

- |   |  |
|---|--|
| <b>1</b> Mains lead (9), (12)   | <b>5</b> AERIAL OUT<br>ANTENNE SORTIE connector (9), (12)                                      |
| <b>2</b> ↻ LINE-1 (TV)<br>↻ LIGNE-1 (TV) connector (9), (36)                | <b>6</b> NTSC PB (Play Back) switch (41)   |
| <b>3</b> DECODER/↻ LINE-3 IN<br>DECODEUR/↻ ENTREE LIGNE-3<br>connector (36) | <b>7</b> LINE-2 OUT<br>AUDIO L(left)/R (right)/VIDEO<br>SORTIE LIGNE-2<br>AUDIO G/D/VIDEO (15) |
| <b>4</b> AERIAL IN<br>ANTENNE ENTREE connector (9), (12)                    |  |

## Remote commander

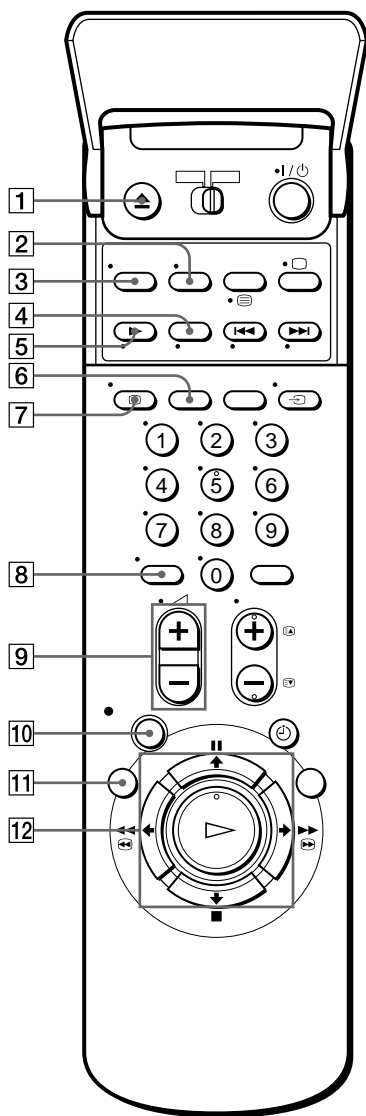

- 1 ▲ EJECT button (42)
- 2 WIDE button (*for TV*) (7)
- 3 AUDIO MONITOR button (6), (63)
- 4 X2 button\*
- 5 ► SLOW button\*
- 6 SP (Standard Play)/LP (Long Play) button (44)
- 7 [i+] DISPLAY button (46)
- 8 -/- (ten's digit) button (6), (46)
- 9 ∟ (volume) +/- buttons (*for TV*) (6)
- 10 ● REC (record) button (44), (58), (73)
- 11 MENU button
- 12 ↑/↓/←/→ buttons  
OK button
- ◀◀ ◀ REW (rewind) button (42), (56)
- ▶▶ ▶ FF (fast-forward) button (42), (56)
- ▷ PLAY button (42), (56)
- STOP button (42), (58)
- ▬ PAUSE button (42), (58)

\* FASTTEXT buttons (*for TV*)

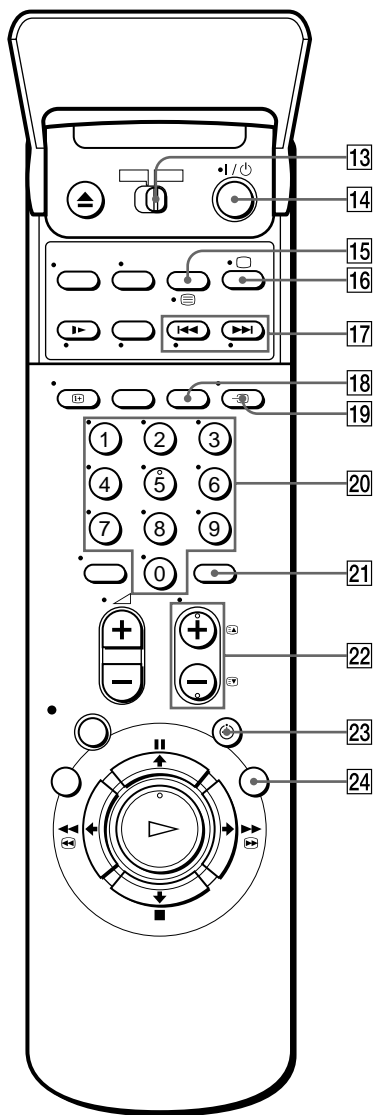

- 13 TV/VIDEO remote control switch (5)
- 14 I/⏻ (on/standby) button (6), (53)
- 15 COUNTER/REMAIN button\* (46)  
☰ (Teletext) button (*for TV*) (6)
- 16 □ TV power on/TV mode select button  
(*for TV*) (6)
- 17 ◀◀/▶▶ INDEX SEARCH buttons\*  
(65)
- 18 CLEAR button (41), (48), (61)
- 19 ⇄ TV/VIDEO button (6)
- 20 Programme number buttons (6)
- 21 INPUT SELECT button (45), (53)
- 22 PROG (programme) +/- buttons (6),  
(26) (45)  
⬆/⬇ Teletext page access buttons (*for TV*) (7)
- 23 ⏰ TIMER button (48), (53)
- 24 SMARTFILE button (77)

\* FASTTEXT buttons (*for TV*)

# Menu chart

This VCR is equipped with an on-screen indication system which allows you a visual, quick and easy selection of the different menus. For a total view of all the menus, please refer to the following chart.

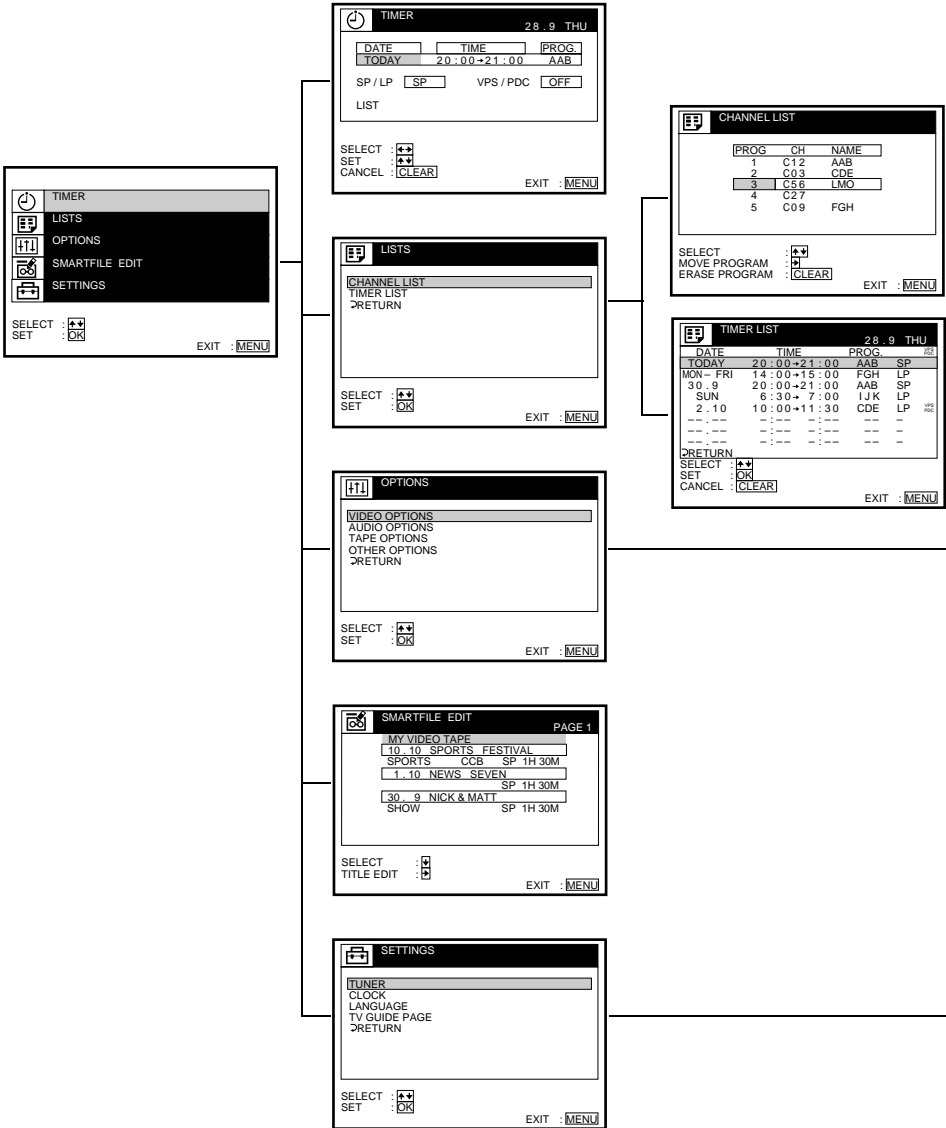

**HTL VIDEO OPTIONS**

GPC	ON
EDIT	OFF
SHARPNESS	NORMAL
COLOUR SYSTEM	AUTO
RR	NORMAL

RETURN

SELECT : **↔**  
SET : **OK**      EXIT : **MENU**

**HTL AUDIO OPTIONS**

AUDIO MIX	OFF
HIFI AUDIO	NICAM

RETURN

SELECT : **↔**  
SET : **OK**      EXIT : **MENU**

**HTL TAPE OPTIONS**

AUTO LONG PLAY	OFF
TAPE LENGTH	E180

RETURN

SELECT : **↔**  
SET : **OK**      EXIT : **MENU**

**HTL OTHER OPTIONS**

BUZZER	ON
DIMMER	OFF
DECODER LINES	DECODER
POWER SAVE	OFF
TIMER OPTIONS	VARIABLE
TV DIRECT REC	ON

RETURN

SELECT : **↔**  
SET : **OK**      EXIT : **MENU**

**TUNER**      **PROG. 1**

SYSTEM	D/K
NORMAL / CATV	NORMAL
CHANNEL SET	C12 AAB
PAY - TV / CANAL+	OFF
AFT	ON

FINE TUNING  
RETURN

SELECT : **↔**  
SET : **OK**      EXIT : **MENU**

**CLOCK**

AUTO ADJUST  
CLOCK PROGRAM      1      AAB  
MANUAL ADJUST  
[ 28 . 9 . 2000 THU 18 : 00 ]

SELECT : **↔**  
CONFIRM : **OK**      EXIT : **MENU**

**LANGUAGE**

**ENGLISH**  
POLSKI  
CESKY  
MAGYAR  
SLOVENŠINA  
TURKCE  
РУССКИЙ

SELECT : **↔**  
SET : **OK**      EXIT : **MENU**

**TV GUIDE PAGE**      **PROG. 5**

SUN	P 3 0 1
MON	P - - -
TUE	P - - -
WED	P - - -
THU	P - - -
FRI	P - - -
SAT	P - - -

SELECT : **↔**  
SET : **OK**      EXIT : **MENU**

# SONY

**Sony International (Europe) GmbH**  
Advanced Technology Center Stuttgart  
Hedelfinger Straße 61, D-70327 Stuttgart  
Telefon (07 11) 58 58-0, Telefax (07 11) 58 58-235

## DECLARATION OF CONFORMITY

We Sony International (Europe) GmbH  
Hedelfinger Str. 61, 70327 Stuttgart, Germany

declare under our sole responsibility that the product

**Category Name:** Video Cassette Recorder  
**Model Name:** SLV-SF950N

to which this declaration relates is in conformity with the following standard(s) or other normative document(s)

**Art.3.1 (a):** EN 60065 (1998)  
**Art.3.1 (b):** EN 55013 (1990) + Am. 12 (1994), EN 55020 (1990),  
EN 61000-3-2 (1995), EN 61000-3-3 (1995), ETS 300683 (1997)  
**Art.3.2 :** EN 300330 (1999)  
**Art.3.3 :** not applicable

following the provisions of 1999/5/EC, R&TTE directive(s)

Germany, May 18, 2000

  
Hubert Klamm  
Senior Manager  
Product Compliance Europe





# Index

## A

- Accessories supplied 4
- Adjusting
  - picture 29, 66
  - tracking 66
- AFT (Auto Fine Tuning) 29
- Audio track 64
- Auto Clock set 23
- Auto Set Up 19

## C

- Canal Plus 36
- Changing the programme position 32
- Clock setting 21
- Color system
  - compatible colour systems 2
  - setting 42
- Connecting
  - to a decoder 36
  - to a Set-Top Box 13, 14
  - to a stereo system 15
  - to the TV with a EURO-AV (Scart) connector 9
  - to the TV with an aerial cable only 12
- Counter 42

## D

- Disabling the programme positions 34
- Dubbing. *see* Editing

## E

- Editing 71
- EP mode 43
- EURO-AV connection 9

## H

- Hi-fi audio track 64

## I

- Index Search 65

## L

- Language selecting 25
- LP mode 45

## M

- Menu options 68
- Monitoring
  - during playback 64
  - during recording 64

## N

- NICAM broadcasts 63
- Normal audio track 64

## O

- OPC (Optimum Picture Control) 66

## P

- PAY-TV 36
- PDC (Programme Delivery Control) 51
- Picture adjustment. *See* Adjusting
- Playback 41
  - at various speeds 42, 56
  - selecting the sound 64
  - slow motion 56
- Power save 70
- Presetting channels 26

## R

- Recording 44
  - bilingual programmes 63
  - saving 46
  - using the ShowView system 48
  - what you are watching on the TV 47
  - while watching another programme 46
- Remote commander 5
- RF channel 16, 18
- RR (Reality Regenerator) 66

## S

- Safety tab 46
- Searching
  - at various speeds 56
  - using the index function 65
- Set-Top Box
  - connecting 13, 14
  - line through 13
- SMARTFILE
  - checking the contents of a tape 82

- demonstration 75
- erasing the data of an unwanted programme 96
- labelling a recorded programme and tape 84
- protecting a recorded programme 94
- recording 76
- registering the contents of a recorded tape in the SmartFile label 92
- selecting 81
- SmartFile label 4, 76
- SMARTLINK 11
  - Automatic Power Off 11
  - connection 9
  - NexTVView Download 11
  - One Touch Menu 11
  - One Touch Play 11, 43
  - One Touch Timer 11
  - Preset Download 11
  - TV Direct Rec 11, 47
- SP mode 45
- Station name
  - changing 30
  - setting 30
- Synchronized Recording 59

## T

- Timer recording 48, 53
  - overlapping timer recording 62
  - using the ShowView system 48
- Timer setting
  - cancelling 61
  - changing 61
  - checking 61
  - daily/weekly recording 51, 55
- Tracking adjustment. *See* Adjusting

## V

- VPS (Video Programme System) 51

## Z

- Zweiton broadcasts 63

---

Sony online

<http://www.world.sony.com/>