

Video Cassette Recorder

Operating Instructions



Hi-Fi

VIDEO*plus+*
DELUXE

SLV-SE850G

WARNING

To prevent fire or shock hazard, do not expose the unit to rain or moisture.

To avoid electrical shock, do not open the cabinet. Refer servicing to qualified personnel only.

Mains lead must only be changed at a qualified service shop.

Notice for customers in the United Kingdom

A moulded plug complying with BS1363 is fitted to this equipment for your safety and convenience. If the 13A fitted plug does not match the outlet socket in your home, please refer to your Appointed Sony Dealer for advice.

Should the fuse in the plug supplied need to be replaced, a 5 AMP fuse approved by ASTA or BSI to BS1362, (i.e., marked with ⚡ or ⚡ mark) must be used.

If the plug supplied with this equipment has a detachable fuse cover, be sure to attach the fuse cover after you change the fuse. Never use the plug without the fuse cover. If you should lose the fuse cover, please contact your nearest Sony service station.

Precautions

Safety

- This unit operates on 220 – 240 V AC, 50 Hz. Check that the unit's operating voltage is identical with your local power supply.
- If anything falls into the cabinet, unplug the unit and have it checked by qualified personnel before operating it any further.
- The unit is not disconnected from the mains as long as it is connected to the mains, even if the unit itself has been turned off.
- Unplug the unit from the wall outlet if you do not intend to use it for an extended period of time. To disconnect the cord, pull it out by the plug, never by the cord.

Installing

- Allow adequate air circulation to prevent internal heat buildup.
- Do not place the unit on surfaces (rugs, blankets, etc.) or near materials (curtains, draperies) that may block the ventilation slots.
- Do not install the unit near heat sources such as radiators or air ducts, or in a place subject to direct sunlight, excessive dust, mechanical vibration or shock.

- Do not install the unit in an inclined position. It is designed to be operated in a horizontal position only.
- Keep the unit and cassettes away from equipment with strong magnets, such as microwave ovens or large loudspeakers.
- Do not place heavy objects on the unit.
- If the unit is brought directly from a cold to a warm location, moisture may condense inside the VCR and cause damage to the video head and tape. When you first install the unit, or when you move it from a cold to a warm location, wait for about three hours before operating the unit.

Caution

Television programmes, films, video tapes and other materials may be copyrighted. Unauthorized recording of such material may be contrary to the provisions of the copyright laws. Also, use of this recorder with cable television transmission may require authorization from the cable television transmitter and/or programme owner.

Compatible colour systems

This VCR is designed to record using the PAL colour system and play back using the PAL and NTSC 4.43 colour systems. Recording of video sources based on other colour systems cannot be guaranteed.

VIDEO Plus + is a registered trademark of Gemstar Development Corporation. VIDEO Plus + system is manufactured under license from Gemstar Development Corporation.

Table of contents

Getting Started

- 4 Step 1 : Unpacking
- 5 Step 2 : Setting up the remote commander
- 9 Step 3 : Connecting the VCR
- 15 Step 4 : Tuning your TV to the VCR
- 18 Step 5 : Setting up the VCR with the Auto Set Up function
- 19 Step 6 : Setting the clock
- 23 Step 7 : Setting the Set-Top Box
- 30 Selecting a language
- 31 Presetting channels
- 34 Setting/changing the station names
- 36 Changing/disabling programme positions
- 40 Setting your personal code

Basic Operations

- 43 Playing a tape
- 46 Recording TV programmes
- 50 Recording TV programmes using the VIDEO Plus + system
- 55 Setting the timer manually

Additional Operations

- 58 Playing/searching at various speeds
- 60 Setting the recording duration time
- 61 Synchronized Recording
- 63 Checking/changing/cancelling timer settings
- 65 Recording stereo and bilingual programmes
- 67 Searching using the Smart Search function
- 70 Searching using the index function
- 71 Adjusting the picture
- 73 Changing menu options

Editing

- 76 Connecting to a VCR or stereo system

- 78 Basic Editing
- 79 Audio dubbing

Additional Information

- 81 Troubleshooting
- 86 Specifications
- 87 Index to parts and controls
- 92 Menu chart

Back cover

- Index

Step 1 : Unpacking

Check that you have received the following items with the VCR :

- Remote commander

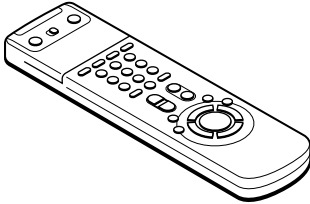

- Aerial cable

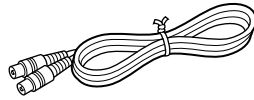

- R6 (size AA) batteries

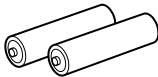

- Set-Top Box controller

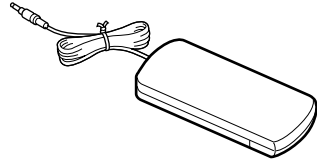

Step 2 : Setting up the remote commander

Inserting the batteries

Insert two R6 (size AA) batteries by matching the + and – on the batteries to the diagram inside the battery compartment.

Insert the negative (–) end first, then push in and down until the positive (+) end clicks into position.

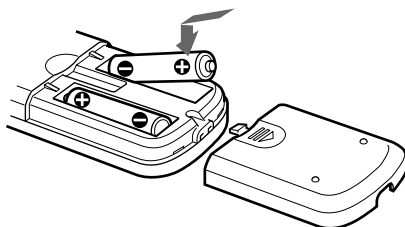

Using the remote commander

You can use this remote commander to operate this VCR and a Sony TV. Buttons on the remote commander marked with a dot (•) can be used to operate your Sony TV. If the TV does not have the  symbol near the remote sensor, this remote commander will not operate the TV.

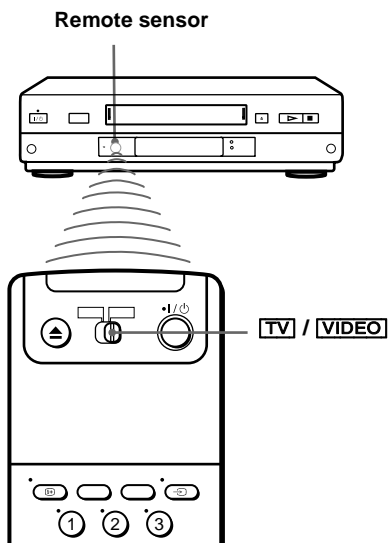

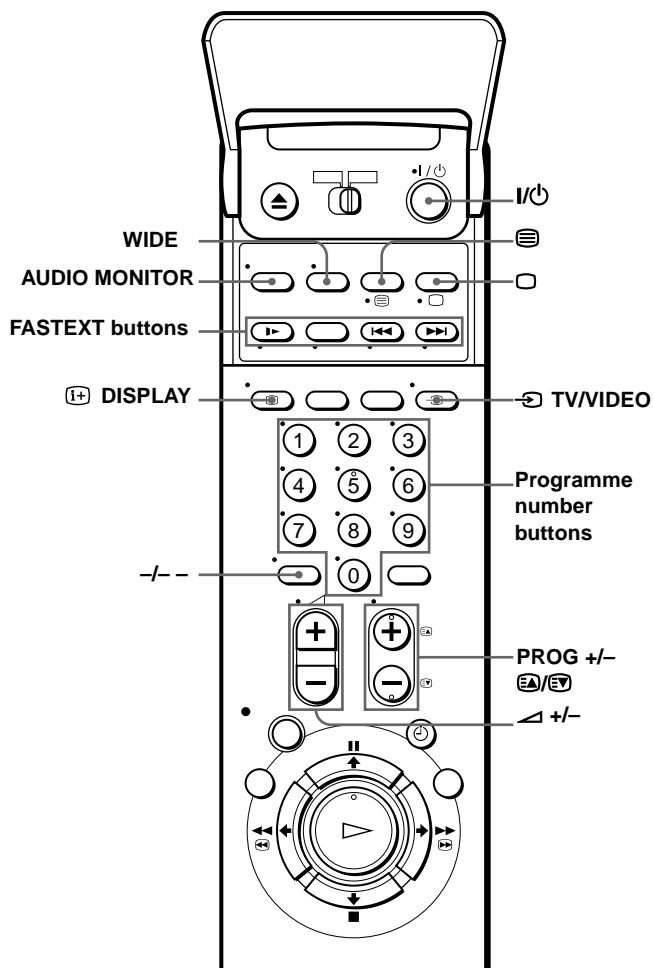

To operate	Set TV / VIDEO to
the VCR	VIDEO and point at the remote sensor on the VCR
a Sony TV	TV and point at the remote sensor on the TV

continued



TV control buttons

To	Press
Set the TV to standby mode	I/O
Select an input source: aerial in or line in	TV/VIDEO
Select the TV's programme position	Programme number buttons, -/-, PROG +/-
Adjust the TV's volume	△ +/-
Switch to TV (Teletext off)	□ (TV)
Switch to Teletext	☰ (Teletext)

To	Press
Select the sound	AUDIO MONITOR
Use FASTEXT	FASTEXT buttons
Call up the on-screen display	 DISPLAY
Change the Teletext page	 
Switch to/from wide mode of a Sony wide TV (For other manufactures' wide TVs, see "Controlling other TVs with the remote commander".)	WIDE



Notes

- With normal use, the batteries should last about three to six months.
- If you do not use the remote commander for an extended period of time, remove the batteries to avoid possible damage from battery leakage.
- Do not use a new battery with an old one together.
- Do not use different types of batteries together.
- Some buttons may not work with certain Sony TVs.









Controlling other TVs with the remote commander

The remote commander is preprogrammed to control non-Sony TVs. If your TV is listed in the table below, set the appropriate manufacturer's code number.

1 Set TV/VIDEO at the top of the remote commander to TV.

2 Hold down , and enter your TV's code number(s) using the programme number buttons. Then release .

Now you can use the following TV control buttons to control your TV:

, TV/VIDEO, programme number buttons, -- (ten's digit), PROG +/-,  +/-,  (TV),  (Teletext), FASTEXT buttons, WIDE*, MENU*, */*/*/*, and OK*.

* These buttons may not work with all TVs.

Tip

- When you set your TV's code number correctly while the TV is turned on, the TV turns off automatically.

continued

Code numbers of controllable TVs

If more than one code number is listed, try entering them one at a time until you find the one that works with your TV.

To switch to wide mode, see the footnotes below this table for the applicable code numbers.

Manufacturer	Code number
Sony	01 ^{*1} , 02
Akai	68
Blaupunkt	10
C.G.M	09
Ferguson	52
Goldstar	03, 04, 17
Grundig	10 ^{*1} , 11 ^{*1}
Hitachi	24
ITT	15, 16, 69 ^{*3}
JVC	33
Loewe	45
Mivar	09
NEC	66

Manufacturer	Code number
Nokia	15, 16, 69 ^{*3}
Panasonic	17 ^{*1} , 49
Philips	06 ^{*1} , 07 ^{*1} , 08 ^{*1}
Saba	12, 13
Samsung	22, 23
Sanyo	25
Sharp	29
Telefunken	36
Thomson	43 ^{*2}
Toshiba	38

^{*1} Press WIDE to switch to the wide picture mode you want.

^{*2} Press WIDE, then press \triangle +/- to select the wide picture mode you want.

^{*3} Press WIDE. The menu appears on the TV screen. Then, press $\uparrow/\downarrow/\leftarrow/\rightarrow$ to select the wide picture you want and press OK.

Notes

- If the TV uses a different remote control system from the one programmed to work with the VCR, you cannot control your TV with the remote commander.
- If you enter a new code number, the code number previously entered will be erased.
- If you remove the batteries of the remote commander for more than a few minutes, the code number may be reset to 01 (Sony). In this case, reset the appropriate code number.

Step 3 : Connecting the VCR

We recommend connecting your VCR to your TV using a Scart (EURO-AV) cable. You must still connect your VCR to your TV with an aerial cable as well.

If you use the Scart (EURO-AV) cable for connecting, you will improve the picture and sound quality playback of your VCR and make the set up easier.

- Connection to your TV with an aerial cable only, see page 12.
- Connection to your TV and Set-Top Box, see page 13.

Connection to your TV with a Scart (EURO-AV) connector

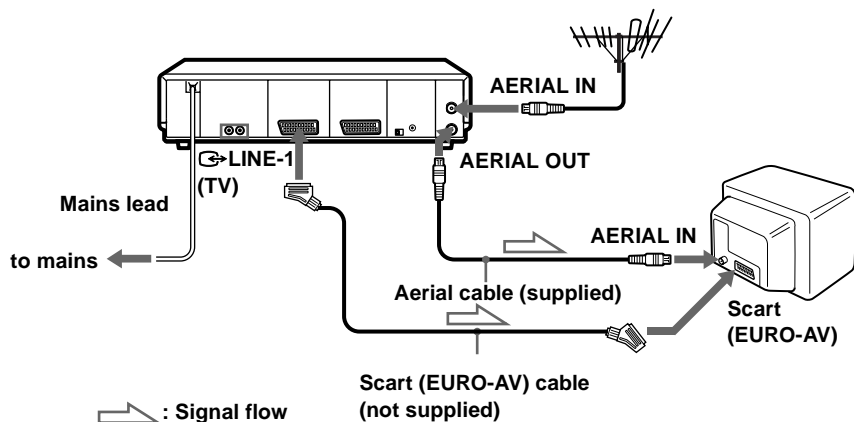

- 1 Disconnect the aerial cable from your TV and connect it to AERIAL IN on the rear panel of the VCR.

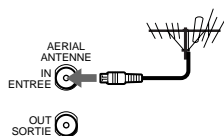

- 2 Connect AERIAL OUT of the VCR and the aerial input of your TV using the supplied aerial cable.

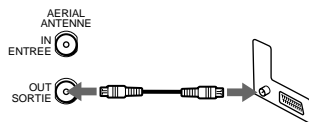

continued

3

Connect LINE-1 (TV) on the VCR and the Scart (EURO-AV) connector on the TV with the optional EURO-AV cable.

This connection improves picture and sound quality. Whenever you want to watch the VCR picture, press  TV/VIDEO to display the VIDEO indicator in the display window.

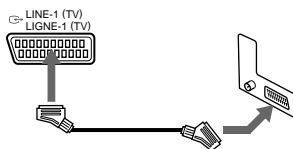

4

Connect the mains lead to the mains.

You can now tune your TV to the VCR (see page 15).

Notes

- If the TV is connected to the LINE-1 (TV) connector, setting the RF channel to OFF is recommended (see page 17). In the OFF position, only the signal from the aerial is output through the AERIAL OUT connector.
- For a correct SmartLink connection, you will need a Scart cable which the 21 pins are completely connected (for example a Sony cable reference VMC-2121HG). Please refer to your TV's instruction manual as well for this connection.

About the SMARTLINK features

If the connected TV complies with SMARTLINK, NexTView Link, MEGALOGIC^{*1}, EASYLINK/CinemaLink^{*2}, Q-Link^{*3} or T-V LINK^{*4}, you can use the

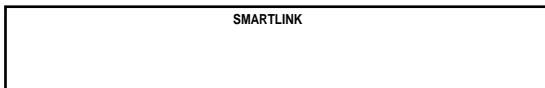

SMARTLINK function after you complete the steps on the previous page (the SMARTLINK indicator appears in the VCR's display window when you turn on the TV). You can enjoy the following SMARTLINK features.

- **Preset Download**
You can download your TV tuner preset data to this VCR and tune the VCR according to that data in Auto Set Up. This greatly simplifies the Auto Set Up procedure. Be careful not to disconnect the cables or exit the Auto Set Up function during the procedure. See "Setting up the VCR with the Auto Set Up function" on page 18.
- **TV Direct Rec**
You can easily record what you are watching on the TV (other than tapes being played on this VCR). For details, see "Recording what you are watching on the TV (TV Direct Rec)" on page 49.
- **One Touch Play**
With One Touch Play, you can start playback automatically without turning on the TV. For details, see "Starting playback automatically with one button (One Touch Play)" on page 45.
- **One Touch Menu**
You can turn on the VCR and TV, set the TV to the video channel, and display the VCR's on-screen display automatically by pressing MENU on the remote commander.
- **One Touch Timer**
You can turn on the VCR and TV, set the TV to the video channel, and display the timer recording menu (the TIMER METHOD menu, the TIMER menu or the VIDEO Plus + menu) automatically by pressing  TIMER on the remote commander. You can set which timer recording menu is displayed using TIMER OPTIONS in the OTHER OPTIONS menu (see page 75).
- **Automatic Power off**
You can have the VCR turn off automatically, if the VCR is not used for about 1 minute, after you turn off the TV.
- **NexTView Download**
You can easily set the timer by using the NexTView Download function on your TV. Please refer to your TV's instruction manual.

^{*1} "MEGALOGIC" is a registered trademark of Grundig Corporation.

^{*2} "EASYLINK/CinemaLink" is a trademark of Philips Corporation.

^{*3} "Q-Link" is a trademark of Panasonic Corporation.

^{*4} "T-V LINK" is a trademark of JVC Corporation.

Note

- Not all TVs respond to the functions above.

continued

Connection to your TV with an aerial cable only

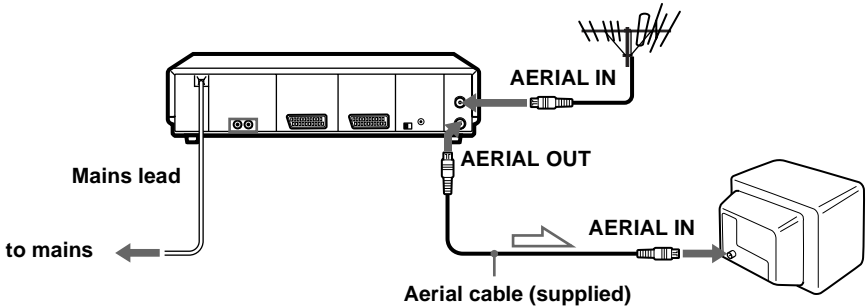

: Signal flow

1

Disconnect the aerial cable from your TV and connect it to AERIAL IN on the rear panel of the VCR.

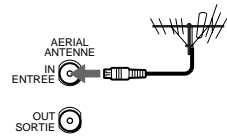

2

Connect AERIAL OUT of the VCR and the aerial input of your TV using the supplied aerial cable.

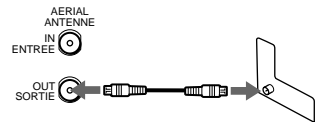

3

Connect the mains lead to the mains.

You can now tune your TV to the VCR (see page 15).

If your STB does not have a Scart (EURO-AV) connector

Set the STB CONNECTION setting to RF (see page 23).

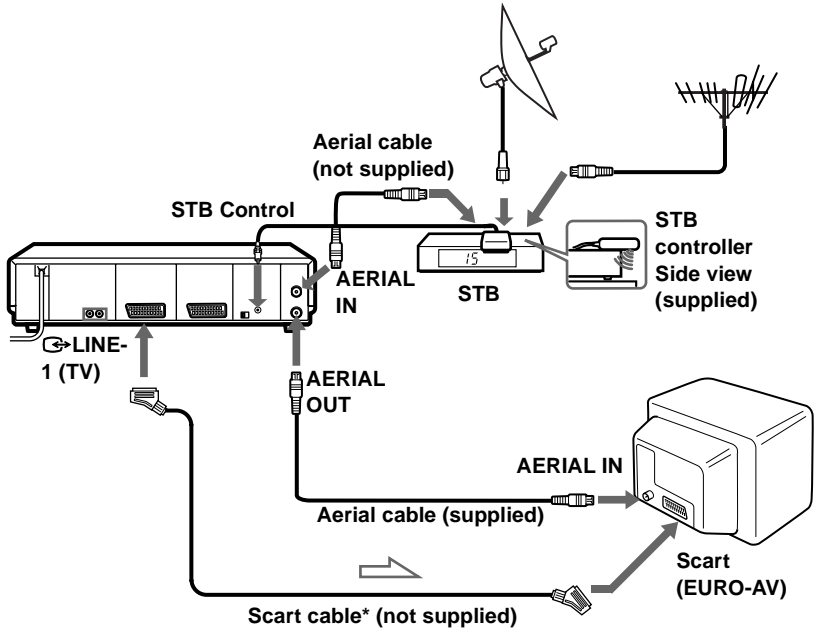

 : Signal flow

* If your TV doesn't have a Scart (EURO-AV) connector, the Scart cable connected to the VCR is not required.

Additional connections

To a stereo system

You can improve sound quality by connecting a stereo system to the AUDIO OUT R/L jacks as shown on the right.

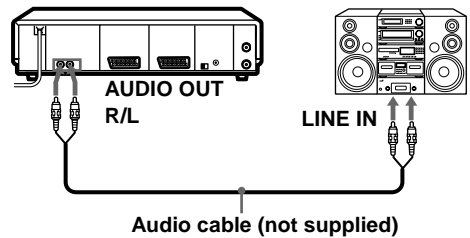

Step 4 : Tuning your TV to the VCR

If you have connected your VCR to the TV with an aerial cable only

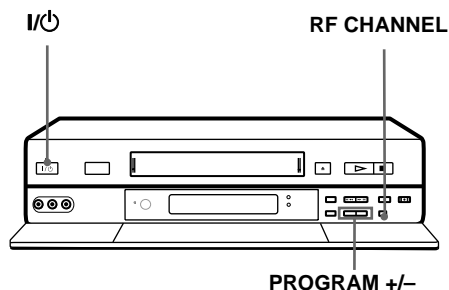

- 1** Turn on your TV and press I/⏻ (on/standby) to turn on the VCR.
Pull down the drop down panel.

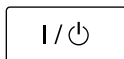

- 2** Press briefly RF CHANNEL on the VCR.
The factory-preset RF (Radio Frequency) channel appears in the display window..

AUTO SET UP
RF CHANNEL

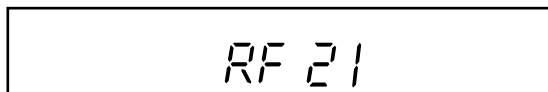

- 3** Turn on your TV and select an unused programme position for the VCR picture (for ex. programme position "0").
This programme position will be referred to as the video channel (for watching your VCR on the TV) after tuning is completed.

continued

4

Tune in the programme position you have selected (for ex. programme position "0") until the picture shown on the right appears clearly on the TV screen (background must be green).

Refer to your TV manual for tuning instructions.

If the picture does not appear clearly, see "To obtain a clear picture from the VCR" below.

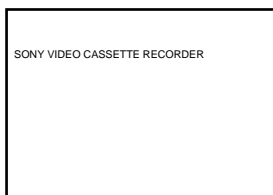

5

AUTO SET UP



RF CHANNEL

Press RF CHANNEL.

You have now tuned your TV to the VCR. From now on, whenever you want to play a tape, set the TV to the video channel (for ex. programme position "0").

You can now set your VCR with the Auto Set Up function (see page 18).

To check if the TV tuning is correct

Set the TV to the video channel (for ex. programme position "0") and press PROGRAM +/- on the VCR. If the TV screen changes to a different programme each time you press PROGRAM +/-, the TV tuning is correct.

To obtain a clear picture from the VCR

If the screen does not appear clearly in step 5 above, press PROGRAM +/-, so that another RF channel appears. Then tune the TV to the new RF channel until a clear picture appears.

If you have connected your VCR to the TV with a Scart (EURO-AV) connector and an aerial cable as well

In order to avoid any interferences with existing broadcasts, we recommend you to set RF channel to the OFF position.

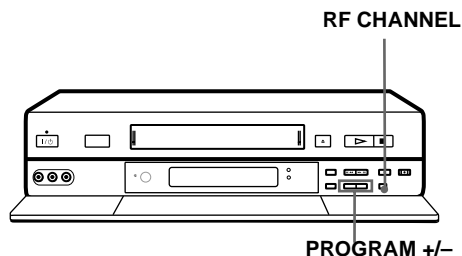

- 1** Turn on your TV and press I/⏻ (on/standby) to turn on the VCR.
Pull down the drop down panel.

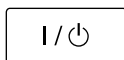

- 2** Press briefly RF CHANNEL on the VCR.
The factory-preset RF (Radio Frequency) channel appears in the display window.

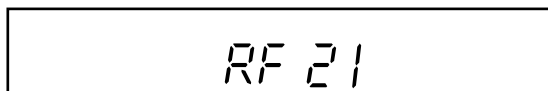
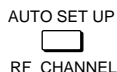

- 3** Press PROGRAM +/- until the OFF indication appears in the display window. The RF channel is then switched off.

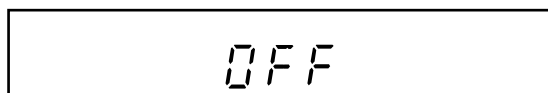
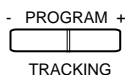

The picture shown below appears clearly on the TV screen (background must be green).



- 4** Press RF CHANNEL again.
You can now set your VCR with the Auto Set Up function (see page 18).

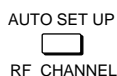

Note

- If in step 3 the green screen does not appear, select the "AV/EXTERNAL" source on your TV (please refer to your TV instruction manual).

Step 5 : Setting up the VCR with the Auto Set Up function

Before using the VCR for the first time, set up the VCR using the Auto Set Up function. With this function, you can set the language for the on-screen display, TV channels, guide channels for the VIDEO Plus + system, and VCR clock automatically.

Before you start ...

- Turn on the set -top box if it is connected to the VCR only by the aerial cable and not to the Scart cable.

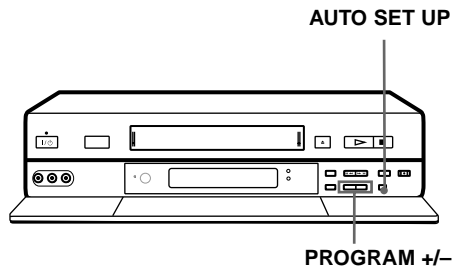

-
- AUTO SET UP** Hold down AUTO SET UP on the VCR for more than 3 seconds.
- RF CHANNEL** The VCR automatically turns on, and starts searching for all of the receivable channels and presets them in the appropriate order for your local area.



If you use the SMARTLINK connection, the Preset Download function starts and the SMARTLINK indicator flashes in the display window during download.

After the search or download is complete, the current time appears in the display window for any stations that transmit a time signal.

To cancel the Auto Set Up function

Press AUTO SET UP.

Notes

- Do not cancel the Auto Set Up function during step 3. If you do, repeat Auto Set Up from the beginning.
- When you operate the Auto Set Up function, some of the settings (VIDEO Plus +, timer etc...) will be reset. In this case, you have to set them again.

Step 6 : Setting the clock

You must set the time and date on the VCR to use the timer recording features properly. If the VCR clock was not set in the Auto Set Up procedure, you need to set it manually.

The Auto Clock Set function works only if a station in your area is broadcasting a time signal. If the Auto Set Up function did not set the clock correctly for your local area, try another station for the Auto Clock Set function.

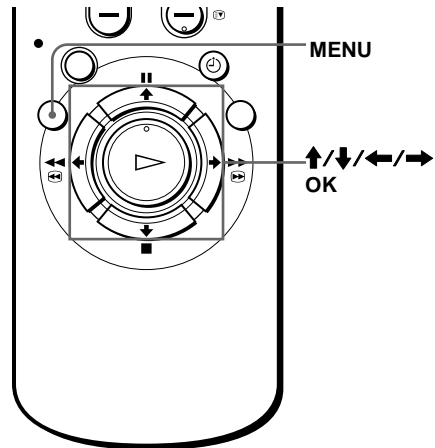

Setting the clock manually

Before you start...

- Turn on the VCR and the TV.
- Set the TV to the video channel.

1

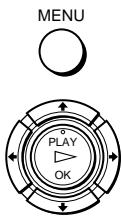

Press MENU, then press **↑/↓** to highlight SETTINGS and press OK.

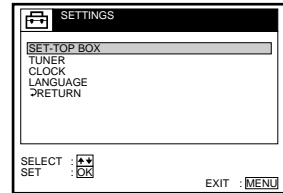

2



Press **↑/↓** to highlight CLOCK, then press OK.

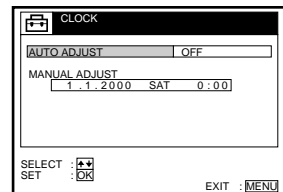

continued

3



Press **↑/↓** to highlight MANUAL ADJUST, then press OK.

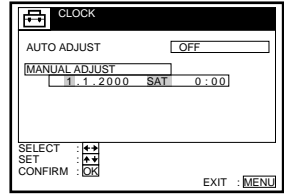

4



Press **↑/↓** to set the date.

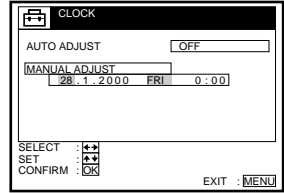

5



Press **→** to highlight the month and set the month pressing **↑/↓**.

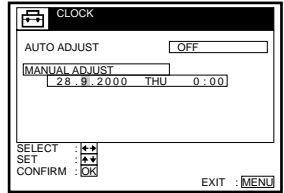

6



Set the year, hour, and minutes in sequence, pressing **→** to highlight the item to be set, and press **↑/↓** to select the digits.

The day of the week is set automatically.

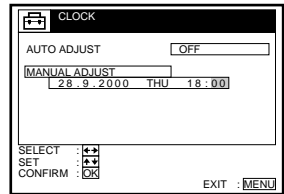

7



Press OK to confirm the setting and start the clock.

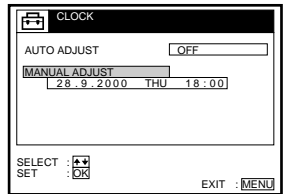

8



Press MENU to exit the menu.

Tip

- To change the digits while setting, press **←** to return to the item to be changed, and select the digits pressing **↑/↓**.

Note

- The menu disappears automatically if you don't proceed for more than a few minutes.

Changing the station for the Auto Clock Set function

Before you start...

- Turn on the VCR and the TV.
- Set the TV to the video channel.

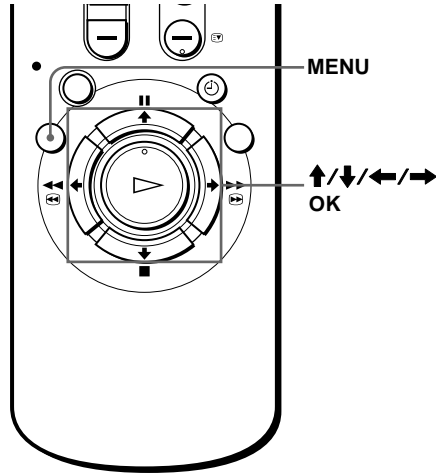

Getting Started

1

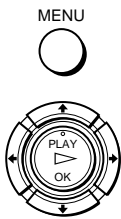

Press MENU, then press **↑/↓** to highlight SETTINGS and press OK.

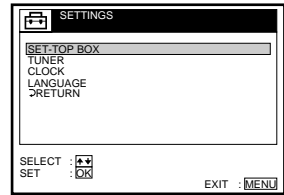

2



Press **↑/↓** to highlight CLOCK, then press OK.
AUTO ADJUST is highlighted.

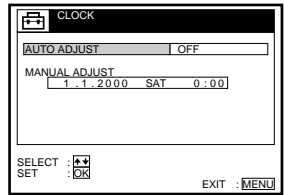

3



Press OK.

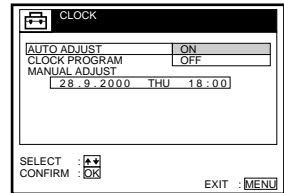

continued

4



Press **↑/↓** to highlight ON, then press OK.

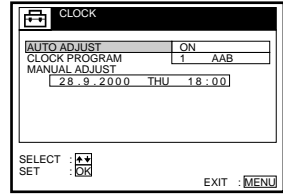

5



Press **↓** to highlight CLOCK PROGRAM, then press OK.

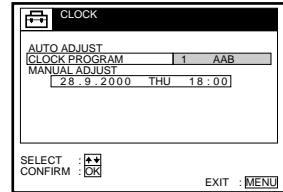

6



Press **↑/↓** until the programme position of the station that carries the time signal appears.

If the VCR does not receive the time signal from any station, AUTO ADJUST returns to OFF automatically.

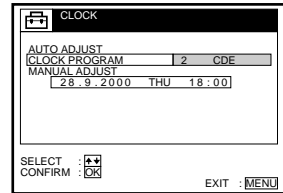

7

MENU



Press MENU to exit the menu.

Tips

- To change the digits while setting, press **←** to return to the item to be changed, and select the digits using **↑/↓**.
- If you set AUTO ADJUST to ON, the Auto Clock Set function is activated whenever the VCR is turned off. The time is adjusted automatically by making reference to the time signal from the station whose programme position is displayed in the "CLOCK PROGRAM" row. If you do not need the Auto Clock Set function, select OFF.

Note

- The menu disappears automatically if you don't proceed for more than a few minutes.

Step 7 : Setting the Set-Top Box

If you did not connect a Set-Top Box (STB), skip this step.

Before you start...

- Turn on the VCR and the TV.
- Set the TV to the video channel.
- Connect the STB controller, remove the protection sticker on the STB controller and place it on top of the STB, so that it hangs out over the infrared receptor on the front of the STB (see page 13).

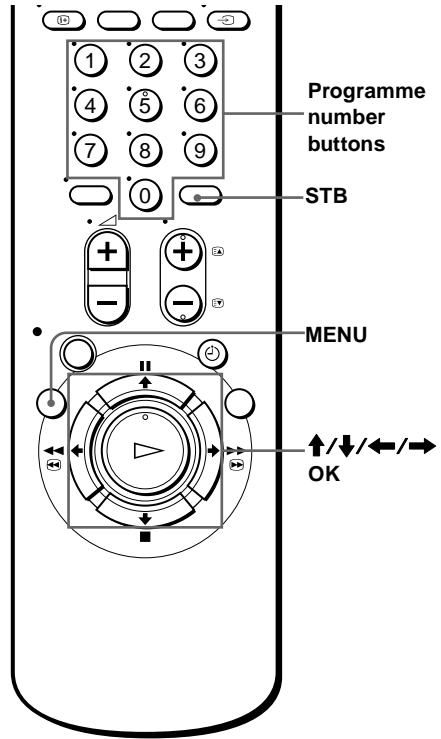

1

MENU

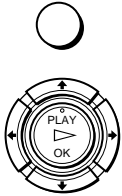

Press MENU, then press \uparrow/\downarrow to highlight SETTINGS and press OK.

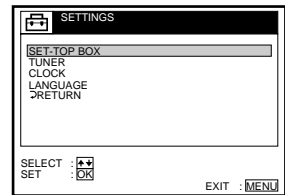

2



Press \uparrow/\downarrow to highlight SET-TOP BOX, then press OK.

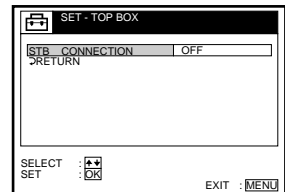

continued

3



Press **↑/↓/←/→** to highlight STB CONNECTION and press OK.

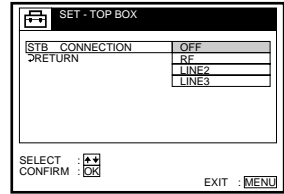

4



• If you connect the STB using the aerial cable :

Press **↑/↓/←/→** to select RF and press OK.

Press **↑/↓/←/→** to highlight PROGRAMME NO. and press OK. Enter the appropriate number using **↑/↓** and press OK.

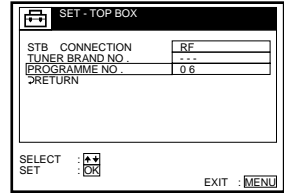

• If you connect the STB using the Scart (EURO-AV) cable :

Press **↑/↓/←/→** to select LINE-3 and press OK.

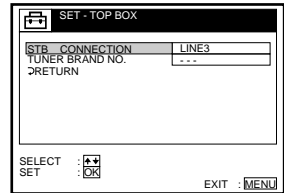

5

MENU



Press **↑/↓/←/→** to highlight TUNER BRAND NO. and press OK. Enter the appropriate number using the programme number buttons. Refer to the table on the next page. Press OK.



Press MENU to exit the menu.

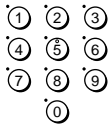
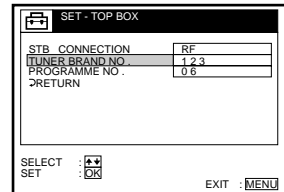

Notes

- If your VCR is connected to the STB by the aerial cable, enter the programme number of the VCR corresponding to the channel where you have set up the STB output in step 4.
- It is recommended to connect your STB to the LINE-3 connector.
- For some STB, in order to avoid any conflict between the STB controller and the VCR remote commander, be careful not to point the remote commander towards the STB and the VCR at the same time.
- You cannot watch programmes from your STB on the TV while recording unless you record a programme from your STB.

Set-Top Box brand number

To control the STB, enter the appropriate number corresponding to your STB brand.

Some STBs may not operate at all with this VCR.

STB brand	Code numbers
ABC	025, 028
ABsat	134, 843
Akai	526
Alba	102, 265, 373, 432, 466, 526, 624
Allantide	344
Amstrad	091, 224, 263, 349, 472, 520, 686, 700
Andover	555
Ankaro	228, 231, 380, 530
Anttron	194, 432
Arcon	283, 379
Armstrong	254
Asat	384
AST	332, 361, 362
Astra	119, 384, 529
Astro	184, 369, 531, 559, 595
Audio Ton	375
Avalon	407
Axis	377, 380
Birmingham Cable Communications	287
British Telecom	014, 116
Barcom	228
Best	228, 380
Blaupunkt	184
Boca	254, 524, 840
Brain Wave	343
British Sky Broadcasting	858, 013, 012
Brunor	420

STB brand	Code numbers
Bush	078, 102, 265
BT	526, 679, 721
Cabletime	172, 282, 388, 459
Cambridge	267, 355, 526
Camundosat	104
Canal+	864
Canal Satellite	864
Channel Master	373
CityCom	829
Clyde	097
CME	091, 119, 184, 211
CNT	531
Comtec	277
Connexions	104, 407, 469
Conrad	618
Contec	377
Cryptovision	611
Crown	254
Cyrus	211
Daewoo	384
D-box	734
DDC	373

continued

STB brand	Code numbers
Diskxpress	228
DNT	211, 407, 469
Drake	279, 470
Dynasat	690
Echostar	181, 407, 465
EEC	344
EIF	428, 685
Einhell	344
Elta	375
Emanon	432
Emme Esse	708
Engel	461
Eurodec	535, 537
Europa	708
Ferguson	078, 194, 347, 625, 722
Fidelity	263, 686
Finlux	119, 355, 408, 425, 466, 525
Fraba Sat	596
Fracarro	060
France Telecom	462
Freecom	346, 432, 745
FTE	277, 342, 422
Fuba	183, 228, 308, 309, 380, 407, 425, 428, 432, 720
Galaxis	375, 377, 844, 845
Galaxisat	332
GEC	097
Gold Box	864
Goldstar	346
Gooding	582
Grothusen	346

STB brand	Code numbers
Grundig	151, 184, 339, 474, 582, 761, 540
G-Sat	194
Harting und Helling	344
Hinari	194
Hirschmann	184, 344, 407, 408, 409, 513, 584, 592, 683, 764
Hitachi	466
Houston	679
Humax	059
Huth	231, 254, 375, 528, 600, 805
HyperVision	630
Ikusi Allsat	379
Imperial	265, 496
IRTE	620
ITS	632
ITT	119, 183
Jerrold	014, 025, 287
Johansson	343
JOK	721
JSR	375
JVC	526, 582
Kathrein	103, 134, 184, 211, 342, 369, 453, 491, 515, 564, 592, 633, 636
Key West	805
König	103, 183, 184
Kosmos	342, 346
Kreiselmeier	184
Kyostar	432
La Sat	435, 475, 524, 531, 618
Lasat	833

STB brand	Code numbers
Lenco	346, 384, 422, 432, 461
Lion	364
Lupus	380
Luxor	119, 183, 584
Macab	535, 597
Magnavox	043
Manhattan	466, 531
Maranz	211
Maspro	103, 339, 347, 761
Matsui	355, 582
MediaSat	864
Mediamarkt	254
Memphis	377
Micro Technology	344
Minerva	582
Mintec	589
MNet	030
Morgan's	254, 524, 840
Multistar	342, 475
Muratto	346
Navex	343
NEC	189
Neusat	703, 845
Newhaus	231
Next-Wave	743
Nikko	371
Nokia	034, 692, 119, 183, 339, 408, 425, 466, 584, 734, 832
Nordmende	283, 373, 625
Oceanic	597
Orbit	361, 362

STB brand	Code numbers
Orbitec	596
Oxford	355
Pace	078, 194, 339, 347, 466, 802, 806, 858
Pal	848
Palcom	308, 309
Palladium	582
Panasonic	225
Panda	466
Philips	630, 144, 211, 339, 466, 474, 582, 721, 761, 864
Phoenix	377
Phonotrend	799
Pioneer	155, 271, 544, 864
ProVision	595
Promax	466
Prosat	496
PTT Telecom	224
PVP Stereo Visual Matrix	014
Pyxis	842
Quadral	373, 530, 639
Radiola	211
Radix	407, 893, 764
RFT	211, 231, 552
Saba	265, 347, 364, 531, 586, 701, 720, 745
Sabre	466
Sagem	831
Sakura	377
Salora	119, 183, 210
Samsung	283
SAT	332, 361, 362, 472
Satbox	386

continued

STB brand	Code numbers
Satcom	224
Satec	194, 339
Satmaster	283
SatPartner	343, 346, 432, 513, 531, 703, 720, 745
Schwaiger	194, 515
Scientific Atlanta	019, 028, 288
Seemann	407, 589, 637
SEG	380, 432, 529, 753
Siemens	184
Skymaster	530, 639
Sony	286, 289, 293, 650, 715
Stella	104
STVI	428
STS	167
Sunstar	524, 805
Tandberg	742
Tantec	308, 309, 347, 466
Tatung	156
TechniSat	272, 273, 331, 420, 469, 552, 559, 596
Teco	384
Telecom	104
Telefunken	432
Teleka	254, 624, 683
Telemax	435
Teleservice	292
Televés	596
Tensai	632
Thomson	466, 864
Thorens	597

STB brand	Code numbers
Tonna	679
TPS	831
Triad	332, 344, 346, 361, 362
Triasat	425
Tristar	277
Tudi	297
Uniden	205, 803, 842
Unisat	377
United Cable	014
Unitor	228, 343
Universum	184, 525, 582
Vector	344, 364, 529
Ventana	211
Videoway	261
VisiCable+	492
Vortec	432
VTech	332, 473, 771
Vtech	362, 701
Westminster	116
Wevasat	344
Winersat	343
Wisi	184, 332, 362, 383, 407, 417, 418, 426, 466, 647, 649, 701
Wolsey Gene	555
XSat	134, 900
Xcom Multimedia	900
Zehnder	332, 342, 531, 829
Zenith	011, 536
Zwergnase	805

Note

- To check if the brand number is entered correctly or not, press STB repeatedly to display "STB" in the display window then enter a three digit number with the programme number buttons. If the STB responds, you have entered the correct brand number.

Selecting a language

If you prefer an on-screen language other than English, use the on screen display to select another language.

Before you start...

- Turn on the VCR and the TV.
- Set the TV to the video channel.

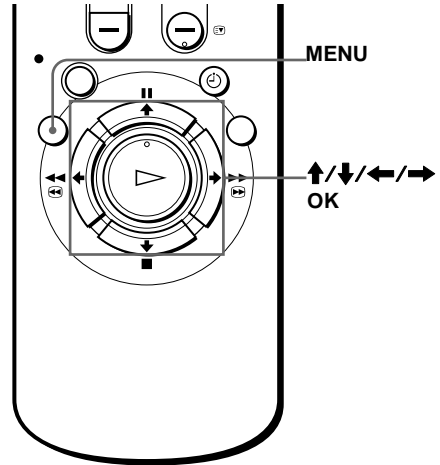

- 1** Press MENU, then press \uparrow/\downarrow to highlight SETTINGS and press OK.

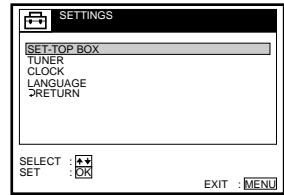
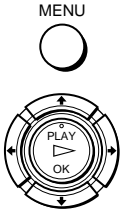

- 2** Press \uparrow/\downarrow to highlight LANGUAGE, then press OK.

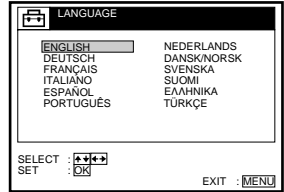

- 3** Press $\uparrow/\downarrow/\leftarrow/\rightarrow$ to highlight the desired language, then press OK.



Note

- The menu disappears automatically if you don't proceed for more than a few minutes.

Presetting channels

If some channels could not be preset using the Auto Set Up function, you can preset them manually.

Before you start...

- Turn on the VCR and the TV.
- Set the TV to the video channel.

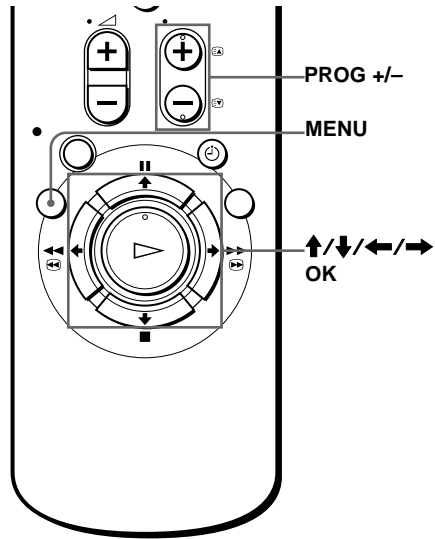

1

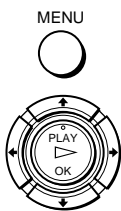

Press MENU, then press **↑/↓** to highlight SETTINGS and press OK.

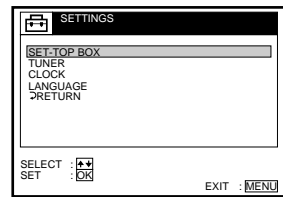

2



Press **↑/↓** to highlight TUNER, then press OK.

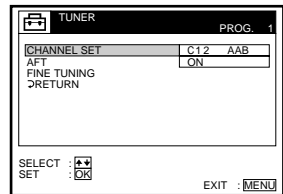

3



Press **↑/↓** to highlight CHANNEL SET.

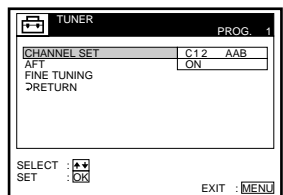

continued

4



Press PROG +/- to select the programme position.

Selected programme position

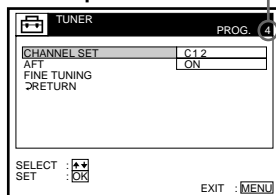

5



Press OK to highlight the channel number row, then press **↑/↓** to start tuning.

The VCR starts searching for a channel and displays the first one it finds on the TV screen. Press **↑/↓** repeatedly until the channel you want is displayed.

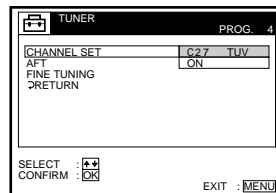

The channels are scanned in the following order:

- UHF B21 - B69

If you know the number of the channel you want, press the programme number buttons. For example, for channel 05, first press “0” and then press “5.”

6



Press OK.

7

To allocate another channel to another programme position, repeat steps 4 and 5.

8



Press MENU to exit the menu.

Disabling unwanted programme positions

After tuning the TV channels, you can disable unused programme positions. The disabled positions will be skipped later when you press the PROG +/- buttons. You can also disable unwanted programme positions using the CHANNEL LIST menu (see page 36).

- 1 In step 5 above, press programme number button “0” twice to display the number “00” beside CHANNEL SET.
- 2 Press OK to confirm the setting, then MENU to exit the menu.

If the picture is not clear

Normally, the Auto Fine Tuning (AFT) function automatically tunes in channels clearly. If, the picture is not clear, you may also use the manual tuning function.

- 1 Press PROG +/- or the programme number buttons to select the programme position for which you cannot obtain a clear picture.
- 2 Press MENU, then select SETTINGS and press OK.
- 3 Select TUNER, then press OK.
- 4 Select FINE TUNING.

The fine tuning meter appears.

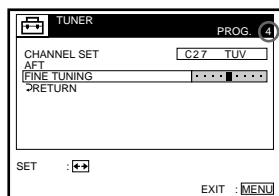

Selected programme position

- 5 Press ←/→ to get a clearer picture, then press MENU to exit the menu. Note that the AFT (Auto Fine Tuning) setting switches to OFF.

Tip

- If you want to return to the previous menu, highlight RETURN and press OK.

Note

- The menu disappears automatically if you don't proceed for more than a few minutes.

Setting/changing the station names

You can also set and change station names as you like (up to 5 characters). The set station names are displayed on the TV screen when you change the programme position on the VCR.

Before you start...

- Turn on the VCR and the TV.
- Set the TV to the video channel.

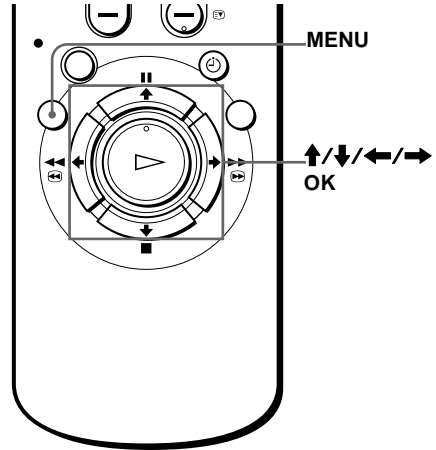

- 1** Press MENU, then press \uparrow/\downarrow to highlight LISTS and press OK.

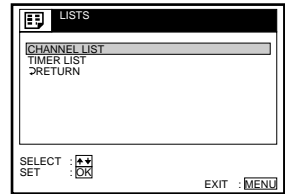
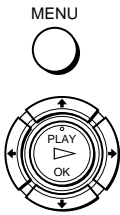

- 2** Press \uparrow/\downarrow to highlight CHANNEL LIST, then press OK.

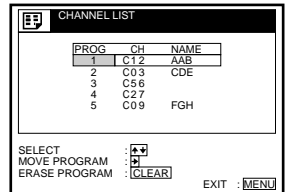

- 3** Press \uparrow/\downarrow to highlight the row on which you want to set or change the station name.



To display other pages for programme positions 6 to 60, press \uparrow/\downarrow repeatedly.

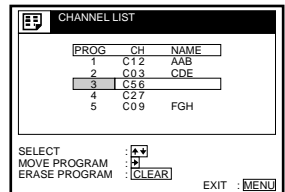

4



- If you want to set the station name, press **→** twice to highlight the station name column only.
- If you don't want to set the station name, go to step 7.

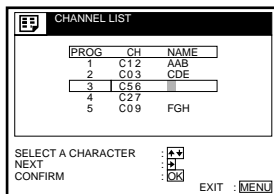

5



Enter the station name.

- 1 Press **↑/↓** to select a character. Each time you press **↑**, the character changes as shown below.
A → B → ... → Z → a → b → ... → z → 0 → 1 → ... → 9 → (symbols) → (blank space) → A

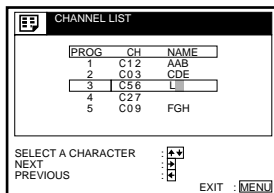

- 2 Press **→** to set the next character. The next space is highlighted. To correct a character, press **←** until the character you want to correct is highlighted, then reset it.

You can set up to 5 characters for the station name.

6

To change or to set the station name of another station, repeat steps 2 to 4.

7



Press **OK** to confirm the setting.

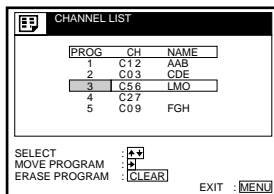

8

MENU



Press **MENU** to exit the menu.

Note

- The menu disappears automatically if you don't proceed for more than a few minutes.

Changing/disabling programme positions

After setting the channels, you can change the programme positions as you like. If any programme positions are unused or contain unwanted channels, you can disable them.

Before you start...

- Turn on the VCR and the TV.
- Set the TV to the video channel.

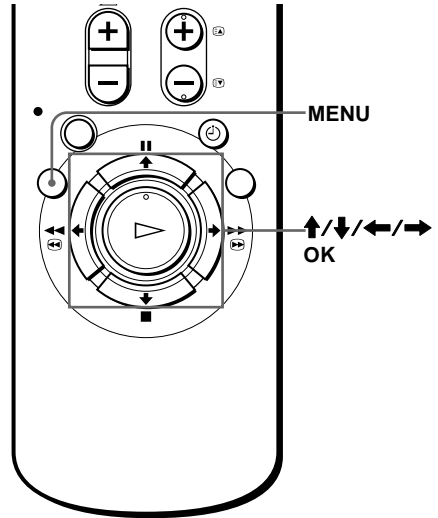

Changing programme positions

- 1** Press MENU, then press **↑/↓** to highlight **LISTS** and press OK.

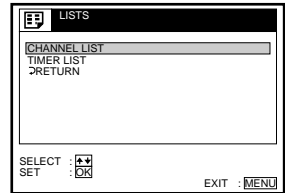
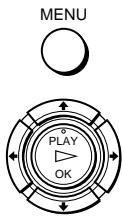

- 2** Press **↑/↓** to highlight **CHANNEL LIST**, then press OK.

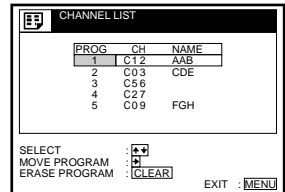
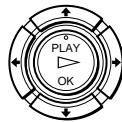

3



Press **↑/↓** to highlight the row on which you want to change the programme position, then press **→**.

To display other pages for programme positions 6 to 60, press **↑/↓** repeatedly.

CHANNEL LIST		
PROG	CH	NAME
1	C12	AAB
2	C03	CDE
3	C56	LMO
4	C27	FGH
5	C09	FGH

SELECT : **↑/↓**
 SET STATION NAME : **→**
 CONFIRM : **OK** EXIT : **MENU**

4



Press **↑/↓** until the selected channel row moves to the desired programme position.

The selected channel is inserted at the new programme position and the intermediate channels are displaced to fill the gap.

CHANNEL LIST		
PROG	CH	NAME
1	C56	LMO
2	C12	AAB
3	C03	CDE
4	C27	FGH
5	C09	FGH

SELECT : **↑/↓**
 SET STATION NAME : **→**
 CONFIRM : **OK** EXIT : **MENU**

5



Press **OK** to confirm the setting.

6

To change the programme position of another station, repeat steps 3 to 5.

7



Press **MENU** to exit the menu.

continued

Disabling unwanted programme positions

After presetting channels, you can disable unused programme positions. The disabled positions will be skipped later when you press the PROG +/- buttons.

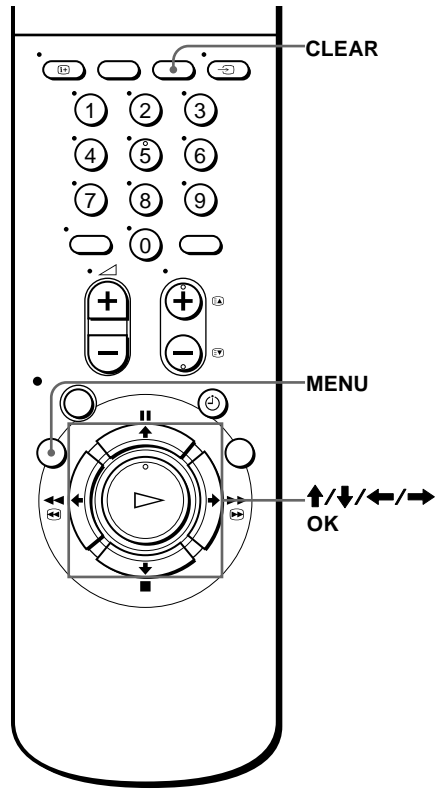

1

MENU



Press MENU, then press \uparrow/\downarrow to highlight LISTS, and press OK.

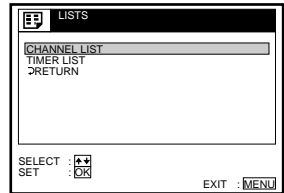

2



Press \uparrow/\downarrow to highlight CHANNEL LIST, then press OK.

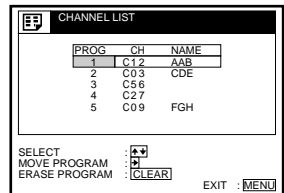

3



Press **↑/↓** to highlight the row which you want to disable.

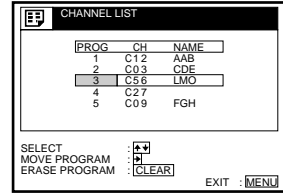

4



Press **CLEAR**.

The selected row will be cleared as shown on the right.

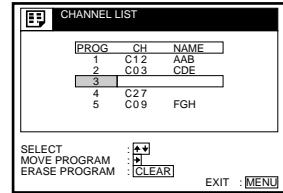

5

Repeat steps 3 and 4 for any other programme positions you want to disable.

6



Press **MENU** to exit the menu.

Notes

- The menu disappears automatically if you don't proceed for more than a few minutes.
- Be sure to select the programme position you want to disable correctly. If you disable a programme position by mistake, you need to reset that channel manually.

Setting your personal code

This VCR is equipped with a security function that assures quick identification of your set in case of a robbery. Just enter the Personal Code to personalize your set. Once you enter your personal code, you can check it any time but can never change it.

Before you start...

- Turn on your TV and set it to the video channel.
- Remove the tape in the VCR if there is one inserted.
- Turn off the VCR.

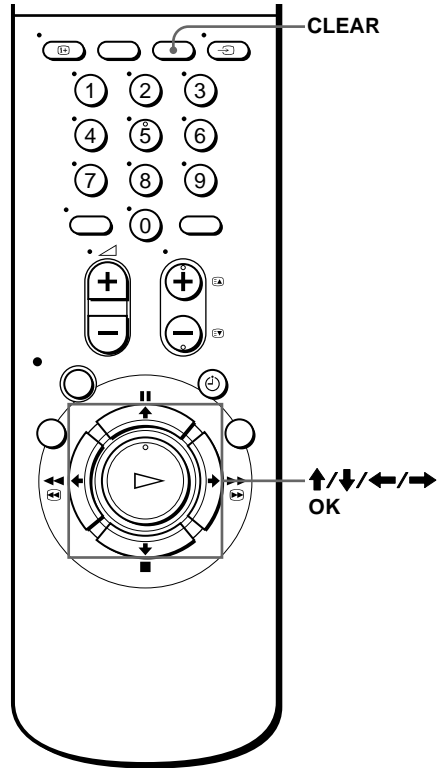
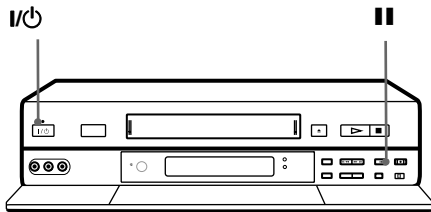

1

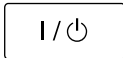

Hold down first **II** (pause), hold on **I/O** (on/standby) simultaneously on the VCR for more than 3 seconds.



The VCR automatically turns on, and the on-screen display appears on the TV screen.

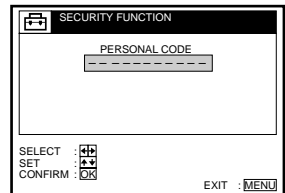

2



Press **↑/↓/←/→** to enter your personal code.

- 1 Press **↑/↓** to select a character.
- 2 Press **→** to set the next character. The next space is highlighted. To correct a character, press **←/→** until the character you want to correct is highlighted, then reset it. You can set up to 11 characters for your personal code.

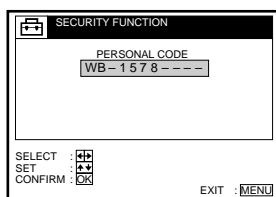

3



Press **OK**.

A confirmation screen appears.

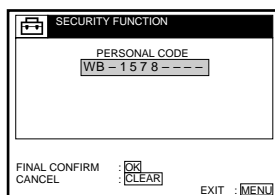

4



If the displayed personal code is correct, press **OK** to confirm the setting and to return to the normal display.

If the displayed personal code is wrong, press **CLEAR** to cancel the code and re-enter it restarting from step 2.



5

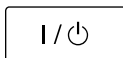

Press **I/⏻** (on/standby) to turn off the VCR.

continued

Checking your personal code

After setting the personal code number of your VCR, you can check the setting.

- 1 Holding down first **II** (pause), hold down **I/⏻** (on/standby) for more than 3 seconds.
The VCR automatically turns on, and the entered personal code appears on the TV screen.

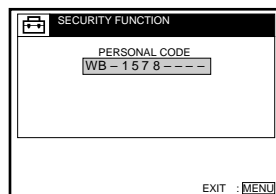

- 2 Press OK to exit the menu.

Playing a tape

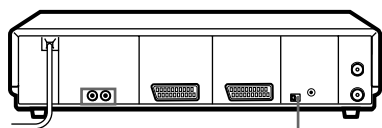

NTSC PB

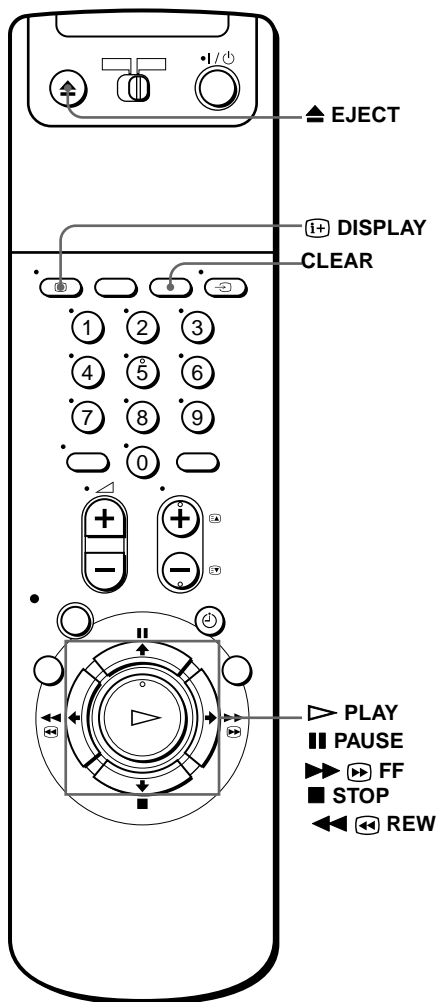

1 Turn on your TV and set it to the video channel.

2 Insert a tape.
The VCR turns on and starts playing automatically if you insert a tape with its safety tab removed.

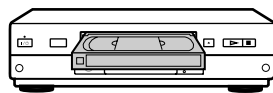

continued

3



Press PLAY.

When the tape reaches the end, it will rewind automatically.

Additional tasks

To	Press
Stop play	■ STOP
Pause play	PAUSE
Resume play after pause	PAUSE or PLAY
Fast-forward the tape	▶▶ FF during stop
Rewind the tape	◀◀ REW during stop
Eject the tape	▲ EJECT

To play an NTSC-recorded tape

Set NTSC PB at the rear of the VCR according to the colour system of your TV.

When your TV is	Set NTSC PB to
PAL only	ON PAL TV
PAL and NTSC	NTSC 4.43

To use the time counter

Press CLEAR at the point on the tape that you want to find later. The counter in the display window resets to “0:00:00.” Search for the point afterwards by referring to the counter.

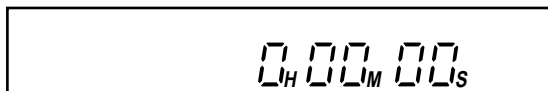

To display the counter on the TV screen, press DISPLAY.

Notes

- The counter resets to “0:00:00” whenever a tape is reinserted.
- The counter stops counting when it comes to a portion with no recording.
- Depending on your TV, the following may occur while playing an NTSC-recorded tape:
 - The picture becomes black and white.
 - The picture shakes.
 - No picture appears on the TV screen.
 - Black streaks appear horizontally on the TV screen.
 - The colour density increases or decreases.
- If you playback a tape in LP or EP mode with the NTSC system, the sound is heard in monaural.
- While setting the menu on the TV screen, you cannot use buttons for tape operation.

Starting playback automatically with one button (One Touch Play)

If you use the SMARTLINK connection, you can turn on the VCR and the TV, set the TV to the video channel, and start playback automatically with one button.

1 Insert a tape.

The VCR automatically turns on.

If you insert a tape with its safety tab removed, the TV turns on and switches to the video channel. Playback starts automatically.

2 Press \triangleright PLAY.

The TV turns on and switches to the video channel automatically. Playback starts.

Tip

- When there already is a tape in the VCR, the VCR and the TV turn on, the TV is set to the video channel, and playback starts automatically in one sequence when you press \triangleright PLAY.

Note

- When you use the One Touch Play function, leave the TV on or in the standby mode.

Recording TV programmes

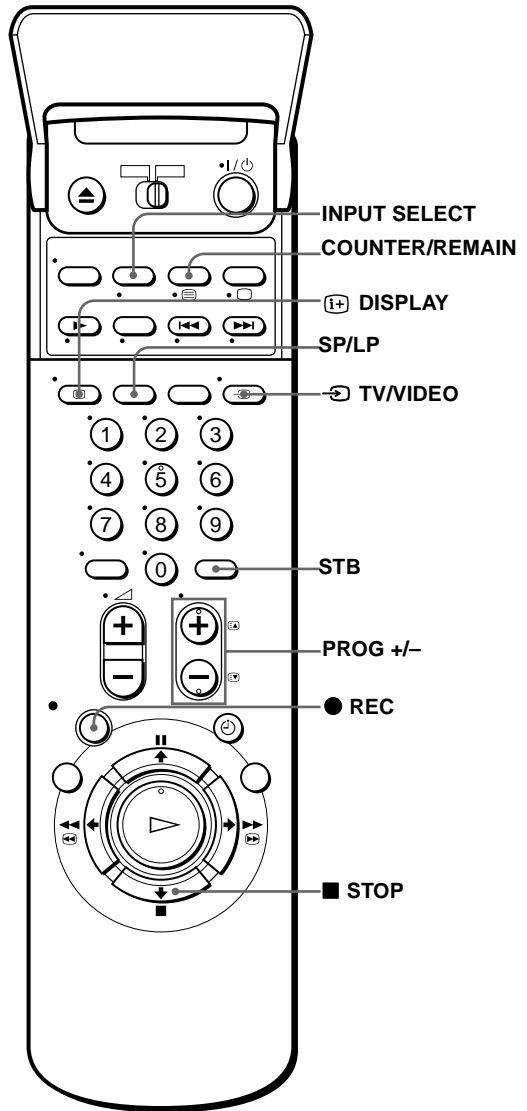

1

Turn on your TV and set it to the video channel.
To record from a decoder or other source, turn it on.

2 Insert a tape with its safety tab in place.

3



- To record a normal channel.
Press PROG +/- until the programme position number you want appears in the display window.



- To record a video source from the LINE-1 (TV) or LINE-3 (Scart) connector or the LINE-2 IN jacks. Press INPUT SELECT until L1, L2, or L3 appears in the display window.

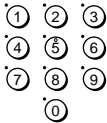
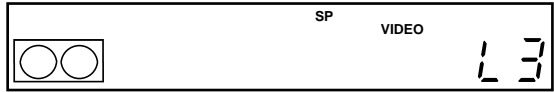

- To select a channel for your Set-Top Box.
Press STB. The STB indicator lights up in the display window. Then enter a three digit STB channel number with the programme number buttons.

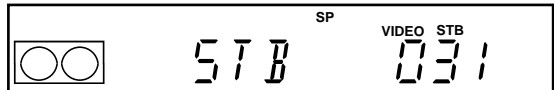

4



Press SP/LP to select the tape speed, SP or LP.

LP (Long Play) provides recording time twice as long as SP. However, SP (Standard Play) produces better picture and audio quality.

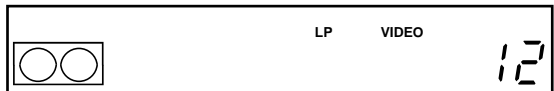

5



Press ● REC to start recording.

The recording indicator lights up red in the display window.

Recording indicator



To stop recording

Press ■ STOP.

continued

To check the remaining time

Press **(1+)** DISPLAY. With the display on, press COUNTER/REMAIN to check the remaining time. Each time you press COUNTER/REMAIN, the time counter and the remaining time appear alternately. The **(C)** indicator indicates the remaining time..

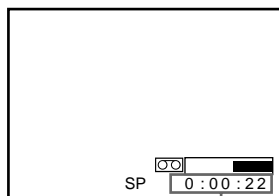

Time counter

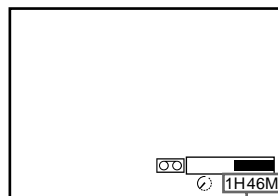

Remaining time

In order to get an accurate remaining time indication, be sure the TAPE LENGTH item in the TAPE OPTIONS menu is set according to the tape type you use (see page 74).

To watch another TV programme while recording

- 1 Press **(TV)** TV/VIDEO on the remote commander to turn off the VIDEO indicator in the display window.
- 2 Select another programme position on the TV.

To protect a recording

To prevent accidental erasure, break off the safety tab as illustrated. To record on a tape again, cover the tab hole with adhesive tape.

Tips

- To select a programme position, you can use the programme number buttons on the remote commander. For two-digit numbers, press the **--** (ten's digit) button followed by the programme number buttons.
- The display appears on the TV screen indicating information about the tape, but the information won't be recorded on the tape.
- If you don't want to watch TV while recording, you can turn off the TV. When using a decoder or other source, make sure to leave it on.

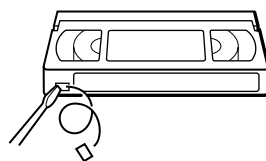

Safety tab

Notes

- If a tape has portions recorded in both PAL and NTSC systems, the time counter reading will not be correct. This discrepancy is due to the difference between the counting cycles of the two video systems.
- You cannot watch a PAY-TV/Canal Plus programme while recording another PAY-TV/Canal Plus programme.
- The remaining time is intended for rough measurement only.
- The remaining time will be displayed for only about 30 seconds after the tape starts playback.

Recording what you are watching on the TV (TV Direct Rec)

If you use the SMARTLINK connection, you can easily record what you are watching on the TV (other than tapes being played on the VCR).

- 1** Insert a tape with its safety tab in place.
- 2** Press ● REC while you are watching a TV programme or external source.
The VCR automatically turns on, then the TV indicator lights up and the VCR starts recording what you are watching on the TV.

Tips

- The TV indicator appears in the display window after you press ● REC in some situations such as:
 - when you are watching a source connected to the TV's line input, or
 - when the TV tuner preset data for the programme position is different from the data preset in the VCR tuner.
- If there already is a tape with its safety tab in place in the VCR, the VCR automatically turns on and starts recording what you are watching on the TV when you press ● REC.
- You can turn the TV Direct Rec function ON and OFF in the OTHER OPTIONS menu (see page 75).

Notes

- You cannot record what you are watching using this method when the VCR is in the following modes : pause, timer standby, tuner preset, Auto Set Up, and recording. You also cannot record using this method when the tape's safety tab is removed or when the tape is at the end.
- When the TV indicator is lit in the display window, do not turn off the TV nor change the TV programme position. When the TV indicator is not lit, the VCR continues recording the programme even if you change the TV programme position on the TV.

Recording TV programmes using the VIDEO Plus + system

The VIDEO Plus + system is a feature that simplifies programming the VCR to make timer recordings. Just enter the PLUSCODE NO. listed in the TV programme guide. The date, times, and programme position of that programme are set automatically. You can preset up to eight programmes at a time.

Before you start...

- Check that the VCR clock is set to the correct time and date.
- Insert a tape with its safety tab in place. Make sure the tape is longer than the total recording time.
- Turn on your TV and set it to the video channel.
- Set **TIMER OPTIONS** to **VIDEO Plus +** or **VARIABLE** in the **OTHER OPTIONS** menu (see page 75).

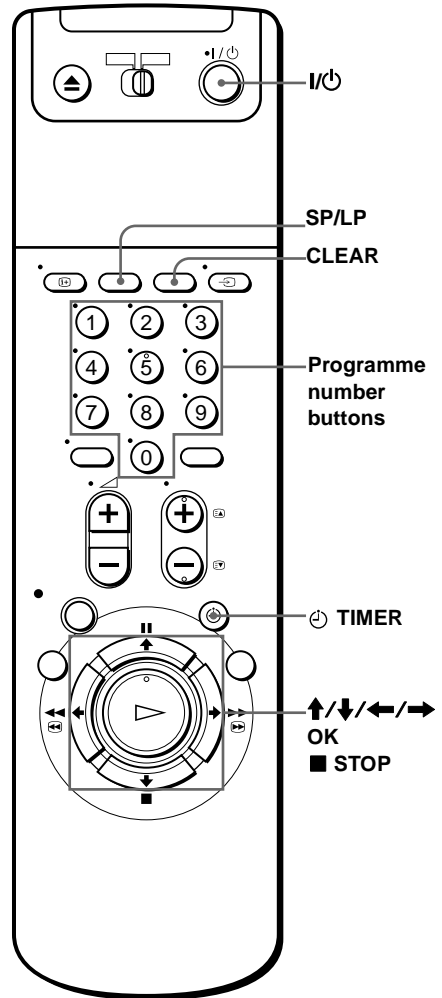

1

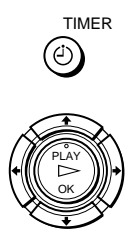

Press TIMER.

- When you set TIMER OPTIONS to VARIABLE:
The TIMER METHOD menu appears on the TV screen. Press to select VIDEO Plus +, then press OK.

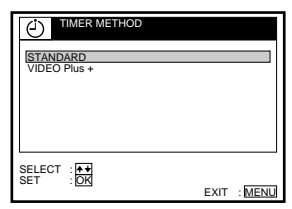

- When you set TIMER OPTIONS to VIDEO Plus +:
The VIDEO Plus + menu appears on the TV screen.

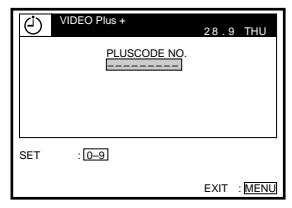

2

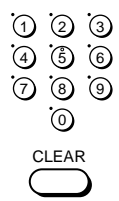

Press the programme number buttons to enter the PLUSCODE NO.

If you make a mistake, press CLEAR and re-enter the correct number.

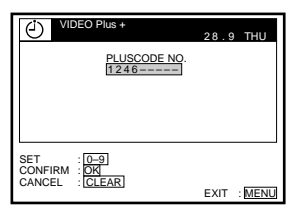

continued

3



Press OK.

The date, start and stop times, programme position, tape speed, and VPS/PDC setting appear on the TV screen.

If “- -” appears in the “PROG.” (programme) column (this may happen for local broadcasts), you have to set the appropriate programme position manually.

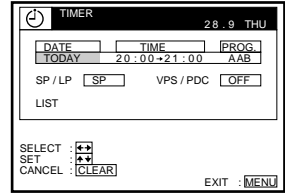

- To select a terrestrial channel.
Press **↑/↓** to select the desired programme position.
- To select a video source from the LINE-1 (TV) or LINE-3 IN connector, or the LINE-2 IN jacks.
Press INPUT SELECT to select the desired video source.
- To select a satellite channel
Press STB. “STB ---” appears in the PROG position on the TV screen.
Then enter a three digit channel number with the number buttons.

You will only have to do this operation once for the referred channel. The VCR will then store your setting.

For details about the VPS/PDC function, see “Timer recording with VPS/PDC signals” on page 53.



If the information is incorrect, press CLEAR to cancel the setting.

4



If you want to change the date, tape speed, and the VPS/PDC function setting:

- 1 Press **←/→** to highlight the item you want to change.
- 2 Press **↑/↓** to reset it.

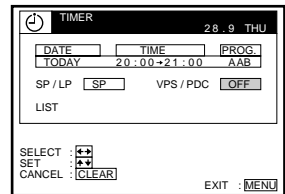

- To record the same programme every day or the same day every week, see “Daily/weekly recording” on page 53.
- To use the VPS/PDC function, set VPS/PDC to ON. For details about the VPS/PDC function, see “Timer recording with VPS/PDC signals” on page 53.
- To change the setting, press MENU, and highlight LIST, then select TIMER LIST and press OK. Then enter the new timer setting and press OK.



If the information is not correct, press CLEAR to cancel the settings.

5



Press MENU to exit the menu.

6



Press **I/⏻** to turn off the VCR.

The **⏻** indicator appears in the display window and the VCR stands by for recording.

To stop recording

To stop the VCR while recording, press **■ STOP**.

Daily/weekly recording

In step 4 above, press **↓** to select the recording pattern. Each time you press **↓**, the indication changes as shown below. Press **↑** to change the indication in reverse order.

TODAY → SUN-SAT (Sunday to Saturday) → MON-SAT (Monday to Saturday) → MON-FRI (Monday to Friday) → SAT (every Saturday) → MON (every Monday) → SUN (every Sunday) → 1 month later → (dates count down) → TOMORROW → TODAY

Timer recording with VPS/PDC signals

Some broadcast systems transmit VPS (Video Programme System) or PDC (Programme Delivery Control) signals with their TV programmes. These signals ensure that your timer recordings are made regardless of broadcast delays, early starts, or broadcast interruptions (when the VPS or PDC indicator in the display window is lit).

In step 4 above, press **↑/↓** to turn on/off the VPS/PDC indication after you set the recording date. If you do not want to set the VPS/PDC function, turn off the VPS/PDC indication.

You can also use the VPS/PDC function for a source connected to the LINE-1 (TV) and LINE-3 IN (Scart) connectors, or the LINE-2 IN jacks.

To use the VCR after setting the timer

To use the VCR before a timer recording begins, just press **I/⏻**. The **⏻** indicator turns off and the VCR switches on. Remember to press **I/⏻** to reset the VCR after using the VCR.

You can also do the following tasks while the VCR is recording:

- Reset the counter.
- Display tape information on the TV screen.
- Check the timer settings (see “Setting the timer manually” on page 55).
- Watch another TV programme.

continued

Tips

- To set the programme position with a two digit number, press $-/-$ (ten's digit) button followed by the programme number button.
- To set the programme position, you can also use the PROG +/- or programme number buttons.
- To set the tape speed, you can also use the SP/LP button.
- When you are recording a programme in the SP mode and the remaining tape becomes shorter than the recording time, the tape speed is automatically changed to the LP mode. Note that some interference will appear on the picture at the point the tape speed is changed. If you want to keep the same tape speed, set AUTO LONG PLAY to OFF in the TAPE OPTIONS menu (see page 73).
- To check, change, or cancel the programme setting, press \leftarrow/\rightarrow to choose LIST, then press OK after step 4. For details, see step 3 in "Checking/changing/cancelling timer settings on page 63.

Notes

- When setting the timer with VPS/PDC signals, enter the start and stop times exactly as indicated in the TV programme guide, otherwise the VPS/PDC function won't work and the recording won't start.
- If the VPS/PDC signal is too weak or the broadcasting station failed to transmit VPS/PDC signals, the VCR will start recording at the set time without using the VPS/PDC function.
- The \odot indicator flashes in the display window when you press I/⏻ with no tape inserted.
- The VPS/PDC function is automatically set to OFF for the timer recording of a satellite programme.
- When you set TIMER OPTIONS to STANDARD in the OTHER OPTIONS menu, the VIDEO Plus + menu does not appear on the TV screen. Select VIDEO Plus + or VARIABLE.

Setting the timer manually

If the VIDEO Plus + system is not available in your area, follow the instructions below to set the timer to record programmes.

Before you start...

- Check that the VCR clock is set to the correct time and date.
- Insert a tape with its safety tab in place. Make sure the tape is longer than the total recording time.
- To record from a decoder or other source, turn it on.
- Turn on your TV and set it to the video channel.
- Set **TIMER OPTIONS** to **STANDARD** or **VARIABLE** in the **OTHER OPTIONS** menu (see page 75).

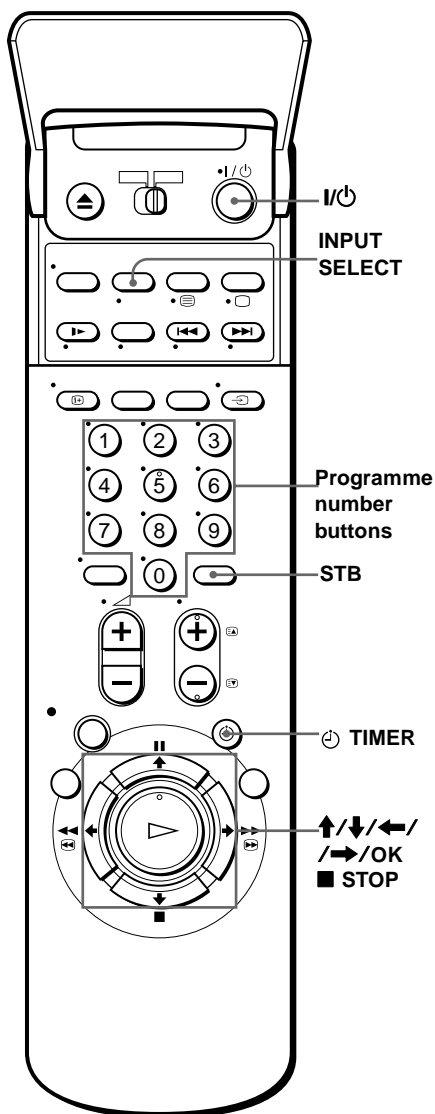

continued

1

TIMER



Press TIMER.

- When you set TIMER OPTIONS to VARIABLE:

The TIMER METHOD menu appears on the TV screen. Press to select STANDARD, then press OK.

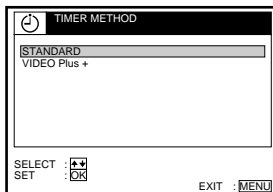

- When you set TIMER OPTIONS to STANDARD:

The TIMER menu appears on the TV screen.

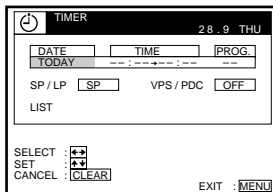

2



INPUT SELECT



Set the date, start and stop times, programme position, tape speed, and VPS/PDC function:

- 1 Press to highlight each item in turn.
- 2 Press to set each item.

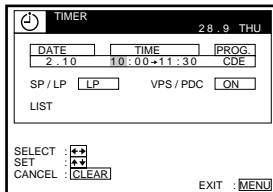

To correct a setting, press to return to that setting and reset it.

- To record the same programme every day or the same day every week, see “Daily/weekly recording” on page 57.
- To use the VPS/PDC function, set VPS/PDC to ON. For details about the VPS/PDC function, see “Timer recording with VPS/PDC signals” on page 53.
- To record from a decoder or other source connected to the LINE-1 (TV) or LINE-3 IN connectors, or the LINE-2 INjacks, press INPUT SELECT to display “L1,” “L2,” or “L3” in the “PROG.” position.
- To record from the STB, press STB to display “STB---” in the PROG position and enter a three digit number with the programme number buttons.

STB

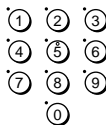

3

MENU



Press MENU to exit the menu.

4



Press **I/⏻** to turn off the VCR.

The **⏻** indicator appears in the display window and the VCR stands by for recording.

To record from a decoder or other sources, leave the connected equipment switched on.

To stop recording

To stop the VCR while recording, press **■ STOP**.

Daily/weekly recording

In step 2 above, press **↓** to select the recording pattern. Each time you press **↓**, the indication changes as shown below. Press **↑** to change the indication in reverse order.

TODAY → SUN-SAT (Sunday to Saturday) → MON-SAT (Monday to Saturday) → MON-FRI (Monday to Friday) → SAT (every Saturday) → MON (every Monday) → SUN (every Sunday) → 1 month later → (dates count down) → TOMORROW → TODAY

Tips

- To set the programme position, you can also use the PROG +/- or programme number buttons.
- To set the tape speed, you can also use the SP/LP button.
- When you are recording a programme in the SP mode and the remaining tape becomes shorter than the recording time, the tape speed is automatically changed to the LP mode. Note that some interference will appear on the picture at the point the tape speed is changed. If you want to keep the same tape speed, set AUTO LONG PLAY to OFF in the TAPE OPTIONS menu (see page 73).
- Even if you set TIMER OPTIONS to VIDEO Plus + in the OTHER OPTIONS menu, you can set the timer manually. Press MENU to select TIMER, then go to step 2.

Notes

- When setting the timer with VPS/PDC signals, enter the start and stop times exactly as indicated in the TV programme guide, otherwise the VPS/PDC function won't work and the recording won't start.
- If the VPS/PDC signal is too weak or the broadcasting station failed to transmit VPS/PDC signals, the VCR will start recording at the set time without using the VPS/PDC function.
- The VPS/PDC function is automatically set to OFF for the timer recording of a satellite programme.
- The **⏻** indicator flashes in the display window when you press **I/⏻** with no tape inserted.

Playing/searching at various speeds

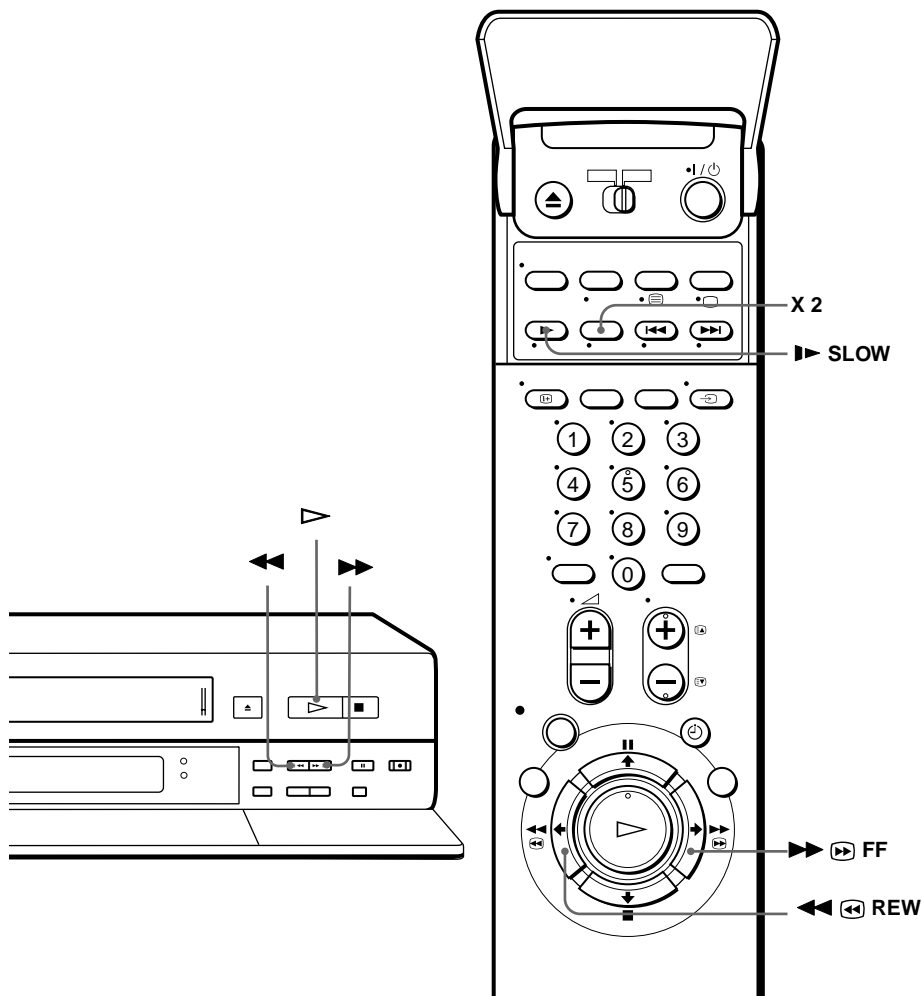

Playback options	Operation
Fast-forward /rewind	During stop, press ►► FF or ◀◀ REW and release.
View the picture during fast-forward or rewind	During fast-forward, hold ►► FF down. During rewind, hold ◀◀ REW down.
Play at high speed	<ul style="list-style-type: none"> • During playback, press ►► FF down or ◀◀ REW <u>on the remote commander.</u> • During playback, hold down ►► FF or ◀◀ REW. When you release the button, normal playback resumes.
Play at twice the normal speed	During playback, press X2.

Playback options	Operation
Play in slow motion	During playback, press ►► SLOW.
Play frame by frame	<ul style="list-style-type: none"> During pause, press ►► ⏮ FF down or ◀◀ ⏪ REW <u>on the remote commander</u>. Hold down ►► ⏮ FF or ◀◀ ⏪ REW to play one frame each second.
Rewind and start play	During stop, hold ◀◀ (rewind) down <u>on the VCR</u> and press ▷ (playback) <u>on the VCR</u> then release both.

To resume normal playback

Press ▷ (playback).

Tip

- Adjust the picture using the TRACKING +/- buttons if:
 - Streaks appear while playing in slow motion.
 - Bands appear at the top or bottom while pausing.
 - The picture shakes while pausing.
- To set tracking to the centre position, press both TRACKING buttons (+/-) at the same time.

Notes

- The playback sound is muted during the operations in the above table.
- In the LP mode, noise may appear or there may be no colour.
- If the playback mode mark doesn't appear on the TV screen, press Ⓛ+ DISPLAY.

Setting the recording duration time

After you start recording in the normal way, you can have the VCR stop recording automatically after a specified duration.

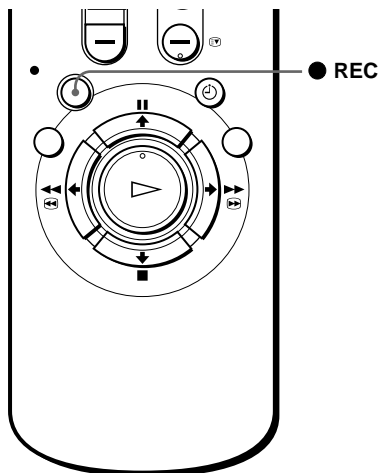

- 1 While recording, press ● REC.
The ⏻ indicator appears in the display window.

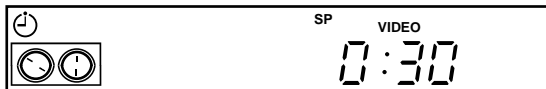

- 2 Press ● REC repeatedly to set the duration.
Each press advances the time in increments of 30 minutes.

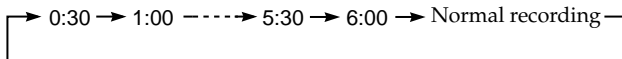

The tape counter decreases minute by minute to 0:00, then the VCR stops recording and turns off automatically.

To extend the duration

Press ● REC repeatedly to set a new duration.

To cancel the duration

Press ● REC repeatedly until the ⏻ indicator disappears and the VCR returns to normal recording mode.

To stop recording

To stop the VCR while recording, press ■ STOP.

Note

- You cannot display the current tape time in the display window when setting the recording duration.

Synchronized Recording

You can set the VCR to automatically record programmes from equipment such as a programmable Set Top Box by connecting the equipment to the LINE-3 IN connector. The connected equipment must have a timer function for this feature to work.

When the connected equipment turns on, the VCR also automatically turns on and starts recording a programme from LINE-3 IN.

How to connect for Synchronized Recording.

Connect the LINE-3 IN of the VCR to the TV Scart connector of the Set-Top Box. Then connect the LINE-1 (TV) connector to the TV.

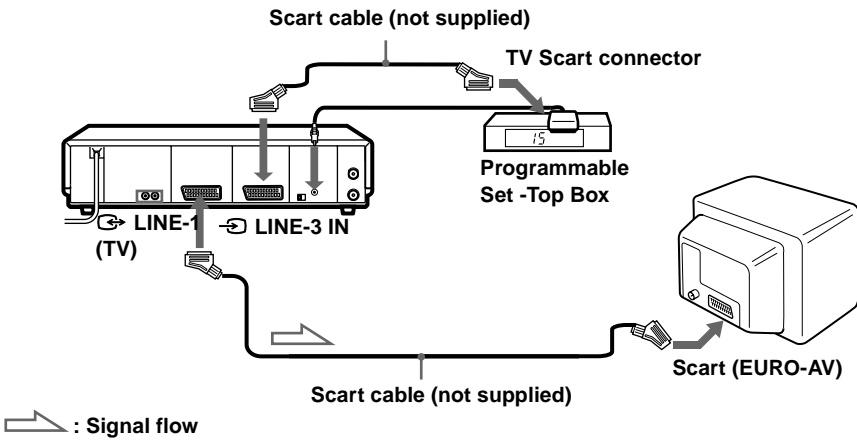

Recording programmes using the Synchronized Recording function

Before you start...

- Insert a tape with its safety tab in place. Make sure the tape is longer than the total recording time.

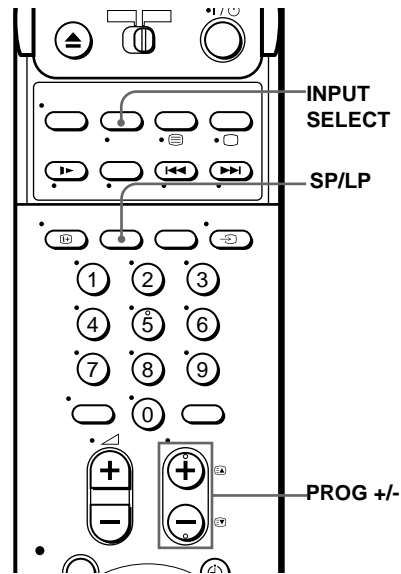
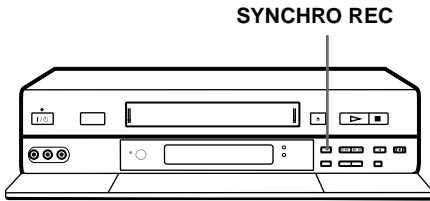

- 1** Set the timer on the STB to the time of the programme you want to record, then turn it off.
- 2** Press SP/LP to select the tape speed on the VCR.
- 3** Hold down SYNCHRO REC for more than two seconds. The SYNCHRO REC indicator lights up on the front panel and the VCR stands by for recording. The VCR automatically turns on and starts recording when it receives an input signal from the STB. The VCR automatically stops recording when the tape reaches the end or when the STB stops transmitting an input signal.

To cancel the Synchronized Recording function

Press SYNCHRO REC. The SYNCHRO REC indicator turns off.

To stop recording

Press ■ STOP while recording.

Notes

- This function may not work with some types of Set-Top Boxes.
- If the settings for timer recording and Synchronized Recording overlap, the programme that starts first has priority and the second programme starts recording only after the first programme has finished.
- The Auto Clock Set function does not work while the VCR stands by for Synchronized Recording.

Checking/changing/cancelling timer settings

Before you start...

- Turn on your TV and set it to the video channel.

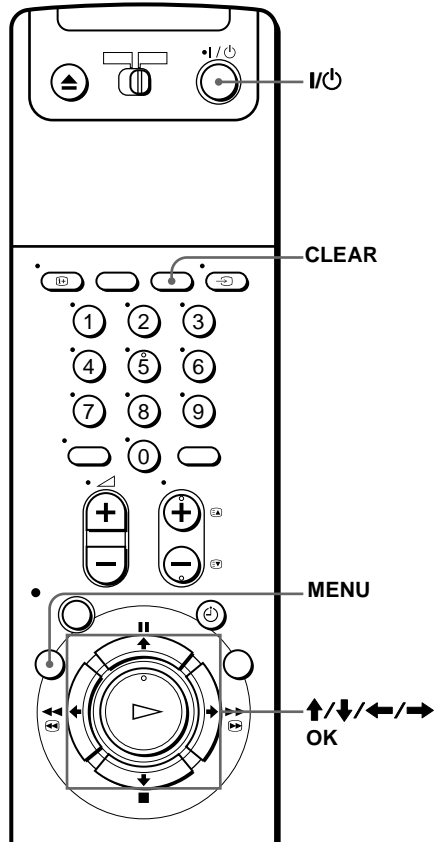

- 1** Press I/Power to turn on the VCR.
- 2** Press MENU, then press **↑/↓** to highlight LISTS and press OK.

continued

3 Press **↑/↓** to highlight **TIMER LIST**, then press **OK**:

- If you want to change or cancel a setting, go on to the next step.
- If you do not need to change or cancel the settings, press **MENU**, then turn off the VCR to return to recording standby.

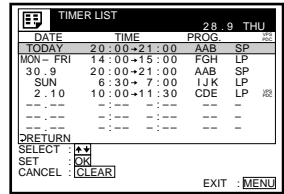

4 Press **↑/↓** to select the setting you want to change or cancel, then press **OK**.

The selected setting appears in the **TIMER** menu.

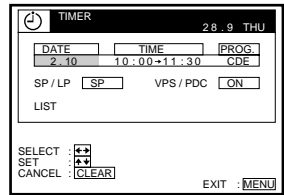

- 5**
- To change the setting, press **←/→** to highlight the item you want to change, and press **↑/↓** to change it.
 - To cancel the setting, press **CLEAR**.

6 Press **MENU**.

If any settings remain, turn off the VCR to return to recording standby.

When the timer settings overlap

The programme that starts first has priority and the second programme starts recording only after the first programme has finished. If the programmes start at the same time, the programme listed first in the menu has priority.

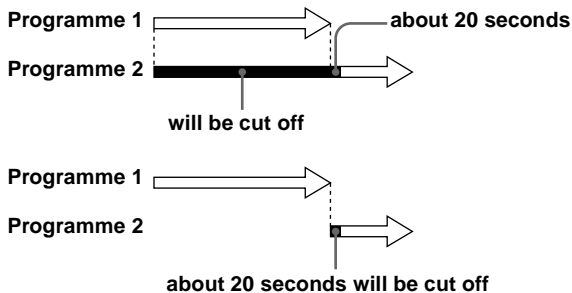

Tip

- In step 5 above, you can check the **TIMER LIST** by selecting **LIST** and pressing **OK**. Press **MENU** to exit the **TIMER LIST**.

Recording stereo and bilingual programmes

In NICAM system

This VCR receives and records stereo and bilingual programmes based on the NICAM system (the NICAM indicator appears). When a stereo or bilingual programme is received, the STEREO indicator appears in the display window.

To record a NICAM programme, HI-FI AUDIO in the AUDIO OPTIONS menu should be set to NICAM (initial setting). To check the menu setting, see page 74 for details.

To select the sound while recording

Press AUDIO MONITOR to select the sound you want.

Stereo programme

To listen to	On-screen display	Display window
Stereo	STEREO	STEREO
Standard sound*	No indicator	No indicator

* Usually the mixed sound of left and right channels (monaural)

Bilingual programme

To listen to	On-screen display	Display window
Main	MAIN	STEREO
Sub	SUB	STEREO
Main and sub	MAIN/SUB	STEREO
Standard sound*	No indicator	No indicator

* Usually the main sound (monaural)

Selecting the sound during playback

Press AUDIO MONITOR to select the sound you want.

To listen to	On-screen display	Display window
Stereo/main and sub (left and right channels)	STEREO	STEREO
Left channel/main	LCH	STEREO
Right channel/sub	RCH	STEREO
Standard sound	No indicator	No indicator

continued

How sound is recorded on a video tape

The VCR records sound onto two separate tracks. Hi-fi audio is recorded onto the main track along with the picture. Monaural sound is recorded onto the normal audio track along the edge of the tape.

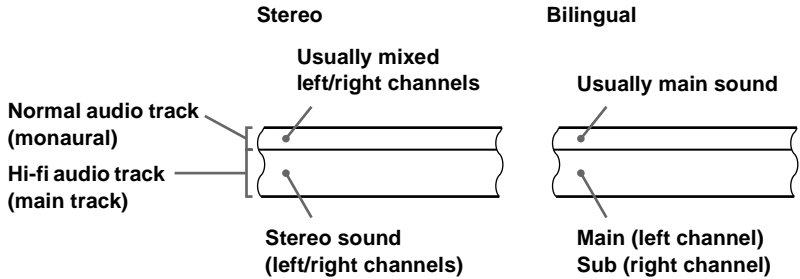

Notes

- To listen to playback sounds in stereo, you must use the EURO-AV or AUDIO OUT connections.
- When you play a tape recorded in monaural, the sound is heard in monaural regardless of the AUDIO MONITOR setting.
- If the AUDIO MONITOR button does not function, check that AUDIO MIX in the AUDIO OPTIONS menu is set to OFF (see page 74).
- If HIFI AUDIO is set to STANDARD, the standard sound will be recorded on both the hi-fi and normal audio tracks. Pressing AUDIO MONITOR will not change the sound.

Searching using the Smart Search function

If you record multiple programmes on a tape, use the Smart Search function to see what has been recorded on your tape. You can see information such as date time, and channel of programmes recorded on a tape. You can also start playback directly from the selected programme using the SMART SEARCH screen.

All programmes are listed on the screen, regardless of how the programme was recorded.

The data of last tape inserted into the VCR is automatically stored in memory. If you want to recall the latest data screen, select LATEST DATA in the SMART SEARCH screen recording.

Before you start...

- Turn on your TV and set it to the video channel.

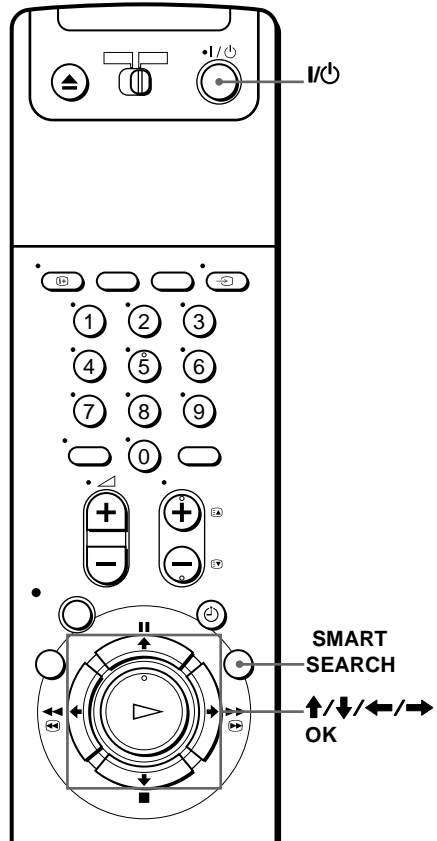

Additional Operations

- 1 After recording, press I/O to turn on the VCR.
- 2 Press SMART SEARCH.

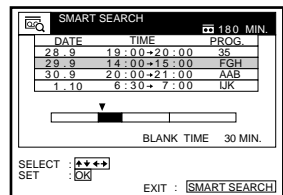

continued

3 Press **↑/↓/←/→** , to select the programme you want to start viewing.

4 Press **OK**.

The VCR starts searching, and playback starts automatically from the beginning of the selected programme.

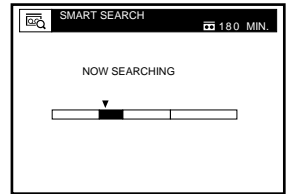

To stop searching

Press **■ STOP**.

To exit the SMART SEARCH screen

Press **SMART SEARCH**.

To record in a blank space

Blank space on the tape will appear as a blank row in the SMART SEARCH screen. Select the blank row in step 3, then press **OK**. The VCR rewinds/fast-forwards the tape to the beginning of the blank space, then stops. Start recording. Note that "BLANK TIME" and the remaining time indication only refers to the length of the last blank space.

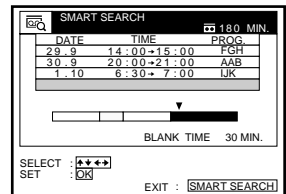

To recall the latest data screen after you remove the tape

You can display the data of the last tape used to record a programme, even after you have removed the tape.

If you reinsert the tape and record additional programmes, be sure to select **LATEST DATA**. Otherwise, all of the data for the tape is deleted.

1 Reinsert the last tape on which you record a programme

2 Press **SMART SEARCH**.

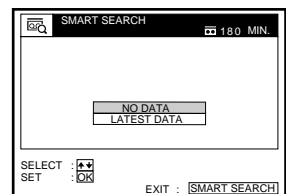

3 Press **↑/↓** to highlight LATEST DATA.

If you want to reset the latest data screen, highlight NO DATA and press OK, then record a programme.

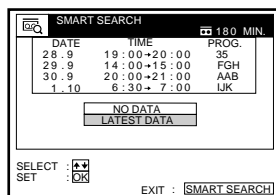

4 Press OK.

The latest data stored in the VCR's memory is displayed.

Tips

- You can store information for up to 24 programmes on a single list.
- While recording, you can display the SMART SEARCH screen using the SMART SEARCH button. If you decide to stop recording, press SMART SEARCH to make the SMART SEARCH screen disappear first. Then press STOP.

Notes

- You cannot use this function unless the clock is set.
- Depending on the tape, the total or remaining time may not appear correctly.
- When recording a short programme (less than 12 minutes in SP mode, or 24 minutes in LP mode), the Smart Search function may not be available or the programme information may not appear. Also, if you record a long programme directly after a short programme, the Smart Search information for the short programme may be deleted.
- Blank Time is measured from the end of the last recorded programme to the end of the tape. However, if you eject the tape then make a new recording on the same tape, the original recorded programme(s) is displayed as a blank space.
- If no information is stored in the VCR's memory, LATEST DATA does not appear in the SMART SEARCH screen.
- If you replace the tape with another tape and select LATEST DATA, you will not be able to record properly. You must reset the data by selecting NO DATA before you can record any new programmes.

Searching using the index function

The VCR marks the tape with an index signal at the point where each recording begins. Use these signals as references to find a specific recording. The VCR can search up to 99 index signals ahead or behind the current position.

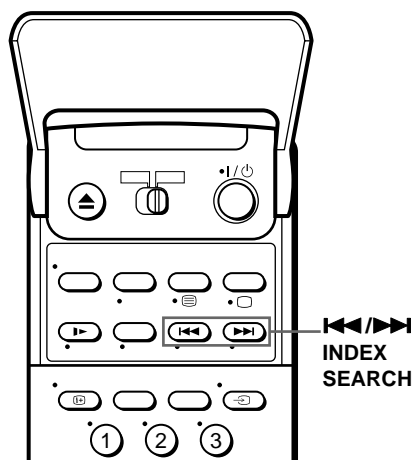

- 1 Insert an indexed tape into the VCR.
- 2 Press **◀◀/▶▶** INDEX SEARCH repeatedly to specify how many index signals ahead or behind you want to search :
 - To search ahead, press **▶▶** INDEX SEARCH.
 - To search backwards, press **◀◀** INDEX SEARCH.

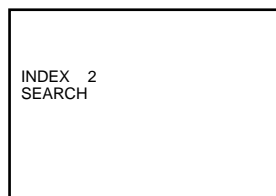

The VCR starts searching and the index number on the TV screen counts down to zero. Playback starts automatically from that point.

To stop searching

Press **■** STOP.

Note

- No index signal will be added when recording starts from recording pause. However, an index signal will be marked if you change the programme position during recording pause.

Adjusting the picture

Adjusting the tracking

Although the VCR automatically adjusts the tracking when playing a tape (the  indicator flashes in the display window, then goes off), distortion may occur if the tape was recorded in poor condition. In this case, manually adjust the tracking.

During playback, press TRACKING +/- to display the tracking meter. The distortion should disappear as you press one of the two buttons (the  indicator lights up). To resume automatic tracking adjustments, eject the tape and re-insert it. To set the tracking to the centre position, press TRACKING + and - buttons at the same time.

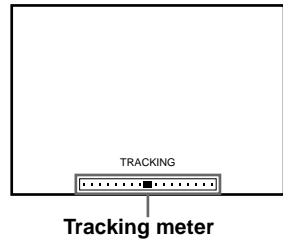

About the Reality Regenerator (RR) function

The Reality Regenerator (RR) function automatically restores the picture to its original quality during playback.

To use the RR function, press REALITY REGENERATOR button. The REALITY REGENERATOR indicator lights up. You can set RR to HIGH or NORMAL in the VIDEO OPTIONS menu (see page 73).

To turn it off, press REALITY REGENERATOR. The REALITY REGENERATOR indicator lights off.

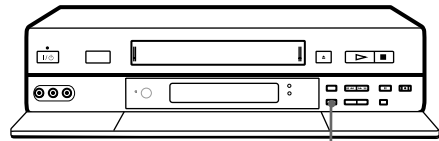

REALITY REGENERATOR

About the Optimum Picture Control (OPC) function

The Optimum Picture Control (OPC) function automatically improves recording and playback quality by adjusting the VCR to the condition of the video heads and tape. To maintain better picture quality, we recommend that you set OPC to ON in the VIDEO OPTIONS menu (with the OPC indicator in the display window lit). For details, see page 73.

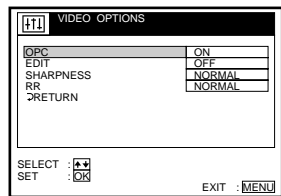

OPC playback

The OPC function automatically works on all types of tapes, including rental tapes and tapes that were not recorded with OPC.

continued

OPC recording

Whenever you insert a tape and start recording for the first time, the VCR adjusts to the tape using the OPC function (the OPC indicator flashes rapidly). This adjustment is retained until the tape is ejected.

To deactivate the OPC function

Set OPC to OFF in the VIDEO OPTIONS menu. The OPC indicator in the display window turns off.

Notes

- You can adjust the tracking for an NTSC-recorded tape but the tracking meter won't be displayed.
- With the Auto Long Play function ON, the OPC function will work only in SP mode. If the tape speed automatically switches from SP to LP, the OPC function turns off. However, if the entire programme is recorded in LP mode, the OPC function will work.
- There is a delay of about ten seconds before the VCR actually starts recording while the VCR analyses the tape. To avoid the delay, first set the VCR to recording pause (the OPC indicator flashes slowly) and press ● REC to have the VCR analyse the tape (the OPC indicator flashes rapidly) and return to recording pause. After the OPC indicator stops flashing, press ■■ PAUSE to start recording immediately. If you want to start recording quickly without using the OPC function, first set the VCR to recording pause (the OPC indicator flashes slowly) and press ■■ PAUSE to start recording.

Changing menu options

1 Press MENU, then select OPTIONS and press OK.

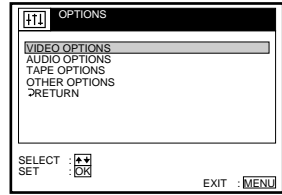

2 Press \uparrow/\downarrow to highlight the kind of option to change, VIDEO OPTIONS, AUDIO OPTIONS, TAPE OPTIONS or OTHER OPTIONS, then press OK.

3 Press \uparrow/\downarrow to select the option, then press OK to enter the pop up menu.

4 Press \uparrow/\downarrow to select the desired setting, then press OK.

5 Press MENU to exit the menu.

VIDEO OPTIONS menu

Initial settings are indicated in bold print.

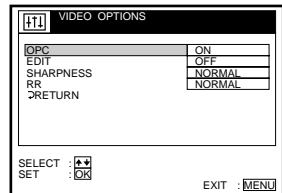

Menu option	Set this option to
OPC	<ul style="list-style-type: none"> • ON to switch on the OPC (Optimum Picture Control) function and improve picture quality. • OFF to switch off OPC.
EDIT	<ul style="list-style-type: none"> • ON to minimize picture deterioration when editing. • OFF to turn off EDIT.
SHARPNESS	<ul style="list-style-type: none"> • LOW to playback a poor quality tape. • NORMAL to playback an average quality tape. • HIGH to playback a good quality tape.
RR	<ul style="list-style-type: none"> • NORMAL for normal everyday use. • HIGH for well-used video tapes such as rented tapes. Select this option when NORMAL does not improve the picture quality. <p>For details, see page 71.</p>

Note

- When you playback with the EDIT function ON, the OPC and the SHARPNESS functions don't work.

continued

AUDIO OPTIONS menu

Initial settings are indicated in bold print.

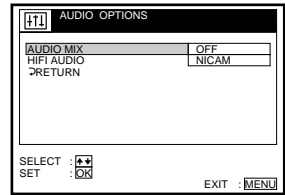

Menu option	Set this option to
AUDIO MIX	<ul style="list-style-type: none"> ON to listen to the hi-fi and normal audio tracks at the same time. The AUDIO MONITOR button will not function. OFF to listen to the hi-fi and normal audio tracks separately. Select the sound using the AUDIO MONITOR button. For details, see page 65.
HIFI AUDIO	<ul style="list-style-type: none"> STANDARD to record standard sound on the hi-fi audio track. NICAM to record NICAM broadcasts on the hi-fi audio track. For details, see page 65.

Note

- If you eject the tape, AUDIO MIX is automatically set to OFF.

TAPE OPTIONS menu

Initial settings are indicated in bold print.

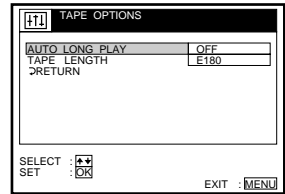

Menu option	Set this option to
AUTO LONG PLAY	<ul style="list-style-type: none"> ON to automatically record from SP (Standard Play) to LP (Long Play) when the tape length is not long enough. OFF to normally record in SP (Standard Play).
TAPE LENGTH	<ul style="list-style-type: none"> E180 to use an E-180 or shorter tape type. E195 to use an E-195. E240 to use an E-240. E300 to use an E-300.

OTHER OPTIONS menu

Initial settings are indicated in bold print.

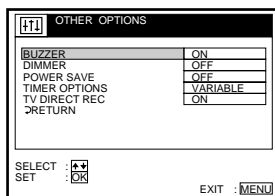

Menu option	Set this option to
BUZZER	<ul style="list-style-type: none"> • ON to output a beep sound. • OFF to deactivate it.
DIMMER	<ul style="list-style-type: none"> • ON to make the display window dim. • OFF to make it brighter.
POWER SAVE	<ul style="list-style-type: none"> • ON to turn off the indicators in the display window to save the VCR power. • OFF to turn on the indicators in the display window while the VCR is standing by.
TIMER OPTIONS	<ul style="list-style-type: none"> • VARIABLE to display the TIMER METHOD menu for selecting STANDARD or VIDEO Plus + when pressing the ⏻ TIMER button. • STANDARD to display only the TIMER menu when pressing the ⏻ TIMER button. • VIDEO Plus + to display only the VIDEO Plus + menu when pressing the ⏻ TIMER button. <p>For details, see page 50 and 55.</p>
TV DIRECT REC	<ul style="list-style-type: none"> • ON to activate the TV Direct Rec function. • OFF to deactivate it.

Note

- When you set a timer recording or a synchronized recording, the indicators in the display window remain on, even though POWER SAVE is set to ON.

Connecting to a VCR or stereo system

How to connect to record on your VCR

Connect the line outputs of the other VCR to the LINE IN connector or jacks of your VCR. Refer to the examples A or B and choose the connection that best suits your VCR.

Example A

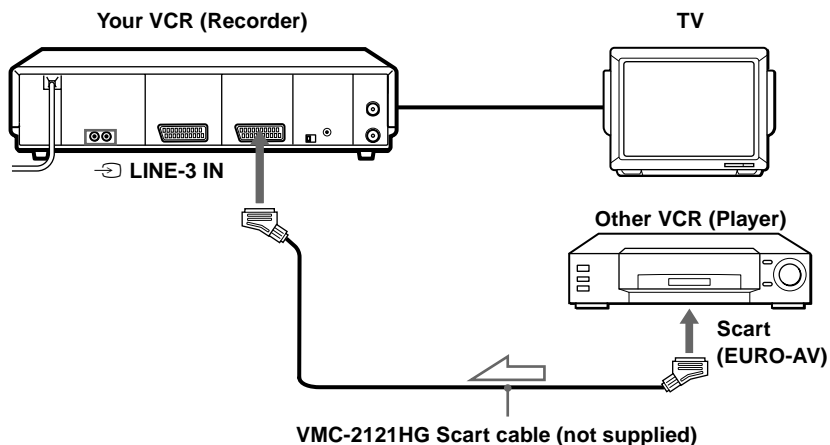

 : Signal flow

Example B

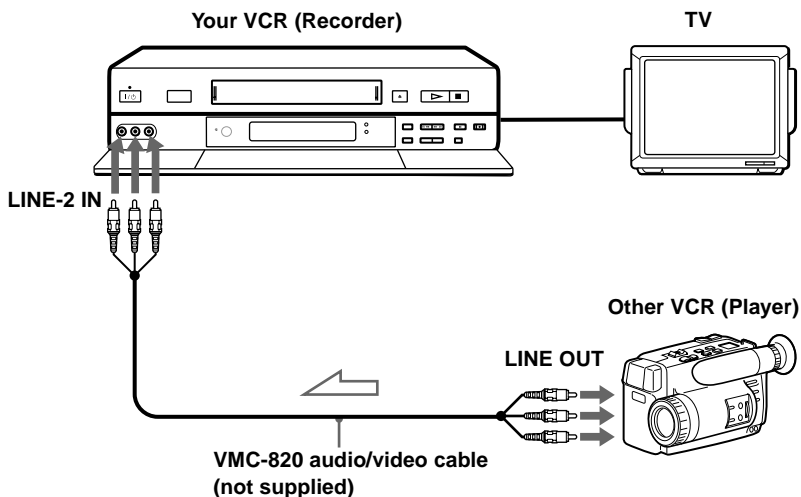

 : Signal flow

How to connect to a stereo system

Connect the LINE-2 IN AUDIO L/R jacks on your VCR to the audio output jacks on the stereo system using the RK-C510HG audio cable (not supplied).

Notes

- Make sure you connect the plugs to jacks of the same colour.
- If the other VCR is a monaural type, leave the red plugs unconnected.
- If you connect your VCR to both the LINE IN and LINE OUT jacks of the other VCR, select the input correctly to prevent a humming noise.
- If the other VCR does not have a Scart (EURO-AV) connector, use the VMC-2106HG cable instead and connect the cable to the line out jacks of the other VCR.

Tip

- You can also use the LINE-3 IN connector instead.

Basic Editing

(when recording on your VCR)

Before you start editing...

- Turn on your TV and set it to the video channel. Press INPUT SELECT to display “L2” (or “L1” or “L3”) in the display window.
- Press SP/LP to select the tape speed, SP or LP.
- On your VCR, set EDIT to ON in the VIDEO OPTIONS menu to display “EDIT” in the display window. If the other VCR has a similar feature, activate this one as well.

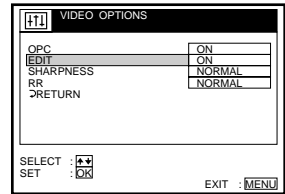
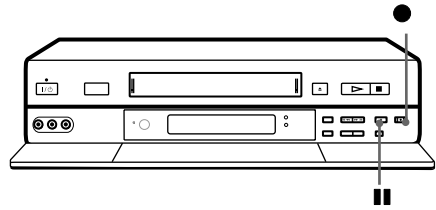

- 1 Insert a source tape with its safety tab removed into the other (playback) VCR. Search for the point to start playback and set it to playback pause.
- 2 Insert a tape with its safety tab in place into your (recording) VCR. Search for the point to start recording and press **||** (pause).
- 3 Press **●** (record) on your VCR to set it to recording pause.
- 4 To start editing, press the **||** (pause) buttons on both VCRs at the same time.

To stop editing

Press the **■** (stop) buttons on both VCRs.

Tip

- To cut out unwanted scenes while editing, press **||** (pause) on your VCR when an unwanted scene begins. When it ends, press **||** (pause) again to resume recording.

Note

- If you start editing following the procedure above, the VCR won't start recording with the OPC function. To record a tape with the OPC function, press **●** (record) again during recording pause in step 3 so the VCR analyses the tape. Then, press **||** (pause) after the OPC indicator stops flashing to start recording. If you press **||** (pause) before the OPC indicator stops flashing, the OPC function is cancelled.

Audio dubbing

This feature lets you record over the normal audio track. The monaural sound previously recorded is replaced while the original hi-fi sound remains unchanged. Use this feature to add commentary to a tape that you have recorded with a camcorder.

Before you start...

- Turn on the TV and set it to the video channel

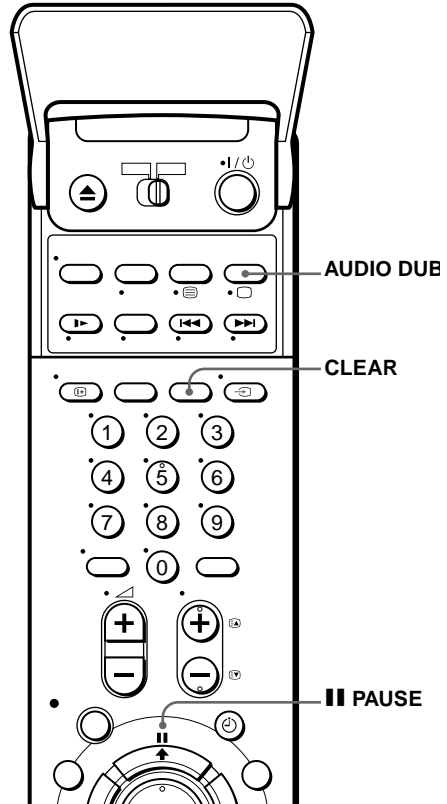

- 1** Insert a source tape into the stereo system (or the playback VCR). Search for the point to start playback and set it to playback pause.
- 2** Insert a prerecorded tape with its safety tab in place into your (recording) VCR. Search for the end of the section to be replaced and press **|| PAUSE**.
- 3** Press **CLEAR** to reset the counter to "0H00M00S."
- 4** Rewind the prerecorded tape to the beginning of the section to be replaced. The VCR enters pause mode.
- 5** Press **AUDIO DUB**. The \ominus indicator appears in the display window.

continued

- 6** To start editing, press the **||** (pause) buttons on your VCR and the stereo system (or other VCR) at the same time.

When the counter reaches “0H00M00S,” audio dubbing stops automatically.

To stop while editing

Press **■** (stop) on this VCR and the stereo system (or other VCR).

Note

- After you use this feature, the audio in playback mode is automatically set to monaural.

To listen to both the hi-fi and normal audio

Set AUDIO MIX to ON in the AUDIO OPTIONS menu (see page 77). Use this feature to listen to dubbed audio over the original hi-fi audio. When AUDIO MIX is set to ON, the AUDIO MONITOR button does not function. Note that by mixing both hi-fi and normal audio, some echo may appear.

Remember to reset AUDIO MIX to OFF after playing the tape.

Note

- If you eject the tape, AUDIO MIX is automatically set to OFF.

Troubleshooting

If you have any questions or if your problems are not covered below, please consult your nearest Sony service facility.

Problem summary

The following table summarizes the reference numbers for the problems you might face. In order to solve your problem, please refer to the corresponding reference (S1=symptom1, S2=symptom2 ...) in the right column below.

CATEGORY	REFER TO
Picture <ul style="list-style-type: none"> • while watching broadcast tuned by the TV • while watching broadcast tuned by the VCR. • while playing a tape. 	S2, S6 S1, S6 S3, S4, S5
Sound <ul style="list-style-type: none"> • while playing a tape. 	S7, S8, S9
Functional <ul style="list-style-type: none"> • Playback • Normal recording • Timer recording • Synchronized Recording • Remote commander • Cleaning • Clock • Power • Tape • SMARTLINK • Set-Top Box control 	S4, S9, S10 S11, S12 S13, S14 S15, S16, S17 S18, S19 S20 S21 S22, S23, S24, S25, S26 S27, S28 S29 S30, S31

continued

Picture		
S1	The VCR picture does not appear on the TV screen.	<ul style="list-style-type: none"> → Make sure the TV is set to the video channel. If you are using a monitor, set it to video input. → If the VCR is connected to the TV with a Scart cable, make sure the TV/VIDEO indicator is lit in the display window. Use the TV/VIDEO key on the remote commander to light the TV/VIDEO indicator. → If your VCR is connected to the TV with only an aerial cable, make sure the TV is correctly tuned to the VCR (see page 15).
S2	The TV programme is not clear or has some interference.	<ul style="list-style-type: none"> → If your TV is connected to the VCR with both a Scart and an aerial cable, make sure the RF channel is set to OFF (see page 17). → If your VCR is connected to the TV with only an aerial cable, make sure the TV is correctly tuned to the VCR (see page 15).
S3	The playback picture is not clear or has some interference.	<ul style="list-style-type: none"> → If your TV is connected to the VCR with both a Scart and an aerial cable, make sure the RF channel is set to OFF (see page 17). → Existing broadcasts may interfere with the VCR. Reset the RF channel output of your VCR (see page 15). → Adjust the tracking with the TRACKING +/- buttons (see page 71). → The video heads are dirty (see below). Clean the video heads using the Sony T-25CLD, E-25CLDR, or T-25CLW video head cleaning cassette. If these cleaning cassettes are not available in your area, have the heads cleaned at your nearest Sony service facility (a standard service charge will be required). Do not use a commercially available liquid type cleaning cassette other than Sony's, as it may damage the video heads. → The video heads may have to be replaced. Consult your local Sony service facility for more information.
S4	The tracking meter does not appear on the TV screen.	→ The recording condition of the tape is very poor and tracking cannot be adjusted.
S5	The picture rolls vertically during picture search.	→ Adjust the vertical hold control on the TV or monitor.

Symptoms caused by contaminated video heads

• Normal picture



• Rough picture



initial
contamination

Unclear picture



• No picture (or black & white screen appears)



terminal



Picture		
S6	TV reception is poor.	<ul style="list-style-type: none"> → Make sure the aerial cables are connected securely. → Adjust the TV aerial.
Sound		
S7	The picture has no sound.	→ The tape is defective. Please use a new tape.
S8	The sound is unstable or has an echo.	→ When you play a tape with the same sound recorded on both the hi-fi and normal sound tracks, make sure AUDIO MIX in the AUDIO OPTIONS menu is set to OFF (see page 74).
S9	You cannot select the left or the right channel while playing a tape	<ul style="list-style-type: none"> → Make sure AUDIO MIX is set to OFF in the AUDIO OPTIONS menu (see page 74). → Make sure you are playing a hi-fi tape.
Playback		
S10	The tape starts playing as soon as it is inserted.	→ This is normal. When you insert a tape with no safety tab, the VCR starts playing automatically.
Normal recording		
S11	The tape is ejected when you press ● REC.	→ The safety tab has been removed. To record on this tape, cover the tab hole (see page 48).
S12	Nothing happens when you press ● REC.	→ Make sure the tape is not at its end.
Timer recording		
S13	The timer does not operate properly.	<ul style="list-style-type: none"> → Check that the clock is set. → The clock stops if the VCR is disconnected from the mains for more than an hour. Reset the clock and the timer. → Check that the safety tab has not been removed. → Make sure the tape is not at its end. → Make sure a tape has been inserted. → Make sure the current time is not already past your timer settings. → If you are recording a programme from a set top box, make sure the set top box is turned on.
S14	The VPS/PDC function does not operate properly.	<ul style="list-style-type: none"> → Check that the clock and the date are set correctly. → Check that the VPS/PDC time you set is the correct one (there might be a mistake in the TV guide programme). If the broadcast you wanted to record did not send the correct VPS/PDC information, the VCR will not start recording. → If the reception is poor, the VPS/PDC signal might be altered and the VCR might not start recording.

continued

Synchronized Recording		
S15	The SYNCHRO REC indicator turns off while recording or does not go back to recording standby mode.	→ The tape has reached its end. Insert a new tape and press SYNCHRO REC again.
S16	The Synchronized Recording function does not work.	→ The connected equipment was not turned off. Turn off the connected equipment and press SYNCHRO REC again. → There was a power failure. Press SYNCHRO REC again.
S17	The programme recorded with the Synchronized Recording function is incomplete.	→ If the settings for timer recordings and Synchronized Recording overlap, the programme that starts first has priority and the second programme starts recording only after the first programme has finished. → There was a power failure. Press SYNCHRO REC again.
Remote commander		
S18	The remote commander does not operate.	→ Make sure you are pointing the remote commander at the remote sensor on the VCR. → Replace all of the batteries in the remote commander with new ones if they are weak. → Make sure the TV/VIDEO remote control switch is set correctly.
S19	You cannot control your TV.	→ Set your TV's code number. The code number may change when you replace the batteries for the remote commander (see page 8).
Cleaning		
S20	The VCR needs to be cleaned.	→ Clean the cabinet, panel and controls with a dry, soft cloth, or a soft cloth slightly moistened with a mild detergent solution. Do not use any type of solvent, such as alcohol or benzene.
Clock		
S21	The clock has stopped and “-:--” lights up in the display window.	→ The clock stops if the VCR is disconnected from the mains for more than one hour. Reset the clock and timer if needed (see page 19).
Power		
S22	The I/⏻ ON/STANDBY switch does not function.	→ Connect the mains lead to the mains securely.
S23	The power is turned on but the VCR does not operate.	→ Moisture condensation has occurred. Turn the power off, unplug the mains lead and leave the VCR to dry for over three hours.
S24	The tape is ejected when you press I/⏻ ON/STANDBY.	→ You have set a timer recording, but the tape on which you want to record is protected. Use another tape or replace the safety tab.
S25	The display is not lit when the VCR is in STANDBY mode.	→ The VCR is in power save mode. Set the POWER SAVE option to OFF in the OTHER OPTIONS menu (see page 75).

Power		
S26	POWER SAVE is set to ON but the display remains lit in STANDBY mode.	→ The display is always lit if the VCR is in timer standby mode. For more details regarding the energy saving function, see page 75.
Tape		
S27	The tape is ejected when you press I/⏻ ON/STANDBY.	→ You have set a timer recording, but the tape on which you want to record is protected. Use another tape or replace the safety tab.
S28	A tape cannot be inserted.	→ Check that a tape isn't already in the tape compartment.
SMARTLINK		
S29	The SMARTLINK function does not work properly.	<ul style="list-style-type: none"> → Check that your TV complies with SMARTLINK, NexTVView Link, MEGALOGIC, EASYLINK/CinemaLink, Q-Link or TV-LINK. → Make sure you use a 21-pin Scart cable to connect the VCR and your TV. → Make sure the Scart cable is connected securely. Refer to your TV manual for instructions.
Set-Top Box control		
S30	The Set-Top Box Control function does not work properly.	<ul style="list-style-type: none"> → Be sure to point the VCR remote commander only at the VCR's remote sensor and not at the STB sensor. → Be sure the STB controller is pointing at the set top box's remote sensor receiver. → Make sure the STB controller is connected securely. → The STB tuner brand number may be deleted if you disconnect it from the VCR. Re-enter the brand code number corresponding to your set top box (see page 28).
S31	You cannot watch the STB picture when the VCR is in standby mode or ● REC standby mode.	→ Make sure the POWER SAVE option is set to OFF in the OTHER OPTIONS menu (see page 75).

Specifications

System

Channel coverage

PAL (I)

UHF B21 to B69

RF output signal

UHF channels 21 to 69

Aerial out

75-ohm asymmetrical aerial socket

Tape speed

SP: PAL 23,39 mm/s (recording/playback)

NTSC 33,35 mm/s (playback only)

LP: PAL 11,70 mm/s (recording/playback)

NTSC 16,67mm/s (playback only)

EP: NTSC 11,12 mm/s (playback only)

Maximum recording/playback time

10 hrs. in LP mode (with E300 tape)

Fast-forward and rewind time

Approx. 1 min. (with E180 tape)

Inputs and outputs

LINE-1 (TV)

21-pin

Video input: pin 20

Audio input: pins 2 and 6

Video output: pin 19

Audio output: pins 1 and 3

LINE-3 IN

21-pin

Video input: pin 20

Audio input: pins 2 and 6

LINE-2 IN

VIDEO IN, phono jack (1)

Input signal: 1 Vp-p, 75 ohms, unbalanced, sync negative

AUDIO IN, phono jack (2)

Input level: 327 mVrms

Input impedance : more than 47 kilohms

AUDIO OUT, phono jack (2)

Rated output level: 327 mVrms

Load impedance: 47 kilohms

Output impedance: less than 10 kilohms

General

Power requirements

220 – 240 V AC, 50 Hz

Power consumption

23 W (Normal)

2, 0 W (POWER SAVE is set to ON, no decoder)

Operating temperature

5°C to 40°C

Storage temperature

-20°C to 60°C

Dimensions

Approx. 430 × 100 × 330 mm (w/h/d)

including projecting parts and controls

Mass

Approx. 4.6 kg

Supplied accessories

Remote commander (1)

R6 (size AA) batteries (2)

Aerial cable (1)

Set-Top Box controller (1)

Design and specifications are subject to change without notice.

Index to parts and controls

Refer to the pages indicated in parentheses () for details.

Front panel

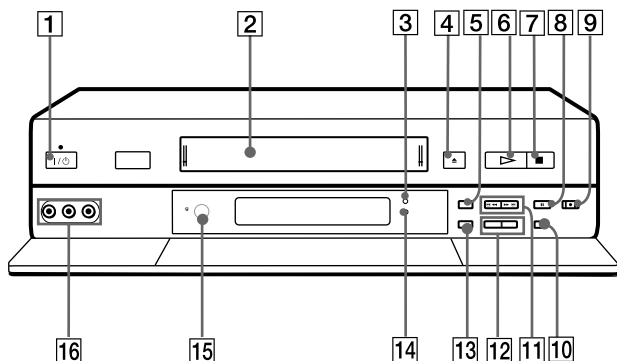

- | | |
|---|--|
| 1 I/ON (on/standby) button/indicator (6) | 10 AUTO SET UP (18)/
RF (Radio Frequency) CHANNEL
button (15) |
| 2 Tape compartment | 11 ◀◀ (rewind) / ▶▶ (fast-forward)
buttons (44) |
| 3 SYNCHRO REC indicator (62) | 12 PROGRAM/TRACKING +/- buttons
(15), (18), (71) |
| 4 ▲ (eject) button (44) | 13 REALITY REGENERATOR button (71) |
| 5 SYNCHRO REC button (62) | 14 REALITY REGENERATOR (RR)
indicator (71) |
| 6 ▷ (playback) button (44) | 15 Remote sensor (5) |
| 7 ■ (stop) button (44) | 16 LINE-2 IN VIDEO/AUDIO L/R jacks
(76) |
| 8 (pause) button (44) | |
| 9 ● (record) button (46), (78) | |

continued

Display window

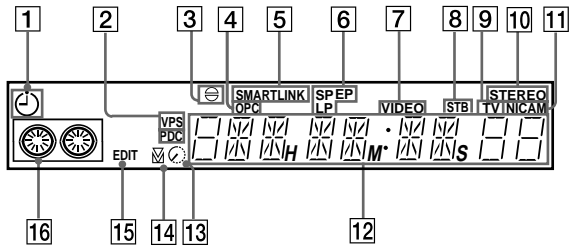

- | | |
|---|---|
| 1 Timer indicator (50), (55) | 8 STB indicator (53) |
| 2 VPS (Video Programme System)/PDC (Programme Delivery Control) indicator (53) | 9 TV indicator (49) |
| 3 Audio Dubbing indicator (82) | 10 STEREO indicator (65) |
| 4 OPC (Optimum Picture Control) indicator (71) | 11 NICAM indicator (65) |
| 5 SMARTLINK indicator (11) | 12 Time counter/clock/line/programme position indicator (15), (44), (47) |
| 6 Tape speed indicators (47) | 13 Remaining time indicator (48) |
| 7 VIDEO indicator (47) | 14 Tracking indicator (71) |
| | 15 EDIT indicator (78) |
| | 16 Tape/recording indicator (47) |

Rear panel

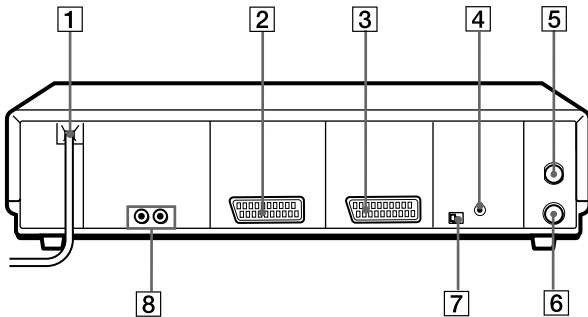

- | | |
|---|---|
| 1 Mains lead (9), (12) | 5 AERIAL IN
ANTENNE ENTREE connector (9), (12) |
| 2 ↻ LINE-1 (TV)
↻ LIGNE-1 (TV) connector (9) | 6 AERIAL OUT
ANTENNE SORTIE connector (9), (12) |
| 3 ↻ LINE-3 IN
↻ ENTREE LIGNE-3 connector (13) | 7 NTSC PB (Play Back) switch (43) |
| 4 STB CONTROL
CONTROLEUR STB jack (15) | 8 LINE-2 OUT
AUDIO R/L /VIDEO
SORTIE LIGNE-2
AUDIO D/G/VIDEO (14) |

continued

Remote commander

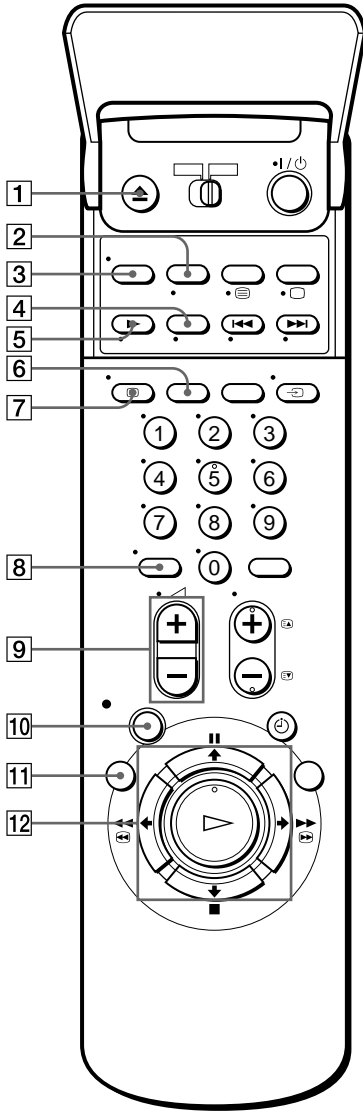

- 1 ▲ EJECT button (40)
- 2 INPUT SELECT button (43), (51)
WIDE button (*for TV*) (7)
- 3 AUDIO MONITOR button (6), (61)
- 4 X2 button*
- 5 ► SLOW button*
- 6 SP (Standard Play)/LP (Long Play)
button (42)
- 7 [i+] DISPLAY button (44)
- 8 -/- (ten's digit) button (6), (44)
- 9 ▲ (volume) +/- buttons (*for TV*) (6)
- 10 ● REC (record) button (42), (56), (71)
- 11 MENU button
- 12 ↑/↓/←/→ buttons
OK button
◀◀ [↺] REW (rewind) button (40), (54)
▶▶ [↻] FF (fast-forward) button (40),
(54)
▷ PLAY button (40), (54)
■ STOP button (40), (56)
⏸ PAUSE button (40), (56)

* FASTTEXT buttons (*for TV*)

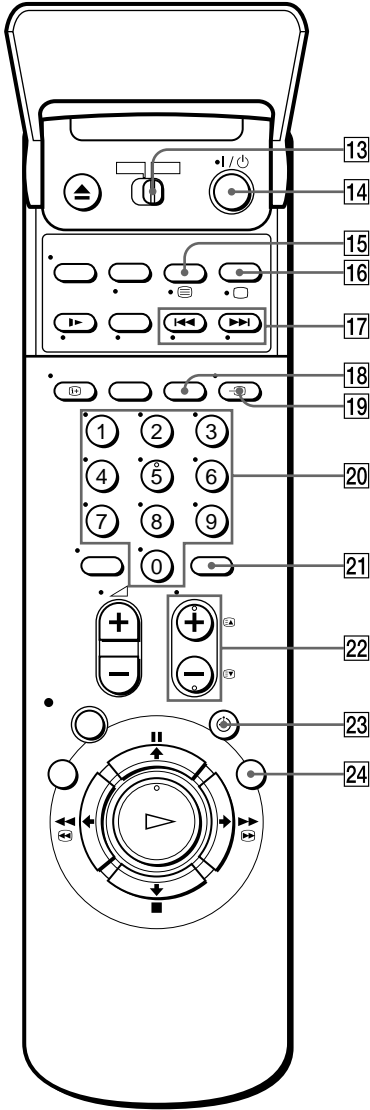

- 13 TV/VIDEO remote control switch (5)
 - 14 I/⏻ (on/standby) button (6), (51)
 - 15 COUNTER/REMAIN button (44)
⊞ (Teletext) button (for TV) (6)
 - 16 AUDIO DUB button (79)
□ TV power on/TV mode select button (for TV) (6)
 - 17 ◀◀/▶▶ INDEX SEARCH buttons* (63)
 - 18 CLEAR button (39), (46), (59)
 - 19 ↶ TV/VIDEO button (6)
 - 20 Programme number buttons (6)
 - 21 STB button (27)
 - 22 PROG (programme) +/- buttons (6), (25) (43)
⊞/⊟ Teletext page access buttons (for TV) (7)
 - 23 ⏸ TIMER button (46), (51)
 - 24 SMART SEARCH button (70)
- * FASTEXT buttons (for TV)

Menu chart

This VCR is equipped with an on-screen indication system which allows you a visual, quick and easy selection of the different menus. For a total view of all the menus, please refer to the following chart.

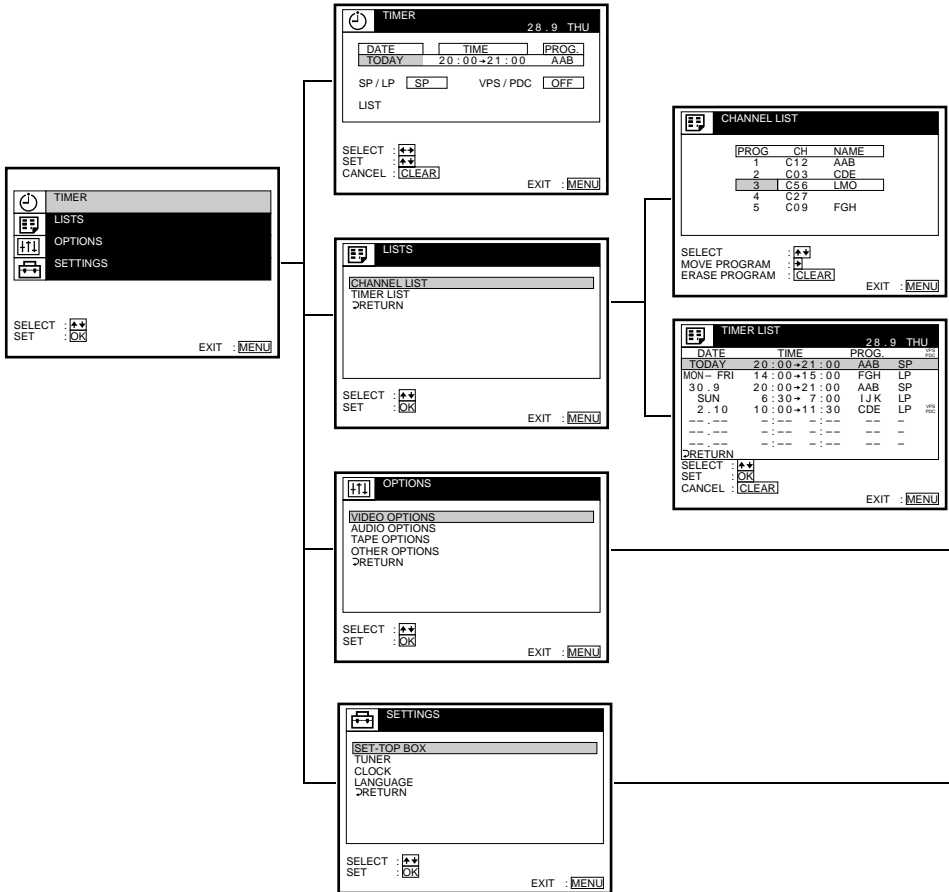

VIDEO OPTIONS

OPC	ON
EDIT	OFF
SHARPNESS	NORMAL
RR	NORMAL
RETURN	

SELECT : **▲▼**
 SET : **OK** EXIT : **MENU**

AUDIO OPTIONS

AUDIO MIX	OFF
HIFI AUDIO	NIGAM
RETURN	

SELECT : **▲▼**
 SET : **OK** EXIT : **MENU**

TAPE OPTIONS

AUTO LONG PLAY	OFF
TAPE LENGTH	E180
RETURN	

SELECT : **▲▼**
 SET : **OK** EXIT : **MENU**

OTHER OPTIONS

BUZZER	ON
DIMMER	OFF
POWER SAVE	OFF
TIMER OPTIONS	VARIABLE
TV DIRECT REC	ON
RETURN	

SELECT : **▲▼**
 SET : **OK** EXIT : **MENU**

SET - TOP BOX

STB CONNECTION	RF
TUNER BRAND NO.	1 2 3
PROGRAMME NO.	0 6
RETURN	

SELECT : **▲▼**
 SET : **OK** EXIT : **MENU**

TUNER PROG. 1

CHANNEL SET	C 1 2 AAB
AFT	ON
FINE TUNING	
RETURN	

SELECT : **▲▼**
 SET : **OK** EXIT : **MENU**

CLOCK

AUTO ADJUST	
CLOCK PROGRAM	1 AAB
MANUAL ADJUST	
28 . 9 . 2000 THU 18 : 00	

SELECT : **▲▼**
 CONFIRM : **OK** EXIT : **MENU**

LANGUAGE

ENGLISH	NEDERLANDS
DEUTSCH	DANSKNORSK
FRANCAIS	SVENSKA
ITALIANO	SUOMI
ESPAÑOL	EAAHNIKA
PORTUGUÉS	TURKÇE

SELECT : **▲▼**
 SET : **OK** EXIT : **MENU**

Additional Information

Index

A

- Accessories supplied 4
- Adjusting
 - picture 33, 71
 - tracking 71
- AFT (Auto Fine Tuning) 33, 68
- Audio track 66
- Auto Clock set 21
- Auto Set Up 18

C

- Changing the programme position 36
- Clock setting 19
- Colour system
 - compatible colour systems 2
 - setting 44
- Connecting
 - the VCR to the TV with a EURO-AV (Scart) connector 9
 - the VCR to the TV with an aerial cable only 12
 - to a Set - Top Box 13
 - to a stereo system 14
- Counter 44

D

- Disabling the programme positions 38
- Dubbing. *see* Editing

E

- Editing 76
- EP mode 44
- EURO-AV connection 9

H

- Hi-fi audio track 66

I

- Index Search 70

L

- Language selecting 30
- LP mode 47

M

- Menu options 73
- Monitoring

- during playback 65
- during recording 65

N

- NICAM broadcasts 65
- Normal audio track 66

O

- OPC (Optimum Picture Control) 71

P

- PDC (Programme Delivery Control) 53
- Personal code 40
- Picture adjustment. *See* Adjusting
- Playback 43
 - at various speeds 44, 58
 - selecting the sound 65
 - slow motion 58
- Power save 75
- Presetting channels 31

R

- Recording 46
 - bilingual programmes 65
 - saving 48
 - using the VIDEO Plus + system 50
 - what you are watching on the TV 49
 - while watching another programme 48
- Remote commander 5
- RF channel 15, 17
- RR (Reality Regenerator) 71

S

- Safety tab 48
- Searching
 - at various speeds 58
 - using the index function 70
 - using the Smart Search function 67
- Set - Top Box
 - connecting 13
 - line through 13
 - setting 23
- SMARTLINK 11
 - Automatic Power Off 11

- connection 9
- NexTVView Download 11
- One Touch Menu 11
- One Touch Play 11, 45
- One Touch Timer 11
- Preset Download 11
- TV Direct Rec 11, 49
- SP mode 47
- Station name
 - changing 34
 - setting 34
- Synchronized Recording 61

T

- Timer recording 50, 55
 - overlapping timer recording 64
 - using the VIDEO Plus + system 50
- Timer setting
 - cancelling 63
 - changing 63
 - checking 63
 - daily/weekly recording 53, 57
- Tracking adjustment. *See* Adjusting

V

- VPS (Video Programme System) 53

Sony  line

<http://www.world.sony.com/>