

Video Cassette Recorder

Operating Instructions



SHOWVIEW

SLV-SE40EG

WARNING

To prevent fire or shock hazard, do not expose the unit to rain or moisture.

To avoid electrical shock, do not open the cabinet. Refer servicing to qualified personnel only.

Mains lead must only be changed at a qualified service shop.

Precautions

Safety

- This unit operates on 220 – 240 V AC, 50 Hz. Check that the unit's operating voltage is identical with your local power supply.
- If anything falls into the cabinet, unplug the unit and have it checked by qualified personnel before operating it any further.
- The unit is not disconnected from the mains as long as it is connected to the mains, even if the unit itself has been turned off.
- Unplug the unit from the wall outlet if you do not intend to use it for an extended period of time. To disconnect the cord, pull it out by the plug, never by the cord.

Installing

- Allow adequate air circulation to prevent internal heat buildup.
- Do not place the unit on surfaces (rugs, blankets, etc.) or near materials (curtains, draperies) that may block the ventilation slots.
- Do not install the unit near heat sources such as radiators or air ducts, or in a place subject to direct sunlight, excessive dust, mechanical vibration or shock.
- Do not install the unit in an inclined position. It is designed to be operated in a horizontal position only.
- Keep the unit and cassettes away from equipment with strong magnets, such as microwave ovens or large loudspeakers.
- Do not place heavy objects on the unit.
- If the unit is brought directly from a cold to a warm location, moisture may condense inside the VCR and cause damage to the video head and tape. When you first install the unit, or when you move it from a cold to a warm location, wait for about three hours before operating the unit.

Caution

Television programmes, films, video tapes and other materials may be copyrighted. Unauthorized recording of such material may be contrary to the provisions of the copyright laws. Also, use of this recorder with cable television transmission may require authorization from the cable television transmitter and/or programme owner.

Compatible colour systems

This VCR is designed to record using the PAL (B/G or D/K) or MESECAM (B/G or D/K) colour system and play back using the PAL (B/G or D/K), MESECAM (B/G or D/K), and NTSC 4.43 colour systems.

Table of contents

Getting Started

- 4 Step 1: Unpacking
- 5 Step 2: Setting up the remote commander
- 8 Step 3: Connecting the VCR
- 12 Step 4: Tuning your TV to the VCR
- 14 Step 5: Setting up the VCR with the Auto Set Up function
- 16 Step 6: Setting the clock
- 21 Selecting a language
- 22 Presetting channels
- 26 Changing/disabling programme positions

Basic Operations

- 32 Playing a tape
- 35 Recording TV programmes
- 40 Recording TV programmes using the ShowView system*
- 44 Setting the timer manually

Additional Information

- 62 Troubleshooting
- 65 Specifications
- 66 Index to parts and controls
- Back cover
- Index

Additional Operations

- 47 Playing/searching at various speeds
- 49 Setting the recording duration time
- 50 Checking/changing/cancelling timer settings
- 52 Searching using the Smart Search function
- 55 Adjusting the picture
- 57 Changing menu options
- 60 Editing with another VCR

* ShowView is a trademark applied for by Gemstar Development Corp. ShowView system is manufactured under license from Gemstar Development Corporation.

Step 1

Unpacking

Check that you have received the following items with the VCR:

- Remote commander

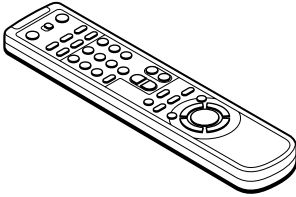

- Aerial cable

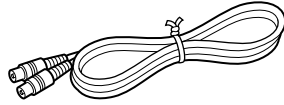

- R6 (size AA) batteries

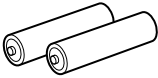

Step 2

Setting up the remote commander

Inserting the batteries

Insert two R6 (size AA) batteries by matching the + and - on the batteries to the diagram inside the battery compartment.

Insert the negative (-) end first, then push in and down until the positive (+) end clicks into position.

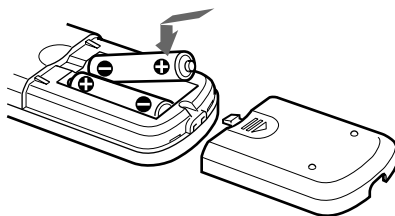

Using the remote commander

You can use this remote commander to operate this VCR and a Sony TV. Buttons on the remote commander marked with a dot (•) can be used to operate your Sony TV. If the TV does not have the  symbol near the remote sensor, this remote commander will not operate the TV.

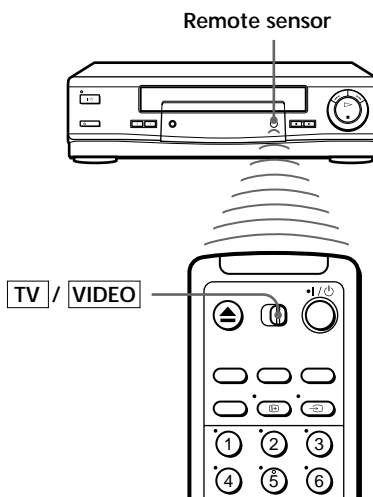

To operate	Set TV / VIDEO to
the VCR	VIDEO and point at the remote sensor on the VCR
a Sony TV	TV and point at the remote sensor on the TV

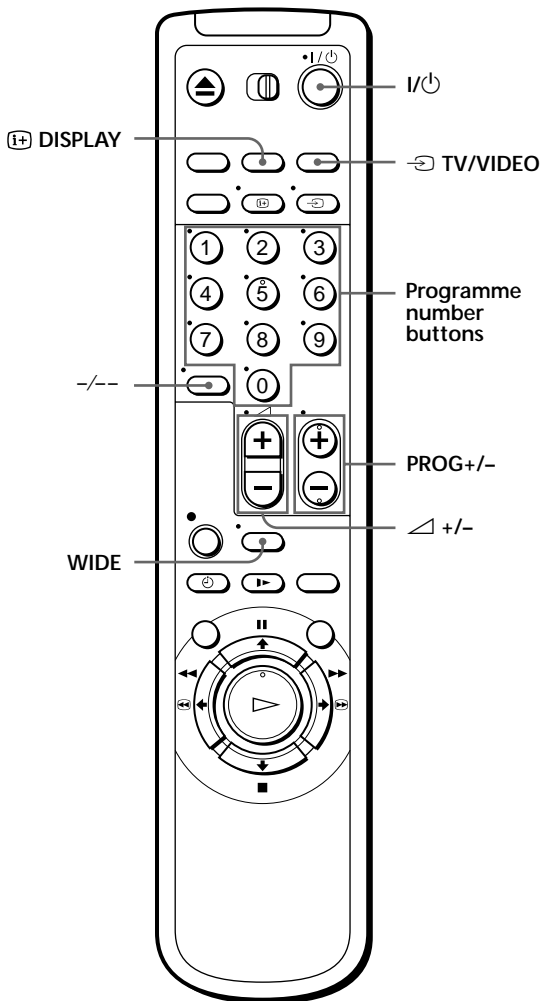

continued

Step 2 : Setting up the remote commander (continued)



TV control buttons

To	Press
Turn the TV into standby mode	I/Power
Select an input source of the TV either from aerial in or from line in	TV/VIDEO
Select the programme position of the TV	Programme number buttons, ---/---, PROG +/-

To	Press
Adjust the volume of the TV	
Call up on-screen display	
Switch to/from wide mode of a Sony wide TV.	WIDE

Notes

- With normal use, the batteries should last about three to six months.
- If you do not use the remote commander for an extended period of time, remove the batteries to avoid possible damage from battery leakage.
- Do not use a new battery with an old one together.
- Do not use different types of batteries together.
- Some buttons may not work with certain Sony TVs.

Step 3

Connecting the VCR

If your TV has a EURO-AV connector, see page 9.

If your TV does not have a EURO-AV (Scart) connector

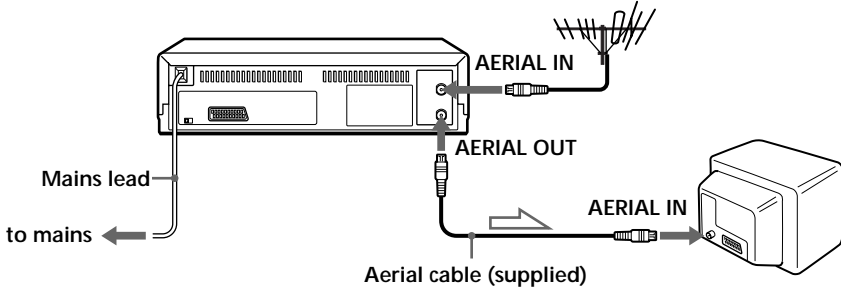

: Signal flow

1

Disconnect the aerial cable from your TV and connect it to AERIAL IN on the rear panel of the VCR.

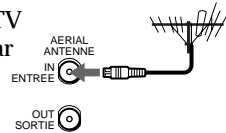

2

Connect AERIAL OUT of the VCR and the aerial input of your TV using the supplied aerial cable.

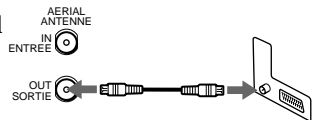

3

Connect the mains lead to the mains.

Note

- When you connect the VCR and your TV only with an aerial cable, you have to set RF MODULATOR in the OPTIONS-2 menu to ON (initial setting) (see page 59).

If your TV has a EURO-AV (Scart) connector

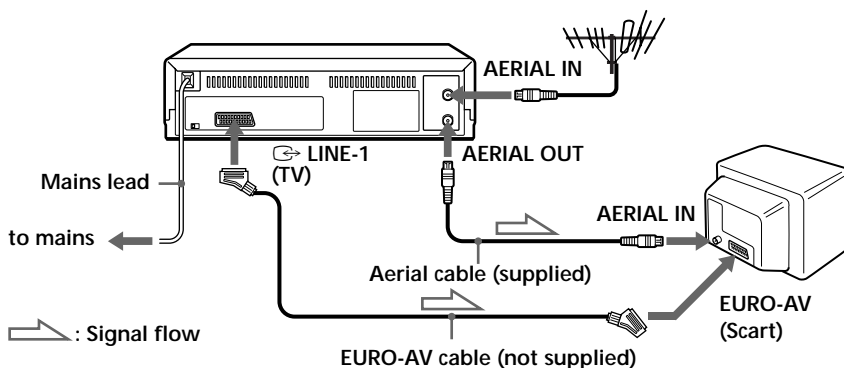

1

Disconnect the aerial cable from your TV and connect it to AERIAL IN on the rear panel of the VCR.

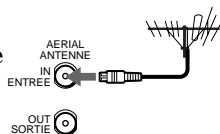

2

Connect AERIAL OUT of the VCR and the aerial input of your TV using the supplied aerial cable.

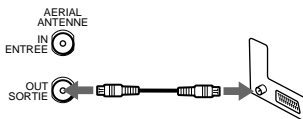

continued

Step 3 : Connecting the VCR (continued)

3

Connect LINE-1 (TV) on the VCR and the EURO-AV (Scart) connector on the TV with the optional EURO-AV cable.

This connection improves picture and sound quality. Whenever you want to watch the VCR picture, press \rightarrow TV/VIDEO to display the VIDEO indicator in the display window.

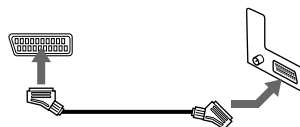

4

Connect the mains lead to the mains.

Note

- If the TV is connected to the LINE-1 (TV) connector, setting the RF MODULATOR in the OPTIONS-2 menu to OFF is recommended. In the OFF position, only the signal from the aerial is output through the AERIAL OUT connector (see page 59). You do not have to tune your TV to the VCR. Skip “Tuning your TV to the VCR” on page 12.

About the SMARTLINK features

If the connected TV complies with SMARTLINK, MEGALOGIC¹, EASYLINK², Q-Link³, or EURO VIEW LINK⁴, you can use the SMARTLINK

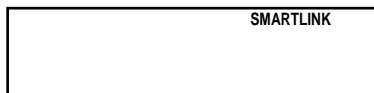

function after you complete the steps on the previous page (the SMARTLINK indicator appears in the VCR's display window when you turn on the TV). You can enjoy the following SMARTLINK features.

• Preset Download

You can download your TV tuner preset data to this VCR and tune the VCR according to that data in Auto Set Up. This greatly simplifies the Auto Set Up procedure. Be careful, not to disconnect the cables or exit the Auto Set Up function during the procedure.

See “Setting up the VCR with the Auto Set Up function” on page 14.

- **TV Direct Rec**
You can easily record what you are watching on the TV (other than tapes being played on this VCR). For details, see “Recording what you are watching on the TV (TV Direct Rec)” on page 39.
- **One Touch Play**
With One Touch Play, you can start playback automatically without turning on the TV. For details, see “Starting playback automatically with one button (One Touch Play)” on page 34.
- **One Touch Menu**
You can turn on the VCR and TV, set the TV to the video channel, and display the VCR’s on-screen display automatically by pressing MENU on the remote commander.
- **One Touch Timer**
You can turn on the VCR and TV, set the TV to the video channel, and display the timer recording menu (the TIMER METHOD menu, the TIMER menu, or the SHOWVIEW menu) automatically by pressing ⊖ TIMER on the remote commander. You can set which timer recording menu is displayed using TIMER OPTIONS in the OPTIONS-2 menu (see page 59).
- **Automatic Power Off**
You can have the VCR turn off automatically, if the VCR is not used after you turn off the TV.

*1 “MEGALOGIC” is a registered trademark of Grundig Corporation.

*2 “EASYLINK” is a trademark of Philips Corporation.

*3 “Q-Link” is a trademark of Panasonic Corporation.

*4 “EURO VIEW LINK” is a trademark of Toshiba Corporation.

Note

- Not all the TVs respond to the functions above.

Step 4

Tuning your TV to the VCR

If you have connected the VCR to your TV using the EURO-AV cable, skip this step.

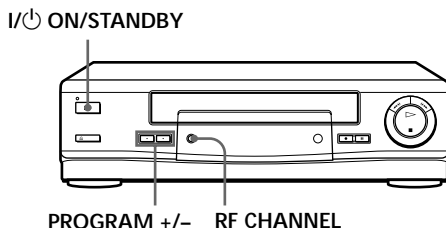

-
- 1**  Press I/ON/STANDBY to turn on the VCR.

-
- 2**  Press RF CHANNEL on the VCR lightly.
The factory-preset RF channel appears in the display window.
The VCR signal is output through this channel to the TV.

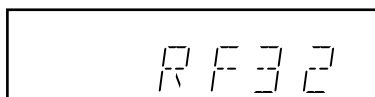

-
- 3** Turn on your TV and select a programme position for the VCR picture.
This programme position will now be referred to as the video channel.

-
- 4**  Press RF CHANNEL.
The TV system appears in the display window.

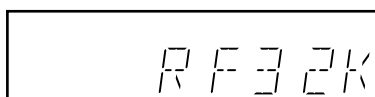

- 5**  Press PROGRAM +/- (repeatedly) to select the appropriate TV system for your area. Select “G” for the B/G TV system, or “K” for the D/K TV system.

- 6** Tune the TV to the same channel as that shown in the display window so that the picture on the right appears clearly on the TV screen.

Refer to your TV manual for tuning instructions.

If you select the wrong TV system in step 5, the picture on the right may not appear. Select the appropriate TV system and tune the TV again.

If the picture does not appear clearly, see “To obtain a clear picture from the VCR” below.



- 7**  Press RF CHANNEL.

You have now tuned your TV to the VCR. Whenever you want to play a tape, set the TV to the video channel.

To check to see if the TV tuning is correct

Set the TV to the video channel and press PROGRAM +/- on the VCR. If the TV screen changes to a different programme each time you press PROGRAM +/-, the TV tuning is correct.

To obtain a clear picture from the VCR

If the screen does not appear clearly in step 6 above, go to step 7 to finish this procedure once. Then start again from step 2. After pressing RF CHANNEL, press PROGRAM +/- while the RF channel is displayed, so that another RF channel appears. Then tune the TV to the new RF channel until a clear picture appears.

Note

- If you set the wrong TV system, you may have no sound or sound may be distorted.

Step 5

Setting up the VCR with the Auto Set Up function

Before using the VCR for the first time, set up the VCR using the Auto Set Up function. With this function, you can set the language for the on-screen display, TV channels, guide channels for the ShowView system.

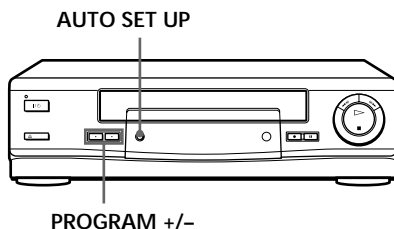

1

AUTO
SET UP



Hold down AUTO SET UP on the VCR for more than three seconds. The VCR automatically turns on, and the country abbreviation appears in the display window.

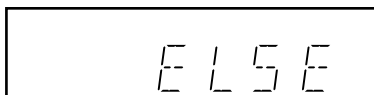

2

-PROGRAM +



Press PROGRAM +/- to select the abbreviation of your country. For some countries, there is a selection of languages to choose from. The abbreviations of the countries and languages are as follows:

Abbreviation	Country	Language
CZ	Checho	Czech
H	Hungary	Hungarian
PL	Poland	Polish
RU	Russia	Russian
ELSE	Other countries	English

If your country does not appear, select ELSE.

3AUTO
SET UP

Press AUTO SET UP lightly.

The VCR starts searching for all of the receivable channels and presets them according to the TV system you selected in “Tuning your TV to the VCR.”



If you use the SMARTLINK connection, the Preset Download function starts and the SMARTLINK indicator flashes in the display window during download.

After the search or download is complete, the current time appears in the display window for any stations that transmit a time signal.

To cancel the Auto Set Up function

Press AUTO SET UP.

Tip

- If you want to change the language for the on-screen display from the one preset in the Auto Set Up function, see page 21.

Note

- Do not cancel the Auto Set Up function during step 3. If you do, repeat the steps above.

Step 6

Setting the clock

You must set the time and date on the VCR to use the timer recording features properly.

The Auto Clock Set function works only if a station in your area is broadcasting a time signal. If the Auto Set Up function did not set the clock correctly for your local area, try another station for the Auto Clock Set function.

Setting the clock manually

Before you start...

- Turn on the VCR and the TV.
- Set the TV to the video channel.

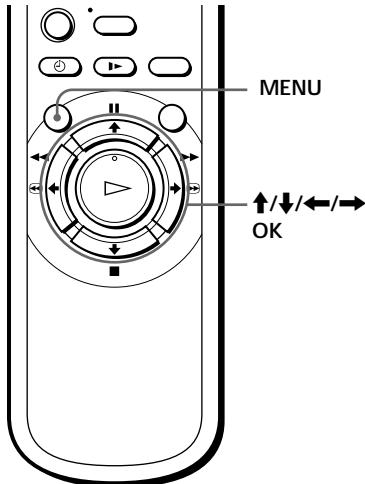

1

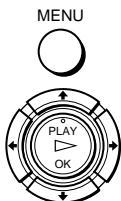

Press MENU, then press \uparrow/\downarrow to highlight SETTINGS and press OK.

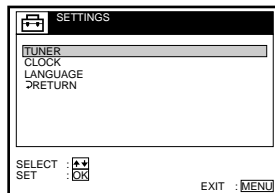

2



Press \uparrow/\downarrow to highlight CLOCK, then press OK.

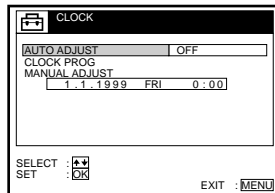

3



Press **↑/↓** to highlight **MANUAL ADJUST**, then press **OK**.

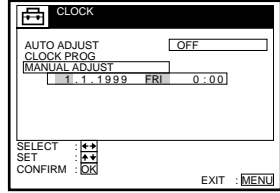

4



Press **↑/↓** to set the date.

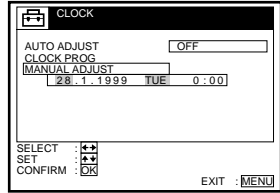

5



Press **→** to highlight the month and set the month pressing **↑/↓**.

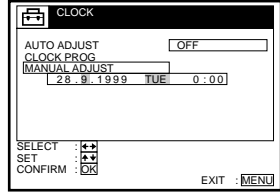

6



Set the year, hour, and minutes in sequence, pressing **→** to highlight the item to be set, and press **↑/↓** to select the digits.

The day of the week is set automatically.

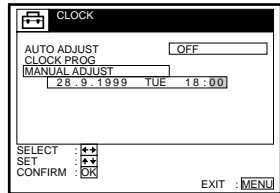

continued

Step 6 : Setting the clock (continued)

7



Press OK to start the clock.

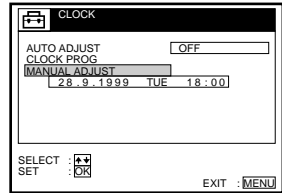

8

MENU



Press MENU to exit the menu.

Tips

- To change the digits during setting, press **←** to return to the item to be changed, and select the digits pressing **↑/↓**.
- If you want to return to the previous menu, highlight RETURN and press OK.

Note

- The menu disappears automatically if you don't proceed for more than a few minutes.

Changing the station for the Auto Clock Set function

Before you start...

- Turn on the VCR and the TV.
- Set the TV to the video channel.

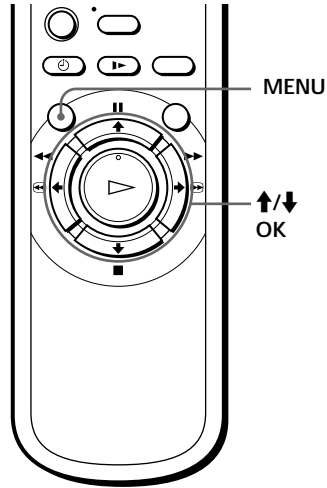

- 1** Press MENU, then press **↑/↓** to highlight SETTINGS and press OK.

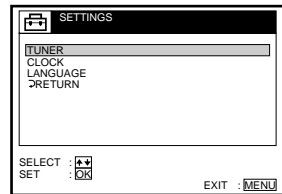
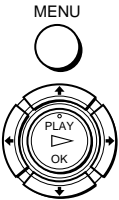

- 2** Press **↑/↓** to highlight CLOCK, then press OK. AUTO ADJUST is highlighted.

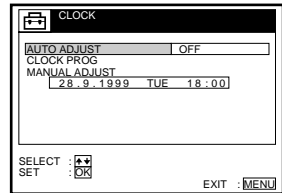

- 3** Press OK.

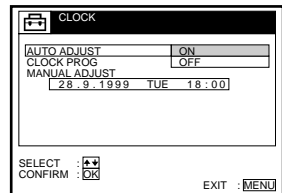

continued

Step 6 : Setting the clock (continued)

4



Press \uparrow/\downarrow to highlight ON, then press OK.

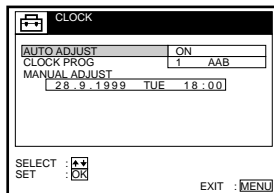

5



Press \downarrow to highlight CLOCK PROG, then press OK.

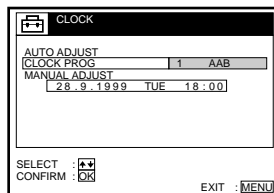

6



Press \uparrow/\downarrow repeatedly until the programme position of the station that carries the time signal appears.

If the VCR does not receive the time signal from any station, AUTO ADJUST returns to OFF automatically.

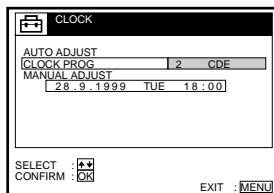

7



Press MENU to exit the menu.

Tips

- If you set AUTO ADJUST to ON, the Auto Clock Set function is activated whenever the VCR is turned off. The time is adjusted automatically by making reference to the time signal from the station whose programme position is displayed in the "CLOCK PROG" row.

If you do not need the Auto Clock Set, select OFF.

- If you want to return to the previous menu, highlight RETURN and press OK.

Note

- The menu disappears automatically if you don't proceed for more than a few minutes.

Selecting a language

You can change the on-screen display language from the one you selected with the Auto Set Up function.

Before you start...

- Turn on the VCR and the TV.
- Set the TV to the video channel.

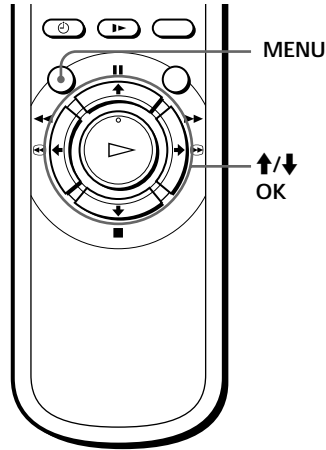

- 1** Press MENU, then press ↑/↓ to highlight SETTINGS and press OK.

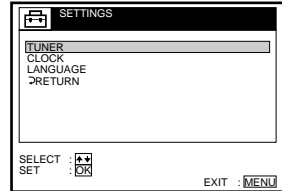
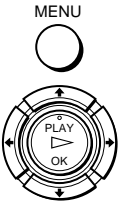

- 2** Press ↑/↓ to highlight LANGUAGE, then press OK.



- 3** Press ↑/↓ to highlight the desired language, then press OK.



- 4** Press MENU to exit the menu.



Tip

- If you want to return to the previous menu, highlight RETURN and press OK.

Note

- The menu disappears automatically if you don't proceed for more than a few minutes.

Presetting channels

If some channels could not be preset using the Auto Set Up function, you can preset them manually.

Before you start...

- Turn on the VCR and the TV.
- Set the TV to the video channel.

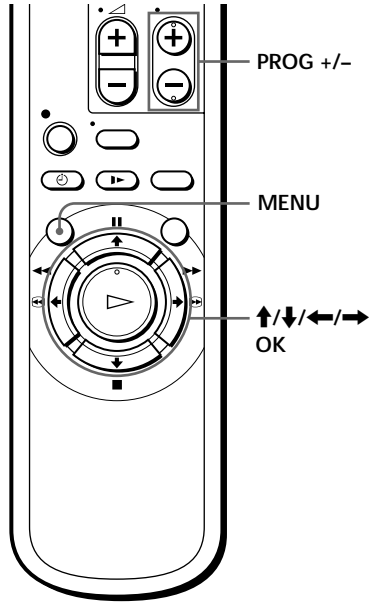

1

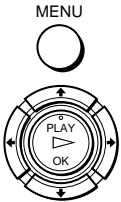

Press MENU, then press **↑/↓** to highlight SETTINGS and press OK.

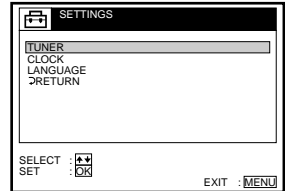

2



Press **↑/↓** to highlight TUNER, then press OK.

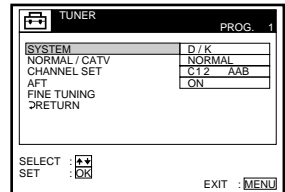

3



Press **↑/↓** to highlight NORMAL/
CATV, then press OK.

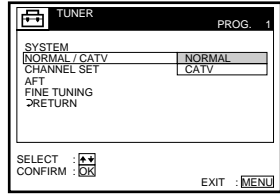

4



Press **↑/↓** to highlight NORMAL, then
press OK.

To preset CATV (Cable Television)
channels, select CATV.

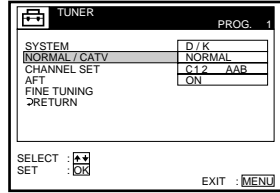

5

• PROG



Press PROG +/- to select the programme
position.

Selected programme
position

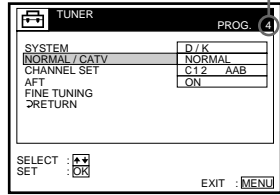

6



Press **↑/↓** to highlight CHANNEL SET,
then press OK.

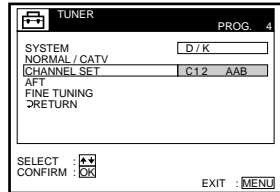

continued

Presetting channels (continued)

7



Press \uparrow/\downarrow repeatedly until the channel you want is displayed.
The channels appear in the following order:

B/G TV system		D/K TV system	
Channel number in the CHANNEL SET field	Receivable Channel	Channel number in the CHANNEL SET field	Receivable Channel
C02	E2	C02	R1
C03	E3	C05	R6
C04	E4	C06	R7
C05	E5	C12	R12
C06	E6	C13	R2
C07	E7	C14	R3
C08	E8	C15	R4
C09	E9	C16	R5
C10	E10	C17	R8
C11	E11	C18	R9
C12	E12	C19	R10
C21-C69	E21-E69	C20	R11
S01-S41	S1-S41	C21-C69	R21-R69
S42-S46	S01-S05		

If you know the number of the channel you want, press the programme number buttons. For example, for channel 5, first press "0" and then press "5."

8



If the TV sound is distorted or noisy, press \uparrow/\downarrow to highlight SYSTEM and press OK. Then press \uparrow/\downarrow to select B/G or D/K so that you get the better sound.

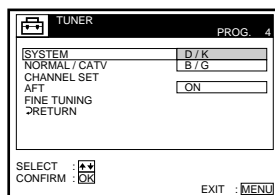

9

To allocate another channel to another programme position, repeat steps 5 to 8.

10



Press MENU to exit the menu.

Disabling unwanted programme positions

After presetting channels, you can disable unused programme positions. The disabled positions will be skipped later when you press the PROG +/- buttons.

- 1 In step 7 above, press programme number button “0” twice to display the number “00” beside CHANNEL SET.
- 2 Press MENU to exit the menu.

If the picture is not clear

Normally, the Auto Fine Tuning (AFT) function automatically tunes in channels clearly. If, however, the picture is not clear, you may also use the manual tuning function.

- 1 Press PROG +/- or the programme number buttons to select the programme position for which you cannot obtain a clear picture.
- 2 Press MENU, then select SETTINGS and press OK.
- 3 Select TUNER, then press OK.
- 4 Select FINE TUNING, then press OK.

The fine tuning meter appears.

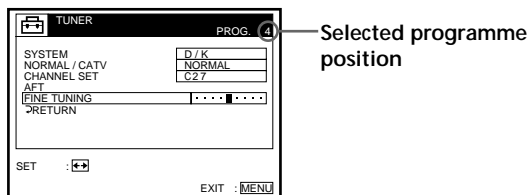

- 5 Press ←/→ to get a clearer picture, then press MENU to exit the menu.

Note that the AFT (Auto Fine Tuning) setting switches to OFF.

Tip

- If you want to return to the previous menu, highlight RETURN and press OK.

Note

- The menu disappears automatically if you don't proceed for more than a few minutes.

Changing/ disabling programme positions

After setting the channels, you can change the programme positions and station names as you like. If any programme positions are unused or contain unwanted channels, you can disable them.

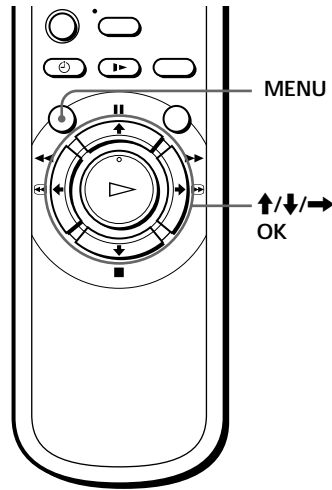

Changing programme positions

Before you start...

- Turn on the VCR and the TV.
- Set the TV to the video channel.

1

MENU



Press MENU, then press **↑/↓** to highlight **LISTS** and press OK.

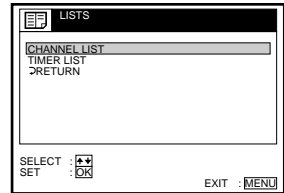

2



Press **↑/↓** to highlight **CHANNEL LIST**, then press OK.

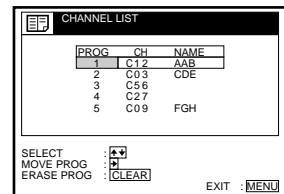

3



Press **↑/↓** to highlight the row on which you want to change the programme position, then press **→**.

To display other pages for programme positions 6 to 60, press **↑/↓** repeatedly.

CHANNEL LIST		
PROG	CH	NAME
1	C12	AAB
2	C03	CDE
3	C56	
4	C27	
5	C09	FGH

SELECT **↑/↓**
 SET STATION NAME **→**
 CONFIRM **OK** EXIT : **MENU**

4



Press **↑/↓** until the selected channel row moves to the desired programme position.

The selected channel is inserted at the new programme position and the intermediate channels are displaced to fill the gap.

CHANNEL LIST		
PROG	CH	NAME
1	C03	CDE
2	C56	
3	C12	AAB
4	C27	
5	C09	FGH

SELECT **↑/↓**
 SET STATION NAME **→**
 CONFIRM **OK** EXIT : **MENU**

5



Press **OK** to confirm the setting.

6

To change the programme position of another station, repeat steps 3 to 5.

7



Press **MENU** to exit the menu.

Tip

- If you want to return to the previous menu, highlight **RETURN** and press **OK**.

Note

- The menu disappears automatically if you don't proceed for more than a few minutes.

continued

Changing/disabling programme positions (continued)

Changing the station names

You can change the station names (up to 5 characters).

Before you start...

- Turn on the VCR and the TV.
- Set the TV to the video channel.

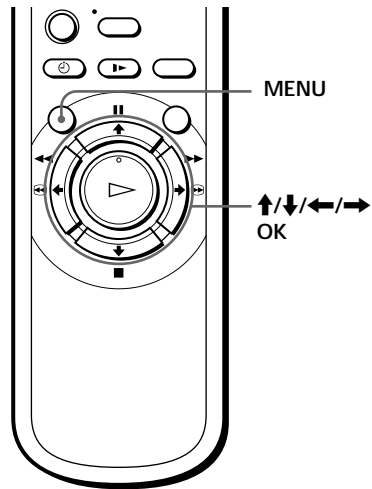

1

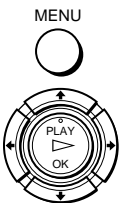

Press MENU, then press \uparrow/\downarrow to highlight LISTS and press OK.

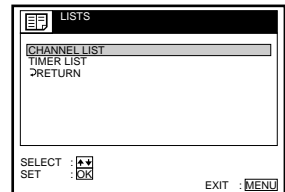

2



Press \uparrow/\downarrow to highlight CHANNEL LIST, then press OK.

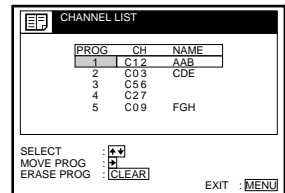

3



Press \uparrow/\downarrow to highlight the row on which you want to change the station name, then press \rightarrow .

To display other pages for programme positions 6 to 60, press \uparrow/\downarrow repeatedly.

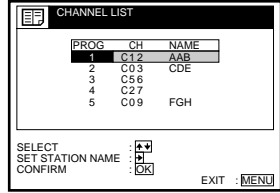

4

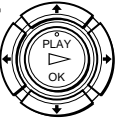

Press \rightarrow .

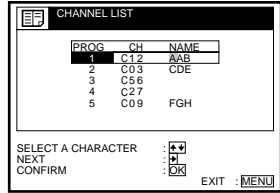

5



Enter the station name.

1 Press \uparrow/\downarrow to select a character.

Each time you press \uparrow , the character changes as shown below.

A \rightarrow B \rightarrow ... \rightarrow Z \rightarrow a \rightarrow b \rightarrow ... \rightarrow z
 \rightarrow 0 \rightarrow 1 \rightarrow ... \rightarrow 9 \rightarrow (symbols) \rightarrow
 (blank space) \rightarrow A

2 Press \rightarrow to set the next character.

The next space is highlighted.

To correct a character, press \leftarrow/\rightarrow until the character you want to correct is highlighted then reset it.

You can set up to 5 characters for the station name.

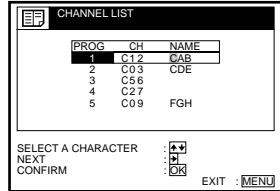

6



Press OK to confirm the new name.

7



Press MENU to exit the menu.

Tip

- If you want to return to the previous menu, highlight RETURN and press OK.

Note

- The menu disappears automatically if you don't proceed for more than a few minutes.

continued

Changing/disabling programme positions (continued)

Disabling unwanted programme positions

After presetting channels, you can disable unused programme positions. The disabled positions will be skipped later when you press the PROG +/- buttons.

Before you start...

- Turn on the VCR and the TV.
- Set the TV to the video channel.

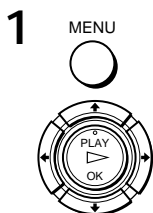
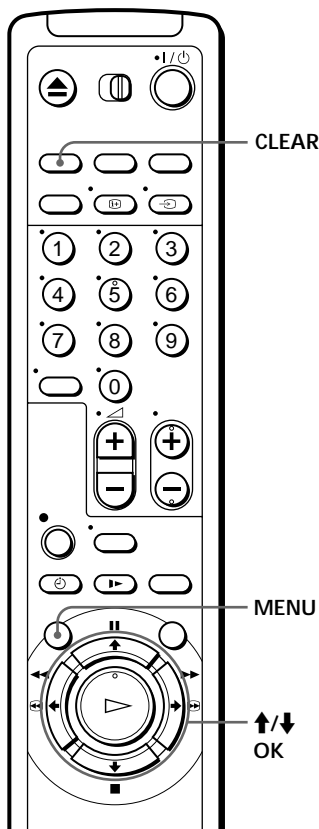

Press MENU, then press **↑/↓** to highlight **LISTS**, and press OK.

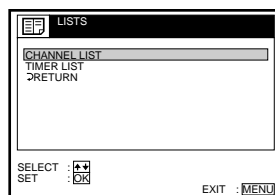

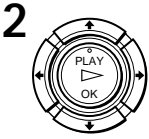

Press **↑/↓** to highlight CHANNEL LIST, then press OK.

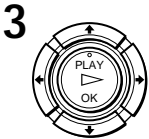
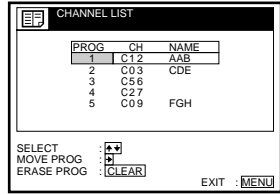

Press **↑/↓** to highlight the row on which you want to disable.

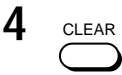
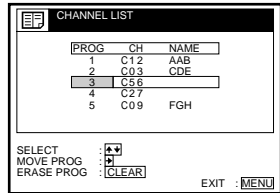

Press CLEAR.

The selected row will be cleared as shown on the right.

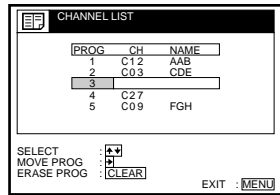

5

Repeat steps 3 and 4 for any other programme positions you want to disable.



Press MENU to exit the menu.

Tip

- If you want to return to the previous menu, highlight RETURN and press OK.

Notes

- The menu disappears automatically if you don't proceed for more than a few minutes.
- Be sure to select the programme position you want to disable correctly. If you disable a programme position by mistake, you need to reset that channel manually.

Playing a tape

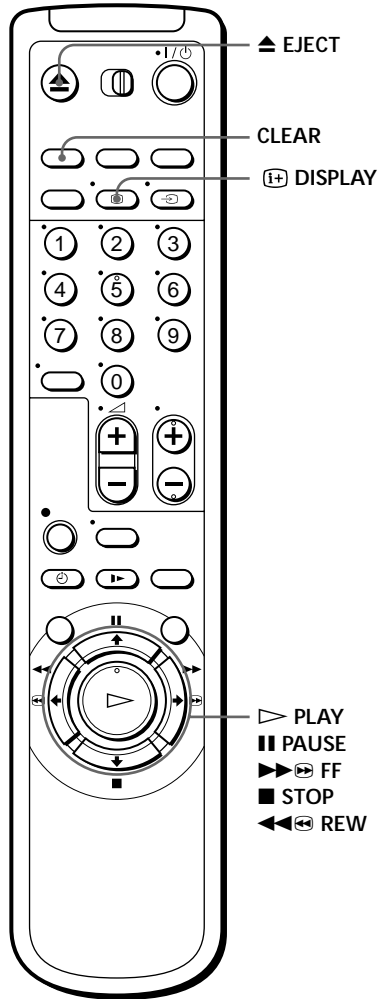
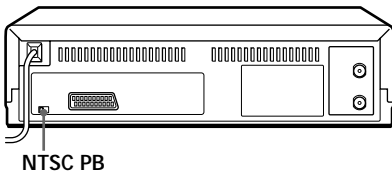

1 Turn on your TV and set it to the video channel.

2 Insert a tape.
The VCR turns on and starts playing automatically if you insert a tape with its safety tab removed.

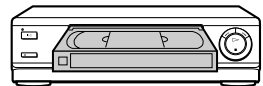

3



Press ▷ PLAY.

When the tape reaches the end, it will rewind automatically.

Additional tasks

To	Press
Stop play	■ STOP
Pause play	PAUSE
Resume play after pause	PAUSE or ▷ PLAY
Fast-forward the tape	▶▶ FF during stop
Rewind the tape	◀◀ REW during stop
Eject the tape	▲ EJECT

To set the colour system

If the playback picture has no colour, or streaks appear during playback, set COLOUR SYSTEM in the OPTIONS-1 menu to conform to the system that the tape was recorded in (see page 58). (Normally set the option to AUTO.)

To play an NTSC-recorded tape

Set NTSC PB at the rear of the VCR according to the colour system of your TV.

When your TV is	Set NTSC PB to
PAL only	ON PAL TV
PAL and NTSC	NTSC 4.43

To use the time counter

At the point on the tape that you want to find later, press CLEAR. The counter in the display window resets to “0:00:00.” Search for the point afterwards by referring to the counter.



To display the counter on the TV screen, press (Ⓛ) DISPLAY.

continued

Playing a tape (continued)

Notes

- The counter resets to “0:00:00” whenever a tape is reinserted.
- The counter stops counting when it comes to a portion with no recording.
- The time counter does not appear on the TV screen when using an NTSC-recorded tape.
- Depending on your TV, the following may occur while playing an NTSC-recorded tape:
 - The picture becomes black and white.
 - The picture shakes.
 - No picture appears on the TV screen.
 - Black streaks appear horizontally on the TV screen.
 - The colour density increases or decreases.
- While setting the menu on the TV screen, buttons for playback on the remote commander do not function.

Starting playback automatically with one button (One Touch Play)

If you use the SMARTLINK connection, you can turn on the VCR and the TV, set the TV to the video channel, and start playback automatically with one button.

1 Insert a tape.

The VCR automatically turns on.

If you insert a tape with its safety tab removed, the TV turns on and switches to the video channel. Playback starts automatically.

2 Press \triangleright PLAY.

The TV turns on and switches to the video channel automatically. Playback starts.

Tip

- When there already is a tape in the VCR, the VCR and the TV turn on, the TV is set to the video channel, and playback starts automatically in one sequence when you press \triangleright PLAY.

Note

- When you use the One Touch Play function, leave the TV on or in the standby mode.

Recording TV programmes

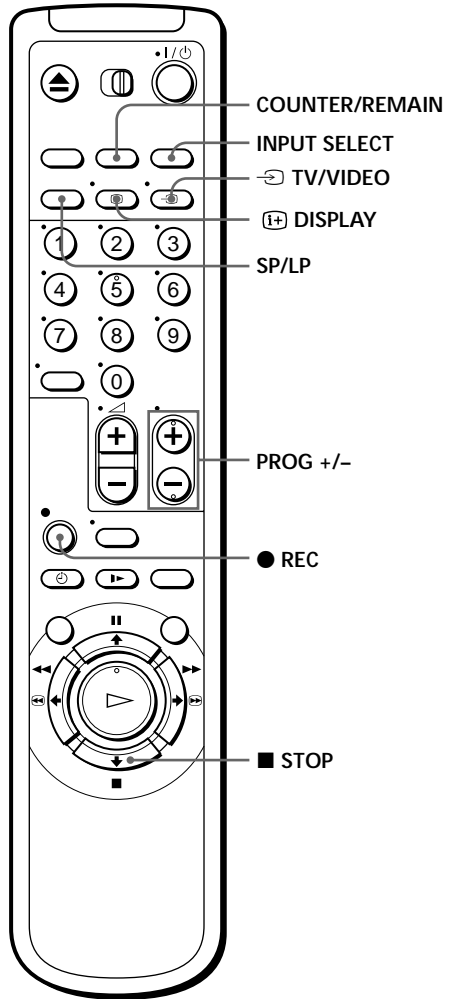



- 1 Turn on your TV and set it to the video channel.
- 2 Insert a tape with its safety tab in place.

continued

Recording TV programmes (continued)

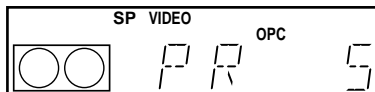
- 3**  Press INPUT SELECT until a programme position number appears in the display window.



- 4**  Press PROG +/- to select the programme position you want to record.

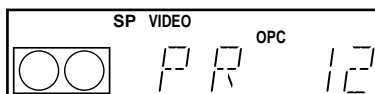

- 5**  Press SP/LP to select the tape speed, SP or LP.
LP (Long Play) provides recording time twice as long as SP, however, SP (Standard Play) produces better picture and audio quality.

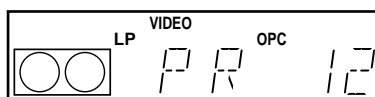

- 6**  Press ● REC to start recording.
The recording indicator lights up red in the display window.

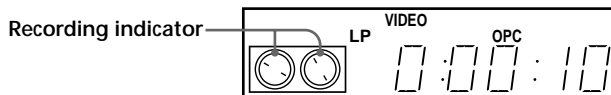

To stop recording

Press ■ STOP.

To check the remaining time

Press **[DISP]** DISPLAY. With the display on, press COUNTER/REMAIN to check the remaining time. Each time you press COUNTER/REMAIN, the time counter and the remaining time appear alternately. The remaining time with the  indicator also appears in the display window.

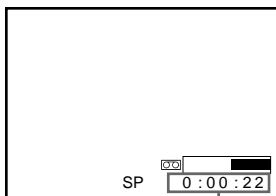

Time counter

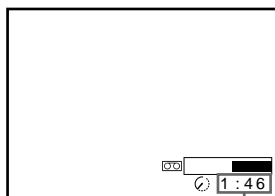

Remaining time

To correctly check the remaining time of the tape, set TAPE LENGTH in the OPTIONS-1 menu according to the tape type you use (see page 58).

To watch another TV programme while recording

- 1 Press **[TV/VIDEO]** TV/VIDEO to turn off the VIDEO indicator in the display window.
- 2 Select another programme position on the TV.

To save a recording

To prevent accidental erasure, break off the safety tab as illustrated. To record on a tape again, cover the tab hole with adhesive tape.

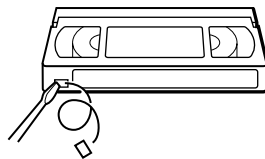

Safety tab

continued

Recording TV programmes (continued)

Tips

- To select a programme position, you can use the programme number buttons on the remote commander. For two-digit numbers, press the *-/--* (ten's digit) button followed by the programme number buttons.
- You can select a video source from the LINE-1 (TV) connector also using the INPUT SELECT button.
- The display appears on the TV screen indicating information about the tape, but the information won't be recorded on the tape.
- If you don't want to watch TV while recording, you can turn off the TV.

Notes

- The display does not appear during still (pause) mode or slow-motion playback.
- The display will not appear while playing an NTSC-recorded tape.
- If a tape has portions recorded in both PAL and NTSC systems, the time counter reading will not be correct. This discrepancy is due to the difference between the counting cycles of the two video systems.
- When you insert a non-standard commercially available tape, the remaining time may not be correct.
- The remaining time is intended for rough measurement only.
- About 30 seconds after the tape begins playback, the tape remaining time will be displayed.

Recording what you are watching on the TV (TV Direct Rec)

If you use the SMARTLINK connection, you can easily record what you are watching on the TV (other than tapes being played on the VCR).

- 1 Insert a tape with its safety tab in place.
- 2 Press ● REC while you are watching a TV programme or external source.

The VCR automatically turns on, then the TV indicator lights up and the VCR starts recording what you are watching on the TV.

Tips

- The TV indicator appears in the display window after you press ● REC in some situations such as:
 - when you are watching a source connected to the TV's line input, or
 - when the TV tuner preset data for the programme position is different from the data in the VCR tuner preset.
- If there is a tape with its safety tab in place in the VCR, the VCR automatically turns on and starts recording what you are watching on the TV when you press ● REC.
- You can turn the TV Direct Rec function ON and OFF in the OPTIONS-2 menu (see page 59).

Notes

- You cannot record what you are watching using this method when the VCR is in the following modes; pause, timer standby, tuner preset, Auto Set Up, and recording.
- When the TV indicator is lit in the display window, do not turn off the TV nor change the TV programme position. When the TV indicator is not lit, the VCR continues recording the programme even if you change the TV programme position on the TV.

Recording TV programmes using the ShowView system

The ShowView system is the feature that simplifies programming the VCR to make timer recording. Just enter the ShowView number listed in the TV programme guide. The date, times, and programme position of that programme are set automatically. You can preset up to eight programmes at a time.

Before you start...

- Check that the VCR clock is set to the correct time and date.
- Insert a tape with its safety tab in place. Make sure the tape is longer than the total recording time.
- Turn on your TV and set it to the video channel.
- Set **TIMER OPTIONS** to **SHOWVIEW** or **VARIABLE** in the **OPTIONS-2** menu (see page 59).

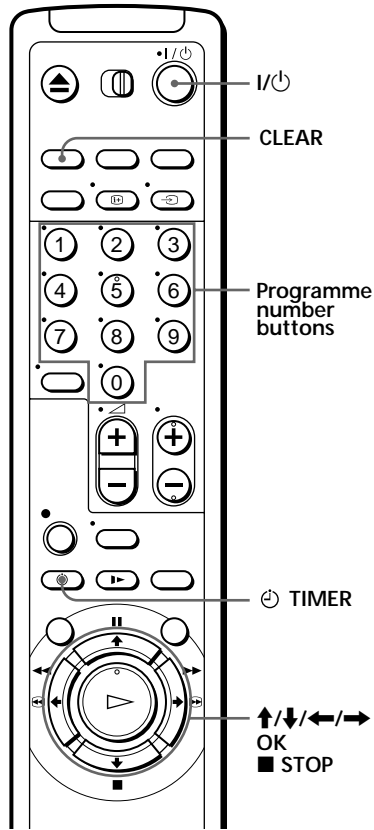

1



Press **TIMER**.

- When you set **TIMER OPTIONS** to **VARIABLE**

The **TIMER METHOD** menu appears on the TV screen. Press **↑/↓** to select **SHOWVIEW**, then press **OK**.

- When you set **TIMER OPTIONS** to **SHOWVIEW**

The **SHOWVIEW** menu appears on the TV screen.

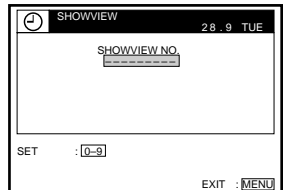
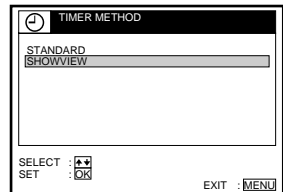

2

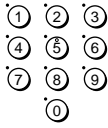

Press the programme number buttons to enter the ShowView number.
If you make a mistake, press CLEAR and re-enter the correct number.

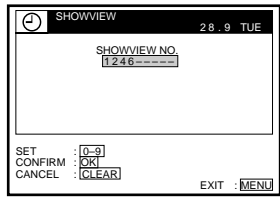

3



Press OK.
The date, start and stop times, programme position, tape speed, and VPS/PDC setting appear on the TV screen.

- If "--" appears in the "PROG." (programme) column (this may happen for local broadcasts), you have to set the appropriate programme position manually.

Press \uparrow / \downarrow to select the desired programme position.

To record from a decoder or other source connected to the LINE-1 (TV) connector, press INPUT SELECT to display "L1."

You will only have to do this operation once for the referred channel. The VCR will then store your setting.

The information is incorrect, press CLEAR.

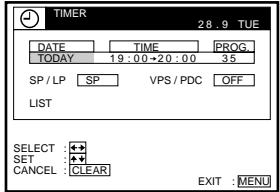

continued

Recording TV programmes using the ShowView system (continued)

4



If you want to change the date, tape speed, and the VPS/PDC function setting:

- 1 Press **←/→** to highlight the item you want to change.
- 2 Press **↑/↓** to reset it.

- To record the same programme every day or the same day every week, see “Daily/weekly recording” below.
- To use the VPS/PDC function, set VPS/PDC to ON. For details of the VPS/PDC function, see “Timer recording with VPS/PDC signals” on page 43.

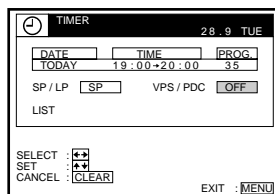

5



Press MENU to exit the menu.

6



Press **1/⏻** to turn off the VCR.

The **⏻** indicator appears in the display window and the VCR stands by for recording.

To stop recording

To stop the VCR while recording, press **■ STOP**.

Daily/weekly recording

In step 4 above, press **↓** to select the recording pattern. Each time you press **↓**, the indication changes as shown below. Press **↑** to change the indication in reverse order.

- TODAY → SUN-SAT (Sunday to Saturday) → MON-SAT (Monday to Saturday)
- MON-FRI (Monday to Friday) → SAT (every Saturday)
- MON (every Monday) → SUN (every Sunday) → 1 month later
- (dates count down) → TOMORROW → TODAY

Timer recording with VPS/PDC signals

Some broadcast systems transmit VPS (Video Programme System) or PDC (Programme Delivery Control) signals with their TV programmes. These signals ensure that your timer recordings are made regardless of broadcast delays, early starts, or broadcast interruptions (with the VPS or PDC indicator in the display window lit).

To use the VPS/PDC function, set VPS/PDC to ON in step 4 above. You can also use the VPS/PDC function for a source connected to the LINE-1 (TV) connector.

To use the VCR after setting the timer

To use the VCR before a timer recording begins, just press I/\odot . The \odot indicator turns off and the VCR switches on. Remember to press I/\odot to reset the VCR after using the VCR.

You can also do the following tasks while the VCR is recording:

- Reset the counter.
- Display tape information on the TV screen.
- Check the timer settings.
- Watch another TV programme.

Tips

- To set the programme position with a two digit number, press $-/--$ (ten's digit) button followed by the programme number button.
- To set the programme position, you can also use the PROG $+/-$ or programme number buttons.
- To set the tape speed, you can also use the SP/LP button.
- When you are recording a programme in the SP mode and the remaining tape becomes shorter than the recording time, the tape speed is automatically changed to the LP mode. Note that some interference will appear on the picture at the point the tape speed is changed. If you want to keep the same tape speed, set AUTO LONG PLAY to OFF in the OPTIONS-1 menu (page 58).
- To confirm, change, or clear the programme setting, press \leftarrow/\rightarrow to choose LIST, then press OK after step 4. For details, see step 3 in "Checking/changing/cancelling timer settings" (page 50).

Notes

- If the VPS/PDC signal is too weak or the broadcasting station failed to transmit VPS/PDC signals, the VCR will start recording at the set time without using the VPS/PDC function.
- The \odot indicator flashes in the display window when you press I/\odot with no tape inserted.
- When you set TIMER OPTIONS to STANDARD in the OPTIONS-2 menu, the SHOWVIEW menu does not appear on the TV screen. Select SHOWVIEW or VARIABLE.

Setting the timer manually

If the ShowView system is not available in your area, follow the instructions below to set the timer to record programmes.

Before you start...

- Check that the VCR clock is set to the correct time and date.
- Insert a tape with its safety tab in place. Make sure the tape is longer than the total recording time.
- Turn on your TV and set it to the video channel.
- Set **TIMER OPTIONS** to **STANDARD** or **VARIABLE** in the **OPTIONS-2** menu (see page 59).

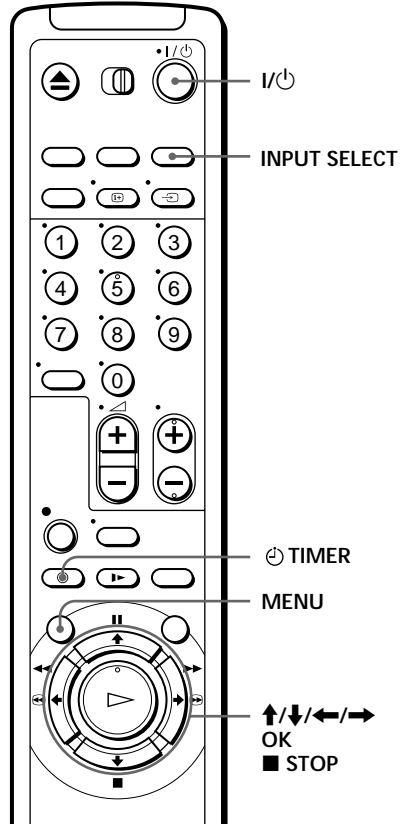

1



Press  **TIMER**.

- When you set **TIMER OPTIONS** to **VARIABLE**

The **TIMER METHOD** menu appears on the TV screen. Press **↑/↓** to select **STANDARD**, then press **OK**.

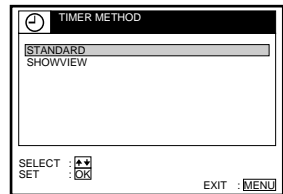

- When you set **TIMER OPTIONS** to **STANDARD**

The **TIMER** menu appears on the TV screen.

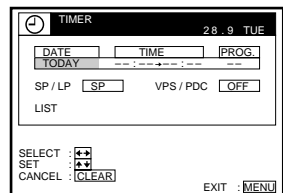

2



Set the date, start and stop times, programme position, tape speed, and VPS/PDC function:

- 1 Press **→** to highlight each item in turn.
- 2 Press **↑/↓** to set each item.

To correct a setting, press **←** to return to that setting and reset.

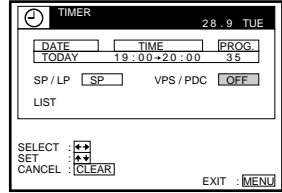

- To record the same programme every day or the same day every week, see “Daily/weekly recording” on page 46.
- To use the VPS/PDC function, set VPS/PDC to ON. For details of the VPS/PDC function, see “Timer recording with VPS/PDC signals” on page 43.
- To record from a source connected to the LINE-1 (TV) connector, press INPUT SELECT to display “L1” in the “PROG.” position.

INPUT SELECT



3

MENU



Press MENU to exit the menu.

4

•I/⏻



Press **I/⏻** to turn off the VCR.

The **⏻** indicator appears in the display window and the VCR stands by for recording.

To record from a source, leave the connected equipment switched on.

To stop recording

To stop the VCR while recording, press **■ STOP**.

continued

Setting the timer manually (continued)

Daily/weekly recording

In step 2 above, press **↓** to select the recording pattern. Each time you press **↓**, the indication changes as shown below. Press **↑** to change the indication in reverse order.

TODAY → SUN-SAT (Sunday to Saturday) → MON-SAT (Monday to Saturday)
→ MON-FRI (Monday to Friday) → SAT (every Saturday)
→ MON (every Monday) → SUN (every Sunday) → 1 month later
→ (dates count down) → TOMORROW → TODAY

Tips

- To set the programme position, you can also use the PROG +/- or programme number buttons.
- To set the tape speed, you can also use the SP/LP button.
- When you are recording a programme in the SP mode and the remaining tape becomes shorter than the recording time, the tape speed is automatically changed to the LP mode. Note that some interference will appear on the picture at the point the tape speed is changed. If you want to keep the same tape speed, set AUTO LONG PLAY to OFF in the OPTIONS-1 menu (page 58).
- Even if you set TIMER OPTIONS to SHOWVIEW in the OPTIONS-2 menu, you can set the timer manually. Press MENU to select TIMER, then go to step 2.

Notes

- When setting the timer with VPS/PDC signals, enter the start and stop times exactly as indicated in the TV programme guide, otherwise the VPS/PDC function won't work.
- If the VPS/PDC signal is too weak or the broadcasting station failed to transmit VPS/PDC signals, the VCR will start recording at the set time without using the VPS/PDC function.
- The  indicator flashes in the display window when you press **I/⏻** with no tape inserted.

Playing/searching at various speeds

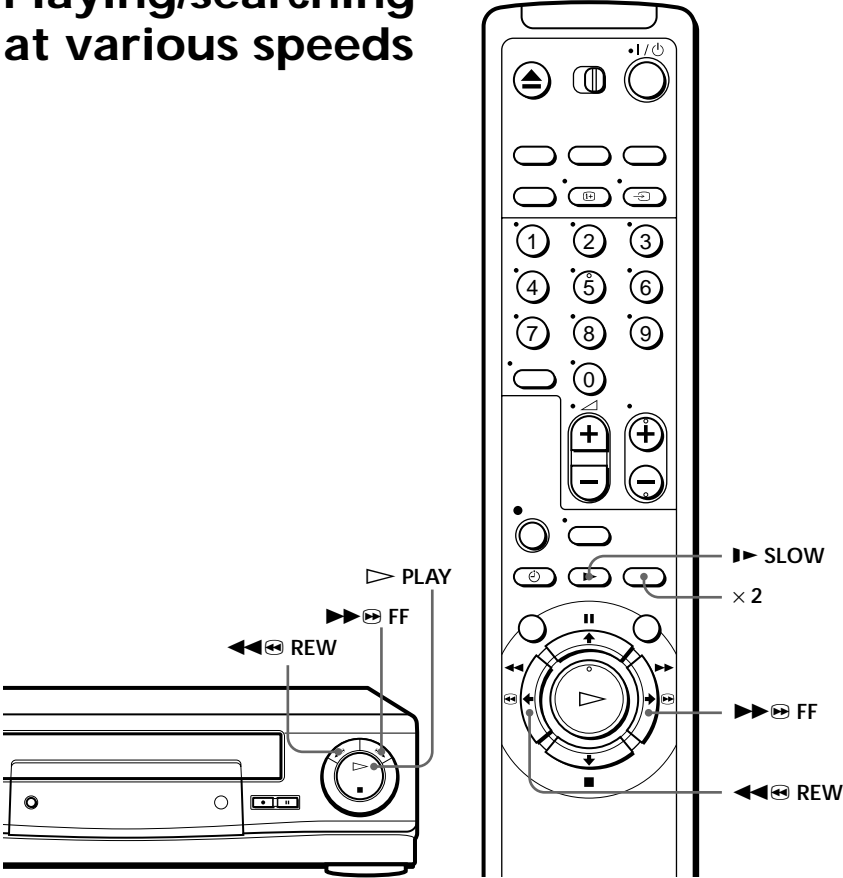

Playback options	Operation
View the picture during fast-forward or rewind	During fast-forward, hold down ►►► FF. During rewind, hold down ◀◀◀ REW.
Play at high speed	<ul style="list-style-type: none"> • During playback, press ►►► FF or ◀◀◀ REW <u>on the remote commander.</u> • During playback, hold down ►►► FF or ◀◀◀ REW. When you release the button, normal playback resumes.

continued

Playing/searching at various speeds (continued)

Playback options	Operation
Play at twice the normal speed	During playback, press $\times 2$.
Play in slow motion	During playback, press ▶▶ SLOW .
Play frame by frame	During pause, press ▶▶⏪ FF or ⏩◀◀ REW <u>on the remote commander</u> . Hold down ▶▶⏪ FF or ⏩◀◀ REW to play one frame each second.
Rewind and start play	During stop, press ▷ PLAY <u>on the VCR</u> while holding down ⏩◀◀ REW <u>on the VCR</u> .

To resume normal playback

Press **▷ PLAY**.

Tip

- Adjust the picture using the TRACKING +/- buttons if:
 - Streaks appear while playing in slow motion.
 - Bands appear at the top or bottom while pausing.
 - The picture shakes while pausing.
- To set tracking to the centre position, press both buttons (+/-) at the same time.

Notes

- The sound is muted during these operations.
- In the LP mode, noise may appear or there may be no colour.

Setting the recording duration time

After starting recording in the normal way, you can have the VCR stop recording automatically after a specified duration.

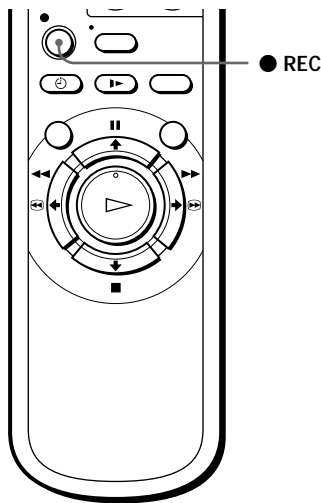

- 1 While recording, press ● REC.
The ⏻ indicator appears in the display window.

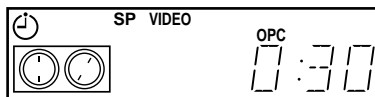

- 2 Press ● REC repeatedly to set the duration.
Each press advances the time in increments of 30 minutes.

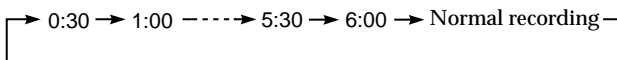

The tape counter decreases minute by minute to 0:00, then the VCR stops recording and turns off automatically.

To extend the duration

Press ● REC repeatedly to set a new duration.

To cancel the duration

Press ● REC repeatedly until the ⏻ indicator disappears and the VCR returns to normal recording mode.

To stop recording

To stop the VCR while recording, press ■ STOP.

Note

- You cannot display the current tape time in the display window when setting the recording duration.

Checking/ changing/ cancelling timer settings

Before you start...

- Turn on your TV and set it to the video channel.

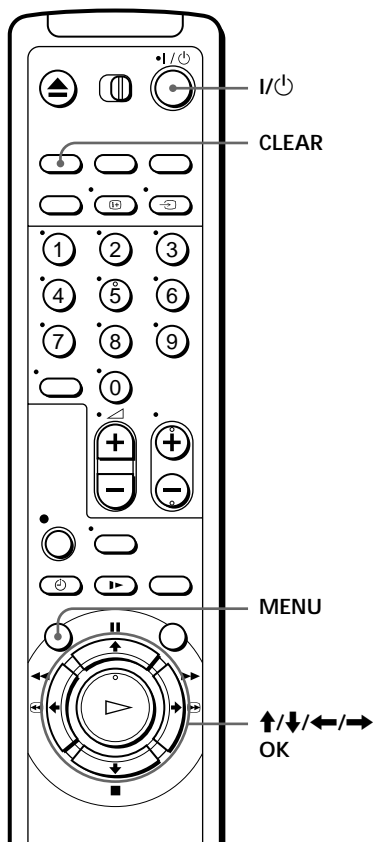

- 1 Press I/Power to turn on the VCR.
- 2 Press MENU, then press ↑/↓ to highlight LISTS and press OK.
- 3 Press ↑/↓ to highlight TIMER LIST, then press OK:
 - If you want to change or cancel a setting, go on to the next step.
 - If you do not need to change or cancel the settings, press MENU, then turn off the VCR to return to recording standby.

TIMER LIST				28. 9 TUE	
DATE	TIME	PRG.			
TODAY	19:00-20:00	35	SP		
30. 9	20:00-21:00	AAB	SP		
2. 10	10:00-11:30	CDE	LP		
MON-FRI	14:00-15:00	FGH	LP		
SUN	6:30- 7:00	IJK	LP		
---	---	---	---		
---	---	---	---		
---	---	---	---		
---	---	---	---		

RETURN : **
 SELECT : **
 SET : OK
 CANCEL : CLEAR
 EXIT : MENU

- 4 Press **↑/↓** to select the setting you want to change or cancel, then press OK.

The selected setting appears in the TIMER menu.

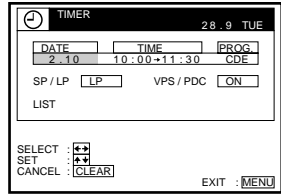

- 5
- To change the setting, press **←/→** to highlight the item you want to change, and press **↑/↓** to reset it.
 - To cancel the setting, press CLEAR.

- 6 Press MENU.

If any settings remain, turn off the VCR to return to recording standby.

When the timer settings overlap

The programme that starts first has priority and the second programme starts recording only after the first programme has finished. If the programmes start at the same time, the programme listed first in the menu has priority.

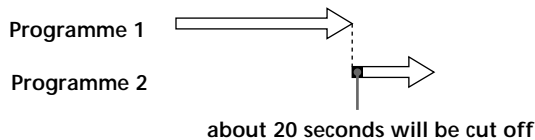
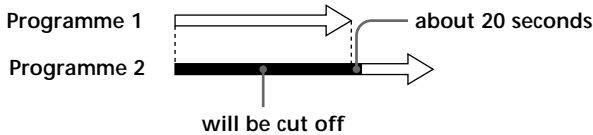

Searching using the Smart Search function

If you record multiple programmes on a tape, use the Smart Search function to see what has been recorded on your tape. You can see information such as date, time, and channel of programmes recorded on a tape. You can also start playback directly from the selected programme using the SMART SEARCH screen.

All programmes are listed on the screen, regardless of how the programme was recorded.

The data of last tape inserted into the VCR is automatically stored in memory. If you want to recall the latest data screen, select LATEST DATA in the SMART SEARCH screen (see page 53).

Before you start...

- Turn on your TV and set it to the video channel.

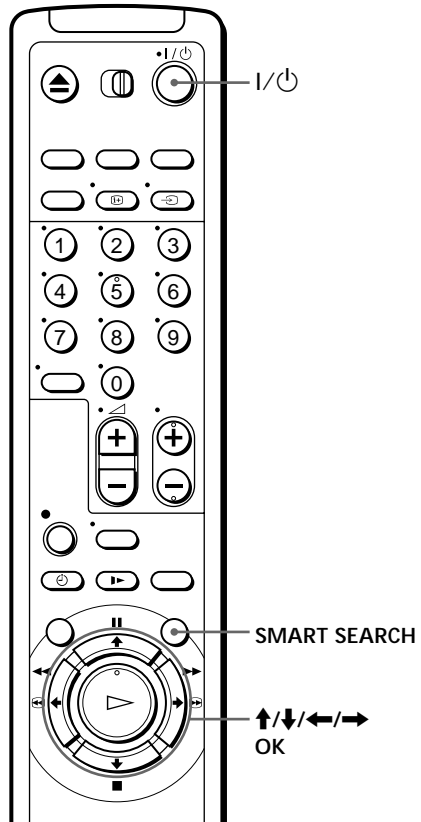

- 1 After recording, press I/Power to turn on the VCR.
- 2 Press SMART SEARCH.
- 3 Press $\uparrow/\downarrow/\leftarrow/\rightarrow$ to select the programme you want to start viewing.

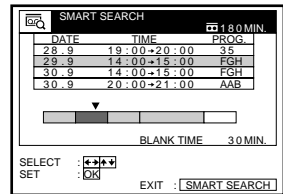

- 4 Press OK.
The VCR starts searching, and playback starts automatically from the beginning of the selected programme.

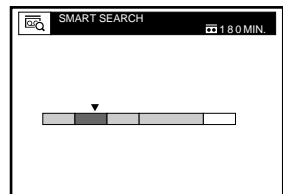

To stop searching

Press **■** STOP.

To exit the SMART SEARCH screen

Press SMART SEARCH.

To record in a blank space

Blank space on the tape will appear as a blank row in the SMART SEARCH screen. Select the blank row in step 3, then press OK. The VCR rewinds/ fast-forwards the tape to the beginning of the blank space, then stops. Start recording.

To recall the latest data screen after you remove the tape

You can display the data of the last tape used to record a programme, even after you have removed the tape.

If you reinsert the tape and record additional programmes, be sure to select LATEST DATA. Otherwise, all of the data for the tape is deleted.

- 1 Reinsert the last tape that you used to record a programme.
- 2 Press SMART SEARCH.

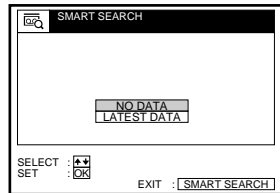

- 3 Press **↑/↓** to highlight LATEST DATA.

If you want to reset the latest data screen, highlight NO DATA and press OK, then record a programme.

- 4 Press OK.

The latest data stored in the VCR's memory is displayed.

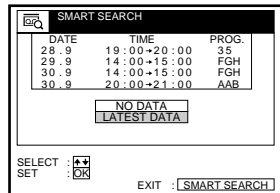

Tips

- You can store information for up to 24 programmes on a single list.
- While recording, you can display the SMART SEARCH screen using the SMART SEARCH button. If you decide to stop recording, press SMART SEARCH to make the SMART SEARCH screen disappear first. Then press **■** STOP.

continued

Searching using the Smart Search function (continued)

Notes

- If you begin recording a programme “D” from the middle of a previously recorded programme “A,” and into another previously recorded programme “B,” the Smart Search information for the second programme “B” which is recorded over is deleted.

Originally recorded programmes

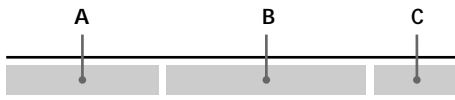

Recording the programme “D” over the programme “A” and “B”

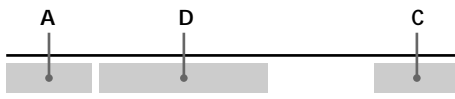

- You cannot use this function unless the clock is set.
- Depending on the tape, the total or remaining time may not appear correctly.
- When recording a short programme (less than 10 minutes in SP mode, or 20 minutes in LP mode), the Smart Search function may not be available or the programme information may not appear. Also, if you record a long programme directly after a short programme, the Smart Search information for the short programme may be deleted.
- Blank space is measured from the end of the last recorded programme to the end of the tape. However, if you eject the tape then make a new recording on the same tape, the original recorded programme(s) is displayed as a blank space.

Adjusting the picture

Adjusting the tracking

Although the VCR automatically adjusts the tracking when playing a tape (the  indicator flashes in the display window, then goes off), distortion may occur if the tape was recorded in poor condition. In this case, manually adjust the tracking.

During playback, press TRACKING +/- to display the tracking meter. The distortion should disappear as you press one of the two buttons (the  indicator lights up). To resume automatic tracking adjustments, eject the tape and re-insert it.

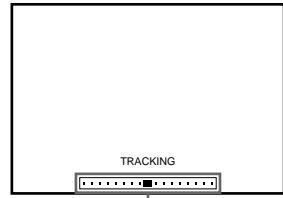

Tracking meter

About the Optimum Picture Control (OPC) function

The Optimum Picture Control (OPC) function automatically improves recording and playback quality by adjusting the VCR to the condition of the video heads and tape. To maintain better picture quality, we recommend that you set OPC to ON in the OPTIONS-1 menu (with the OPC indicator in the display window lit). For details, see page 58.

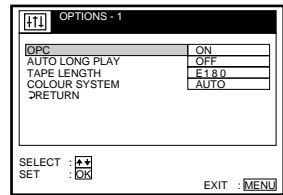

OPC playback

The OPC function automatically works on all types of tapes, including rental tapes and tapes that were not recorded with OPC.

OPC recording

Whenever you insert a tape and start recording for the first time, the VCR adjusts to the tape using the OPC function (the OPC indicator flashes rapidly). This adjustment is retained until the tape is ejected.

To deactivate the OPC function

Set OPC to OFF in the OPTIONS-1 menu. The OPC indicator in the display window goes off.

continued

Adjusting the picture (continued)

Tip

- To set tracking to the centre position, press the TRACKING + and – buttons at the same time.

Notes

- You can adjust the tracking for the NTSC-recorded tape but the tracking meter won't be displayed.
- With the Auto Long Play function on, the OPC function will work only in SP mode. If the tape speed automatically switches from SP to LP, the OPC function turns off. If, however, the entire programme is recorded in LP mode, the OPC function will work.
- There is a delay about ten seconds before the VCR actually starts recording while the VCR analyses the tape. To avoid the delay, first set the VCR to recording pause (the OPC indicator flashes slowly) and press ● REC to have the VCR analyse the tape (the OPC indicator flashes rapidly). After the OPC indicator stops flashing, press ■■ PAUSE to start recording immediately. If you want to start recording quickly without using the OPC function, first set the VCR to recording pause (the OPC indicator flashes slowly) and press ■■ PAUSE to start recording.

Changing menu options

- 1 Press MENU, then select OPTIONS and press OK.

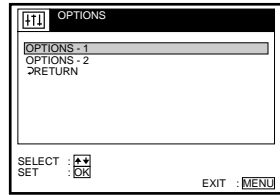

- 2 Press \uparrow/\downarrow to highlight OPTIONS-1 or OPTIONS-2, then press OK.

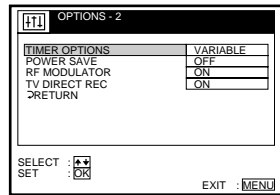
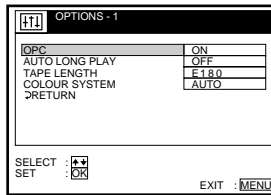

- 3 Press \uparrow/\downarrow to select the option, then press OK.
- 4 Press \uparrow/\downarrow to change the setting, then press OK.
- 5 Press MENU to return to the original screen.

continued

Changing menu options (continued)

Menu choices

Initial settings are indicated in bold print.

OPTIONS-1

Menu option	Set this option to
OPC	<ul style="list-style-type: none">• ON to switch on the OPC (Optimum Picture Control) function and improve picture quality.• OFF to switch off OPC.
AUTO LONG PLAY	<ul style="list-style-type: none">• ON to change the timer recording tape speed automatically to the LP mode when the remaining tape becomes shorter than the recording time.• OFF to keep the set tape speed.
TAPE LENGTH	<ul style="list-style-type: none">• E180 to use an E-180 or shorter type tape.• E195 to use an E-195 type tape.• E240 to use an E-240 type tape.• E300 to use an E-300 type tape.
COLOUR SYSTEM	<ul style="list-style-type: none">• AUTO to set the colour system automatically.• PAL to play back a tape recorded in the PAL colour system.• MESECAM to play back a tape recorded in the MESECAM colour system. <p>For details, see page 33.</p>

OPTIONS-2

Menu option	Set this option to
TIMER OPTIONS	<ul style="list-style-type: none">• VARIABLE to display the TIMER METHOD menu for selecting STANDARD or SHOWVIEW when pressing the ⏸ TIMER button.• STANDARD to display the TIMER menu when pressing the ⏸ TIMER button.• SHOWVIEW to display the SHOWVIEW menu when pressing the ⏸ TIMER button. For details, see pages 40, 44.
POWER SAVE	<ul style="list-style-type: none">• ON to turn off the indicators in the display window to conserve the VCR power.• OFF to turn on the indicators in the display window while the VCR is standing by.
RF MODULATOR	<ul style="list-style-type: none">• ON if you connect the VCR to your TV using only the aerial cable.• OFF if you connect the VCR to your TV using the EURO-AV cable.
TV DIRECT REC	<ul style="list-style-type: none">• ON to activate the TV Direct Rec function.• OFF to deactivate it.

Note

- When you set a timer recording, the indicators in the display window remain on, even though POWER SAVE is set to ON.

Editing with another VCR

How to connect to record on this VCR

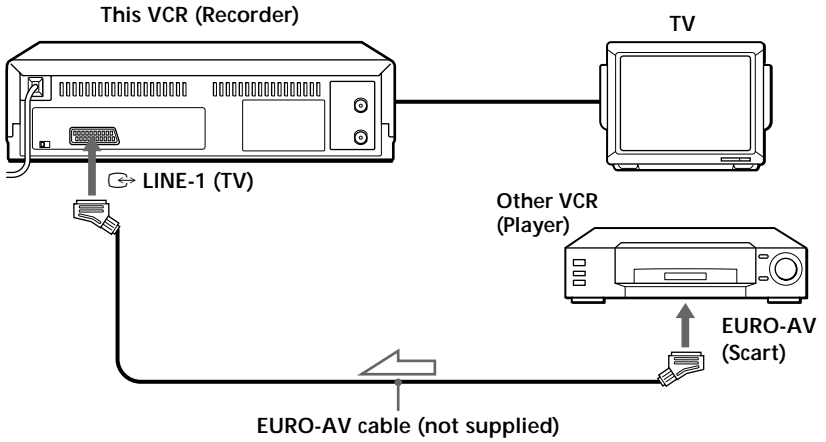

 : Signal flow

Operation (when recording on this VCR)

Before you start editing

- Turn on your TV and set it to the video channel.
- Press INPUT SELECT to display “L1” in the display window.
- Press SP/LP to select the tape speed, SP or LP.

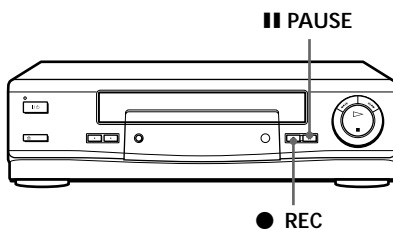

- 1** Insert a source tape with its safety tab removed into the other (playback) VCR. Search for the point to start playback and set it to playback pause.
- 2** Insert a tape with its safety tab in place into this (recording) VCR. Search for the point to start recording and press || PAUSE.
- 3** Press ● REC on this VCR to set it to recording pause.
- 4** To start editing, press the || PAUSE buttons on both VCRs at the same time.

To stop editing

Press the ■ STOP buttons on both VCRs.

Tip

- To cut out unwanted scenes while editing, press || PAUSE on this VCR when an unwanted scene begins. When it ends, press || PAUSE again to resume recording.

Note





- If you start editing following the procedure above, the VCR won't start recording with the OPC function. To record a tape with the OPC function, press ● REC again during recording pause in step 3 so the VCR analyses the tape. Then, when you start editing in step 4, press || PAUSE after the OPC indicator stops flashing. If you press || PAUSE before the OPC indicator stops flashing, the OPC function is cancelled.

Troubleshooting

If you have any questions or problems not covered below, please consult your nearest Sony service facility.

	Symptom	Remedy
Power	The I/⏻ ON/STANDBY switch does not function.	<ul style="list-style-type: none"> • Connect the mains lead to the mains securely.
	The power is turned on but the VCR does not operate.	<ul style="list-style-type: none"> • Moisture condensation occurs. Turn the power off, unplug the mains lead and leave the VCR to dry for over three hours.
Clock	The clock has stopped and “--:--” lights in the display window.	<ul style="list-style-type: none"> • The clock stops if the VCR is disconnected from the mains for more than one hour. Reset the clock (and timer).
	The playback picture does not appear on the TV screen.	<ul style="list-style-type: none"> • Make sure the TV is set to the video channel. If you are using a monitor, set it to video input. • If the VCR is connected to the TV only with the aerial cable, make sure that RF MODULATOR in the OPTIONS-2 menu is set to ON.
Playback	The picture is not clear.	<ul style="list-style-type: none"> • Adjust the tracking with the TRACKING +/- buttons. • The video heads are dirty (see below). Clean the video heads using the Sony T-25CLD, E-25CLDR, or T-25CLW video head cleaning cassette. If these cleaning cassettes are not available in your area, have the heads cleaned at your nearest Sony service facility (a standard service charge will be required). Do not use a commercially available liquid type cleaning cassette other than Sony's, as it may damage the video heads. • The video heads may have to be replaced. Consult your local Sony service facility for more information.

Symptoms caused by contaminated video heads

• Normal picture	• Rough picture	• Unclear picture	• No picture (or black & white screen appears)
			
	initial contamination	→	terminal

	Symptom	Remedy
Playback	The picture is no colour.	<ul style="list-style-type: none"> The COLOUR SYSTEM option in the OPTIONS-1 menu is set to the wrong position. Set the option to conform to the system that the tape was recorded.
	The picture rolls vertically during picture search.	<ul style="list-style-type: none"> Adjust the vertical hold control on the TV or monitor.
	The picture has no sound.	<ul style="list-style-type: none"> The tape is defective.
Recording	No TV programme appears on the TV screen.	<ul style="list-style-type: none"> Make sure the TV is set to the video channel. If you are using a monitor, set it to video input. If the VCR is connected to the TV using only the aerial cable, make sure that RF MODULATOR in the OPTIONS-2 menu is set to ON. Select the correct source with the INPUT SELECT button. Select a programme position when recording TV programmes; select "L1" when recording from other equipment.
	TV reception is poor.	<ul style="list-style-type: none"> Adjust the TV aerial. Make sure the TV system is correctly set for your TV. Make sure SYSTEM (B/G or D/K) in the TUNER menu is set to the same system in your local area.
	The tape starts playing as soon as it is inserted.	<ul style="list-style-type: none"> The safety tab has been removed. To record on this tape, cover the tab hole.
	The tape is ejected when you press ● REC.	<ul style="list-style-type: none"> Check that the safety tab has not been removed.
	Nothing happens when you press ● REC.	<ul style="list-style-type: none"> Make sure the tape is not at its end.
Timer recording	The timer does not operate.	<ul style="list-style-type: none"> Check that the clock is set. Make sure a tape has been inserted. Check that the safety tab has not been removed. Make sure the tape is not at its end. Make sure a programme has been set for timer recording. Make sure your timer settings have not already passed the current time. The clock stops if the VCR is disconnected from the mains for more than one hour. Reset the clock and timer.
	The SHOWVIEW menu or the TIMER menu does not appear.	<ul style="list-style-type: none"> Check that TIMER OPTIONS in the OPTIONS-2 menu is set correctly.

continued

Troubleshooting (continued)

	Symptom	Remedy
Others	A tape cannot be inserted.	<ul style="list-style-type: none">• Check that a tape isn't already in the tape compartment.
	The remote commander does not function.	<ul style="list-style-type: none">• Make sure you are pointing the remote commander at the remote sensor on the VCR.• Replace all the batteries in the remote commander with new ones if they are weak.• Make sure the TV/VIDEO remote control switch is set correctly.
	The SMARTLINK function does not work.	<ul style="list-style-type: none">• Check that your TV complies with SMARTLINK, MEGALOGIC, EASYLINK, Q-Link, or EURO VIEW LINK.• Make sure you use the optional EURO-AV cable to connect the VCR and your TV.• Make sure the EURO-AV cable is connected securely.
	The tracking meter does not appear on the TV screen.	<ul style="list-style-type: none">• The recording condition of the tape is very poor and tracking cannot be adjusted.• The tracking meter does not appear when playing back an NTSC-recorded tape.
	The VCR needs to be cleaned.	<ul style="list-style-type: none">• Clean the cabinet, panel and controls with a dry, soft cloth, or a soft cloth slightly moistened with a mild detergent solution. Do not use any type of solvent, such as alcohol or benzine.

Specifications

System

Channel coverage

PAL (B/G, D/K)

VHF E2-E12, R1-R12

UHF E21-E69, R21-R69

CATV S1-S41, S01-S05

RF output signal

UHF channels 21 to 69

Aerial out

75-ohm asymmetrical aerial socket

Inputs and outputs

↳ LINE-1 (TV)

21-pin

Video input: pin 20

Audio input: pins 2 and 6

Video output: pin 19

Audio output: pins 1 and 3

General

Power requirements

220 – 240 V AC, 50 Hz

Power consumption

20 W

Operating temperature

5°C to 40°C

Storage temperature

-20°C to 60°C

Dimensions

Approx. 355 × 96 × 285 mm (w/h/d)

including projecting parts and controls

Mass

Approx. 3.8 kg

Supplied accessories

Remote commander (1)

R6 (size AA) batteries (2)

Aerial cable (1)

Design and specifications are subject to change without notice.

Index to parts and controls

Refer to the pages indicated in parentheses () for details.

Front panel

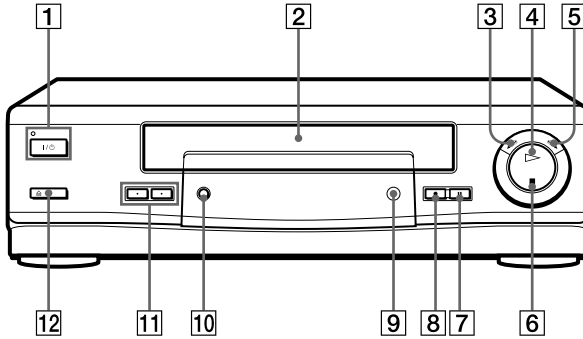

- 1** I/⏻ ON/STANDBY switch/
indicator (12)
- 2** Tape compartment
- 3** ◀◀⏮ REW (rewind) button (33, 47)
- 4** ▷▶⏭ PLAY button (33, 48)
- 5** ▶▶⏭ FF (fast-forward) button (33,
47)
- 6** ■ STOP button (33, 61)
- 7** ■ PAUSE button (33, 61)
- 8** ● REC (record) button (36, 49, 61)
- 9** Remote sensor (5)
- 10** AUTO SET UP/
RF (Radio Frequency) CHANNEL
button (12, 14)
- 11** PROGRAM/TRACKING +/-
buttons (14, 48, 55)
- 12** ≡ EJECT button (33)

Display window

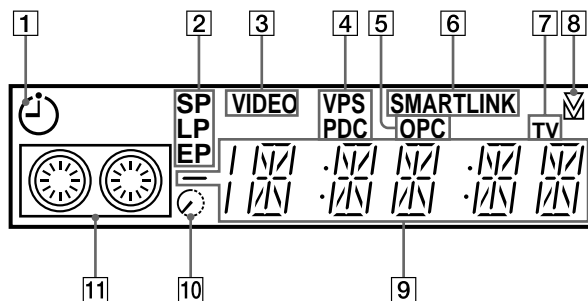

- | | |
|--|---|
| 1 Timer indicator (42, 45) | 7 TV indicator (39) |
| 2 Tape speed indicators (36) | 8 Tracking indicator (55) |
| 3 VIDEO indicator (10, 37) | 9 Time counter/clock/line/
programme position indicator (33,
36, 61) |
| 4 VPS (Video Programme System)/
PDC (Programme Delivery Control)
indicator (43) | 10 Remaining time indicator (37) |
| 5 OPC (Optimum Picture Control)
indicator (55) | 11 Tape/recording indicator (36) |
| 6 SMARTLINK indicator (10) | |

continued

Index to parts and controls (continued)

Rear panel

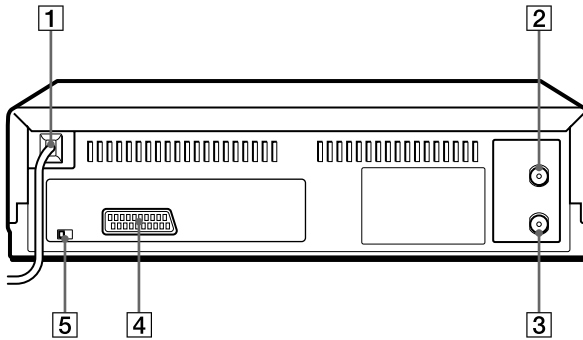

- 1** Mains lead (8, 9)
- 2** AERIAL IN
ANTENNE ENTREE connector (8, 9)
- 3** AERIAL OUT
ANTENNE SORTIE connector (8, 9)
- 4** ↔ LINE-1 (TV)
↔ LIGNE-1 (TV) connector (10, 60)
- 5** NTSC PB (Play Back) switch (33)

Remote commander

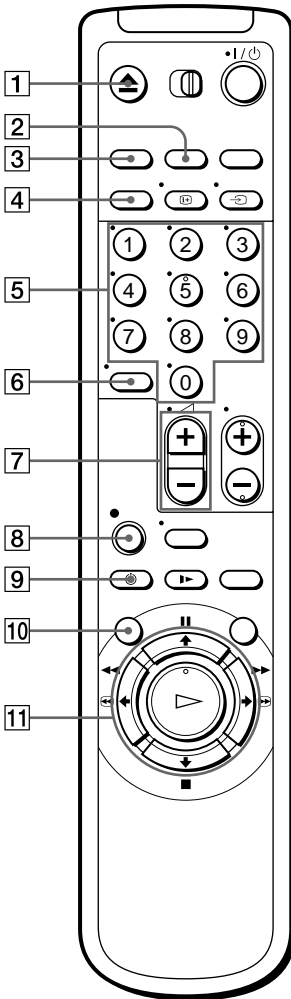

- 1 ▲ EJECT button (33)
- 2 COUNTER/REMAIN button (37)
- 3 CLEAR button (41, 51)
- 4 SP (Standard Play)/LP (Long Play) button (36)
- 5 Programme number buttons (6, 38)
- 6 --- (ten's digit) button (6, 38)
- 7 ∟ (volume) +/- buttons (for TV) (7)
- 8 ● REC (record) button (36, 49)
- 9 ⌚ TIMER button (40, 44)
- 10 MENU button (16, 50)
- 11 ■■ PAUSE/↑ button (16, 33)
 ■ STOP/↓ button (16, 33)
 ◀◀ ⏮ REW (rewind)/← button (33, 47)
 ▶▶ ⏭ FF (fast-forward)/→ button (33, 47)
 ▷ PLAY/OK button (16, 33)

continued

Index to parts and controls (continued)

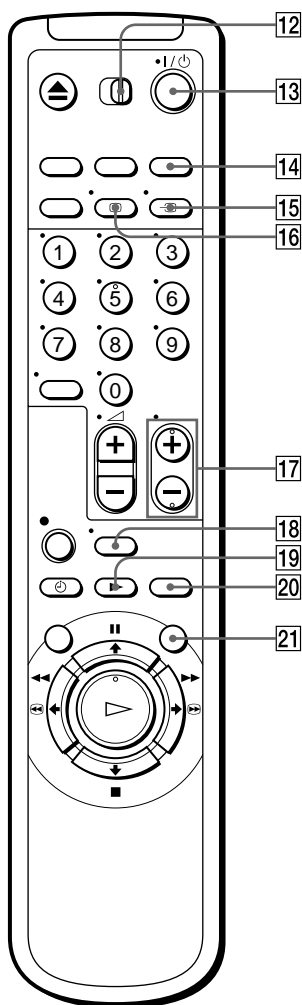

- 12 TV/VIDEO remote control switch (5)
- 13 I/⏻ (on/standby) switch (6, 42)
- 14 INPUT SELECT button (36, 45, 61)
- 15 TV/VIDEO button (6, 37)
- 16 ⏻ DISPLAY button (37)
- 17 PROG (programme) +/– buttons (6, 23, 36)
- 18 WIDE button (for TV) (7)
- 19 ▶ SLOW button (48)
- 20 × 2 button (48)
- 21 SMART SEARCH button (52)

Index

A, B

- Adjusting
 - picture 25, 55
 - tracking 55
- Aerial hookup 8
- AFT (Auto Fine Tuning) 25
- Auto Clock Set 19
- Auto Set Up 14
- Auto Long Play 58

C

- Changing the programme position 26
- Changing the station name 28
- Cleaning the video heads 62
- Clock setting 16
- Colour system
 - compatible colour systems 2
 - setting 33
- Connecting
 - the VCR and your TV 8
 - to a TV with a EURO-AV connector 9
- Counter 33

D

- Disabling the programme position 25
- Dubbing. *See* Editing

E, F, G, H, I, J, K

- Editing 60
- EURO-AV connection 9

L, M, N

- Language selecting 21
- LP mode 36

O

- OPC (Optimum Picture Control) 55
- Optional setting 57

P, Q

- PDC (Programme Delivery Control) 43
- Picture adjustment. *See* Adjusting
- Playback 32
 - at various speeds 47
 - slow motion 48
- Power save 59
- Presetting channels 22

R

- Recording 35
 - saving 37
 - timer setting 44
 - using ShowView 40
 - what you watching on the TV 39
 - while watching another programme 37
- RF channel 12

S

- Safety tab 37
- Searching
 - at various speeds 47
 - using the Smart Search function 52
- ShowView
 - recording 40
- SMARTLINK
 - Automatic Power Off 11
 - One Touch Menu 11
 - One Touch Play 11, 34
 - One Touch Timer 11
 - Preset Download 10
 - TV Direct Rec 11, 39
- Smart Search 52
- SP mode 36

T, U

- Timer setting 44
 - cancelling 50
 - changing 50
 - checking 50
 - daily/weekly recording 42, 46
 - using ShowView 40
- Tracking adjustment. *See* Adjusting

V, W, X, Y, Z

- VPS (Video Programme System) 43