

Portable IC Audio Player

Network Walkman

Operating Instructions

English Operating Instructions are contained in the supplied CD-ROM.

Français le mode d'emploi se trouve sur le CD-ROM fourni.

Die deutsche Bedienungsanleitung ist auf der mitgelieferten CD-ROM enthalten.

El manual de instrucciones en español se incluye en el CD-ROM suministrado.

Le Istruzioni per l'uso in italiano sono contenute nel CD-ROM in dotazione.

Os manuais de instruções em português encontram-se no CD-ROM fornecido.

U vindt de Nederlandse gebruiksaanwijzing op de bijgeleverde CD-ROM.

Svensk bruksanvisning finns på den medföljande CD-ROM-skivan.

Suomenkielinen Käyttöohje on vakiovarusteisiin sisältyvällä CD-ROM-levyllä.

"Инструкция по эксплуатации" на русском языке имеется на прилагаемом компакт-диске.

Magyar nyelvű Használati útmutató a mellékelt CD-ROM-on található.

Instrukcja obsługi w języku polskim znajduje się na dostarczonej płycie CD-ROM.

Návod k obsluze v češtině je umístěn na dodávaném disku CD-ROM.

Návod na používanie v slovenskom jazyku sa nachádza na dodanom disku CD-ROM.

Den danske betjeningsvejledning findes på den medfølgende CD-ROM.

Norsk bruksanvisning er tilgjengelig på den medfølgende CD-ROMen.



"WALKMAN" is a registered trademark of Sony Corporation to represent Headphone Stereo products.

 WALKMAN is a trademark of Sony Corporation.

NW-E95/E99

WARNING

To prevent fire or shock hazard, do not expose the unit to rain or moisture.

Do not install the appliance in a confined space, such as a bookcase or built-in cabinet.

To prevent fire, do not cover the ventilation of the apparatus with newspapers, table cloths, curtains, etc. And don't place lighted candles on the apparatus.

To prevent fire or shock hazard, do not place objects filled with liquids, such as vases, on the apparatus.

Note on installation

If you use the unit at a place subject to static or electrical noise, the track's transferring information may be corrupted. This would prevent successful transferring authorization on your computer.

A pleine puissance, l'écoute prolongée du baladeur peut endommager l'oreille de l'utilisateur.

For the customers in the Netherlands

Voor de Klanten in Nederland



Gooi de batterij niet weg maar lever deze in als klein chemisch afval(KCA).

Notice for users

On the supplied software

- Copyright laws prohibit reproducing the software or the manual accompanying it in whole or in part, or renting the software without the permission of the copyright holder.
- In no event will SONY be liable for any financial damage, or loss of profits, including claims made by third parties, arising out of the use of the software supplied with this player.
- In the event a problem occurs with this software as a result of defective manufacturing, SONY will replace it.
However, SONY bears no other responsibility.
- The software provided with this player cannot be used with equipment other than that which is so designated.
- Please note that, due to continued efforts to improve quality, the software specifications may be changed without notice.
- Operation of this player with software other than that provided is not covered by the warranty.
- Depending on the type of the text and characters, the text shown on SonicStage and MP3 File Manager may not be displayed properly on device. This is due to:
 - The capability of the connected player.
 - The player is not functioning normally.
 - The ID3 TAG information for the track is written in the language or the character that is not supported by the player.

Program ©2001, 2002, 2003, 2004 Sony Corporation
Documentation ©2004 Sony Corporation

This manual explains how to operate your Network Walkman and how to use the MP3 File Manager (pre-installed software). For details on how to use the SonicStage (supplied software), refer to the SonicStage operating instructions.

OpenMG and its logo are trademarks of Sony Corporation.

SonicStage and SonicStage logo are trademarks or registered trademarks of Sony Corporation.

ATRAC, ATRAC3, ATRAC3plus and their logos are trademarks of Sony Corporation.

Microsoft, Windows and Windows Media are trademarks or registered trademarks of Microsoft Corporation in the United States and/or other countries.

All other trademarks and registered trademarks are trademarks or registered trademarks of their respective holders.

In this manual, ™ and © marks are not specified.

Table of Contents

Overview	6
What you can do with your Network Walkman	6
Other features	7
Step 1: Checking the package contents	8
Step 2: Inserting the battery	9
Locating controls	10
Front side	10
Rear side	10
Display	11

Basic Operations

Transferring audio files from the computer to your Network Walkman	12
Note on playing songs with a limited playing period (Timeout contents) ..	13
Note on playing songs with a limited playing count	13
Listening to music with your Network Walkman	14
What is the Group function?	15
On other operations	16

Advanced Operations

Repeat mode	17
Selecting the repeat mode	17
Playing the tracks repeatedly (Track Repeat)	18
Playing a specified section repeatedly (A-B Repeat)	19
Playing specified sentences repeatedly (Sentence Repeat)	20
Setting the repeat counts	21
Changing the display mode	22
Selecting the group display mode	23
Adjusting treble and bass (Digital sound preset)	23
Selecting the Sound quality	23
Adjusting the Sound quality	24
Locking the controls (HOLD)	25
Storing non-audio data	25

Adjusting the settings of your Network Walkman

Adjusting the time setting of your Network Walkman to a computer's built-in clock	26
Adjusting the current time setting (DATE-TIME)	27
Limiting the volume (AVLS)	28
Setting the volume using the preset volume function	29
Setting a volume level of the preset mode	29
Switching to the manual mode	30
Turning off the beep sound (BEEP)	31
Changing the backlight setting	32

Other functions

Regrouping songs (REGROUP) — NW-E95 only	33
Formatting memory (FORMAT)	34

Other Information

Precautions	35
Troubleshooting	36
To reset the player	36
What happened?	36
Messages	39
Specifications	41
Glossary	42
Menu list	44

MP3 File Manager software operation

What you can do with the MP3 File Manager	45
Transferring MP3 audio files from the computer to your Network Walkman ..	46
Display of MP3 File Manager	48
Erasing audio file	49
Ordering audio file	49

Index	50
-------------	----

Overview

What you can do with your Network Walkman

First, you need to install the “SonicStage” software into your computer (MP3 File Manager software is pre-installed in your Network Walkman). You can easily transfer digital audio files from your computer to the built-in flash memory and carry it anywhere to enjoy.

1 Store digital audio files on your computer.

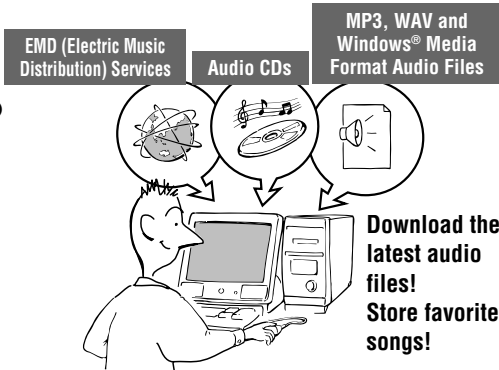

2 Transfer files to your Network Walkman.

When you transfer MP3 format audio files to your Network Walkman, use MP3 File Manager software (pre-installed software) to transfer and store them as MP3 format audio files.



3 Enjoy music with your Network Walkman.

You can display the data stored in the built-in flash memory using Windows Explorer when your Network Walkman is connected to the computer. However, an MP3 file cannot be played back if you drag or copy the file directly on the Windows Explorer screen. When you transfer an MP3 format audio file to your Network Walkman, be sure to use the MP3 File Manager software (see page 45).



Other features

- Compact size, light weight, skip-proof operation, high portability.
- The pre-installed MP3 File Manager software enables you to transfer MP3 format audio files to your Network Walkman and listen to them with your Network Walkman as MP3 format files.
- Continuous playback time with a battery
NW-E95/E99: Approximately 70*¹ hours
- Recording time*²
NW-E95: 512MB built-in flash memory, more than 23 hours 20 minutes
NW-E99: 512MB + 512MB built-in flash memories, more than 46 hours 40 minutes
- The supplied SonicStage software enables you to record songs from audio CDs to the hard disk of your computer using the ATRAC3plus format (high sound quality, high compression).
- Sentence Repeat: Useful function for learning a foreign language.
- High-speed data transfer using the dedicated USB cable.
- Backlight LCD screen: song titles and artist names can be displayed.
- Group function: you can select songs to be played by album.
- Storage function: you can store a variety of data as well as audio files.

*¹ Differs according to the data format. In this case, the figure for the battery duration is when continuously playing ATRAC3 format audio files.

*² Differs according to the bit rate when recording. In this case, the figure for the recordable time is when recording at 48kbps ATRAC3plus format.

NOTES:

- The recorded music is limited to private use only. Use of the music beyond this limit requires permission of the copyright holders.
- Sony is not responsible for incomplete recording/downloading or damaged data due to problems of the Network Walkman or computer.

Step 1: Checking the package contents

Please check the accessories in the package.

NW-E95/E99:

- Network Walkman (1)
- Headphones (1)

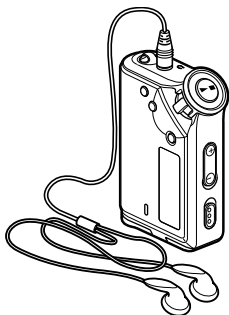

- Dedicated USB cable (1)

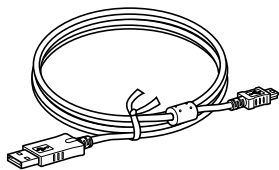

- Carrying pouch (1)
- Neck strap (1)
- Extension headphone cord (1)
- CD-ROM for the SonicStage software (1)
- Operating Instructions (1)
- SonicStage Operating Instructions (1)
- CD-ROM for the Operating Instructions and SonicStage Operating Instructions (1)

About the Serial Number

The serial number provided for your device is required for the customer registration. The number is on the rear side of your Network Walkman.

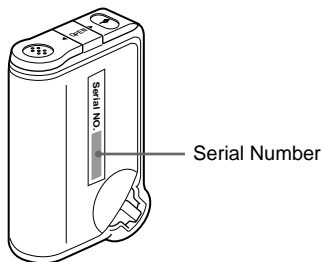

Record the serial number in the space provided below. Refer to it whenever you call upon your Sony dealer regarding this product.

Serial No. _____

Step 2: Inserting the battery

Insert the LR03 (size AAA) alkaline battery with correct polarity. Be sure to insert it from the  side as illustrated.

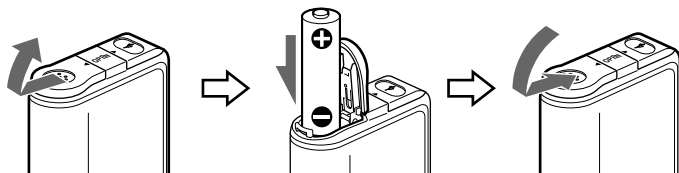

Battery duration*

ATRAC3 format: Approximately 70 hours

ATRAC3plus format: Approximately 60 hours

MP3 format: Approximately 50 hours

* The battery life may be shorter due to operating conditions and the temperature of the location.

On the remaining battery indication

The battery icon in the display changes as shown below.



If “LOW BATT” is displayed in the display, you need to change the battery.

If the battery compartment lid is accidentally detached, attach it as illustrated.

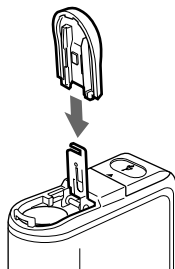

Note

If you do not use the battery correctly, it may become damaged from leakage and corrosion. For best results:

- Use the alkaline battery.
- Make sure the polarity is correct.
- Do not charge a dry cell battery.
- Remove the battery, if you do not intend to use the player for an extended period of time.
- If you have battery leakage, replace with a new battery after cleaning the battery compartment.

Locating controls

For details about each part, refer to the pages in parentheses.

Front side

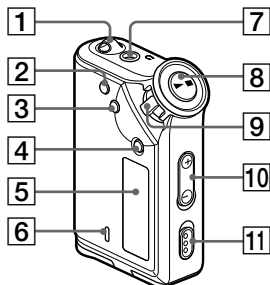

- 1** Strap hole for attaching the strap
- 2** REPEAT/SOUND button
(page 18 to 20, 23)
- 3** MENU button (page 16 to 22, 24, 26 to 34)
You can switch to the Time display by pressing the MENU button for a while.
- 4** GROUP button (page 15, 23)
- 5** Display (page 11, 18, 39)
For details on the display and icons, refer to page 11.
- 6** ACCESS lamp (page 12, 46)
- 7** Headphone jack (page 14)
- 8** ►■ button
(page 14, 16 to 17, 19 to 22, 24, 26 to 34)

Rear side

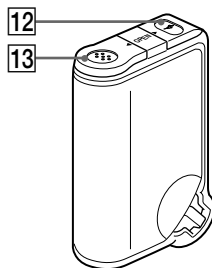

- 9** Shuttle switch
(page 16 to 17, 19 to 22, 24, 26 to 34)
- 10** VOLUME +/- button (page 14, 29)
- 11** HOLD (Locking controls) switch
(page 14, 25)
- 12** USB jack (page 12, 46)
- 13** Battery compartment (page 9)

Display

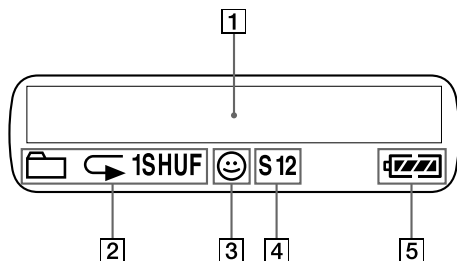

- 1** Text/graphic information display (page 17)
Displays track number, track name, current date and time (page 22 to 28), MESSAGE (page 13, 39) and menu. Press the MENU button to switch the display mode. For details, refer to “Changing the display mode” on page 22.
- 2** Repeat mode indication (page 18)
The current repeat mode is displayed.
- 3** AVLS indication (page 28)
The indication appears while the AVLS function is activated.
- 4** Digital sound preset indication (page 23 to 24)
The current sound setting is displayed.
- 5** Remaining battery indication (page 9)
The remaining battery power is displayed.

Basic Operations

Transferring audio files from the computer to your Network Walkman

Note

Before connecting your Network Walkman to the computer for the first time, be sure to install the “SonicStage” software from the supplied CD-ROM in your computer. Even if the SonicStage software is already installed, you need to install the SonicStage software supplied with this Network Walkman before connecting your Network Walkman to the computer (update programs may be available).

You can transfer ATRAC3plus format audio files from the computer to your Network Walkman using the installed SonicStage software. Follow the procedure below.

You can also transfer MP3 format audio files, using the MP3 File Manager that is pre-installed in your Network Walkman. For details, refer to “MP3 File Manager software operation” on page 45.

1 Install the SonicStage software in your computer using the supplied CD-ROM.

Follow step 1 only for the first time when you connect your Network Walkman to the computer.

For details, refer to the manual “SonicStage operating instructions.”

2 Import audio files into the SonicStage software.

For details, refer to the manual “SonicStage operating instructions.”

3 Connect your Network Walkman to your computer.

Connect the small connector of the dedicated USB cable into the USB jack on the Network Walkman, then the large connector to a USB port on your computer.

“CONNECT” appears in the display.

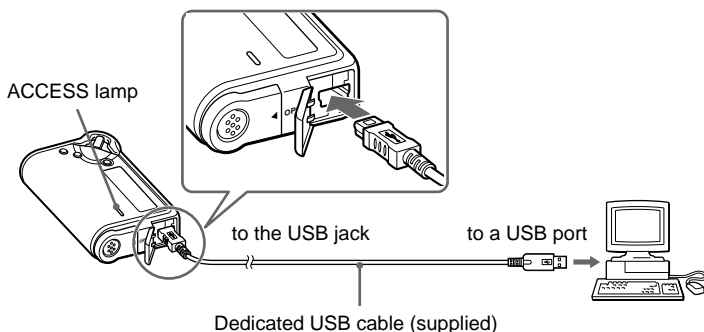

Notes

- The ACCESS lamp blinks while your Network Walkman accesses the computer.
- Do not disconnect the USB cable when the ACCESS lamp is blinking. The data being transferred may be destroyed.
- Use of your Network Walkman with a USB hub or a USB extension cable is not guaranteed. Always connect your Network Walkman to the computer directly using the dedicated USB cable.
- Some USB devices connected to the computer may interfere with the proper operation of your Network Walkman.
- The control buttons on your Network Walkman are all disabled while it is connected to a computer.
- You can display the data stored in the built-in flash memory using Windows Explorer when your Network Walkman is connected to the computer.

4 Transfer audio files to your Network Walkman.

For information on transferring audio files to the built-in flash memory, refer to the separate manual “SonicStage operating instructions.”

Tips

- As the NW-E99 has two flash memories, you can select one flash memory from the list of transfer destinations. The transfer destinations below are shown on the SonicStage screen:
 - Network Walkman (#1 Internal): flash memory 1
 - Network Walkman (#2 Internal): flash memory 2
- For information on transferring audio files back to the computer, refer to the manual “SonicStage operating instructions” or online Help for the SonicStage software.

Note on playing songs with a limited playing period (Timeout contents)

Some songs distributed via the Internet (EMD service) have a limited playing period.

If you try to play an expired song, “EXPIRED” blinks and the next song will be played after a moment.

In addition, an expired song cannot be played using the SonicStage software, or transferred to your Network Walkman. Delete any songs as needed.

Note on playing songs with a limited playing count

Your Network Walkman does not support contents with a limited playing count.

When you try to play a song with a limited playing count, “EXPIRED” will be displayed and the song will not be played.

Listening to music with your Network Walkman

Please insert the battery before use (see page 9).

Note

When using Network Walkman, be sure to disconnect it from the computer.

1 Connect the headphones.

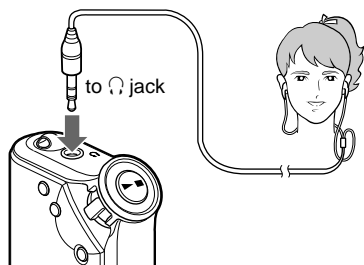

To use the headphones extension cord

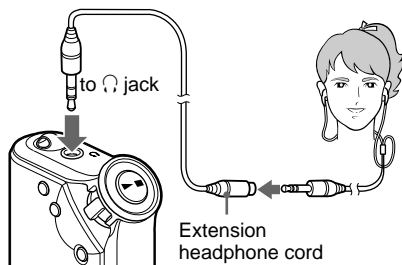

2 Start playback.

- ① Press the ►■ button.

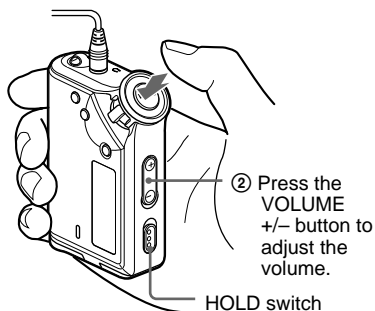

Tip

If your Network Walkman is not operated for 5 seconds while in stop mode, the display automatically turns off.

When the normal playback mode is selected, playback stops automatically after the last song is played.

If playback does not start

Make sure that the HOLD switch is set to off (page 25).

To stop playback

Press the ►■ button.

To adjust the volume

The volume can be set in the Preset and Manual mode (page 29 to 30).

Playback order of tracks/groups (NW-E99 only)

The transferred tracks/groups playback as follows:
Tracks/groups transferred using SonicStage software in the flash memory 1 → Tracks/groups transferred using MP3 File Manager software in the flash memory 1 → Tracks/groups transferred using SonicStage software in the flash memory 2 → Tracks/groups transferred using MP3 File Manager software in the flash memory 2

What is the Group function?

The Group function enables you to select favorite music conveniently on your Network Walkman. You can transfer to audio files or play songs by album or artist using the Group function.

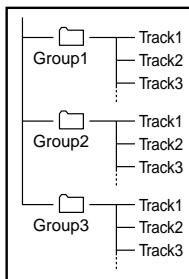

- The track number is the order of songs in each group.
- You can switch between Track Name mode and Group mode by pressing the GROUP button.
- In the Group mode, group names are displayed instead of track names. In addition, any shift operations, such as Skip or Repeat, are performed by group.

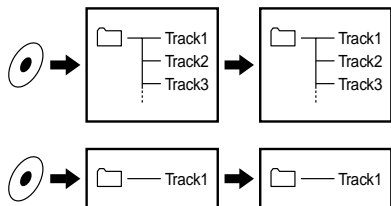

Transferring by group

The audio files transferred to the SonicStage software are always grouped when transferred to the built-in flash memory.

Tip

A group created by SonicStage software has priority over one created by MP3 File Manager software on your Network Walkman.

continued

On other operations

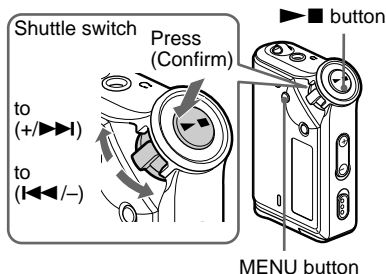

Tip

You can switch to the Group mode by pressing the GROUP button.

To	Shuttle switch operation
Skip to the beginning of the next track/group* ¹	Rotate the Shuttle switch clockwise once (+/▶▶).
Skip to the beginning of the current track/group* ¹	Rotate the Shuttle switch counterclockwise once (◀◀/-).
Fast-forward* ²	Rotate the Shuttle switch clockwise (+/▶▶) and hold it.
Fast-rewind* ²	Rotate the Shuttle switch counterclockwise (◀◀/-) and hold it.

*¹ Rotating and holding of the Shuttle switch during stop mode allows you to skip to the beginning of the next (current and previous) track/group continuously.

*² Fast-forward and fast-rewind speed become faster if the operation is continued for 5 seconds.

Repeat mode

There are three types of repeat mode: Track Repeat, A-B Repeat and Sentence Repeat.

• **Track Repeat (TRK Rep)**

This mode plays back tracks repeatedly in the following five ways.

Track Repeat mode	Operation
All Repeat*1	All tracks repeatedly
Single Repeat	Current track repeatedly
Group Repeat	Current group repeatedly
Group Shuffle Repeat	Current group repeatedly in random order
All Groups Shuffle Repeat*2	All groups repeatedly in random order Tracks in a group play back in order

• **A-B Repeat (A-B Rep)**

This mode plays back the specified section in a track repeatedly.

• **Sentence Repeat (SENTENCE Rep)**

This mode plays back voice data within a specified section in a track repeatedly.

*1 All tracks repeat as follows (NW-E99 only):
Tracks transferred using SonicStage software in the flash memory 1 → Tracks transferred using MP3 File Manager software in the flash memory 1 → Tracks transferred using SonicStage software in the flash memory 2 → Tracks transferred using MP3 File Manager software in the flash memory 2

*2 The All Groups Shuffle Repeat mode applies to both flash memory. (NW-E99 only)

Selecting the repeat mode

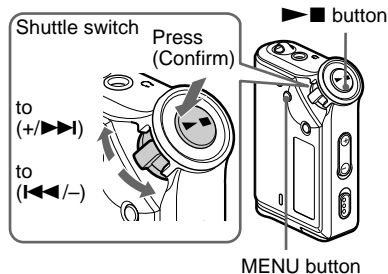

1 Press the MENU button in stop mode.

The menu screen is displayed.



2 Rotate the Shuttle switch to select "REPEAT MODE >" and press the ►■ button to confirm.

3 Rotate the Shuttle switch to select a desired repeat mode and press the ►■ button to confirm.



You can choose one mode among "TRK Rep," "A-B Rep" and "SENTENCE Rep."

Repeat mode

4 Press the MENU button.

The display returns to the normal screen. You can operate each repeat mode you selected, as refer to the below.

- TRK Rep: see “Playing the tracks repeatedly (Track Repeat).”
- A-B Rep: see “Playing a specified section repeatedly (A-B Repeat).”
- SENTENCE Rep: see “Playing specified sentences repeatedly (Sentence Repeat).”

To cancel the Menu mode

Select [RETURN] in the menu screen or press the MENU button.

Notes

- The display automatically returns to the normal playback screen if you do not operate any button for 60 seconds.
- When there is no audio files in the built-in flash memory, you cannot set any repeat mode.
- When you connect the Network Walkman to your computer, the selected desired mode will be canceled.
- You can select repeat mode only in stop mode.

Playing the tracks repeatedly (Track Repeat)

The Track Repeat mode is changed by pressing the REPEAT/SOUND button. You can check the current Track Repeat mode with the icon of the display.

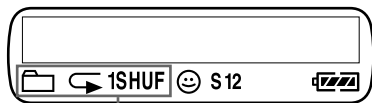
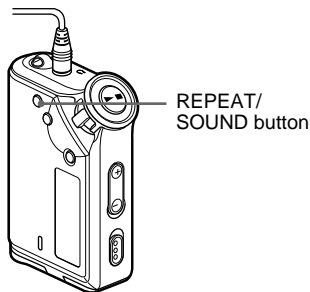

Track Repeat icon

Select the Track Repeat mode (TRK Rep) first (page 17). Then, press the REPEAT/SOUND button repeatedly to select the repeat mode you want.

Each press changes the Track Repeat icon as follows:

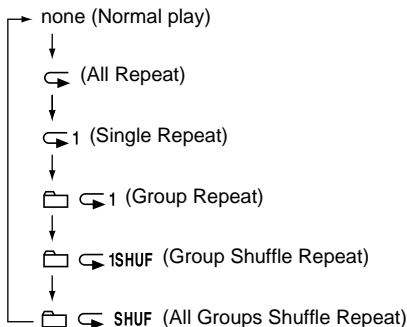

Playing a specified section repeatedly (A-B Repeat)

While playing a track, you can set the start point (A) and end point (B) for a section you wish to play repeatedly.

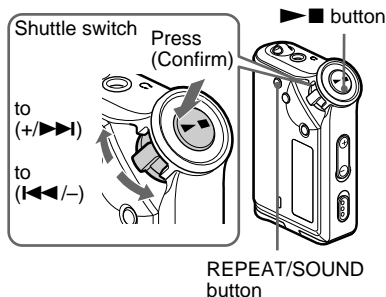

1 Select the A-B Repeat mode (A-B Rep) (page 17).

2 Press the ▶■ button to start playback.

3 Press the REPEAT/SOUND button to set the start point (A) while playing back.
“B” blinks.

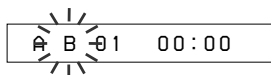

4 Press the REPEAT/SOUND button to set the end point (B).
“A B” is displayed and the specified section is played back repeatedly.



Notes

- You cannot set A-B Repeat for a section that overlaps two or more tracks.
- If you do not set the end point (B), the end point is automatically set at the end of the track.
- You cannot use A-B Repeat in the Group mode or when the current time is displayed.

Tips

- You can fast-forward or fast-rewind by rotating the Shuttle switch, after the start point (A) is set. If the track reaches the end while fast-forwarding, the end point is set as point (B) and fast-forwarding continues. A-B Repeat starts when you release the Shuttle switch. If the track reaches the beginning while fast-rewinding, it jumps to the end of the track, the end point is set as point (B), and fast-rewinding continues.
- You can fast-forward or fast-rewind by rotating the Shuttle switch, during A-B Repeat playback. If the track reaches the track start/end while fast-forwarding or fast-rewinding, playback is stopped (enters Standby). A-B Repeat restarts when you release the Shuttle switch.

To clear the start point (A) and end point (B)

- Press the REPEAT/SOUND button during A-B Repeat playback.
- Press the MENU button during A-B Repeat playback.
- Select the Group mode by pressing the GROUP button during A-B Repeat playback.
- Select the previous or next track by rotating the Shuttle switch during A-B Repeat playback.
(The A-B Repeat mode is not canceled.)

To cancel the A-B Repeat mode

Change the Repeat mode in the menu screen (page 17).

continued

Repeat mode

Playing specified sentences repeatedly (Sentence Repeat)

This function automatically detects only voice data from the setting point and repeats the voice data for setting counts. This is useful for language-learning material which has no background music.

Tip

The default repeat counts setting is 2 times for one sentence. But you can change the repeat counts setting. Refer to "Setting the repeat counts" on page 21.

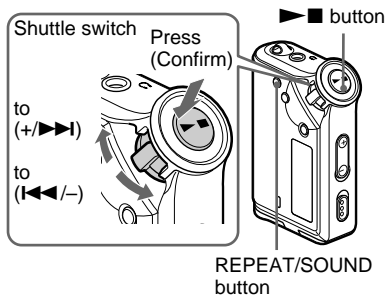

1 Select the Sentence Repeat mode (SENTENCE Rep) (page 17).

2 Press the ▶■ button to start playback.

3 Press the REPEAT/SOUND button to place the setting point during playback.

The Network Walkman detects spoken sections and non-spoken sections from the set point, and Sentence Repeat starts. (The spoken section is repeated once (during detection), and the setting is counted.)

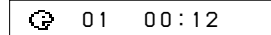

Notes

- You cannot use Sentence Repeat in the Group mode, or when the current time is displayed.
- A spoken or non-spoken section of less than 1 second will not be detected.
- If a non-spoken section is not detected until the track end, the track end point is recognized as a non-spoken section and Sentence Repeat begins from the previous spoken section.

To clear the setting point

- Press the REPEAT/SOUND button during Sentence Repeat playback.
- Press the MENU button during Sentence Repeat playback.
- Select the Group mode by pressing the GROUP button during Sentence Repeat playback.
- Select the previous or next track by rotating the Shuttle switch during Sentence Repeat playback. (The Sentence Repeat mode is not canceled.)

To cancel the Sentence Repeat mode

Change the Repeat mode in the menu screen (page 17).

Setting the repeat counts

You can set the repeat counts (1-9) of one sentence for the Sentence Repeat mode.

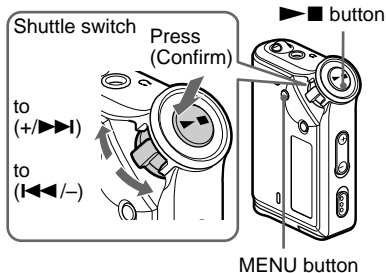

-
- 4** Rotate the Shuttle switch to select a desired repeat counts and press the **▶■** button to confirm.
-

- 5** Press the MENU button.
The display returns to the normal screen.
-

To cancel the Menu mode

Select [RETURN] in the menu screen or press the MENU button.

-
- 1** Press the MENU button.

The menu screen is displayed.

-
- 2** Rotate the Shuttle switch to select "REPEAT MODE >" and press the **▶■** button to confirm.
-

- 3** Rotate the Shuttle switch to select "SENTENCE Rep" and press the **▶■** button to confirm.

"COUNT:" is displayed on the screen.

Changing the display mode

You can view information such as track numbers or titles in the display while music is played or stopped. Change the display mode by operating the Shuttle switch in the Menu mode.

- Lap Time: Elapsed time display mode

The following will be displayed after a music title and artist name are displayed.

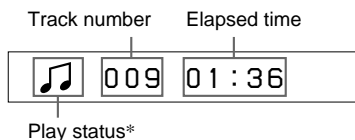

- * Play: Displays and alternately.
- Stop: Displays .
- Search track: Displays or .
- Fast-forward/Fast-rewind: Displays or .

- Title: Title display mode

When the music title includes more than 12 characters, the title will be automatically scrolled.

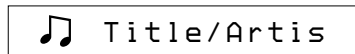

- Track info: Track information display mode

The track title, CODEC, and bit rate are displayed. When the information includes more than 12 characters, the information will be automatically scrolled.

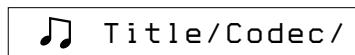

While searching, fast-forwarding, or fast-rewinding a track, the current playing position is displayed.

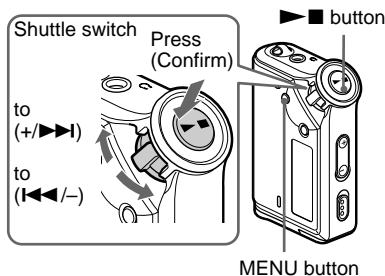

- 1 Press the MENU button.**

The menu screen is displayed.



- 2 Rotate the Shuttle switch to select "DISPLAY >" and press the ▶ button to confirm.**

The selected display mode blinks.

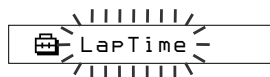

- 3 Rotate the Shuttle switch to select a desired display mode and press the ▶ button to confirm.**

The display switches to the selected display mode.



- 4 Press the MENU button.**

The display returns to the normal screen.

To cancel the Menu mode

Select [RETURN] in the menu screen or press the MENU button.

Note

The display automatically returns to the normal playback screen if you do not press any buttons for 60 seconds.

Selecting the group display mode

For any menu mode, you can select the group display by pressing the GROUP button.

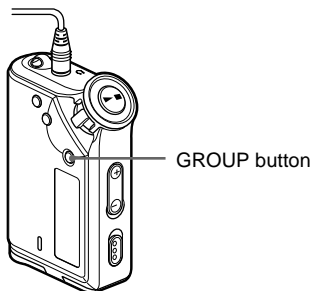

To cancel the Group mode

Press the GROUP button in the Group mode screen.

Note

The display automatically returns to the normal playback screen if you do not operate any button for 30 seconds.

Adjusting treble and bass (Digital sound preset)

You can adjust the treble and bass. You can preset two settings, which can be selected during playback.

Selecting the Sound quality

Default settings

Sound quality	SOUND 1 (S1)	SOUND 2 (S2)	SOUND OFF (NORMAL SOUND)
Bass	+1	+3	±0
Treble	±0	±0	±0

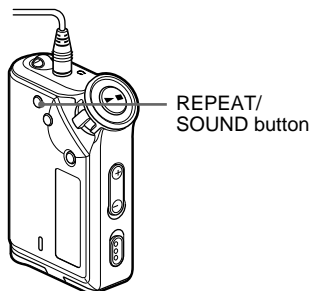

Press and hold the REPEAT/SOUND button for half a second.

The Sound quality setting is changed as follows:

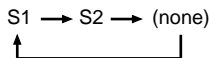

To return to the normal Sound quality

Select "SOUND OFF."

continued

Adjusting treble and bass (Digital sound preset)

Adjusting the Sound quality

You can adjust the sound quality of bass and treble parts.

Sound quality	Emphasis level
Bass	-4 to +3
Treble	-4 to +3

You can preset desired sound quality settings as “Sound 1” and “Sound 2.” While playing music, you can assign a preset sound quality to music.

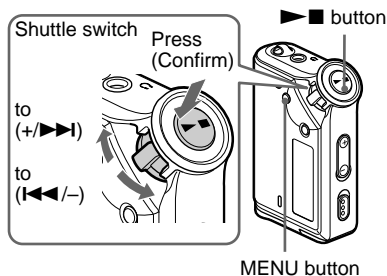

1 Press the MENU button.

The menu screen is displayed.



2 Rotate the Shuttle switch to select “SOUND >” and press the ► button to confirm.



3 Set the tone for “SOUND 1.”

- ① Rotate the Shuttle switch to select “SOUND 1 >” and press the ► button to confirm.
- ② “BASS:+1” appears, rotate the Shuttle switch to adjust the emphasis level of bass sound and press the ► button to confirm.
- ③ “TREBLE: 0” appears, rotate the Shuttle switch to adjust the emphasis level of treble sound and press the ► button to confirm.

4 Press the MENU button.

The display returns to the normal screen.

To adjust the “SOUND 2” setting

Select “SOUND 2” in step 3.

To cancel the Menu mode

Select [RETURN] in the menu screen or press the MENU button.

Locking the controls (HOLD)

You can protect your Network Walkman against accidental operation by using the HOLD function when carrying it.

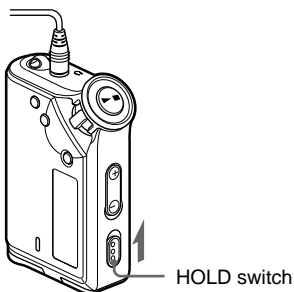

Slide the HOLD switch in the direction of the arrow.

All operation buttons are disabled.

If you press buttons while the HOLD switch is on, "HOLD" blinks in the display.

To release the HOLD function

Slide the HOLD switch in the opposite direction of the arrow.

Storing non-audio data

You can transfer data from the hard disk of your computer to the built-in flash memory using Windows Explorer.

The built-in flash memory is displayed in Windows Explorer as an external drive (for example: as the D drive).

Notes

- If you store a lot of non-audio data into the built-in flash memory, the space for audio data is reduced by the same amount.
- The NW-E99 contains two flash memories. When you connect the Network Walkman to a computer, two removable disks appear in Windows Explorer. The first removable disk is flash memory 1, and second is flash memory 2.

► **Adjusting the settings of your Network Walkman**

Adjusting the time setting of your Network Walkman to a computer's built-in clock

If the function is set to "ON," the time setting of your Network Walkman is automatically adjusted to the computer's built-in clock when your Network Walkman is connected and audio file transferring is executed (the SonicStage software must be started). "ON" is selected by default.

You cannot play a song with a limited playing period without the time setting of your Network Walkman. Be sure to adjust the time setting.

To set the date and time on your Network Walkman, refer to "Adjusting the current time setting (DATE-TIME)" on page 27.

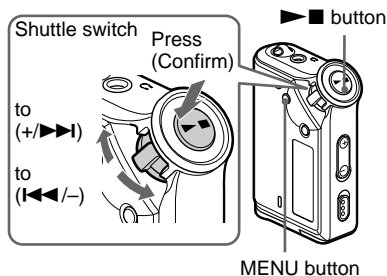

Changing the setting to "OFF"

The time setting of your Network Walkman does not change even when your Network Walkman is connected to a computer.

1 Press the MENU button.

The menu screen is displayed.



2 Rotate the Shuttle switch to select "PC CLK:" and press the ► button to confirm.



3 Rotate the Shuttle switch to select "OFF" and press the ► button to confirm.

4 Press the MENU button.

The display returns to the normal screen.

To change the setting to "ON"

Select "ON" in step 3.

To cancel the Menu mode

Select [RETURN] in the menu screen or press the MENU button.

Adjusting the current time setting (DATE-TIME)

You can set and display the current time.

You can also adjust the time setting of your Network Walkman to a computer's built-in clock by connecting your Network Walkman to the computer (page 26).

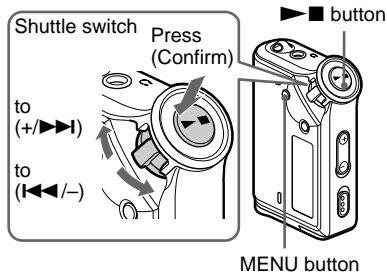

1 Press the MENU button.

The menu screen is displayed.



2 Rotate the Shuttle switch to select "DATE-TIME" and press the ▶■ button to confirm.

The "year" digit blinks.

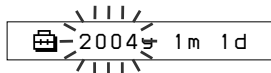

3 Rotate the Shuttle switch to adjust the "year" setting and press the ▶■ button to confirm.

The "month" digit blinks.

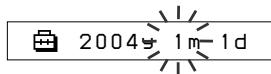

4 As you did in step 3, adjust the settings for "month" and "date."

After rotating the Shuttle switch to adjust the "date" setting and pressing the ▶■ button to confirm, the display switches to the time setting screen.

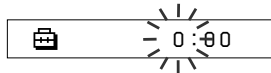

5 Rotate the Shuttle switch to adjust the "hour" setting and press the ▶■ button to confirm.

The "minute" digit blinks.



6 As you did in step 5, adjust the settings for "minute."

After rotating the Shuttle switch to adjust the "minute" setting and pressing the ▶■ button to confirm, the display switches to the time setting screen.

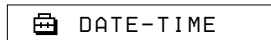

7 Press the MENU button.

The display returns to the normal screen.

continued

Adjusting the current time setting (DATE-TIME)

To cancel the Menu mode

Select [RETURN] in the menu screen or press the MENU button.

To display the current time

Press the MENU button and hold it.

You can display the current time while pressing the button.

Notes

- If the unit is not used for a long time, your settings of the date and time may be reset.
- If the current time is not set, the display for the date and time will be "-- --."
- If PC CLK is set to "ON" (page 26), the time setting of your Network Walkman is automatically adjusted to a computer's built-in clock when your Network Walkman is connected to the computer.
- Depending on the shipping area, the time display format of the unit is set to a 12-hour display or a 24-hour display.

You cannot switch between a 12-hour display and a 24-hour display in the unit.

A 24-hour display is shown in this manual.

Limiting the volume (AVLS)

You can set AVLS (Automatic Volume Limiter System) to limit the maximum volume to prevent auditory disturbance or distraction. With AVLS, you can listen to music at a comfortable volume level.

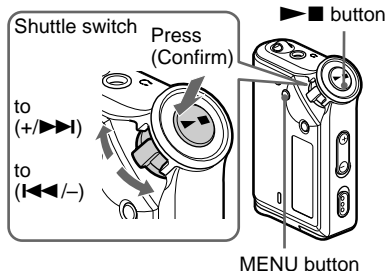

1 Press the MENU button.

The menu screen is displayed.



2 Rotate the Shuttle switch to select "AVLS" and press the ► button to confirm.

"OFF" blinks.



3 Rotate the Shuttle switch to select "ON" and press the ► button to confirm.

The ☺ (AVLS) indication is displayed.
The volume is kept at a moderate level.

4 Press the MENU button.

To change the setting to "OFF"

Select "OFF" in step 3.

To cancel the Menu mode

Select [RETURN] in the menu screen or press the MENU button.

Setting the volume using the preset volume function

There are two modes to adjust the volume level.

Manual mode:

Press the VOLUME +/- button to adjust the volume level in the range of 0 to 31.

Preset mode:

Press the VOLUME +/- button to set the volume level to any of three preset levels: LO, MID, or HI.

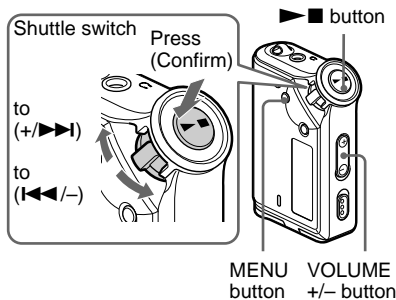

Setting a volume level of the preset mode

1 Press the MENU button.

The menu screen is displayed.



2 Rotate the Shuttle switch to select "VOL: MAN."

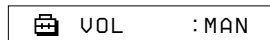

continued

Setting the volume using the preset volume function

- 3** Press the **▶■** button to confirm.
“MAN” blinks.

- 4** Rotate the Shuttle switch to select “SET >.”



- 5** Press the **▶■** button to confirm.
“VOL LO xx”* blinks.
* “xx” stands for numeric values of the volume level.



- 6** Set volume levels of three preset levels: **LO**, **MID**, or **HI**.

- ① Press the VOLUME +/- button to set the volume level of the LO preset.
- ② Rotate the Shuttle switch to select “VOL MID xx,” and then press the VOLUME +/- button to set the volume level of the MID preset.
- ③ Rotate the Shuttle switch to select “VOL HI xx,” and then press the VOLUME +/- button to set the volume level of the HI preset.

- 7** Press the **▶■** button to confirm.

- 8** Press the **MENU** button.

The display returns to the normal screen. With these settings, you can adjust the volume level to any of three preset levels: LO, MID, or HI.

To cancel the Menu mode

Select [RETURN] in the menu screen or press the MENU button.

Note

If AVLS (page 28) is set, the actual volume may be lower than the settings.

Releasing AVLS returns the volume to the preset level.

Switching to the manual mode

- 1** Press the **MENU** button.

The menu screen is displayed.

- 2** Rotate the Shuttle switch to select “VOL: SET.”

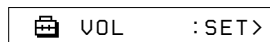

- 3** Press the **▶■** button to confirm.
“SET >” blinks.

- 4** Rotate the Shuttle switch to select “MAN.”

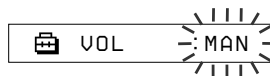

- 5** Press the **▶■** button to confirm.

- 6** Press the **MENU** button.

The display returns to the normal screen. With this setting, you can adjust the volume level by pressing the VOLUME +/- button.

Turning off the beep sound (BEEP)

You can turn off the beep sounds of your Network Walkman.

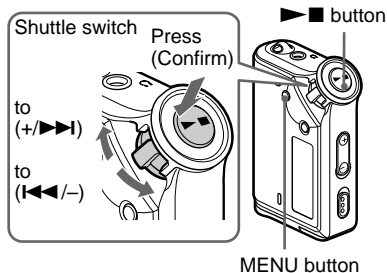

To change the setting to "ON"

Select "ON" in step 3.

To cancel the Menu mode

Select [RETURN] in the menu screen, or press the MENU button.

1 Press the MENU button.

The menu screen is displayed.

 REPEATMODE>

2 Rotate the Shuttle switch to select "BEEP:" and press the ▶■ button to confirm.

"ON" blinks.

 BEEP: ON

3 Rotate the Shuttle switch to select "OFF" and press the ▶■ button to confirm.

 BEEP: OFF

4 Press the MENU button.

The display returns to the normal screen.

Changing the backlight setting

You can select ON or OFF.

Menu	Backlight mode
OFF	Always off
ON	Turns on for three seconds after each operation (or until scrolling is complete)

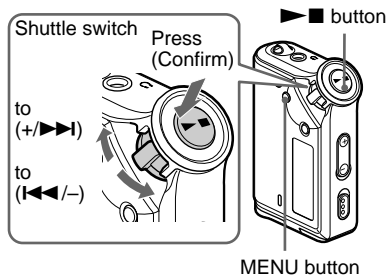

To set "ON"

1 Press the MENU button.

The menu screen is displayed.



2 Rotate the Shuttle switch to select "LIGHT:" and press the ▶■ button to confirm.

"OFF" blinks.



3 Rotate the Shuttle switch to select "ON" and press the ▶■ button to confirm.



4 Press the MENU button.

The display returns to the normal screen.

To change the setting to "OFF"

Select "OFF" in step 3.

To cancel the Menu mode

Select [RETURN] in the menu screen or press the MENU button.

► Other functions

Regrouping songs (REGROUP)

— NW-E95 only

The songs group function may be disabled* when a song has been deleted from or added to the built-in flash memory by operating the computer in which the SonicStage software is not installed (page 12). In such a case, you may enable the group function by regrouping audio file. When you need to edit audio file, make sure that you connect your Network Walkman to the computer and use the SonicStage software.

* The order of songs will not be changed even if the song group function is disabled.

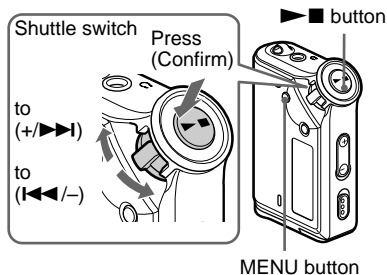

1 Press the MENU button.

The menu screen is displayed.

 REPEATMODE >

2 Rotate the Shuttle switch to select "REGROUP" and press the ►■ button to confirm.

 REGROUP : N

You cannot regroup audio file while playing music.

3 Rotate the Shuttle switch to select "Y" and press the ►■ button to confirm.

"Really?" is displayed.

 Really?

4 Press the ►■ button.

Regrouping starts and "REGROUPING" blinks. When regrouping audio file is complete, "COMPLETE" is displayed and the display returns to the indication in step 2.

5 Press the MENU button.

The display returns to the normal screen.

To cancel the Menu mode

Select [RETURN] in the menu screen or press the MENU button.

Note

You cannot regroup songs while playing music. ("REGROUP" will not be displayed in the menu screen.)

Tip

In some cases, you may not be able to restore the former grouping. When you need to edit audio file, connect your Network Walkman to the computer and use the SonicStage software.

Formatting memory (FORMAT)

You can use your Network Walkman to format the built-in flash memory. If memory is formatted, all data previously stored in the memory will be erased. Be sure to verify the data stored in the memory prior to formatting.

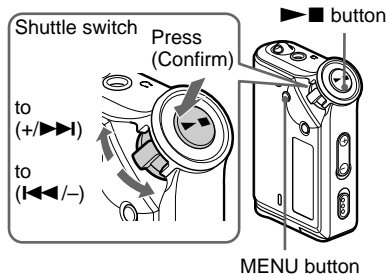

1 Press the MENU button.

The menu screen is displayed.

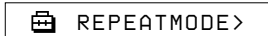

2 Rotate the Shuttle switch to select "FORMAT" and press the ► button to confirm.

– For the NW-E95

Proceed to step 4.



– For the NW-E99

Proceed to next step.

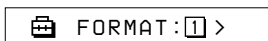

You cannot format memory while playing music.

3 Rotate the Shuttle switch to select "1 (flash memory 1)" or "2 (flash memory 2)" and press the ► button to confirm. (NW-E99 only)



4 Rotate the Shuttle switch to select "Y" and press the ► button to confirm.

"Really?" is displayed.

5 Press the ► button.

"FORMATTING" blinks and formatting starts.

When formatting is complete, "COMPLETE" is displayed and the display returns to the indication in step 2.

6 Press the MENU button.

The display returns to the normal screen.

To cancel the Menu mode

Select [RETURN] in the menu screen or press the MENU button.

To cancel formatting

Select "N" in step 4.

Notes

- You cannot format memory while playing music. ("FORMAT" will not be displayed in the menu screen.)
- The MP3 File Manager software and MP3 audio files transferred with this software are erased as a result of formatting. If the MP3 File Manager software is erased, you can restore it from the supplied CD-ROM, or download it from the Sony customer service website. For details, refer to "MP3 File Manager software operation" on page 45.

Precautions

On installation

- Never use your Network Walkman where it will be subjected to extremes of light, temperature, moisture or vibration.
- Never leave the Network Walkman exposed to high temperature, such as in a car parked in the sun or under direct sunlight.

On the headphones

Road Safety

Do not use headphones while driving, cycling, or operating any motorized vehicle. It may create a traffic hazard and is illegal in many areas. It can also be potentially dangerous to play your Network Walkman at a high volume while walking, especially at pedestrian crossings. You should exercise extreme caution or discontinue use in potentially hazardous situations.

Preventing hearing damage

Avoid using the headphones at a high volume. Hearing experts advise against continuous, loud and extended play. If you experience a ringing in your ears, reduce the volume or discontinue use.

Caring for others

Keep the volume at a moderate level. This will allow you to hear outside sounds and to be considerate to the people around you.

Warning

If there is lightning when you are using your Network Walkman, take off the headphones immediately.

On the use

- If you use a strap, be careful to avoid hooking it on objects you pass by.
- Do not use the Network Walkman on an aircraft.
- Do not use the Network Walkman in confined public areas where pacemakers for people with heart problems may be adversely affected.

On cleaning

- Clean your Network Walkman casing with a soft cloth slightly moistened with water or a mild detergent solution.
- Clean the headphone plug periodically.

Note

Do not use any type of abrasive pad, scouring powder or solvent such as alcohol or benzene as it may mar the finish of the casing.

If you have any questions or problems concerning your Network Walkman, please consult your nearest Sony dealer.

Troubleshooting

If you experience any of the following difficulties while using your Network Walkman, use this troubleshooting guide to help you to remedy the problem prior to consult a Sony dealer. Should any problem persist, consult your nearest Sony dealer. For trouble concerning operations while connected to your computer, please refer to “Troubleshooting” in the online help of the supplied software in addition.

To reset the player

If your Network Walkman does not operate normally or if there is no sound, even after checking the troubleshooting guide below, remove the battery, then re-insert it.

What happened?

On operating

Symptom	Cause/Remedy
There is no sound. Noise is generated.	<ul style="list-style-type: none">• The volume level is set to zero. → Turn the volume up (page 14).• The headphone jack is not connected properly. → Connect the headphone jack properly (page 14).• The headphone plug is dirty. → Clean the headphone plug with a soft dry cloth.• Songs with a limited playing period is played. → Songs with an expired playing period cannot be played.• No audio files are stored in the memory. → If “NO DATA” is displayed, transfer audio file(s) from the computer.
Buttons do not work.	<ul style="list-style-type: none">• The HOLD switch is set to on. → Set the HOLD switch to off (page 25).• Your Network Walkman contains moisture condensation. → Keep your Network Walkman aside for a few hours.• The remaining battery power is insufficient. → Replace the battery (page 9).
The volume is not loud enough.	The AVLS is enabled. → Disable the AVLS (page 28).
There is no sound from the right channel of the headphones.	<ul style="list-style-type: none">• The headphone jack is not fully connected. → Connect the headphone jack fully (page 14).• The extension headphone cord is not properly connected to the headphone jack of your Network Walkman or the headphone cord. → Connect them properly (page 14).
Playback has stopped suddenly.	The remaining battery power is insufficient. → Replace the battery (page 9).

On the display window

Symptom	Cause/Remedy
The backlight is not turned on.	LIGHT is set to "OFF." → In the menu mode, set "LIGHT" to "ON" (page 32).
"□" is displayed for a title.	Characters that cannot be displayed on your Network Walkman are involved. → Use the supplied SonicStage software to rename the title with appropriate characters.

On the connection with the computer or supplied software

Symptom	Cause/Remedy
The software cannot be installed.	An operating system not compatible with the software is used. → For details, refer to the separate manual "SonicStage operating instructions."
"CONNECT" is not displayed when connecting to the computer with the dedicated USB cable.	<ul style="list-style-type: none"> • Please wait for the authentication of the SonicStage software. • Another application is running on the computer. → Wait for a while and reconnect the USB cable. If the problem persists, disconnect the USB cable, restart the computer, and then reconnect the USB cable. • The dedicated USB cable is disconnected. → Connect the dedicated USB cable. • A USB hub is used. → Connecting via a USB hub is not guaranteed. Connect the dedicated USB cable directly to the computer.
Your Network Walkman is not recognized by the computer when it is connected to the computer.	The dedicate USB cable is disconnected. → Connect the dedicated USB cable.
Song cannot be transferred to your Network Walkman.	<ul style="list-style-type: none"> • The dedicated USB cable is not connected properly. → Connect the USB cable properly. • The free space of the built-in flash memory to where you want to transfer audio files to is insufficient. → Transfer any unnecessary songs back to your computer to increase free space. • You have already transferred to 400 songs or 400 groups to the built-in flash memory using the SonicStage software. → The maximum number of songs or groups that you can transfer to the built-in flash memory using the SonicStage software is 400.* * The 400 songs or groups refer to each flash memory in the case of NW-E99.

continued

Troubleshooting

Symptom	Cause/Remedy
Song cannot be transferred to your Network Walkman.	<ul style="list-style-type: none">You have already transferred to 40,000 songs or 400 groups to the built-in flash memory using the MP3 File Manager software.<ul style="list-style-type: none">→ The maximum number of songs and groups that you can transfer to the built-in flash memory using the MP3 File Manager software is 40,000 and 400 respectively.* (The maximum number of songs contained in one group is 100.)* The 40,000 songs or 400 groups refer to each flash memory in the case of NW-E99.Audio files with a limited playing period or playing count may not be transferred due to restrictions set by copyright holders. For details on the settings of each audio file, contact the distributor.
The number of audio files that can be transferred to is limited. (Available recording time is short.)	<ul style="list-style-type: none">The free space of the built-in flash memory to where you want to transfer to is not enough for the size of audio files you wish to transfer.<ul style="list-style-type: none">→ Transfer any unnecessary audio files back to the computer to increase free space.→ Try to transfer audio files to another flash memory. (NW-E99 only)Non-audio data is stored in the built-in flash memory to where you want to transfer audio files to.<ul style="list-style-type: none">→ Move non-audio data to the computer to increase free space.
The operation of the Network Walkman becomes unstable while it is connected to the computer.	USB hub or USB extension cable is used. <ul style="list-style-type: none">→ Connecting via a USB hub or USB extension is not guaranteed. Connect the dedicated USB cable directly to the computer.
“Failed to authenticate Device/Media” is displayed on the computer screen while connecting the Network Walkman to the computer.	Your Network Walkman is not connected to the computer properly. <ul style="list-style-type: none">→ Quit the SonicStage software and verify the connection of the dedicated USB cable. Restart the SonicStage software.

Other

Symptom	Cause/Remedy
There is no beep sound when your Network Walkman is operated.	BEEP is set to “OFF.” <ul style="list-style-type: none">→ In the menu mode, set “BEEP” to “ON” (page 31).
Your Network Walkman gets warm.	Sometimes, during normal conditions, the player becomes slightly warm.

Messages

Follow the instructions below if an error message appears in the display.

Message	Meaning	Remedy
ACCESS	Accessing the built-in flash memory.	Please wait for access to complete. This message appears while transferring audio files and during initialization of the built-in flash memory.
AVLS	The volume level exceeds the rated value while the AVLS is enabled.	Turn the volume down or disable the AVLS.
CANNOT PLAY	<ul style="list-style-type: none"> Your Network Walkman cannot play certain files because of incompatible formats. Transferring has been interrupted forcefully. 	If the file cannot be played, you can erase it from the built-in flash memory. For details, refer to “To delete abnormal data from the built-in flash memory” (page 40).
CONNECT	Your Network Walkman is connected to the computer.	You can operate your Network Walkman using the SonicStage or MP3 File Manager software, but you cannot operate the controls on your Network Walkman.
ERROR	A malfunction is detected.	Please consult your nearest Sony dealer.
EXPIRED	<ul style="list-style-type: none"> The song with a playback restriction has expired. The current time has not been set to play the song with a playback restriction. The song is protected by the playback restriction that is not compatible with your Network Walkman. 	<ul style="list-style-type: none"> If the current time has not been set yet, set the current time in the menu mode (page 27). If song cannot be played, you can erase it from the built-in flash memory. For details, refer to “To delete abnormal data from the built-in flash memory” (page 40). Your Network Walkman does not support contents with a limited playing count. For details, refer to “Note on playing songs with a limited playing count” (page 13).
FILE ERROR	<ul style="list-style-type: none"> The file cannot be read. The file is not normal. 	Transfer the normal audio file back to the computer and then format your Network Walkman. For details, refer to “To delete abnormal data from the built-in flash memory” on page 40.
HOLD	All operation buttons are disabled since the HOLD switch is set to on.	Set the HOLD switch to off to operate the buttons.
LOW BATT	The battery is low.	You must change the battery (page 9).
MEMORY FULL*	The memory is full or there are 400 groups.	Delete songs or groups. A group without song is also regarded as one group. To delete groups without song, use the SonicStage software.

continued

Troubleshooting

Message	Meaning	Remedy
MG ERROR	An unauthorized distribution file is detected for copyright protection.	Transfer the normal audio file back to the computer and then format your Network Walkman. For details, refer to “To delete abnormal data from the built-in flash memory” on page 40.
NO DATA	There is no audio files in the built-in flash memory.	If there is no audio files in the built-in flash memory, use the SonicStage software to transfer audio files.

* This message is displayed for either flash memory. (NW-E99 only)

To delete abnormal data from the built-in flash memory

If “CANNOT PLAY,” “EXPIRED,” “FILE ERROR,” or “MG ERROR” is displayed, there is a problem with all or part of the data stored in the built-in flash memory.

Please follow the procedures below to erase data you cannot play.

- 1** Connect your Network Walkman to the computer, and start the SonicStage software.
- 2** If you have already specified the data with problems (such as expired songs), erase the data from the Portable Player window of the SonicStage software.
- 3** If the problem persists, transfer all data without problems back to the computer using the SonicStage software while your Network Walkman is connected to the computer.
- 4** Disconnect your Network Walkman from the computer and then format the built-in flash memory using the FORMAT menu (page 34).

Specifications

Maximum recording time (Approx.)

NW-E95

ATRAC3*

8 hr. 20 min. (132 kbps)
10 hr. 00 min. (105 kbps)
16 hr. 50 min. (66 kbps)

ATRAC3plus*

4 hr. 00 min. (256 kbps)
17 hr. 10 min. (64 kbps)
23 hr. 20 min. (48 kbps)

MP3

4 hr. 00 min. (256 kbps)
8 hr. 00 min. (128 kbps)

NW-E99

ATRAC3*

16 hr. 40 min. (132 kbps)
21 hr. 00 min. (105 kbps)
33 hr. 40 min. (66 kbps)

ATRAC3plus*

8 hr. 00 min. (256 kbps)
34 hr. 20 min. (64 kbps)
46 hr. 40 min. (48 kbps)

MP3

8 hr. 00 min. (256 kbps)
16 hr. 00 min. (128 kbps)

* The values for ATRAC3, ATRAC3plus apply if the MP3 File Manager software has been erased from the built-in flash memory.

Sampling frequency

ATRAC3, ATRAC3plus, MP3: 44.1 kHz

Audio compression technology

Adaptive Transform Acoustic Coding3 (ATRAC3)
Adaptive Transform Acoustic Coding3plus
(ATRAC3plus)
MPEG1 Audio Layer-3 (MP3): 8 to 320 kbps,
variable bit rate-compliant

Frequency response

20 to 20,000 Hz (single signal measurement)

Output

Headphone: Stereo mini-jack

Signal-to-noise ratio (S/N)

80 dB or more (excluding ATRAC3 66 kbps)

Dynamic range

85 dB or more (excluding ATRAC3 66 kbps)

Operating temperature

5°C to 35°C (67°F to 95°F)

Power source

Size AAA (LR03) alkaline battery

Battery life (continuous playback)

ATRAC3 format: Approximately 70 hours
(Playback at 105 kbps)
ATRAC3plus format: Approximately 60 hours
(Playback at 48 kbps)
MP3 format: Approximately 50 hours
(Playback at 128 kbps)

Dimension

56 × 37.3 × 15 mm (2 1/4 × 1 1/2 × 19/32 inches)
(w/h/d, projecting parts not included)

Mass

Approx. 40 g (2 oz) (battery not included)

Supplied accessories

Headphones (1)
Dedicated USB cable (1)
Carrying pouch (1)
Neck strap (1)
Extension headphone cord (1)
CD-ROM for the SonicStage software (1)
Operating Instructions (1)
SonicStage Operating Instructions (1)
CD-ROM for the Operating Instructions and
SonicStage Operating Instructions (1)

Pour les utilisateurs en France

En cas de remplacement des écouteurs,
référez-vous au modèle d'écouteurs adaptés à
votre appareil et indiqué ci-dessous.
MDR-E838SP

Design and specifications are subject to
change without notice.

US and foreign patents licensed from Dolby
Laboratories.

Glossary

MagicGate

Copyright protection technology that consists of authentication and encryption technology. Authentication ensures that protected content is transferred only between compliant devices and media, and that protected content is recorded and transferred in an encrypted format to prevent unauthorized copying or playback.

Note

MAGICGATE is terminology denoting the copyright protection system developed by Sony. It does not guarantee conversion among other media.

OpenMG

Copyright protection technology that securely manages music content from the EMD/Audio CD on a personal computer. Application software that is installed on the computer encrypts the digital music content when recording on the hard drive. This allows you to enjoy music content on the computer, but prevents unauthorized transmission of this content across a network (or elsewhere). This PC copyright protection complies with “MagicGate”, and allows you to transfer digital music content from a PC’s hard drive to a compliant device.

ATRAC3

ATRAC3, which stands for Adaptive Transform Acoustic Coding3, is audio compression technology that satisfies the demand for high sound quality and high compression rates. The ATRAC3 compression rate is approximately 10 times higher than that of the Audio CD, resulting in an increased data capacity for the media.

ATRAC3plus

ATRAC3plus, which stands for Adaptive Transform Acoustic Coding3plus, is audio compression technology that compresses data higher than ATRAC3. The ATRAC3plus is new audio compression technology that enables equal or higher quality sound comparing to ATRAC3.

Bit rate

Indicates the data amount per second. The rate is reflected in bps (bit per second). 64 kbps means 64,000 bits of information per second. If the bit rate is large, that means a large amount of information is used to play music. Comparing music of the same format (e.g., ATRAC3plus), 64 kbps data offers better sound quality than 48 kbps data. However, audio files in formats such as MP3 have different encoding methods, and thus sound quality cannot be determined by simply comparing the bit rate.

MP3

MP3, which stands for MPEG-1 Audio Layer-3, is a format standard for music file compression. It was codified by the Motion Picture Experts Group, a working group of ISO (International Organization for Standardization).

It compresses audio CD data to approximately one tenth its original size. Because the MP3 encoding algorithm has been made publicly available, there are various encoders and decoders that are compliant with this standard.

Menu list

Press the **MENU** button to display the menu mode and use the **Shuttle** switch (rotate: select/press: confirm) to change the settings of your Network Walkman.

For details about each menu, refer to the pages in parentheses. The menu with a ">" mark will be followed by a detailed-setting screen when you press the **▶■** button to confirm.

Display (Menu mode)	Purposes
REPEAT MODE >	You can select your favorite repeat mode. (page 17)
DISPLAY > (Display mode)	You can select your favorite display mode. (page 22)
VOL: (Preset volume)	You can preset your desired volume level. (page 29)
SOUND > (Digital sounds preset)	You can preset your desired sound quality. (page 23)
AVLS: (Automatic Volume Limiter System)	You can set to "ON" or "OFF." (page 28)
BEEP: (Operation sounds setting)	You can set to "ON" or "OFF." (page 31)
LIGHT: (LCD backlight setting)	"OFF": Always off "ON": Turns on for three seconds after each operation (page 32)
DATE-TIME (Current time setting)	You can set and display the current time. (page 27)
PC CLK: (Adjusting the time setting to a computer built-in clock)	You can adjust the time setting of your Network Walkman to a computer built-in clock. (page 26)

Display (Menu mode)	Purposes
FORMAT > (Formatting memory)	You can format the built-in flash memory. (page 34)
REGROUP > (Regrouping data) (NW-E95 only)	You can restore the group function. (page 33)
[RETURN]	You can switch to the normal mode by selecting [RETURN] and pressing the ▶■ button.

What you can do with the MP3 File Manager

You can transfer MP3 audio files easily, using the MP3 File Manager software, to your Network Walkman in the same format (MP3), unlike the SonicStage software, which converts MP3 audio files into ATRAC3plus format.

The MP3 File Manager software is pre-installed on the Network Walkman at the factory; thereby no installation is necessary.

However, be sure to install the SonicStage software from the supplied CD-ROM in your computer before using the MP3 File Manager software. The computer will not recognize your Network Walkman unless you install the SonicStage software (in the supplied CD-ROM) first. If you use a computer that is not installed with the SonicStage software, you need to install the driver file for your Network Walkman from the Sony customer service website [<http://www.support-nwalkman.com>].

System requirements

- **OS:** Windows XP Media Center Edition 2005
Windows XP Media Center Edition 2004
Windows XP Media Center Edition
Windows XP Professional
Windows XP Home Edition
Windows 2000 Professional
Windows Millennium Edition
Windows 98 Second Edition
- **CPU:** Pentium II 400MHz or higher
- **RAM:** 64MB or more
- **HDD:** 5MB or more
- **Display:** 16-bit color or higher, 800 × 600 dots or better
- **USB port** (Supports USB (Previously called USB1.1))

On language support

The ability to display the languages on your MP3 File Manager will depend on the installed OS on your PC. For better results, please ensure that the installed OS is compatible with the desired language you want to display.

- We do not guarantee all the languages will be able to be displayed properly on your MP3 File Manager.
- User-created characters and some special characters may not be displayed.

Transferring MP3 audio files from the computer to your Network Walkman

1 Connect your Network Walkman to your computer.

Connect the small connector of the supplied dedicated USB cable into the USB jack on the Network Walkman, then the large connector to a USB port on your computer.

“CONNECT” appears in the display.

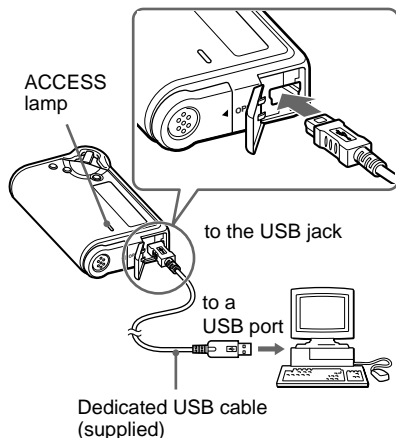

2 Click [My Computer]-[removable disk:]* on your computer.

* **NW-E95 only**

[Network Walkman] in the case of Windows XP Media Center Edition 2004/Windows XP Media Center Edition/Windows XP Professional/Windows XP Home Edition

* **NW-E99 only**

The NW-E99 contains two flash memories. When you connect the Network Walkman to a computer, two removable disks appear in Windows Explorer. MP3 File Manager is pre-installed in the first removable disk (flash memory 1).

3 Click [Esys] folder to open in the removable disk.

4 Double-click [MP3FileManager.exe] to start it.

5 Select a flash memory from the transfer destination list (page 48). (NW-E99 only)

6 Drag the MP3 audio files you want to transfer to your Network Walkman and drop them to the MP3 File Manager screen. You can also transfer MP3 format audio files to your Network Walkman by dragging a folder.



The display is for the NW-E99.

Notes

- Do not disconnect the USB cable or remove your Network Walkman when the MP3 File Manager software is running. If you do, operation is not guaranteed.
- The ACCESS lamp blinks while your Network Walkman accesses the computer.
- Do not disconnect the USB cable or remove your Network Walkman when the ACCESS lamp is blinking. The data being transferred may be destroyed.
- Do not put your computer into hibernation or standby when the MP3 File Manager software is running.
- Install Service Pack 3 or later when you use Windows 2000.
- With the Network Walkman, priority is given to the display of ID3 Tag information. (ID3 Tag is the format that adds music title or artist name information, etc., to an MP3 file. The Network Walkman supports version 1.0/1.1/2.2/2.3/2.4.)
- Use of your Network Walkman with a USB hub or a USB extension cable is not guaranteed. Always connect your Network Walkman to the computer directly using the dedicated USB cable.
- Some USB devices connected to the computer may interfere with the proper operation of your Network Walkman.
- The control buttons on your Network Walkman are all disabled while it is connected to a computer.
- You can display the data stored in the built-in flash memory using Windows Explorer when your Network Walkman is connected to the computer.
- MP3 audio files compliant with the MP3 File Manager software are the one sampling frequency rate of 44.1 kHz, bit rate 8 – 320 kbps.

If the MP3 File Manager software is accidentally erased by formatting, etc., you can restore it from the supplied CD-ROM by following the procedure below:

- 1** Connect your Network Walkman to your computer with the USB cable.
- 2** Insert the supplied CD-ROM into your computer.
- 3** Open the CD-ROM, select the [MP3FileManager] folder and open it with Windows Explorer.
- 4** Select the folder ([English], [French]^{*1}) and open it with Windows Explorer.
- 5** Double-click the installation file [MP3FileManager_1.x_Update_ENU.exe]^{*2}, [MP3FileManager_1.x_Update_FRA.exe]^{*1}.

Installation starts.

Follow the instructions of the installation wizard.

^{*1} The Help menu is displayed in French; the Operation menu is displayed in English.

^{*2} "1.x" refers to the MP3 File Manager software version.

NW-E95: Version 1.1



NW-E99: Version 1.2

(You can also download the MP3 File Manager software from the Sony customer service website [<http://www.support-nwalkman.com>].)

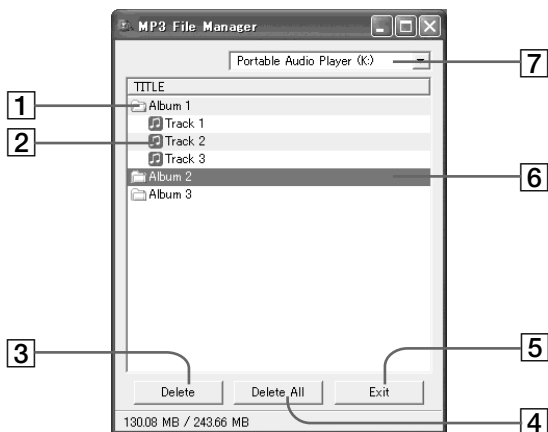
Display of MP3 File Manager



The display is for the NW-E99.

- 1** Album list
Double click this to show the included track list. Double click again to hide the track list.
- 2** Track list
- 3** 
Click this button to erase selected albums or tracks.
- 4** 
Click this button to erase all the albums or tracks.
- 5** 
Clicks this button to finish the MP3 File Manager.

- 6** A selected line turns blue
You can select several albums or tracks simultaneously using the CTRL key or Shift key.
- 7** Transfer destination list (NW-E99 only)
You can select one flash memory from this list.

Note

Audio files transferred to the built-in flash memory using SonicStage software are not displayed on the MP3 File Manager screen. In addition, audio files transferred to the built-in flash memory using MP3 File Manager software are not displayed on the SonicStage software screen.

Erasing audio file

You can erase a song stored in the built-in flash memory by track or album using MP3 File Manager.

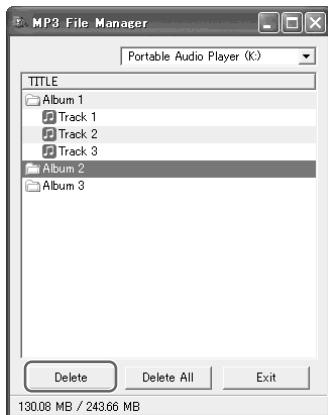

The display is for the NW-E99.

- 1 Open the MP3 File Manager.
- 2 Select a flash memory from the transfer destination list. (NW-E99 only)
- 3 Select the title you want to erase.
- 4 Click the button in the screen.

Tip

You can select several albums or tracks simultaneously using CTRL key or Shift key. However, albums and tracks cannot be selected simultaneously.

Ordering audio file

You can move a song stored in the built-in flash memory by track or album using MP3 File Manager.



The display is for the NW-E99.

- 1 Open the MP3 File Manager.
- 2 Select a flash memory from the transfer destination list. (NW-E99 only)
- 3 Select the title you want to move.
- 4 Move it by drag and drop.

Index

A

A-B Repeat	19
ACCESS lamp	12, 46
Accessories	8
ATRAC3	42
ATRAC3plus	42
Audio CDs	6
AVLS (Limiting the volume)	11, 28

B

Backlight	32
Battery	9
BEEP (Beep sound)	31
Bit rate	42

C

CD (Audio CDs)	6
CD-ROM	8, 12
Clock	26, 27
Computer	6, 12, 45

D

DATE-TIME	27
Display	11, 18, 39
Display mode	22
Download	6

E

EMD service	6, 13
Explorer (Windows Explorer)	13, 25, 47

F

Fast-forward	16
Fast-rewind	16
Formatting	34

G

Group	15, 23
-------	--------

H

Headphones	8, 14, 35
HOLD function (Locking the controls)	25

L

LIGHT	32
Limiting the volume (AVLS)	28
Listening	14
Locking the controls (HOLD function)	25

M

MENU button	16-22, 24, 26-34
Menu list	44
MP3	6, 12, 43, 45
MP3 File Manager software	45

O

OpenMG 42

P

PC CLK 26

Playback 14

R

Regroup (NW-E95 only) 33

Remaining battery indication
9

Repeat 17

Repeat count 21

Reset 36

RETURN 44

S

Sentence Repeat 20

Serial Number 8

Shuffle Repeat 17

Skip to the beginning of a track
16

SonicStage 12

Sound preset (Digital sound preset)
23

T

Time Setting 26, 27

Title 22

Track Repeat 18

Transferring 6, 12, 46

Troubleshooting 36

U

USB cable 8, 12, 46

V

Volume 28

W

WAV format 6

Windows Explorer 13, 25, 47

<http://www.sony.net/>

Printed in China
