

SONY



© 2007 Sony Corporation Printed in Malaysia  
3-093-018-12 (1)

**Quick Start Guide**  
**NW-E013 / E015 / E016 / E013F / E015F / E016F**

## Owner's Record

The model and serial numbers are located on the back of the player. Record them in the space provided below. Refer to these numbers in the spaces whenever you call upon your Sony dealer regarding this product.

Model No. \_\_\_\_\_

Serial No. \_\_\_\_\_

## About the Manual

- The use of the player is described in this “Quick Start Guide,” in the “Operation Guide” (PDF file), and in the SonicStage Help (accessible from the “Help” menu of SonicStage), etc.
- **Quick Start Guide:** Explains basic operation of the player, including importing, transferring, and playing music songs.
- **Operation Guide:** Explains advanced features of the player and offers troubleshooting information.
- **SonicStage Help:** Explains details of using the SonicStage software.
- **Precautions:** Explains important notes to prevent accidents.
- **Troubleshooting:** Explains symptoms, causes and remedies when the player has problems.

## To learn about advanced features of the player

- Refer to the Operation Guide (PDF file). To view the Operation Guide;
- Click [Start] – [All Programs] – [SonicStage] – [NW-E010 Series Operation Guide].
- You need Adobe Acrobat Reader 5.0 or later, or Adobe Reader software in your computer. Adobe Reader can be downloaded from the Internet for free.

## For the latest information

If you have any questions about or issue with this product, visit the following web sites.

For customers in the USA: <http://www.sony.com/walkmansupport>

For customers in Canada: <http://www.sony.ca/ElectronicsSupport/>

For customers in Europe: <http://support.sony-europe.com/DNA>

For customers in Latin America: <http://www.sony-latin.com/pa/info/>

For customers in other countries/regions: <http://www.css.ap.sony.com>

For customers who purchased the overseas models: <http://www.sony.co.jp/overseas/support/>

## Table of Contents

<b>Introduction .....</b>	<b>6</b>
<b>Getting Started .....</b>	<b>8</b>
Supplied Items.....	8
Charging the battery .....	9
Installing SonicStage.....	10
<b>Importing Music .....</b>	<b>12</b>
<b>Transferring Music.....</b>	<b>14</b>
<b>Playing Music .....</b>	<b>16</b>
Turning the player on and off .....	17
To delete songs .....	17
<b>Parts and Controls .....</b>	<b>18</b>
<b>About the HOME menu .....</b>	<b>22</b>
<b>Listening to FM Radio</b>	
<b>(NW-E013F/E015F/E016F only) .....</b>	<b>24</b>

## For the Customers in Netherlands Voor de klanten in Nederland



Gooi de batterij niet weg maar lever deze in als klein chemisch afval (KCA).

## Notice for the customer in the countries applying EU Directives

According to the EU Directive related to product safety, EMC and R&TTE, the manufacturer of this product is Sony Corporation, 1-7-1 Konan, Minato-ku, Tokyo, Japan. The Authorized Representative is Sony Deutschland GmbH, Hedelfinger Strasse 61, 70327 Stuttgart, Germany. For any service or guarantee matters please refer to the addresses given in separate service or guarantee documents.

## Notice for users

- The recorded song is limited to private use only. Use of the song beyond this limit requires permission of the copyright holders.
- Sony is not responsible for incomplete recording/downloading or damaged data due to problems of the player or computer.
- The ability to display the languages on supplied software will depend on the installed OS on your computer. For better results, please ensure that the installed OS is compatible with the desired language you want to display.
  - We do not guarantee all the languages will be able to be displayed properly on your SonicStage.
  - User-created characters and some special characters may not be displayed.
- Depending on the types of the text and characters, the text shown on the player may not be displayed properly on device. This is due to:
  - The capacity of the connected player.
  - The player is not functioning normally.
  - Content information is written in the language or the character that is not supported by the player.

## On static electricity from the human body

On rare occasions, you may not be able to operate the player due to strong static electricity from the human body. If this happens, leave the player for about 30 seconds to one minute. You will then be able to operate the player normally again.

## On condensation

Note that condensation may form temporarily in cases such as when the player is moved quickly from a low-temperature environment to a high-temperature environment or used in a room that has a heater just turned on.

Condensation creates a phenomenon where moisture in the air adheres to surfaces such as metal panels, etc., and then changes to liquid. If condensation forms in the player, leave it turned off until the condensation disappears. If you use the player with condensation present, a malfunction may result.

## On sample audio data\*

The player is pre-installed with sample audio data. To delete this audio data, delete it using SonicStage.

If you delete sample audio data, you cannot restore it. We cannot supply any replacement data.

\* In some countries/regions some sample data is not installed.

# Introduction

Thank you for purchasing the NW-E013/E015/E016/E013F/E015F/E016F\*.

To begin using the player, first import music songs into your computer using the SonicStage software, and then transfer them to the player.

After transferring the music songs to the player, you can enjoy them wherever you go.

Be sure to install the “SonicStage” software from the supplied CD-ROM in your computer.

## 1 Getting Started

(See page 8)

## 2 Importing Music

(See page 12)

## 3 Transferring Music

(See page 14)

## 4 Playing Music

(See page 16)

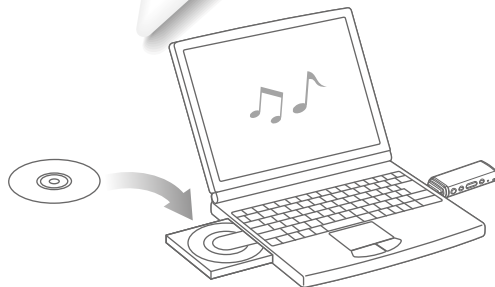

\* Depending on the country/region in which you have purchased the player, some models may not be available.

# 1 Getting Started

## Supplied Items

Check the following items.

- Headphones (1)
- CD-ROM\*<sup>1</sup> (1)
  - SonicStage software
  - Operation Guide (PDF file)
- Quick Start Guide (this manual) (1)
- Precautions (1)
- Troubleshooting (1)

\*<sup>1</sup> Do not attempt to play this CD-ROM in an audio CD player.

## Charging the battery

The player's battery is recharged while the player is connected to a running computer. Remove the USB cap and connect the USB connector to a USB port on your computer.

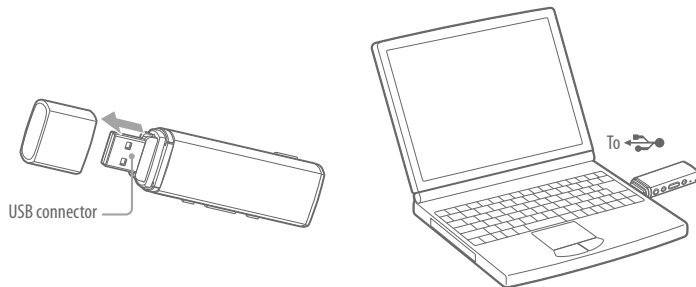

When the remaining battery indication of the display shows: **Full**, charging is complete. When you use the player for the first time, or if you have not used the player for a long time, recharge it fully until **Full** appears on the screen. Charging takes about 60 minutes when the battery power is completely used up.



### Note

- Be careful not to accidentally bump or put stress on the player when it is connected to your computer. It may be damaged.

## Installing SonicStage

Install SonicStage according to the following instructions.

Install SonicStage and the Operation Guide (PDF file) following the instructions.

If SonicStage is already installed, it will be overwritten. All functions and audio data from the previous installation will be preserved on the new installation. We recommend to backup data with SonicStage.

### 1 Turn on the computer and start Windows.

Log on as an administrator.

### 2 Quit all activated software programs on your computer.

Be sure to quit any anti-virus software as it may strain the CPU.

### 3 Insert the supplied CD-ROM into your computer.

The install wizard will start automatically and the Main Menu appears.

### 4 Install SonicStage and Operation Guide (PDF file).

Click [Install SonicStage] from the Main Menu, and follow the on-screen instructions. Installation may take 20 to 30 minutes depending on your computer. If prompted, restart the computer after installing.

#### To install the Operation Guide (PDF file)

Click [Install Hardware Operation Guide (PDF)], and then follow the on-screen instructions.

## When installation is not successful

For details, see “Troubleshooting.”

### Visit the following web sites:

For customers in the USA: <http://www.sony.com/walkmansupport>

For customers in Canada: <http://www.sony.ca/ElectronicsSupport/>

For customers in Europe: <http://support.sony-europe.com/DNA>

For customers in Latin America: <http://www.sony-latin.com/pa/info/>

For customers in other countries/regions: <http://www.css.ap.sony.com>

For customers who purchased the overseas models: <http://www.sony.co.jp/overseas/support/>

### If the issue persists:

Consult your nearest Sony dealer.

Import audio data to your computer using the SonicStage. The methods of importing songs of CD are described here.



### 1 Double-click icon on the desktop.

SonicStage starts up.

When SonicStage is activated for the first time, the startup setting screen appears. Follow the on-screen instructions.

### 2 Insert the audio CD that you want to import to hard drive of your computer.

You can obtain CD information (song name or artist name, etc.) while connected to the Internet.

### 3 Place the pointer over [Music Source] at the top of the screen and click [Import a CD].

The screen for importing is displayed, and the song list of the CD appears.

### 4 Click at the right of the screen.

Importing audio data starts.

#### Hint



- SonicStage also offers the following additional features.
  - Importing audio files downloaded from the Internet and audio files stored on your computer, such as MP3, WMA\*, ATRAC, or AAC\*, etc., format files.
  - \* WMA/AAC format audio files that are copyright-protected cannot be played back on the player.
  - Importing only selected audio files from a CD.
  - Changing the audio formats and bit rates of audio files.

#### Note

- While SonicStage is in use (recording CDs, importing audio data or transferring data to the player), and the computer enters Sleep/Standby/Hibernate status, data may be lost and SonicStage may not restore properly.

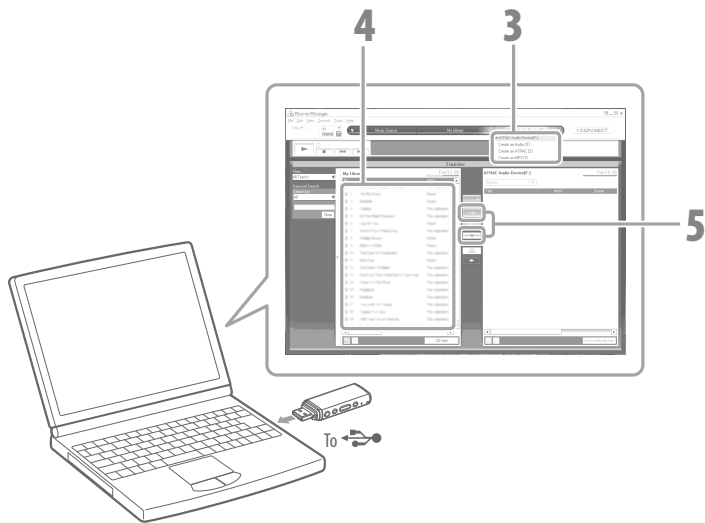
Connect the player to your computer and transfer the audio data to the player. Be sure to use SonicStage when transferring songs (audio data) to the player. Songs which are transferred using Windows Explorer cannot be played back on the player.



- 1 Double-click the  icon on the desktop.**  
SonicStage starts up.
- 2 Connect the player directly to a USB port on your computer.**  
Be sure to remove the USB cap, and then connect to the player.
- 3 Place the pointer over [Transfer] and select [ATRAC Audio Device] from the transfer destination list.**
- 4 Select an audio file(s) or album you want to transfer.**
- 5 Click  to start transferring.**  
To stop transferring, click .

### Note

- Be careful not to accidentally bump or put stress on the player when it is connected to your computer. It may be damaged.

### Hints

- When you register a cover art for an album on SonicStage, you can display the cover art for an album on the player after transferring the audio data to the player. For details on how to register cover art, refer to SonicStage Help.
- You can create and transfer playlists that group your favorite songs in your desired order into a list. Select the playlist in the SonicStage display mode to transfer playlists.



## 4 Playing Music

You can play songs transferred to the player using SonicStage.

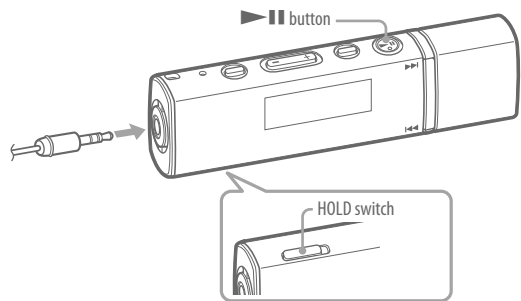

### 1 Check that the HOLD function of the player is released.

By sliding the HOLD switch to the opposite direction of the arrow (▷), the HOLD function is released.

### 2 Press the ▶|| button.

When starting playback, ▶ appears in the display, and if the ▶|| button is pressed again, || appears and playback pauses. After a few seconds, "POWER OFF" appears and the display goes off automatically, then the player enters Sleep status.

#### Hint

- You can also operate the following using the player. For details, see "Playing Songs" or "Settings" in "Operation Guide (PDF file)."
  - Changing song order
  - Playing songs in repeat or shuffle mode
  - Adjusting to your desired sound quality

## Turning the player on and off

### To turn on the player

Press any button to turn the player on.

### To turn off the player

When you pause song playback or FM reception (NW-E013F/E015F/E016F only) by pressing the ▶|| button, after a few seconds, "POWER OFF" appears and the display goes off automatically, then the player enters Sleep status. The player consumes very little battery power.

## To delete songs

To delete songs on the player, delete them using SonicStage. For details, refer to the SonicStage Help.

## Front

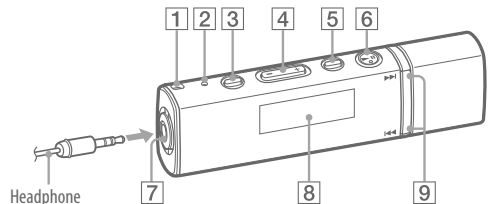

### 1 Strap hole

This is used to attach a strap (sold separately).

### 2 RESET button

Resets the player when you press the RESET button with a small pin, etc.

### 3 PLAY MODE/SOUND\*<sup>1</sup> button

Switches the play mode. Press and hold this button to change the sound quality setting.

### 4 VOL +\*<sup>2</sup>/- button

Adjusts the volume.

### 5 FOLDER/HOME\*<sup>1</sup> button

When you press this button while playing or pausing a song, you can switch between Song control mode and Folder mode. In Song control mode, the player skips to the beginning of the song. In Folder mode, the player skips to the beginning of the album/artist. Press and hold this button to display the HOME menu (ⓘ page 22).

### 6 ►||\*<sup>2</sup> button

Starts song playback. When starting playback, ► appears in the display, and if the ►|| button is pressed again, || appears and playback pauses.

### 7 Headphone jack

For connecting the headphones. Connect until it clicks into place. If connecting the headphones improperly, it may not sound right.

### 8 Display

See ⓘ page 21.

### 9 I<<</>>> button

Selects a song, album, artist, or menu item. You can also skip to the beginning of the song/album/artist, fast-forward or fast-rewind as follows.

#### • Pressing the I<<< (>>>) button:

Skips to the beginning of the current (or next) song/album/artist.

#### • Pressing and holding the I<<< (>>>) button during playback and releasing it at the desired point in Song control mode:

Fast-rewinds (or fast-forwards) the current song.

#### • Pressing and holding the I<<< (>>>) button soon after entering pause mode:

Skips to the beginning of the current (or next) song/album/artist, and if held longer, continues to skip through the previous (or next) song/album/artist.

\*<sup>1</sup> Functions which are marked ○ near the buttons are activated if you press them. Likewise functions marked ◯ near the buttons, are activated if you press and hold them.

\*<sup>2</sup> There are tactile dots. Use them to help with button operations.

## Rear

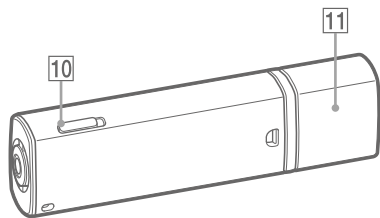

### 10 HOLD switch

You can protect the player against accidental operation by using the HOLD switch when carrying it.

By sliding the HOLD switch in the direction of the arrow (▷), all operation buttons are disabled. If you press buttons while the HOLD function is activated, “HOLD” appears in the display. If you slide the HOLD switch to the opposite position, the HOLD function is released.

### 11 USB cap

Remove the USB cap and connect the USB connector of the player to a USB port on your computer.

#### To remove the USB cap

Remove the USB cap as shown below.

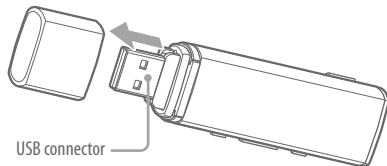

## Display

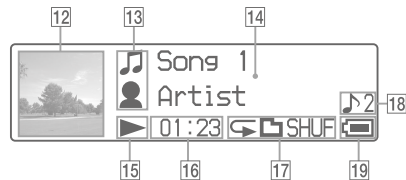

For details of the display, see “Operation Guide (PDF file).”

### 12 Cover art display

Displays the cover art (jacket picture) of an album after you register the cover art and transfer songs from SonicStage.

You can set the cover art to not display.

For details on how to register cover art, refer to SonicStage Help.

### 13 Icon indication

### 14 Text/graphic information display

### 15 Playing status indication

Displays the current playback mode (▶: playback, ||: pause, ◀▶: fast-rewinds (fast-forwards), ◀▶▶: skips to the beginning of the current (or next) song).

### 16 Lapse time indication

Displays the elapsed time.

### 17 Play mode indication (PLAY MODE)

Displays the current play mode icon. If the play mode is set to Normal, no icon appears.

### 18 Sound quality setting indication

Displays the current sound quality icon. If the sound quality is not set, no icon appears.

### 19 Remaining battery indication

Displays the remaining battery power.

#### 💡 Hint

- For the display without a cover art, see “Operation Guide (PDF file).”





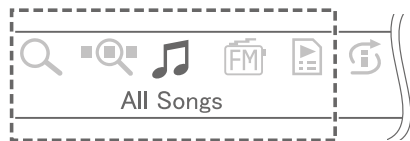

## About the HOME menu

The HOME menu appears when you press and hold the /HOME button of the player. The HOME menu is the starting point to play audio, search for songs, and change settings.

### HOME menu\*1



\*1 5 of the 7 icons appear in the display with the current selection in the center. The current icon changes depending on the function you use. By pressing the /▶▶▶ button, you can select an icon and press the ▶▶▶ button to confirm.

	Search	Searches for songs of the player.
	Jacket Search	Searches for songs by cover art.
	All Songs	Plays all transferred songs of the player.
	FM *2	Enables to listen to FM.
	Playlist Select	Plays songs which are registered in playlists.
	Intelligent Shuffle	Plays songs randomly.
	Settings	Displays setting menu.

\*2 NW-E013F/E015F/E016F only

For details on how to use functions, make settings, and troubleshooting, see “Operation Guide (PDF file).”

Troubleshooting is also explained in the supplementary “Troubleshooting.”

### Operating the HOME menu

When menu items appear on the HOME menu, press the /▶▶▶ button to select an item, and then press the ▶▶▶ button to confirm.

When menu items appear on the HOME menu and press the /HOME button, the screen returns to the previous menu. If you press and hold it, the screen returns to the HOME menu.

For example, when you want to change the song order by selecting  (Settings) on the HOME menu during playback, the menu changes as follows.

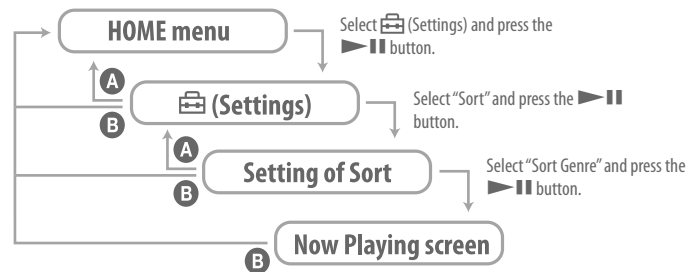

- A Press the /HOME button.
- B Press and hold the /HOME button.

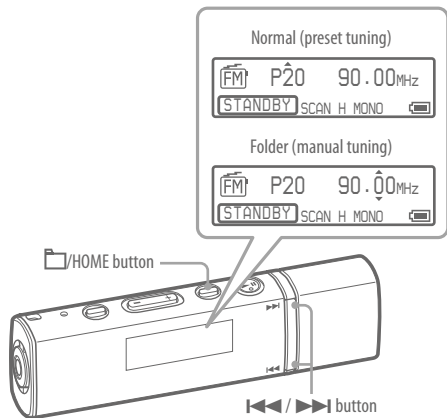

**1** Press and hold the /HOME button until the HOME menu appears.

**2** Press the / button to select (FM), and then press the button to confirm.

The FM tuner screen appears.

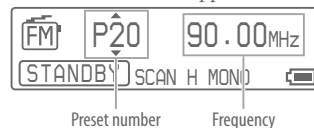

**3** Press the /HOME button to enter the manual tuning mode.

The player enters the manual tuning mode.

Manual tuning display

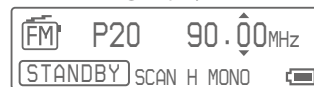

**4** Press the ( ) button to select the previous (or next) frequency.

Press the button briefly to select the next frequency and the button to select the previous frequency.

### Hints

- For details on the FM radio operation, see “Listening to FM Radio” in “Operation Guide (PDF file).”
- The headphones cord serves as an antenna, so extend it as far as possible.

## On Copyrights

- SonicStage and the SonicStage logo are trademarks or registered trademarks of Sony Corporation.
- OpenMG, ATRAC, ATRAC3, ATRAC3plus and their logos are trademarks of Sony Corporation.
- “WALKMAN” and “WALKMAN” logo are registered trademarks of Sony Corporation.
- Microsoft, Windows, Windows Vista, and Windows Media are trademarks or registered trademarks of Microsoft Corporation in the United States and/or other countries.
- Adobe and Adobe Reader are trademarks or registered trademarks of Adobe Systems Incorporated in the United States and/or other countries.
- MPEG Layer-3 audio coding technology and patents licensed from Fraunhofer IIS and Thomson.
- IBM and PC/AT are registered trademarks of International Business Machines Corporation.
- Macintosh is a trademark of Apple Inc.
- Pentium is a trademark or a registered trademark of Intel Corporation.
- US and foreign patents licensed from Dolby Laboratories.
- All other trademarks and registered trademarks are trademarks or registered trademarks of their respective holders. In this manual, <sup>TM</sup> and ® marks are not specified.

This product is protected by certain intellectual property rights of Microsoft Corporation. Use or distribution of such technology outside of this product is prohibited without a license from Microsoft or an authorized Microsoft subsidiary.

Program ©2007 Sony Corporation  
Documentation ©2007 Sony Corporation