

Portable MiniDisc Recorder

Operating Instructions

Recorder Operation _____ **page 10**

Software Operation _____ **page 68**



NetMD



MDLP

"WALKMAN" is a registered trademark of Sony Corporation to represent Headphone Stereo products.  is a trademark of Sony Corporation.

MZ-N520

WARNING

To prevent fire or shock hazard, do not expose the unit to rain or moisture.

Do not install the appliance in a confined space, such as a bookcase or built-in cabinet.

To prevent fire, do not cover the ventilation of the apparatus with news papers, table cloths, curtains, etc. And don't place lighted candles on the apparatus.

To prevent fire or shock hazard, do not place objects filled with liquids, such as vases, on the apparatus.

Certain countries may regulate disposal of the battery used to power this product. Please consult with your local authority.

Caution

The use of optical instruments with this product will increase eye hazard.

CAUTION — INVISIBLE LASER RADIATION WHEN OPEN

AVOID EXPOSURE TO BEAM

CAUTION — CLASS 1M INVISIBLE LASER RADIATION WHEN OPEN

DO NOT VIEW DIRECTLY WITH OPTICAL INSTRUMENTS

Information

IN NO EVENT SHALL SELLER BE LIABLE FOR ANY DIRECT, INCIDENTAL OR CONSEQUENTIAL DAMAGES OF ANY NATURE, OR LOSSES OR EXPENSES RESULTING FROM ANY DEFECTIVE PRODUCT OR THE USE OF ANY PRODUCT.

The validity of the CE marking is restricted to only those countries where it is legally enforced, mainly in the countries EEA (European Economic Area).

Notice for users

On the supplied software

- Copyright laws prohibit reproducing the software or the manual accompanying it in whole or in part, or renting the software without the permission of the copyright holder.
- In no event will SONY be liable for any financial damage, or loss of profits, including claims made by third parties, arising out of the use of the software supplied with this recorder.
- In the event a problem occurs with this software as a result of defective manufacturing, SONY will replace it. However, SONY bears no other responsibility.
- The software provided with this recorder cannot be used with equipment other than that which is so designated.
- Please note that, due to continued efforts to improve quality, the software specifications may be changed without notice.
- Operation of this recorder with software other than that provided is not covered by the warranty.

Notes

- The recorded music is limited to private use only. Use of the music beyond this limit requires permission of the copyright holders.
- Sony is not responsible for music files that cannot be saved on your computer due to unsuccessful recording from a CD or from music downloading.

- SonicStage, MD Simple Burner, OpenMG, Magic Gate, MagicGate Memory Stick, Memory Stick, Net MD, ATRAC, ATRAC3, ATRAC3plus and their logos are trademarks of Sony Corporation.
- Microsoft, Windows, Windows NT and Windows Media are trademarks or registered trademarks of Microsoft Corporation in the United States and /or other countries.
- IBM and PC/AT are registered trademarks of International Business Machines Corporation.
- Macintosh is a trademark of Apple Computer, Inc. in the United States and/or other countries.
- MMX and Pentium are trademarks or registered trademarks of Intel Corporation.
- All other trademarks and registered trademarks are trademarks or registered trademarks of their respective holders.
- TM and ® marks are omitted in this manual.
- CD and music-related data from Gracenote, Inc., copyright © 2000-2003 Gracenote. Gracenote CDDDB® Client Software, copyright 2000-2003 Gracenote. This product and service may practice one or more of the following U.S. Patents: #5,987,525; #6,061,680; #6,154,773, #6,161,132, #6,230,192, #6,230,207, #6,240,459, #6,330,593 and other patents issued or pending. Gracenote and CDDDB are registered trademarks of Gracenote. The Gracenote logo and logotype, the Gracenote CDDDB logo, and the “Powered by Gracenote” logo are trademarks of Gracenote.

Program © 2001, 2002, 2003, 2004
Sony Corporation

Documentation © 2004 Sony Corporation

Table of contents

Recorder Operation

| | |
|---------------------------|----|
| Looking at controls | 11 |
|---------------------------|----|

| | |
|-----------------------|----|
| Getting started | 14 |
|-----------------------|----|

| | |
|-----------------------------------|----|
| Recording an MD right away! | 17 |
|-----------------------------------|----|

| | |
|---------------------------------|----|
| Playing an MD right away! | 20 |
|---------------------------------|----|

| | |
|--|----|
| Various ways of recording | 22 |
| Viewing various information | 22 |
| To start/stop recording in sync with the sound source (Synchro-recording) | 23 |
| Long-time recording (MDLP) | 24 |
| Recording from a TV or a radio (Analog Recording) | 25 |
| Adding track marks while recording | 25 |
| Adding track marks manually | 25 |
| Adding track marks automatically (Auto Time Mark) | 26 |
| Adjusting the recording level manually | 27 |

| | |
|---|----|
| Various ways of playback | 28 |
| Viewing various information | 28 |
| Selecting the play mode | 29 |
| Listening to selected tracks only (Bookmark Play) | 29 |
| Adjusting treble or bass (Digital Sound Preset) | 30 |
| Selecting the sound quality | 30 |
| Adjusting the sound quality | 31 |

| | |
|--|----|
| Editing recorded tracks | 32 |
| Before editing | 32 |
| Labeling recordings (Name) | 32 |
| Labeling | 32 |
| Moving recorded tracks (Move) | 33 |
| Dividing a track (Divide) | 34 |
| Dividing a track directly | 35 |
| Combining tracks (combine) | 35 |
| Erasing tracks and a whole disc contents (Erase) | 36 |
| To erase a track | 36 |
| To erase the whole disc | 37 |

| | |
|---|----|
| Using the group function | 38 |
| What is the group function? | 38 |
| Recording tracks using the group function | 38 |
| Recording a track to a new group | 38 |
| Recording a track to an existing group | 39 |
| Playing groups | 39 |
| Playing a track in group play | 39 |
| Selecting the play mode for group play (Group Play Mode) | 40 |
| Editing groups | 40 |
| Assigning tracks or groups as a new group (Group Setting) | 40 |
| Releasing a group setting | 41 |
| Labeling recorded groups | 42 |
| Moving a track in a disc with group setting | 42 |
| Changing the order of a group on a disc (Group Move) | 43 |
| To erase a group | 44 |

| | |
|---|----|
| Other operations | 45 |
| Useful settings | 45 |
| How to use the menu items | 47 |
| Turning off the beep sound | 48 |
| Recording without overwriting existing material | 48 |
| Creating a new group when recording | 48 |
| Starting the playback quickly (Quick Mode) | 48 |
| Protecting your hearing (AVLS) | 49 |
| List of menus | 50 |

| | |
|---------------------|----|
| Power sources | 52 |
| Battery life | 52 |

| | |
|------------------------------|----|
| Additional information | 53 |
| Precautions | 53 |
| Specifications | 56 |

| | |
|--|----|
| Troubleshooting and explanations | 57 |
| Troubles and solutions | 57 |
| While charging | 57 |
| While recording | 57 |
| While playing | 59 |
| While Editing | 60 |
| While using group function | 61 |
| Others | 62 |
| Messages | 63 |
| Explanations | 66 |

Software Operation

| | |
|--|----|
| What you can do with MD Simple Burner/ SonicStage | 68 |
| What you can do with MD Simple Burner | 68 |
| What you can do with SonicStage | 68 |
| Basic operational flow using an MD Walkman | 69 |

| | |
|--|----|
| Installing | 70 |
| Providing the required system environment | 70 |
| System requirements | 70 |
| Installing the software onto your computer | 71 |
| Connecting the MD Walkman to your computer | 73 |

| | |
|---|----|
| Using MD Simple Burner | 74 |
| Recording by computer operations | 74 |
| The window for recording all tracks on the CD | 74 |
| The window for recording selected tracks from an audio CD | 75 |

| | |
|--|----|
| Using SonicStage | 76 |
| Importing audio data | 76 |
| Transferring audio data from your computer to the MD Walkman | 78 |
| Transferring back audio data from the MD Walkman to your computer | 80 |
| Transferring from the MD Walkman back to your computer | 80 |
| Using SonicStage Help | 82 |
| To display SonicStage Help | 82 |
| Understanding SonicStage Help | 83 |
| Searching for a word inside an explanation | 83 |
| Referring to SonicStage Help | 84 |
| Importing audio data to the computer | 84 |
| Listening to audio data on the computer | 84 |
| Managing and editing imported tracks | 84 |
| Backing up audio data | 85 |
| Troubleshooting | 85 |
| When you want to know | 85 |

| | |
|---|----|
| Other information | 86 |
| Uninstalling SonicStage/MD Simple Burner | 86 |
| On copyright protection | 87 |
| Troubleshooting | 88 |
| The software cannot be installed onto your computer | 89 |
| Using a MD Walkman connected to the computer | 90 |
| | |
| Index | 91 |

Before using this product

This manual explains the recorder operations and the installation and basic use of the supplied software. For details on the various operations, refer to the pages indicated below.

When using the recorder

Recorder Operation (pages 10 to 67)

Pages 10 to 67 in this manual explain the use of the Net MD as an ordinary MiniDisc Walkman.

Troubleshooting and explanations (page 57)

This section shows the troubles you may find while using the recorder, and their solutions.

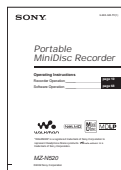

When using the Net MD (the recorder) connected to your computer

Software Operation (pages 68 to 90)

Pages 68 to 90 in this manual explain the installation and basic operations of the supplied SonicStage software. Refer to these pages for details.

Other information (page 86)

This section shows the troubles you may find while using the SonicStage software, and their solutions. It also has the list of frequently asked questions and answers.

SonicStage Ver. 2.0 Help

This is an online help that you can view on your computer screen.

Refer to online help for details on the use of the software. To display the help window, see page 82.

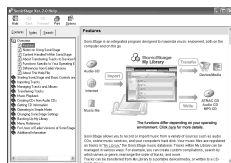

Notes on the "Software Operation" section

- The displayed items in the illustrations that appear in this section may differ from the actual items displayed by the software.
- Explanations in this section assume familiarity with basic Windows operations. For details on the use of your computer and the operating system, please refer to the respective manuals.
- Explanations in this section cover general Net MD products. For this reason, some explanations (and some illustrations) may not be applicable to your Net MD. Please refer to the operating instructions of your Net MD as well.

Checking the supplied accessories

AC power adaptor (1)

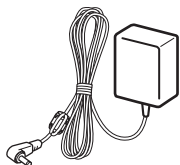

NH-7WMAA Nickel metal
hydride rechargeable
battery (1)

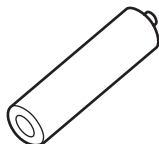

Headphones/earphones with
a remote control (1)

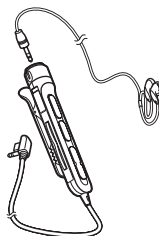

Dedicated USB cable (1)

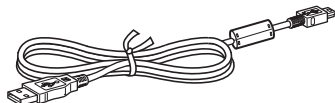

Optical cable (1)

Battery carrying case (1)

CD-ROM (SonicStage Ver. 2.0 and MD Simple Burner Ver. 2.0) (1)*

Carrying pouch (1) (European model only)

*Do not play a CD-ROM on an audio CD player.

Looking at controls

The recorder

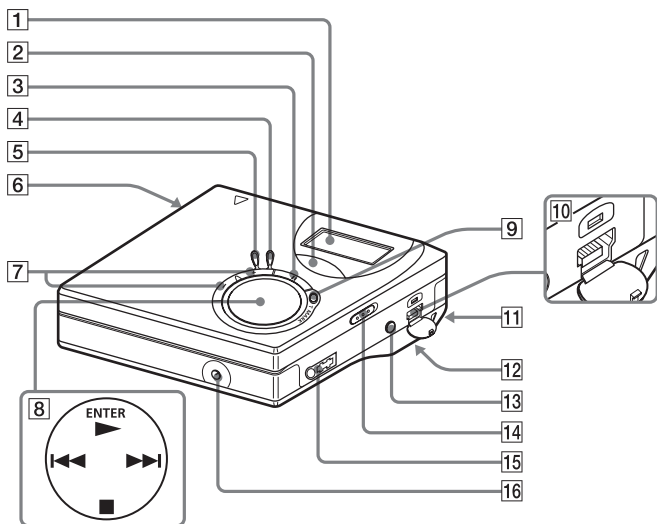

- 1** Display window
- 2** GROUP button
- 3** **||** (pause) button
- 4** END SEARCH button
- 5** MENU button
- 6** OPEN button
- 7** VOL +*, - button
* VOL + has a tactile dot.
- 8** 4-way control key
ENTER • ►*
◀◀, ▶▶ (search/AMS)
■ • CANCEL/CHG (stop/cancel/
charge)
* ► has a tactile dot.
- 9** REC (record) • T MARK button
- 10** USB connecting jack
- 11** Handstrap hole
Use the hole to attach your own strap.
- 12** Battery compartment (at the bottom)
- 13** LINE IN (OPTICAL) jack
- 14** HOLD switch
To prevent the buttons from being
accidentally operated when you carry
the recorder, use this function.
- 15** ◡ (headphones/earphones) jack
- 16** DC IN 3V jack



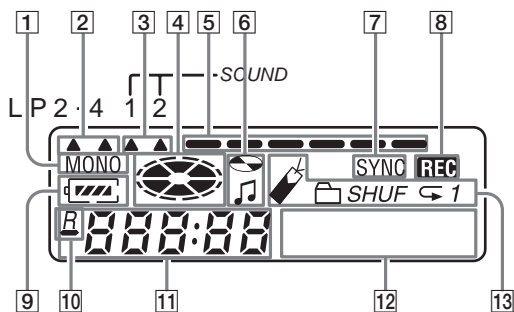

The display window of the recorder

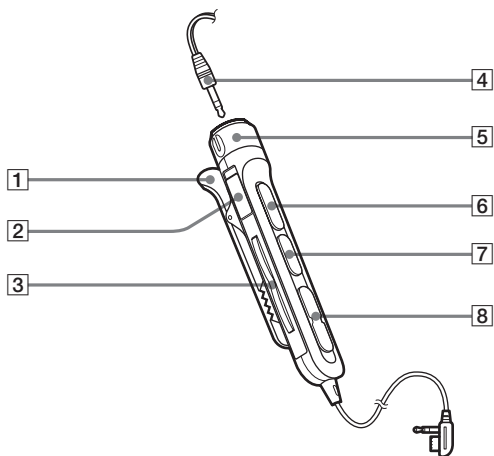

- 1 MONO (monaural) indication
- 2 LP mode indication
- 3 Sound indications
- 4 Disc indication
Shows that the disc is rotating for recording or playing an MD.
- 5 Level meter
Shows the volume of the MD being played or recorded.
- 6 Disc name/track name indication
Lights up when labeling a disc or a track.
- 7 SYNC (synchro-recording) indication
- 8 REC indication
Lights up while recording. When flashing, the recorder is in record standby mode.
- 9 Battery indication
Shows approximate battery condition.
- 10 : Indication for remaining playing time of the current track or of the disc
 : Indication for remaining recordable time of the disc
- 11 Time display
- 12 Character information display
Displays the disc and track names, error messages, track numbers, etc.
- 13 Play mode indications
Shows the play mode (shuffle play, repeat play, group play, bookmark play, etc.) of the MD.

The headphones/earphones with a remote control



- 1** Clip
- 2** HOLD switch
To prevent the buttons from being accidentally operated when you carry the recorder, use this function.
- 3**  (group) +, - button
- 4** Headphones/earphones
Can be replaced with optional headphones/earphones.
- 5** Volume Control (VOL+, -)
Turn to adjust the volume.
- 6** * (to press): play, pause
*  has a tactile dot.
- 7**  (stop) button
- 8**  (search/AMS) button

Getting started

Charge the rechargeable battery before using. Even if the rechargeable battery is not charged, you can use the recorder as long as the AC power adaptor is connected.

1 Insert the rechargeable battery.

Slide OPEN to open the battery compartment lid.

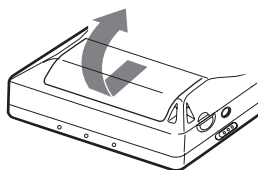

Insert the NH-7WMAA rechargeable battery minus end first.

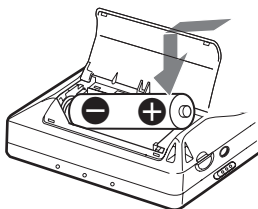

Close the lid.

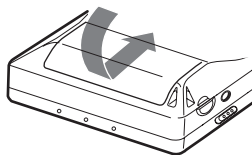

Using the dry battery

Insert one LR6 (size AA) alkaline dry battery (not supplied) instead of the rechargeable battery.

2 Charge the rechargeable battery.

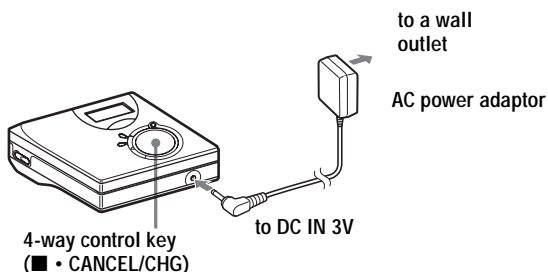

- 1 Connect the AC power adaptor to DC IN 3V.
- 2 Press ■ • CANCEL/CHG while the recorder is stopped.
“Charge” flashes,  appears in the display, and charging starts. When charging is completed, the battery indication disappears.
Full charging of a completely discharged rechargeable battery takes about 2 hours.
- 3 Disconnect the AC power adaptor.



For models supplied with the AC plug adaptor

If the AC power adaptor does not fit the wall outlet, use the AC plug adaptor.

Note

Charge the battery at a temperature of +5°C (+41°F) to +40°C (+104°F). The charging time may vary, depending on the surrounding temperature.

3 Make connections and unlock the controls.

1 Connect the headphones/earphones with the remote control to .

2 Slide HOLD to the opposite direction of the arrow () to unlock the controls.

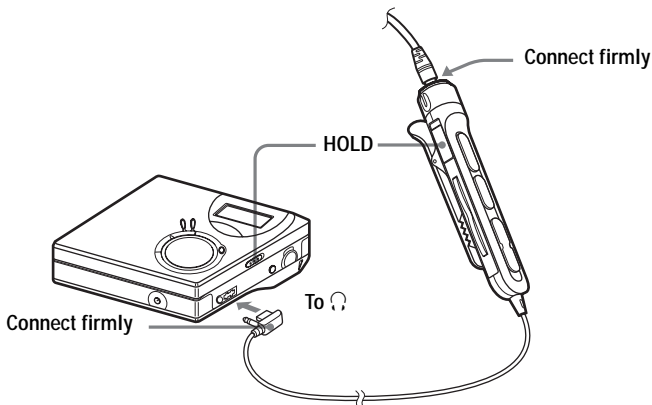

Battery life

For details, refer to “Battery life” (page 52).

When recording

(Unit: Approx. hours)

| Batteries | SP Stereo | LP2 Stereo | LP4 Stereo |
|--|-----------|------------|------------|
| NH-7WMAA nickel metal hydride rechargeable battery | 6 | 9 | 10 |
| LR6 (SG) Sony alkaline dry battery | 10 | 14 | 18.5 |

When playing

(Unit: Approx. hours)

| Batteries | SP Stereo | LP2 Stereo | LP4 Stereo |
|--|-----------|------------|------------|
| NH-7WMAA nickel metal hydride rechargeable battery | 15 | 16 | 20 |
| LR6 (SG) Sony alkaline dry battery | 42 | 48 | 56 |

Recording an MD right away!

This section explains the basic procedure for making digital recordings using an optical cable connected to a CD player, Digital TV or other digital equipment. For other recording operations, see “Various ways of recording” (page 22).

1 Insert an MD.

1 Press OPEN to open the lid.

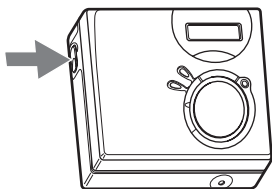

2 Insert an MD with the label side facing front, and press the lid down to close.

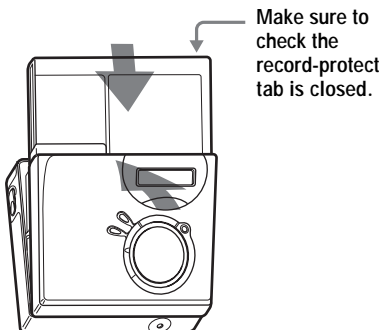

2 Make connections. (Insert the cables firmly and completely into the appropriate jacks.)

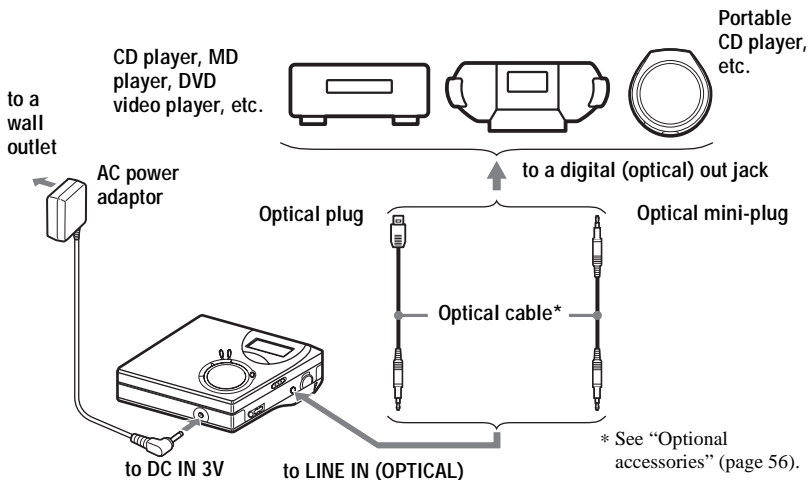

3 Record an MD.

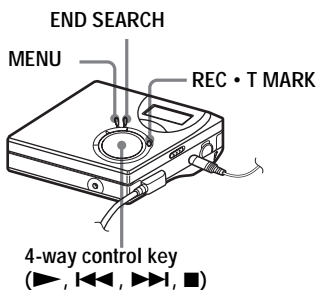

- 1 Set the sound source you want to record to pause.
- 2 While the recorder is stopped, hold down REC • T MARK and press ▶. The recorder starts recording.
- 3 Play the source you want to record. Track marks are automatically added at the same point as the sound source.

To stop recording, press ■.

Note

If you record on a previously recorded disc, the recorder is factory set to overwrite the entire contents of the disc. If you want the recording to start after the existing contents, do the procedure "Recording without overwriting existing material" (page 48) before doing step 3, "Record an MD." (page 18).

| To | Press |
|--|---|
| Record from the end of the current contents ¹⁾ | Press END SEARCH, press ► while holding down REC • T MARK ¹⁾ . |
| Record over partway through the previous recording ¹⁾ | Press ► or press ◀◀ or ▶▶ to find the start point of recording, and then press ■ to stop. Press ► while holding down REC • T MARK. |
| Pause | Press ²⁾ . Press again to resume recording. |
| Remove the MD | Press ■ and open the lid. ³⁾ (The lid does not open while “Edit” flashing in the display.) |

¹⁾ If “R-Posi” is set to “Fr End”, recording operations will always start from the end of the previously recorded material without pressing the END SEARCH button (page 48).

²⁾ A track mark is added at the point where you press || again to resume recording while pausing; thus the remainder of the track will be counted as a new track.

³⁾ If you open the lid while “R-Posi” is set to “FrHere”, recording will begin from the top of the disc the next time you record. Check the point to start recording on the display.

If the recording does not start

- Make sure the recorder is not locked (pages 11, 16).
- Make sure the MD is not record-protected (pages 17, 54).
- Remastered MDs cannot be recorded over.

Notes

- Do not change the rechargeable battery during operation even if the recorder is connected to AC power adaptor. The operation may stop.
- “Edit” flashes while data of the recording (the track’s start and end points, etc.) is being recorded. Do not move the recorder or disconnect the power source while the indication is flashing in the display.
- If the power supply is disrupted (i.e. the battery is removed or becomes exhausted or the AC power adaptor is disconnected) during a recording or editing operation, or while “Edit” appears in the display, it will not be possible to open the lid until power is restored.

- Note the following when recording from a portable CD player:
 - Some portable CD players may not be capable of digital out when the AC power adaptor is disconnected. If this is the case, connect the AC power adaptor to the portable CD player and use it on AC power as the power source.
 - On some portable CD players, optical output may not be possible when using an anti-skip function (e.g., ESP* or G-PROTECTION). If this is the case, turn off the anti-skip function.
- * Electronic Shock Protection



- The recording level is adjusted automatically. To adjust the level manually, see “Adjusting the recording level manually” (page 27).
- You can monitor the sound during recording. Connect the headphones/earphones with remote control to and adjust the volume by turning towards VOL + or – (pressing VOL + or – on the recorder). This does not affect the recording level.

Playing an MD right away!

1 Insert an MD.

1 Press OPEN to open the lid.

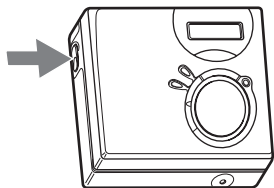

2 Insert an MD with the label side facing front, and press the lid down to close.

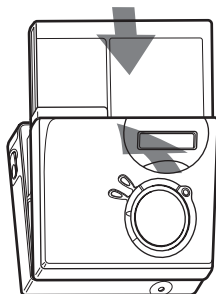

2 Play an MD.

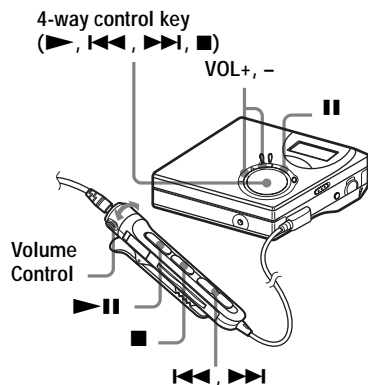

1 Press **▶** on the recorder.
(Press **▶||** on the remote control.)
A short beep sounds in the headphones/earphones.

2 Press VOL + or - to adjust the volume on the recorder.
(Turn the volume control towards VOL + or - on the remote control.)
The volume will be shown in the display.

To stop play, press ■.

A long beep sounds in the headphones/earphones when you operate. After you stop the recorder, the recorder will automatically turn off in about 10 seconds (when using battery) or about 3 minutes (when using an AC power adaptor).

Playback starts from the point you last stopped playing.

To start with the first track of the disc, press **▶** on the recorder or **▶||** on the remote control for 2 seconds or more.

| To | Operation on the recorder | Operation on the remote control |
|---|--|--|
| Pause | Press II . Press II again to resume play. | Press ▶II . Press ▶II again to resume play. |
| Cue to the current track or the previous track | Press I◀◀ . Press I◀◀ repeatedly. | Press I◀◀ . Press I◀◀ repeatedly. |
| Cue to the next track | Press ▶▶I . | Press ▶▶I . |
| Go backwards or forward while playing | Press and hold I◀◀ or ▶▶I . | Press and hold I◀◀ or ▶▶I . |
| Search for a specific position while viewing a elapsed time (Time Search) | Press and hold I◀◀ or ▶▶I while pausing. | Press and hold I◀◀ or ▶▶I while pausing. |
| Search for a specific track while viewing track numbers (Index Search) | Press and hold I◀◀ or ▶▶I while the recorder is stopped. | Press and hold I◀◀ or ▶▶I while the recorder is stopped. |
| Cue to the beginning of the every 10th track (only during playback of the disc with no group settings ¹⁾) | — | Press 📁 + or – button. |
| Remove the MD | Press ■ and open the lid. ²⁾ | Press ■ and open the lid. |

¹⁾ For more details, see “Using the group function” (page 38).

²⁾ Once you open the lid, the point to start play will change to the beginning of the first track.

If the play does not start

Make sure the recorder is not locked (pages 11, 16).

Note

The playback sound may skip if:

- the recorder receives stronger continuous shock.
- a dirty or scratched MD is played.

Viewing various information

You can check the remaining time, track number, etc. when recording or during stop. Group-related items appear only when a track with group settings is played and then stopped.

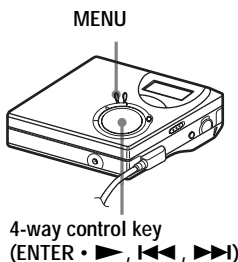

- 1 Press MENU.
- 2 Press ◀ or ▶▶ repeatedly until "DISP" appears in the display, and then press ENTER.
- 3 Press ◀ or ▶▶ repeatedly until the information you want appears in the display, and then press ENTER. Each time you press ◀ or ▶▶, the display changes as follows:
LapTim → RecRem →
GP Rem → AllRem

Display window on the recorder

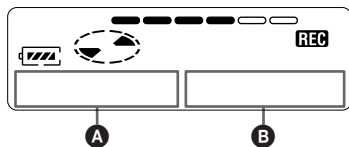

When you press ENTER, **A** and **B** appear in the display.

Display: **A/B**

| B (selected item) | A | B (After a few seconds) |
|-----------------------------|---|--------------------------------|
| — LapTim | Elapsed time | Track number |
| RecRem | Remaining time for recording | Track number |
| GP Rem | Remaining time after the current track in a group | Group name |
| AllRem | Remaining time after the current location | Disc name |

Note

Depending on whether the group function is used or not, the operating conditions, and the disc settings, you may not be able to select certain indications or the indications may appear different.



For more details about the indications in the display while playing, see "Viewing various information" (page 28).

To start/stop recording in sync with the sound source (Synchro-recording)

During synchro-recording, the recorder starts and stops recording in sync with the sound source. When recording from digital equipment (such as a CD player), you can omit operating both the recorder and the sound source, and easily make digital recording. You can make synchro-recording only when the optical cable is connected.

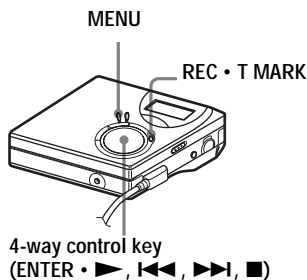

- 1 Make connections.
Use the appropriate optical cable to suit the source equipment. Connect the cable firmly to the appropriate jacks.
- 2 While the recorder is stopped, press MENU.
- 3 Press ◀ or ▶ repeatedly until "R-SET" appears in the display, and then press ENTER.
- 4 Press ◀ or ▶ repeatedly until "SYNC-R" appears in the display, and then press ENTER.
- 5 Press ◀ or ▶ repeatedly until "ON" appears in the display, and then press ENTER.

- 6 Press ▶ while pressing REC • T MARK.
The recorder stands by for recording.
- 7 Play the source you want to record.
The recorder starts recording automatically when it receives the playing sound. "REC" light up in the display.

To stop recording

Press ■.



When there is no sound from the player for about 3 seconds during synchro-recording, the recorder goes into the standby mode automatically. When the sound comes from the player again, the recorder resumes synchro-recording. If the recorder is kept in the standby mode for 5 minutes or longer, the recorder stops automatically.

Notes

- The pause function cannot be turned on or off manually during synchro-recording. Press ■ to stop recording.
- Do not switch the "SYNC-R" setting while recording. Recording may not be done properly.
- Even when there is no sound on the sound source, there may be cases when recording does not pause automatically during synchro-recording due to the noise level emitted from the sound source.
- If a silent portion is encountered for approximately 2 seconds during synchro-recording from a sound source other than a CD or an MD, a new track mark is automatically added at the point where the silent portion ends.

Long-time recording (MDLP)

Select each recording mode according to the recording time that you want. Stereo recording is possible at 2 times (LP2) or 4 times (LP4) the normal (stereo) recording time. Monaural recording at 2 times normal recording time is also possible.

MDs recorded in monaural, LP2, or LP4 mode can be played back only on MD players or recorders with monaural, LP2, or LP4 playback mode.

MENU

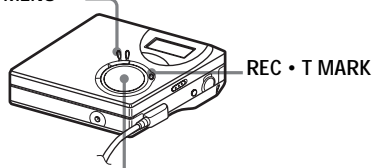

4-way control key
(ENTER • ►, ◀, ►►, ◼)

- 1 Press MENU.
- 2 Press ◀◀ or ►► repeatedly until “R-SET” appears in the display, and then press ENTER.
- 3 Press ◀◀ or ►► repeatedly until “R-MODE” appears in the display, and then press ENTER.

- 4 Press ◀◀ or ►► repeatedly to select the desired recording mode, and then press ENTER.

| Recording mode ¹⁾ | Display window on the recorder | Recording time ³⁾ |
|------------------------------|--------------------------------|------------------------------|
| SP stereo | SP | Approx. 80 min. |
| LP2 stereo | LP2 | Approx. 160 min. |
| LP4 stereo | LP4 | Approx. 320 min. |
| Monaural ²⁾ | MONO | Approx. 160 min. |

¹⁾ For better sound quality, record in normal stereo (stereo) or LP2 stereo mode.

²⁾ If you record a stereo source in monaural, the sounds from left and right will be mixed.

³⁾ When using an 80-minute recordable MD

- 5 Press ► while pressing REC • T MARK.
The recording starts.

- 6 Play the source you want to record.

To stop recording

Press ◼.

The recorder keeps the setting of the recording mode when you record the next time.



Audio components that support the LP2 stereo or LP4 stereo modes are indicated by the MDLP or MDLP logo marks.

Notes

- It is recommended that you use the AC power adaptor for long recordings.
- When you record in LP4 mode, momentary noise may be produced on very rare occasions with certain sound sources. This is because of the special digital audio compression technology that enables a recording time 4 times longer than normal. If noise is produced, it is recommended that you record in normal stereo or LP2 mode to obtain better sound quality.

Recording from a TV or a radio (Analog Recording)

This section explains how to record from an analog equipment such as a cassette recorder, a radio, or TV.

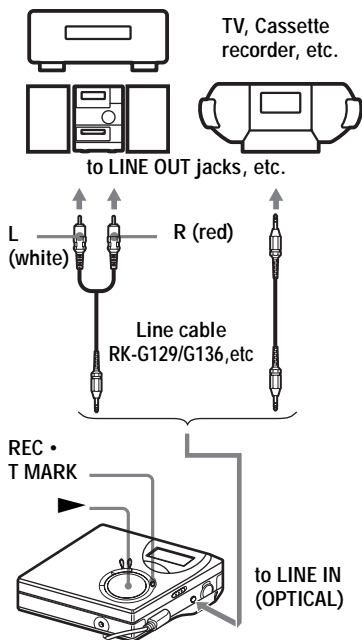

1 Make connections.

Use the appropriate connecting cord to suit the source equipment*. When connecting the cable, make sure to insert the connectors firmly.

* For details, see "Optional accessories" (page 56).

2 Press **▶** while pressing REC • T MARK.

The recording starts.

3 Play the source you want to record.

Adding track marks while recording

You can add track marks (track number) while recording.

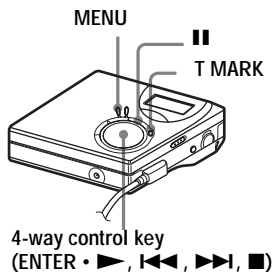

Adding track marks manually

- 1 While the recorder is recording, press T MARK.

Adding track marks automatically (Auto Time Mark)

Use this feature to add track marks automatically at specified intervals when recording through the analog input connector. This function is convenient for recording long period of time, such as lectures, meetings, etc.

- 1 While the recorder is recording or in recording pause, press MENU.
- 2 Press **◀◀** or **▶▶** repeatedly “R-SET” appears in the display, and then press ENTER.
- 3 Press **◀◀** or **▶▶** repeatedly “TimeMk” appears in the display, and then press ENTER.
“OFF” appears in the display.
- 4 Press **▶▶** to show “ON” in the display, and then press ENTER.
- 5 Press **◀◀** or **▶▶** repeatedly until the desired time interval appears in the display, and then press ENTER.
Pressing **◀◀** or **▶▶** changes the time setting (Time:) by 1 minute, within the range of 1 to 99 minutes.

To cancel Auto Time Mark
Select “OFF” in step 4 or stop recording.

Using Auto Time Mark to add track marks while recording

When the elapsed recording time exceeds the time interval for Auto Time Mark:

The recorder adds track marks at the point you set the time interval and from that point the recorder adds a track mark whenever the time interval has elapsed.

Example: Eight minutes of recording has been completed when the Auto Time Mark time interval is set to 5 minutes. A track mark will be added at the 8-minute point (after the start of recording) and after each 5-minute interval thereafter.

When the time interval set for Auto Time Mark exceeds the elapsed recording time:

The recorder adds track marks when the set Auto Time Mark time interval has elapsed.

Example: Three minutes of recording has been completed when the Auto Time Mark time interval is set to 5 minutes. A track mark will be added at the 5-minute point (after the start of recording) and after each 5-minute interval thereafter.



“T” appears after the track display on the recorder for track marks added by Auto Time Mark.

Notes

- If you add a track mark by pressing T MARK or **||** (pause), etc, while recording, Auto Time Mark will begin automatically adding a track mark each time the selected time interval has elapsed.
- The setting will be lost when the recording stopped.

Adjusting the recording level manually

The sound level is adjusted automatically while recording. If necessary, you can set the recording level manually during both analog and digital recording.

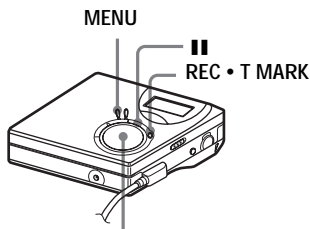

4-way control key
(ENTER • ►, ◀, ►►, ◀◀)

- 1 While pressing **||**, press REC • T MARK.
The recorder stands by for recording.
- 2 Press MENU.
- 3 Press ◀◀ or ►► repeatedly until “R-SET” appears in the display, and then press ENTER.
- 4 Press ◀◀ or ►► repeatedly until “RecVol” appears in the display, and then press ENTER.
- 5 Press ◀◀ or ►► repeatedly until “Manual” appears in the display, and then press ENTER.
- 6 Play the source.

- 7 While observing the level meter in the display, adjust the recording level by pressing ◀◀ or ►►.

Set the level so that the maximum input lights up the fifth segment on the level meter.

If the sixth segment lights up, lower the level by pressing ◀◀.

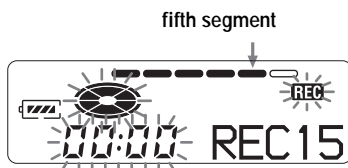

Recording does not start in this step. If your source is an externally connected component, be sure to cue the source to the beginning of the material to be recorded before you start playback.

- 8 Press **||** again to start recording.

To switch back to automatic level control

Select “Auto” in step 5.

Notes

- You cannot adjust the left and right channel levels separately.
- Once you stop recording, the recorder will revert to automatic recording level adjustment mode the next time you start a recording operation.
- To adjust the recording level manually during synchro-recording, do steps 1 to 7 of the procedure in this section with “SYNC-R” is set to “OFF”. Then change the “SYNC-R” setting to sync “ON”, and start recording (page 23).

Viewing various information

You can check the track or disc name, track number, the elapsed playing time of the current track, the number of the tracks recorded on the MD, the group name, and the total number of tracks in a group.

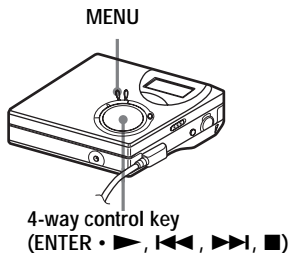

- 1 While playing, press MENU.
- 2 Press ◀◀ or ▶▶ repeatedly until "DISP" appears in the display, and then press ENTER.
- 3 Press ◀◀ or ▶▶ repeatedly until the information you want appears in the display, and then press ENTER. Each time you press ◀◀ or ▶▶, the display changes as follows:
LapTim → 1 Rem →
GP Rem → AllRem

Display window on the recorder

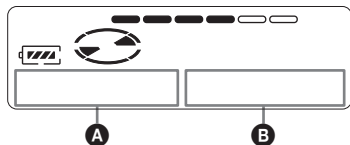

When you press ENTER, **A** and **B** appear in the display.

Indication: **A/B**

| B (Selected item) | A | B (After a few seconds) |
|-----------------------------|---|--------------------------------|
| LapTim | Elapsed time | Track number |
| 1 Rem | Remaining time of the current track | Track number |
| GP Rem | Remaining time after the current track in a group | Group name |
| AllRem | Remaining time after the current location | Disc name |

Note

Depending on whether group play or normal play is selected, the operating conditions, and the disc settings, you may not be able to select certain indications or the indications may appear different.



If you want to check the remaining time or the recording position while recording or in stop mode, see "Viewing various information" (page 22).

Selecting the play mode

You can select from various play modes such as repeat play, shuffle play, or bookmark play.

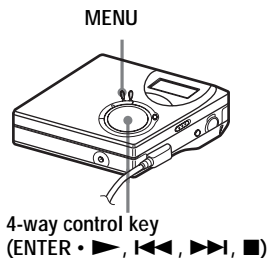

- 1 While the recorder is playing, press MENU.
- 2 Press ◀◀ or ▶▶ repeatedly until "P-MODE" flashes in the display, and then press ENTER again.
- 3 Press ◀◀ or ▶▶ repeatedly to select play mode, and then press ENTER.

Display window on the recorder



When you press ▶▶, B changes.
When you press ENTER, A appears.

| Indication A/ B ¹⁾ | Play mode |
|----------------------------------|---------------------------------|
| Normal/— | All the tracks are played once. |
| 1 Trk/1 | A single track is played once. |

| Indication A/ B ¹⁾ | Play mode |
|----------------------------------|---|
| TrPLAY/ | Bookmarked tracks play back in order of their track number. |
| Shuff/SHUF | All the tracks are played in random order |

¹⁾ Group play mode () appears whenever you play a disc with group settings. For more details, see "Selecting the play mode for group play (Group Play Mode)" (page 40).

- 4 Select "RepON" (playing a track repeatedly) or "RepOFF".
When you select "RepON", "↶" appears on A and the playback repeats with the play mode selected in step 2.

Listening to selected tracks only (Bookmark Play)

You can bookmark tracks on a disc and play them only. The sequence of bookmarked tracks cannot be changed.

To bookmark the tracks

- 1 While playing the track you want to bookmark, press and hold ▶ for 2 seconds or more.

Flashing slowly



- The first track of the bookmark play is set.
- 2 Repeat step 1 to bookmark other tracks.
You can bookmark up to 20 tracks.

To play the bookmarked tracks

- 1 During playback, press MENU.
- 2 Press **◀◀** or **▶▶** repeatedly until “P-MODE” appears in the display, and then press ENTER.
- 3 Press **◀◀** or **▶▶** repeatedly until “**TrPLAY**” appears in the display, and then press ENTER.
“**RepOFF**” appears.
- 4 Select “**RepON**” (playing the bookmark play repeatedly) or “**RepOFF**”.
- 5 Press ENTER.
The Bookmarked tracks start playing, starting with the smallest track number.

To erase a bookmark

While playing the track for which you want to erase the bookmark, press and hold **▶** until “B. OFF” appears.

Note

If you open the lid, all bookmarks are canceled.

Adjusting treble or bass (Digital Sound Preset)

You can adjust the treble and bass to suit your taste. The recorder can store two sets of treble-bass adjustments, which can then be selected later during playback.

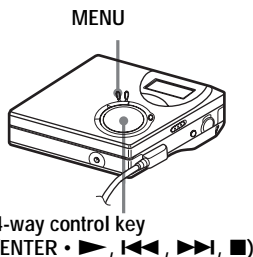

Selecting the sound quality

Factory settings

Factory settings of the Digital Sound Preset are as follows:

- “SOUND1”: bass +1, treble ± 0
- “SOUND2”: bass +3, treble ± 0

- 1 Press MENU.
- 2 Press **◀◀** or **▶▶** repeatedly until “SOUND” appears in the display, and then press ENTER.
- 3 Press **◀◀** or **▶▶** repeatedly until “SOUND1” or “SOUND2” flashes in the display, and then press ENTER.

To cancel Digital Sound Preset
Select “OFF” in step 3.

Adjusting the sound quality

You can change the preset sound quality and store the results in “SOUND1” or “SOUND2”.

- 1 While playing, press MENU.
- 2 Press **◀◀** or **▶▶** repeatedly until “SOUND” appears in the display, and then press ENTER.
- 3 Press **◀◀** or **▶▶** repeatedly until “SET” appears in the display, and then press ENTER.
- 4 Press **◀◀** or **▶▶** repeatedly to select “SOUND1” or “SOUND2”, and then press ENTER.

The display shows the currently selected “BASS” sound setting.

- 5 Press **◀◀** or **▶▶** repeatedly to adjust the sound level.

Shows “SOUND1” or “SOUND2” is selected



The sound can be adjusted in 8 steps (-4, -3, ...±0, ...+2, +3).

- 6 Press ENTER.
“BASS” is set and the display changes to “TRE” (treble) setting mode.
- 7 Press **◀◀** or **▶▶** repeatedly to adjust the sound level, and then press ENTER.

“TRE” (treble) is set.

The sound settings are saved and the playback display appears again.

To cancel selecting

Press CANCEL.



- Settings can also be changed while playback is momentarily paused (⏸).
- If the recorder is not operated approximately for 3 minutes, the current setting is stored and the display automatically switches to normal playback.

Notes

- When you use the Digital Sound Preset, the sound may break or become distorted depending on the settings or the track. In this case, change the settings of the sound quality.
- Changing to another Digital Sound Preset during a recording operation will not affect the quality of recorded sound.

Before editing

You can edit your recordings by adding/erasing track marks or labeling tracks and MDs.

Notes

- Premastered MDs cannot be edited.
- Close the record-protect tab on the side of the MD before editing.
- The recorder is recording editing results while “Edit” is flashing in the display.
 - Do not move or jog the recorder.
 - Do not disconnect the power source.
 - The lid does not open.

Labeling recordings (Name)

You can name tracks and discs using the recorder’s character palette.

Note

When you label a group, see page 42.

Available characters

- Capital and small letters of the English alphabet
- Numbers 0 to 9
- ! " # \$ % & () * . ; < = > ?
@ _ ` + - ' , / : _ (space)

Maximum number of characters per name

Track names, group names, and disc name: Approx. 200 each (containing a mixture of all available characters)

Maximum number of characters that can be input per disc

Alphanumeric characters and symbols only: Approx. 120 titles of about 10 characters each (a maximum of about 1,700 characters)

The number of titles that can be stored on a disc depends on the number of characters that are input for track names, group names, and disc name.

Note

If you enter the symbol “/” between the characters in disc names such as “abc/def”, you may be unable to use the group function.

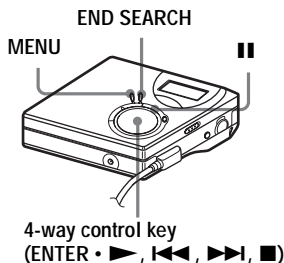

Labeling

You can label a track and a disc while the recorder is stopped, recording, or playing. Note that if you label a track while the recorder is stopped, the track must be the currently selected.

For labeling a group, see “Labeling recorded groups” (page 42).

- 1 Press MENU.
- 2 Press ◀◀ or ▶▶ repeatedly until “EDIT” appears in the display, and then press ENTER.
- 3 Press ◀◀ or ▶▶ repeatedly until “Name” appears in the display, and then press ENTER.

- 4 Press **◀◀** or **▶▶** repeatedly until the following item appears in the display, and then press ENTER.

| | |
|------------------------------|------------|
| When labeling a track | “T : Name” |
| When labeling a disc | “D : Name” |

The cursor flashes in the letter input area and the track, group, or disc is ready to be labeled.



The cursor flashes.

- 5 Press **VOL +** or **-** to select a letter and press ENTER.

The selected letter appears and the cursor moves to the next input position.

The buttons used for character input and their functions are listed below.

| Functions | Operations |
|---|--|
| To select a character | Press VOL + or - . |
| To enter a letter | Press ENTER . |
| To enter a name | Press ENTER for 2 seconds or more. |
| To insert a blank space before the cursor | Press END SEARCH and press VOL + at the same time. |
| To delete a letter | Press END SEARCH and press VOL - at the same time. |
| To switch capital and small letters. | Press II . |
| To cancel labeling. | Press ■ or MENU . |

- 6 Repeat step 5, and then enter all characters of the label name.

- 7 Press **ENTER** for 2 seconds or more. A track or disc is labeled.

To return the preceding settings

Press **■**.

To cancel labeling

Press **■** for 2 seconds or more.

Note

When the recording is stopped while labeling a track or a disc during recording, or when the recording moves on to the next track while labeling a track, the input at that point is entered automatically.

Re-labeling recordings

Follow the procedure of the “Labeling” (page 32) to relabel a name.

Note

The recorder cannot rewrite a disc or track name of more than 200 letters that was created by another device.

Moving recorded tracks (Move)

You can change the order of the recorded tracks.

Note

To move tracks in a disc with group settings, see page 42.

Example

Move track C (track number 3) from the third to the second track.

Before moving



After moving

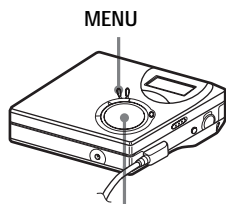

4-way control key
(ENTER • ►, ◀, ▶, ■)

- 1 While playing the track you want to move, press MENU.
- 2 Press ◀ or ▶ repeatedly until “EDIT” appears in the display, and then press ENTER.
The recorder plays the selected track repeatedly.
- 3 Press ◀ or ▶ repeatedly until “Move” appears in the display, and then press ENTER.
- 4 Press ◀ or ▶ repeatedly until “T : Move” appears in the display, and then press ENTER.
For example above, “→Tr003” appears in the display.
- 5 Press ◀ or ▶ repeatedly to select the destination track number.

- 6 Press ENTER.

The track moves to the selected destination track.

For example above, “002” appears in the display.

To return the preceding settings

Press ■.

To cancel moving

Press ■ for 2 seconds or more.

Dividing a track (Divide)

You can divide a track with a track mark, creating a new track from the part following the track mark. The track numbers will increase as follows.

Note

You cannot add a track mark on a track that has been transferred from your computer.

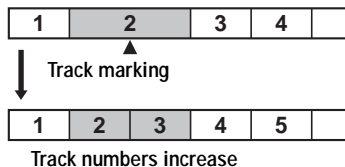

4-way control key
(◀, ▶)

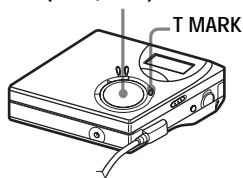

Dividing a track directly

- 1 While playing or pausing an MD, press T MARK on the recorder at the point you want to mark.
“MK ON” appears in the display, and a track mark is added. The track number will increase by one.

To add track marks while recording (except while synchro-recording)

Press T MARK on the recorder at the point you want to add a track mark.

You can use Auto Time Mark to add track marks automatically at specified intervals (except while digital recording) (page 25).

Combining tracks (combine)

When you record with analog (line) input, unnecessary track marks may be recorded where recording level is low. You can erase a track mark to combine the tracks before and after the track mark.

Notes

- You cannot erase a track mark on a track that has been transferred from your computer.
- To combine groups or tracks in a disc with group settings, see page 42.
- You cannot combine tracks recorded in different recording mode.

The track numbers will change as follows:

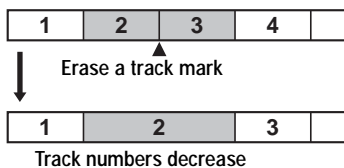

4-way control key (⏪)

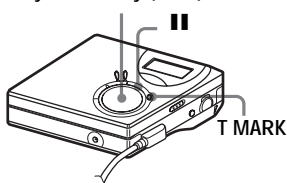

- 1 While playing the track with the track mark you want to erase, press ⏸ to pause.
- 2 Find the track mark by pressing ⏪.
For example, to erase the third track mark, find the beginning of the third track. “00:00” appears in the display. “MK” appears in the display for a few seconds.
- 3 Press T MARK to erase the mark. “MK OFF” appears in the display. The track mark is erased and the two tracks are combined.



When you erase a track mark, the date, time, and name assigned to the mark are also erased.

Note

When you erase a track mark between the two consecutive tracks that are assigned into different groups, the second track is re-assigned into the group containing the first track. In addition, if you combine a track that is assigned to a group with a track that is not assigned to a group (two consecutive tracks), the second track takes the same group assignment as the first track.

Erasing tracks and a whole disc contents (Erase)

You can erase unnecessary tracks or all tracks on a disc.

Notes

- You cannot erase tracks that have been transferred from your computer. You cannot erase an entire disc if it contains a transferred track. In this case, transfer the track or tracks to the computer.
- When you erase groups, see page 44.

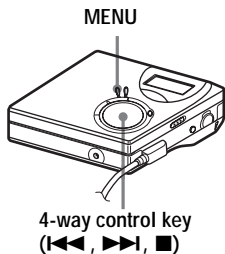

To erase a track

Note that once a recording has been erased, you cannot retrieve it. Make sure of the track you are erasing.

- 1 While playing the track you want to erase, press MENU.

- 2 Press ◀◀ or ▶▶ repeatedly until "EDIT" appears in the display, and then press ENTER.

- 3 Press ◀◀ or ▶▶ repeatedly until "Erase" appears in the display, and then press ENTER.

- 4 Press ◀◀ or ▶▶ repeatedly until "T : Ers" appears in the display, and then press ENTER.
"Erase?" and "ENTER" appear alternately in the display.

- 5 Press ENTER.

The track is erased and the next track starts to play. All the tracks after the one erased are automatically renumbered.

To erase a part of a track
Add track marks at the beginning and the end of the part you want to erase, then erase the part (page 34).

To return the preceding settings
Press ■.

To cancel erasing
Press ■ for 2 seconds or more.

To erase the whole disc

You can quickly erase all the tracks and data of the MD at the same time.

Note that once a recording has been erased, you cannot retrieve it. Be sure to check the contents of the disc before you erase it.

- 1 Play the disc you want to erase to check the contents.
- 2 Press ■ to stop.
- 3 Press MENU.
- 4 Press ◀◀ or ▶▶ repeatedly until “EDIT” appears in the display, and then press ENTER.
- 5 Press ◀◀ or ▶▶ repeatedly until “Erase” appears in the display, and then press ENTER.
- 6 Press ◀◀ or ▶▶ repeatedly until “D : Ers” appears in the display, and then press ENTER.
“Erase?” and “ENTER” appear alternately in the display.
- 7 Press ENTER.
“Edit” appears in the display, and all the tracks will be erased.
When erasing is complete, “BLANK” appears in the display.

To return the preceding settings

Press ■.

To cancel moving

Press ■ for 2 seconds or more.

What is the group function?

The group function is provided to allow playback of discs with group settings. The group function is convenient for playback of MDs on which several albums or CD singles have been recorded in MDLP (LP2/LP4) mode.

What is a disc with group settings?

The recorder can operate various functions in units of group; that is tracks that have been recorded on a disc as a part of separate groups, as shown below.

Before group settings are made (normal play)

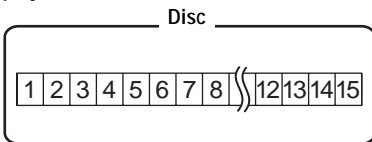

- Track 1 to 5 are assigned to group 1.
- Track 8 to 12 are assigned to group 2.
- Track 13 to 15 are assigned to group 3.
- Track 6 to 7 are not assigned to a group.

After setting the group (group play)

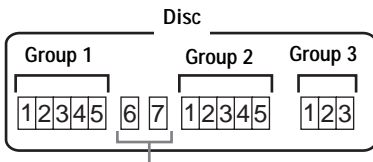

Tracks that were not assigned to a group are treated as being part of "Group - -".

You can create a maximum of 99 groups on a disc.

Note

It will not be possible to make a group setting if the tracks, groups and disc name on a disc exceed the maximum number that can be input.

Recording tracks using the group function

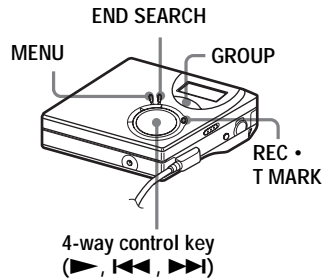

Recording a track to a new group

During recording, you can add a new group at the end of the currently recorded tracks on a disc.

- 1 While the recorder is stopped, press END SEARCH.
- 2 While pressing GROUP, press REC • T MARK and ▶.
- 3 Play the source sound.

A new group will be added after the current contents on a disc.

To stop recording

Press ■.

The material that was recorded up until ■ was pressed is entered as a new group.

Recording a track to an existing group

You can add a track to an existing group.

- 1 Press GROUP, and then press **◀◀** or **▶▶** until the group you want to add a track to appears in the display.
- 2 Press **▶** while pressing REC • T MARK.
- 3 Play the source sound.
Newly recorded track is added after the current contents in the group.



- To add a track that is currently playing to a group, stop or pause playing the track first, and then do the procedure from step 2.
- You can set the recorder to always create a new group without pressing the GROUP button. See page 48 for details.

Playing groups

The recorder can operate various playback with a disc which has group setting.

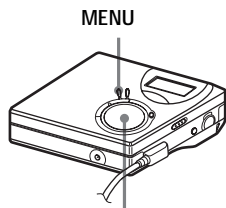

4-way control key
(**◀◀**, **▶▶**)

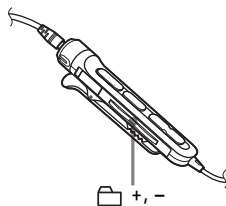

Playing a track in group play

In group play, all groups are played in order, starting with group 1, followed by the unassigned tracks (“Group -”). Playback stops after all the tracks have been played.

- 1 Press MENU.
- 2 Press **◀◀** or **▶▶** repeatedly until “P-MODE” appears in the display, and then press ENTER.
- 3 Press **◀◀** or **▶▶** repeatedly to select “ Normal”, and then press ENTER.

To cue to the start of a group (Group Skip)

On the recorder

- 1 Press GROUP.
- 2 While “ ” flashing, press **◀◀** or **▶▶**.
Pressing **-** button cues to the first track in the current group. Pressing the button again cues to the first track of the previous group.

On the remote control

- 1 Press “ ”+ or -.

Selecting the play mode for group play (Group Play Mode)

The shuffle play and repeat play function can be used during group play mode.

- 1 Press MENU.
- 2 Press ◀◀ or ▶▶ until "P-MODE" appears in the display, and then press ENTER.
- 3 Press ◀◀ or ▶▶ repeatedly to select the play mode, and then press ENTER.

After normal playback (page 29), the following play modes are displayed.

| Display | Play mode |
|-------------------------------|---|
| 📁 (Normal Group Play) | All tracks in the groups play back once (starting with the first track in group 1). |
| 📁, SHUF (In-Group Shuffle) | Shuffle play starts with the group that is currently playing, and continues with the succeeding groups. |

- 4 Select "RepON" or "RepOFF".
"↺" appears in the display.
Playback repeats in the respective group play mode (Group Repeat Play).

| Display | Play mode |
|-----------|--|
| 📁 ↺ | Repeat play of tracks within a group |
| 📁, SHUF ↺ | Repeat shuffle play of tracks within a group |

Editing groups

Assigning tracks or groups as a new group (Group Setting)

With this function, you can assign existing tracks or groups to a new group, and also you can assign a track that currently belongs to no group to an existing group.

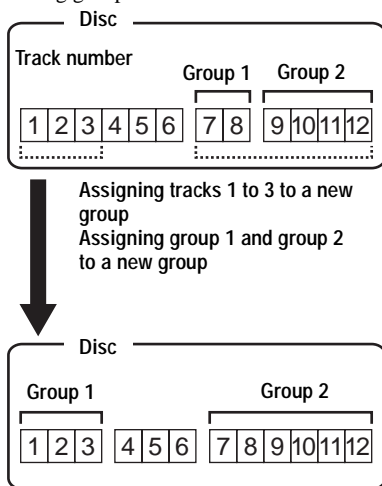

Group assignment of non-consecutive tracks is not possible (for example, track 3 and tracks 7 to 8 cannot be assigned to a new group).

Track numbers appear according to their order on the disc, not their order within the group.

Notes

- You can create a maximum of 99 groups on a disc. It will not be possible to make a group setting if the tracks, groups and disc name on a disc exceed the maximum number that can be input.
- The tracks or groups must be sequential. If the desired tracks or groups are not consecutive, you must move them to make them consecutive before you can assign them (“Moving recorded tracks (Move)”, page 33).

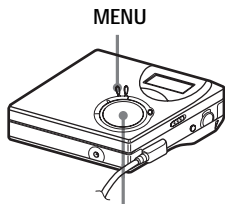

4-way control key
(ENTER • ▶▶, ◀◀, ▶▶, ■)

- 1 While the recorder is stopped, press MENU.
- 2 Press ◀◀ or ▶▶ until “EDIT” appears in the display, and then press ENTER.
- 3 Press ◀◀ or ▶▶ until “G : Set” appears in the display, and then press ENTER.
The track number of the first track (“STR”) appears in the display.



- 4 Press ◀◀ or ▶▶ until the number of the desired first track appears in the display, and then press ENTER.
This selects the first track of the new group.

- 5 Press ◀◀ or ▶▶ until the number of the desired last track appears in the display, and then press ENTER.
This selects the last track of the new group.
- 6 Label a group (see “Labeling recorded groups” (page 42)).

To return the preceding settings

Press ■.

To cancel the operation

Press ■ for 2 seconds or more.

Notes

- In step 4, the first track must be either the first track of an existing group or a track that does not belong to a group.
- When selecting the last track in step 5, make sure the track comes after the one selected in step 4. The last track must be either the last track of an existing group or a track that does not belong to a group.

Releasing a group setting

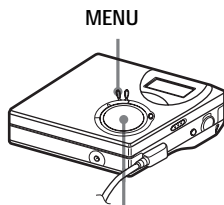

4-way control key
(◀◀, ▶▶, ■)

- 1 Select a group you want to release and check the contents (see “To cue to the start of a group (Group Skip)” (page 39)).
- 2 Press ■.
- 3 Press MENU.

continued

- 4 Press **⏮** or **⏭** until “EDIT” appears in the display, and then press ENTER.
- 5 Press **⏮** or **⏭** until “G : Rls” appears in the display, and press ENTER.
“G : Rls?” and “ENTER” appear alternately in the display.
- 6 Press ENTER.
The group setting of the selected group is released.

To return the preceding settings

Press **■**.

To cancel the operation

Press **■** for 2 seconds or more.

Labeling recorded groups

You can label a group while the recorder is recording or playing a track in the group. You can also label a group while a track in the group is selected and the recorder is stopped.

- 1 Do the procedure of “Labeling” (page 32) and select “G : Name” in step 4, and then do steps 5 to 7.

Moving a track in a disc with group setting

You can move a track from one group out of the group or to another group. You can also move a track that is not belong to a group into an existing group.

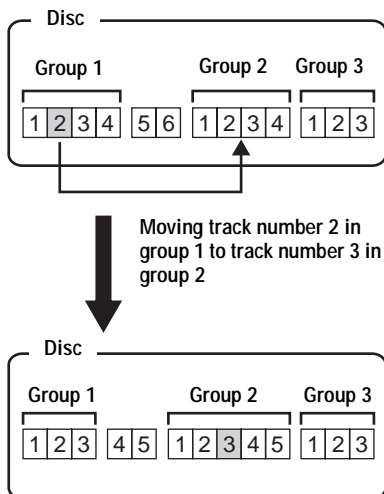

MENU

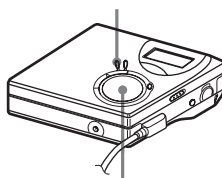

4-way control key
(**⏮**, **⏭**, **■**)

- 1 While playing the track you want to move, press MENU.
- 2 Press **⏮** or **⏭** until “EDIT” appears in the display, and then press ENTER.

- 3 Press ◀◀ or ▶▶ until “Move” appears in the display, and then press ENTER.
- 4 Press ◀◀ or ▶▶ until “T : Move” appears in the display, and then press ENTER.



- 5 When moving a track out of a group, skip this step. When moving a track into a different group, press ◀◀ or ▶▶ until the destination group appears in the display, and then press ENTER.

The indications will appear alternately as follows, for example.



The destination group



The number of the track within the destination group

- 6 Press ◀◀ or ▶▶ until the number of the destination track (within a group when moving into a different group) appears in the display, and then press ENTER.

The selected track number appears in the display.

To return the preceding settings

Press ■.

To cancel moving

Press ■ for 2 seconds or more.

Changing the order of a group on a disc (Group Move)

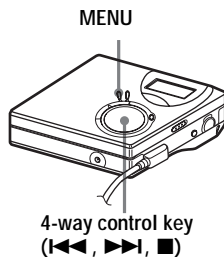

4-way control key
(◀◀, ▶▶, ■)

- 1 While playing a track within a group whose order you want to change, press MENU.
- 2 Press ◀◀ or ▶▶ until “EDIT” appears in the display, and then press ENTER.
- 3 Press ◀◀ or ▶▶ until “Move” appears in the display, and then press ENTER.
- 4 Press ◀◀ or ▶▶ until “G : Move” appears in the display, and then press ENTER.

- 5 Press **◀◀** or **▶▶** to select the destination point on the disc, and then press ENTER.

To return the preceding settings

Press **■**.

To cancel moving

Press **■** for 2 seconds or more.

To erase a group

You can erase tracks in a selected group.

Note that once a recording has been erased, you cannot retrieve it. Be sure to check the contents of the group before you erase it.

Note

You cannot erase tracks that have been transferred from your computer. You cannot erase a group if it contains a transferred track. In this case, transfer the track or tracks to the computer.

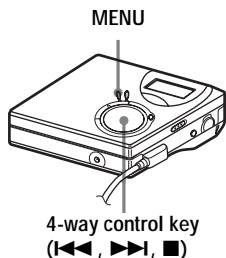

- 1 Select a group you want to erase and check the contents (see “To cue to the start of a group (Group Skip)” (page 39)).
- 2 Press **■**.
- 3 Press MENU.
- 4 Press **◀◀** or **▶▶** until “EDIT” appears in the display, and then press ENTER.

- 5 Press **◀◀** or **▶▶** until “Erase” appears in the display, and then press ENTER.

- 6 Press **◀◀** or **▶▶** until “G : Ers” appears in the display, and then press ENTER.

The group name, “G : Ers?” and “ENTER” appear alternately in the display.

- 7 Press ENTER.

The group is erased.

To return the preceding settings

Press **■**.

To cancel erasing

Press **■** for 2 seconds or more.

Useful settings

The recorder has many menus with useful functions for recording, playback, editing, etc. The following table shows the menu items that you can select.

| Category | Function | What it does | Site page |
|---------------------------|-------------------------------------|--|---|
| General operations | Beep on/off | Turns the beep sound on or off. | page 48 |
| Recording | Synchro-Recording | Simplifies operations during digital recording. | page 23 |
| | Long-time recording | Selects the recording mode (SP, LP2, LP4, or monaural). | page 24 |
| | Adding track marks (Divide) | Adds track marks automatically at specified intervals. | page 25 |
| | Adjusting the recording level | Manually adjusts the recording level. | page 27 |
| | Selecting the record-starting point | Allows you to specify whether material is overwritten or not when recording. | page 48 |
| | Group recording | Sets the recorder to create a new group with each recording operation. | page 48 |
| Playing | Selecting the play mode | Selects the play mode, such as repeat play, shufful play, etc. | page 29 |
| | Changing the sound quality | Adjust the treble and bass, and stores two sets of treble-bass adjustment. | page 31 |
| | Starting playback quickly | Sets the recorder to start playback or cue to a track quickly. | page 48 |
| | Limiting the maximum volume | Sets a limit on the maximum volume to protect your hearing. | page 49 |
| Display | Viewing information | Displays various information such as the remaining time, etc. in the display window. | pages 22 and 28 |
| Editing | Labeling (Name) | Labels tracks, groups, or the disc. | page 32 (track and disc) page 42 (group) |

| Category | Function | What it does | Site page |
|-----------------|----------------------------|---|---|
| Editing | Moving | Changes the order of tracks or groups. | page 33 (track) page 42 (group) |
| | Erasing | Erases tracks, groups, or the entire disc contents. | page 36 (track and disc) page 44 (group) |
| | Assigning tracks to groups | Assigns recorded tracks or groups to a new group. | page 40 |
| | Releasing a group | Releases group settings. | page 41 |

How to use the menu items

To set the menu items, do the following procedure.

- 1 Press MENU to enter the menu.
- 2 Press ◀◀ or ▶▶ to select the item.
- 3 Press ENTER to enter the selection.
- 4 Repeat steps 2 and 3.

The setting will be entered when you press ENTER at the last.

To return the preceding setting

Press ■.

To cancel the operation while setting

Press and hold ■ for 2 seconds or more.

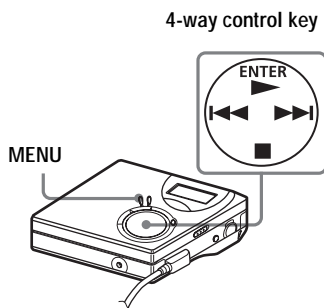

Turning off the beep sound

You can turn on/off the beep sound on the recorder and the remote control.

- 1 Enter the menu and select "OPTION" - "BEEP".
- 2 Select "OFF".

To turn on the beep sound
Select "ON".

Recording without overwriting existing material

If you wish to avoid recording over the current contents of an MD, do the following procedure. All new material will then be recorded from the end of the current contents. The recorder is factory set to record over existing material.

- 1 Enter the menu and select "OPTION" - "R-Posi".
- 2 Select "Fr End".

To start recording over the current contents
Select "FrHere".



- To temporarily record without recording over the current contents, press END SEARCH before the start of recording. The recording will begin after the last track, even if "R-Posi" is set to "FrHere" (factory setting). The remaining recordable time on the disc will appear in the display when you press END SEARCH.
- If the group recording setting ("G-REC") is set to "G-ON", the recorder will always set to "Fr End".

Creating a new group when recording

By pressing  while pressing REC • T MARK, you can set the recorder to create a new group automatically each time you record. This is convenient when recording several CDs in succession.

- 1 While the recorder is stopped, enter the menu and select "R-SET" - "G-REC".
- 2 Select "G-ON".

To turn the setting to normal
Select "G-OFF".

Starting the playback quickly (Quick Mode)

After pressing the playback button or cueing to the track, the playback can start quickly.

- 1 Enter the menu and select "OPTION" - "Power".
- 2 Select "QUICK".

Display window on the recorder



To switch back to the normal setting
Select "NORMAL".

Notes

- When the power mode is set to “QUICK”, the power remains on within the recorder even when nothing appears in the display. This leads to a shorter battery life. For this reason, it is recommended that you charge the battery daily.
- If no recorder operation (including opening or closing of the lid) occurs for an hour, the power in the recorder automatically turn off. For this reason, the next time you start playback or do another operation, the recorder will not respond quickly. The unit, however, will return to quick mode afterwards.

Protecting your hearing (AVLS)

The AVLS (Automatic Volume Limiter System) function keeps down the maximum volume to protect your ears.

1 Enter the menu and select “OPTION” - “AVLS”.

2 Select “ON”.

When you try to turn the volume too high, “AVLS” appears in the display. The volume is kept to a moderate level.

To cancel the AVLS

Select “AVLS OFF”.



List of menus

Menus on the recorder

Items listed under “Menu 1” are the selectable items which appear when you press MENU, items listed under “Menu 2” are the selectable items which appear when you select an item in Menu 1, and “Menu 3” are the selectable items which appear when you select an item in Menu 2.

Note

Different indication may be displayed depending on the operating conditions and disc settings.

| Menu 1 | Menu 2 | Menu 3 |
|--------|---|---|
| EDIT | Name | T : Name ↔ G : Name ↔ D : Name |
| | G : Set | — |
| | G : Rls | — |
| | Move | T : Move ↔ G : Move |
| | Erase | T : Ers ↔ G : Ers ↔ D : Ers |
| DISP | LapTim | — |
| | RecRem (while recording and stopped)/1 Rem (while playing) | — |
| | GP Rem | — |
| | AllRem | — |
| P-MODE | Normal | RepOFF (factory setting) ↔ RepON |
| | 1 Trk | |
| |  TrPLAY | |
| | Shuff | |
| |  Normal | |
| |  Shuff | |
| SOUND | OFF | — |
| | SOUND1 | — |
| | SOUND2 | — |
| | SET | SOUND1 ↔ SOUND2 |
| R-SET | R-MODE | SP (factory setting) ↔ LP2 ↔ LP4 ↔ MONO |
| | RecVol | Auto (factory setting) ↔ Manual |
| | TimeMk | MK OFF (factory setting) ↔ MK ON |
| | G-REC | G-OFF (factory setting) ↔ G-ON |
| | SYNC-R | OFF (factory setting) ↔ ON |

| Menu 1 | Menu 2 | Menu 3 |
|---------------|---------------|-----------------------------------|
| OPTION | AVLS | OFF (factory setting) ↔ ON |
| | BEEP | OFF ↔ ON (factory setting) |
| | R-Posi | FrHere (factory setting) ↔ Fr End |
| | Power | NORMAL (factory setting) ↔ QUICK |

You can use the recorder on house current or as follows.

- a nickel metal hydride rechargeable battery NH-7WMAA
- an LR6 (size AA) alkaline dry battery

It is preferable to use the recorder on house current when recording for a long time. When using a battery, make sure it is a fully charged rechargeable battery or a new alkaline dry battery to prevent operations (e.g., recording and editing) from failing due to insufficient battery power.

Battery life

The battery life may be shorter due to operating conditions, the temperature of the location, or alkaline dry battery you use.

When recording

(Unit: approx.hours)(JEITA¹⁾)

| Batteries | SP Stereo | LP2 Stereo | LP4 Stereo |
|---|-----------|------------|------------|
| Nickel metal hydride rechargeable battery ²⁾ | 6 | 9 | 10 |
| LR6 Sony alkaline dry battery ³⁾ | 10 | 14 | 18.5 |

¹⁾ Measured in accordance with the JEITA (Japan Electronics and Information Technology Industries Association) standard.

²⁾ When using a 100% fully charged nickel metal hydride rechargeable battery (NH-7WMAA).

³⁾ When using a Sony LR6 (SG) alkaline dry battery (produced in Japan).

When playing

(Unit: approx.hours)(JEITA)

| Batteries | SP Stereo | LP2 Stereo | LP4 Stereo |
|---|-----------|------------|------------|
| Nickel metal hydride rechargeable battery | 15 | 16 | 20 |
| LR6 Sony alkaline dry battery | 42 | 48 | 56 |

When to replace the batteries

When the dry battery or rechargeable battery is weak, flashing  or "LoBATT" appears in the display.

Replace the dry battery or charge the rechargeable battery.

The battery level indicator is approximate. It may be more or less than the indication depending on the operating condition.

Note

Stop the recorder before replacing battery.

Precautions

On safety

Do not put any foreign objects in the DC IN 3V jack.

On power sources

- Use house current, nickel metal hydride rechargeable battery, LR6 (size AA) battery.
- For use in your house: Do not use any other AC power adaptor since it may cause the recorder to malfunction.

Polarity of the plug



- Connect the AC power adaptor to an easily accessible AC outlet. Should you notice an abnormality in the AC power adaptor, disconnect it from the AC outlet immediately.
- The recorder is not disconnected from the AC power source (mains) as long as it is connected to the wall outlet, even if the recorder itself has been turned off.
- If you are not going to use this recorder for a long time, be sure to disconnect the power supply (AC power adaptor, dry battery or rechargeable battery). To remove the AC power adaptor from the wall outlet, grasp the adaptor plug itself; never pull the cord.

On heat build-up

Heat may build up in the recorder if it is used for an extended period of time. This, however, is not a malfunction.

On installation

- Never use the recorder where it will be subjected to extremes of light, temperature, moisture or vibration.
- Never wrap the recorder in anything when it is being used with the AC power adaptor. Heat build-up in the recorder may cause malfunction or damage.

On the headphones/earphones

Road safety

Do not use headphones/earphones while driving, cycling, or operating any motorized vehicle. It may create a traffic hazard and is illegal in many areas. It can also be potentially dangerous to play your recorder at high volume while walking, especially at pedestrian crossings. You should exercise extreme caution or discontinue use in potentially hazardous situations.

Preventing hearing damage

Avoid using headphones/earphones at high volume. Hearing experts advise against continuous, loud and extended play. If you experience a ringing in your ears, reduce the volume or discontinue use.

Caring for others

Keep the volume at a moderate level. This will allow you to hear outside sounds and to be considerate of the people around you.

On the remote control

The supplied remote control is designated for this recorder only. You cannot use the recorder with a remote control supplied with other equipment.

Note on charging

- Be sure to use the supplied AC power adaptor.
- Charge the rechargeable battery at a temperature of +5°C (+41°F) to +40°C (+104°F).
- Though the battery and the recorder may become hot during the charging procedure, this poses no danger.
- If you are charging the battery for the first time or after a long period of disuse, the battery may not charge up to its rated capacity. This is a normal characteristic. After you use and recharge the battery a few times, it will return to its normal charge capacity.

Notes on recording

Before you remove the MD after the recording has completed

Make sure that “Edit” has disappeared in the display.

Before you remove the MD after the transfer of audio data from your computer has completed

Make sure that “Edit” has disappeared in the display, and then press the ■ (stop) button.

If the power source (AC power adaptor/battery) accidentally becomes disconnected during recording

The lid may refuse to open. If this happens, do not open the lid by force. Do the steps below instead.

- 1 Connect the power source (AC power adaptor/battery) firmly to the recorder.
- 2 Press the OPEN button to open the lid.

On the MiniDisc cartridge

- When carrying or storing the MiniDisc, keep it in its case.
- Do not break open the shutter.
- Do not place the cartridge where it will be subject to light, extreme temperatures, moisture or dust.
- Attach the supplied MD label only in the space designated for it on the disc. Do not stick it on any other disc surface.

On cleaning

- Clean the recorder casing with a soft cloth slightly moistened with water or a mild detergent solution. Do not use any type of abrasive pad, scouring powder or solvent such as alcohol or benzene as it may mar the finish of the casing.
- Wipe the disc cartridge with a dry cloth to remove dirt.
- Dust on the lens may prevent the unit from operating properly. Be sure to close the disc compartment lid after inserting or ejecting an MD.

- To obtain the best sound quality, use a dry cloth to wipe the plugs of the headphones/earphones or the remote control. Dirty plugs may cause sound distortion or intermittent breaks in the sound.

Notes on battery

Incorrect battery usage may lead to leakage of battery fluid or bursting battery. To prevent such accidents, observe the following precautions:

- Install the + and – poles of the battery correctly.
- Do not try to recharge dry battery.
- When the recorder is not to be used for a long time, be sure to remove the battery.
- If a battery leak should develop, carefully and thoroughly wipe away battery fluid from the battery compartment before inserting new ones.

Note on mechanical noise

The recorder gives off mechanical noise while operating, which is caused by the power-saving system of the recorder and it is not a problem.

To protect a recorded MD

To record-protect an MD, slide open the tab at the side of the MD. In this position, the MD cannot be recorded. To record again, slide the tab back so the tab is visible.

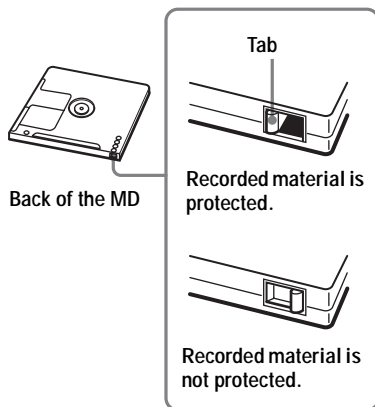

Note on maintenance

Clean the terminals periodically with a cotton swab or a soft cloth.

If you have any questions or problems concerning your recorder, please consult your nearest Sony dealer. (If a trouble occurred when the disc was in the recorder, we recommend that the disc be left in the recorder when you consult your Sony dealer so that the cause of trouble may be better understood.)

Specifications

Audio playing system

MiniDisc digital audio system

Laser diode properties

Material: GaAlAs

Wavelength: $\lambda = 790$ nm

Emission duration: continuous

Laser output: less than 44.6 μ W

(This output is the value measured at a distance of 200 mm from the lens surface on the optical pick-up block with 7 mm aperture.)

Recording and playback time (when using MDW-80)

Maximum 160 min. in monaural

Maximum 320 min. in LP4 stereo

Revolutions

380 rpm to 2,700 rpm (CLV)

Error correction

ACIRC (Advanced Cross Interleave Reed

Solomon Code)

Sampling frequency

44.1 kHz

Sampling rate converter

Input: 32 kHz/44.1 kHz/48 kHz

Coding

ATrac (Adaptive TRansform Acoustic Coding)

ATrac3 — LP2/LP4

Modulation system

EFM (Eight to Fourteen Modulation)

Frequency response

20 to 20,000 Hz \pm 3 dB

Inputs¹⁾

Line in:

stereo mini-jack for analog input

(minimum input level 49 mV)

optical (digital) mini-jack for optical

(digital) input

Outputs

²⁾: stereo mini-jack

Maximum output level

2.5 mW + 2.5 mW; load impedance

16 Ω (European models)

5 mW + 5 mW; load impedance

16 Ω (Other models)

Power requirements

Sony AC Power Adaptor connected at the DC IN 3V jack:

120 V AC, 60 Hz (Models for USA, Canada, Mexico, and Taiwan)

230 V AC, 50/60 Hz (Models for continental Europe and Chili)

240 V AC, 50 Hz (Model for Australia)

220 V AC, 50 Hz (Model for China)

230 V AC, 50 Hz (Models for U.K. and Hong Kong)

240 V AC, 60 Hz (Model for Korea)

100 - 120 V/220 - 240 V AC, 50/60 Hz (Other models)

The recorder:

Nickel metal hydride rechargeable battery

NH-7WMAA 1.2V 700 mAh (MIN) Ni-MH

LR6 (size AA) alkaline battery

Battery operation time³⁾

See "Battery life" (page 52)

Dimensions

Approx. 81.0 \times 27.7 \times 74.4 mm (w/h/d)

(3¹/₄ \times 1¹/₈ \times 3 in.)

Mass

Approx. 103 g (3.6 oz) the recorder only

¹⁾The LINE IN (OPTICAL) jack is used to connect either a digital (optical) cable or a line (analog) cable.

²⁾The  jack connects either headphones/earphones or a line cable.

³⁾Measured in accordance with JEITA.

US and foreign patents licensed from Dolby Laboratories.

Design and specifications are subject to change without notice.

Optional accessories

Optical Cable

POC-15B, POC-15AB, POC-DA12SP

MDR-series stereo headphones/earphones*

SRS-series active speakers

Your dealer may not handle some of the above listed accessories. Please ask the dealer for detailed information about the accessories in your country.

* When using optional headphones, use only headphones/earphones with stereo mini plugs. You cannot use headphones/earphones with micro plugs.

Troubles and solutions

If you find any troubles operating the recorder, follow the steps below.

- 1 Check this section, “Troubles and solutions” (page 57).
You may find the solution of your trouble on “Messages” (page 63) as well. Check the information.
- 2 If you cannot solve the problem after you made checks, consult your nearest Sony dealer.

While charging

| Symptom | Cause/Solution |
|---|--|
| The rechargeable battery does not start charging. The rechargeable battery cannot be fully charged. | <ul style="list-style-type: none">• The rechargeable battery has been inserted incorrectly or the AC power adaptor has been connected incorrectly. ➔ Insert the battery correctly or connect the AC power adaptor correctly. |
| The recorder become hot during the charging procedure. | <ul style="list-style-type: none">• This is not a trouble and poses no danger. |

While recording



| Symptom | Cause/Remedy |
|--|--|
| The recorder overwrites existing materials when record. | <ul style="list-style-type: none">• The record starting-position setting (“R-Posi”) is set to “FrHere”. ➔ Set “R-Posi” setting to “Fr End”. |
| The recording starts from the end of the disc even when “R-Posi” is set to “FrHere”. | <ul style="list-style-type: none">• The group recording (“G-REC”) is set to “G-ON”. (You cannot overwrite tracks when “G-REC” is set to “G-ON”.) ➔ Set the group recording setting to “G-OFF” (page 48). |
| “R-Posi” (the record-starting point) cannot be set to “FrHere”. | <ul style="list-style-type: none">• The group recording (“G-REC”) is set to “G-ON”. ➔ Set the group recording setting to “G-OFF” (page 48), and then set “R-Posi” to “FrHere”. |

| Symptom | Cause/Remedy |
|--|--|
| Recording cannot be done correctly. | <ul style="list-style-type: none"> • Audio sources may not be securely connected. <ul style="list-style-type: none"> ➔ Disconnect the audio sources once and connect them again (pages 16, 18). • There is no digital signal from the portable CD player. <ul style="list-style-type: none"> ➔ When recording digitally from a portable CD player, use the AC power adaptor and disable the anti-skip function (such as ESP) on the CD player (page 18). • The analog recording was made using a connecting cord with an attenuator. <ul style="list-style-type: none"> ➔ Use a connecting cord without an attenuator. • Recording level is too small to record (when adjusting the recording level manually). <ul style="list-style-type: none"> ➔ Pause the recorder and adjust the recording level (page 27). • The power sources was disconnected or a power outage occurred during recording. <ul style="list-style-type: none"> ➔ The recording result is not recorded on the disc. Make recording again. • The premastered MD is inserted. <ul style="list-style-type: none"> ➔ Replace to the recordable MD. • The remaining recordable time on the disc is 12 seconds or less (“FULL” appears). <ul style="list-style-type: none"> ➔ Replace the disc. |
| Recording stops automatically while recording. | <ul style="list-style-type: none"> • You tried to overwrite a track which is transferred from the computer. (Tracks that are transferred from the computer cannot be overwrite. The recording stops automatically.) <ul style="list-style-type: none"> ➔ Transfer back the transferred track into the computer. ➔ Record from the end of the disc. |
| Stereo sound is heard in the headphones/earphones while recording in monaural. | <ul style="list-style-type: none"> • This is normal. During digital recording, the sound will be stereo in the headphones/earphones, even though the recorded sound is monaural. |
| Momentary noise is heard when recording. | <ul style="list-style-type: none"> • Due to the special digital audio compression technology used in LP4 stereo mode, momentary noise may occur on very rare occasions with certain sound sources. <ul style="list-style-type: none"> ➔ Record in SP or LP2 mode. |
| The lid does not open after recording. | <ul style="list-style-type: none"> • The lid does not open until “Edit” disappears in the display. |

| Symptom | Cause/Remedy |
|--|---|
| “TrFULL” appears even before the disc has reached the maximum recording time (60, 74, or 80 minutes) and the recording cannot be done. | <ul style="list-style-type: none"> This is due to the MiniDisc system limitation. When 254 tracks have been recorded on the disc, “TrFULL” appears regardless of the total recorded time. More than 254 tracks cannot be recorded on the disc. <ul style="list-style-type: none"> ➔ To continue recording, erase unnecessary tracks. |
| The remaining recording time does not increase even after erasing numerous short tracks. | <ul style="list-style-type: none"> This is due to the MiniDisc system limitation. Tracks of under 12 seconds (in SP stereo), 24 seconds (in LP2 stereo mode or monaural), or 48 seconds (in LP4 stereo mode) in length are not counted and so erasing them may not lead to an increase in the recording time. |

While playing

| Symptom | Cause/Remedy |
|---|---|
| An MD is not played normally. | <ul style="list-style-type: none"> Repeat play is selected. <ul style="list-style-type: none"> ➔ Use MENU on the recorder to change back to the normal play. Playback mode is changed. <ul style="list-style-type: none"> ➔ Use MENU on the recorder to change back to the normal play. |
| An MD is not played from the first track. | <ul style="list-style-type: none"> Disc playing stopped before it came to the last track. <ul style="list-style-type: none"> ➔ Press ▶ (or ▶ on the remote control) for 2 seconds or more to start playing |
| Playback sound skips. | <ul style="list-style-type: none"> The recorder is placed where it receives continuous vibration. <ul style="list-style-type: none"> ➔ Put the recorder on a stable place. A very short track may cause sound to skip. <ul style="list-style-type: none"> ➔ Try not to create a track under one second long. |
| Sound has a lot of static. | <ul style="list-style-type: none"> Strong magnetism from a television or such device is interfering with operation. <ul style="list-style-type: none"> ➔ Move the recorder away from the source of strong magnetism. |
| The volume of the recorded track is low. | <ul style="list-style-type: none"> The track was recorded in analog (When recorded in digital, the recording level will be automatically adjusted as same as the sound source), or you used a connecting cord with an attenuator. <ul style="list-style-type: none"> ➔ Use a correct connecting cord. The recording level was low. <ul style="list-style-type: none"> ➔ Adjust the recording level manually when recording. |
| Volume cannot be turned up. | <ul style="list-style-type: none"> AVLS is on. <ul style="list-style-type: none"> ➔ Release AVLS settings (page 49). |

| Symptom | Cause/Remedy |
|---|---|
| No sound comes through the headphones/earphones. | <ul style="list-style-type: none"> The headphones/earphones plug is not firmly connected. <ul style="list-style-type: none"> ➔ Plug in the plug of the headphones/earphones firmly to the remote control. Plug in the plug of the remote control firmly to . The plug is dirty. <ul style="list-style-type: none"> ➔ Clean the plug. |
| The recorder skips to several tracks ahead or behind when you press ⏮ or ⏭ on recorder. | <ul style="list-style-type: none"> The GROUP button has been pressed ( is flashing in the display). <ul style="list-style-type: none"> ➔ The recorder returns to normal if no operation has made for 5 seconds. |
| The edited tracks may exhibit sound dropout during search operations. | <ul style="list-style-type: none"> This occurs due to the MiniDisc system limitation. The fragmentation of data may cause sound dropout while searching because the tracks are played in higher speed than normal playback. |
| R-channel sound is not output when playing a track recorded from a cassette deck or an amplifier, or when listening a track with connected cassette deck or through an amplifier. | <ul style="list-style-type: none"> R-channel sound is not output if connecting to a cassette deck or an amplifier with a monaural cord. <ul style="list-style-type: none"> ➔ Make sure to use a stereo connecting cord. However, if the connected equipment is a monaural specification, R-channel sound will not be output even if connecting with stereo connecting cord. |

While Editing

| Symptom | Cause/Remedy |
|--|---|
| The lid does not open. | <ul style="list-style-type: none"> The power sources have been disconnected during recording or editing, or the battery have been exhausted. <ul style="list-style-type: none"> ➔ Set the power sources again, or replace the exhausted battery with new ones. |
| Editing could not be done. | <ul style="list-style-type: none"> The power sources have been disconnected or a power outage occurred while editing. <ul style="list-style-type: none"> ➔ Editing result up to that point is not recorded on the disc. Do the editing operation again |
| The tracks that are transferred from your computer cannot be erased. | <ul style="list-style-type: none"> This is due to the MiniDisc system limitations. To erase a track that has been transferred from your computer, transfer it back first, and then erase it using the SonicStage software. |

| Symptom | Cause/Remedy |
|---|--|
| Track marks cannot be erased. | <ul style="list-style-type: none"> This is due to the MiniDisc system limitations. When the data of a track is fragmented, the track mark of a fragment under 12 seconds long (recorded in SP stereo), 24 seconds long (recorded in LP2 stereo mode or monaural mode), or 48 seconds long (recorded in LP4 stereo mode) cannot be erased. You cannot combine tracks recorded in different recording modes, e.g., a track recorded in stereo and a track recorded in monaural; nor can you combine a track recorded with digital connection and a track recorded with analog connection. |
| The disc cannot be edited on another component. | <ul style="list-style-type: none"> The component does not support LP2 stereo or LP4 stereo. ➔ Edit on other component that support LP2 stereo or LP4 stereo. |
| “TrFULL” appears even before the disc has reached the maximum track number or recording time. | <ul style="list-style-type: none"> This is due to the MiniDisc system limitation. Repeated recording and erasing may cause fragmentation and scattering of data. Although those scattered data can be read, each fragment is counted as a track. In this case, the number of tracks may reach 254 and further recording is not possible. To continue recording, erase unnecessary tracks. |

While using group function

| Symptom | Cause/Remedy |
|---|---|
| The group function does not operate. | <ul style="list-style-type: none"> While using a disc with no group setting, an attempt was made to select some group-related menu. ➔ Use a disc with group setting. |
| A track cannot be recorded to a new group. A new group cannot be created. | <ul style="list-style-type: none"> This is due to the MiniDisc system limitations. Group information has been written to the area where the disc name is stored. The disc name and track names are recorded in the same area, which can store a maximum of approximately 1,700 characters. If the total number exceeds this amount, a new group cannot be created even though group mode is on. It is also impossible to make group settings at this time. |

Others

| Symptom | Cause/Remedy |
|---|---|
| The recorder does not work or works poorly. | <ul style="list-style-type: none"> • The rechargeable battery is not charged. ➔ Charge the rechargeable battery. • The volume is low. ➔ Turn up the volume. • No disc is inserted. ➔ Insert a recorded disc. • The HOLD function is turned on (“HOLD” appears in the display when you press an operation button on the recorder). ➔ On the recorder, disable HOLD by sliding the HOLD switch to the opposite direction of the arrow. • The lid is not firmly closed. ➔ Close the lid until it clicks. Then slide OPEN to open the lid. • Moisture has condensed inside the recorder. ➔ Take the MD out and leave the recorder in a warm place for several hours until the moisture evaporates. • The rechargeable battery or dry battery is weak (“LoBATT” flashes or nothing appears). ➔ Charge the rechargeable battery or replace the dry battery with the new one, or connect the supplied AC power adaptor to the recorder. • The dry battery have been inserted incorrectly. ➔ Insert the battery correctly. • The disc is damaged or does not contain proper recording or editing data. ➔ Reinsert the disc. Rerecord the disc. If the error message still appears, replace it with another disc. • While operating, the recorder received a mechanical shock, too much static, abnormal power voltage caused by lightning, etc. ➔ Restart the operation as follows. <ol style="list-style-type: none"> 1 Disconnect all the power sources. 2 Leave the recorder for about 30 seconds. 3 Connect the power source. |
| The recorder will not play. | <ul style="list-style-type: none"> • A Hi-MD disc or a standard disc in Hi-MD mode is inserted. ➔ Hi-MD discs or standard discs in Hi-MD mode cannot be played on this recorder. |

Messages

If the following error messages flash in the display window, check the chart below.

| Error message | Meaning/Remedy |
|---|---|
| AVLS | <ul style="list-style-type: none">• AVLS is set to "ON" so that the volume will not increase anymore. ➔ Set AVLS to "OFF" (page 49). |
|  FULL | <ul style="list-style-type: none">• You tried to set the 21st bookmark. ➔ You can set up to 20 bookmarks. Set bookmarks within 20. |
| BLANK | <ul style="list-style-type: none">• An MD with no recording on it is inserted. |
| BUSY | <ul style="list-style-type: none">• You tried to operate the recorder while it was accessing the recorded data. ➔ Wait until the message goes out (in rare cases, it may take a few minutes). |
| CannotCHG | <ul style="list-style-type: none">• You tried to charge at a place where the temperature is too high. ➔ Charge the battery at a temperature of 5°C (+41°F) to +40°C (+104°F). |
| Edit | <ul style="list-style-type: none">• The MD player is recording information (track start and end position) from the memory to the disk. ➔ Wait until this process is completed. Do not expose the player to physical shock, nor disrupt power supply. |
| ERROR | <ul style="list-style-type: none">• There is an internal malfunction in the system. ➔ Restart the operation by doing steps 1 to 3 on page 62. If the message appears again, please consult your nearest Sony dealer. |
| FULL | <ul style="list-style-type: none">• The remaining recording time on the disc is 12 seconds (stereo), 24 seconds (LP2 stereo or monaural), 36 seconds (LP4 stereo), or less. ➔ Replace the disc.• You tried to enter more than 200 letters to label a single track or disc.• You tried to enter a total of more than 1,700 letters for track or disc names.• You tried to create a 100th group. ➔ You can create only up to 99 groups on a disc. Keep the group number within 99. |
| HiDCin | <ul style="list-style-type: none">• Voltage of the power supply is too high (The supplied AC power adaptor is not used). ➔ Use the supplied AC power adaptor. |
| Hi-MD Disc | <ul style="list-style-type: none">• A standard disc in Hi-MD mode is inserted. ➔ Standard discs in Hi-MD mode cannot be played on this recorder. |

continued

| Error message | Meaning/Remedy |
|---------------|---|
| HOLD | <ul style="list-style-type: none"> • The recorder is locked. ➔ Slide HOLD against the arrow to unlock the recorder (page 16). |
| LoBATT | <ul style="list-style-type: none"> • Battery is weak. ➔ Replace the dry battery (page 14). |
| MEMORY | <ul style="list-style-type: none"> • You tried to record with the recorder placed where it receives continuous vibration. ➔ Put the recorder on a stable place, and start recording again. |
| NO CHG | <ul style="list-style-type: none"> • You tried to charge at a place where the temperature is too high. ➔ Charge the battery at a temperature of +5°C (+41°F) to +40°C (+104°F). |
| NoCOPY | <ul style="list-style-type: none"> • You tried to make a copy from a disc that is protected by the Serial Copy Management System. You cannot make copies from a digitally connected source which was itself recorded using digital connection. ➔ Use analog connection instead (page 25). |
| NoDISC | <ul style="list-style-type: none"> • You tried to play or record with no disc in the recorder. ➔ Insert an MD. |
| NoEDIT | <ul style="list-style-type: none"> • You selected “G : Ers” with a disc without group setting. ➔ You cannot erase groups with a disc with no groups. • You selected, “G : Set”, “G : Rls”, “Move”, or “Erase” while recording. • You tried to erase the track mark at the beginning of the first track or group. • You tried to erase a track mark to combine tracks the recorder cannot combine (a track recorded in stereo and in mono, for example). • You tried to overwrite a track marks. |
| NoMARK | <ul style="list-style-type: none"> • You selected bookmark play without setting bookmarks. ➔ Set bookmarks (page 29). |
| NO OPR | <ul style="list-style-type: none"> • You tried to make the Auto Time Mark setting while recording through digital connection. • You tried to press II or T MARK during synchro-recording. |
| NO SET | <ul style="list-style-type: none"> • You tried to make the following settings while recording. — Recording mode — Recording level — Selection of “G-REC” in menu — Selection of “R-Posi” during recording to a group. |
| No SIG | <ul style="list-style-type: none"> • The recorder could not detect digital input signals. ➔ Make sure that the source is connected firmly (page 18). |

| Error message | Meaning/Remedy |
|----------------------|---|
| PbONLY | <ul style="list-style-type: none"> You tried to record or edit on a pre mastered MD (Pb stands for “playback”). ➔ Insert a recordable MD. |
| Rd ERR | <ul style="list-style-type: none"> The recorder cannot read the disc information correctly. ➔ Reinsert the disc. A Hi-MD disc is inserted. ➔ Hi-MD discs cannot be played on this recorder. |
| Rec ERR | <ul style="list-style-type: none"> Recording was not correctly done. ➔ Place the recorder at a place with no vibrations and record again. The disc is soiled with an oil film or finger prints, is scratched, or is not a standard disc. ➔ Try recording again with another disc. |
| SAVED | <ul style="list-style-type: none"> You tried to record or edit on a MD with the tab in the record-protect position. ➔ Slide the tab back (page 54). |
| Saving | <ul style="list-style-type: none"> The MD player is recording information (sounds) from the memory to the disc. ➔ Wait until this process is completed. Do not expose the player to any physical shock, nor disrupt power supply. |
| SEL GR | <ul style="list-style-type: none"> You selected “G : Name”, “G : Move”, or “G : Ers” while the recorder is stopped or while playing a track that does not belong to a group. ➔ Select a track within a group you want to edit, and then do the editing operation again. |
| TEMP | <ul style="list-style-type: none"> Heat has built up in the recorder. ➔ Let the recorder cool down. |
| TOC ERR | <ul style="list-style-type: none"> The recorder cannot read the disc information correctly. ➔ Insert another disc. ➔ If it is no problem to erase the entire disc, do so (page 36). |
| TrFULL | <ul style="list-style-type: none"> Track number 254 has been reached. ➔ Erase unnecessary tracks (page 36). |
| TrPROT | <ul style="list-style-type: none"> You tried to record or edit on a track that is protected from erasing. ➔ Record or edit on other tracks. You tried to edit a track that has been transferred from a computer. ➔ Transfer the track back to the computer and then edit. |

Explanations

Difference between digital (optical) and analog (line) inputs

The input jack of this recorder works as both digital and analog input jacks. Connect the recorder to a CD player or a cassette recorder using either digital (optical) input or analog (line) input. To record, see “Recording an MD right away!” (page 17) to record using digital (optical) input, and “Recording from a TV or a radio (Analog Recording)” (page 25) to record using analog (line) input.

| Difference | Digital (optical) input | Analog (line) input |
|---------------------------|---|---|
| Connectable source | Equipment with an digital (optical) output jack (CD player, DVD player, etc.) | Equipment with an analog (line) output jack (Cassette deck, radio, record player, etc.) |
| Usable cord | Optical cable (with an optical or an optical-mini plug) (page 18) | Line cable (with 2 phono plugs or a stereo-mini plug) (page 25) |
| Signal from the source | Digital | Analog Even when a digital source (such as a CD) is connected, the signal sent to the recorder is analog. |
| Track marks ¹⁾ | Marked (copied) automatically <ul style="list-style-type: none">• at the same positions as the source (when the sound source is a CD or an MD).• after more than 2 seconds of no sound (page 67) or low-level segment (with a sound source other than a CD or an MD).• when the recorder is paused (3 seconds of no sound is encountered while synchro-recording) | Marked automatically <ul style="list-style-type: none">• after more than 2 seconds of no sound (page 67) or low-level segment.• when the recorder is paused while recording. |
| Recorded sound level | Same as the source. Can also be adjusted manually (Digital REC level control) (“Adjusting the recording level manually”, page 27). | Adjusted automatically. Can also be adjusted manually (“Adjusting the recording level manually”, page 27). |

¹⁾ You can erase unnecessary marks after recording. (“Combining tracks (combine)”, page 35).

Note

Track marks may be copied incorrectly:

- when you record from some CD players or multi disc players using digital (optical) input.
- when the source is in shuffle or program play mode while recording using digital (optical) input. In this case, play the source in normal play mode.
- when programs with audio that is digitally broadcast (e.g., digital TV) are recorded through the digital (optical) input.

The meaning of “no sound”

“No sound” describes a recorder condition in which the input level is about 4.8 mV during analog input or less than -89 dB during optical (digital) input (with 0 dB as full bit (the maximum recordable level for a MiniDisc)).

Note on digital recording

This recorder uses the Serial Copy Management System, which allows only first-generation digital copies to be made from premastered software. You can only make copies from a home-recorded MD by using the analog (line out) connections.

Premastered software such as CDs or MDs.

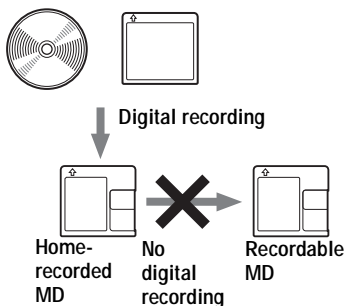

Microphone, record player, tuner, etc. (with analog output jacks).

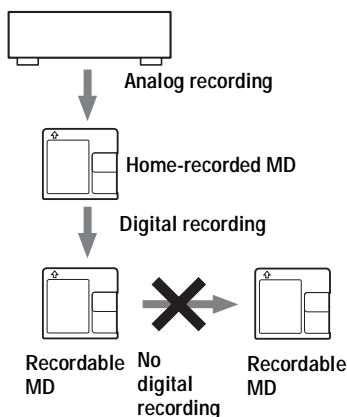

Restrictions on the editing of tracks transferred from your computer

This unit was designed so that editing functions (i.e., erasing tracks, adding track marks, and erasing track marks) do not function for tracks that have been transferred from your computer. This is to prevent the loss of transfer authorization by the transferred tracks. To edit these tracks, first transfer them back into the computer, and then edit them on the computer.

About the DSP TYPE-S for ATRAC/ATRAC3

This recorder supports DSP TYPE-S, a specification for high-level Sony MiniDisc decks equipped with digital signal processors (DSP). This specification allows the recorder to produce high-quality sound from tracks recorded in MDLP mode. Since it retains DSP TYPE-R support, the recorder produces superior results during recording or playback in SP (normal stereo) mode.

Suppressing the skips of the sound (G-PROTECTION)

The G-PROTECTION function was developed to provide a higher level of shock resistance than that of existing players.

What you can do with MD Simple Burner/SonicStage

What you can do with MD Simple Burner

MD Simple Burner allows you to record music tracks from an audio CD in the CD drive of your computer to an MD Walkman, without first recording the music tracks to the computer.

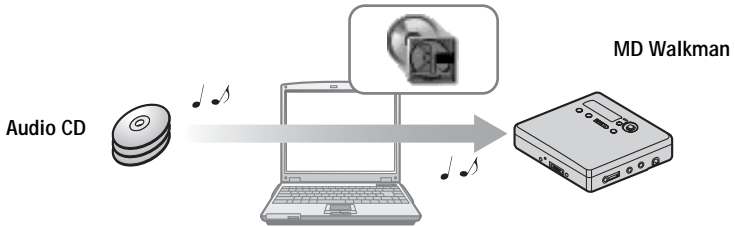

What you can do with SonicStage

SonicStage allows you to import audio data to your computer from music sources such as audio CDs and the Internet, and then transfer the audio data stored in your computer to an MD.

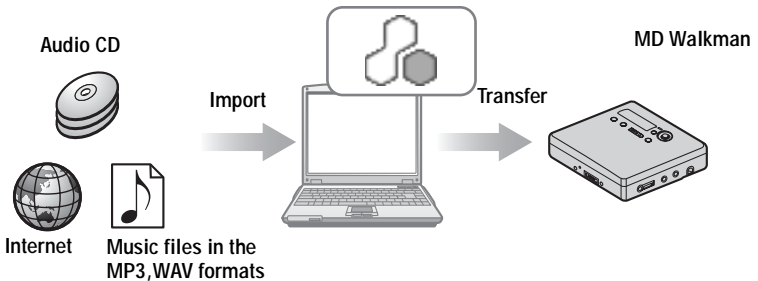

Basic operational flow using an MD Walkman

● MD Simple Burner

● SonicStage

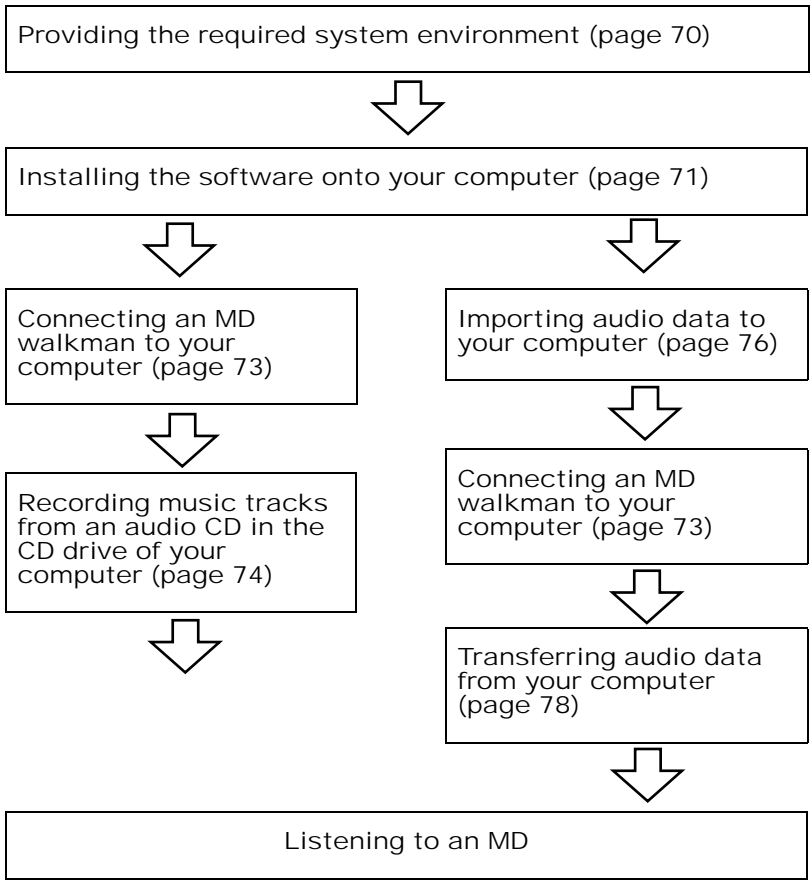

Providing the required system environment

System requirements

The following system environment is required in order to use the SonicStage Ver. 2.0/MD Simple Burner Ver. 2.0 software for the MD Walkman.

| | |
|------------------|---|
| Computer | IBM PC/AT or Compatible |
| | <ul style="list-style-type: none">• CPU: Pentium II 400 MHz or higher (Pentium III 450 MHz or higher is recommended.)• Hard disk drive space: 200 MB or more (1.5 GB or more is recommended) (The amount space will vary according to Windows version and the number of music files stored on the hard disk.)• RAM: 64 MB or more (128 MB or more is recommended) |
| | Others <ul style="list-style-type: none">• CD drive (capable of digital playback by WDM)• Sound Board• USB port (supports USB (previously USB 1.1)) |
| Operating System | Factory installed: Windows XP Media Center Edition 2004/Windows XP Media Center Edition/Windows XP Professional/Windows XP Home Edition/ Windows 2000 Professional/Windows Millennium Edition/Windows 98 Second Edition |
| Display | High Color (16bit) or higher, 800 × 600 dots or better (1024× 768 dots or better is recommended) |
| Others | <ul style="list-style-type: none">• Internet access: for Web registration, EMD services and CDDB• Windows Media Player (version 7.0 or higher) installed for playing WMA files |

This software is not supported by the following environments:

- OSs other than the indicated above
- Personally constructed PCs or operating systems
- An environment that is an upgrade of the original manufacturer-installed operating system
- Multi-boot environment
- Multi-monitor environment
- Macintosh

Notes

- We do not ensure trouble-free operation on all computers that satisfy the system requirements.
- The NTFS format of Windows XP/Windows 2000 Professional can be used only with the standard (factory) settings.
- We do not ensure trouble-free operation of the system suspend, sleep, or hibernation function on all computers.
- For Windows 2000 Professional users, install Service Pack 3 or later version before using the software.

Installing the software onto your computer

Before installing the software

- Make sure to close any virus-check software, as such software usually demands a large amount of system resources.
- When you use the MD Walkman, make sure to install the software with the supplied CD-ROM.
 - If OpenMG Jukebox, SonicStage or Net MD Simple Burner is installed already, the previous software will be overwritten by the new version. The new version retains the functions of the older version, but with new functions added.
 - If SonicStage Premium or SonicStage Simple Burner is installed already, the previous software will co-exist with the new version.
 - You will still be able to use music data registered by an older software version even after SonicStage Ver. 2.0 has been installed. As a precaution, we recommend that you back up your music data. To back up the data, refer to [Backing Up My Library] – [Backing Up Data to a Disk] on SonicStage Help.

1 Turn on your computer and start up Windows.

2 Insert the supplied CD-ROM into the CD drive of your computer.

The setup program starts up automatically and the installation window appears.

Depending on the region, a window may appear asking you to select your country. In this case, follow the displayed instructions.

-
- 3 Click [Install SonicStage and MD Simple Burner] and then follow the displayed instructions.

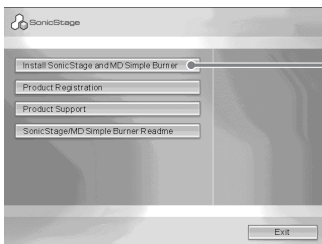

Click [Install SonicStage and MD Simple Burner]

Read the instructions carefully.

Depending on your region, the buttons other than [Install SonicStage and MD Simple Burner] may differ from those in the illustration above.

The installation may take 20 to 30 minutes, depending on your system environment. Make sure to restart your computer only after the installation is completed.

Was the installation successful?

If any trouble occurs during the installation, see "Troubleshooting" (page 88).

Connecting the MD Walkman to your computer

After the software installation is completed, connect the MD Walkman to your computer.

- 1 Insert a recordable disc into the MD Walkman.
 - 2 Make the power source and connect the MD Walkman to the computer using the supplied dedicated USB cable.
-

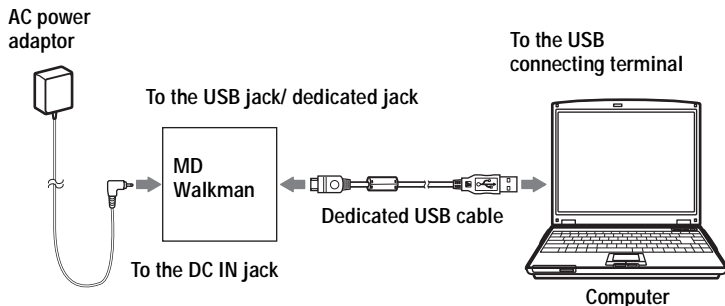

- 3 Check the connections.

When the connections have been properly made, "PC↔MD"* appears in the display of the MD Walkman.

* Depending on the MD Walkman, "Net MD" may be displayed.

Note

When using the MD Walkman connected to your computer, it is recommended that you run the recorder from an AC outlet. If you use a battery to run the MD Walkman, be sure to use a new dry cell or a fully charged rechargeable battery. We do not assure the results should there be a mis-operation, transferring failure, or destruction of audio data caused by insufficient battery power.

Recording by computer operations



MD Simple Burner allows you to record music tracks from an audio CD in the CD drive of your computer to the MD Walkman.

To start MD Simple Burner, click [Start] – [All Programs]* – [MD Simple Burner] – [MD Simple Burner].

* [Programs] in the case of Windows 2000 Professional/Windows Millennium Edition/Windows 98 Second Edition



There are other ways to start up MD Simple Burner as follows:

- Double-click the  MD Simple Burner icon in the task tray, or right-click and select [Show Standard Mode].
- Double-click the  MD Simple Burner shortcut icon on the desktop.

Notes

- Only audio CDs with a  mark can be used with MD Simple Burner.
- We do not guarantee normal operation in the case of the copy-controlled CDs.

The window for recording all tracks on the CD

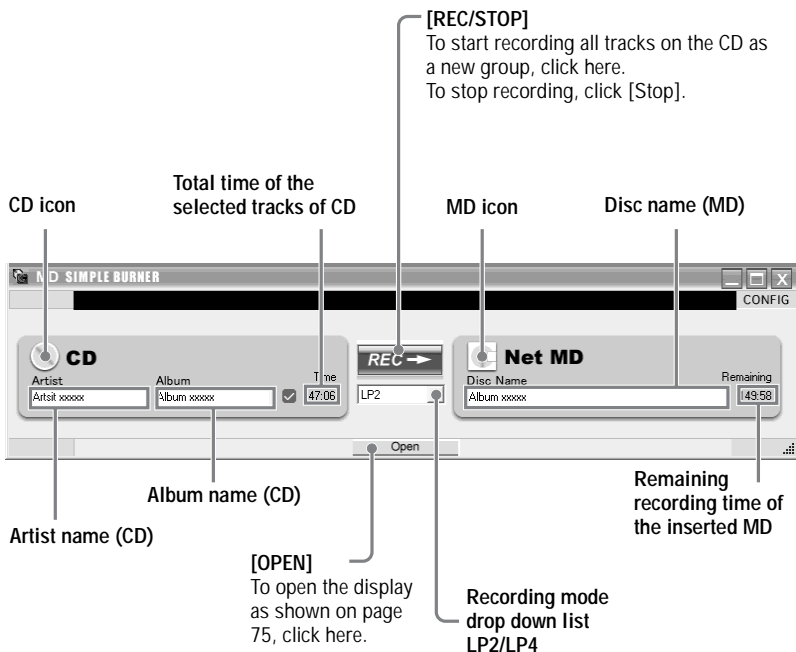

The window for recording selected tracks from an audio CD

Track information
(CD)

[CONFIG]

Click here to do the following:

- Set the CD-ROM drive
- View version information for MD Simple Burner
- Confirm CD information registered in the CDDB

Artist name

Total time of the
selected tracks of CD

Track information (MD)

You can change the
track name and track
number

Album Title

[REC/
STOP]

Disc name
(MD)

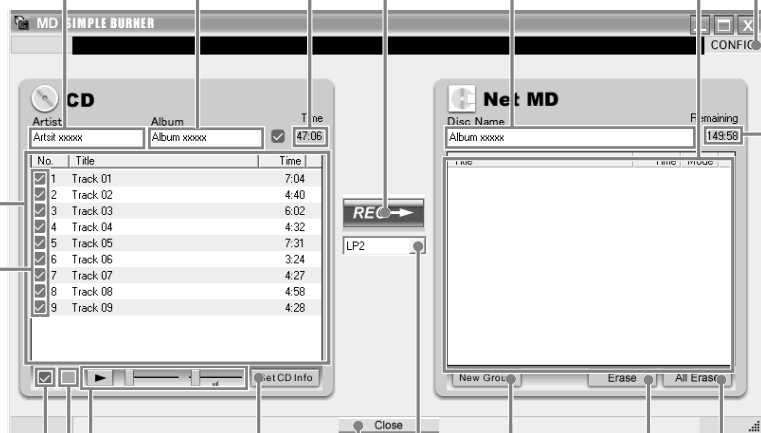

[Get CD info]

Information of an audio CD
(album name, track title,
etc.) will be reflected in the
track list.

[New Group]

Recording mode
drop down list

[CLOSE]

To close the display as shown
on page 74, click here.

CD operating section

Use these controls to confirm the tracks on audio CD to
be recorded

To deselect all tracks, click here.

To select all tracks, click here.

[Erase]

[All Erase]

Check boxes

Check the box of the tracks
that you want to record

Remaining time of the inserted MD

Importing audio data

This section explains how to record and store audio data from an audio CD to My Library of SonicStage on the hard disk drive of your computer.

You can record or import music from other sources such as the Internet and your computer's hard disk. Refer to SonicStage Help for details.

Notes

- Only audio CDs with a  mark can be used with SonicStage.
- We do not guarantee normal operation in the case of the copy-controlled CDs.

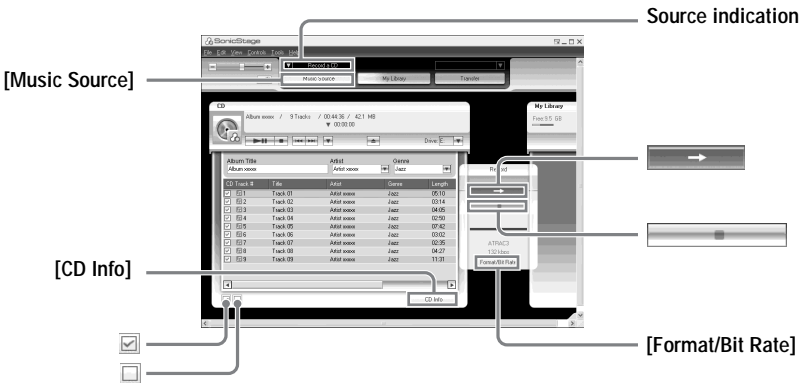

1 Start up SonicStage.

Select [Start] – [All Programs]* – [SonicStage] – [SonicStage].

*[Programs] in the case of Windows 2000 Professional/Windows Millennium Edition/Windows 98 Second Edition

SonicStage starts up and the main window appears.



You can also start SonicStage with double click  ([SonicStage] icon) on the desktop.

2 Insert the audio CD that you want to record into the CD drive of your computer.

The source indication in the top-left of the display changes to [Record a CD].

3 Click [Music Source].

The contents of the audio CD appear in the music source list (on the left side of the screen).

4 If necessary, click to uncheck tracks you do not want to record.

If you unchecked a box by mistake, click it again to restore the check.

To check all boxes, click .

To uncheck all boxes, click .

5 If necessary, change the format and bit rate for recording the audio CD.

When you click [Format/Bit Rate] on the right side of the screen, “CD Recording Format [My library]” dialog box will appear. The dialog box will ask you to select the format and bit rate for recording the audio CD.

6 Click .

The recording of the tracks selected in step 4 starts.

To stop recording

Click .



If CD information such as album title, artist name, and track names could not be obtained automatically, click [CD Info] on the right side of the screen. When you do this, your computer must be connected to the Internet.

Transferring audio data from your computer to the MD Walkman

Audio data stored in My Library of SonicStage can be transferred to your MD Walkman an infinite number of times.

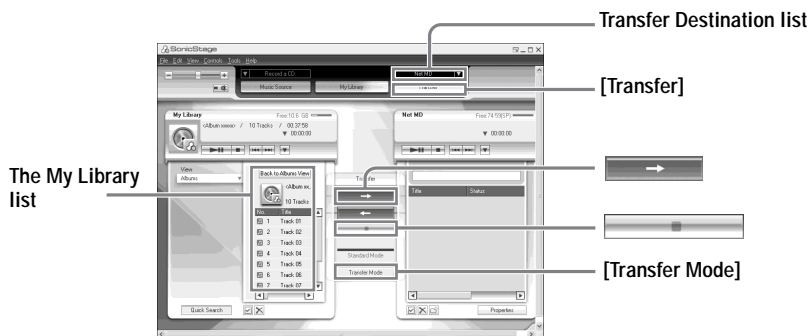

1 Connect your MD Walkman to the computer.

After making the connections, “Net MD” is displayed in the Transfer Destination list in the upper right of the screen.

For details about connections, see “Connecting the MD Walkman to your computer” (page 73).

Do not disconnect the power source or the dedicated USB cable before the transfer has completed.

2 Click [Transfer].

The screen is switched to the Transfer (Net MD) screen.

3 Click the tracks you want to transfer in the My Library list on the left side of the screen.

To transfer more than one track, hold down the [Ctrl] key while selecting the tracks. To transfer all tracks of the album, click the album.

4 Change the transfer mode, if necessary.

Click [Transfer Mode] in the middle of the screen to display the “Transfer Mode Settings” dialog box (for Net MD) and select the transfer mode.

5 Click  .

Transfer of the tracks selected in step 3 begins.

To stop transferring

Click  .

Notes

- A transfer will fail and an error message will appear in the following cases:
 - When there is not enough free space on the disc.
 - When the track is subject to playback restrictions.
- During the transfer, the system suspend, sleep, or hibernation function will not operate.
- Depending on the type of the text and number of characters, the text entered by SonicStage may not be displayed on the connected MD Walkman. This is due to the limitations of the connected MD Walkman.
- When using your MD Walkman connected to the computer, be sure to use a new battery. We do not assure the results should there be a mis-operation, transferring failure, or destruction of audio data caused by insufficient battery power.

Transferring back audio data from the MD Walkman to your computer

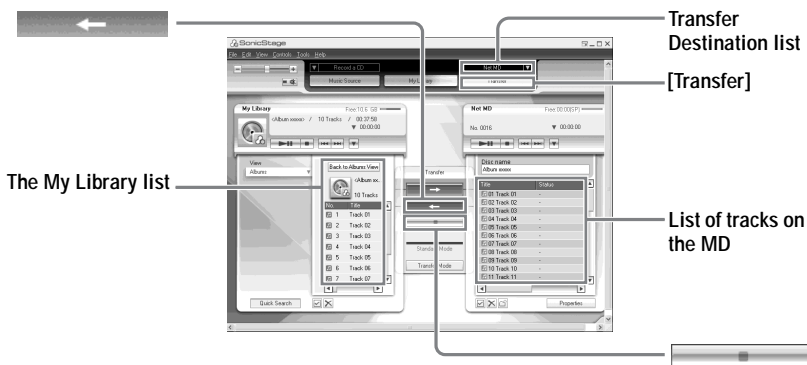

Transferring from the MD Walkman back to your computer

Audio data that has been transferred from your computer and stored on the MD can be transferred back to My Library of SonicStage on your computer.

- 1 Connect your MD Walkman to the computer.
After making the connections, “Net MD” is displayed in the Transfer Destination list in the upper right of the screen.
For details about connections, see “Connecting the MD Walkman to your computer” (page 73).
Do not disconnect the power source or the dedicated USB cable before the transfer has completed.
- 2 Click [Transfer].
The screen is switched to the Transfer (Net MD) screen.
- 3 In the Net MD list on the right side of the screen, click to select the tracks you want to transfer to your computer.

4 Click  in the middle of the screen.

The transferring of the tracks selected in step 3 starts.

To stop transferring

Click  .

Note

Tracks transferred to the MD Walkman from another computer cannot be transferred back to My Library on your computer.

Using SonicStage Help

SonicStage Help provides further details on how to use SonicStage. SonicStage Help allows you to search easily for information from a list of operations, such as “Importing audio data” or “Transferring audio data”, or from large list of keywords, or by typing in words that might lead you to the appropriate explanations.

To display SonicStage Help

Click [Help] – [SonicStage Help] while SonicStage is running.

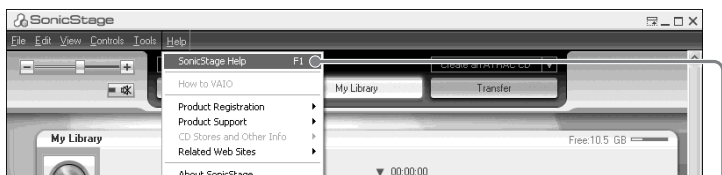

[SonicStage Help]



You can display SonicStage Help by selecting the following:
[Start] – [All Programs]* – [SonicStage] – [SonicStage Help].

* [Programs] in the case of Windows 2000 Professional/Windows Millennium Edition/Windows 98 Second Edition

Notes

- In SonicStage Help, “Device/Media” is the general term for the external device such as the MD Walkman, the Network Walkman, and the CD Walkman.
- Follow the instructions of your internet provider regarding such things as recommended system.

Understanding SonicStage Help

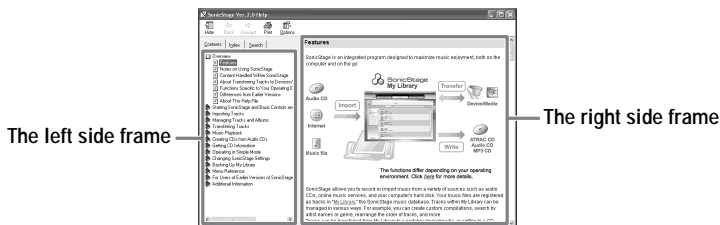

- 1 Double click [Overview] in the left-side frame.
- 2 Click [About This Help File].
The explanation will appear in the right-side frame.
- 3 Read the text.
Scroll the display if necessary.
Click underlined words to jump to their explanations.

Searching for a word inside an explanation

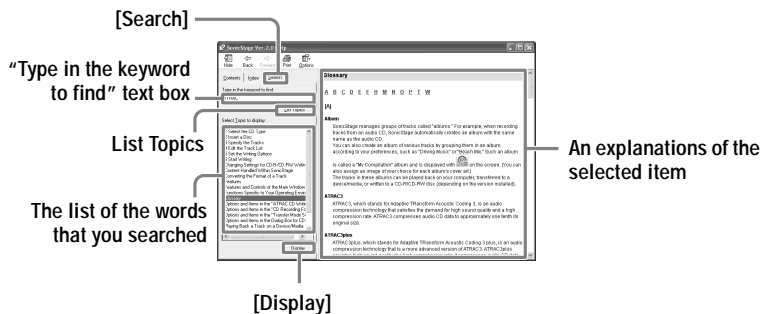

- 1 Click [Search] to open the "Search" window.
- 2 Type in the words.
- 3 Click [List Topics].
A list of the words that were searched is displayed.
- 4 Click to select the desired item among those displayed.
- 5 Click [Display].
An explanation of the selected item is displayed.

Referring to SonicStage Help

Click [Contents] on the left side of the Help window to view a list of items for each operation. Click on any items for details.

Importing audio data to the computer

| To | SonicStage Help |
|--|--|
| Import audio data from the Internet | [Importing tracks] – [Purchasing Tracks from a Music Service Site] |
| Import audio files on the computer in SonicStage | [Importing tracks] – [Importing Music Files] |

Listening to audio data on the computer

| To | SonicStage Help |
|--|---|
| Listen to audio data from the CD drive or My Library | [Music Playback] – [Playing Back an Audio CD] or [Playing Back a Track in My Library] |
| Listen to audio data on the MD Walkman connected to the computer | [Music Playback] – [Playing Back a Track on a Device/Media] |

Managing and editing imported tracks

| To | SonicStage Help |
|--|--|
| Change information related to CD information downloading | [Changing SonicStage Settings] – [Changing Settings for Getting CD information] |
| Edit an album Delete the tracks | [Managing Tracks and Albums] – [Creating/Editing Albums] |
| Change the destination directly for track storage | [Changing SonicStage Settings] – [Changing the Location for Saving Recorded Files] |

Backing up audio data

We recommend that you back up your music data as a precaution against hard disk crashes or computer replacement.

| To | SonicStage Help |
|----------------------------------|--|
| Back up audio data in My Library | [Backing Up My Library] – [Backing Up Data to a Disk] |
| Look up about SonicStage backup | [Backing Up My Library] – [FAQ-About SonicStage Backup Tool] |

Troubleshooting

| To | SonicStage Help |
|-----------------------------------|--|
| Look up troubleshooting procedure | [Additional Information] – [Troubleshooting] |

When you want to know

| To | SonicStage Help |
|---|--|
| Look up unknown words | [Additional Information] – [Glossary] |
| Look up the kinds of audio data that can be managed by SonicStage | [Overview] – [Content Handled Within SonicStage] |
| Look up the kinds of functions that can be used with SonicStage | [Overview] – [Features] |

Uninstalling SonicStage/MD Simple Burner

To uninstall SonicStage/MD Simple Burner, follow the procedures below.

1 Click [Start]–[Control Panel]*.

* [Settings]–[Control Panel] in the case of Windows 2000 Professional/Windows Millennium Edition/Windows 98 Second Edition

2 Double-click [Add/Remove Programs].

3 Click [SonicStage 2.0.xx] or [MD Simple Burner 2.0.xx] in the “Currently Installed Programs” list, and then click [Change and Remove]*.

Follow the displayed instruction and restart your computer. The uninstallation is completed when the computer has restarted.

* [Change/Remove] in the case of Windows 2000 Professional, [Add/Remove] in the case of Windows Millennium Edition/Windows 98 Second Edition

Note

When you install SonicStage Ver.2.0/MD Simple Burner Ver.2.0, OpenMG Secure Module 3.4 is installed at the same time. Do not delete OpenMG Secure Module 3.4 since it may be used by other software.

On copyright protection

The OpenMG technology allows you to enjoy digital music, while maintaining the copyrights of its holders. SonicStage encrypts audio files in OpenMG format and stores them on the hard disk of your computer to prevent unauthorized distribution.

Restrictions on audio content

High-quality digital audio content is widely available through music distribution services on the Internet. To protect the copyrights of its holders from unauthorized distribution, some audio content is distributed with certain restrictions on recording and playback. For example, the playback period or playback count for the data may be limited.

Troubleshooting

Please refer to the following steps if you encounter a problem while using SonicStage/MD Simple Burner.

- 1 Check the symptoms in this “Troubleshooting” section.
- 2 Check the symptoms in SonicStage Help when you use SonicStage.
- 3 If the problem cannot be solved after checking the above references.
Check the following table and then consult your nearest Sony dealer.

| |
|--|
| Computer <ul style="list-style-type: none">• Manufacturer:• Model:• Type: Desktop type / Laptop type |
| Name of operating system: |
| RAM capacity: |
| Hard disk drive (containing SonicStage/MD Simple Burner and audio data) <ul style="list-style-type: none">• Capacity of the drive:• Free space: |
| Version of the software <ul style="list-style-type: none">• SonicStage Ver. 2.0¹⁾• MD Simple Burner Ver.2.0²⁾ |
| Error Message (if one appear): |
| If an externally connected CD-ROM drive is used <ul style="list-style-type: none">• Manufacturer:• Model:• Type: CD-ROM / CD-R/RW / DVD-ROM / Other ()• Type of connection to the computer: PC card / USB / IEEE1394 / Other () |
| If another device with USB connection is used <ul style="list-style-type: none">• Name of the device (or devices): |

- ¹⁾ To check the SonicStage software version, go to [Help] – [About SonicStage] in the SonicStage window.
- ²⁾ To check the MD Simple Burner software version, go to [CONFIG] – [Version] in the MD Simple Burner window.

The software cannot be installed onto your computer

| Problem | Cause/Remedy |
|---|--|
| The installation was not successful. | You are using an OS that does not support this software. → See page 70 for more details. All windows applications are not closed. → If you start the installation while other programs are running, a malfunction may occur. This is especially true for programs that require large amounts of system resources, such as virus-check software. There is not enough hard disk space on your hard disk. → You need 200MB or more free space on your hard disk. |
| The installation appears to have stopped before it has completed. | Check for the appearance of an error message beneath the installation window. → Press the [Tab] key while holding down the [Alt] key. If an error message has appeared, press the [Enter] key. The installation will resume. If there is no message, the installation is still in progress. Wait a little while longer. |
| The progress bar on the display is not moving. The access lamp has not lit for a few minutes. | The installation is progressing normally. Please wait. The installation may take 30 minutes or more, depending on your CD drive or system environment. |

Using a MD Walkman connected to the computer

| Problem | Cause/Remedy |
|---|--|
| Your computer does not recognize the MD Walkman. | The MD Walkman is not firmly connected with the supplied dedicated USB cable to the computer. →Reconnect the MD Walkman to the computer firmly. A disc is not inserted in the MD Walkman. →Check if a disc is inserted in the MD Walkman. The Net MD driver is not be installed. →Install the SonicStage/MD Simple Burner software using the supplied CD-ROM. |
| Even though the dedicated USB cable is used to connect the MD Walkman to the computer, the display on the MD Walkman does not indicate it is connected. | It takes time to recognize SonicStage. Please wait. The other application software is running. →Reconnect the supplied dedicated USB cable after a while. If the computer still does not recognize the MD Walkman, disconnect the MD Walkman, restart the computer, and connect the dedicated USB cable again. |
| The progress bar on the display is not moving. The access lamp has not lit for a few minutes. | The supplied dedicated USB cable is disconnected. →Connect the supplied dedicated USB cable firmly. The connections are made through a USB hub. →Operations are not guaranteed for USB-hub connections. Connect the MD Walkman directly to the USB connector on the computer. |

Index

A

Accessories

- optional 56
- supplied 10

Auto Time Mark 25

AVLS 49

B

Bookmark

- add 29
- play 30

C

CD drive 70

CDDB 70

CD-ROM 71

Charging 15

Checking

- playing position 28
- remaining time 22, 28

Cleaning 54, 55

Combining tracks 35

Connecting 73

- analog 25
- digital 18
- when charging 15

Copyright protection 87

D

Divide

- directly 35
- rehearsal 35

DSP TYPE-S 67

E

EMD service 70

Erasing

- a whole disc 37
- groups 44
- tracks 36

G

G-PROTECTION 67

Group

- erasing 44
- moving 43
- play 39
- recording 38
- releasing 41
- setting 40
- skip 39

Group Program Play 40

H

Hard disk

- free space 70

I

Importing 76

Installing 70

L

Labeling

- a disc 32
- tracks 32

M

Manual recording 27

MD Simple Burner 74

MDLP 24

Menus 50

Move

- groups 42
- tracks 33

My Library 76

N

Name

- a disc 32
- groups 42
- tracks 32

Net MD 67

No sound 67

O

OpenMG Secure Module 3.4 86

P

Play mode

- groups 39
- tracks 29

Q

Quick mode 48

R

Recording

- analog 25
- digital 17
- level 27
- MDLP mode 24
- without overwriting tracks 48

Recording mode (Bit rate) 77

Relabeling 33

S

SonicStage 76

SonicStage Help 82

Start (software)

- MD Simple Burner 74
- SonicStage 76

Synchro-recording 23

System environment 70

System limitations 70

T

Track mark

- Add (Divide) 34
- Erase (Combine) 35

Transferring

- to the MD Walkman 78
- to your computer 80

U

Uninstalling 86

USB

- cable 10

USB port 70

W

Windows 2000 Professional 70, 74, 76, 82, 86

Windows 98 Second Edition 70, 74, 76, 82, 86

Windows Media Player 70

Windows Millennium Edition 74, 76, 82, 86

Windows XP Home Edition 70

Windows XP Media Center Edition 70

Windows XP Media Center Edition 2004 70

Windows XP Professional 70

WMA 70



Printed using VOC (Volatile Organic Compound)-free vegetable oil ink.

<http://www.sony.net/>

Printed in Malaysia



* 3 2 6 5 3 4 5 1 1 * (1)