

**Scheibe montieren**

GB	Mounting a disk
F	Monter le disque
NL	Schijf monteren
I	Montare la mola
E	Montar disco
S	Montera skivan
DK	Monter skive
N	Monter skiven
FIN	Hiomalaikan asentaminen
GR	Τοποθετήστε το δίσκο
CZ	Montování kotouče
PL	Montaż tarczy
RUS	Установить Шлифовальный круг
P	Montar anel
H	Korongot felszerelni
KOR	연삭숫돌 장착

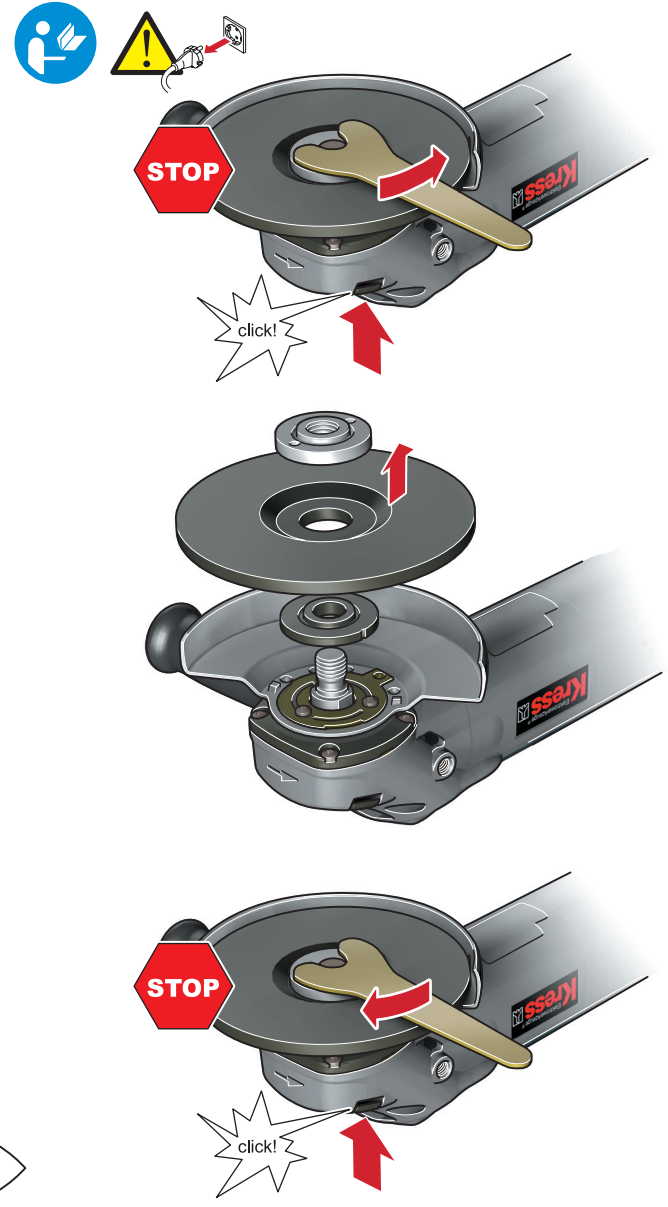
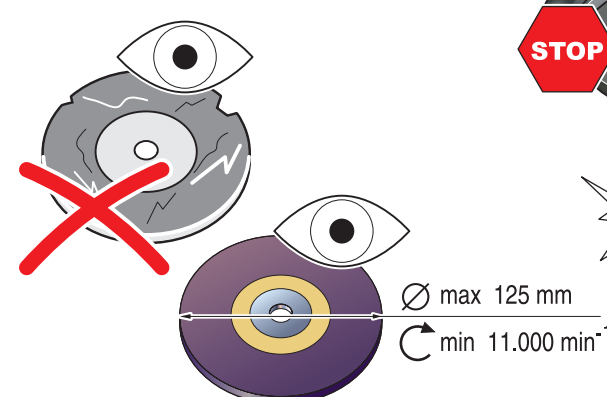
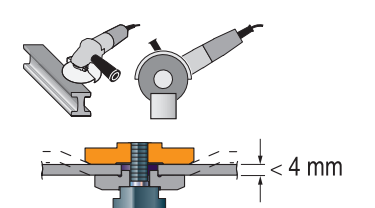
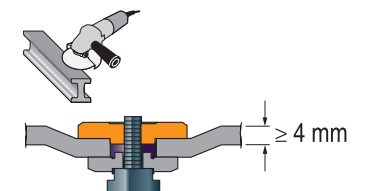

**Ein ① / Aus ②**

On / Off	①	②	GB
Marche/Arrêt	①	②	F
Aan / Uit	①	②	NL
On / Off	①	②	I
Con / Des	①	②	E
Till/Från	①	②	S
Til / Fra	①	②	DK
På / Av	①	②	N
Käynnistys	①	②	FIN
Ενεργοποίηση	①	②	GR
Zap / Vyp	①	②	CZ
Włącz / Wyłącz	①	②	PL
Вкл. / Выкл.	①	②	RUS
Ligar / Desligar	①	②	P
Be / Ki	①	②	H
스위치 작동법	①	②	KOR

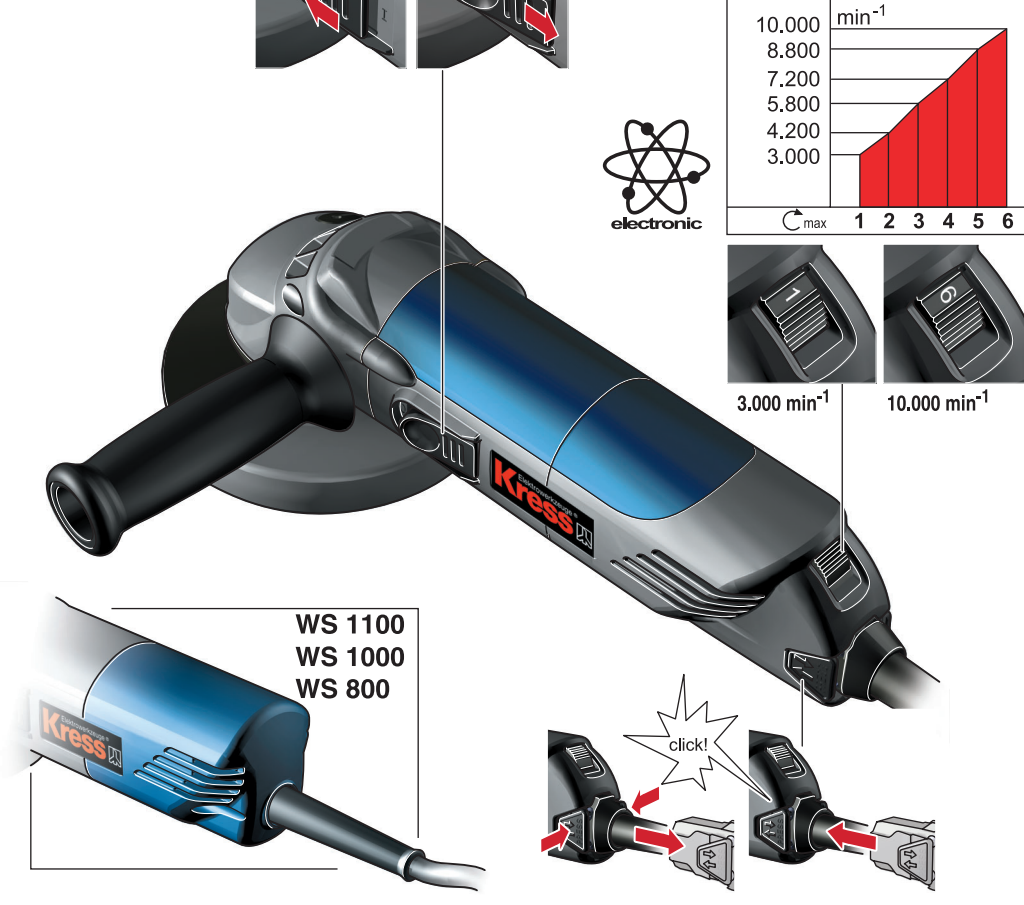

**Sicheres Arbeiten**

Save working	GB
Travailler en toute sécurité	F
Veilige werkmethode	NL
Lavoro sicuro	I
Operación segura	E
Säkert arbete	S
Sikkert arbejde	DK
Sikker jobbing	N
Turvallinen toiminta	FIN
Ασφαλής εργασία	GR
Bezpečné pracovní	CZ
Bezpieczna praca	PL
Безопасная работа	RUS
Operação segura	P
Biztonságos munkavégzés	H
작업시 주의사항	KOR



**Kohlebürsten wechseln**

Brush replacement	GB
Changer les balais	F
Koolborstels wisselen	NL
Sostituire le spazzole	I
Renovar escobillas de carbón	E
Byta kolborstarna	S
Skift kulbørster	DK
Skift kulbørstene	N
Hiiliharjojen vaihto	FIN
Αντικαταστήστε τις βούρτσες άνθρακα	GR
Výměna uhlíkových kartáčů	CZ
Wymiana szcetek węglowych	PL
Замена угольных щеток	RUS
Renovar escovas de carvão	P
Szénkeféket cserélni	H
카본브러쉬 교환방법	KOR

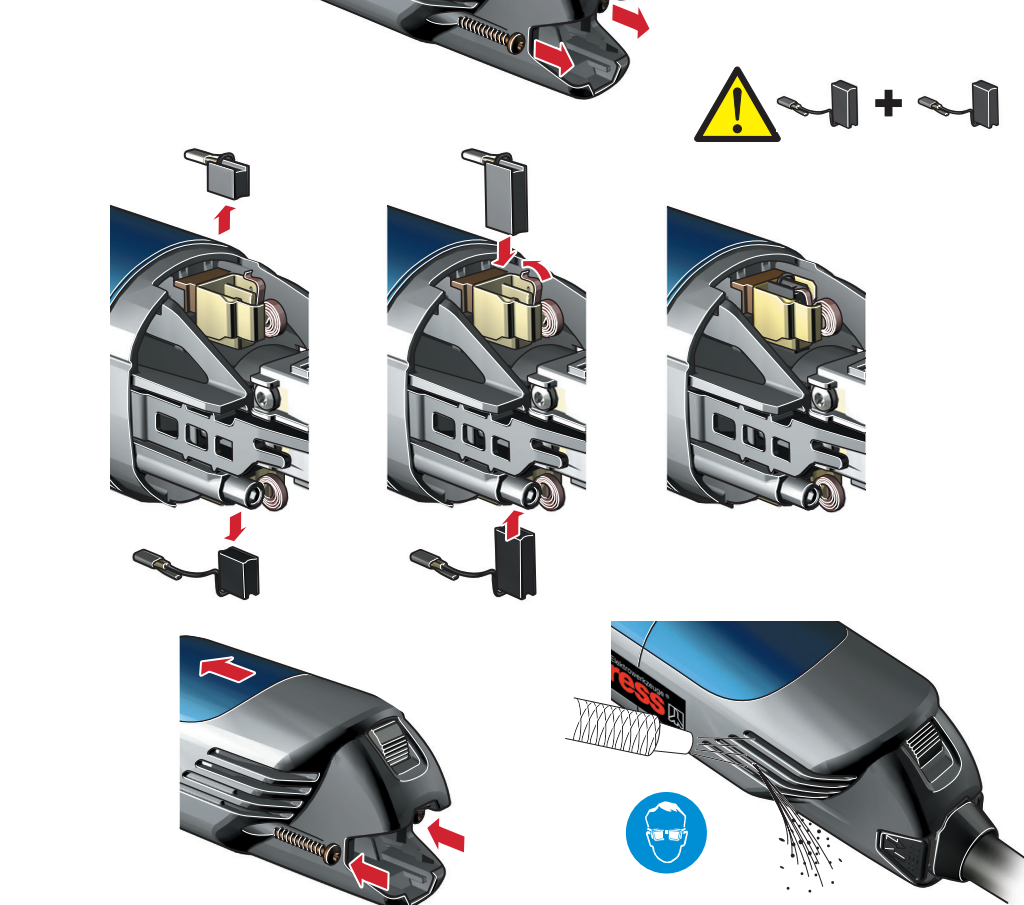



## Service

### **D** CE Konformitätserklärung

Wir erklären in alleiniger Verantwortung, dass dieses Produkt mit den folgenden Normen oder normativen Dokumenten übereinstimmt: siehe unten

### **GB** CE Declaration of conformity

We declare under our sole responsibility that this product is in conformity with the following standards or standardization documents: see below

### **F** CE Déclaration de conformité

Nous déclarons sous notre propre responsabilité que ce produit est en conformité avec les normes ou document normalisés : Voir ci-dessous

### **NL** CE Konformiteitsverklaring

Wij verklaren op eigen verantwoording, dat dit produkt voldoet aan de volgende normen of normatieve documenten: zie onder

### **I** CE Dichiarazione di conformità

Assumendone la piena responsabilità, dichiariamo che il dotto è conforme alle seguenti normative ed ai relativi documenti: vedere sotto

### **E** CE Declaracion de conformidad

Declaramos bajo nuestra sola responsabilidad que este producto está en conformidad con las normas o documentos normalizados siguientes: ver abajo

### **S** CE Konformitetsförklaringen

Vi intygar och ansvarar för att denna produkt överensstämmer med följande norm och dokument: se nedan

### **DK** CE Overensstemmelseserklæring

Vi erklærer under almindeligt ansvar, at dette produkt er i overensstemmelse med følgende normer eller normative dokumenter: se nedenfor

### **N** CE Erklæring av konformitet

Vi overtar ansvaret for at dette produktet er i overensstemmelse med følgende standarder eller standarddokumenter: se nede

### **FIN** CE Todistus

**standardinmukaisuudesta**  
Todistamme täten ja vastaame yksin siitä, että tämä tuote on allatueteltujen standardien ja stardoimisasiakirjojen vaatimusten mukainen: katso alla

### **GR** CE Δήλωση συμμορφότητας

Δηλώνουμε υπευθύνως ότι το προϊόν αυτό είναι κατασκευασμένο σύμφωνα με τους εξής κανονισμούς ή κατασκευαστικές συστάσεις: βλέπε κάτω

EN 50144-2-3, EN 60745-1,  
EN 55014-1, EN 55014-2, EN 61000-3-2, EN 61000-3-3,  
72/23/EWG, 89/336/EWG, 98/37/EG

Kress-elektrik GmbH + Co., D-72406 Bisingen  
Bisingen, im Juli 2004

  
Alfred Binder,  
Entwicklungsleiter

### **PL** Oświadczenie o zgodności norma bezpieczeństwa CE

Niniejszym oświadczamy na nasza wyłączna odpowiedzialność, że niniejszy produkt spełnia wymogi następujących norm lub dokumentów normatywnych: zob. niżej

### **CZ** CE Prohlášení o shode

Prohlašujeme, že výrobce posoudil shodu výrobku S technickými požadavky na el.bezpečnost a EMC a jsou v souladu S normami: viz dole

### **RUS** Сертификат соответствия CE

Настоящим заявляем со всей ответственностью, что данное изделие соответствует следующим нормам или нормативным документам: смотри ниже

### **P** Declaração de conformidade CE

Declaramos a responsabilidade exclusiva que este produto está em conformidade com as seguintes normas ou documentos normativos: Veja abaixo.

### **H** CE Egenlóségi nyilatkozat

Teljes felelősségünkkel igazoljuk, hogy ez a termék az alábbi normáknak vagy az ezen normákat alátámasztó dokumentumoknak megfelel: lásd alul

### **B NL** Belgie/Belgique, Nederland

Present Handel bvba/sprl  
Industriezone "Wolfstee"  
Toekomstlaan 8  
B-2200 Herentals  
Telefon: +32(0)14-257474  
Telefax: +32(0)14-257475  
e-mail: info@present.be

### **ISR** שירות ע"י כל סיניפי הוס סנטר

### **D** Bundesrepublik Deutschland

**Kress-elektrik GmbH & Co.**  
Elektromotorenfabrik  
Abt. Kundendienst / Werk 2  
Hechinger Straße 48  
D-72406 Bisingen / Zollernalbkreis  
Telefon: +49-(0)7476-87450  
Telefax: +49-(0)7476-87375  
E-mail: tkd@kress-elektrik.de

### **A** Österreich

**b+s Elektroinstallations- und Maschinenbaugesellschaft m.b.H.**  
Jheringgasse 22  
A-1150 Wien  
Telefon: +43-(0)1-8936077  
Telefax: +43-(0)1-8936016  
E-mail: office@bs-elektro.at

### **CH** Schweiz/Suisse

**CEKA Elektrowerzeuge AG + Co. KG**  
Industriestraße 2  
CH-9630 Wattwil  
Telefon: +41-(0)71-9874040  
Telefax: +41-(0)71-9874041  
E-mail: info@ceka.ch

### **GB** Great Britain

**N & J Tools Ltd.**  
Westcross Centre, 15 Shield Drive  
Brentford TW8 9EX  
Phone: +44 (0)208-560 0885  
Telefax: +44 (0)208-847 0790  
E-mail: njtoolsbrentford@btopenworld.com

### **F** France

**S.A.R.L. Induba**  
4, Rue du Viaduc - B.P. 1  
F-01130 Les Neyrolles  
Téléphone: +33-(0)4-74750133  
Téléfax: +33-(0)4-74752362  
E-mail: induba@online.fr

### **B NL** Belgie/Belgique, Nederland

Present Handel bvba/sprl  
Industriezone "Wolfstee"  
Toekomstlaan 8  
B-2200 Herentals  
Telefon: +32(0)14-257474  
Telefax: +32(0)14-257475  
e-mail: info@present.be

### **ISR** שירות ע"י כל סיניפי הוס סנטר

### **H** Hungaria

**MAQYARORSZAG**  
Csöszer & Co. Kft, Fischer Ke'pviselet  
Gubacsi út 28  
107 Budapest  
Phone: +36 -280 1020, 280 1000  
Telefax: +36 -280 8329, 280 1008  
E-Mail: fischer.hu@matavnet.hu  
www.fischerhungary.hu

### **E** Espana

**Apolo fijaciones y herramientas s.l.**  
Garrotxa Naves 10-22  
Polig. Ind. Pla. de la Bruguera  
E-08211 Castellar del Vallès (Barcelona)  
Telefono: +34 -93 -747 33 35  
Telefax: +34 -93 -747 33 37  
E-mail: fijaciones@apolo.es

### **S** Sverige

**AB Novum**  
Mörsaregatan 8  
S-25466 Helsingborg  
Phone: +46 (0)42 - 15 10 30  
Telefax: +46 (0)42 - 16 16 66  
E-mail: mail@abnovum.se

### **DK** Danmark

**Ryttergaard Vaerktojs A/S**  
Postbox 118, Rodovrevej 151  
DK-2610 Rodovre  
Phone: +45 -36 70 65 55  
Telefax: +45 -36 41 44 72  
E-mail: Kress@os.dk

### **FIN** Suomi

**Tecalemit**  
Hankasuontie 13, P.O. Box 78  
FIN-00391 Helsinki  
Phone: +358 (0)9 - 54 77 01  
Telefax: +358 (0)9 - 547 17 79  
E-mail: jyri.lahti@tecalemit.fi

### **N** Norge

**Ifö Electric AS**  
P.O.B. 336 Alnabru  
Brobekveien 115 B  
N-0614 Oslo  
Phone: +47 -23 -37 81 10  
Telefax: +47 -23 -37 81 20  
E-mail: info@foelectric.no

### **P** Portugal

**Sarraipa S.A.**  
Máquinas e Equipamentos Industriais  
Rua das Flores, Carreira d'Água  
Zona Industrial da Barosa  
PT-2400 Leiria  
Phone: +351 - (2)44 - 81 90 60  
Telefax: +351 - (2)44 - 81 90 69  
E-mail: sarraipa@net.sapo.pt

### **KOR** Korea

**Phenix Trading Co., Ltd.**  
Phenix BLDG. 926-3, Bangbae-Dong,  
Seocho-Ku, Seoul 137-843, Korea  
Mail: C.P.O. Box 2995 Seoul, Korea  
Phone:+82 -2-586-7136, 7137, 7138, 0960  
Telefax: +822-586-8948, 598-7634  
E-mail: phenix@unitel.co.kr

### **CZ** Czech republic

**Fischer International s.r.o.**  
Prumyslova 1833  
CZ-25001 Brandys n./L  
Phone: +42 (0)326 - 90 46 01  
Telefax: +42 (0)326 - 90 46 00  
E-mail: custom.service@ics.cz

### **PL** Polska

**Construbau Polska sp. z.o.o.**  
Ul. Albatrosów 2  
PL-30-716 Kraków  
Phone: +48 (0)12 - 290 08 80  
Telefax: +48 (0)12 - 290 08 88  
E-mail: info@construbau.com

### **RUS** Россия

**ДАНГА**  
Нахимовский проспект 48  
Россия 117292 Москва  
Телефон: +7 (0)95 - 125-17-25  
Телефакс: +7 (0)95 - 125-17-25  
E-mail: danga@stk.mmtel.ru

### **GR** Hellas

**D. Nikolaou & Co Ltd.**  
Leonidou 6; GR-17343 Athens  
Phone: +30 -210 -975 37 57  
Telefax: +30 -210 -973 74 23  
E-mail: vnikaou@internet.gr

### **I** Italia

**Hodara Utensili S.p.A.**  
Viale Lombardia, 16  
I-20090 Buccinasco (Milano)  
Telefono: +39 -02 -48 84 25 97  
Telefax: +39 -02 -48 84 27 75  
E-mail: info@hodara.it



<http://www.kress-elektrik.de>  
<http://spareparts.kress-elektrik.de>

WS 1100 E  
 WS 1100  
 WS 1000  
 WS 800

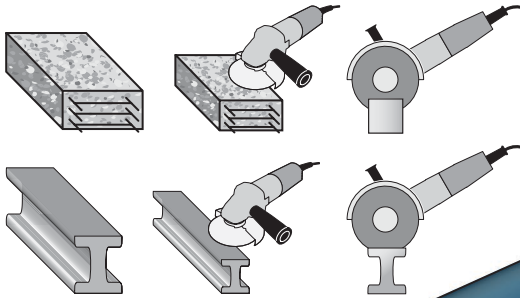























**Bedienungsanleitung** (D)

- Operating instructions (GB)
- Instructions d'emploi (F)
- Gebruiksaanwijzing (NL)
- Istruzioni d'uso (I)
- Instrucciones de manejo (E)
- Bruksanvisning (S)
- Betjeningsvejledning (DK)
- Bruksanvisning (N)
- Käyttöohje (FIN)
- Οδηγίες χρήσης (GR)
- Návod k obsluze (CZ)
- Instrukcja obsługi (PL)
- Руководство по обслуживанию (RUS)
- Instruções de serviço (P)
- Használati utasítás (H)
- 사용 설명서 (KOR)



35451/0409

D Sicherheitshinweise				
(GB) Notes on safety				
(F) Consignes de sécurité				
(NL) Veiligheidsinstructies				
(I) Istruzioni di sicurezza				
(E) Indicaciones de seguridad				
(S) Säkerhetsföreskrifter				
(DK) Bemærkninger til sikkerheden				
(N) Sikkerhetsshenvisning				
(FIN) Turvallisuusohjeet				
(GR) Οδηγίες ασφαλείας				
(CZ) Bezpečnostní pokyny				
(PL) Wskazówki odnośnie bezpieczeństwa pracy				
(RUS) Инструкции по технике безопасности				
(P) Instruções de segurança				
(H) Biztonsági előírások				
(KOR) 안전수칙				

D Technische Daten		WS 1100 E	WS 1100	WS 1000	WS 800
(GB) Technical data		220 - 230 V 50/60 Hz 1100 W	220 - 230 V 50/60 Hz 1100 W	220 - 230 V 50/60 Hz 1000 W	220 - 230 V 50/60 Hz 800 W
(F) Caractéristiques techniques					
(NL) Technische gegevens					
(I) Caratteristiche tecniche		3,000 - 10,000 min <sup>-1</sup>	11,000 min <sup>-1</sup>	11,000 min <sup>-1</sup>	11,000 min <sup>-1</sup>
(E) Parámetros técnicos					
(S) Tekniska data					
(DK) Tekniske specifikationer		LWA= 103 dB(A) LpA = 89 dB(A)			
(N) Tekniske data					
(FIN) Tekniset tiedot					
(GR) Τεχνικά χαρακτηριστικά					
(CZ) Technická data		a = 5,5 m/s <sup>2</sup>			
(PL) Dane techniczne					
(RUS) Технические характеристики					
(P) Parâmetros técnicos		1,8 kg	1,7 kg	1,7 kg	1,7 kg
(H) Technikai adatok					
(KOR) 기술정보					
		v = 80 m/s Ø max. 125 mm			
		•	-	-	-