

# BASIC™ 60

SINGLE UNIT GUITAR AMPLIFIER

## OPERATING GUIDE





Intended to alert the user to the presence of uninsulated “dangerous voltage” within the product’s enclosure that may be of sufficient magnitude to constitute a risk of electric shock to persons.



Intended to alert the user to the presence of important operating and maintenance (servicing) instructions in the literature accompanying the product.

**CAUTION** Risk of electrical shock — DO NOT OPEN!

**CAUTION** To reduce the risk of electric shock, do not remove cover. No user serviceable parts inside. Refer servicing to qualified service personnel.

**WARNING** To prevent electrical shock or fire hazard, do not expose this appliance to rain or moisture. Before using this appliance, read the operating guide for further warnings.



Este símbolo tiene el propósito de alertar al usuario de la presencia de “(voltaje) peligroso” que no tiene aislamiento dentro de la caja del producto que puede tener una magnitud suficiente como para constituir riesgo de corrientazo.



Este símbolo tiene el propósito de alertar al usuario de la presencia de instrucciones importantes sobre la operación y mantenimiento en la literatura que viene con el producto.

**PRECAUCION** Riesgo de corrientazo — No abra.

**PRECAUCION** Para disminuir el riesgo de corrientazo, no abra la cubierta. No hay piezas adentro que el usuario pueda reparar. Deje todo mantenimiento a los técnicos calificados.

**ADVERTENCIA** Para evitar corrientazos o peligro de incendio, no deje expuesto a la lluvia o humedad este aparato. Antes de usar este aparato, lea más advertencias en la guía de operación.



Ce symbole est utilisé pour indiquer à l'utilisateur la présence à l'intérieur de ce produit de tension non-isolée dangereuse pouvant être d'intensité suffisante pour constituer un risque de choc électrique.



Ce symbole est utilisé pour indiquer à l'utilisateur qu'il ou qu'elle trouvera d'importantes instructions sur l'utilisation et l'entretien (service) de l'appareil dans la littérature accompagnant le produit.

**ATTENTION** Risques de choc électrique — NE PAS OUVRIR!

**ATTENTION** Afin de réduire le risque de choc électrique, ne pas enlever le couvercle. Il ne se trouve à l'intérieur aucune pièce pouvant être réparée par l'utilisateur. Confier l'entretien à un personnel qualifié.

**AVERTISSEMENT** Afin de prévenir les risques de décharge électrique ou de feu, n'exposez pas cet appareil à la pluie ou à l'humidité. Avant d'utiliser cet appareil, lisez les avertissements supplémentaires situés dans le guide d'utilisation.



Dieses Symbol soll den Anwender vor unisolierten gefährlichen Spannungen innerhalb des Gehäuses warnen, die von Ausreichender Stärke sind, um einen elektrischen Schlag verursachen zu können.



Dieses Symbol soll den Benutzer auf wichtige Instruktionen in der Bedienungsanleitung aufmerksam machen, die Handhabung und Wartung des Produkts betreffen.

**VORSICHT** Risiko — Elektrischer Schlag! Nicht öffnen!

**VORSICHT** Um das Risiko eines elektrischen Schlages zu vermeiden, nicht die Abdeckung entfernen. Es befinden sich keine Teile darin, die vom Anwender repariert werden könnten. Reparaturen nur von qualifiziertem Fachpersonal durchführen lassen.

**ACHTUNG** Um einen elektrischen Schlag oder Feuergefahr zu vermeiden, sollte dieses Gerät nicht dem Regen oder Feuchtigkeit ausgesetzt werden. Vor Inbetriebnahme unbedingt die Bedienungsanleitung lesen.

# ENGLISH

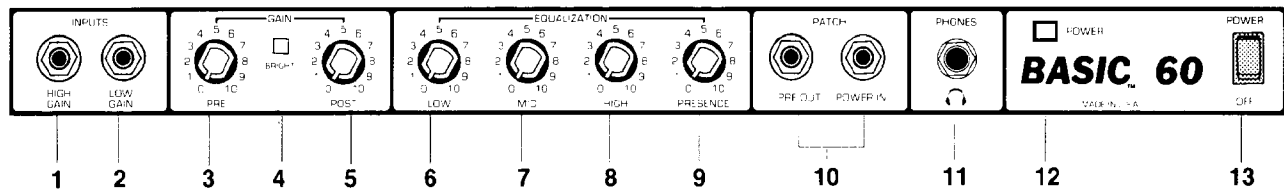

## HIGH GAIN INPUT (1)

Used for most electric basses. It is 6 dB louder than the Low Gain Input.

## LOW GAIN INPUT (2)

Provided for instruments that have extremely high outputs, which can result in overdriving (distorting) the High Gain input. If both inputs are used simultaneously, the output levels are the same (both are Low Gain).

## PRE GAIN (3)

Controls the input volume level of the amplifier.

## BRIGHT SWITCH (4)

Provides a preset boost to treble frequencies. To activate, depress the switch to its “in” position.

## POST GAIN (5)

Controls the overall volume level of the amplifier. The final level adjustment should be made after the desired sound has been achieved.

## LOW FREQUENCY EQ (6)

A passive tone control that adjusts low frequencies.

**OPERATION NOTE:** Excessive EQ boost, especially of the low frequencies, increases the possibility of speaker damage, and sacrifices valuable headroom.

## MID FREQUENCY EQ (7)

A passive tone control that adjusts mid frequencies.

## HIGH FREQUENCY EQ (8)

A passive tone control that adjusts high frequencies.

## PRESENCE (9)

A passive tone control that adjusts extreme high frequencies.

## PREAMP OUT/POWER AMP IN (10)

These jacks are provided for in-line patching of effects devices. To patch an effects unit, connect the Preamp Output to the Input of the device. Next, connect the output of the device to the Power Amp Input (high-quality shielded cables must be used for these connections). The Preamp Output can also be used to route the amplified signal to a mixing console, tape recorder, etc. Connect the Preamp Output, using a shielded cable, to an input of the tape recorder, mixer, etc. This patch does not affect the operation of the amplifier.

**NOTE:** The preamp output level is approximately 1 volt RMS and is of relatively low impedance (600 ohms). Any effects device used in this effects loop must be capable of receiving 1 volt input and providing 1 volt output in order to properly drive the power amp. The Power Amp Input has an internal switch which disconnects the internal preamp.

### HEADPHONE OUT (11)

This stereo jack allows the signal to flow to both sides of any stereo headset. When headphones are connected to the amplifier, the internal speaker is automatically turned off.

**NOTE:** The headphone system will not work with headsets equipped with a mono phone plug.

### POWER LED (12)

Illuminates when AC power is being supplied to the unit.

### POWER SWITCH (13)

Depress the switch to the "On" position. The red pilot light (LED) will illuminate indicating power is being supplied to the unit.

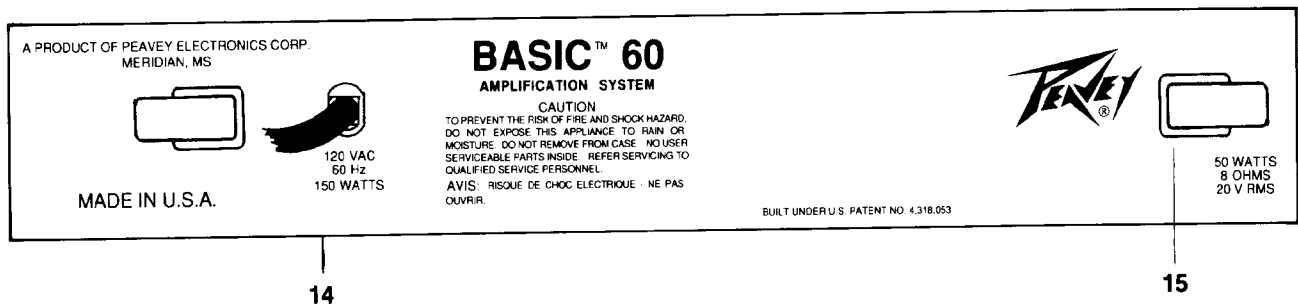

### LINE CORD (120V PRODUCTS ONLY) (14)

For your safety, we have incorporated a 3-wire line (mains) cable with proper grounding facilities. It is not advisable to remove the ground pin under any circumstances. If it is necessary to use the equipment without proper grounding facilities, suitable grounding adaptors should be used. Less noise and greatly reduced shock hazard exists when the unit is operated with the proper grounded receptacles.

### LINE (MAINS) CORD RETAINERS (15)

Allow storage of mains cable for travel.

# SPECIFICATIONS

## POWER AMPLIFIER SECTION

### Rated Power & Load:

50 W RMS into 8 ohms with DDT™ compression and LED indicator

### Power At Clipping: (typically 5% THD, 1 kHz, 120 VAC line)

57 W RMS into 8 ohms

### Frequency Response:

+0, -2 dB, 60 Hz to 10 kHz at 50 W RMS into 8 ohms

### Total Harmonic Distortion:

Less than 0.2%, 100 mW to 50 W RMS, 60 Hz to 10 kHz, 8 ohms; typically below 0.1%

### DDT™ Dynamic Range:

Greater than 16 dB

### DDT™ Maximum THD:

Below 0.5% THD for 6 dB overload  
Below 1% THD for 16 dB overload

### Hum & Noise:

Greater than 90 dB below rated power

### Power Consumption: (Domestic)

150W, 50/60 Hz, 120 VAC

### Preamp Section:

The following specs are measured @ 1 kHz with the controls preset as follows: Push Bright Off (Out); Post Gain @ 10; Low EQ @ 10; Mid EQ @ 0; High EQ @ 10; Presence EQ @ 5; Nominal Levels are set with Pre Gain @ 5; Minimum Levels are set with Pre Gain @ 10.

### Preamp High Gain Input:

Impedance: High Z, 220 K ohms  
Nominal Input Level: -24 dBV, 60 mV RMS  
Minimum Input Level: -46 dBV, 5 mV RMS  
Maximum Input Level: +6 dBV, 2V RMS

### Preamp Low Gain Input:

Impedance: High Z, 44 K ohms  
Nominal Input Level: -18 dBV, 120 mV RMS  
Minimum Input Level: -40 dBV, 10 mV RMS  
Maximum Input Level: +12 dBV, 4 V RMS

### Preamp Output:

Load Impedance: 10 K ohms or greater  
Nominal Output: 0 dBV, 1 V RMS

### Power Amp Input:

Impedance: High Z, 22 K ohms  
Designed Input Level: 0 dBV, 1 V RMS

### System Hum & Noise At Nominal Input Level: (20 Hz to 20 kHz, unweighted)

74 dB below rated power

### Equalization:

Low, Mid, High, & Presence  
Passive Type EQ  
Bright: +6 dB at 2 kHz

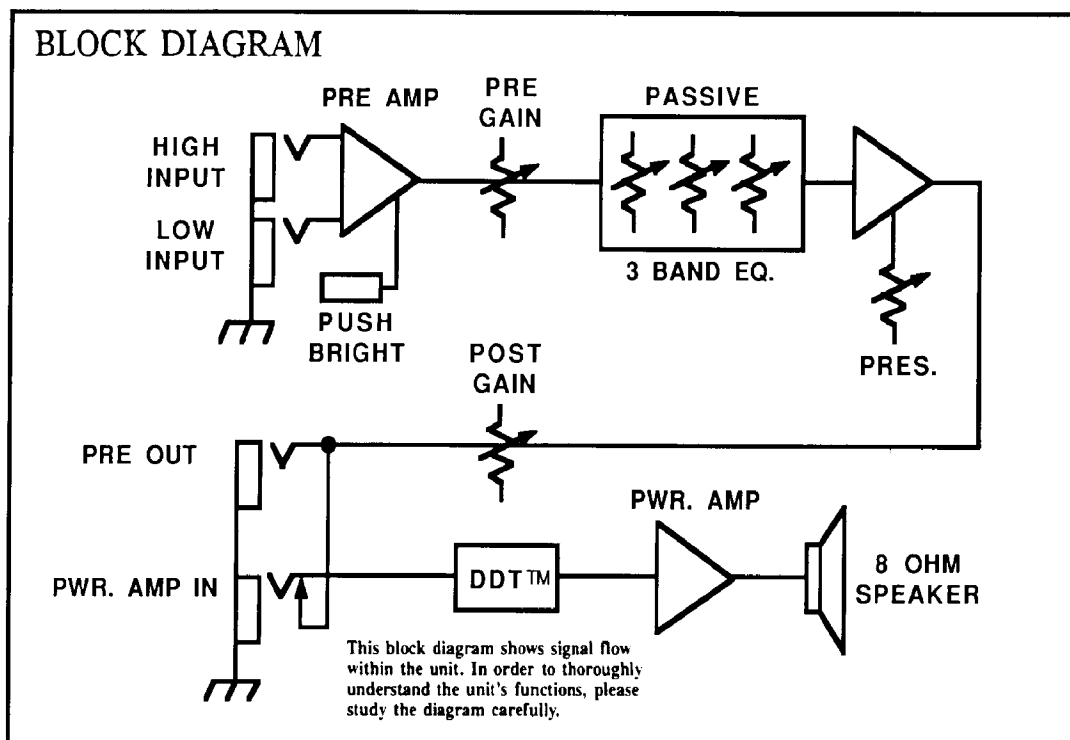

## Consulte los diagramas del panel delantero en la sección de inglés de este manual.

### **HIGH GAIN INPUT (Entrada de alta ganancia) (1)**

Se usa para la mayoría de los bajos eléctricos. Tiene 6 dB más volumen que la entrada de baja ganancia.

### **LOW GAIN INPUT (Entrada de baja ganancia) (2)**

Se suministra para instrumentos que tienen una salida extremadamente alta, la cual puede causar la sobrecarga (distorsión) de la entrada de alta ganancia. Si se usan ambas entradas simultáneamente, el nivel de salida es el mismo (ambos son de baja ganancia).

### **PRE GAIN (Control del preamplificador) (3)**

Controla el nivel de volumen a la entrada del amplificador.

### **BRIGHT SWITCH (Interruptor de brillo) (4)**

Proporciona un impulso preajustado a las frecuencias agudas. Para activarlo, empuje el interruptor a la posición "in" (hacia dentro).

### **POST GAIN (Control de ganancia posterior al preamplificador) (5)**

Controla el nivel global de volumen del amplificador. El ajuste final de nivel debe hacerse una vez que se haya conseguido el sonido deseado.

### **LOW FREQUENCY EQ (Ecuador de frecuencias graves) (6)**

Es un control pasivo de tono que ajusta las frecuencias graves.

**NOTA:** El exceso de ecualización, especialmente en las frecuencias graves, aumenta la posibilidad de dañar los altavoces y también desperdicia valiosa gama dinámica.

### **MID EQ (Ecuador de frecuencias medias) (7)**

Un control pasivo de tono que ajusta las frecuencias medias.

### **HIGH EQ (Ecuador de frecuencias agudas) (8)**

Es un control pasivo de tono, que ajusta las frecuencias agudas.

### **PRESENCE (Presencia) (9)**

Un control pasivo de tono que ajusta las frecuencias muy agudas.

### **PREAMP OUT/POWER AMP IN**

#### **(Salida del preamplificador/Entrada del amplificador de potencia) (10)**

Se suministran estos enchufes hembras para conectar aparatos de efectos en línea. Para conectar un aparato de efectos, conecte la salida del preamplificador a la entrada del aparato, después conecte la salida del aparato a la entrada del amplificador de potencia. (Para este tipo de conexión debe usar cables blindados de buena calidad.) La salida del preamplificador también se puede usar para mandar la señal a nivel de línea a una consola de mezcla, grabadora, etc. Esta conexión no afecta la función del amplificador.

**NOTA:** El nivel de salida del preamplificador es aproximadamente 1 voltio "RMS" y es de relativamente baja impedancia (600 ohms). Cualquier aparato de efectos que se use en este lazo de efectos debe ser capaz de recibir 1 voltio de entrada y proveer 1 voltio de salida para impulsar correctamente el amplificador de potencia. La entrada del amplificador de potencia tiene un interruptor interno que desconecta el preamplificador interno.

### HEADPHONE OUT (Salida para audífonos) (11)

Esta salida es un enchufe hembra estereofónico que permite usar audífonos comunes—escuchando la señal en ambos lados. Cuando se conectan los audífonos al amplificador, los altavoces internos son automáticamente desconectados.

**NOTA:** El sistema de audífonos no funcionará con audífonos equipados con una clavija monofónica.

### POWER LED (LED indicador de corriente) (12)

Se ilumina cuando el equipo recibe la corriente alterna.

### POWER SWITCH (Interruptor de corriente) (13)

Oprima el interruptor a la posición “hacia dentro” (encendido). La luz roja del piloto (indicador) se encenderá indicando que la unidad está recibiendo corriente alterna.

A PRODUCT OF PEAVEY ELECTRONICS CORP.  
MERIDIAN, MS



220/240 V<sub>r</sub>  
50/60 Hz  
150 WATT'S

MADE IN U.S.A.

## BASIC™ 60

AMPLIFICATION SYSTEM

**WARNING**  
TO PREVENT THE RISK OF FIRE AND SHOCK HAZARD,  
DO NOT EXPOSE THIS APPLIANCE TO RAIN OR  
MOISTURE. DO NOT REMOVE FROM CASE. NO USER  
SERVICEABLE PARTS INSIDE. REFER SERVICING TO  
QUALIFIED SERVICE PERSONNEL.  
AVIS: RISQUE DE CHOC ELECTRIQUE - NE PAS  
OUVRIR.

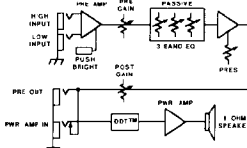

**PEAVEY**



50 WATT'S  
8 OHMS  
20 V RMS

BUILT UNDER U.S. PATENT NO. 4,318,053

### LINE CORD (120 V PRODUCTS ONLY)

#### (Cable de corriente para 120 v solamente) (14)

Para su protección hemos incorporado un cable de 3 polos con polo a tierra. No es recomendable remover la pata del polo a tierra bajo ninguna circunstancia, se recomienda un adaptador en caso necesario. Esto reducirá ruidos y peligrosos corrientazos.

### LINE (MAINS) CORD RETAINERS. (Guardacable para cables principales) (15)

Permite almacenar los cables principales para traslado.

# FRANCAIS

**Veillez vous référer au “front panel line art”  
situé dans la section en langue anglaise de ce manuel.**

## **HIGH GAIN INPUT (Entrée haut gain) (1)**

À utiliser avec la plupart des basses électriques. Elle donne un volume plus élevé de 6 dB que l'entrée “Low Gain”.

## **LOW GAIN INPUT (Entrée faible Gain) (2)**

Cette prise accepte les instruments à très haut niveau de sortie qui causeraient de la saturation (distorsion) sur l'entrée “High Gain”. Si les deux entrées sont utilisées simultanément, les niveaux sont alors équivalents (“Low Gain”).

## **PRE GAIN (3)**

Contrôle le niveau de volume à l'entrée de l'amplificateur.

## **BRIGHT SWITCH (Sélecteur de brillance) (4)**

Produit un renforcement des fréquences aiguës. Pour activer, enclenchez le bouton à la position “In”.

## **POST GAIN (5)**

Commande le volume global de l'amplificateur. Le réglage final de niveau doit être effectué après avoir obtenu la sonorité désirée à l'aide des autres réglages.

## **LOW FREQUENCY EQ (Égalisation fréquences graves) (6)**

Réglage de tonalité passif ajustant les fréquences graves.

**NOTE:** Une accentuation excessive par égalisation (“EQ”), surtout dans les fréquences graves, augmente les risques de dommages aux haut-parleurs et diminue la réserve de puissance disponible.

## **MID FREQUENCY EQ (Égalisation fréquences moyennes) (7)**

Réglage de tonalité passif servant à ajuster les fréquences moyennes.

## **HIGH FREQUENCY EQ (Égalisation des fréquences aiguës) (8)**

Réglage de tonalité passif ajustant les fréquences aiguës.

## **PRESENCE (Présence) (9)**

Réglage de tonalité passif ajustant les fréquences très aiguës.

## **PREAMP OUT / POWER AMP IN (Sortie préampli/entrée ampli) (10)**

Ces prises jack de boucle d'effets permettent l'insertion d'un appareil d'effets. Pour relier un appareil d'effets, branchez la sortie du préampli (“Preamp Output”) à l'entrée de l'appareil. Branchez ensuite la sortie de l'appareil à l'entrée de l'ampli de puissance (“Power Amp Input”). Des câbles blindés de haute qualité doivent être utilisés pour ces connexions. La sortie “Preamp Output” peut aussi être utilisée pour amener le signal amplifié à une table de mixage, un magnétophone, ou autres. Branchez la sortie du préampli à l'entrée du magnétophone, mélangeur, etc, à l'aide de câbles blindés. Ce branchement n'affecte pas le fonctionnement de l'amplificateur.

**NOTE:** Le niveau de sortie du préampli est d'environ 1 volt sous impédance relativement basse (600 ohms). Les appareils d'effets insérés dans cette “boucle” doivent être capables de recevoir ce niveau d'entrée de 1 volt ainsi que de délivrer une sortie de 1 volt de façon à bien alimenter l'ampli de puissance. L'ampli de puissance possède un interrupteur interne qui débranche le préampli interne.



### HEADPHONE OUT (Sortie pour casque d'écoute) (11)

Cette prise jack stéréo accepte n'importe quel casque d'écoute stéréo et y envoie le signal sur les deux cotés. Lorsqu'un casque est branché à l'amplificateur, le haut-parleur interne est automatiquement mis hors-circuit.

**NOTE:** Le système de casque d'écoute ne fonctionne pas avec un casque équipé d'une fiche phono monophonique.

### Power LED (DEL témoin d'alimentation) (12)

S'allume quand l'unité reçoit l'alimentation CA.

### POWER SWITCH (Interrupteur d'alimentation) (13)

Mettre l'interrupteur en position "On". La lampe témoin rouge (DEL) s'illumine indiquant que l'appareil est alimenté en courant.

A PRODUCT OF PEAVEY ELECTRONICS CORP MERIDIAN, MS	<b>BASIC™ 60</b> AMPLIFICATION SYSTEM			
MADE IN U.S.A.	<p><b>WARNING</b> TO PREVENT THE RISK OF FIRE AND SHOCK HAZARD DO NOT EXPOSE THIS APPLIANCE TO RAIN OR MOISTURE. DO NOT REMOVE FROM CASE. NO USER SERVICEABLE PARTS INSIDE. REFER SERVICE TO QUALIFIED SERVICE PERSONNEL. AVIS: RISQUE DE CHOC ELECTRIQUE. NE PAS OUVRIR.</p>	BUILT UNDER U.S. PATENT NO. 4,318,053	50 WATTS 8 OHMS 20 V RMS	

### LINE CORD (120V products only)

#### (Cordon d'alimentation pour appareils 120V seulement) (14)

Pour votre sécurité, nous avons incorporé un câble d'alimentation secteur à 3 fils avec mise-à-terre appropriée. Il n'est pas recommandé d'enlever la broche de mise-à-terre en aucune circonstance. S'il est nécessaire d'utiliser l'équipement sans mise-à-terre appropriée, utilisez des adaptateurs de mise-à-terre convenables. Une bonne mise-à-terre amoindrit le bruit de fond et réduit grandement les risques de choc.

### LINE (MAINS) CORD RETAINERS (Enrouleurs de câbles d'alimentation) (15)

Permet de remiser les câbles d'alimentation pour le transport.

**Siehe diagramm der frontplatte im englischen teil des handbuchs.**

## **HIGH GAIN INPUT (High Gain-Eingang) (1)**

Wird für die meisten elektrischen Bässe verwendet; ist 6 dB lauter als der Low Gain-Eingang.

## **LOW GAIN INPUT (2)**

Dieser Eingang ist für die Instrumente vorgesehen, die ein besonders hohes Ausgangssignal erzeugen. Falls beide Eingänge gleichzeitig benutzt werden, sind die Ausgangssignale gleich (beide sind dann Low Gain).

## **PRE GAIN (3)**

Regelt die Eingangsempfindlichkeit des Verstärkers.

## **BRIGHT SWITCH (Bright-Schalter) (4)**

Hebt die hohen Frequenzen um einen voreingestellten Wert an. Wenn sich der Schalter in der eingedrückten "In"-Position befindet, ist Bright aktiviert.

## **POST GAIN (5)**

Kontrolliert die Gesamtlautstärke des Verstärkers. Die endgültige Lautstärke sollte erst eingestellt werden, wenn der gewünschte Sound erreicht ist.

## **LOW FREQUENCY EQ (6)**

Eine passive Klangreglung, welche die tiefen Frequenzen regelt.

**MERKE:** Eine extreme Anhebung der Klangreglung insbesondere in den tiefen Frequenzen vergrößert die Gefahr von Lautsprecherschäden und beschneidet den verfügbaren Dynamikbereich (Headroom).

## **MID EQ (Mid EQ) (7)**

Eine passive Klangregelung für die mittleren Frequenzen.

## **HIGH FREQUENCY EQ (8)**

Eine passive Tonregelung für die hohen Frequenzen.

## **PRESENCE (9)**

Eine passive Tonkontrolle, welche die extrem hohen Frequenzen einstellt.

## **PREAMP OUT/POWER AMP IN (10)**

Diese Buchsen sind vorgesehen für das direkte Einschleifen von Effektgeräten. Um ein Effektgerät anzuschließen, verbinden Sie den Preamp-Output mit dem Eingang des Effektgerätes. Als nächstes verbinden Sie den Ausgang des Effekts mit dem Power Amp-Input (für diese Anschlüsse müssen abgeschirmte Kabel verwendet werden). Der Preamp Output kann auch dazu benutzt werden, ein verstärktes Signal direkt in einen Mixer oder eine Bandmaschine zu leiten. Verbinden Sie den Preamp Output über ein abgeschirmtes Kabel mit dem Eingang des Mixers oder der Bandmaschine. Diese Verbindung hat keinen Einfluß auf die Funktion des Verstärkers. Anmerkung: Der Pre-amp Output Vorverstärker Ausgangspegel beträgt c. 1 Volt RMS bei 600 Ohm. Jedes Effektgerät, das hier eingeschleift werden soll, muß ein Eingangs- und Ausgangssignal von 1 Volt haben, um den Poweramp richtig anzusteuern. Der Poweramp-Eingang hat einen internen Schalter, der den internen Preamp trennt.

## **HEADPHONE OUT (11)**

Diese Stereobuchse leitet das Signal an beide Seiten eines jeden handelsüblichen Stereokopfhörers. Wenn ein Kopfhörer an den Verstärker angeschlossen wird, schaltet sich der Lautsprecher automatisch ab.

**MERKE:** Die Kopfhörerbuchse funktioniert nicht mit Kopfhörern, die mit einer Mono-Klinkenbuchse ausgestattet sind.

## POWER LED (12)

Ist erleuchtet, wenn das Gerät eingeschaltet ist und mit Strom versorgt wird.

## POWER SWITCH (Netzschalter) (13)

Bringen Sie den Schalter auf die ON-Position. Die rote Kontrolllampe (LED) leuchtet und zeigt an, daß das Gerät eingeschaltet ist.

A PRODUCT OF PEAVEY ELECTRONICS CORP.  
MERIDIAN, MS



220/240 V $\sqrt{v}$   
50/60 Hz  
150 WATTS

MADE IN U.S.A.



### BASIC™ 60

AMPLIFICATION SYSTEM

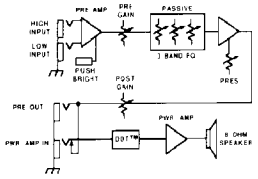
**WARNING**  
TO PREVENT THE RISK OF FIRE AND SHOCK HAZARD,  
DO NOT EXPOSE THIS APPLIANCE TO RAIN OR  
MOISTURE. DO NOT REMOVE FROM CASE. NO USER  
SERVICEABLE PARTS INSIDE. REFER SERVICING TO  
QUALIFIED SERVICE PERSONNEL.  
AVIS: RISQUE DE CHOC ELECTRIQUE NE PAS  
OUVRIR.



BUILT UNDER U.S. PATENT NO. 4,318,053



50 WATTS  
8 OHMS  
20 V RMS

## LINE CORD (120V products only) (Nur bei 120 Volt-Geräten) (14)

Zu Ihrer Sicherheit haben wir das Gerät mit einem dreiadrigen geerdeten Netzkabel versehen. Es ist unter keinen Umständen empfehlenswert den Erdungskontakt des Anschlußkabels zu lösen. Falls es notwendig sein sollte, das Equipment ohne die vorgesehene Erdung zu betreiben empfiehlt sich die Verwendung eines Grounding Adaptors. Die geringsten Störgeräusche und die höchste Sicherheit vor elektrischen Schlägen wird jedoch durch die Benutzung der vorgesehenen Erdungsmöglichkeiten erreicht.

## LINE (MAINS) CORD RETAINERS (15)

Befestigungsmöglichkeit für das Netzkabel.

**THIS LIMITED WARRANTY VALID ONLY WHEN PURCHASED AND REGISTERED IN THE UNITED STATES OR CANADA. ALL EXPORTED PRODUCTS ARE SUBJECT TO WARRANTY AND SERVICES TO BE SPECIFIED AND PROVIDED BY THE AUTHORIZED DISTRIBUTOR FOR EACH COUNTRY.**

**Ces clauses de garantie ne sont valables qu'aux Etats-Unis et au Canada. Dans tous les autres pays, les clauses de garantie et de maintenance sont fixées par le distributeur national et assurées par lui selon la législation en vigueur.**

**Diese Garantie ist nur in den USA und Kanada gültig. Alle Export-Produkte sind der Garantie und dem Service des Importeurs des jeweiligen Landes unterworfen. Esta garantía es válida solamente cuando el producto es comprado en E.U. continentales o en Canada. Todos los productos que sean comprados en el extranjero, están sujetos a las garantías y servicio que cada distribuidor autorizado determine y ofrezca en los diferentes países.**

**PEAVEY ONE-YEAR LIMITED  
WARRANTY/REMEDY**

PEAVEY ELECTRONICS CORPORATION ("PEAVEY") warrants this product, EXCEPT for covers, footswitches, patchcords, tubes and meters, to be free from defects in material and workmanship for a period of one (1) year from date of purchase, PROVIDED, however, that this limited warranty is extended only to the original retail purchaser and is subject to the conditions, exclusions, and limitations hereinafter set forth:

**PEAVEY 90-DAY LIMITED WARRANTY ON TUBES AND METERS**

If this product contains tubes or meters, Peavey warrants the tubes or meters contained in the product to be free from defects in material and workmanship for a period of ninety (90) days from date of purchase; PROVIDED, however, that this limited warranty is extended only to the original retail purchaser and is also subject to the conditions, exclusions, and limitations hereinafter set forth.

**CONDITIONS, EXCLUSIONS, AND LIMITATIONS OF LIMITED WARRANTIES**

These limited warranties shall be void and of no effect, if:

- a. The first purchase of the product is for the purpose of resale; or
- b. The original retail purchase is not made from an AUTHORIZED PEAVEY DEALER; or
- c. The product has been damaged by accident or unreasonable use, neglect, improper service or maintenance, or other causes not arising out of defects in material or workmanship; or
- d. The serial number affixed to the product is altered, defaced, or removed

In the event of a defect in material and/or workmanship covered by this limited warranty, Peavey will:

- a. In the case of tubes or meters, replace the defective component without charge.
- b. In other covered cases (i.e., cases involving anything other than covers, footswitches, patchcords, tubes or meters), repair the defect in material or workmanship or replace the product, at Peavey's option; and provided, however, that, in any case, all costs of shipping, if necessary, are paid by you, the purchaser.

THE WARRANTY REGISTRATION CARD SHOULD BE ACCURATELY COMPLETED AND MAILED TO AND RECEIVED BY PEAVEY WITHIN FOURTEEN (14) DAYS FROM THE DATE OF YOUR PURCHASE.

In order to obtain service under these warranties, you must:

- a. Bring the defective item to any PEAVEY AUTHORIZED DEALER or AUTHORIZED PEAVEY SERVICE CENTER and present therewith the ORIGINAL PROOF OF PURCHASE supplied to you by the AUTHORIZED PEAVEY DEALER in connection with your purchase from him of this product. If the DEALER or SERVICE CENTER is unable to provide the necessary warranty service you will be directed to the nearest other PEAVEY AUTHORIZED DEALER or AUTHORIZED PEAVEY SERVICE CENTER which can provide such service.

**OR**

- b. Ship the defective item, prepaid, to:

PEAVEY ELECTRONICS CORPORATION  
International Service Center  
326 Hwy. 11 & 80 East  
MERIDIAN, MS 39301

including therewith a complete, detailed description of the problem, together with a legible copy of the original PROOF OF PURCHASE and a complete return address. Upon Peavey's receipt of these items:

If the defect is remedial under these limited warranties and the other terms and conditions expressed herein have been complied with, Peavey will provide the necessary warranty service to repair or replace the product and will return it, FREIGHT COLLECT, to you, the purchaser.

Peavey's liability to the purchaser for damages from any cause whatsoever and regardless of the form of action, including negligence, is limited to the actual damages up to the greater of \$500.00 or an amount equal to the purchase price of the product that caused the damage or that is the subject of or is directly related to the cause of action. Such purchase price will be that in effect for the specific product when the cause of action arose. This limitation of liability will not apply to claims for personal injury or damage to real property or tangible personal property allegedly caused by Peavey's negligence. Peavey does not assume liability for personal injury or property damage arising out of or caused by a non-Peavey alteration or attachment, nor does Peavey assume any responsibility for damage to interconnected non-Peavey equipment that may result from the normal functioning and maintenance of the Peavey equipment.

UNDER NO CIRCUMSTANCES WILL PEAVEY BE LIABLE FOR ANY LOST PROFITS, LOST SAVINGS, ANY INCIDENTAL DAMAGES, OR ANY CONSEQUENTIAL DAMAGES ARISING OUT OF THE USE OR INABILITY TO USE THE PRODUCT, EVEN IF PEAVEY HAS BEEN ADVISED OF THE POSSIBILITY OF SUCH DAMAGES.

THESE LIMITED WARRANTIES ARE IN LIEU OF ANY AND ALL WARRANTIES, EXPRESSED OR IMPLIED, INCLUDING, BUT NOT LIMITED TO, THE IMPLIED WARRANTIES OF MERCHANTABILITY AND FITNESS FOR A PARTICULAR USE; PROVIDED, HOWEVER, THAT IF THE OTHER TERMS AND CONDITIONS NECESSARY TO THE EXISTENCE OF THE EXPRESSED, LIMITED WARRANTIES, AS HEREINABOVE STATED, HAVE BEEN COMPLIED WITH, IMPLIED WARRANTIES ARE NOT DISCLAIMED DURING THE APPLICABLE ONE-YEAR OR NINETY-DAY PERIOD FROM DATE OF PURCHASE OF THIS PRODUCT.

SOME STATES DO NOT ALLOW LIMITATION ON HOW LONG AN IMPLIED WARRANTY LASTS, OR THE EXCLUSION OR LIMITATION OF INCIDENTAL OR CONSEQUENTIAL DAMAGES, SO THE ABOVE LIMITATIONS OR EXCLUSIONS MAY NOT APPLY TO YOU. THESE LIMITED WARRANTIES GIVE YOU SPECIFIC LEGAL RIGHTS, AND YOU MAY ALSO HAVE OTHER RIGHTS WHICH MAY VARY FROM STATE TO STATE.

THESE LIMITED WARRANTIES ARE THE ONLY EXPRESSED WARRANTIES ON THIS PRODUCT, AND NO OTHER STATEMENT, REPRESENTATION, WARRANTY, OR AGREEMENT BY ANY PERSON SHALL BE VALID OR BINDING UPON PEAVEY.

In the event of any modification or disclaimer of expressed or implied warranties, or any limitation of remedies, contained herein conflicts with applicable law, then such modification, disclaimer or limitation, as the case may be, shall be deemed to be modified to the extent necessary to comply with such law.

Your remedies for breach of these warranties are limited to those remedies provided herein and Peavey Electronics Corporation gives this limited warranty only with respect to equipment purchased in the United States of America.

**INSTRUCTIONS — WARRANTY REGISTRATION CARD**

1. Mail the completed WARRANTY REGISTRATION CARD to:

PEAVEY ELECTRONICS CORPORATION  
POST OFFICE BOX 2898  
MERIDIAN, MISSISSIPPI 39302-2898

- a. Keep the PROOF OF PURCHASE. In the event warranty service is required during the warranty period, you will need this document. There will be no identification card issued by Peavey Electronics Corporation.
2. IMPORTANCE OF WARRANTY REGISTRATION CARDS AND NOTIFICATION OF CHANGES OF ADDRESSES:
  - a. Completion and mailing of WARRANTY REGISTRATION CARDS — Should notification become necessary for any condition that may require correction, the REGISTRATION CARD will help ensure that you are contacted and properly notified.
  - b. Notice of address changes — If you move from the address shown on the WARRANTY REGISTRATION CARD, you should notify Peavey of the change of address so as to facilitate your receipt of any bulletins or other forms of notification which may become necessary in connection with any condition that may require dissemination of information or correction.
3. You may contact Peavey directly by telephoning (601) 483-5365.

## IMPORTANT SAFETY INSTRUCTIONS

**WARNING:** When using electric products, basic cautions should always be followed, including the following.

1. Read all safety and operating instructions before using this product.
2. All safety and operating instructions should be retained for future reference.
3. Obey all cautions in the operating instructions and on the back of the unit.
4. All operating instructions should be followed.
5. This product should not be used near water, i.e., a bathtub, sink, swimming pool, wet basement, etc.
6. This product should be located so that its position does not interfere with its proper ventilation. It should not be placed flat against a wall or placed in a built-in enclosure that will impede the flow of cooling air.
7. This product should not be placed near a source of heat such as a stove, radiator, or another heat producing amplifier.
8. Connect only to a power supply of the type marked on the unit adjacent to the power supply cord.
9. Never break off the ground pin on the power supply cord. For more information on grounding, write for our free booklet "Shock Hazard and Grounding."
10. Power supply cords should always be handled carefully. Never walk or place equipment on power supply cords. Periodically check cords for cuts or signs of stress, especially at the plug and the point where the cord exits the unit.
11. The power supply cord should be unplugged when the unit is to be unused for long periods of time.
12. If this product is to be mounted in an equipment rack, rear support should be provided.
13. Metal parts can be cleaned with a damp rag. The vinyl covering used on some units can be cleaned with a damp rag or an ammonia-based household cleaner if necessary. Disconnect unit from power supply before cleaning.
14. Care should be taken so that objects do not fall and liquids are not spilled into the unit through the ventilation holes or any other openings.
15. This unit should be checked by a qualified service technician if:
  - a. The power supply cord or plug has been damaged.
  - b. Anything has fallen or been spilled into the unit.
  - c. The unit does not operate correctly.
  - d. The unit has been dropped or the enclosure damaged.
16. The user should not attempt to service this equipment. All service work should be done by a qualified service technician.
17. This product should be used only with a cart or stand that is recommended by Peavey Electronics.
18. Exposure to extremely high noise levels may cause a permanent hearing loss. Individuals vary considerably in susceptibility to noise induced hearing loss, but nearly everyone will lose some hearing if exposed to sufficiently intense noise for a sufficient time. The U.S. Government's Occupational Safety and Health Administration (OSHA) has specified the following permissible noise level exposures.

Duration Per Day In Hours	Sound Level dBA, Slow Response
8	90
6	92
4	95
3	97
2	100
1 1/2	102
1	105
1/2	110
1/4 or less	115

According to OSHA, any exposure in excess of the above permissible limits could result in some hearing loss. Ear plugs or protectors in the ear canals or over the ears must be worn when operating this amplification system in order to prevent a permanent hearing loss if exposure is in excess of the limits as set forth above. To ensure against potentially dangerous exposure to high sound pressure levels, it is recommended that all persons exposed to equipment capable of producing high sound pressure levels such as this amplification system be protected by hearing protectors while this unit is in operation.

**SAVE THESE INSTRUCTIONS!**



Features and specifications subject to change without notice.

**Peavey Electronics Corporation** 711 A Street / Meridian, MS 39301 / U.S.A. / (601) 483-5365 / Telex 504115 / Fax 486-1278  
©1994 #80300781 Printed in U.S.A. 11/94