

# **marantz®**

**Model SR7200 User Guide**

---

AV Surround Receiver

## ENGLISH

### WARRANTY

For warranty information, contact your local Marantz distributor.

#### RETAIN YOUR PURCHASE RECEIPT

Your purchase receipt is your permanent record of a valuable purchase. It should be kept in a safe place to be referred to as necessary for insurance purposes or when corresponding with Marantz.

#### IMPORTANT

When seeking warranty service, it is the responsibility of the consumer to establish proof and date of purchase. Your purchase receipt or invoice is adequate for such proof.

#### FOR U.K. ONLY

This undertaking is in addition to a consumer's statutory rights and does not affect those rights in any way.

## FRANÇAIS

### GARANTIE

Pour des informations sur la garantie, contacter le distributeur local Marantz.

#### CONSERVER L'ATTESTATION D'ACHAT

L'attestation d'achat est la preuve permanente d'un achat de valeur. La conserver en lieu sûr pour s'y reporter aux fins d'obtention d'une couverture d'assurance ou dans le cadre de correspondances avec Marantz.

#### IMPORTANT

Pour l'obtention d'un service couvert par la garantie, il incombe au client d'établir la preuve de l'achat et d'en corroborer la date. Le reçu ou la facture constituent des preuves suffisantes.

## DEUTSCH

### GARANTIE

Bei Garantiefragen wenden Sie sich bitte an Ihren Marantz-Händler.

#### HEBEN SIE IHRE QUITTING GUT AUF

Die Quittung dient Ihnen als bleibende Unterlage für Ihren wertvollen Einkauf. Das Aufbewahren der Quittung ist wichtig, da die darin enthaltenen Angaben für Versicherungswecke oder bei Korrespondenz mit Marantz angeführt werden müssen.

#### WICHTIG!

Bei Garantiefragen muß der Kunde eine Kaufunterlage mit Kaufdatum vorlegen. Ihren Quittung oder Rechnung ist als Unterlage ausreichend.

## NEDERLANDS

### GARANTIE

Voor inlichtingen omtrent garantie dient u zich tot uw plaatselijke Marantz.

#### UW KWITANTIE, KASSABON E.D. BEWAREN

Uw kwitantie, kassabon e.d. vormen uw bewijs van aankoop van een waardevol artikel en dienen op een veilige plaats bewaard te worden voor evt. verwijzing bijv. in verbend met verzekering of bij correspondentie met Marantz.

#### BELANGRIJK

Bij een evt. beroep op de garantie is het de verantwoordelijkheid van de consument een gedateerd bewijs van aankoop te tonen. Uw kassabon of factuur zijn voldoende bewijs.

## ESPAÑOL

### GARANTIA

Para obtener información acerca de la garantía póngase en contacto con su distribuidor Marantz.

#### GUARDE SU RECIBO DE COMPRA

Su recibo de compra es su prueba permanente de haber adquirido un aparato de valor. Este recibo deberá guardarlo en un lugar seguro y utilizarlo como referencia cuando tenga que hacer uso del seguro o se ponga en contacto con Marantz.

#### IMPORTANTE

Cuando solicite el servicio otorgado por la garantía el usuario tiene la responsabilidad de demostrar cuándo efectuó la compra. En este caso, su recibo de compra será la prueba apropiada.

## ITALIANO

### GARANZIA

L'apparecchio è coperto da una garanzia di buon funzionamento della durata di un anno, o del periodo previsto dalla legge, a partire dalla data di acquisto comprovata da un documento attestante il nominativo del Rivenditore e la data di vendita. La garanzia sarà prestata con la sostituzione o la riparazione gratuita delle parti difettose.

Non sono coperti da garanzia difetti derivanti da uso improprio, errata installazione, manutenzione effettuata da personale non autorizzato o, comunque, da circostanze che non possano riferirsi a difetti di funzionamento dell'apparecchio. Sono inoltre esclusi dalla garanzia gli interventi inerenti l'installazione e l'allacciamento agli impianti di alimentazione.

Gli apparecchi verranno riparati presso i nostri Centri di Assistenza Autorizzati. Le spese ed i rischi di trasporto sono a carico del cliente.

La casa costruttrice declina ogni responsabilità per danni diretti o indiretti provocati dalla inosservanza delle prescrizioni di installazione, uso e manutenzione dettagliate nel presente manuale o per guasti dovuti ad uso continuato a fini professionali.

## PORTUGUÊS

### GARANTIA

Para informações sobre a garantia, contactar o distribuidor Marantz local.

#### GUARDAR O RECIBO DE COMPRA

O recibo é o registo permanente da compra que fez. Deve ser guardado num local seguro, para ser apresentado em questões relacionadas com o seguro ou para quando tiver de contactar a Marantz.

#### IMPORTANTE

Quando procurar assistência técnica ao abrigo da garantia, é da responsabilidade do consumidor estabelecer a prova e data de compra.

O recibo é prova adequada.

## SVENSKA

### GARANTI

För information om garantin, kontakta Marantz lokalgagent.

#### SPAR KVITTOT

Kvittot är ett inköpsbevis på en värdefull vara. Det skall förvaras säkert och hänvisas till vid försäkringsfall eller vidkorrespondens mod Marantz.

#### VIKTIGT

Fö att garantin skall gälla är det kundens sak att framställa bevis och datum om köpet. Kvitto eller faktura är tillräckligt bevis för detta.

## DANSK

### GARANTI

Henvend dem til Deres MARANTZ-forhandler angående information om garantien.

#### GEM DERES KVITTERING

Deres købskvittering er Deres varige bevis på et dyrt køb. Den bør gemmes godt og anvendes som bevis, hvis De vil tegne en forsikring, eller hvis De kommunikerer med Marantz.

#### VIGTIGT

Det påhviler forbrugeren at skaffe bevis for købet og købsdatoen, hvis han eller hun ønsker garantiservice. Deres købskvittering eller faktura er et fuldgældigt bevis herpå.

# CE MARKING

- English**  
The SR7200 is in conformity with the EMC directive and low-voltage directive.
- Français**  
Le SR7200 est conforme à la directive EMC et à la directive sur les basses tensions.
- Deutsch**  
Das Modell SR7200 entspricht den EMC-Richtlinien und den Richtlinien für Niederspannungsgeräte.
- Nederlands**  
De SR7200 voldoet aan de EMC eisen en de vereisten voor laag-voltage.
- Español**  
El SR7200 está de acuerdo con las normas EMC y las relacionadas con baja tensión.
- Italiano**  
Il SR7200 è conforme alle direttive CEE ed a quelle per i bassi voltaggi.
- Português**  
O SR7200 conforma com as diretrizes EMC e de baixa voltagem.
- Svenska**  
SR7200 är tillverkad i enlighet med EMC direktiven och direktiven för lågvoltsutrusning.
- Dansk**  
Model SR7200 er i overensstemmelse med EMC-direktivet og direktivet om lavspænding.

## English

To ventilate the unit, do not install the unit in a rack or bookshelf, and note the followings.

- Do not touch the top of the enclosure during operation.
- Do not block the openings in the enclosure during operation.
- Do not insert objects beneath the unit.
- Do not block the ventilation slots at the top of the unit.
- Do not place anything about 1 meter above the top panel.
- Make a space of about 0.2 meter around the unit.

## Français

Pour que l'appareil puisse être correctement ventilé, ne pas l'installer dans un meuble ou une bibliothèque et respecter ce qui suit.

- Ne pas toucher le dessus du coffret.
- Ne pas obstruer les ouïes de ventilation du coffret pendant le fonctionnement.
- Ne placer aucun objet sous l'appareil.
- Ne pas obstruer les ouïes de ventilation du panneau supérieur. Ne placer aucun objet à moins d'un mètre environ du panneau supérieur.
- Veiller à ce qu'aucun objet ne soit à moins de 0,2 mètre des côtés de l'appareil.

## Deutsch

Um eine einwandfreie Belüftung des Geräts zu gewährleisten, darf das Gerät nicht in einem Gestell oder Bücherregal aufgestellt werden; die folgenden Punkte sind besonders zu beachten:

- Während des Betriebs das Oberteil des Gehäuses nicht berühren.
- Während des Betriebs die Öffnungen im Gehäuse nicht blockieren.
- Keine Gegenstände in das Gerät einführen.
- Die Belüftungsschlitze an der Oberseite des Geräts dürfen nicht blockiert werden. Darauf achten, daß über dem Gerät ein Freiraum von mindestens 1 meter vorhanden ist.
- Auf allen Geräteseiten muß ein Zwischenraum von ungefähr 0,2 meter vorhanden sein.

## Nederlands

Installeer het toestel niet in een rek of boekenkast waar de ventilatie mogelijk wordt gehinderd. Let tevens op de volgende punten:

- Raak de bovenkant van het toestel niet aan als het in gebruik is.
- Blokkeer de openingen van het toestel niet als het in gebruik is.
- Plaats geen onderwerpen onder het toestel.
- Blokkeer de ventilatie-openingen aan de bovenkant van het toestel niet. Zorg dat er tenminste 1 meter vrije ruimte boven het toestel is.
- Zorg dat er 0,2 meter vrije ruimte rond het toestel is.

## Español

Para ventilar la unidad no la instale en una estantería ni estante para libros, y tenga en cuenta lo siguiente:

- No toque la parte superior de la caja durante el funcionamiento.
- No tape las ranuras en la caja durante el funcionamiento
- No ponga objetos debajo de la unidad.
- No tape las ranuras de ventilación de la parte superior de la unidad. No ponga nada a menos de 1 metro por encima del panel superior.
- Deje un espacio de unos 0,2 metro alrededor de la unidad.

## Italiano

Perché l'unità possa essere sempre ben ventilata, non installarla in scaffali o librerie e tenere presente quanto segue.

- Non toccare la parte superiore del rivestimento durante il funzionamento.
- Non bloccare le aperture sul rivestimento durante il funzionamento.
- Non inserire oggetti al di sotto dell'unità.
- Non bloccare le fessure di ventilazione sopra l'unità. Non posare nulla per circa un metro sopra il pannello superiore.
- Lasciare 0,2 metro liberi tutto intorno l'unità.

## Português

Para ventilar o aparelho, não instalá-lo dentro duma estante ou algo similar, e observar as seguintes recomendações:

- Não tocar a parte superior do aparelho durante a operação.
- Não bloquear as aberturas do aparelho durante a operação.
- Não inserir objectos debaixo do aparelho.
- Não bloquear as aberturas de ventilação na parte de cima do aparelho. Deixar um espaço completamente livre de cerca de 1 metro acima do painel superior.
- Deixar um espaço de cerca de 0,2 metro ao redor do aparelho.

## Svenska

För att ventilera enheten, ställ den inte i ett ställ eller bokhylla och tänk på följande.

- Vidrör inte ytterhöljets ovansida under pågående drift.
- Blockera inte öppningarna i ytterhöljet under pågående drift.
- Stick inte in föremål under enheten.
- Blockera inte ventiltionshålén ovanpå enheten. Placera inte någonting närmare än 1 meter ovanför apparaten eller enheten.
- Se till att det finns omkring 0,2 meter fri plats runt omkring enheten.

## Dansk

Anbring ikke apparatet i et rack eller en boghylde, da dette kan bloke luftcirkulationen omkring apparatet. Iagttag ligeledes følgende:

- Berør ikke oversiden af kabinettet under anvendelsen.
- Bloker ikke åbningerne i kabinettet under anvendelsen.
- Stik ikke genstande ind under apparatet.
- Bloker ikke ventilationsåbningerne ovenpå apparatet. Anbring ikke noget nærmere end 1 m over apparatets overside, Sørg for, at der er et frit område på omkring 0,2 m omkring apparatet.

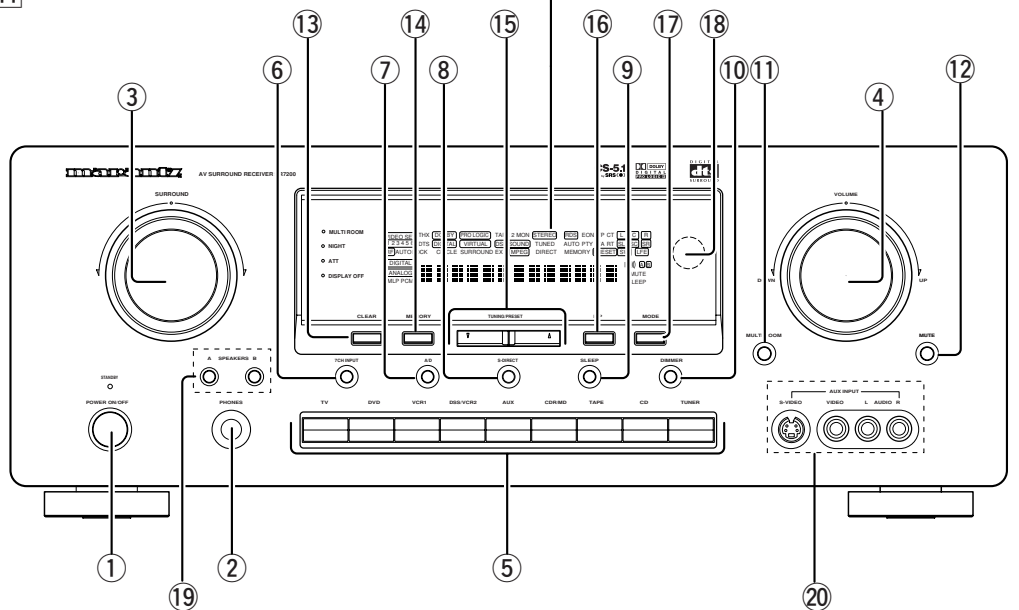
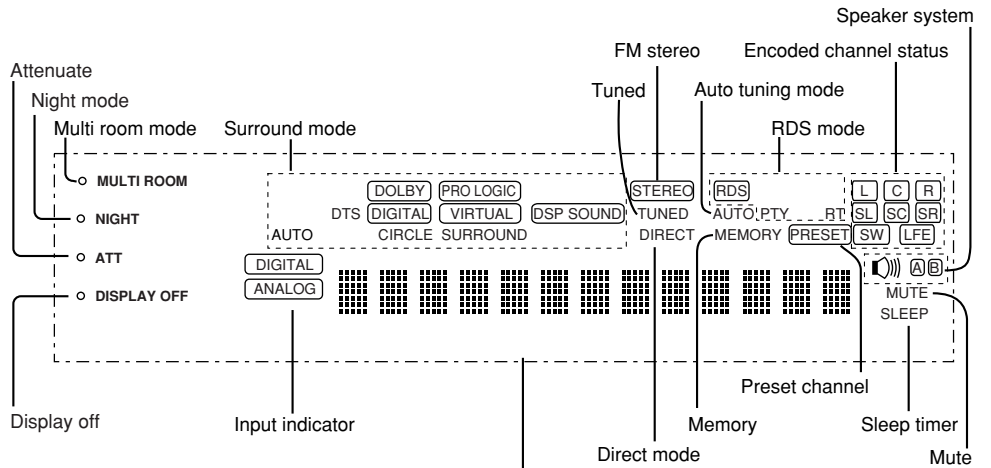
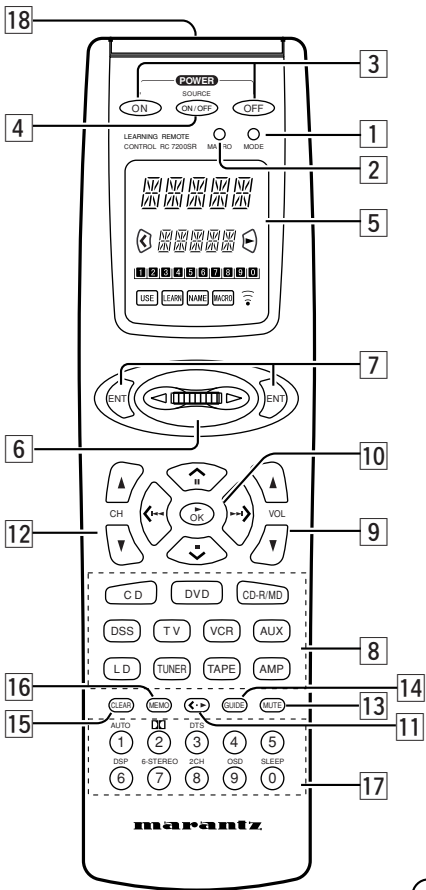
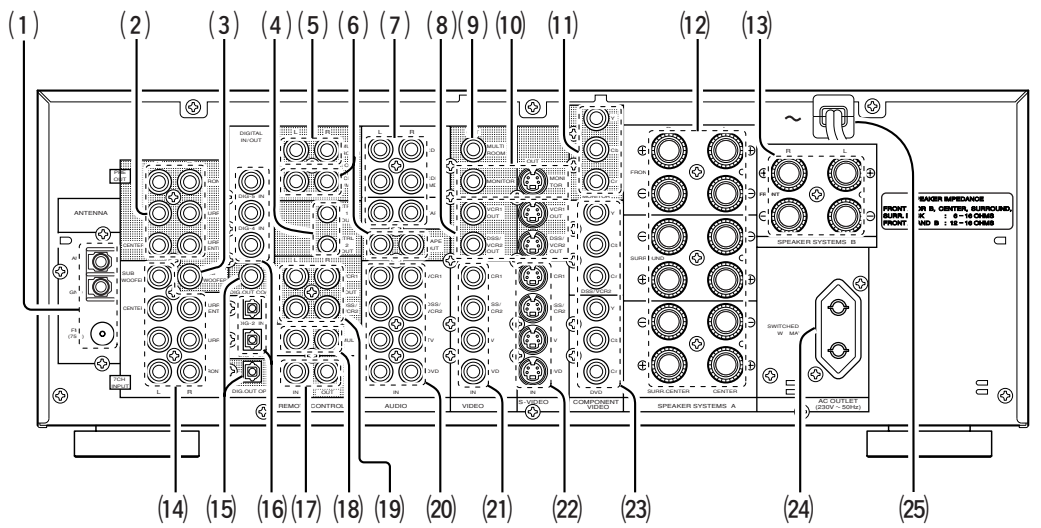

# TABLE OF CONTENTS

<b>FOREWORD</b> .....	<b>2</b>
PRECAUTIONS .....	2
<b>INTRODUCTION</b> .....	<b>3</b>
<b>DESCRIPTION</b> .....	<b>3</b>
<b>FEATURES</b> .....	<b>3</b>
<b>FRONT PANEL FEATURES</b> .....	<b>4</b>
<b>REAR PANEL CONNECTIONS</b> .....	<b>5</b>
<b>REMOTE CONTROL UNIT RC7200SR</b> .....	<b>8</b>
OPERATION OF REMOTE CONTROL UNIT .....	8
<b>SET-UP</b> .....	<b>9</b>
ON SCREEN DISPLAY MENU SYSTEM .....	9
OSD MAIN MENU .....	10
SYSTEM SETUP .....	10
SPEAKERS SETUP .....	11
SURROUND MODE .....	12
CHANNEL LEVEL CONTROL .....	12
MULTI ROOM SETUP .....	12
<b>BASIC OPERATION</b> .....	<b>13</b>
LISTENING TO THE TUNER .....	13
RDS OPERATION .....	14
PLAYBACK OPERATION .....	15
<b>OTHER FUNCTIONS</b> .....	<b>15</b>
SETTING THE SLEEP TIMER .....	15
TV AUTO ON/OFF FUNCTION .....	15
MULTI ROOM SELECTOR .....	16
<b>ON SCREEN DISPLAY INFORMATION</b> .....	<b>16</b>
<b>REMOTE CONTROL UNIT RC7200SR</b> .....	<b>18</b>
MAIN FEATURES & FUNCTIONS .....	18
NAMES OF PARTS & FUNCTIONS .....	18
BASIC OPERATION .....	20
OTHER FUNCTIONS .....	26
BATTERY LIFE .....	26
NUMBER OF LEARNABLE CODES .....	26
JOG DIAL COMMAND FUNCTIONS LISTING .....	27
<b>SURROUND MODES</b> .....	<b>28</b>
<b>TROUBLE SHOOTING</b> .....	<b>30</b>

## FOREWORD

This section must be read before any connection is made to the mains supply.

### WARNINGS

Do not expose the equipment to rain or moisture.  
Do not remove the cover from the equipment.  
Do not push anything inside the equipment through the ventilation holes.  
Do not handle the mains lead with wet hands.

### EQUIPMENT MAINS WORKING SETTING

Your Marantz product has been prepared to comply with the household power and safety requirements that exist in your area. SR7200 can be powered by 230 V AC only.

### IMPORTANT: (FOR UK VERSION)

This apparatus is fitted with an approved moulded 13 Amp plug. To change a fuse in this type of plug proceed as follows:

1. Remove fuse cover and fuse.
2. Fix new fuse which should be a BS1362 13A, A.S.T.A. or BSI approved type.
3. Refit the fuse cover.

If the fitted plug is not suitable for your socket outlets, it should be cut off and an appropriate plug fitted in its place.

If the mains plug contains a fuse, this should have a value of 13A. If a plug without a fuse is used, the fuse at the distribution board should not be greater than 5A.

#### Note:

The severed plug must be destroyed to avoid a possible shock hazard should it be inserted into a 13A socket elsewhere.

### HOW TO CONNECT A PLUG

The wires in the mains lead are coloured in accordance with the following code:

BLUE—"NEUTRAL" ("N")

BROWN—"LIVE" ("L")

1. The BLUE wire must be connected to the terminal which is marked with the letter "N" or coloured BLACK.
2. The BROWN wire must be connected to the terminal which is marked with the letter "L" or coloured RED.
3. Do not connect either wires to the earth terminal in the plug which is marked by the letter "E" or by the safety earth symbol or coloured green or green-and-yellow.

Before replacing the plug cover, make certain that the cord grip is clamped over the sheath of the lead — not simply over the two wires.

### COPYRIGHT

Recording and playback of any material may require consent. For further information refer to the following:

- Copyright Act 1956
- Dramatic and Musical Performers Act 1958
- Performers Protection Acts 1963 and 1972
- any subsequent statutory enactments and orders

### ABOUT THIS USER GUIDE

Refer to the figures on page iii of this user guide. The numbers on the figures correspond to those in the text. All references to the connections and controls that are printed in **BOLD** type are as they appear on the unit.

## PRECAUTIONS

The following precautions should be taken when operating the equipment.

### GENERAL PRECAUTIONS

When siting the equipment ensure that:

- the ventilation holes are not covered;
- air is allowed to circulate freely around the equipment
- it is on a vibration free-surface;
- it will not be exposed to interference from an external source;
- it will not be exposed to excessive heat, cold, moisture or dust;
- it will not be exposed to direct sunlight;
- it will not be exposed to electrostatic discharges

Never place heavy objects on the equipment.

If a foreign body or water does enter the equipment, contact your nearest dealer or service centre.

Do not pull out the plug by pulling on the mains lead, hold the plug. It is advisable when leaving the house, or during a thunderstorm, to disconnect the equipment from the mains supply.

### PRECAUTIONS IN CONNECTION

- Be sure to unplug the power cable from the AC outlet or turn off the POWER switch before proceeding with any connection.
- Connect one cable at a time observing the "input" and "output".  
This will avoid any cross connection between channels and signal inputs and outputs.
- Insert the plugs securely. Incomplete connection may result in noise.
- Prior to connecting other audio and video equipment to the SR7200, please read their owner's manuals.

### INSTALLATION

If this unit or another electronic device incorporating a microcomputer is used at the same time with the tuner or television, picture disturbance or noise may occur. In such a case, install the unit according to the following guide points.

- Separate the unit as far as possible from the television.
- Place the antenna wire for the tuner or TV apart from the power cable and audio and video connection cables of this unit.
- Since the phenomenon is likely to occur when using an indoor antenna and/or 300-ohm feeder wire, we recommend using an outdoor antenna and 75-ohm coaxial cable.

## INTRODUCTION

Thank you for purchasing the Marantz SR7200 DTS/Dolby Digital Surround receiver.

This remarkable component has been engineered to provide you with many years of home theater enjoyment.

Please take a few minutes to read this manual thoroughly before you connect and operate the SR7200.

As there are a number of connection and configurations options, you are encouraged to discuss your own particular home theater setup with your Marantz A/V specialist dealer.

## DESCRIPTION



DTS was introduced in 1994 to provide 5.1 channels of discrete digital audio into home theater systems.

DTS brings you premium quality, discrete multi-channel digital sound to both movies and music.

DTS is a multi-channel sound system designed to create full range digital sound reproduction.

The no compromise DTS digital process sets the standard of quality for cinema sound by delivering an exact copy of the studio master recordings to neighborhood and home theaters.

Now, every moviegoer can hear the sound exactly as the moviemaker intended.

DTS can be enjoyed in the home for either movies or music on DVD's, LD's, and CD's.



Dolby Digital lets you enjoy Digital TV, Digital Satellite as well as DVD, LD software in digital surround, which is the next step above Dolby Pro Logic. In Comparison with Dolby Pro Logic, Dolby Digital can provide separate left surround and right surround channels, for more precise localization of sound and a more convincing, realistic ambience.

And, with Dolby Digital all five main channels can be full ranged and a subwoofer can be added to each channel, if desired.

By providing up to 5.1 channels of digital audio independently. Dolby Digital lets you enjoy better sound quality and more powerful presence than conventional Dolby Surround.

Pro Logic II, the next generation in Dolby Surround Pro Logic technology, brings the excitement of surround sound to any existing stereo mix, while making existing Dolby Surround mixes sound more like discrete 5.1-channel surround sound. It works with CDs, VHS tapes and TV shows, and MP3 files and radio broadcasts-converting all of these source to surround sound, without the artifacts by other matrix-decoding technologies.



Circle Surround is backward compatible, such that surround playback is possible from any stereo or passive matrix-encoded material.

Five full-bandwidth, discrete channels of information can be extracted from an enormous library of material not multi-channel encoded. These sources include many of today's DVDs and laser discs, as well as most all video tape, VCD, Compact Disc, radio and television broadcast material.

"Dolby", "Pro Logic", and the double-D symbol are trademarks of Dolby Laboratories.

"DTS", "ES" and "DTS Digital Surround" are trademarks of Digital Theater Systems, Inc.

Circle Surround and the  symbol are trademarks of SRS Labs, Inc. Circle Surround technology is incorporated under license from SRS Labs, Inc.

## FEATURES

- Dolby Digital and DTS surround sound decoding, plus Dolby Pro LogicII decoding, Circle Surround and a variety of additional surround modes.
- 6.1 mode reproduces the original 6.1 channel soundfield by extracting the surround back signal from surround left and surround right channels.
- 192 kHz/ 24 bit decoding for highest possible fidelity and bandwidth, and high-resolution playback of 192 kHz/ 24 bit PCM audio sources.
- 110 watts to each of the six main channels; the power amp section features advanced, premium high-storage power supply capacitors, and fully discrete output stages housed in cast aluminum heat sinks.
- 6.1 channel pre-amp outputs for connection to external components such as a subwoofer and external power amplifiers.
- Seven-channel direct inputs accommodate future surround sound formats or an external digital decoder.
- 5 Digital inputs, for connection to other sources, such as DVD, DSS, CD, CD-R or MD.
- 2 Digital outputs for connection to CD-R or MD.
- High-quality AM (MW/LW) /FM tuner with 30 station presets.
- Source Direct switch bypasses, tone controls and bass management for purest audio quality.
- S-video and composite video switching .
- On- Screen- Display with both Composite and "S" video.
- Front panel A/V inputs, with S-video .
- Easy to use, on-screen menu.
- Multi-room capability offers independent control of a second room audio and video system.
- Supplied with RC7200SR Programmable Learning Remote Control.
- Radio Data System (RDS) provides information on FM broadcasts.

## FRONT PANEL FEATURES (SEE PAGE iii.)

### ① POWER switch and STANDBY indicator

Press the button to turn the power ON, and press again to turn it OFF. If the **POWER** switch is in the ON position, the power of this unit can be turned ON/OFF by pressing the **POWER** button on the remote control unit.

When this unit is in the standby mode with the **POWER** switch set to the ON position, pressing one of the **FUNCTION SELECTOR** buttons also allows to turn the power on.

The **STANDBY** indicator lights up when this unit is in the standby mode (power OFF) by the remote control unit.

### ② PHONES jack for stereo headphones

Conventional dynamic headphones can be plugged in here.

#### Notes:

When using headphones, turn off the speakers system A and B with **SPEAKERS** buttons. The surround mode is switched automatically to STEREO.

### ③ SURROUND MODE Selector knob

When this knob is turned, the surround mode is switched in the following sequence.

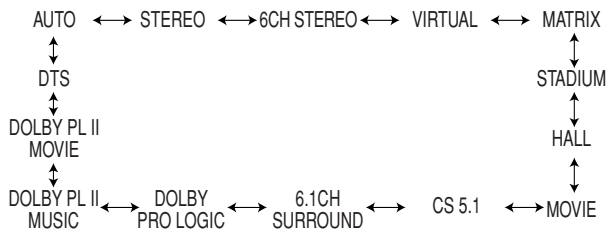

#### Note:

Not all modes will be present if an analog input is selected.

### ④ VOLUME control knob

Adjusts the overall sound level. Turning the control clockwise increases the sound level.

### ⑤ FUNCTION SELECTOR buttons (AUDIO/VIDEO)

These buttons are used to select the sources.

The video function selector, such as TV, DVD, VCR1, DSS/VCR2 and AUX, selects video and audio simultaneously.

Audio function sources such as CD, TAPE, CD-R/MD and TUNER may be selected in conjunction with a Video source.

This feature (Sound Injection) combines a sound from one source with a picture from another.

Choose the video source first, and then choose a different audio source to activate this function.

### ⑥ 7CH INPUT button

Press this button to select the output of an external multi channel decoder.

### ⑦ A/D (Analog/Digital) SELECTOR button

This is used to select between the analog and digital inputs.

#### Note:

This button is not used for an input source that is not connected to a digital input.

### ⑧ S. ( Source) DIRECT button

When this button is pressed, the tone control circuit is bypassed as well as Bass Management.

#### Notes:

The surround mode is automatically switched to AUTO when the source direct function is turned on.

Additionally, Speaker Configurations are fixed automatically as follow.

Front SPKR = Large

Center SPKR = Large

Surround SPKR = Large

Surround Center SPKR = Yes

Sub woofer = Yes

### ⑨ SLEEP button

Set the sleep timer function with this button .

### ⑩ DIMMER button

When this button is pressed once, the display is dimmed.

When this button is pressed twice, the display is turned off and "DISPLAY OFF" indicator lights up.

Press this button again to turn the display ON again.

### ⑪ MULTI (Multi Room) button

Press this button to switch the unit to multi room mode. "MULTI ROOM" indicator lights up.

### ⑫ MUTE button

Press this button to mute the output to the speakers. Press it again to return to the previous volume level.

### ⑬ CLEAR button

Press this button to cancel the station memory setting mode or preset scan tuning.

### ⑭ MEMORY button

Press this button to enter the tuner preset memory numbers and station names.

### ⑮ TUNING / PRESET UP and DOWN buttons

During reception of AM (MW/LW) or FM, you can scan the other frequencies or select another preset station pressing these buttons.

### ⑯ FREQUENCY / PRESET button

During reception of AM (MW/LW) or FM, you can change the function of the UP/DOWN buttons for scanning frequencies or selecting preset stations by pressing this button.

### ⑰ FM MODE button

Press this button to select the auto stereo mode or mono mode when the FM band is selected. The AUTO indicator lights in the auto stereo mode.

### ⑱ INFRARED SENSOR window

This window receives infrared signals from the remote control unit.

### ⑲ SPEAKERS buttons

Press these buttons to select speakers systems A and/or B.

### ⑳ AUX input jacks

These auxiliary video/audio input jacks accept the connection of a camcorder, portable VCR, etc.



## REAR PANEL CONNECTIONS (SEE PAGE iii.)

All connections to the rear panel should be made with the entire system powered off.

To avoid errors, it is advisable to connect one cable at a time between the various components.

### (1) FM antenna terminal (75 ohms)

Connect an external FM antenna with a coaxial cable, or a cable network FM source.

#### AM antenna and ground terminals

Connect the supplied AM loop antenna. Use the terminals marked "AM" and "GND".

The supplied AM loop antenna will provide good AM reception in most areas.

Position the loop antenna until you hear the best reception.

### (2) PRE OUT jacks

Jacks for Front - L/R, Center, Surround and Surround center. Use these jacks for connection to an external power amplifier.

### (3) SUB WOOFER output jack

Connect to the input jack(s) of the power amplifier for subwoofer channel or powered subwoofer.

### (4) DC control output 1 & 2

Connect a device that needs to be triggered by DC under certain conditions (screen, power strip, etc...) Use the system setup menu (3/3) to determine the conditions by which these jacks will be active.

#### Note:

This output voltage is for (status) control only, It is not sufficient for drive capability.

### (5) MULTI OUT jacks (Audio)

Connect to the input jacks of the amplifier used to drive the speakers in another room (Second zone).

### (6) Analog audio outputs for audio source equipment

#### TAPE and CD-R/MD

Connect each output to the audio inputs (REC in) of your recording equipment.

### (7) Analog audio inputs

#### CD, TAPE, and CD-R/MD

Connect the audio outputs of your source components to the input jacks on the receiver.

### (8) Video outputs

#### VCR1, and DSS/VCR2

Connect each output to the video input (REC in) of your video recording equipment.

### (9) MULTI OUT jack (Video)

Connect to the input jack of the TV monitor in another room (Second zone).

### (10) TV MONI. (VIDEO/S-VIDEO) output jacks

Connect the TV MONI jack to your TV's video input (VIDEO IN) jack. You can connect your video equipment with S-VIDEO jacks if possible, or the composite VIDEO jacks.

You must use the same type of connection from your video player into the receiver, and out of the receiver into your TV.

Both must be composite video or both must be S-Video. You cannot convert a signal from one type to the other.

When you connect to S-video connections, there will be no signal output from the composite video jacks.

### (11) COMPONENT VIDEO outputs

Connect to these outputs to the component video inputs of a video projector or monitor. When a source connected to one of the two component video inputs is selected the signal will be sent to these jacks.

### (12) SPEAKER SYSTEMS A terminals

#### FRONT Left & Right speakers output terminals

Connect to the front left & right speakers.

#### CENTER speaker output terminals

Connect to the center speaker.

#### SURROUND Left & Right speakers output terminals

Connect to the surround (rear) left & right speakers.

#### SURROUND Center speakers output terminals

Connect to the surround center speakers.

### (13) SPEAKER SYSTEMS B terminals

#### FRONT Left & Right speakers output terminals

Connect to the front left & right speakers.

#### Notes:

When you use the speaker systems A and B simultaneously, the connected speakers which are impedance 12 to 16 ohms must be used.

### (14) 7 CH INPUT jacks

Connect to the outputs of an external multichannel decoder.

### (15) DIGITAL outputs

#### Optical and Coaxial

Connect digital input of your digital recording equipment.

### (16) DIGITAL inputs

#### Fig.1,2 (Optical) and Fig. 3, 4, 5 (Coaxial)

Connect each input to the digital output of your source equipment.

Use the system setup menu to assign digital input to appropriate source. (see page. 10)

#### Note :

The coaxial connections are not for AC-3 RF from the LD player, If you want to decode this type of signal, an external demodulator must be used.

### (17) REMOTE CONT. IN/OUT terminals

Connect to a Marantz component equipped with remote control (RC-5) terminals.

### (18) MULTI ROOM REMOTE I/O terminals

IN : Connect to multi-room remote control device, available from your Marantz dealer.

OUT : Connect to the Marantz component equipped with remote control (RC-5) terminals in another room (Second zone).

### (19) Analog audio outputs for video source equipment

#### VCR1, and DSS/VCR2

Connect each output to the audio inputs (REC in) of your video recording equipment.

### (20) Analog audio inputs for video source equipment

#### TV, DVD, VCR1, and DSS/VCR2

Connect each input to the audio outputs of your video source equipment.

**(21) Video inputs****Ex: TV, DVD, VCR1, and DSS/VCR2**

Connect each input to the video outputs of your video source equipment.

**(22) S-video inputs****Ex: TV, DVD, VCR1, and DSS/VCR2**

Connect each input to the S-video outputs of your video source equipment.

**(23) COMPONENT VIDEO inputs****Ex: DVD, and DSS/VCR2**

Connect to the Y/Cr/Cb component video outputs of each your video product to these jacks.

**(24) AC OUTLET**

Connect the power cables of components such as a DVD or CD player to this outlet.

This provides power only when the SR7200 is turned on and is useful for components which you use every time you play your system.

**Caution:**

In order to avoid potential turn-off thumps, anything plugged in here should be powered up BEFORE the SR7200 is turned on.

**(25) Power cable**

Connect to AC power outlet.

SR7200 can be powered by 230V AC only.

### REMOTE CONTROL BUS CONNECTIONS

This unit is equipped with a remote control function. By connecting this unit's remote control jacks to a Marantz CD player or tape deck equipped with remote control (RC-5) jacks, it allows system remote control to operate. Connect **REMOTE CONTROL OUT** jack of SR7200 to **REMOTE CONT. IN** of other Marantz equipment, i.e. CD player or tape deck, by using an RCA pin cable.

**Note:**  
If a component equipped with remote control (RC-5) jacks has an INT/EXT switch on the rear panel, set the switch to EXT when using the system control function.

**(Connection example)**

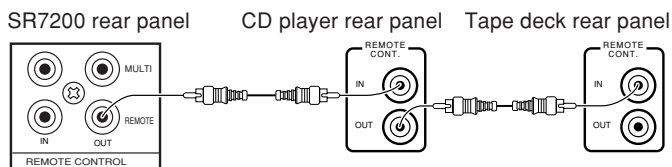

### CONNECTION FOR A SUBWOOFER

Use this connection when using a sub-woofer speaker. You can also connect a powered subwoofer.

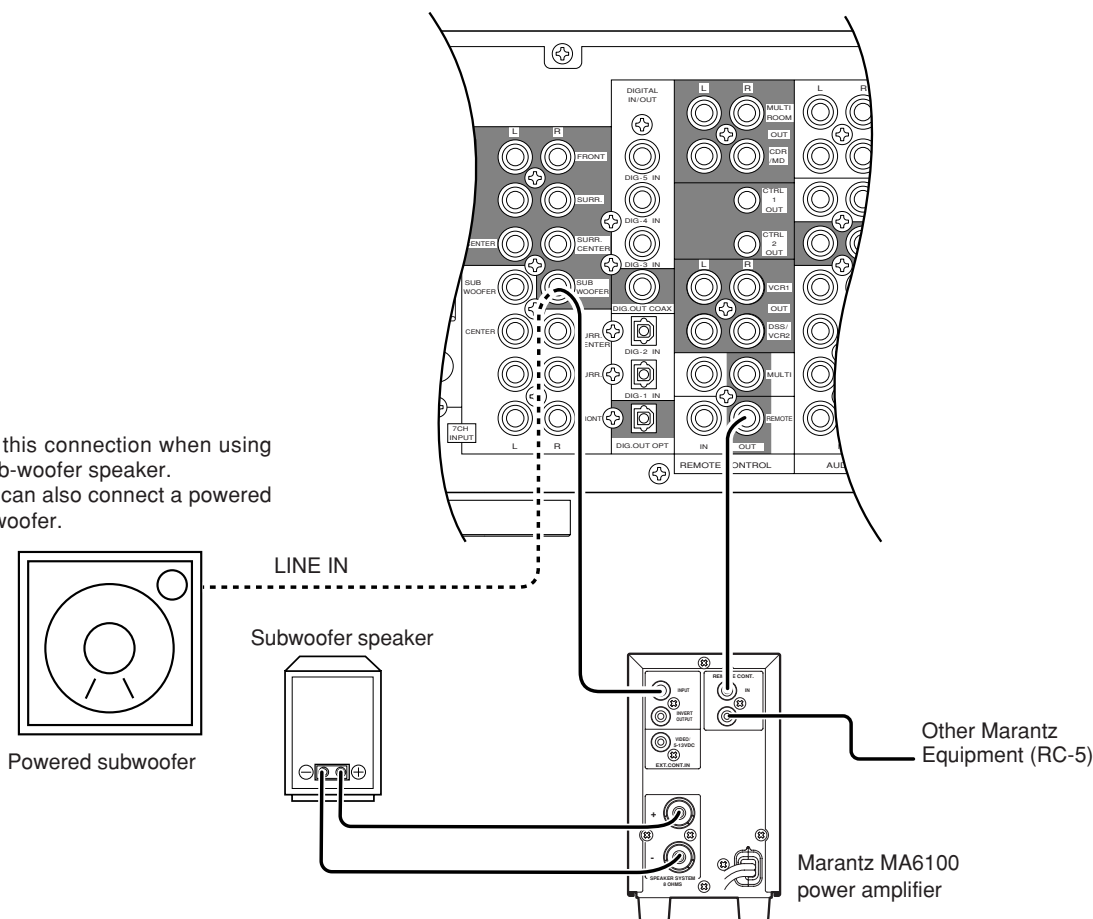

**Controlling the power ON/OFF of a power amplifier connected to the SR7200 through Marantz remote control**

1. Now the MA6100 can be turned ON / OFF in synchronism with the power ON / OFF of the SR7200.

**Notes:**

- Be sure to connect the remote control bus before the procedure above.

## REMOTE CONTROL UNIT RC7200SR

This chapter describes the functions which need to control the SR7200. See page 18 and following pages to refer other function of the RC7200SR.

### 3 POWER ON and OFF

These two buttons are use for turning on or off SR7200.

### 5 LCD

Used to display information about currently selected modes and functions.

### 6 Jog Dial control

Rotate this dial to select commands displayed on the LCD for each function. (see page 27)  
Refer to follow.

Function	Jog Dial command	Note
AMP	1 A/D	switches analog/digital input
	2 ATT	switches attenuator for analog input
	3 NIGHT	selects NIGHT mode for Dolby Digital
	4 MR-ON	turns multi-room mode on
	5 MR-OFF	turns multi-room mode off
	6 7-DIR	activates 7-channel input
	7 TRB+	increases treble
	8 TRB-	decreases treble
	9 BAS+	increases bass
	0 BAS-	decreases bass
TUNER	1 FM	FM band
	2 AM	AM/MW band
	3 LW	Long Wave band
	4 T-MOD	mono/stereo mode selector
	5 SCAN	programmed preset channel scan
	⊗ 6 STM	selects station mode
	7 F-DIR	inputs a frequency directly
	8 PTY	selects PTY function
	9 DISP	selects display function
	⊗ 0 DWR	selects DSR wave range

The marked "⊗" commands are not used for SR7200.

### 7 ENT buttons

Press this button to enter the selected command by the Jog Dial.

### 8 FUNCTION buttons

Press one of these buttons twice within 2 seconds to select the input function of SR7200.

Press one of these buttons once to change the state of remote commander.

### 9 VOLUME ▲ up / ▼ down buttons

These buttons are used to raise and lower the SR7200's volume level.

### 10 CURSOR buttons

The cursor buttons can be used to navigate within on-screen menus of SR7200.

### 12 Channel ▲ up / ▼ down buttons

Used to controls the up/down function of tuner, or allows one to cycle through the tuner presets.

### 13 MUTE button

This button can be used to mute the sound temporarily.

### 15 CLEAR button

This button is used to cancel certain memory or programming operations.

### 16 MEMO button

This button is used to enter the tuner preset memory numbers and station names.

### 17 TEN KEYPAD

They are useful for tuning a pre-set radio station and setting a station name.

## OPERATION OF REMOTE CONTROL UNIT

### 1. Remote control

The distance between the transmitter of the remote control unit and the IR SENSOR of the SR7200 should be less than about 5 meters. If the transmitter is pointed to a direction other than the IR SENSOR or if there is an obstacle between them, remote control may not be possible.

#### Remote-controllable range

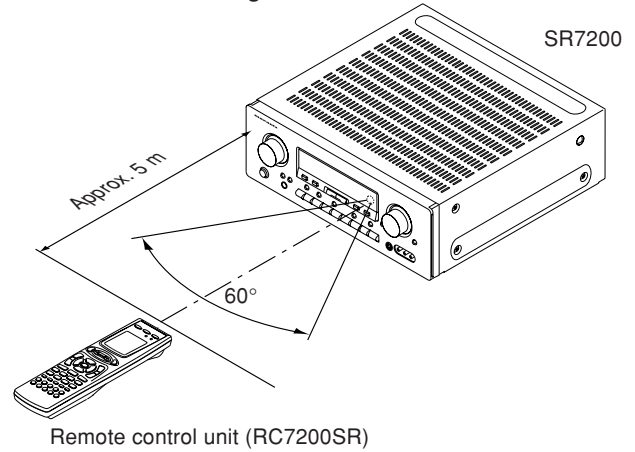

### 2. Loading batteries

The life of the batteries used with the remote control unit is about 4 months with normal use. Also be sure to replace batteries earlier when you notice that they are getting weak.

#### (1) Remove the back cover.

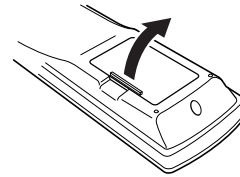

#### (2) Insert the new batteries (AA type) with correct (+) and (-) polarity.

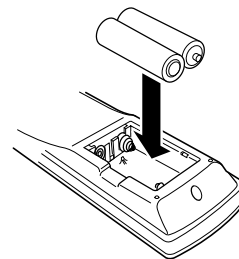

#### (3) Close until it clicks.

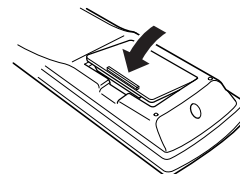

# SET-UP

After all components are connected, initial setup must be performed.

## ON SCREEN DISPLAY MENU SYSTEM

The SR7200 incorporates an on-screen menu system, which makes various operations possible by using the cursor (<, >, ^, v) and OK buttons on the remote controller.

The settings made with these buttons are also shown in the on-screen display.

### OSD MAIN MENU

```

OSD MAIN MENU
▶ SURROUND MODE
CHANNEL LEVEL
MULTI ROOM SETUP
SYSTEM SETUP
SPEAKER SETUP

EXIT
    
```

### SURROUND MODE

```

SURROUND MODE
▶ SOURCE DIRECT : OFF
SURR-MODE : AUTO
NIGHT MODE : OFF
LFE LEVEL : 00dB

RETURN      EXIT
    
```

### SYSTEM SETUP 1/3

```

SYSTEM SETUP 1/3
▶ 7CH-INPUT : OFF
TV-AUTO : DISABLE

NEXT SETUP  EXIT
    
```

### SPEAKER SETUP 1/3 SPKR SIZE

```

SETUP1/3 SPKR SIZE
▶ SETUP : UNLOCKED

FRONT-L/R : LARGE
CENTER : SMALL
SURR-L/R : SMALL
SURR-CENTER : YES
SUBWOOFER : YES

NEXT SETUP  EXIT
    
```

### CHANNEL LEVEL CONTROL

```

CH. LEVEL CONTROL
▶ FRONT L : 00 dB
FRONT R : 00 dB
SUBWOOFER : 00 dB
CENTER : 00 dB
SURROUND L : 00 dB
SURROUND R : 00 dB
SURR. CENTR : 00 dB

RETURN      EXIT
    
```

### SYSTEM SETUP 2/3

```

SYSTEM SETUP 2/3
▶ CD : DIG1
CD-R : DIG2
DVD : DIG3
TV : DIG4
DSS : DIG5

NEXT SETUP  EXIT
    
```

### SPEAKER SETUP 2/3 SPKR DISTANCE

```

SETUP2/3 SPKR DISTANCE
▶ UNIT : ft
FRONT-L : 10ft
FRONT-R : 10ft
CENTER : 10ft
SURROUND-L : 10ft
SURROUND-R : 10ft
ENTER

NEXT SETUP  EXIT
    
```

### MULTI ROOM SETUP

```

MULTI ROOM SETUP
▶ MULTI ROOM : OFF
VIDEO : DVD
AUDIO : DVD
VOLUME : VARIABLE
VOLUME LEVEL : -75 dB
---MAIN-ROOM STATUS---
VIDEO: DVD
AUDIO: DVD
RETURN      EXIT
    
```

### SYSTEM SETUP 3/3

```

DC CONTROL OUTPUT
▶ DC1 : OFF
TV DVD VCR1 DSS CD
CD-R TAPE AUX TUNER

DC2 : OFF
TV DVD VCR1 DSS CD
CD-R TAPE AUX TUNER

RETURN      EXIT
    
```

### SPEAKER SETUP 3/3 SPKR LEVEL

```

SETUP3/3 SPKR LEVEL
▶ TEST MODE : MANUAL
TEST TONE : OFF
FRONT-L : 00dB

■      ■      ■
■      ■      ■

RETURN      EXIT
    
```

## OSD MAIN MENU

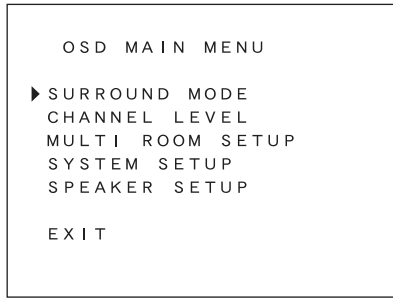

1. Press the **AMP** button [8].
2. Press **OK** button [10] to display the "MAIN MENU" of the on-screen display menu.  
Choose a desired item in the contents with **^** or **v** button, and press the **OK** button to select.  
Display will change to menu for each item.

## SYSTEM SETUP

### SYSTEM SETUP 1/3

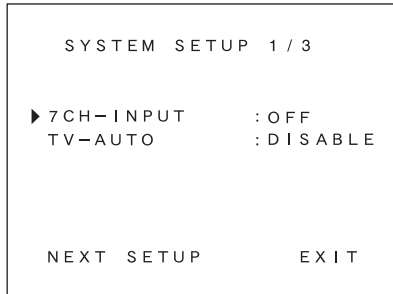

**7CH-INPUT** : The 7 channel input of the SR7200 can be selected to use a 7channel input. Select 7 channel use by **<** or **>** button.

**TV AUTO** : This product is equipped with a TV-auto ON/OFF system, which automatically turns on or off the power 1 second to 5 minutes after the TV video input signal has been sent or has been stopped.

Switch the TV AUTO ON/OFF function to enable or disable with **<** or **>** button.

To use this function, connect the TV video input to TV tuner's video output.

**NEXT SETUP/EXIT** : If you desire to continue the next setup ,press the **OK** button on NEXT-SETUP, if you desire to exit from OSD menu system, press the **OK** button on EXIT.

### SYSTEM SETUP 2/3 (SELECTING THE DIGITAL INPUT)

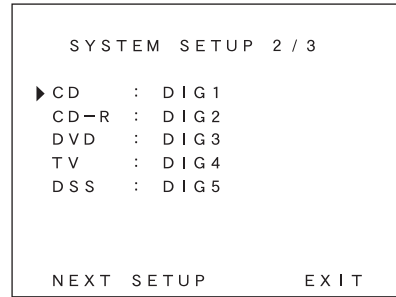

Five digital inputs can be assigned for the desired source. Use this menu to determine which source is connected to which input.

#### Example;

When the digital output of a DVD player is connected to Digital 4 (input jack) of the SR7200;

1. Move the cursor on the line of the DVD with cursor buttons **^** or **v**.
2. Press the the cursor **<** or **>** button until "DIG4" is displayed.
3. Press the **OK** button to chose.
4. If you desire to continue the next setup, press the **OK** button on NEXT-SETUP.

If you desire to exit from OSD menu system, press the **OK** button on EXIT.

#### Notes:

The TUNER, VCR1, TAPE and AUX are assigned to the analog input, and are prevented from selecting any digital input.

While the DTS-LD or DTS-CD is playing, this setup is not available, this is to avoid noise being generated from the analog input. Stop the LD or CD playback to setup.

The SR7200 does not switch from digital input to analog input or vice versa automatically.

In the event that both digital and analog inputs are connected to SR7200, if you desire to switch to an analog input temporarily, you can switch by pressing the **A/D** button [7].

### SYSTEM SETUP 3/3 (DC CONTROL OUTPUT)

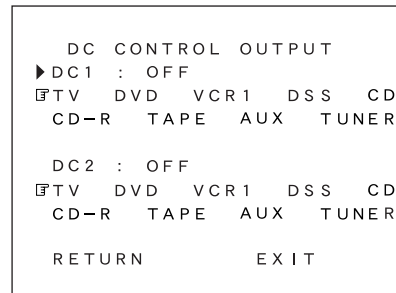

SR7200 has two DC control jacks, each one is selectable to link with input functions for the main room or multi room.

You can select MAIN ROOM, MULTI ROOM or OFF for DC1 & DC2 independently by **<** or **>** button.

And then press **OK** button and move the cursor to select the linked input function you desired by **<** or **>** button and press **OK** button to chose.

#### Notes:

When the DC CONTROL OUTPUT is selected for the multi room, the multi room must be turned on previously.

## SPEAKERS SETUP

The home theater system you already have installed should function provided that there are left, center and right front speakers, left and right rear/surround speakers and a subwoofer. For best results we recommend that all front speakers be of the same type, with identical or similar driver units. This will deliver smooth pans across the front sound stage as the action moves from side to side.

Your center channel speaker is very important as over 80 % of the dialog from a typical motion picture emanates from the center channel. It should possess similar sonic characteristics to the main speakers.

Surround channel speakers need not be identical to the front channel speakers, but they should be of high quality.

The surround center speaker is useful for playback of Dolby Digital Surround EX or DTS-ES. One of the benefits of both Dolby Digital (AC-3) and DTS is that surround channels are discrete full range, while they were frequency limited in earlier "Pro Logic" type systems. Bass effects are an important part of home theater. For optimal enjoyment a subwoofer should be used as it is optimized for low frequency reproduction. If you have full range front speakers, however, they may be used in place of a subwoofer with proper setting of the switches in the menu system.

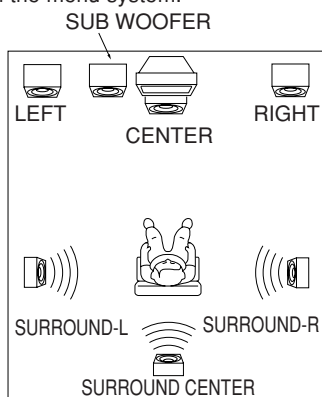

If possible, mount the surround speakers on the walls to the sides of the viewing area, 2-3 feet above seated viewers, firing straight across at each other.

### SPKR SETUP 1/3 (SPKR SIZE)

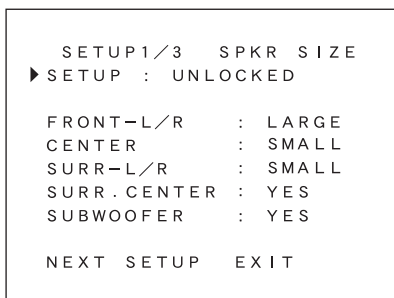

**SETUP:** Select "LOCKED" with < or > button in order to lock the contents of the SPCR SET UP MENU.

Then, when you want to change the contents of this setup, select "UNLOCKED".

#### SPKR SIZE

This menu enters the information about which type of speakers will be used for each channel.

In turn, these settings will determine which speakers receive low frequency information.

For the purpose of establishing proper bass reproduction, use the LARGE settings if the speaker being used at any position is a traditional full-range loudspeaker that is capable of reproducing sound below 100 Hz and you are not using a subwoofer.

Use the SMALL setting for smaller, frequency-limited speakers that are not able to reproduce sounds below 100Hz and you are using a subwoofer. Low frequencies will be diverted from the speaker to the subwoofer.

Note that when "small" speakers are used it is advisable to install a separate subwoofer, especially if you wish to appreciate the full impact of a good home theater soundtrack.

If the Surround speakers or Center speaker will not be used, set NONE for each speaker. The NONE setting will send the audio for the channel to other speakers.

**FRONT -L/R :** Select the type of front speakers with < or > button.

**CENTER :** Select the type of center speaker with < or > button.

**SURR-L/R :** Select the type of surround speakers with < or > button.

**SURR.CENTER :** Select the surround center speaker YES or NO with < or > button.

**SUBWOOFER:** Select the subwoofer speaker YES or NO with < or > button.

#### Notes:

The SUBWOOFER cannot be set to NO when the front speakers are set to SMALL.

This speaker size setup is not effective when the SOURCE-DIRECT or 7CH. Input is selected.

### SPKR SETUP 2/3 (SPKR DISTANCE)

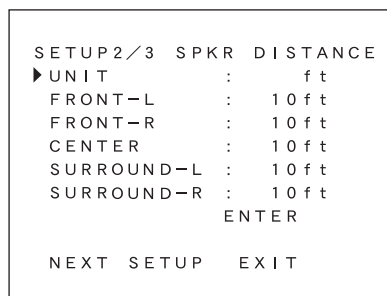

Use this parameter to specify the distance of the speaker's position from the listener.

The delay time is automatically set according to these distances.

**UNITS:** You can select Meters or Feet.

If you select "ft", the setting parameter will change in 1 foot steps.

If you select "m", it will change in 0.3 meter steps.

Select speaker with ^ or v button, and input each speaker's distance with < or > button.

When the input for each speaker's distance has been finished, move the cursor to ENTER and press the OK button.

#### Notes:

Placement beyond that distance is beyond the range of the automatic time delay feature.

The delay feature does not function in the SOURCE-DIRECT ,7 CH-Input modes and decoding of 96 kHz sources.

### SPKR SETUP 3/3 (SPKR LEVEL)

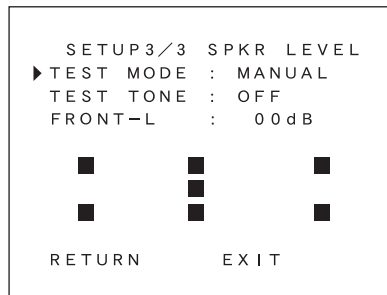

#### SPKR LEVEL

**TEST MODE:** Selects the mode for generating the test tone.

If you select AUTO, the test tone will be cycled through in a circular pattern which is Left → Center → Right → Surround Right → Surround Center → Surround Left → Subwoofer → Left → ... 3 seconds for each channel.

If you select MANUAL, press the OK button to select the test tone channels after the "TEST TONE ON".

**TEST TONE:** Press the < or > button, ON is indicated and the test tone starts from the front L-CH speaker.

Press the < or > button again on this item. OFF is indicated and the output of the test tone will stop.

**Channel:** Adjust the level of test tone for each channel with the < or > buttons of the RC7200SR. The current volume level is shown at the center of the display.

#### Notes:

Test tone does not generate when the SOURCE DIRECT function is turned on.

## SURROUND MODE

SURROUND MODE	
▶ SOURCE DIRECT :	OFF
SURR-MODE :	AUTO
NIGHT MODE :	OFF
LFE LEVEL :	00dB
RETURN	EXIT

**SOURCE DIRECT** : Switch the source direct ON or OFF with < or > button. This bypasses the surround processing and crossover for the main speakers (front left and right will be full range and the subwoofer will be ON)

**Note**: Surround mode cannot be changed in Source Direct mode.

**SURR-MODE** : Select the surround mode with < or > button.

**NIGHT MODE** : Switch the NIGHT MODE ON or OFF with < or > button.

Selecting the Night Mode ON is effective in Dolby Digital only, and it compresses the dynamic range.

This softens loud passages such as sudden explosions, to help prevent disturbing others late at night.

**LFE LEVEL** : Select the output level of the LFE signal included in the Dolby Digital signal or the DTS signal. Select 0dB, -10 dB or OFF with < or > button.

The level is ordinarily set to 0 dB. When use DTS music source, LFE level is set to -10 dB.

## MULTI ROOM SETUP

MULTI ROOM SETUP	
▶ MULTI ROOM :	OFF
VIDEO :	DVD
AUDIO :	DVD
VOLUME :	VARIABLE
VOLUME LEVEL :	-75 dB
---MAIN-ROOM STATUS---	
VIDEO :	DVD
AUDIO :	DVD
RETURN	EXIT

**MULTI ROOM** : To switch on the Multi-room output.

**VIDEO** : Select the video source of the Multi-room output.

**AUDIO** : Select the audio source of the Multi-room output.

**VOLUME** : Select whether the Multi-room output level is variable or fixed.

**VOLUME LEVEL** : Adjust the Multi-room output level.

**MAIN ROOM STATUS** : Selected input source in the main room will be displayed.

### Notes:

If "VOLUME" is set to "FIXED", the multi-room output level cannot be adjusted.

You cannot transmit a digital signal using the multi-room function. Any source component that is desired to be operated in the second zone needs to have the analog outputs connected to receiver.

## CHANNEL LEVEL CONTROL

CH. LEVEL CONTROL	
▶ FRONT L	00 dB
FRONT R :	00 dB
SUBWOOFER :	00 dB
CENTER :	00 dB
SURROUND L :	00 dB
SURROUND R :	00 dB
SURR. CENTR :	00 dB
RETURN	EXIT

Desired channels can be selected by pressing ^ or v button.

Each channel level will be adjusted by pressing < or > button.

Only the usable channels which are determined depending on the SURROUND mode, and SPEAKER SETTING are displayed.



# BASIC OPERATION

## LISTENING TO THE TUNER

### MANUAL TUNING

1. To select the tuner as the source, press the **TUNER** button ⑤ on the front panel or press the **TUNER** button ⑧ on the remote control unit.
2. Press the **TUNER** button ⑤ on the front panel or press the **TUNER** button ⑧ on the remote control unit to select the desired frequency band if required.
3. Press the **F/P** button ⑩ on the front panel to display the frequency.
4. Press the **TUNING/PRESET ▲** or **▼** button ⑮ on the front panel or press the **▲**, **▼** button ⑩ on the remote control unit.
5. If FM is selected, press the **MODE** button ⑰ on the front panel or select **T-MOD** by the **Jog Dial** ⑥ and press the **ENT** button ⑦ in the TUNER mode on the remote controller.

### (FM) MODE BUTTON OPERATION

When "AUTO" indicator is on in the display, FM stations that broadcast in stereo will be received in stereo and the "STEREO" indicator lights. When "AUTO" indicator is off, all the FM stations will be received in mono regardless of whether or not they are broadcasting in stereo.

### AUTO TUNING

1. Press the **F/P** button ⑩ on the front panel to display the frequency.
2. Press the **TUNING/PRESET ▲** or **▼** button ⑮ on the front panel for more than 1 second to start the Auto tuning function.

### AUTO TUNING (USING THE REMOTE CONTROL UNIT)

Press **▲**, **▼** button ⑩ for more than 1 second to start the Auto tuning function.

### PRESET TUNING

With this unit you can preset up to 30 FM/AM (MW/LW) stations in any order. For each station, you can memorize the frequency and reception mode if desired.

#### 1-a. Manual Presetting

1. Refer to the "MANUAL TUNING" or "AUTO TUNING" section above to tune in a desired station.
2. Press the **MEMORY** button ⑭. "MEMORY" indicator starts blinking on the display.  
While "MEMORY" is still blinking (approx. 5 seconds), select the preset number by pressing the **TUNING/PRESET ▲** or **▼** button ⑮ then press the **MEMORY** button ⑭ again.
3. When a number has been properly input, "MEMORY" indicator stops blinking and goes out.  
The station is now stored in the specified preset memory location.

#### 1-b. Manual Presetting (Using the remote unit)

1. Tune in a desired station.
2. Press the **MEMO** button ⑯.
3. Enter the desired preset number with ten keypad ⑰.
4. Then, press **MEMO** button ⑯ again to store.

#### 2. Auto Presetting

This function automatically scans the FM and AM (MW/LW) band and enters all stations with sufficient signal strength into the memory.

1. Press and hold down the **MEMORY** button ⑭ and **TUNER** button ⑤ simultaneously for 3 seconds or more.
2. "MEMORY" will blink on the display.
3. Each time the tuner finds a station, the scanning will pause and memory. Auto presetting will starts.
4. Operation stops automatically when all 30 preset memory positions are filled or when auto scanning attains the highest end of all bands.  
To stop the auto preset function at anytime, press the **CLEAR** button ⑬.

### 3. Recalling a Preset Station

1. Press the **F/P** button ⑩ to change the display to preset.
2. Select the desired preset station by pressing **TUNING/PRESET ▲** or **▼** button ⑮ on the front panel or press **CH▲** or **CH▼** button ⑫ on the remote.

#### Note:

To directly access the preset stations using the numeric keypad, select the desired preset station by entering one or two digits using the numeric keypad ⑰.

To return to the Manual Tuning mode, press the **F/P** button ⑩.

### 4. Preset Scan Tuning (Using the remote control unit)

1. Select the **SCAN** by the **Jog Dial** ⑥ and press the **ENT** button ⑦ in the TUNER mode on the remote controller. (The preset station with the smallest preset number is recalled first. If no stations have been preset, "NO PRESET" shows in the display and the unit returns to the previous mode.)
2. Preset stations are recalled in sequence (CH-1 → CH-2, etc.) for 5 seconds each. Preset numbers that do not contain stations are skipped.
3. You can fast forward the preset stations by pressing the **CH▲** button continuously.  
When the desired preset station is received, cancel the preset scan operation by pressing the **CH▼** button or the **CLEAR** button ⑬.

### 5. Clearing Preset Stations

You can remove preset stations from memory using the following procedure.

1. Recall the preset number to be cleared with the method described in "Recalling" a preset station.
2. Press the **CLEAR** button ⑬ on the front panel or **CLEAR** button ⑮ on the remote control unit for 3 seconds or more.  
"CLEAR" appears on the display to indicate that the specified preset number has been cleared.

### 6. Frequency Direct Call

1. Select **F-DIR** by the **Jog Dial** ⑥ and press the **ENT** button ⑦ in the TUNER mode on the remote controller.
2. Display shows "FM- - - - MHz" (at FM mode).
3. Input your desired frequency with tenkeypad buttons on the remote controller.  
Eg) 98.1 MHz  
Press **9**, **8**, **1** and **0**
4. Press the **ENT** button ⑦ again.

**STATION NAME PRESET (on PRESET display mode)**

The station name preset function allows the name of each preset channel to be entered using alphanumeric characters. The Station Name button is valid only in the tuner mode. Before station name preset operation, store stations with the preset memory operation.

1. Press the **MEMORY** button [14] on the front panel or **MEMO** button [16] on the remote for more than 3 seconds.
2. The left most column of the station name indicator flashes, indicating the character entry ready status.

**[Operation (Using the SR7200)]**

3. When you press the **TUNING/PRESET** ▲ or ▼ buttons [15] is turned, alphabetic and numeric characters will be displayed in the following order:  
**A → B → C ...Z → 1 → 2 → 3.... 0 → - → + → / → (Blank) → A**  
 UP →  
 ← DOWN
4. After selecting the first character to be entered, press the **MEMORY** button [14]. The entry in this column is fixed and the next column starts to flash. Fill the next column and press the **MEMORY** button [14] for more than 1 second to confirm the entry.

**[Operation (Using the remote unit)]**

- First, press the **TUNER** button on the remote control unit.  
 (This operation is not necessary if the remote control unit has already been operated in the TUNER mode.)
3. Enter the character using the ten keypad [17]. For example, to enter "A":  
 1) Press the "1" button. "A" appears on the display column.  
 2) Every time the 1 button is pressed, the displayed character changes in the order: A → B → C → 1 → A...  
 Pressing buttons other than the "1" button cause different characters to be displayed in a similar way, so that other alphanumeric characters can be entered. To enter a blank or space, press the "0" button.
  4. When the desired character is displayed, press the **MEMO** button [16] to confirm the entry in this column and move to the next column. After having filled all of the 8 columns, press the **MEMO** button [16], for more than 1 second to confirm the entry.

**RDS OPERATION**

Now in use in many countries, RDS (Radio Data System) is a description of the station's programming hidden space in the FM signal.  
 Your new receiver is equipped with RDS to assist in the selection of FM stations using station and network names, rather than broadcast frequencies. Additional RDS functions include the ability to search for programme types.

**RADIO TEXT**

Some RDS stations broadcast RADIO TEXT, which is additional information on the station and programme being broadcast. RADIO TEXT information appears as 'running' text in the display. RADIO TEXT is transmitted character-by-character by the radio station. As a result of that it may take some time until the entire text has been completely received.

**RDS DISPLAY**

When a receiver is tuned to an FM station that is transmitting RDS data, the Front Panel Information Display will automatically show the station name or RDS TEXT in place of the typical display of the station's broadcast frequency.  
 To change the display, select the **DISP** by the **Jog Dial** [6] and press the **ENT** button [7] in the TUNER MODE on the remote controller.

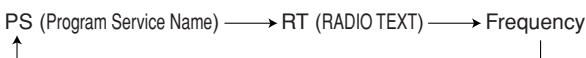

**PROGRAMME TYPE (PTY) DISPLAY**

The RDS system categorizes programmes according to their genre into different programme type (PTY) groups. To display the programme type information of the current station, select the **PTY** by the **Jog Dial** [6] and press the **ENT** button [7] in the TUNER MODE on the remote controller.

**PTY AUTO SEARCH**

Your receiver is equipped to automatically search for stations transmitting any of 29 different programme types. To search for a PTY, follow these procedures:

1. Select the **PTY** button by the **Jog Dial** [6] and press the **ENT** button [7] in the TUNER MODE on the remote controller. The current station's PTY will be displayed, or the currently selected PTY group will be displayed in blinking if no station or RDS data is present.
2. To change to a new PTY type, press the **CH▲/▼** button [12] until the desired PTY is shown in the display.  
 To select a specific PTY type, use the ten key pad [17] on the remote control to select the programme type corresponding to the numbered choices in the table on the following.
3. Once the desired PTY group or type has been selected, select the **PTY** by the **Jog Dial** [6] while the display blink (approx. 5 seconds). The PTY Auto search will start, and the tuner will pause at each station broadcasting RDS PTY information corresponding to the selected choice.
4. To advance to the next RDS station with the desired PTY, select the **PTY** by the **Jog Dial** [6] again within 5 seconds.

NUMBER	DISPLAY	PROGRAMME TYPE
1	POP	Pop Music
2	ROCK	Rock Music
3	MOR	M. O. R. Music
4	LIGHT	Light classical
5	CLASSIC	Serious classical
6	NEWS	News
7	AFFAIR	Current Affairs
8	INFO	Information
9	SPORT	Sport
10	EDUCATE	Education
11	DRAMA	Drama
12	CULTURE	Culture
13	SCIENCE	Science
14	OTHERS	Varied
15	OTHER	Other Music
16	WEATHER	Weather
17	FINANCE	Finance
18	CHILDREN	Children's programmes
19	SOCIAL	Social Affairs
20	RELIGION	Religion
21	PHONE IN	Phone In
22	TRAVEL	Travel
23	HOBBIES	Hobbies
24	JAZZ	Jazz Music
25	COUNTRY	Country Music
26	NATION	National Music
27	OLDIES	Oldies Music
28	FOLK	Folk Music
29	DOCUMENT	Documentary

## PLAYBACK OPERATION

### NORMAL PLAYBACK

1. Press the POWER ON button on the remote.
2. Press the **FUNCTION SELECTOR** button ⑤ on the front panel or press the **FUNCTION** button ⑧ on the remote unit to select an input source.
3. Turn the **SURROUND MODE SELECTOR** knob ③ on the front panel or Surround mode buttons ⑰ in the AMP MODE on the remote unit to select the desired surround mode.
4. Adjust the volume level using the **VOLUME** knob ④ on the front panel or press the **VOL ▲ / ▼** button ⑨ on the remote. If necessary, adjust the tone, select the **TRB+**, **TRB-** and **BAS+**, **BAS-** by the **Jog Dial** ⑥ and press **ENT** button ⑦ in the AMP MODE on the remote unit.

#### Notes:

- In case of remote control operation, press one of the function buttons twice within 2 seconds to select the function.
- Tone control is available for following surround modes. AUTO (except 96 kHz), STEREO, DOLBY PRO LOGIC and DTS.

### LISTENING TO A DIFFERENT AUDIO SOURCE WHILE WATCHING A VIDEO SOURCE (Using the remote control unit)

1. Select one of the following video sources  
TV, DVD, VCR1, DSS/VCR2 or AUX.
2. Next, select one of the following audio sources  
FM, AM (MW/LW), CD, TAPE, or CD-R/MD.

## OTHER FUNCTIONS

### SETTING THE SLEEP TIMER

Set the sleep timer while the power is turned on.

1. Turn the power ON and press the **SLEEP** button ⑨.
2. Press the **SLEEP** button ⑨ the number of times to set the desired sleep time in minutes.  
Each press of the **SLEEP** button ⑨ or changes the display in the following order:

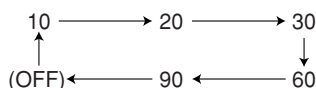

The unit will shut off in the number of minutes indicated.

- \* While the sleep timer is activated, the remaining time can be displayed for approximately 2 seconds by pressing the **SLEEP** button ⑨.
- \* To cancel the sleep timer, press the **SLEEP** button ⑨ and then press the **CLEAR** button ⑬.

### TV AUTO ON/OFF FUNCTION

This function allows the component connected to the TV IN jack to control the power (ON/OFF) to the SR7200.

#### AUTO POWER ON

1. Be sure TV auto mode is enable. (Refer page 10 : System Setup 1/3)
2. Connect your TV TUNER (etc) to the TV IN terminal.  
Be sure to connect the video input.
3. Turn OFF the power to the TV TUNER and the SR7200 will be in standby mode.
4. Turn ON the TV TUNER and tune in a receivable station.
5. When the station is received, the SR7200 turns ON and TV is selected automatically.

#### AUTO POWER OFF

1. In the above situation, turn the TV TUNER OFF or select a channel that does not contain any broadcast.
2. The SR7200 switches to STANDBY after approximately 5 minutes.

#### Note:

AUTO POWER OFF is canceled if the **FUNCTION SELECTOR** button ⑤ is set to a source other than TV. The function reactivates when TV is selected again.

#### Caution:

Some TV broadcasts may cause the TV AUTO FUNCTION to be turned enable. To set this function to ENABLE/DISABLE, refer to the SETUP MENU.

## MULTI ROOM SELECTOR

The Multi Room Selector is a function which allows you to listen to the same or a different source in a room other than the room in which the SR7200 is located. To use this function, a multi room remote unit and remote control signal receiver available from your Marantz dealer are necessary. The operations possible with the multi room function are explained briefly below. For details, refer to the instruction manual supplied with the multi room remote control unit and receiver.

### MULTI ROOM SELECTOR OPERATION

1. Press the **MULTI ROOM** button (1). The unit enters multi room mode and the display indicates "SEL SOURCE" and flashes the "MULTI ROOM" indicator for approx. 5 seconds. In this time, you can select the input source by pressing the **FUNCTION SELECTOR** button (5).
2. Then, the display indicates "M/VOL xx dB". At this time, you can set the volume level of the multi room by turning the volume control knob.
3. Then, the display indicates "MULTI PAL". At this time, you can set PAL or NTSC for second zone TV format of OSD. Press **OSD** button (17) on the remote control unit. "MULTI PAL" or "MULTI NTSC" will be shown on the display of SR7200.
4. Then, the display indicates "M/SLEEP OFF" and you can set sleep timer for multi room by pressing by the **SLEEP** button (9).

#### Note:

If the multi room function is to be set using the remote control unit, select the settings on the MULTI ROOM SETUP screen in the OSD MAIN MENU. (Refer to page 12.)

### MULTI ROOM SELECTOR OPERATION (USING THE MULTI ROOM REMOTE CONTROL UNIT)

1. If Video output for multi room is connected to the TV in your second zone, the on screen display for this video signal will be shown as follow.

```

MULTI ROOM SETUP

VIDEO          : DVD
AUDIO          : DVD
VOLUME LEVEL  : -75 dB

SLEEP TIMER   : OFF
---MAIN-ROOM STATUS---
VIDEO         : DVD
AUDIO         : DVD
  
```

2. Press the **POWER ON** button, or select the desired source on multi room remote control unit from the MULTI ROOM. Any of these operations will put the SR7200 into multi room mode and "MULTI ROOM" indicator will light and OSD system for the TV in the multi room will be shown.
3. Press the **VOL.UP** or **VOL.DOWN** button on the multi room remote control unit to set the desired sound volume.
4. In multi room mode, the multi room remote control unit can be used in the multi room to operate the following functions. You can select a tuner preset channel and tuning up or down, and direct selection. And you can control the CD player, DVD player VCR and tape deck connected to the SR7200.
5. Additionally, SLEEP timer function for multi room is available from second zone, by pressing the SLEEP button on the multi room remote control unit.
6. The status of the main room setting can be monitored from the second zone with the OSD.

#### Caution:

If the main room and the secondary room are listening to the tuner, the main room will have priority over controlling that source. For example, you cannot change the frequency or preset of the Tuner from a remote location if the main room is also listening to that source.

## ON SCREEN DISPLAY INFORMATION

The on-screen display, which can be activated by the Main unit or remote, appears on the TV screen to show the current setting status of the SR7200.

#### Note:

Each video input function is set PAL or NTSC for TV format of OSD.

If this setup does not meet the video input signal, character of OSD can not synchronize.

So You can select these format function by function.

Press **OSD** button (17) on the remote controller for 3 seconds or more. "PAL" or "NTSC" will be shown on the display of SR7200, press **OSD** button (17) again to change the TV format.

The indication on FL display will change "PAL" → "NTSC" → "PAL"→.

This setup is memorized with each video input function.

### 1. GENERAL INFORMATION

When the **OSD** button (17) is pressed, the current setting are displayed on the TV monitor.

This display disappears automatically in about 5 seconds after the button is pressed.

```

VIDEO          : DVD
AUDIO          : DVD
DIGITAL        : DIG3
SURR-MODE     : AUTO
MULTIROOM     : OFF

MASTER VOLUME
-----
  
```

#### ① VIDEO SOURCE:

Displays the current video source being selected with the function selector **TV, DVD, VCR1, DSS** or **AUX**.

#### ② AUDIO SOURCE:

Displays the current audio source being selected with the function selector **FM, AM (MW, LW), CD, TAPE, CD-R, TV, DVD, VCR1, DSS** or **AUX**.

#### ③ DIGITAL INPUT:

Displays the digital input that you are using **DIG-1, DIG-2, DIG-3, DIG-4** or **DIG-5**.

#### ④ SURROUND MODE:

Displays the current surround mode

**AUTO, STEREO, 6CH STEREO, VIRTUAL, MATRIX, STADIUM, HALL, MOVIE, CS5.1, 6.1 CH SURR, PLO LOGIC, PLII MUSIC, PLII MOVIE, DTS**

#### ⑤ MULTI ROOM

Displays the current status of the Multi Room function, ON or OFF.

#### ⑥ MASTER VOLUME

Displays the current volume level.

The volume level is higher at the right of the display.

#### Note:

The On-Screen Display signals for the main room can be output from the TV MONI composite video (RCA) output and the TV MONI, S-Video and TV MONI component video output jacks.

With some video equipment or software, the On-Screen Display characters may be distorted due to noise or tracking adjustment error.

## 2. FUNCTION SELECT & SURROUND MODE

When a function selector button or surround mode button is pressed  
**VIDEO:** Displays the current video source. When TV, DSS, DVD, VCR1 or AUX is selected with the function selector, both AUDIO and VIDEO shows the same name.

**AUDIO:** Displays the current analog audio input source.

**DIGITAL:** Displays the current digital input source.

**SURR-MODE:** Displays the current Surround mode as follows;

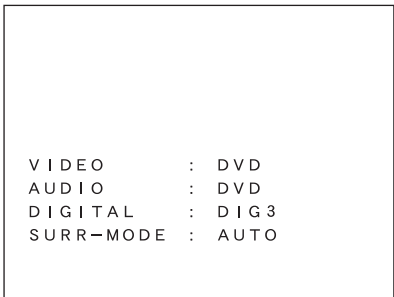
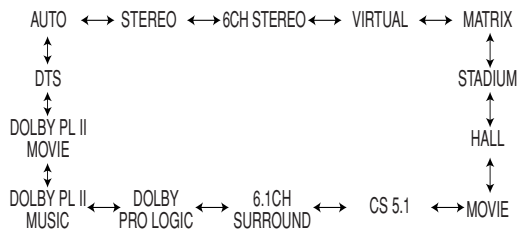

## 3. MASTER VOLUME CONTROL

Displayed when the MASTER volume is varied or a button of the remote control unit is pressed.

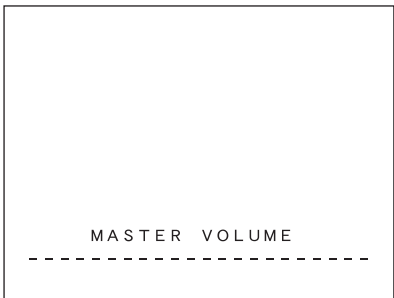

## 4. MUTE

When the MUTE button (12/13) is pressed, "MUTE ON" will be shown on screen.

Pressing MUTE button (12/13) again will show "MUTE OFF" on screen, and return to the previous volume level.



## 5. SLEEP TIMER

When the SLEEP button (9) is pressed, the setting on or off and the remaining time of the sleep timer function are displayed.

You can change the mode between on, off and the amount of time to elapse before the unit will shut itself off by cycling the SLEEP button (9).



## 6. OSD OFF

When OSD button (17) is pressed, OSD system will be bypassed after 3 seconds.

Then there is no indication on the TV display.

Press the OSD button (17) again to activate the OSD.

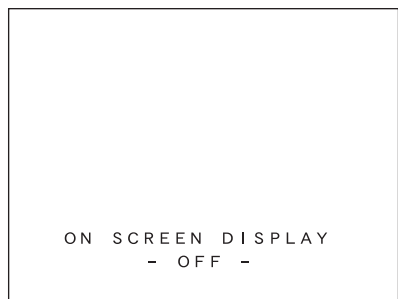

# REMOTE CONTROL UNIT RC7200SR

## MAIN FEATURES & FUNCTIONS

### • PROGRAMMABLE LEARNING FUNCTION

Can easily be programmed to learn the codes for almost any other infrared-based remote, allowing the remote control functions for many different components to be consolidated conveniently in a single unit.

### • PRESET CODES

Function buttons already contain preset codes (using the RC-5/RC-6 remote control language) for other remote-controllable Marantz audio-visual component.

### • LUMINOUS BUTTONS

The remote controller uses luminous buttons which store light allowing it to be used even in the darkened.

### • LARGE, EASY-TO-READ DISPLAY

Large LCD (liquid crystal display) messages and other information at a glance.

### • JOG DIAL

The function selected by Jog Dial (displayed on the LCD) can be operated directly by the enter button.

### • MACRO CAPABILITY

Macro function allows the remote controller to be programmed to execute complex strings of multiple commands using a single keystroke.

### • NAME ASSIGNMENT

Allows one to change the (displayed via the LCD) name for a function button.

## NAMES OF PARTS & FUNCTIONS

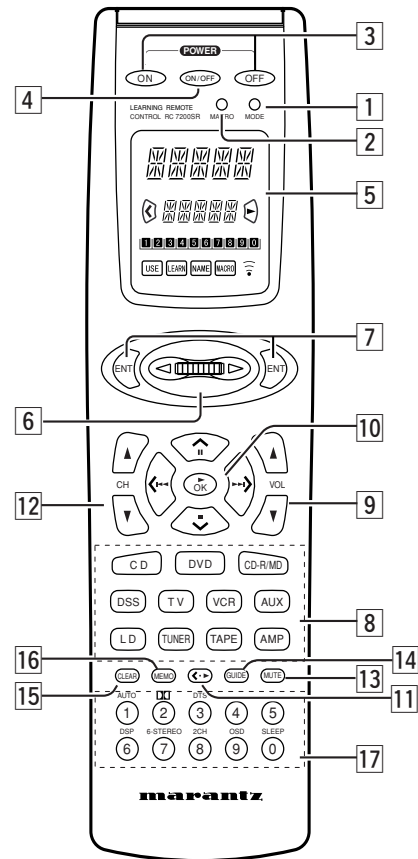

## Names of Buttons & Functions

### 1 MODE button

Used to change the operation mode of the remote controller. Pressing this button cycles the remote controller through **USE** → **LEARN** → **NAME** → **USE**, with the currently selected mode displayed on the LCD.

### 2 MACRO button

Used to switch the remote controller in and out of the MACRO mode, which is used to program complex operational sequences (macros), with the currently selected mode displayed on the LCD.

### 3 Power ON and OFF buttons

Used to turn the main system component (usually a preamplifier or receiver) ON and OFF.

### 4 Source ON/OFF button

Used to turn specific sources (such as DVD players, etc.) ON and OFF independently from the rest of the system.

### 5 LCD

Used to display information about currently selected modes and functions.

### 6 Jog Dial

Used to select the operation content for each source. 10 types of direct operation are possible for each of the 11 functions including DVD, TV, AMP, etc. After selecting the desired function, press either of the **ENT** button 7 to transmit the signal.

## 7 ENT buttons

Used to execute a function selected with the **Jog Dial** 6. There are 2 **ENT** buttons, one on each side, so that the remote controller can be used just as easily with either hand. The characters on the display can also be programmed.

## 8 Function buttons

Used to switch the remote controller to the command sets for specific sources (amplifier, receiver, etc.), thereby allowing a single remote controller to control up to 11 different components. To use these buttons to switch the amplifier's source, press the desired button twice within 2 seconds. The **AMP** button 8 is used only to switch command set of the remote controller itself and therefore does not transmit any signal. Further, the function buttons may also be programmed to execute macros. (A macro allows a complex string of operations to be performed in series simply by pressing a single button.) One button can be programmed to learn sequences containing up to 10 commands. The following is an example of such a sequence that can be activated automatically using a macro:

Turn the receiver ON → Switch the function to DVD → Set the Surround Mode to Dolby Digital → Switch the TV to video input → Set the DVD player to Play.

## 9 VOLUME ▲ up / ▼ down buttons

Used to adjust the volume on receivers and other components equipped with volume control.

## 10 CURSOR/TRANSPORT CONTROL buttons

Used to operate on-screen and other displays used by receivers and other components, as well as to operate the PLAY, STOP, PAUSE, NEXT, and PREVIOUS functions of each source.

## 11 <•▶ (CURSOR/ TRANSPORT CONTROL switching) button

Used to switch the function of the CURSOR/ TRANSPORT CONTROL buttons 10 between the CURSOR and TRANSPORT CONTROL functions, with the currently selected function displayed on the LCD when the DVD or VCR functions are selected. When functions other than DVD or VCR are selected, the <•▶ button remains inactive.

## 12 Channel ▲ up / ▼ down buttons

Used to controls the up/down function of tuner, or allows one to cycle through the tuner presets.

## 13 MUTE button

Used to temporarily mute the sound for amplifiers, receivers, etc.

## 14 GUIDE button

Used to call up the on-screen menus used to control DVD players, digital satellite systems (DSS), and other menu-equipped systems.

## 15 CLEAR button

Used to clear the contents of memory or programmed functions.

## 16 MEMO button

Used to program your CD player's track memory, or to enter a VCR recording program, and can be used to provide the MEMO function included with other components in your system.

## 17 Ten-Key pad/Surround Mode buttons

Used to enter numeric digits, useful for finding a specific track on a CD, or to tune a preset radio station, etc. When the function is set to AMP, it is possible to choose Surround Mode, etc.

## 18 Infrared Transmitter/Receiver Window

Used to transmit remote control signals based on beams of infrared light to system components. To ensure that these signals are properly received, make sure that this window is pointing in the general direction of the infrared receiver on the amplifier or other components. This window should also be pointed toward the source remote controller when using Programmable Learning function.

### Note:

The **MODE** 1, **MACRO** 2, and <•▶ (CURSOR/TRANSPORT CONTROL switching) 11 cannot be programmed.

## LCD (Liquid Crystal Display)

Information about currently selected functions and modes is displayed on the LCD. Pressing any buttons will call up a full display of information on the status of that function or mode. This display will disappear after approximately 1 minute, except for the **Function Name** indicator @, which is always displayed.

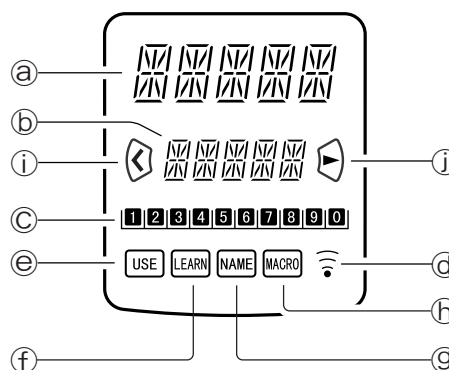

### a Function Name indicator

Displays the name of the currently selected function (DVD, TV, etc.) using up to 5 characters.

### b Command Name indicator

Displays up to 10 types of commands for each function using up to 5 characters.

### c Command Page indicator

Allows confirmation of current command page. Also, when setting or transmitting macros, displays information such as the number of macro steps and the time intervals between command transmissions.

### d Transmission indicator

Indicates when the remote controller is transmitting a signal.

### e USE indicator

For normal operation the USE indicator is displayed.

### f LEARN indicator

Indicates when the remote controller is in the LEARN mode.

### g NAME indicator

Indicates when the remote controller is in the NAME mode and a function name is being changed.

### h MACRO indicator

Indicates when the remote controller is in the MACRO mode.

### i CURSOR indicator

Indicates when the CURSOR/TRANSPORT CONTROL button is in the cursor mode.

## ④ CONTROL indicator

Indicates when the ◀ • ▶ (CURSOR/TRANSPORT CONTROL switching) ① is in a transport control mode such as PLAY, STOP, etc.

- If the LCD flickers when a button is pressed in order to transmit a command or when in the LEARN mode, the transmission or learning is not possible. In such a case, please replace the batteries.
- This remote controller uses non-volatile memory, so that learned codes and macros will be preserved even if the batteries are removed.

## BASIC OPERATION

### USE MODE

The remote controller will normally be used in the USE mode. It comes preset with codes commonly used to control 11 types of components manufactured by Marantz and Philips, including DSS, DVD, TV, LD, VCR, AUX, TUNER, CD, TAPE, CD-R/MD, and AMP, as well as many others that utilize the RC-5 remote control language.

1. Press once one of the **Function** buttons ⑧ to change to another component's commands, such as DVD button.

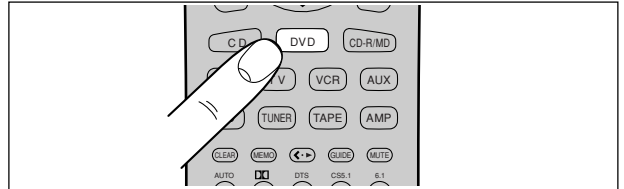

2. **DVD** will be displayed on the LCD and the function codes will be set to operate the DVD player, and if you double clicked the DVD function button, the preamplifier or receiver's input will be changed as well.
3. Now you can operate the DVD player. When a button is pressed, the ⑨ symbol indicates that a remote code is being transmitted. ⑨ is not displayed if a button for which no code has been set is pressed.
4. The **Jog Dial** ⑥ is used to select any one of up to 10 direct operations that can be performed for each of the 11 functions (DVD, TV, AMP, etc.). Rotate the **Jog Dial** ⑥ to select one of these commands. The number of the current page is indicated by ① - ⑩. Page numbers cycle up or down, for example ⑧ → ⑨ → ⑩ → ① → etc. or ⑧ → ⑦ → ⑥ → ⑤ → ④ → ③ → ② → ① → ⑩ → etc. depending on which way the **Jog Dial** ⑥ is rotated.

The last page position for any given command function is retained in the memory even if the remote controller is switched to the command function for another component. (Last Memory)

If it is left for approximately 1 minute without pressing any buttons, all items on the LCD will go off except the function indicator.

Even if the display goes off, the remote controller will hold the page position and other data. The display may be activated again by pressing any button.

### LEARN MODE

The remote controller is capable of learning and memorizing the remote control codes used by almost any other remote controller you may already own.

- If no commands have been programmed for a particular function button, the remote controller will transmit whatever codes have been factory preset.
- The following example shows how to program your remote controller and how to use the codes for a DVD player.
- The remote controller infrared receiver is located at the top of the remote controller.

1. Use a ballpoint pen or other sharp point to press the **MODE** button ① until the **LEARN** indicator is displayed. Each time you press this button, the mode will cycle through **LEARN** → **NAME** → **USE**. Stop when the **LEARN** indicator starts to blink.
2. Place the DVD's remote controller so that its infrared signal transmitter is facing the infrared signal receiver on the Marantz remote controller at a distance of about 5 centimeters (2 inches).

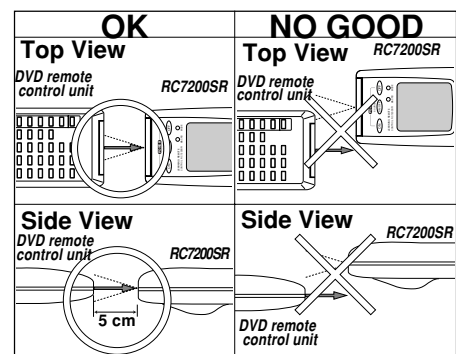



3. Press the **DVD Function** button [8].

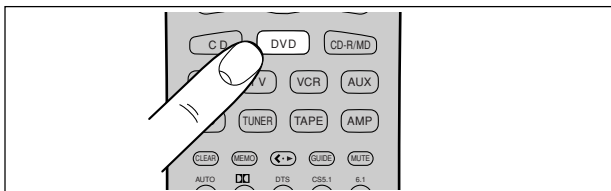

4. Press the **PLAY** button [10] (▶ OK). The **LEARN** indicator changes from blinking to continuously lit.

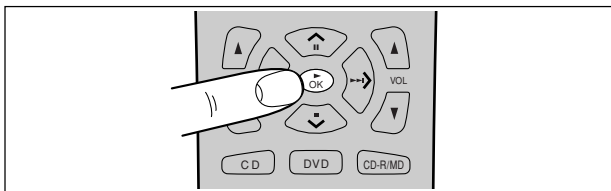

5. Press and hold the **PLAY** button on the DVD player's remote controller. The remote controller has finished learning the command when **OK** appears on the LCD [10].

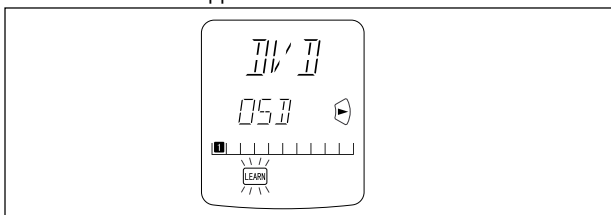

- If **AGAIN** appears on the LCD, some error has prevented the command from being learned. If this happens, simply repeat the procedure from step 4.
  - In the rare event that **NG** appears on the LCD, it means that the remote controller you are attempting to learn from uses special signals that cannot be learned by the Marantz remote controller.
6. Follow the same procedure to make the remote controller learn the ten-key [17] operation used by the DVD player's remote controller.
  7. Repeat the procedure from step 3 to have the remote controller learn the signal codes for the other components such as TV, VCR, etc.
    - If no buttons are pressed for approximately 1 minute while in the LEARN mode, the remote controller automatically returns to the USE mode.
    - When programming the function buttons, first switch to the desired function, then press the button again.
  8. When you have finished programming the remote controller, use a ballpoint pen or other sharp point to once again press the **MODE** button [1] to return it to the USE mode. The LCD displays the **USE** indicator, and the newly programmed codes now can be used.

**If FULL is displayed on the LCD**

If **FULL** is displayed on the LCD [10] when programming in the LEARN mode, it means that the memory has become too full to hold any further codes.

If **FULL** is displayed no matter how many times you attempt to enter new codes, it means that the remote controller cannot accept any new codes until some of the previously learned codes are deleted to make space in the memory. Select unneeded codes for each of the **Jog Dial** control [6] and **Function** buttons [8], which show **FULL** and delete them from the memory.

**Note:**

The power **ON** and **OFF** buttons [3] can only be programmed to learn one type of code, regardless of the function button that has been selected.

**PROGRAMMING THE JOG DIAL**

Let's use the example of setting [2] as the **TITLE** code for the DVD player.

1. Use a ballpoint pen or other sharp point to press the **MODE** button [1] until the **LEARN** indicator is displayed and starts to blink.
2. Place the DVD player's remote controller so that its infrared transmitter window is facing the infrared signal receiver window on the Marantz remote controller at a distance of about 5 centimeters (2 inches).
3. Press the **DVD Function** button [8].
4. Rotate the **Jog Dial** [6] left or right until [2] is displayed, then press the **ENT** button [7].
  - The **LEARN** and **NAME** indicators will both be displayed.

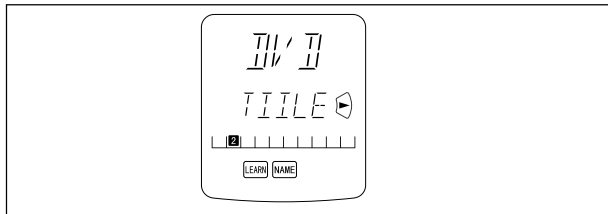

5. Press the **TITLE** button on the DVD player's remote controller continuously until **OK** is displayed on the Marantz remote controller's LCD, indicating that the programming has been completed.
  - If **AGAIN** appears on the LCD, some error has prevented the command from being learned. If this happens, simply repeat the procedure from step 4. When the programming has been completed, the remote controller automatically switches to the **NAME** mode. The left hand position on the LCD [10] blinks, indicating the character in the name to be rewritten.

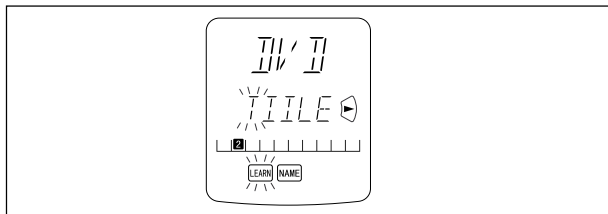

- If you do not wish to rewrite the name, simply press the **OK** Cursor button [10].
  - If you wish to rewrite the name, input the desired characters using the ten-key pad [17]. The part of the display that is being rewritten may be selected using the < and > Cursor buttons [10]. When you are finished rewriting, press the **OK** Cursor button [10]. To simply erase already existing characters, press the 0 button to replace them with a blank space. (Refer to next section on rewriting names)
6. Use the same procedure to program the codes for other 1-6 with the **Jog Dial** [6].
  7. When finished programming the codes for each of the buttons, use a ballpoint pen or other sharp point to press the **MODE** button [1] to return the remote controller to the USE mode. Once **USE** is displayed on the LCD, the newly memorized codes are available for use.

**REWRITING NAMES**

This remote controller allows the names accessible by **Jog Dial** control [6] to be rewritten with new ones of your choosing.

- Rewriting of names is performed for each individual function.
- Let's use a DVD player as an example to show how to change the [1]'s "OSD" to "F-OSD".

1. Use a ballpoint pen or other sharp point to press the **MODE** button [1] to switch the remote controller to the NAME mode. The **NAME** indicator blinks.
2. Press the **DVD Function** button [8].

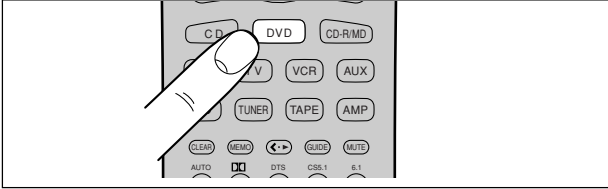

3. Use the **Jog Dial** [6] to select the page for which you wish to enter a new name.
4. The character on the left-hand side of the Command Name indicator on LCD [6] will flash, indicating that it is the character ready to be rewritten. New characters entered will be written over the top of the current character so that the current character is erased. Use the < and > Cursor buttons [10] to select the characters to be rewritten.

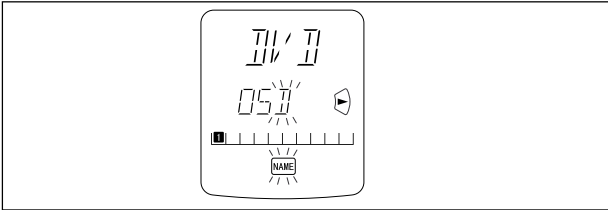

5. Use the ten-key pad [17] to select the desired alphanumeric characters. Pressing the number buttons on the ten-key pad will cycle through the alphanumeric characters as follows:

Ten keypad	Press, press again, press again, etc.
1	A → B → C → 1 → A
2	D → E → F → 2 → D
3	G → H → I → 3 → G
4	J → K → L → 4 → J
5	M → N → O → 5 → M
6	P → Q → R → 6 → P
7	S → T → U → 7 → S
8	V → W → X → 8 → V
9	Y → Z → / → 9 → Y
0	SPACE → + → - → , → ' → 0 → SPACE ( )

6. For example, to enter the letter "F", press the 2-key on the ten-key pad [17] 3 times in a row to cycle from D to E to F.

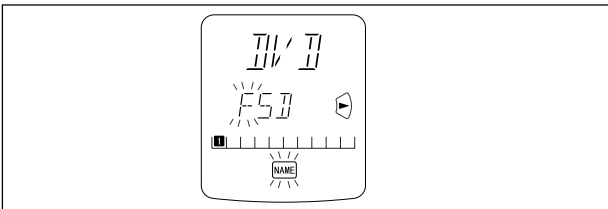

Once the desired character "F" appears, press either of the < and > Cursor buttons [10] and the "F" will be permanently written over the former character. Press the 0-key in order to replace unneeded extra characters with spaces.

7. Follow the same procedure to enter "OSD". When finished, press the **OK** Cursor button [10]. Pressing **OK** permanently fixes the newly written characters.

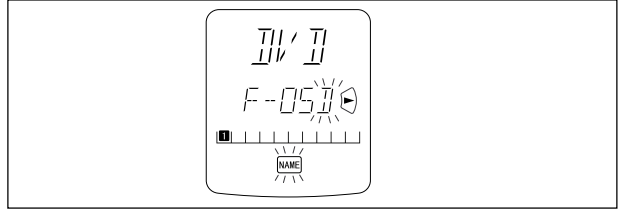

- Up to 5 alphanumeric characters may be entered in the Command Name indicator of the LCD.
  - To rewrite the names of the other items in the Command Name indicator, use the **Jog Dial** [6] to select the desired command and repeat from step 5.
8. When you are finished rewriting, use a ballpoint pen or other sharp point to press the **MODE** button [1] to return the remote controller to the USE mode. The **USE** indicator is displayed on the LCD, and the newly programmed codes now can be used.

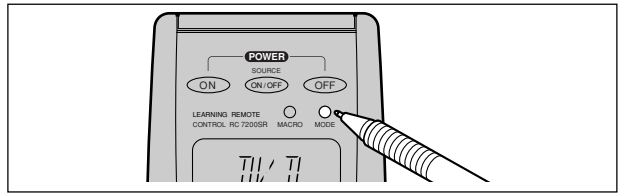

**ERASING PROGRAMMED CODES**

**(Returning to Factory Presets)**

Codes that have been programmed into the memory can be erased in 4 ways: by button(s), by function(s), by Jog Dial command, and by erasing all memory contents.

1. Use a ballpoint pen or other sharp point to press the **MODE** button [1] to switch the remote controller to the LEARN mode, so that the **LEARN** indicator is blinking on the LCD.

**Note:**

Erasing of programmed codes is only possible in the LEARN mode.

**2. Erasing by Button(s)**

To erase the codes and names programmed for any button, press and hold the **CLEAR** button [15], then press the button to be erased twice. This will return the button to its factory presets or leave it empty if no factory presets are available.

Jog Dial codes may be erased in the same way, by pressing and holding the **CLEAR** button [15] while using the **Jog Dial** [6] to call up the command to be erased, then pressing one of the **ENT** buttons [7] on either side of the **Jog Dial** [6] twice. This will return the button to its factory presets or leave it empty if no factory presets are available.

To erase codes programmed for the **CLEAR** button [15], simply press the **CLEAR** button [15] continuously for 3 seconds.

As an example, let's clear the PLAY command from the DVD player command set.

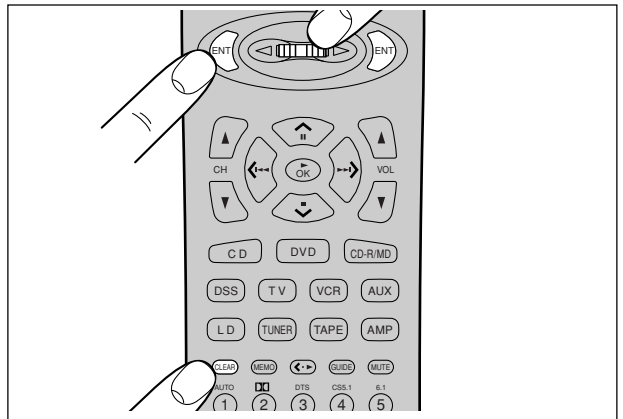

### 3. Erasing Jog Dial Codes

To clear all codes and names previously set for each of the functions (DVD, TV, etc.).

- 1) Press the function you want to erase.
- 2) Hold down the **CLEAR** button [15] and press both **ENT** buttons [7] at the same time. LCD [6] will display **CLR?**.

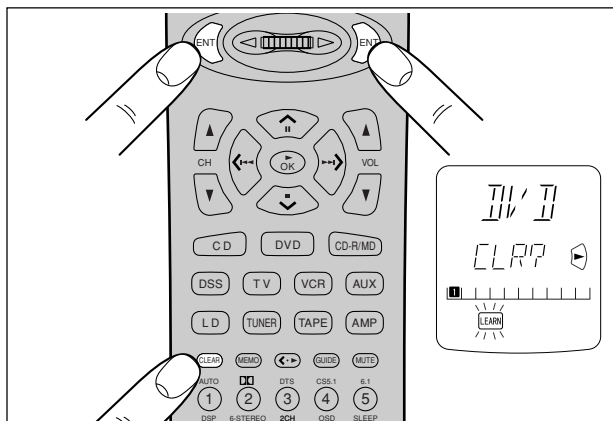

- 3) If you wish to continue the clearing operation, press the **OK** Cursor button [10]. This will return all 10 commands in the Jog Dial to their factory presets, or leave them empty if no factory-presets are available. Accordingly, the LCD [6] will return to the factory preset displays, or will simply be empty.

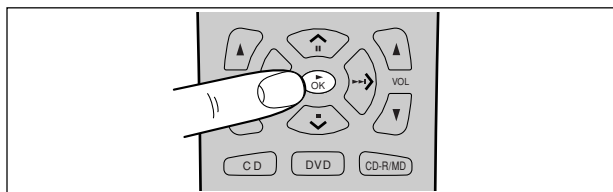

- Use a similar operation to erase the Jog Dial codes for each function.
- To cancel the memory clearing operation, do not press **OK** Cursor button [10] and simply touch any other button.

### 4. Erasing Codes by Function

To clear all codes and names previously set for each of the functions (DVD, TV, etc.), press and hold the **CLEAR** button [15], then press the button for the function to be cleared twice. **CLR?** will appear on LCD [6]. If you wish to continue the clearing operation, press the **OK** Cursor button [10].

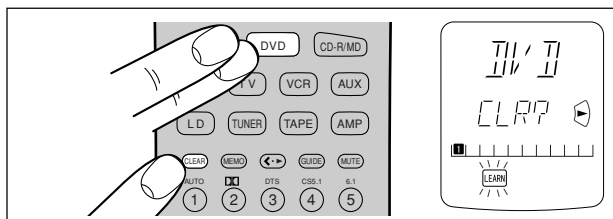

This will return the button to its factory-presets or leave it empty if no factory presets are available. Accordingly, the LCD [6] will return to the factory preset displays, or will simply be empty.

- To cancel the memory clearing operation, do not press the **OK** Cursor button [10] and simply touch any other button.
- The codes for the <•▶ button [11] cannot be cleared.

### 5. Erasing All Memory Contents

To clear all the memory contents and reset all codes and names to their factory presets, press and hold the **CLEAR** button [15], and press both the power **ON** and **OFF** buttons [3] simultaneously. **ACLR?** will appear on LCD [6].

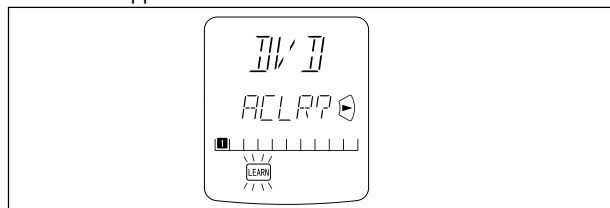

If you wish to continue the clearing operation, press the **OK** Cursor button [10].

This will return the entire memory to its factory-presets, or leave it empty for items for which no factory presets are available. Accordingly, the LCD will return to the factory-preset display or will simply be empty.

- To cancel the memory clearing operation, do not press the **OK** Cursor button [10] and simply touch any other button.

After the **OK** Cursor button [10] is pressed, clearing the entire memory will take approximately 5 seconds.

### PROGRAMMING MACROS

Macros make it possible to use a single function button to perform more complex series of operations that would normally require pressing several buttons. A single button can be programmed to perform up to 10 steps in sequence. A typical example of such a series might be as follows:

- Turn the main amplifier power ON → Switch the function to DVD → Set the Surround Mode to Pro Logic → Switch the TV to video input → Set the DVD player to PLAY.
- No signals may be transmitted during macro programming.
- The various steps that make up a macro are set initially to be sent one after another in 1 second intervals, however these intervals may be shortened to as little as 0.5 seconds or lengthened to as much as 5 seconds using the Setup mode.
- In the macro mode, the number of steps the macro contains is displayed on LCD [6]. Macros may be programmed for each of the 11 function buttons, from DVD to AMP.

1. Use a ballpoint pen or other sharp point to press the **MACRO** button [2] until the **MACRO** and **LEARN** indicators are displayed blinking on the LCD.

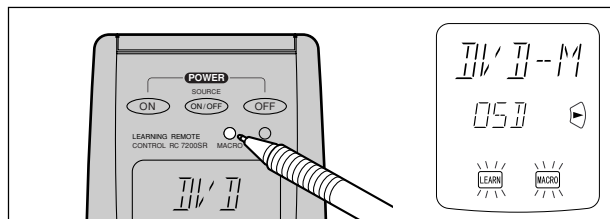

2. Press the **Function** button [8] for which you wish to program a series of operations. In this case, let's use the example of the DVD player.

Press the **DVD Function** button [8]. The LCD [6] will display DVD-M.

Characters displayed on LCD [6] include the following, depending on the function button for which the macro is being programmed: LD-M, DVD-M, TV-M, DSS-M, VCR-M, AUX-M, TUN-M, CD-M, TP-M, AMP-M, CDR-M (or MD-M for remote controller set for MD).

- If a macro has already been set for the selected function button, the LCD [6] will blink. Also, the number of steps in the macro is displayed on LCD [6].

- Press the buttons for the operations you wish to program as a macro in the sequence you want the macro to program them. The name of the button pressed appears on LCD ④. The number of steps in the macro is displayed on LCD ③ and this number increases by 1 with each button pressed.

For example, press DVD, PLAY.

Each function button can be programmed to perform up to 10 steps in sequence.

- If, while programming, no buttons are pressed for approximately 1 minute, the remote controller will automatically return to normal mode, and no macro will be programmed in the memory.

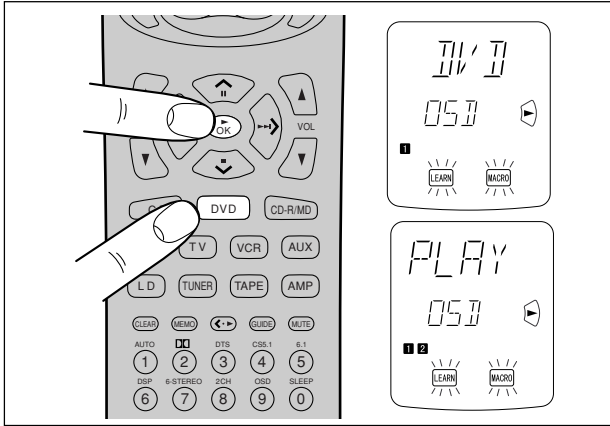

- When you are finished programming macros, use a ballpoint pen or other sharp point to press the **MACRO** button ②. LCD ④ will display **END**, and the display will return to normal.

- Macros cannot be programmed for the **MODE** ①, **MACRO** ②, **< >** ⑪, **VOL ▲/▼** ⑨, **MEMO** ⑫ or **CLEAR** ⑮ buttons.

In the macro mode it is possible to program the memory to perform macros containing up to 10 steps.

Each of the function operations (11 including CD, CD-R, etc.) can be used in a macro more than once, however for all except AMP, only the first function operation will be transmitted as a signal from the remote controller. Accordingly, within a single macro, it is not possible to switch between multiple function operations. (This is to prevent the switching of the receiver function operation.) Within a macro, the second time a function operation is used, it will only be used on the remote controller itself and no signal will be transmitted to the component.

- While pressing the **VOL ▲** button ⑨, use the **▲** and **▼** Cursor buttons ⑩ to call up the portion of the macro to be changed. Pressing the **▲** button advances through the macro steps and pressing the **▼** button regresses through the macro steps.

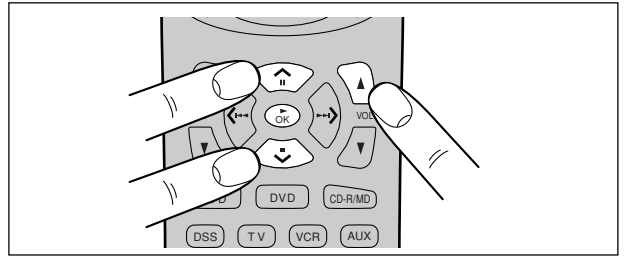

- To rewrite an existing macro step, simply press the button for the new step. The old step will be erased and rewritten with the new step.
- To insert a new step in between existing steps in a macro, after step 3 press the **MEMO** button ⑫, then press the button for the new step. The numbers of the other steps will be adjusted accordingly to accommodate the new step. Since only 10 steps may be stored in any macro, the tenth step will be erased if an step is inserted when the total number of steps is already 10.



- To erase a step in a macro, after step 3 call up the number of the step to be erased and press the **CLEAR** button ⑮.

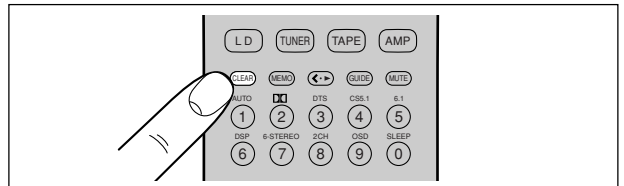

- If while editing macros no buttons are pressed for approximately 1 minute, the remote controller will automatically return to normal mode, and no macro changes will be programmed in the memory.

- When you are finished editing macros, use a ballpoint pen or other sharp point to press the **MACRO** button ②. **END** will be displayed on LCD ④ and the display will return to normal.

## EDITING MACROS

Macros may be edited using following procedure.

- Use a ballpoint pen or other sharp point to press the **MACRO** button ② until the **MACRO** and **LEARN** indicators are displayed blinking on the LCD.
- Press the **Function** button ⑧ to be changed. Let's use the example of the DVD player, by pressing the **DVD Function** button ⑧.
  - DVD-M** is displayed blinking on LCD ④.
  - The number of steps in the completed macro is highlighted on LCD ③. In this example there are 3 macro programs in memory.

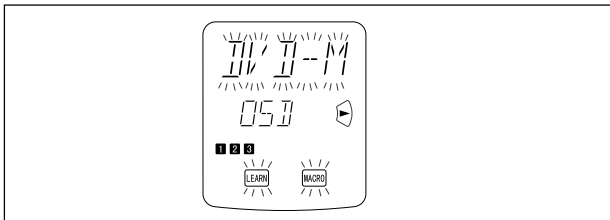

The ① is highlighted if no macros have been programmed, and the remote controller is ready for macro programming.

## USING MACROS

The following procedure will show how to use the function buttons for which you have programmed macros.

- Press the **Function** button ⑧ for the desired macro for 3 seconds. **MACRO** is displayed on LCD ④ for approximately 1 second, after which the number of steps in the macro is displayed on LCD ③.

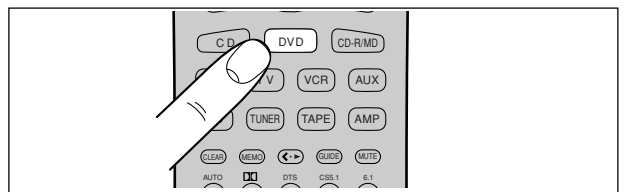

- The remote controller will do nothing if no macros are programmed. The macro steps are executed in order and the names of their buttons are displayed on the LCD. Also, the step numbers displayed on LCD ③ disappear as each step is executed.
- After all macro commands have been transmitted, the remote controller returns to normal mode.
    - To cancel the transmission of a programmed macro, use the Cursor buttons ⑩ to press ■.

**EXAMPLES OF MACRO PROGRAMS**

**Example 1**

Change the input source for the amplifier to CD and play the 3rd track on a CD in the CD player.

1. Use a ballpoint pen or other sharp point to press the **MACRO** button [2], then press the **CD Function** button [8]. CD-M is displayed on the LCD.

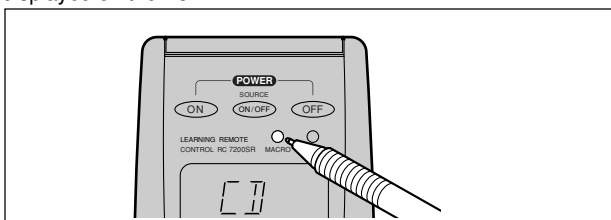

2. Press **CD** [8], **3** [17], and **▶** [10] buttons.

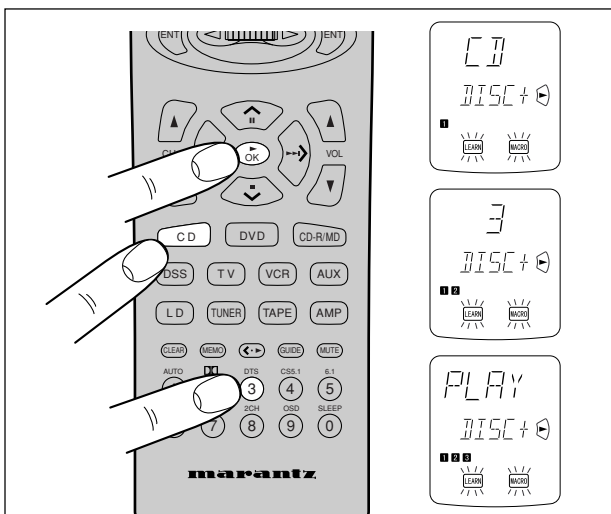

When you are finished programming the macro, use a ballpoint pen or other sharp point to press the **MACRO** button [2].

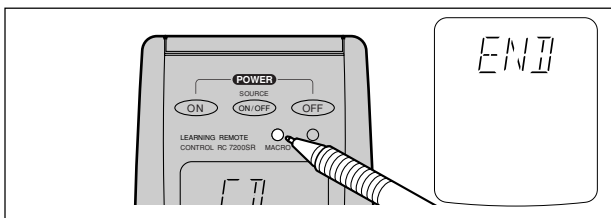

**Now, execute the macro you just programmed.**

1. Press the **CD Function** button [8] for 3 seconds.

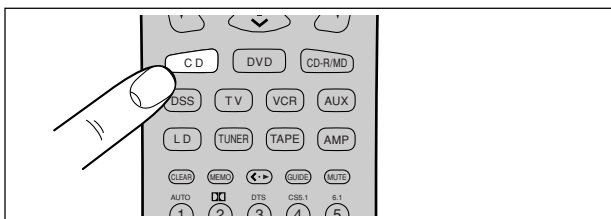

2. The macro commands are transmitted to the components in order, and the names of the operations being performed are displayed on the LCD in order.

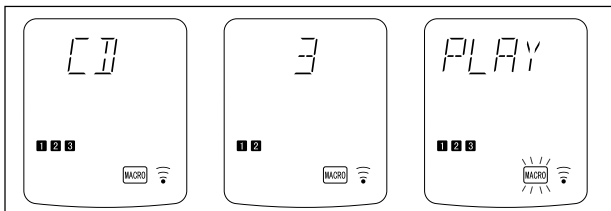

**Example 2**

Turn the main amplifier ON → Change the amplifier's input source to DVD → Set the Surround mode to DOLBY → Switch the TV to video input → Set the DVD player to PLAY

1. Use a ballpoint pen or other sharp point to press the **MACRO** button [2].

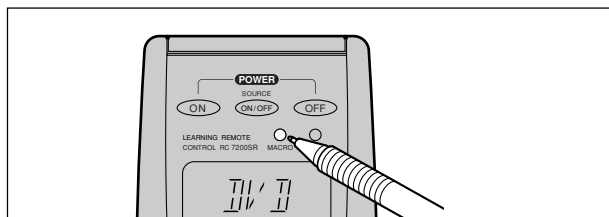

2. Press the **DVD Function** button [8].
  - Here the **DVD Function** button [8] is used as the macro button, but any function button can in fact be used.
3. To set the various steps of the macro, press the following buttons in order: **POWER ON** [3], **DVD** [8], **AMP\*** [8], **2 (DOLBY)** [17], **TV\*** [8], **VIDEO** (use **Jog Dial** [6] to select VIDEO and press **ENT** button [7]), **DVD\*** [8], **▶** [10].
4. When you are finished programming the macro, use a ballpoint pen or other sharp point to press the **MACRO** button [2]. The remote controller returns to normal mode.

**Now, execute the macro you just programmed.**

1. Press the **DVD Function** button [8] for 3 seconds. The macro commands are transmitted in order, and the names of the operations being performed are displayed on LCD @ in order.

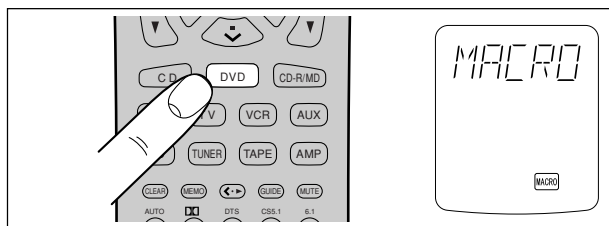

- When executing this macro, function operations AMP\*, TV\*, and DVD\* only switch the command set of the remote controller and no signal is transmitted to the component.
- To cancel the transmission of a programmed macro, use the **Cursor** buttons [10] to press ■.

**CLEARING MACRO PROGRAMS**

The following procedure is used to erase macros you have programmed into the remote controller's memory.

1. Press and hold the **CLEAR** button [15], then the button for the **function** [8] to be cleared (in this case DVD) for 3 seconds. **DVCL?** will appear on LCD @. If you wish to continue the clearing operation, press the **OK** Cursor button [10].

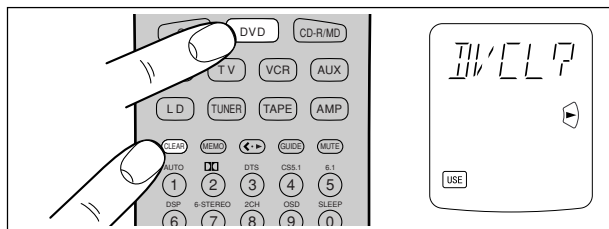

- To cancel the memory clearing operation, do not press **OK** Cursor button [10] and simply touch any other button.

## OTHER FUNCTIONS

### LUMINOUS BUTTONS

The buttons on this remote controller are designed to remain luminous in dim lighting conditions. If the buttons are no longer luminous when the remote controller is used in low light, recharge them by placing it near a fluorescent or other light source for a sufficient amount of time. This should return the buttons to their luminous condition.

### SETUP

Switch the RC-5 destination or adjust the time interval between transmissions of macro operations as follows:

1. While pressing the **MEMO** button [16], press the **OK** Cursor button [10]. This will switch the remote controller to the Setup mode.

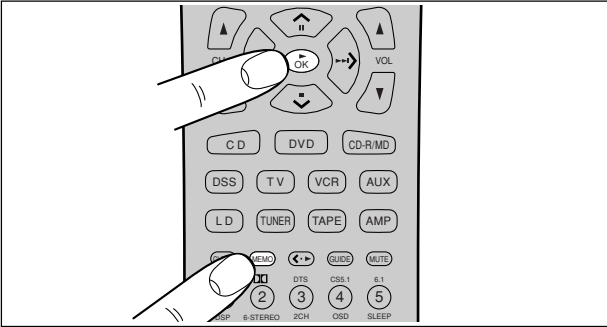

The Setup mode includes the following items, which may be accessed using the **^** and **v** Cursor buttons [10].

- Switch destination (version) (VER)
- Adjust time interval between transmissions of macro operations (MACRO)

**VER:** Switches the type of preset codes contained in the remote controller .

LCD ① displays **VER**, while LCD ② displays either **USA** or **REST**. **USA** means that the **CD-R/MD Function** button [8] is set to CD-R. **REST** means that the **CD-R/MD Function** button [8] is set to MD.

Use the **<** and **>** Cursor buttons [10] to select the desired version, then press the **OK** Cursor button [10]. This will finish the operation and return the LCD to its original state.

- To cancel the setting, press any button other than the Cursor buttons [10].
- To continue the setting, press the **v** Cursor button [10].

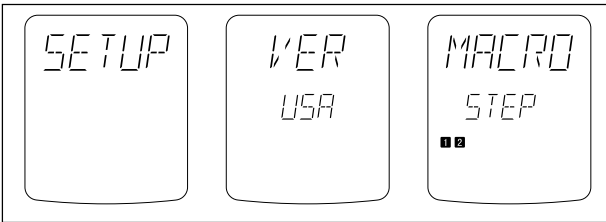

#### Note:

Codes that have been programmed will not be erased even if the VER setting is changed, however the **NAME** indicator displays associated with the Jog Dial command will be changed. Also, the Jog Dial commands for CD-R/MD functions that are contained within macros will also change.

**MACRO:** Adjusts the time interval between transmissions of macro operations

When the **v** Cursor button [10] is pressed, LCD ③ displays **MACRO**, while LCD ④ displays **STEP**.

One square (■) in LCD ④ is equivalent to an interval of 0.5 seconds, allowing intervals of up to 5 seconds to be set. The remote controller is set at the factory with an interval of 1 second, as indicated by (■□□□□□□□□□). Adjust the interval between transmission of operation codes using the **^** and **v** Cursor buttons [10], then press the **OK** Cursor button [10].

- To cancel the setting, press any button other than the Cursor button [10].
- To continue the setting, press the **v** Cursor buttons [10].

## BATTERY LIFE

- New batteries will last about 4 months assuming an average of 30 uses per day.

#### Note:

The batteries shipped with the remote controller are for the purpose of checking function and may not last as long as new batteries.

## NUMBER OF LEARNABLE CODES

The remote controller (RC7200SR) uses 128-Kbyte large-capacity non-volatile memory (EEPROM) and is therefore capable of learning a maximum of 330 remote control codes. This applies only to Philips RC-5 remote programming language codes, however, and depending on the type of other codes that are programmed, the remote controller can learn less than 330 codes.

## JOG DIAL COMMAND FUNCTIONS LISTING

Each of the 10 Jog Dial commands on the LCD has 5 character labels attached for pre-programmed remote commands. These commands can be used with various Marantz A/V components, or other components using the Philips RC-5 remote control language.

You can easily replace the factory-supplied remote command codes with different codes from other brands of component. Most of the supplied functions apply to a wide variety of component from many companies. The following list shows the remote code assignments for the Jog Dial commands, for each of the 11 Function buttons, as supplied from the factory. You can add or replace Jog Dial commands, including re-naming them if you wish, in order to customize the remote controller for your own particular selection of A/V components.

Function	Jog Dial command	Note
AMP	1 A/D 2 ATT 3 NIGHT 4 MR-ON 5 MR-OFF 6 7-DIR 7 TRB+ 8 TRB- 9 BAS+ 0 BAS-	switches analog/digital input switches attenuator for analog input selects NIGHT mode for Dolby Digital turns multi-room mode on turns multi-room mode off activates 7-channel input increases treble decreases treble increases bass decreases bass
TUNER	1 FM 2 AM 3 LW 4 T-MOD 5 SCAN ⊗ 6 STM 7 F-DIR 8 PTY 9 DISP ⊗ 0 DWR	FM band AM/MW band Long Wave band mono/stereo mode selector programmed preset channel scan selects station mode inputs a frequency directly selects PTY function selects display function selects DSR wave range
TV	1 A/CH 2 100S 3 VIDEO 4 INFO 5 S-PIC 6 S-SND 7 S-CH 8 ADV 9 OSD 0 MENU	alternate channel 100's selects video information smart picture smart sound smart channel advance activates on-screen display menu
CD	1 DISC+ 2 DISC- 3 TEXT 4 SHUFL 5 REPT 6 TRAY 7 AMS 8 TIME 9 FF 0 REW	CD changer next disc CD changer previous disc activates text function shuffle play function repeat function tray open/close automatic music scan time display elapsed/remaining/total fast forward rewind
⊗ LD	1 SID-A 2 SID-B 3 DISP 4 AMS 5 AUDIO 6 RPT-A 7 RPT-B 8 CP/F 9 EDIT 0 D/CX	side A side B display on/off automatic music scan selects audio mode repeat A start point repeat B stop point selects chapter or frame activates edit function selects digital audio/analog audio/CX NR
TAPE	1 TP-A 2 TP-B 3 DIR 4 TIME 5 TRAY 6 AMS 7 REC 8 PAUSE 9 0	selects tape deck A selects tape deck B auto reverse direction time display tray open/close automatic music scan record pause

Function	Jog Dial command	Note
VCR	1 REC 2 SLCT 3 2XPLY 4 SLOW 5 STIL 6 OTR 7 AUDIO 8 SKIP 9 VIS+ 0 VIS-	record selects TV or VCR twice normal playback speed slower than normal playback speed still frame one touch recording audio track selector skip to next program marker VHS index search next VHS index search previous
DSS/V2	1 DISP 2 PREV 3 SELECT 4 AUDIO 5 FAV 6 ALT 7 FTCH 8 ANT 9 REC 0 OTR	brings up on-screen channel marker goes to previously selected channel selects TV or VCR audio track selector favorite users and channel lists alternate audio channel, languages brings up on-screen channel logos select broadcast or cable antenna record one touch recording
AUX	1 No 2 No 3 No 4 No 5 No 6 No 7 No 8 No 9 No 0 No	pre code data pre code data pre code data pre code data pre code data pre code data pre code data pre code data pre code data pre code data
DVD	1 OSD 2 TITLE 3 ZOOM 4 MENU 5 10+ 6 SETUP 7 ANGLE 8 SUB-T 9 RESUM 0 AUDIO	activates on-screen display selects title menu zoom mode on/off selects main menu digit entry +10 selects setup menu selects angle selects subtitle resume function selects audio

### For USA setups

Function	Jog Dial command	Note
CDR	1 INPUT 2 INCR 3 SYNC 4 REC 5 PROG 6 TRAY 7 DISP 8 FINAL 9 BLANK 0 REPT	selects input source increments track number activates SYNCRO. recording records pause activates program mode tray open/close display mode finalizes (writes TOC) records blank activates repeat mode

### For REST setups

Function	Jog Dial command	Note
MD	1 REC 2 REPT 3 RANDM 4 DISP 5 EDIT 6 EJCT 7 LP 8 DEL 9 ENTER 0 SYNC	records pause selects repeat mode random play selects display mode selects edit mode eject selects SP/LP mode selects delete selects enter SYNCRO. recording

The marked "⊗" commands are not used for SR7200.

## SURROUND MODES

The SR7200 incorporates digital signal processors (DSP) which can reproduce various surround effects you experience in concert halls and movie theaters, etc. These Surround Modes, are provided to reproduce a variety of surround sound effects, according to the content of the source to be played.

Surround mode	FEATURES
1. <b>AUTO</b>	When this mode is selected, the receiver determines whether the digital input signal is Dolby Digital, PCM-audio or DTS. <b>Note:</b> When a Dolby Digital or DTS signal is input, the number of channels for which the corresponding signal is encoded will be played. Inputting a Dolby Digital two channel signal with Dolby surround status automatically subjects that signal to Pro-Logic processing before play. 96 kHz source material can be playback in this mode.
2. <b>STEREO</b>	This mode bypasses all surround processing. Stereo program sources the left and right channels play normaly when PCM-audio or analog stereo is input. With Dolby Digital and DTS sources, the 5.1 multi-channels are converted to two channel stereo. 96 kHz source material can be playback in stereo mode.
3. <b>DD</b>  <b>MOVIE</b> <b>MUSIC</b> <b>PRO LOGIC</b>	This mode is used with source materials encoded in Dolby Digital and Dolby Surround. Dolby Pro Logic II brings the excitement of surround sound to any stereo mix, while making existing Dolby Surround mixes sound more like discrete 5.1 channels Surround sound. Dolby Pro Logic II has below 3 modes.  This mode provides 5.1 channel surround sound from Dolby Surround encoded stereo movie sound tracks.  This mode provides 5.1 channel surround sound from conventional stereo sources, analog or digital, such as CD, tape, FM, TV, stereo VCR, etc.  This mode emulated original Dolby Pro Logic decoding (3/1 surround) suit for Dolby Surround encoded stereo movie soundtracks. <b>Note:</b> PCM-audio signals can be subjected to Pro Logic processing when the sampling frequency is 32 kHz, 44.1 kHz or 48 kHz. When a signal in another format is input, output will be muted.
4. <b>DTS</b>	This mode is for DTS encoded source materials such as LASER DISC, CD, and DVD. The DTS mode cannot be used when an Analog input has been selected. When the signal in another digital format is input, output will be muted.
5. <b>6.1CH Surround</b>	This mode reproduces 6.1 channel sound field by extracting the surround center information from surround left and surround right channels. This mode is suited for 6.1 channel encoded material such as Dolby Digital Surround EX and DTS-ES. <b>Note:</b> Dolby Digital 5.1ch and DTS source material can be playback in this mode.
6. <b>MOVIE HALL STADIUM MATRIX</b>	These modes provide surround effect processing from each input source material. They will produce theater, concert hall and stadium like atmospheres. Select as your taste desires. <b>Note:</b> PCM-audio (32 kHz, 44.1 kHz or 48 kHz) and analog source material can playback in this mode.
7. <b>VIRTUAL</b>	This mode create the virtual surround sound with the front right and left speakers. <b>Note:</b> The 96 kHz sampling frequency and DTS source material mutes output.
8. <b>CS5.1</b>	This mode is backward compatible, such that surround sound playback is possible from any stereo or passive matrix-encoded material. Five full-bandwidth, discrete channels of information can be extracted from an enormous library of material not encoded in Dolby Digital or DTS. <b>Note:</b> PCM-audio (32 kHz, 44.1 kHz or 48 kHz) and analog source material can play back in this mode.
9. <b>6CH STEREO</b>	This mode is used to create a wider, deeper and more natural soundstage from two channel source material. This is done by feeding the left channel signal to both left front and left surround speaker and the right channel signal to both right front and right surround speaker. Additionally, the center channel reproduces a mix of the right and left channel. <b>Note:</b> The 96 kHz sampling frequency mutes output.

### Caution for DTS signal:

This signal can be played when the connected DVD-player, laser-disc player or CD-player is capable of DTS-digital output. For details, refer to the player's operation manual.

Depending on the player used, DTS play may produce noise. If that happens, set the Surround mode to DTS.

Playing a DTS-CD or DTS laser disc causes the player's analog output terminal to output noise. Before playing DTS sources, be sure to connect the player's digital output to the SR7200's digital input. Be careful when connecting the output of these players to analog audio input.

Note that the SR7200 has the following restrictive functions built in to reduce noise emission as much as possible.

If DTS is selected while in the Surround mode, digital input cannot be switched to analog input. When the analog input function has been selected, Surround mode cannot be switched to DTS.

While signals from DTS-laser disc or CD are playing in another Surround mode, you cannot switch to digital input or from digital input to analog input.

### Caution for 96kHz PCM-audio signal:

This signal can be played when a DVD-player or DAT-player connected to the SR7200 is capable of 96 kHz PCM output. For details, refer to the player's operation manual.

The signal can be played when STEREO or AUTO has been selected for the Surround mode.

Some DVD formatted discs featured copy protect. When use such disc, 96 kHz PCM signal is not output from the DVD player. For details, refer to the player's operation manual.



### The relation between the selected surround mode and the input signal

The surround mode is selected with the surround mode selector knob of the SR7200 or the remote control unit. However, the sound from the speakers depend upon the relationship between the selected surround mode and the input signal. They are as follows;

Surround Mode	Input Signal	Output					Fluorescent Indicator			
		L/R	SL/SR	C	SC	SW	Input Indicator	Format Status & Surround Mode	Temporary Display Status	Ch. Status
Auto	Dolby Digital (5.1ch)	O	O	O	-	O	DIGITAL	DOLBY, DIGITAL, AUTO	>AUTO>	L,C,R,SL,SR,LFE
	Dolby Digital (2ch)	O	-	-	-	O	DIGITAL	DOLBY, DIGITAL, AUTO	>AUTO>	L,R
	Dolby Digital (2ch:Lt/Rt)	O	O	O	-	O	DIGITAL	DOLBY, DIGITAL, PRO LOGIC, AUTO	>AUTO>	L,R,SC
	96kHz PCM	O	-	-	-	-	DIGITAL	PCM, STEREO, AUTO	>AUTO>96kHz>	L,R
	PCM(Audio)	O	-	-	-	O	DIGITAL	PCM, STEREO, AUTO	>AUTO>	L,R
	Analog	O	-	-	-	O	ANALOG	STEREO, AUTO	>AUTO>	-
Stereo	DTS (5.1ch)	O	O	O	-	O	DIGITAL	DTS, AUTO	>AUTO>	L,C,R,SL,SR,LFE
	Dolby Digital (5.1ch)	O	-	-	-	O	DIGITAL	DOLBY, DIGITAL, STEREO	>STEREO>	L,C,R,SL,SR,LFE
	Dolby Digital (2ch)	O	-	-	-	O	DIGITAL	DOLBY, DIGITAL, STEREO	>STEREO>	L,R
	Dolby Digital (2ch:Lt/Rt)	O	-	-	-	O	DIGITAL	DOLBY, DIGITAL, STEREO	>STEREO>	L,R,SC
	96kHz PCM	O	-	-	-	-	DIGITAL	PCM, STEREO	>STEREO>96kHz>	L,R
	PCM(Audio)	O	-	-	-	O	DIGITAL	PCM, STEREO	>STEREO>	L,R
	Analog	O	-	-	-	O	ANALOG	STEREO	>STEREO>	-
	DTS (5.1ch)	O	-	-	-	O	DIGITAL	DTS, STEREO	>STEREO>	L,C,R,SL,SR,LFE
Movie	Dolby Digital (5.1ch)	O	O	O	-	O	DIGITAL	DOLBY, DIGITAL	>DOLBY D>	L,C,R,SL,SR,LFE
	Dolby Digital (2ch)	O	O	O	-	O	DIGITAL	DOLBY, DIGITAL, PRO LOGIC	>PLII MOVIE>	L,R
	Dolby Digital (2ch:Lt/Rt)	O	O	O	-	O	DIGITAL	DOLBY, DIGITAL, PRO LOGIC	>PLII MOVIE>	L,R,SC
	96kHz PCM	-	-	-	-	-	DIGITAL	(PCM), DOLBY, PRO LOGIC	>PLII MOVIE>96kHz>	-
	PCM(Audio)	O	O	O	-	O	DIGITAL	PCM, DOLBY, PRO LOGIC	>PLII MOVIE>	L,R
	Analog	O	O	O	-	O	ANALOG	DOLBY, PRO LOGIC	>PLII MOVIE>	-
Music	DTS (5.1ch)	-	-	-	-	-	DIGITAL	(DTS), DOLBY, PRO LOGIC	>PLII MOVIE>	-
	Dolby Digital (5.1ch)	O	O	O	-	O	DIGITAL	DOLBY, DIGITAL	>DOLBY D>	L,C,R,SL,SR,LFE
	Dolby Digital (2ch)	O	O	O	-	O	DIGITAL	DOLBY, DIGITAL, PRO LOGIC	>PLII MUSIC>	L,R
	Dolby Digital (2ch:Lt/Rt)	O	O	O	-	O	DIGITAL	DOLBY, DIGITAL, PRO LOGIC	>PLII MUSIC>	L,R,SC
	96kHz PCM	-	-	-	-	-	DIGITAL	(PCM), DOLBY, PRO LOGIC	>PLII MUSIC>96kHz>	-
	PCM(Audio)	O	O	O	-	O	DIGITAL	PCM, DOLBY, PRO LOGIC	>PLII MUSIC>	L,R
Pro Logic	Analog	O	O	O	-	O	ANALOG	DOLBY, PRO LOGIC	>PLII MUSIC>	-
	DTS (5.1ch)	-	-	-	-	-	DIGITAL	(DTS), DOLBY, PRO LOGIC	>PLII MUSIC>	-
	Dolby Digital (5.1ch)	O	O	O	-	O	DIGITAL	DOLBY, DIGITAL	>DOLBY D>	L,C,R,SL,SR,LFE
	Dolby Digital (2ch)	O	O	O	-	O	DIGITAL	DOLBY, DIGITAL, PRO LOGIC	>PRO LOGIC>	L,R
	Dolby Digital (2ch:Lt/Rt)	O	O	O	-	O	DIGITAL	DOLBY, DIGITAL, PRO LOGIC	>PRO LOGIC>	L,R,SC
	96kHz PCM	-	-	-	-	-	DIGITAL	(PCM), DOLBY, PRO LOGIC	>PRO LOGIC>96kHz>	-
DTS	PCM(Audio)	O	O	O	-	O	DIGITAL	PCM, DOLBY, PRO LOGIC	>PRO LOGIC>	L,R
	Analog	O	O	O	-	O	ANALOG	DOLBY, PRO LOGIC	>PRO LOGIC>	-
	DTS (5.1ch)	-	-	-	-	-	DIGITAL	(DTS), DOLBY, PRO LOGIC	>PRO LOGIC>	-
	Dolby Digital (5.1ch)	-	-	-	-	-	DIGITAL	(DOLBY, DIGITAL), DTS	>DTS>	-
	Dolby Digital (2ch)	-	-	-	-	-	DIGITAL	(DOLBY, DIGITAL), DTS	>DTS>	-
	Dolby Digital (2ch:Lt/Rt)	-	-	-	-	-	DIGITAL	(DOLBY, DIGITAL), DTS	>DTS>	-
6.1Ch Surround	96kHz PCM	-	-	-	-	-	DIGITAL	(PCM), DTS	>DTS>96kHz>	-
	PCM(Audio)	-	-	-	-	-	DIGITAL	(PCM), DTS	>DTS>	-
	Analog	-	-	-	-	-	(ANALOG)	DTS	>DTS>	-
	DTS (5.1ch)	O	O	O	-	O	DIGITAL	DTS	>DTS>	L,C,R,SL,SR,LFE
	Dolby Digital (5.1ch)	O	O	O	O	O	DIGITAL	DOLBY, DIGITAL	>6.1 CH SURROUND>	L,C,R,SL,SR,LFE
	Dolby Digital (2ch)	-	-	-	-	-	DIGITAL	(DOLBY, DIGITAL)	>6.1 CH SURROUND>	-
Movie Hall Stadium Matrix	Dolby Digital (2ch:Lt/Rt)	-	-	-	-	-	DIGITAL	(DOLBY, DIGITAL)	>6.1 CH SURROUND>	-
	96kHz PCM	-	-	-	-	-	DIGITAL	(PCM)	>6.1 CH SURROUND>96kHz>	-
	PCM(Audio)	-	-	-	-	-	DIGITAL	(PCM)	>6.1 CH SURROUND>	-
	Analog	-	-	-	-	-	(ANALOG)		>6.1 CH SURROUND>	-
	DTS (5.1ch)	O	O	O	O	O	DIGITAL	DTS	>6.1 CH SURROUND>	L,C,R,SL,SR,LFE
	Dolby Digital (5.1ch)	-	-	-	-	-	DIGITAL	(DOLBY, DIGITAL), DSP SOUND	>MOVIE/HALL/ STADIUM/MATRIX>	-
Virtual	Dolby Digital (2ch)	-	-	-	-	-	DIGITAL	(DOLBY, DIGITAL), DSP SOUND	>MOVIE/HALL/ STADIUM/MATRIX>	-
	Dolby Digital (2ch:Lt/Rt)	-	-	-	-	-	DIGITAL	(DOLBY, DIGITAL), DSP SOUND	>MOVIE/HALL/ STADIUM/MATRIX>	-
	96kHz PCM	-	-	-	-	-	DIGITAL	(PCM), DSP SOUND	>MOVIE/HALL/ STADIUM/MATRIX>	-
	PCM(Audio)	O	O	O	-	O	DIGITAL	PCM, DSP SOUND	>MOVIE/HALL/ STADIUM/MATRIX>	L,R
	Analog	O	O	O	-	O	ANALOG	DSP SOUND	>MOVIE/HALL/ STADIUM/MATRIX>	-
	DTS (5.1ch)	-	-	-	-	-	DIGITAL	(DTS), DSP SOUND	>MOVIE/HALL/ STADIUM/MATRIX>	-
CS5.1	Dolby Digital (5.1ch)	O	-	-	-	-	DIGITAL	DOLBY, DIGITAL, VIRTUAL	>VIRTUAL>	L,C,R,SL,SR,LFE
	Dolby Digital (2ch)	O	-	-	-	-	DIGITAL	DOLBY, DIGITAL, PROLOGIC, VIRTUAL	>VIRTUAL>	L,R
	Dolby Digital (2ch:Lt/Rt)	O	-	-	-	-	DIGITAL	DOLBY, DIGITAL, PROLOGIC, VIRTUAL	>VIRTUAL>	L,R,SC
	96kHz PCM	-	-	-	-	-	DIGITAL	(PCM)	>VIRTUAL>96kHz>	-
	PCM(Audio)	O	-	-	-	-	DIGITAL	PCM, DOLBY, PROLOGIC, VIRTUAL	>VIRTUAL>	L,R
	Analog	O	-	-	-	-	ANALOG	DOLBY, PROLOGIC, VIRTUAL	>VIRTUAL>	-
6CH Stereo	DTS (5.1ch)	-	-	-	-	-	DIGITAL	(DTS), DOLBY, VIRTUAL	>VIRTUAL>	-
	Dolby Digital (5.1ch)	-	-	-	-	-	DIGITAL	(DOLBY, DIGITAL)	>CS5.1>	-
	Dolby Digital (2ch)	-	-	-	-	-	DIGITAL	(DOLBY, DIGITAL)	>CS5.1>	-
	Dolby Digital (2ch:Lt/Rt)	-	-	-	-	-	DIGITAL	(DOLBY, DIGITAL)	>CS5.1>	-
	96kHz PCM	-	-	-	-	-	DIGITAL	(PCM)	>CS5.1>96kHz>	-
	PCM(Audio)	O	O	O	-	O	DIGITAL	PCM	>CS5.1>	L,R
6CH Stereo	Analog	O	O	O	-	O	ANALOG		>CS5.1>	-
	DTS (5.1ch)	-	-	-	-	-	DIGITAL	(DTS)	>CS5.1>	-
	Dolby Digital (5.1ch)	O	O	O	-	O	DIGITAL	DOLBY, DIGITAL	>6CH STEREO>	L,C,R,SL,SR,LFE
	Dolby Digital (2ch)	O	O	O	O	O	DIGITAL	DOLBY, DIGITAL	>6CH STEREO>	L,R
	Dolby Digital (2ch:Lt/Rt)	O	O	O	O	O	DIGITAL	DOLBY, DIGITAL	>6CH STEREO>	L,R,SC
	96kHz PCM	-	-	-	-	-	DIGITAL	(PCM)	>6CH STEREO>96kHz>	-
6CH Stereo	PCM(Audio)	O	O	O	O	O	DIGITAL	PCM	>6CH STEREO>	L,R
	Analog	O	O	O	O	O	ANALOG		>6CH STEREO>	-
	DTS (5.1ch)	O	O	O	-	O	DIGITAL	DTS	>6CH STEREO>	L,C,R,SL,SR,LFE

L/R : Front speaker  
 SL/SR : Surround speaker  
 C : Center speaker  
 SC : Surround center speaker  
 SW : Sub woofer speaker  
 ( ) : The indicator blinks

L : Left  
 R : Right  
 C : Center  
 SL : Surround Left  
 SR : Surround Right  
 SC : Mono Surround  
 LFE : Low Frequency Effect

**Note:**

- Dolby Digital (2 ch: Lt/Rt): signal with Dolby Surround flag Speakers are full set.
- When DOLBY DIGITAL, DTS, PCM or ANALOG is blinking, the selected surround mode is unavailable for input signal. Select the other appropriate surround mode to playback.
- No sound outputs from the surround speaker, center speaker and subwoofer if the DVD disc has no surround data.

# TROUBLESHOOTING

If the unit does not operate properly, check items shown in the following table. If your trouble cannot be recovered with the remedy actions listed in the following table, malfunction of the internal circuitry is suspected; immediately unplug the power cable and contact your dealer, nearest Marantz distributor or the Marantz Service Center in your country.

In case of trouble, check the following before calling for service:

1. Are the connections made properly ?
2. Are you operating the unit properly following user's guide ?
3. Are the power amplifiers and speaker working properly ?

SYMPTOM	CAUSE	REMEDY
SR7200 cannot be turned up.	The power plug is not connected.	Connect the power plug to the outlet.
No sound and picture are output even when power is on.	Mute is on. The input cable is not connected correctly. The master volume control is turned all the way down. The function selector position is wrong.	Cancel mute using the remote control unit. See the connection diagram and connect the cables correctly. Adjust the master volume. Select correct position.
Sound and pictures from other than equipment selected with the function selector.	Input cable connected incorrectly.	Connect the cable correctly by referring to the connection diagram.
Sound from the wrong channel is output from the speaker.	Speaker cable connected incorrectly.	Connect the cable correctly by referring to the connection diagram.
No sound is output from the center speaker.	The center speaker cable connection is incomplete. STEREO has been selected for Surround mode. Center = NONE has been selected in SETUP mode.	Connect the cable correctly. When STEREO is selected for Surround mode, no sound will be output from the center speaker. Set another Surround mode. Make the correct setting.
No sound is output from the surround speakers.	The surround speaker cable connection is incomplete. STEREO has been selected for Surround mode. Surround = NONE has been selected in SETUP mode.	Connect the cable correctly. When STEREO has been selected for Surround mode, no sound will be output from the surround speaker. Set another Surround mode. Make the correct setting.
No output to Sub Woofer Out.	Sub-woofer = NO has been selected in SETUP mode.	Select Sub-woofer = YES.
Surround mode cannot be changed.	The headphones are connected to the jack.	Disconnect the headphones. (When headphones are connected, Surround mode will be fixed to STEREO.)
Noise is produced during DTS-encoded CD or laser disc play.	Analog has been selected for input.	Be sure to perform digital connection, select digital input, then play.
DTS sources cannot be played.	Surround mode is set to DOLBY. The DVD or LD player is not DTS digital out capable.	Select other mode. Use a player which responds to DTS-digital out.
Player skips during play of a DTS source and produces noise.	Data error occurred during player skip.	Set Surround mode to DTS.
A 96kHz PCM signal cannot be played.	The disc player is not 96kHz PCM digital out capable. Surround mode is set to other than STEREO and AUTO.	Use a player that responds to 96kHz PCM digital out. Set Surround mode to STEREO or AUTO.
A normal PCM signal (CD or laser disc) cannot be played.	Surround mode is set to DTS.	Select other mode.
A Dolby Digital signal cannot be played.	Surround mode is set to DTS	Select other mode.
A specific channel does not produce output.	Nothing recorded on source.	Check the encoded channel on the source side.
FM or AM reception fails.	Antenna connection is incomplete.	Correctly connect the indoor FM and AM antennas to FM and AM antenna outlets.
Noise is heard during AM reception.	Reception is affected by other electrical fields.	Try changing location where the AM indoor antenna is set up.
Noise is heard during FM reception.	The radio waves from the broadcasting station are weak.	Install an FM outdoor antenna.
Cannot get programmed station when the PRESET button is pressed.	Preset data has been erased.	Disconnecting power plug for long periods of time will erase preset data. If that happens, input the preset data again.
Nothing appears on the remote commander display.	Batteries are consumed.	Replace all the batteries with new ones.
Control with the remote control unit fails.	Batteries are consumed.. Remote controller's function-key setting is wrong. The distance between this SR7200 and the remote commander is too far. Something is blocking SR7200 and the remote commander.	Replace all the batteries with new ones.. Select different position from which equipment will be controlled. Move closer to this SR7200. Remove offending object.

## GENERAL MALFUNCTION

If the equipment malfunctions, this may be because an electrostatic discharge or AC line interference has corrupted the information in the equipment memory circuits. Therefore:

- disconnect the plug from the AC line supply
- after waiting at least three minutes, reconnect the plug to the AC line supply
- re-attempt to operate the equipment

### Memory backup

- In case a power outage occurs or the power cord is accidentally unplugged, the SR7200 is equipped with a backup function to prevent memory data such as the preset memory from being erased.

The memory functions are backed up for up to about one week.

### NOTE:

First of all keep SR7200 Standby or Powered-on more than 6 hours, to sufficient time for memory back up.

# TECHNICAL SPECIFICATIONS

## FM TUNER SECTION

Frequency Range .....	87.5 - 108.0 MHz
Usable Sensitivity .....	IHF 1.8 $\mu$ V/16.4 dBf
Signal to Noise Ratio .....	Mono/Stereo 76/72 dB
Distortion .....	Mono/Stereo 0.2/0.3 %
Stereo Separation .....	1 kHz 45 dB
Alternate Channel Selectivity .....	$\pm$ 300 kHz 60 dB
Image Rejection .....	98 MHz 70 dB
Tuner Output Level .....	1 kHz, $\pm$ 40 kHz Dev 500 mV

## AM TUNER SECTION

Frequency Range .....	LW: 152 - 282 kHz, MW: 522 - 1611 kHz
Signal to Noise Ratio .....	50 dB
Usable Sensitivity .....	Loop 400 $\mu$ V/m
Distortion .....	400 Hz, 30 % Mod. 0.5 %
Selectivity .....	$\pm$ 18 kHz 60 dB

## AUDIO SECTION

Continuous Power Output (8 ohms / 20 Hz - 20 kHz)	
Front .....	110 W
Center .....	110 W
Surround .....	110 W
THD Front (20 Hz - 20 kHz) .....	8 ohms 0.05 %
Input Sensitivity/Impedance	
Linear .....	340 mV/ 47 Kohms
Signal to Noise Ratio	
Linear .....	105 dB

## VIDEO

Television Format .....	NTSC/PAL
Input Level/Impedance .....	1 Vp-p/ 75 ohms
Output Level/Impedance .....	1 Vp-p/ 75 ohms
Video Frequency Response .....	5 Hz to 8 MHz (- 1 dB)
S/N .....	60 dB

## GENERAL

Power Requirement .....	AC 230 V 50 Hz
Power Consumption (STEREO MODE RATED POWER) .....	350 W
Dimension (MAX)	
Width .....	440 mm
Height .....	164 mm
Depth .....	400 mm
Weight .....	14.9 Kg

## ACCESSORIES

Remote Control Unit RC7200SR .....	1
AA-size batteries .....	2
FM Feeder Antenna .....	1
FM Antenna Converter .....	1
AM Loop Antenna .....	1
Registration Card .....	1
User Guide .....	1

Specifications subject to change without prior notice.

COUNTRY	COMPANY	ADDRESS
ALGERIE	Azur 2000	8, Lotissement Ben Hatadi, Alger, Algerie
ARMENIA	NGYIG Ltd.	47 A/75 St. Lalaunts, 375000 Yerevan, Armenia
AUSTRALIA	Jamo Australia Pty. Ltd.,	24 Lionel Road, Mt. Waverley, VIC 3149, Australia
AUSTRIA	Huber & Prohaska GmbH	Taborstraße 95 / Ladestraße 1, Gebäude Hangartner, A-1200 Wien, Austria
BAHREIN	Ambassador Stores	P.O. Box 237,141, Government Avenue, Manama,Bahrein
BANGLADESH	Target	1078, Ramjoy Mohanja Lane Asadgonj, Chittagong 4000, Bangladesh
BELGIUM	Van der Heyden Audio N.V.	Brusselbaan 278, 9320 Erembodegem, Belgium
BULGARIA	Ariescommerce GmbH	Makedonia Blvd. 16, 1606 Sofia, Bulgaria
CANADA	Lenbrook Industries Limited	633 Granite Court, Pickering, Ontario
CHINA	Guang Chang Audio International Co., Ltd.	No.38 Yushan Road, ShiQiao, Pan Yu, Guang Dong, China
CYPRUS	Empire Hifi systems Ltd.	P.O. Box 5604, Nicosia, Cyprus
CZECH REPUBLIC	Audio International	Sokolska 41, 67902 Rajecko, OKR,Blansko, Czech Republic
DENMARK	Audio Nord	Dali Allé 1, 9610 Noerager, Denmark
DUBAI	V.V. & SONS	P.O. Box 105, Dubai, U.A.E.
EGYPT	Solimco	9, El Attibaa St. Doki, Cairo, Egypt
ESTONIA	HiFi Club Estonia	Ehte 4, 90503 Haapsalu, Estonia
F.Y.R.O.M.	T.P. KODI	ul.Cedomir Kantargiev 21a, Skopje, Former Yugoslavian Republic of Macedonia
FINLAND	Audio Nord	Uudenmaankatu 4-6, Helsinki SF-00120, Finland
FRANCE	Marantz France	A division of Marantz Europe B.V., P.O. Box 301, 92 156 Suresnes Cedex, France
GERMANY	Marantz Deutschland	Hakenbusch 3, 49078 Osnabrück, Germany
GREECE	Adamco S.A.	188, Hippocratous Street, 11471 Athens, Greece
HEADQUARTERS EUROPE:	Marantz Europe B.V.	Building SFF-2, P.O. Box 80002, 5600 JB Eindhoven, The Netherlands
HONG KONG	Marantz Asia Ltd.	Unit 1706, Metroplaza II, 223 Hing Fong Road, Kwai Fong, N.T., Kowloon, Hong Kong
HUNGARY	Infovox Ltd.	Terez Krt.31, 1067 Budapest, Hungary
ICELAND	ID Electronics Ltd.	Armula 38, 108 Reykjavik, Iceland
INDIA	NOVA Audio Private	8,Punam Co-op.Society 29/30 Road#5, Union Park MUMBAI 400052, India
IRAN	Home Co.	5th floor no 878 Philips Building Enghelab ave, P.O. 11365/7844 Tehran, Iran
IRELAND	Marantz Ireland	Clonskeagh, Dublin 14, Ireland
ISRAEL	Elmor Ltd.	52 Heh Beiyar Street, Kikar Hamedina, Tel Aviv, Israel
ITALY	Marantz Italy	Via Casati 23, 20052 Monza (Milano), Italy, Servizio Consumatori 1678-20026, Numero Verde
IVORY COAST	Hifivoir	B.P. 2428, Abidjan 01, Ivory Coast
JAPAN	Marantz Japan Inc.	35-1 Sagami Ohno 7-Chome, Sagamihara-shi, Kanagawa 228-8505, Japan
KOREA	Mk Enterprises Ltd.	121-210, 2F Shinhan Bldg., 247-17 Seokyo-dong, Mapo-ku, Seoul, Korea
KUWAIT	alAlamiah Electronics Intl.	P.O. Box 8196, Salmiah 22052, Kuwait
LATVIA	Ace Ltd.	61, LacPlesa Str., Riga LV 1011, Latvia
LEBANON	AZ Electronics S.A., 1,	P.O. Box 11 2833, Beirut, Lebanon
LITHUANIA	Accapella Ltd.	Ausros, Vartu G/5, Pasazo SKG., 2001 Vilnius, Lithuania
MALAYSIA	Wo Kee Hong Electronics Sdn. Bhd.	Suite 8.1, Level 8, Menara Genesis, No. 33, Jalan Sultan Ismail, 50250 Kuala Lumpur, Malaysia
MALTA	Doneo Co Ltd.	78 The Strand, Sliema SLM07, Malta
MAURITIUS	SKR Electronics Ltd.	P.O. Box 685, Bell Village, Port Louis, Mauritius
MILITARY MARKET EUROPE	PASCO GmbH	PO BOX 1280, Sandhausen 69200, Germany
NETHERLANDS	Marantz Domestic Sales	A division of Marantz Europe B.V., Building SFF2, P.O. Box 80002, 5600 JB Eindhoven, The Netherlands
NEW ZEALAND	Wildash Audio Systems	14 Malvern Road, Mt. Albert, Auckland, New Zealand
NORWAY	Audio Nord	Sandkerveien 64, Oslo 0483, Norway
OMAN	Mustafa & Jawad Trading CO.	P.O. Box 1918, Ruwi, Oman
POLAND	Philips Polska Sp. z.o.o.	Al.Jerozolimskie 195b, 02 222 Warszawa, Poland
PORTUGAL	Corel2	Comércio de Electrónica Lda., Av. Luís Bivar, No 85 A, 1050 Lisboa, Portugal
PROFESSIONAL EUROPE	Marantz Professional Products	Kingsbridge House, Padbury Oaks, 575-583 Bath Road, Longford, Middlesex UB7 0EH, U.K.
PROFESSIONAL U.S.A.	Marantz Professional Products	Distributed by: Superscope Technologies Inc., 1000 Corporate Blvd. Ste.D, Aurora, Illinois
QATAR	Almana & Partners W.W.L.	P.O. Box 49, Doha, Qatar
REUNION	Vision +	180 Rue du Marechal Leclerc, 97400 Saint Denis, Ile de la Reunion
ROMANIA	Nova Music Entertainment	5, Zagazului Str. Bl.1G,apt.18, sector 1,Bucharest, Romania
RUSSIA	Absolute Audio	7/2, Montazhnaya Street, 107497 Moscow, Russia
SAUDI ARABIA	Adawlia Univ. Electr. Apl	P.O. Box 2154, Alkhobar 31952, Saudi Arabia
SINGAPORE	Wo Kee Hong Distribution PTE Ltd.	130 Joo Seng Road, #03-02 Olivine Building, Singapore 368357
SLOVAKIA	Bis Audio s.r.o.	Nam. SNP 10, 96001 Zvolem, Slovakia
SLOVENIA	Bofex	Smartinska 152, HALA V/3, 61000 Ljubljana, Slovenia
SOUTH AFRICA	Coherent Imports (PTY) Ltd.	P.O. Box 1614, Alberton, 1450, South Africa
SPAIN	Marantz Spain	Martinez Villergas 2, Apartado 2065, Madrid 28027, Spain
SRI LANKA	The listening Room	Mezzanine Floor, The Landmark 385, Galle Road, Colombo - 3, Sri Lanka
SWEDEN	Audio Nord	Almedalsvagen 4, Gotenborg 402-23, Sweden
SWITZERLAND	Sound Company AG	Postfach, 8010 Zürich, Switzerland
SYRIA	Hamzeh & Partners	Hafez Ibrahim Str. No 117, Damascus Shalan, Syria
TAHITI	Covecolor	Av. Prince Hinoi, Cours de l'union sacré, P.O. Box 2334, Papeete, Tahiti
TAIWAN	Pai-Yuing Co. Ltd.	6th No 148 Sung Kiang Road, Taipei 10429, Taiwan R.O.C.
THAILAND	MRZ Standard Co. Ltd.	746-750 Mahachai Road, Wangburapa, Bangkok 10200, Thailand
TUNESIA	Societe EDEVIG	40, Avenue du Golfe Arabe, El Menzah, 1004, Tunesia
TURKEY	Türk Philips Ticaret A.S.	Yukari Dudullu Organize sanayi Bolgesi, 2.Cadde no.28, 81260 Umraniye-Istanbul, Turkey
U.K.	Marantz Hifi UK Ltd.	Kingsbridge House, Padbury Oaks, 575-583 Bath Road, Longford, Middlesex UB7 0EH, U.K.
U.S.A.	Marantz America Inc.	1100 Maplewood Drive Itasca, IL 60143, U.S.A.
YUGOSLAVIA	ITM Company	Omladinskih Brigada 86, 11070 Belgrade, Yugoslavia
EXPORT	Marantz Domestic Sales	A division of Marantz Europe BV,Building SFF2, P.O. Box 80002, 5600 JB Eindhoven, The Netherlands

www.marantz.com

Manufactured under license from Dolby Laboratories. "Dolby", "Pro Logic", and the double-D symbol are trademarks of Dolby Laboratories.

"DTS", "ES" and "DTS Digital Surround" are trademarks of Digital Theater Systems, Inc.

Circle Surround and the (●)® symbol are trademarks of SRS Labs, Inc.

Circle Surround technology is incorporated under license from SRS Labs, Inc.

