



© playmobil

playmobil

3240

WARNING:
CHOKING HAZARD - SMALL PARTS
Not for children under 3 years.
Ne concerne que les USA

Wichtige Unterlagen: bitte sorgfältig aufbewahren!
Important documents: keep carefully!
Documents importants: conservez avec soin!



1

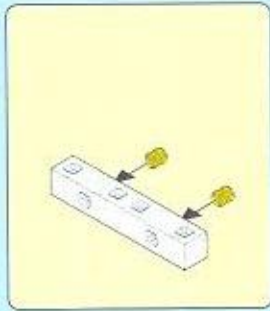
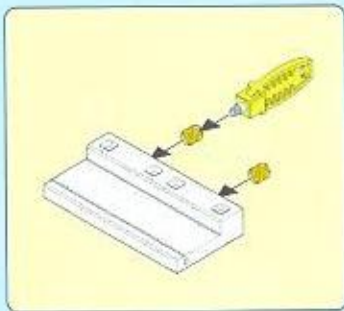

2x

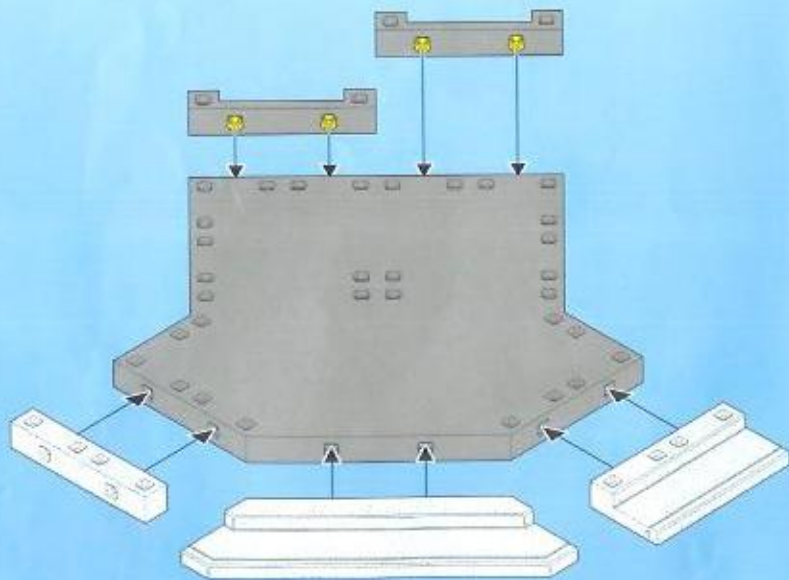
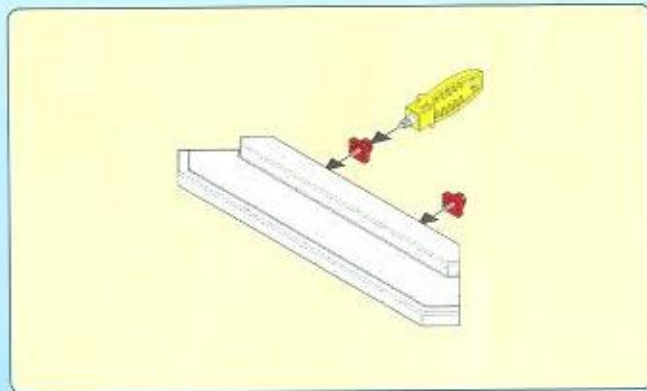
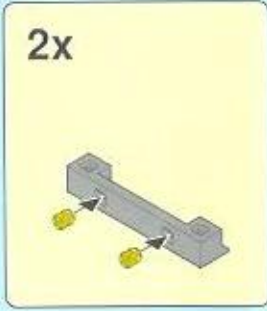

2

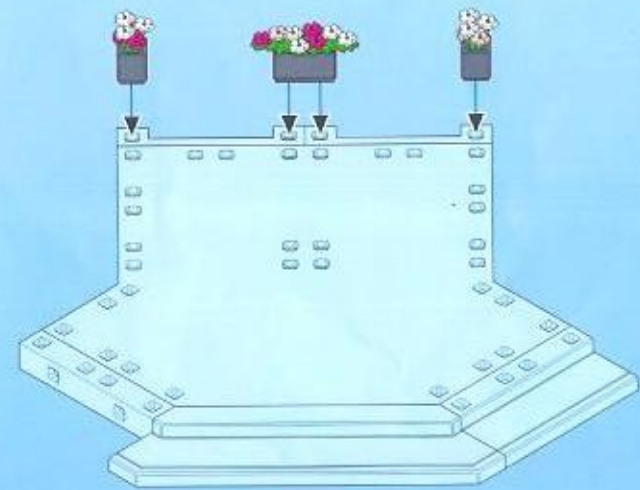
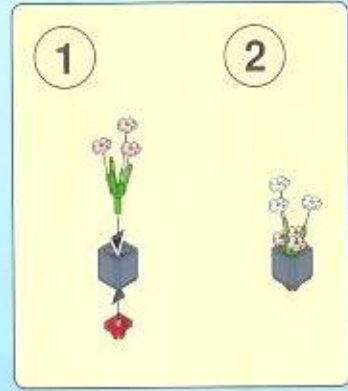
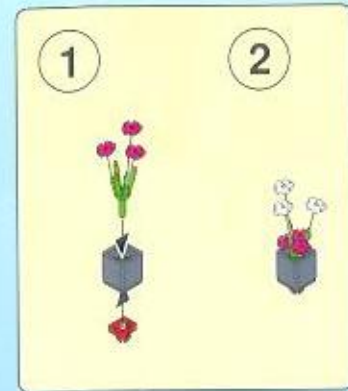
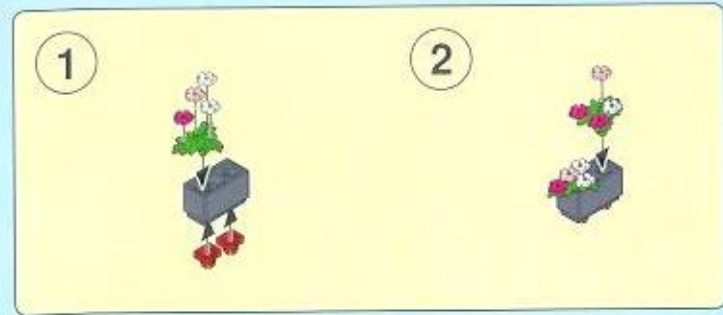

3

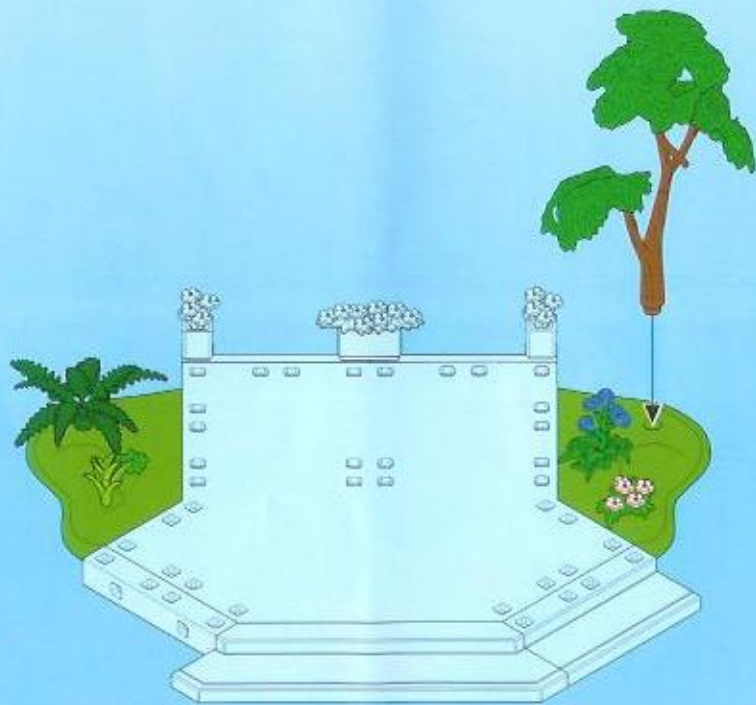
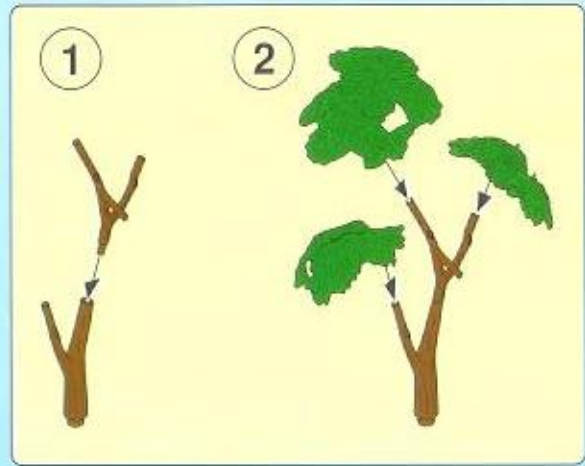
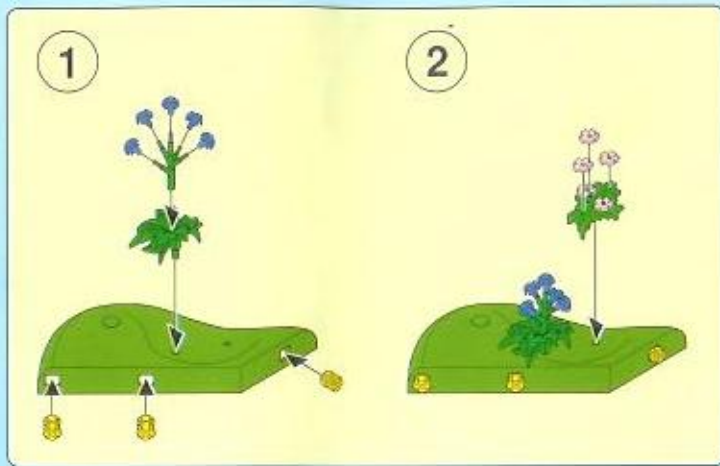
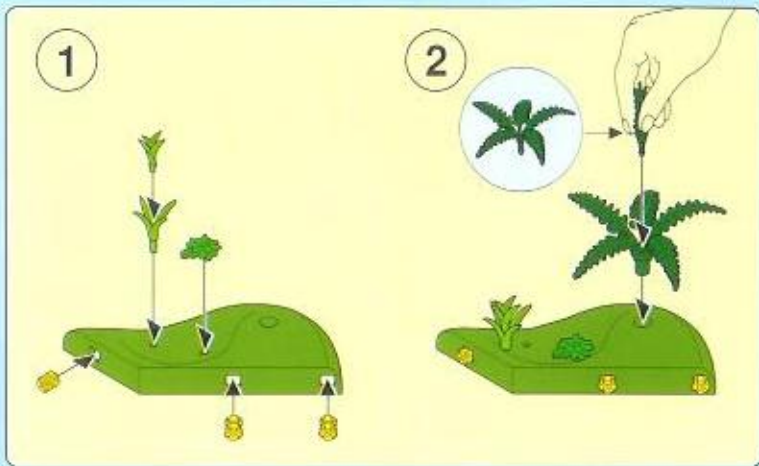

4

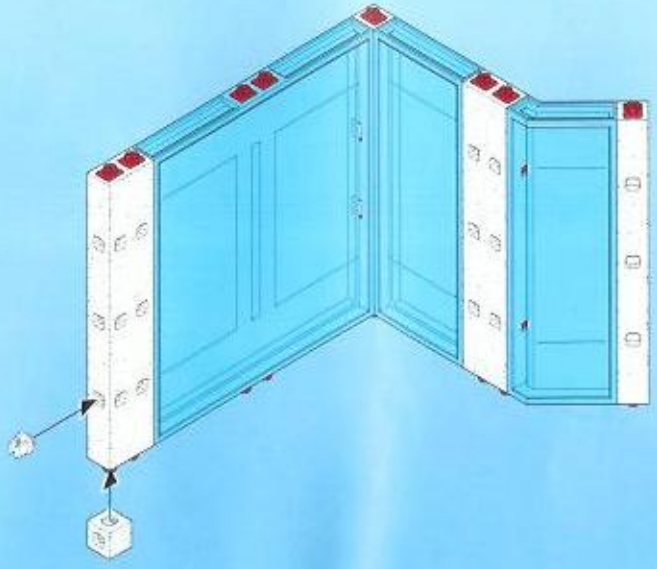
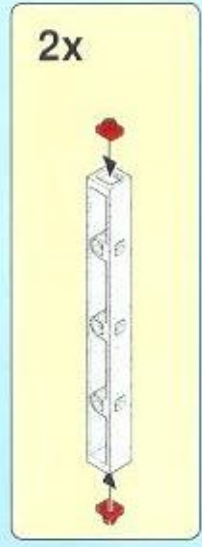
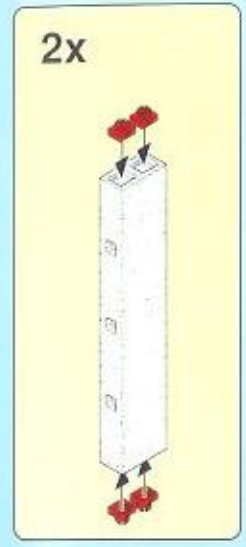
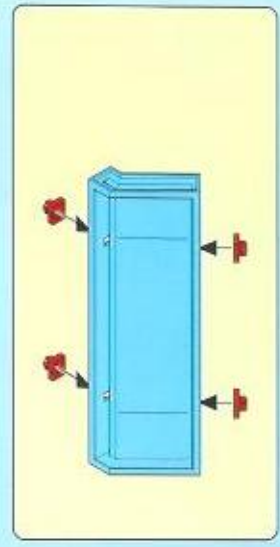
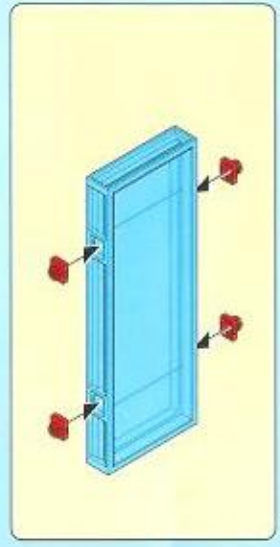
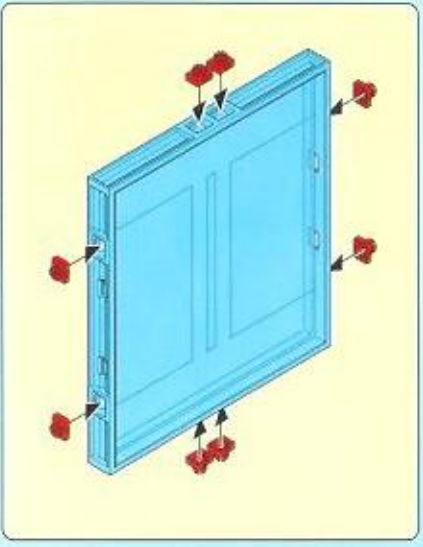

5

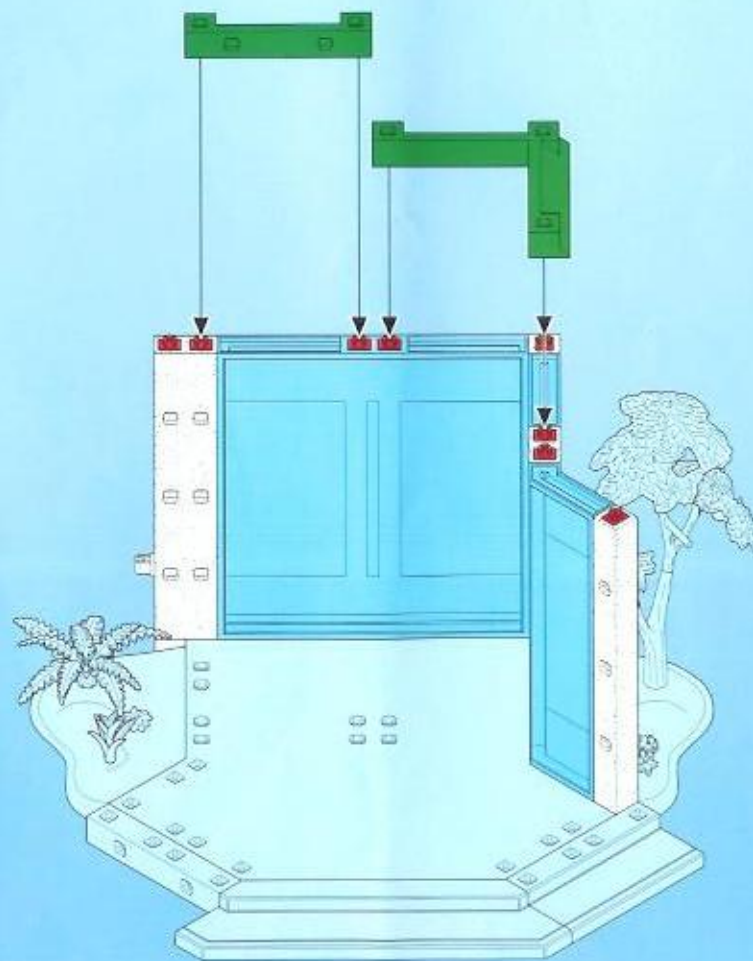

6

1

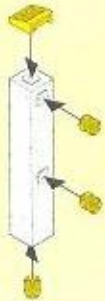

2

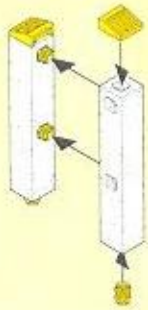

3

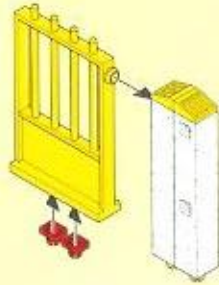

4

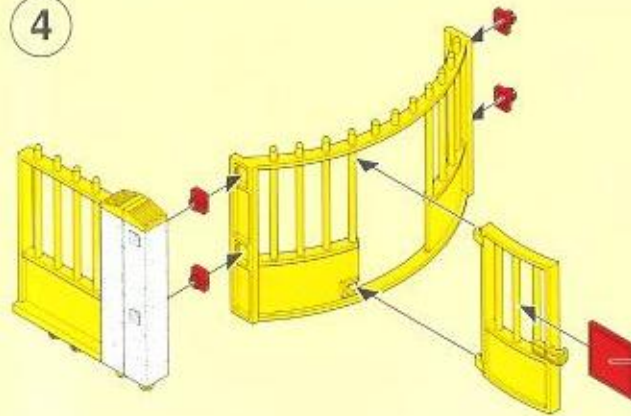

14

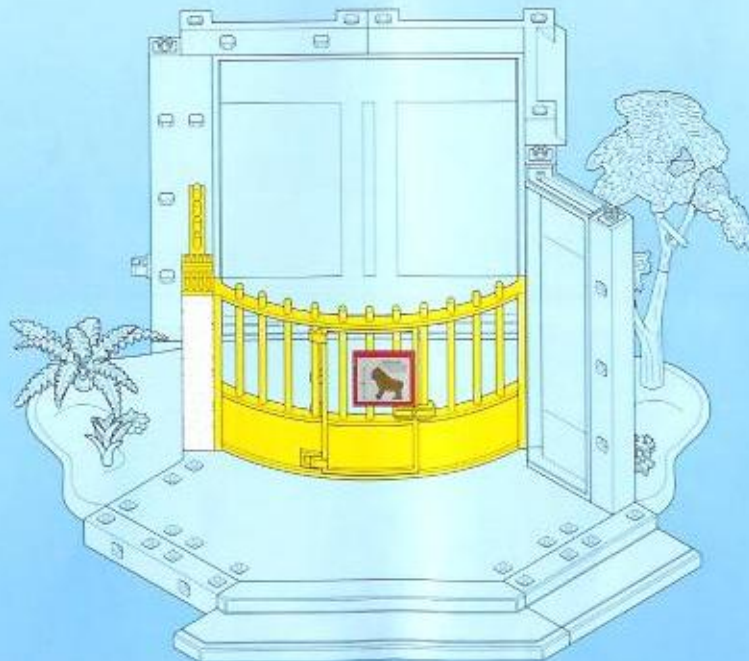

7

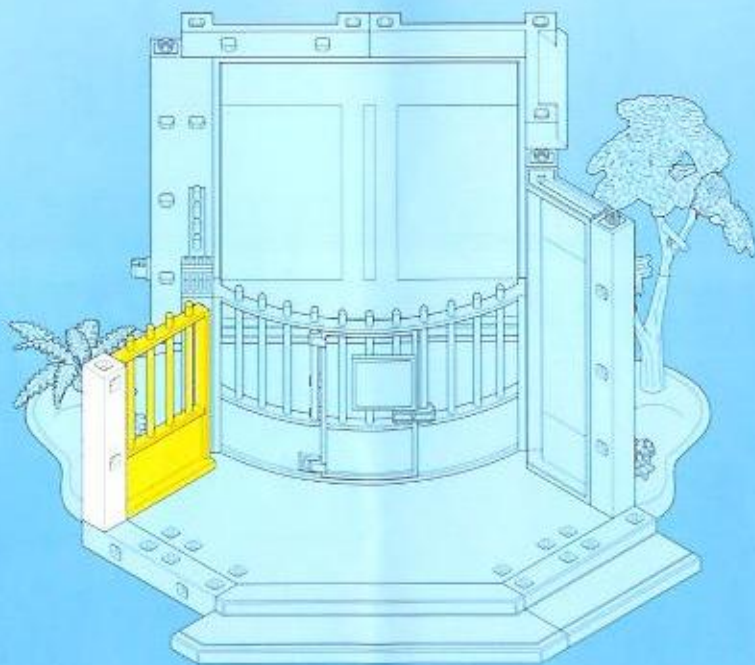
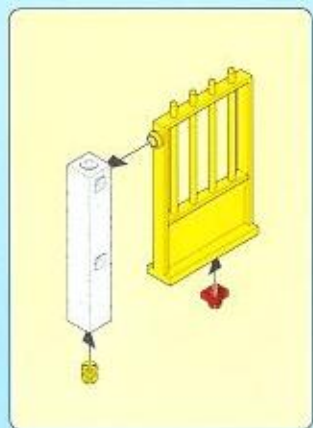

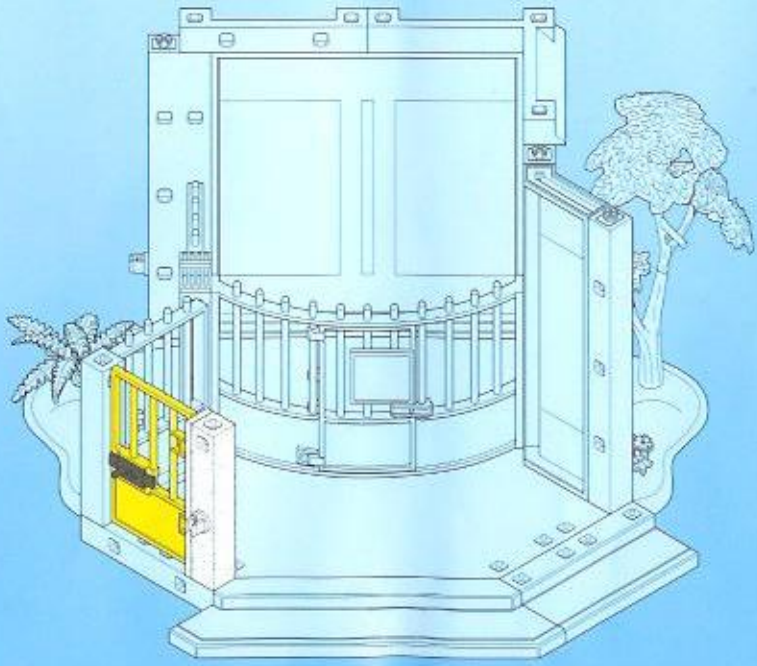
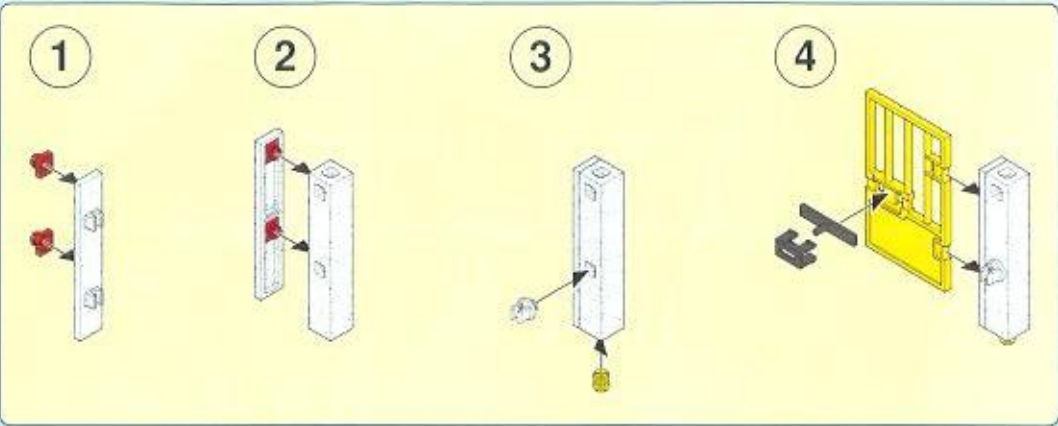

9

1



2

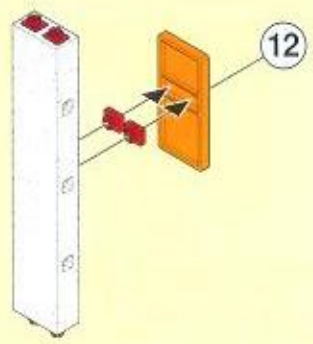

12



3

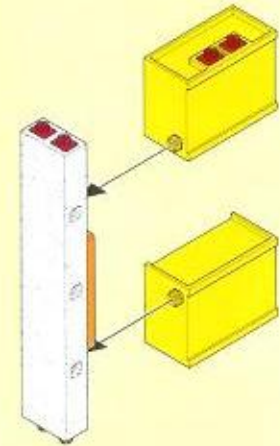
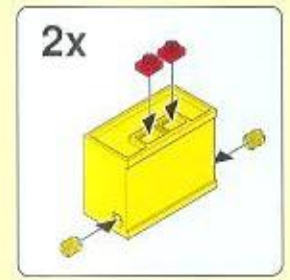

4

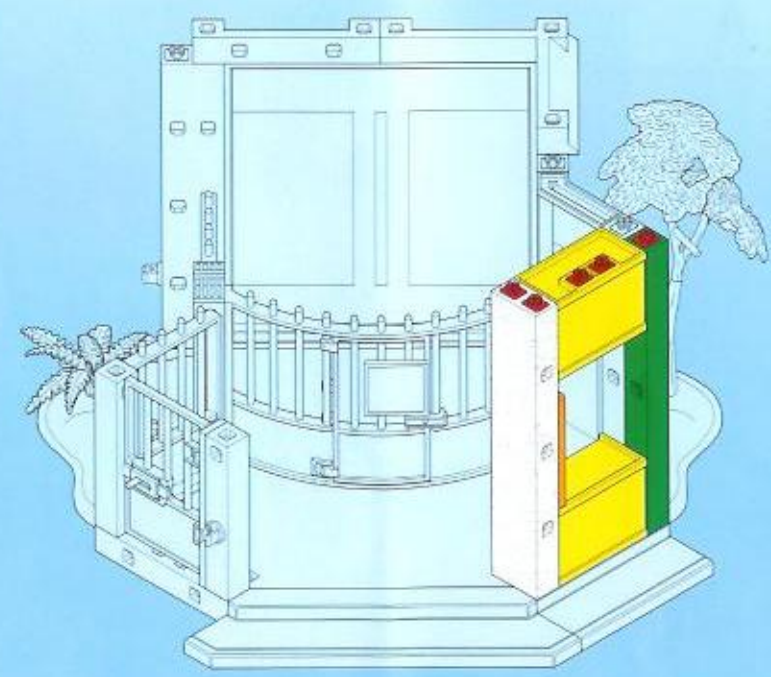
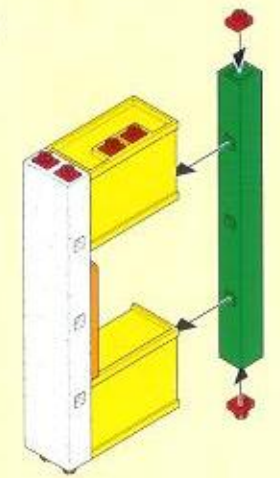

10

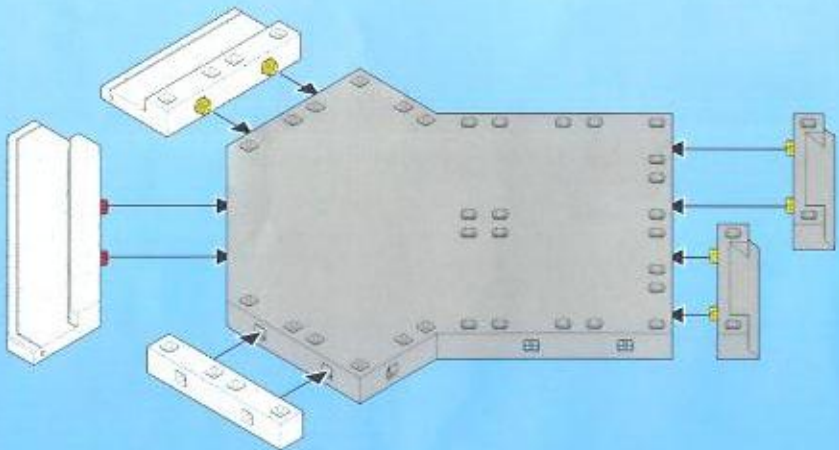
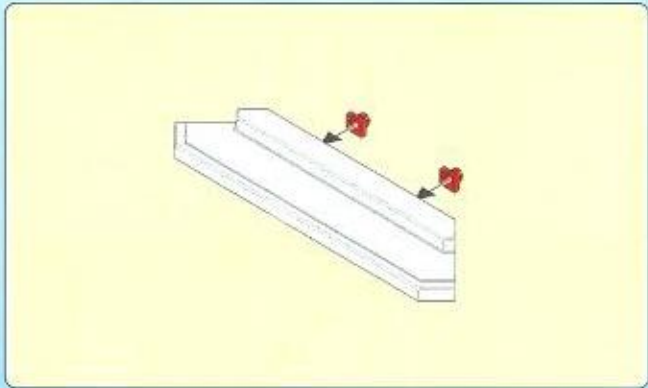
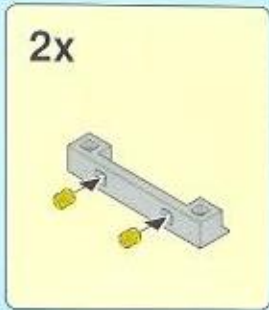
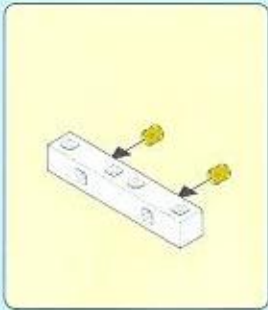
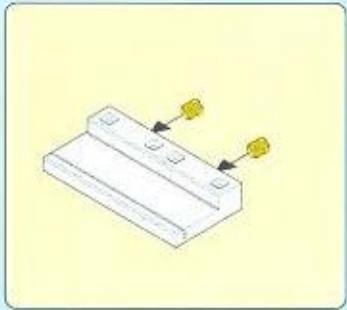

11

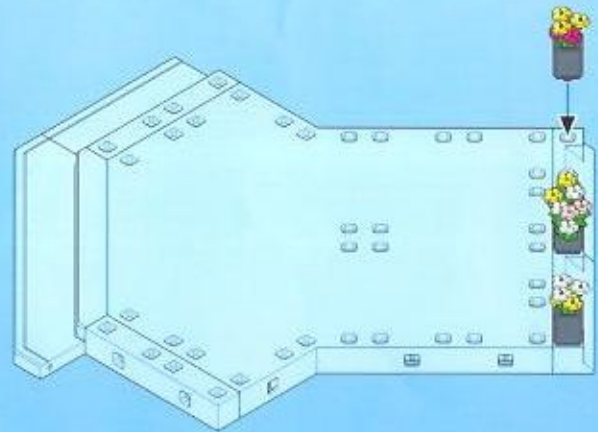
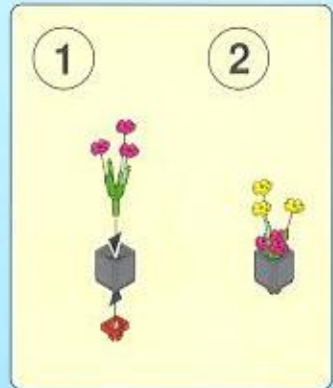
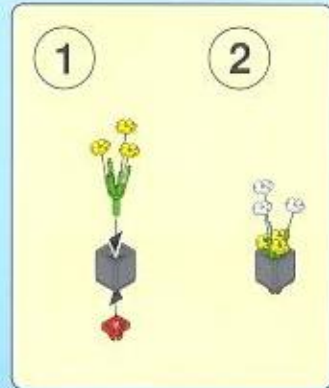
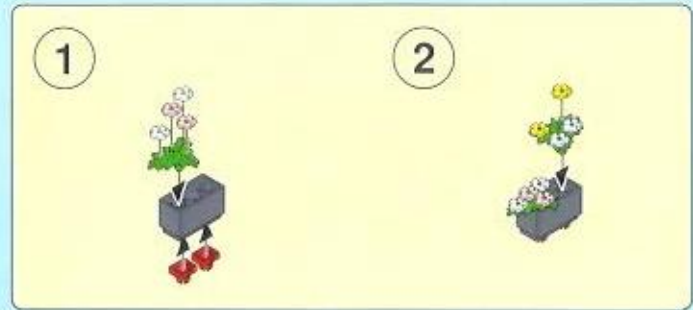

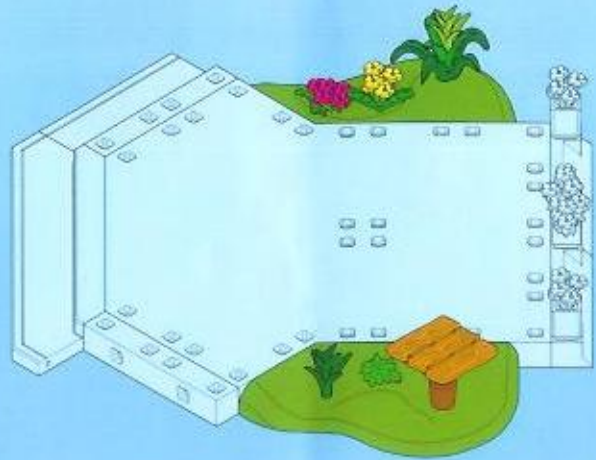
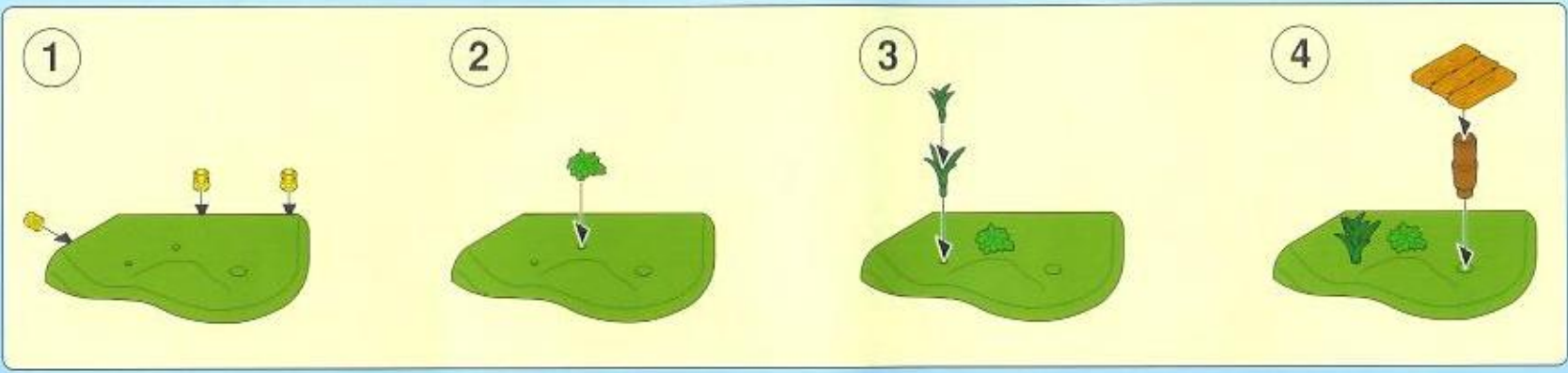
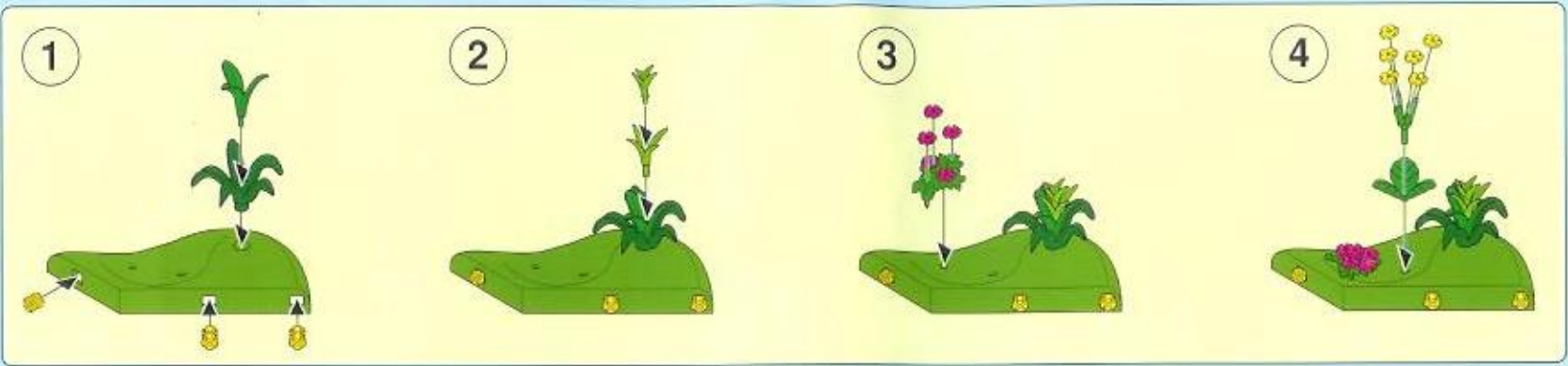

13

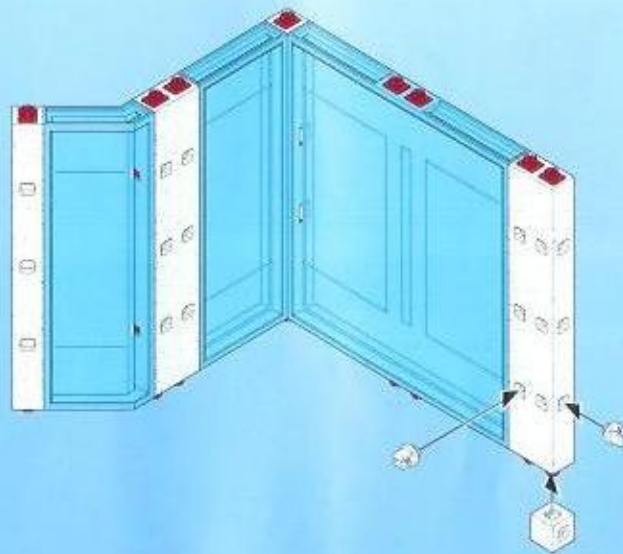
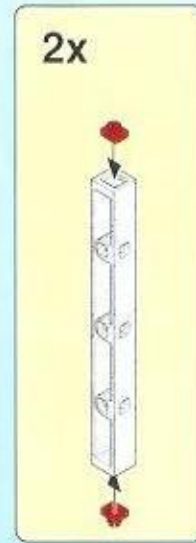
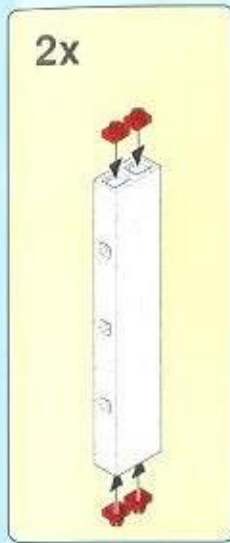
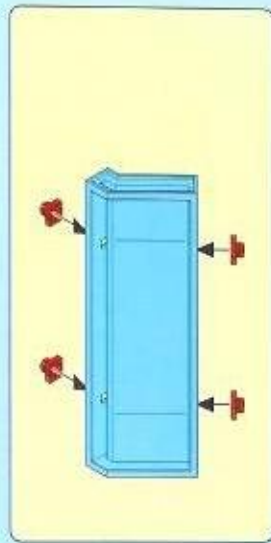
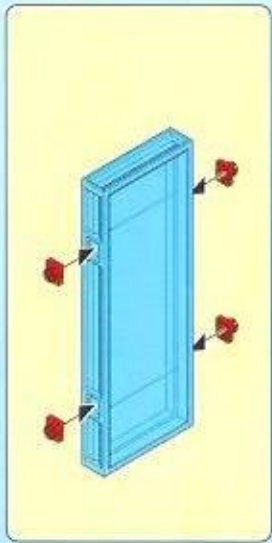
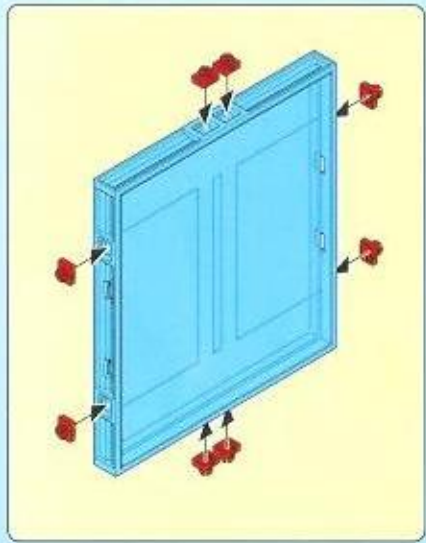

14

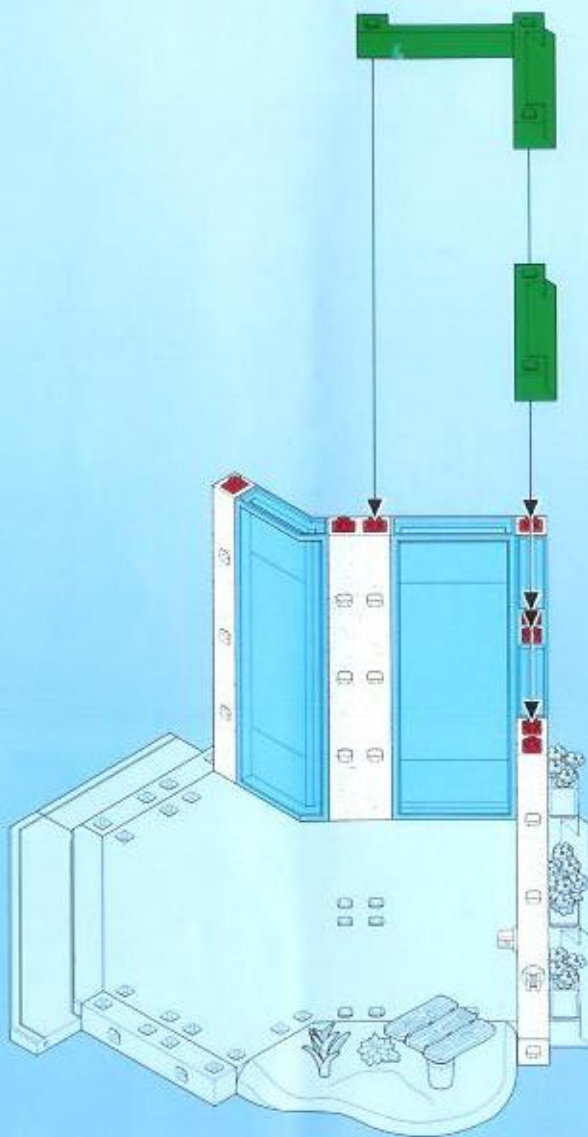

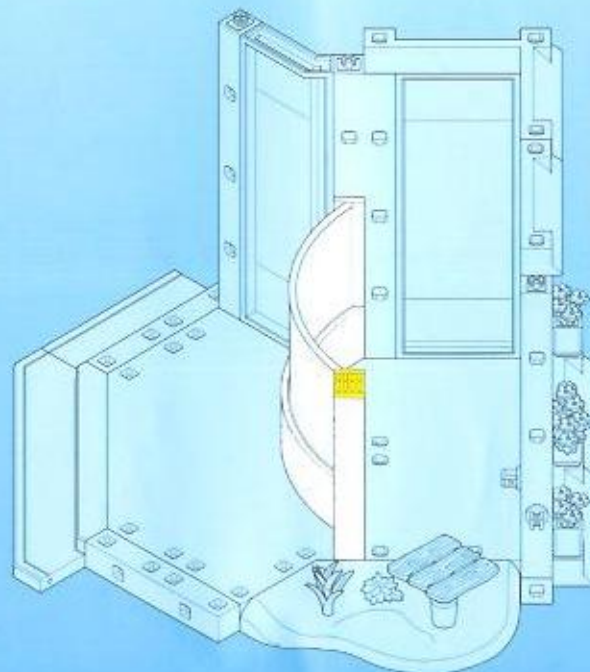
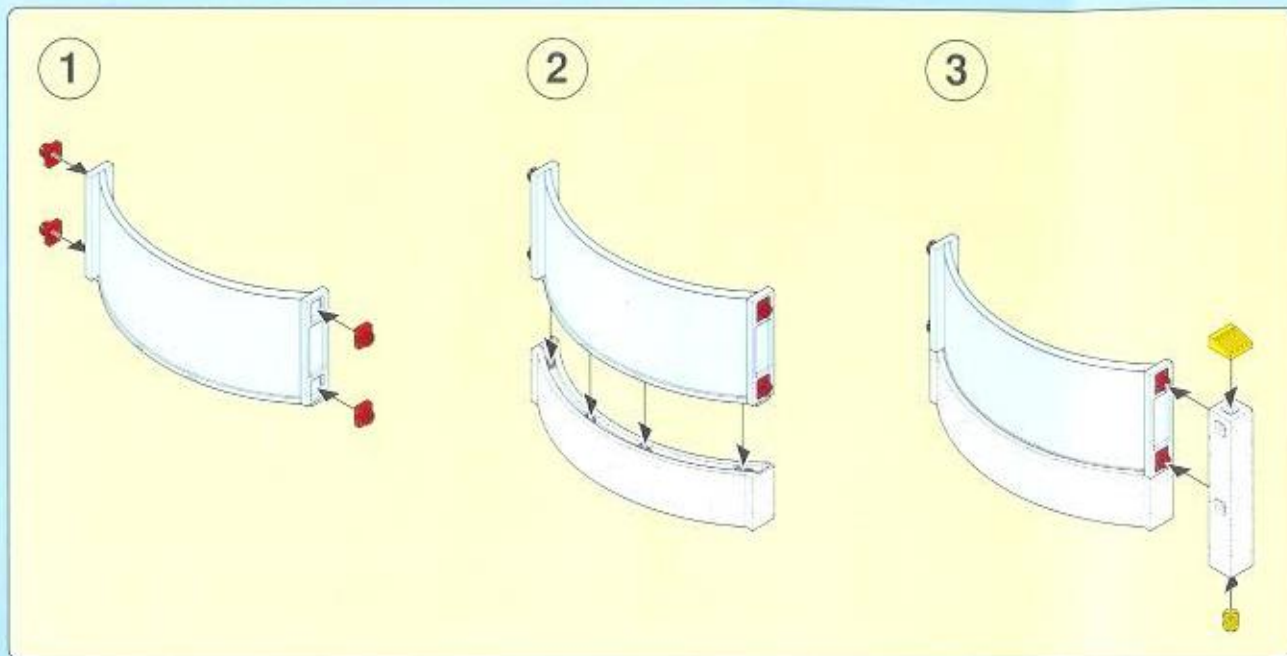

16

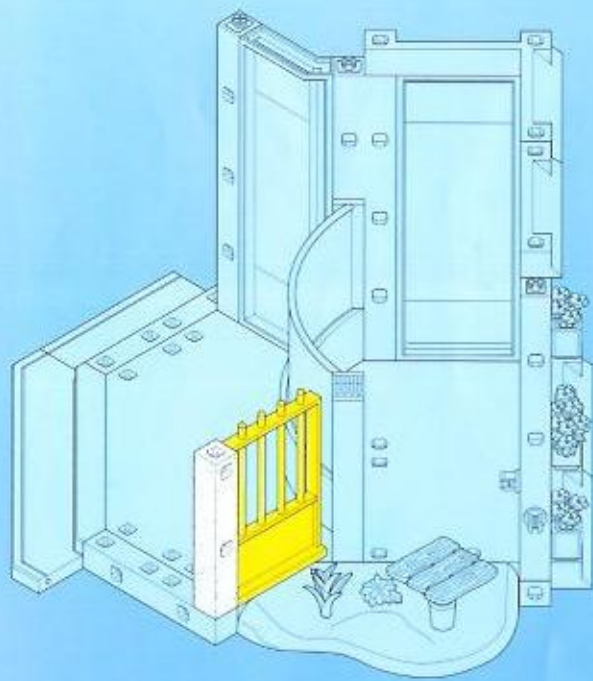
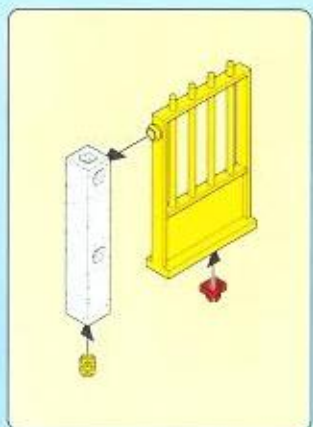

17

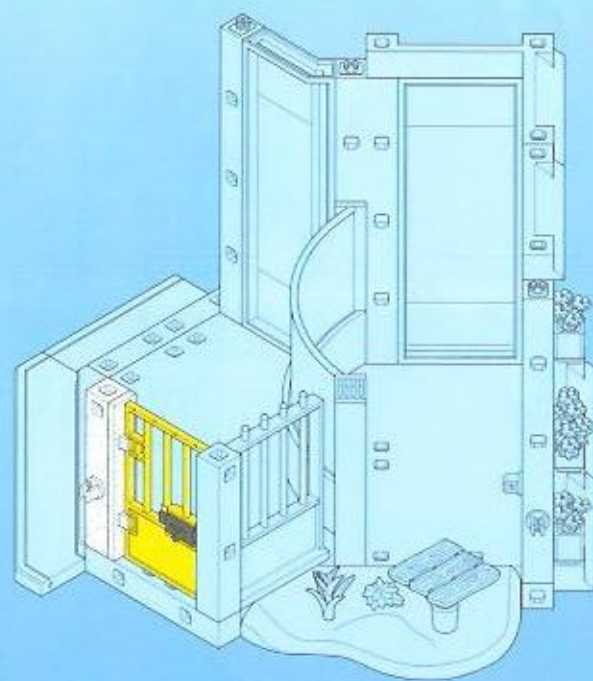
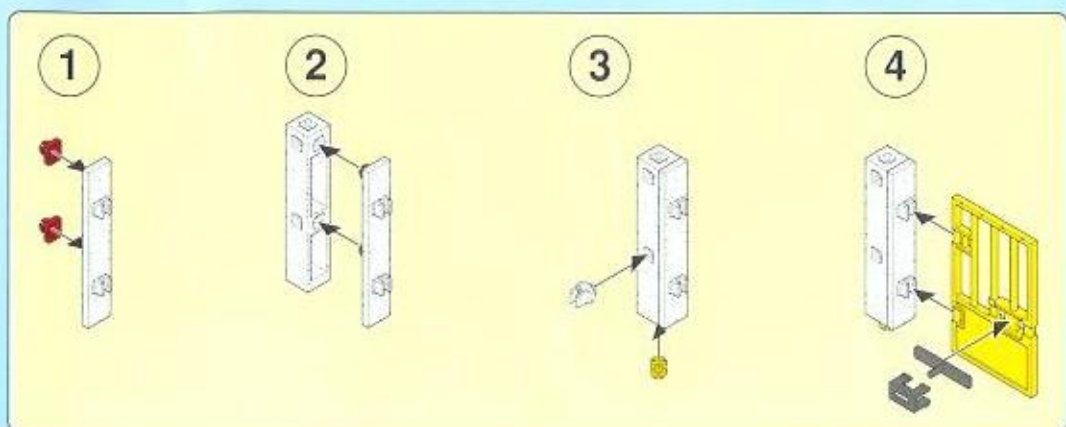

1

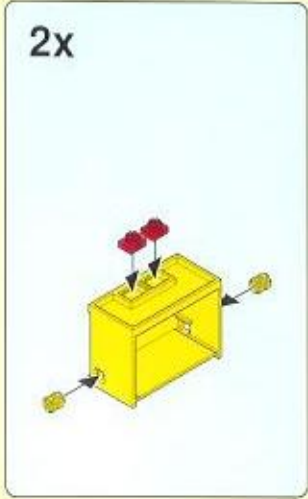
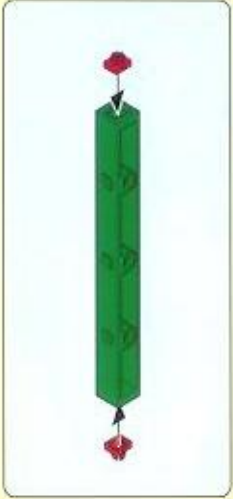
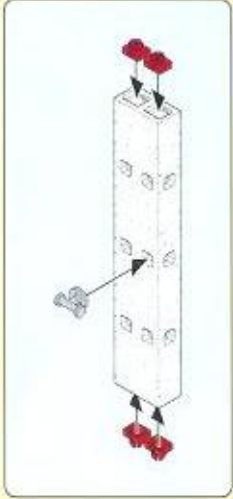

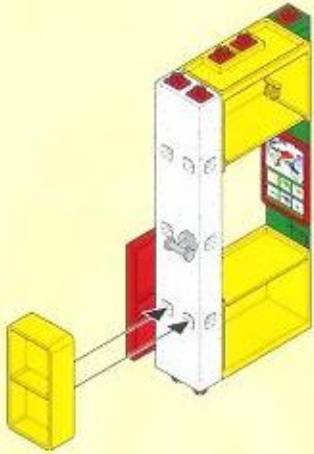
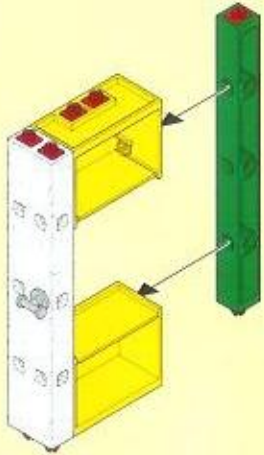
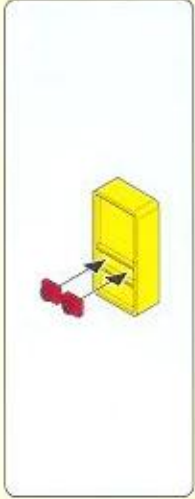
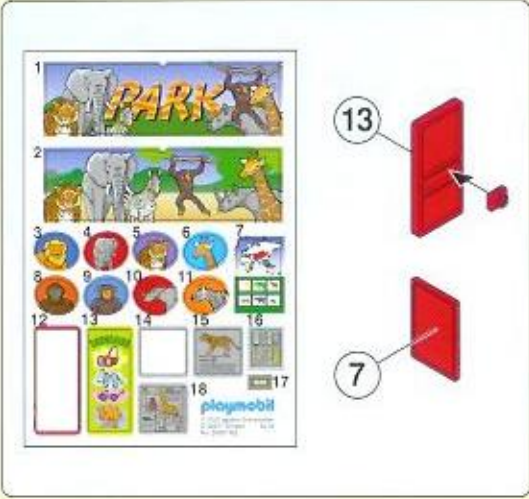

2

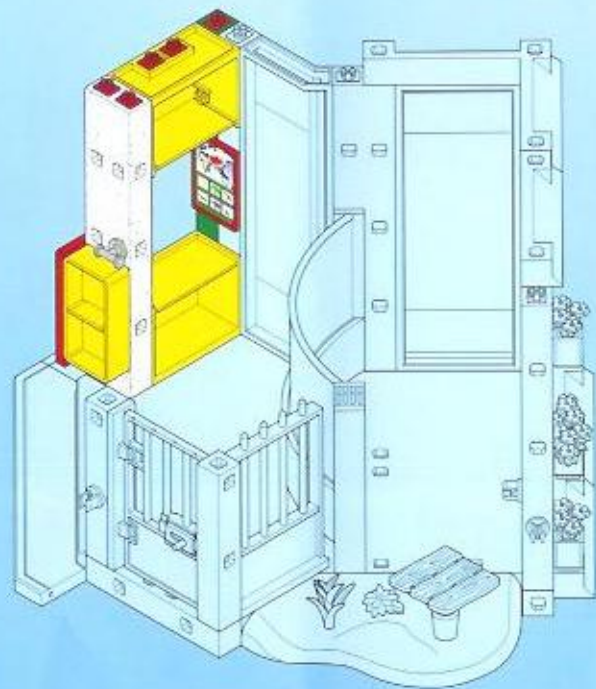

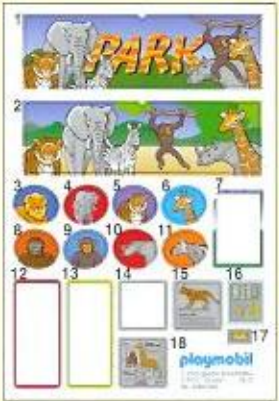

1 4x

2



4 3 6 5 9 8 11 10

This block contains the first two steps of assembly. Step 1 shows a yellow flag with a gold base, labeled '1 4x'. Step 2 shows a parts list for 'PARK' (elephant, lion, giraffe, monkey) and 'playmobil' (12, 13, 14, 15, 16, 17, 18). Below the parts list are four diagrams showing the flag being assembled with numbered parts: 4 and 3, 6 and 5, 9 and 8, and 11 and 10.



35 cm / 13,8 inch

This diagram shows a white string being looped around a grey peg. A red circle highlights the loop, with a dimension line indicating a length of 35 cm / 13,8 inch.

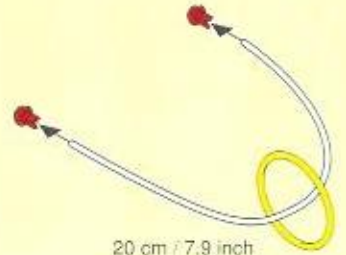

20 cm / 7,9 inch

This diagram shows a white string being looped around a red peg. A yellow circle highlights the loop, with a dimension line indicating a length of 20 cm / 7,9 inch.

2x

1



2

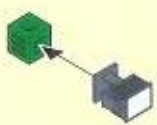

This block contains steps 1 and 2 for a sub-assembly. Step 1 shows a grey assembly of three parts. Step 2 shows a green curved piece being attached to a grey base.

2x



This diagram shows a green curved piece with two red pegs attached to its ends.

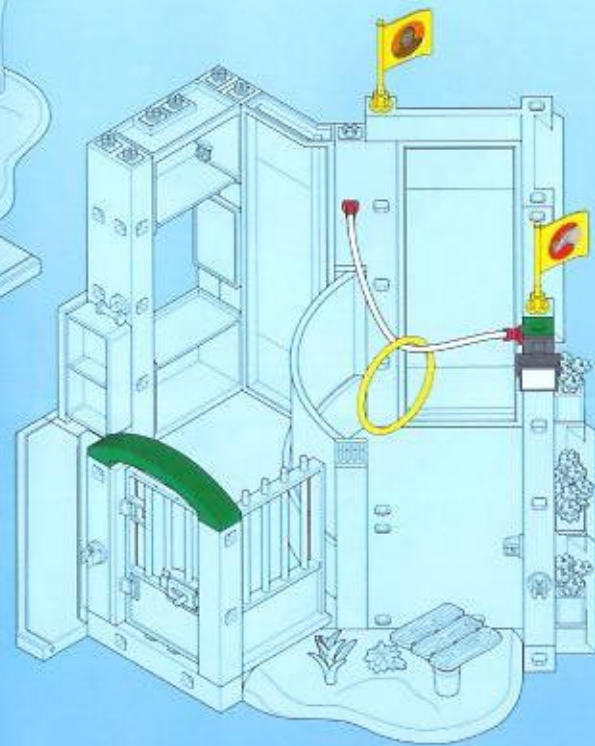
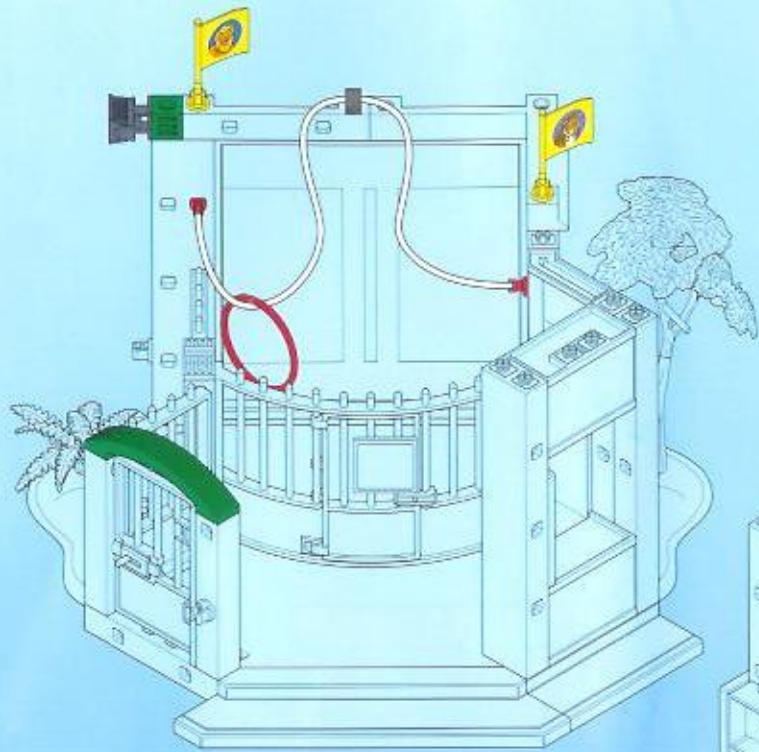

1

2x

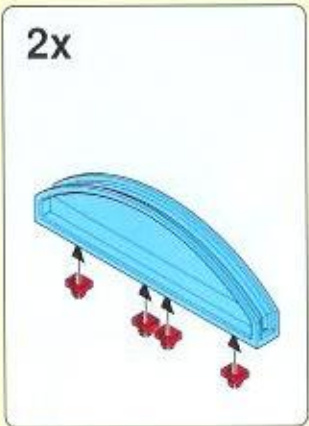

2

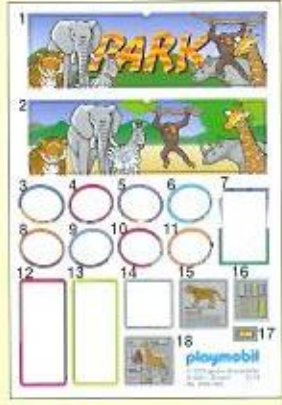
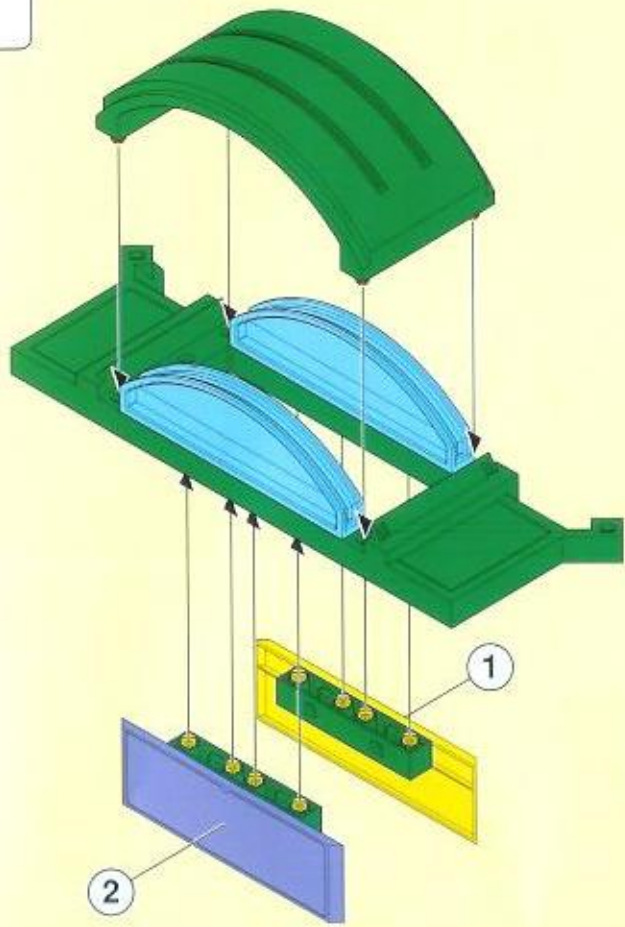
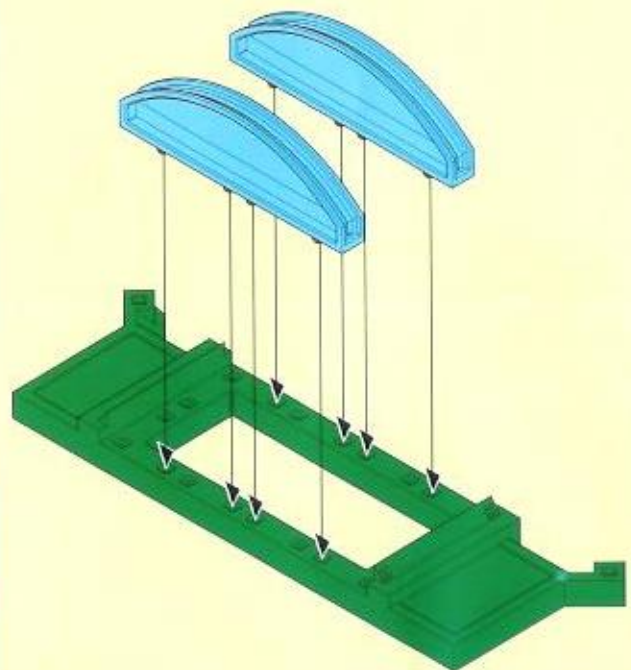
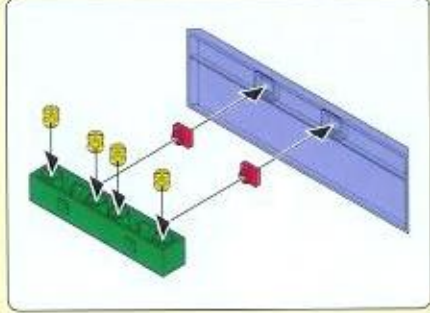
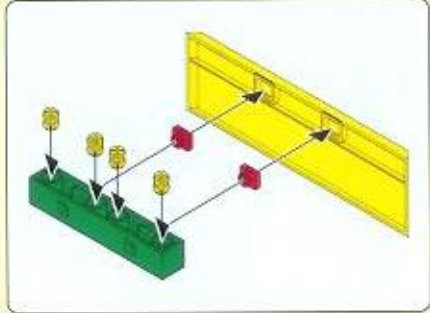
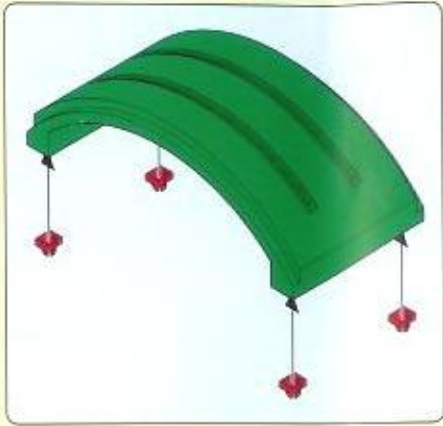

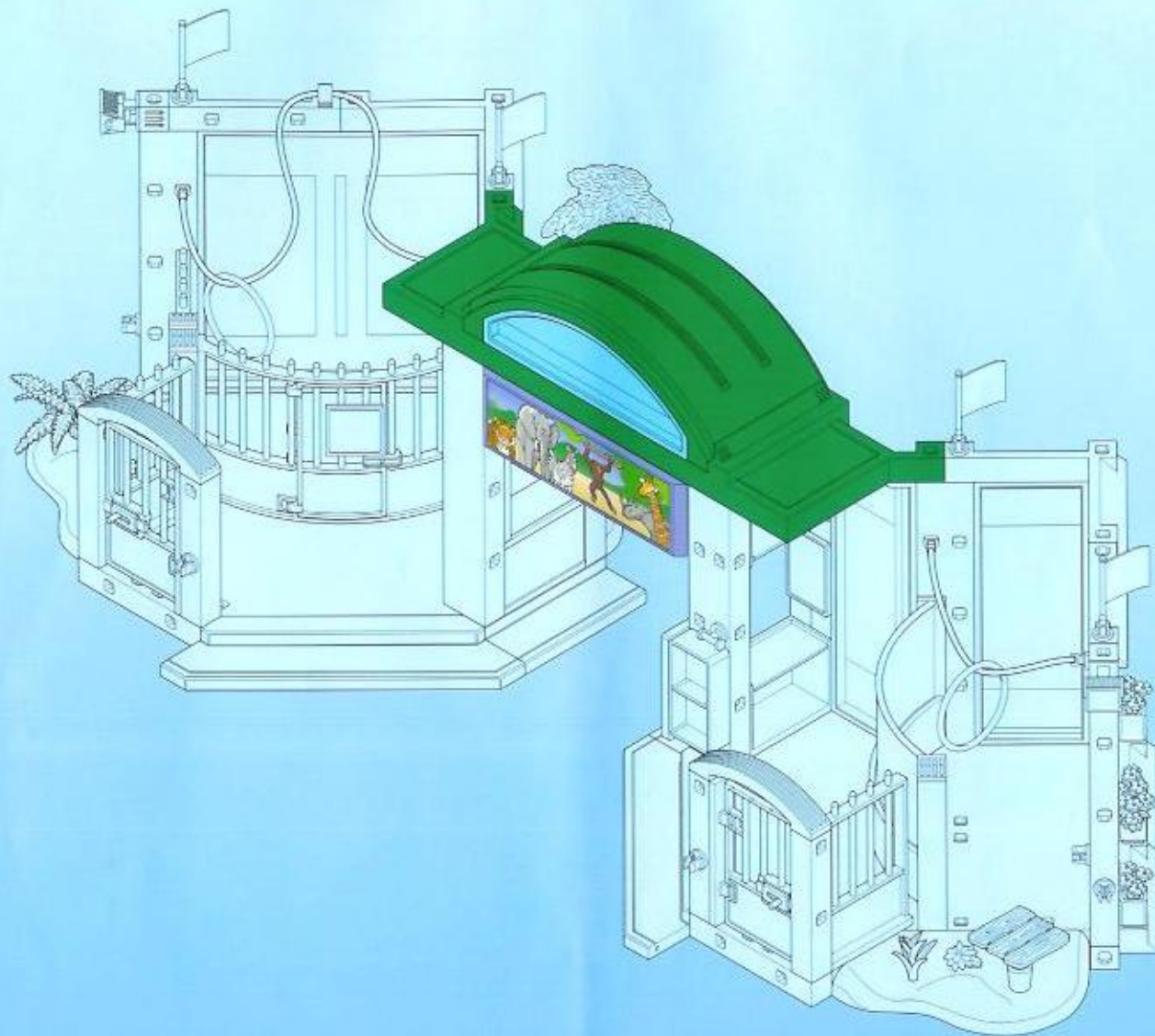

1 5x

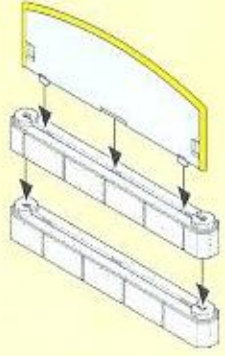

2

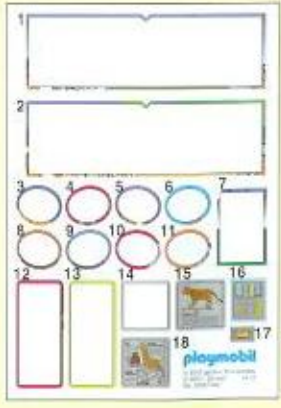
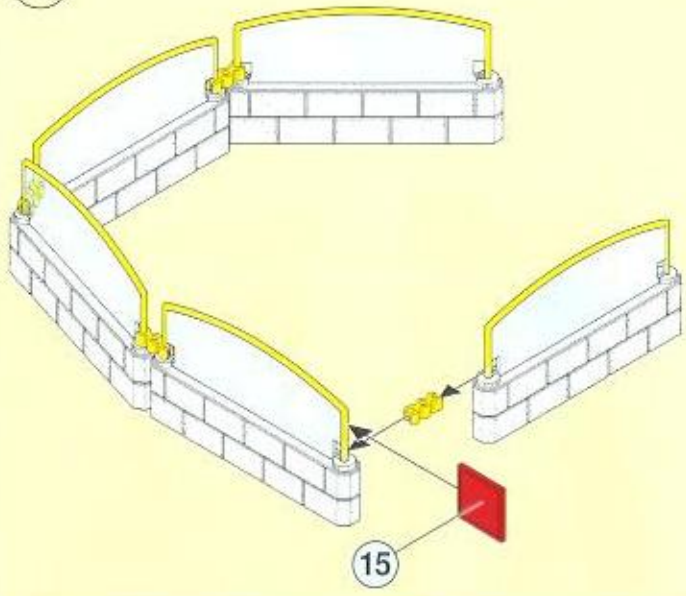

1 5x

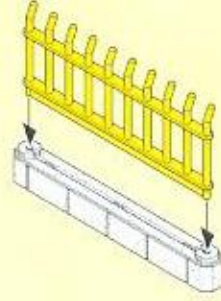

2

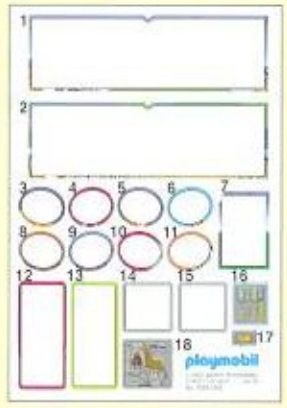
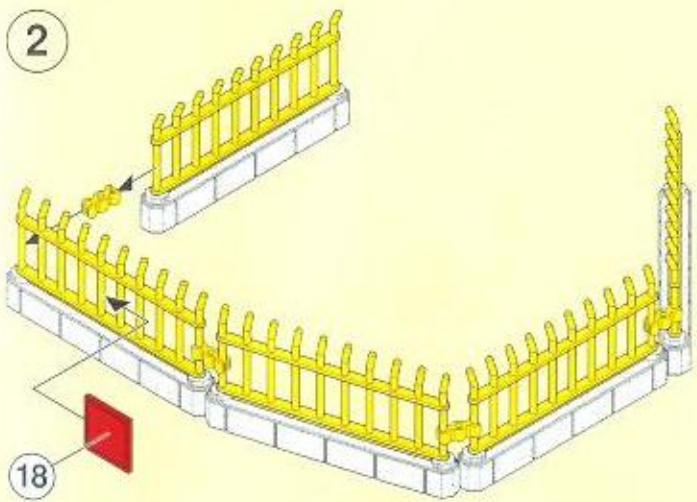

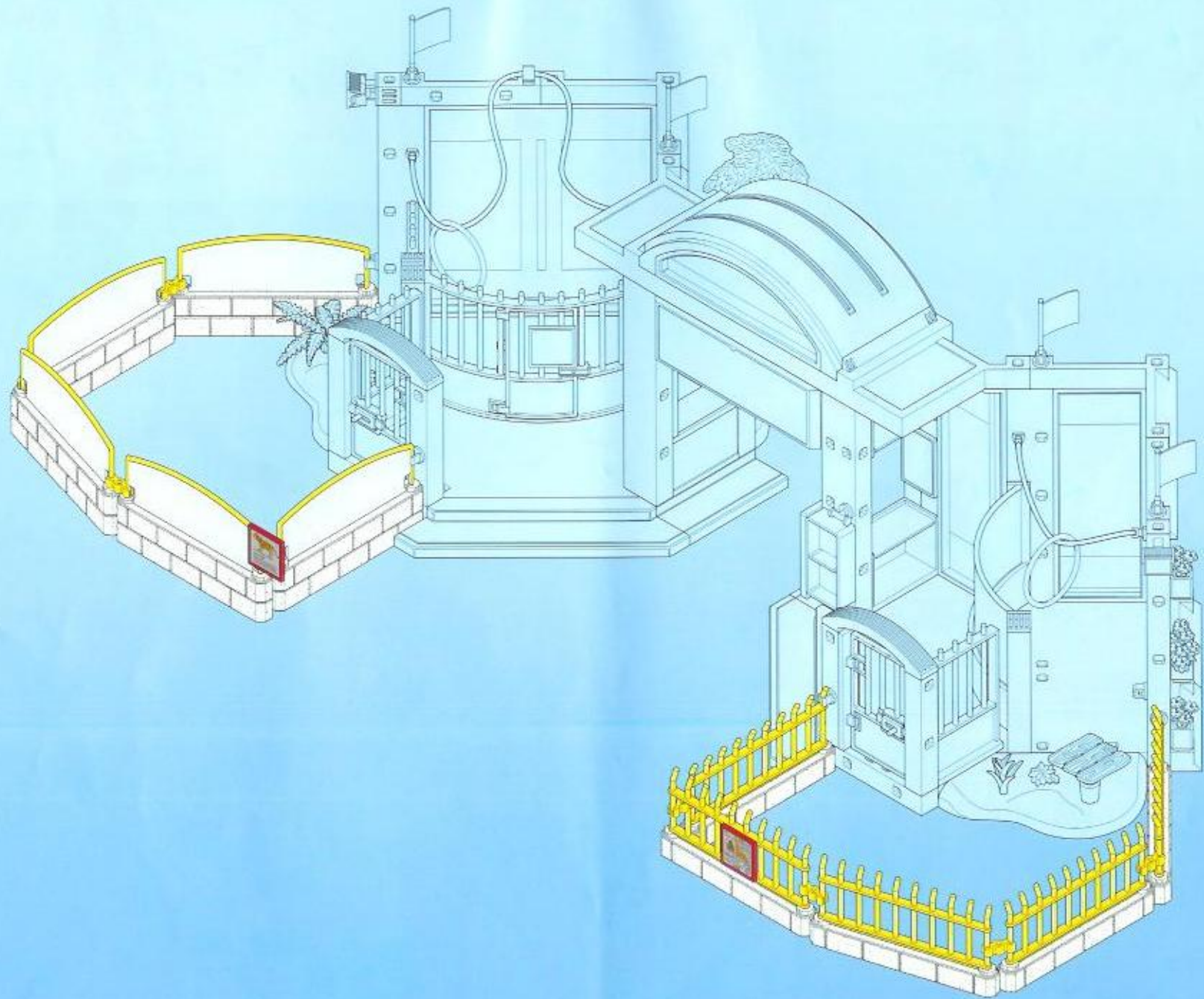

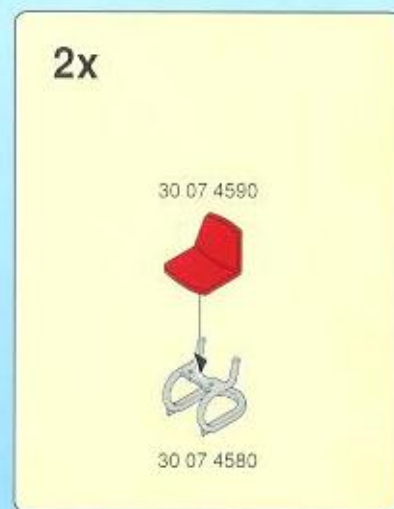
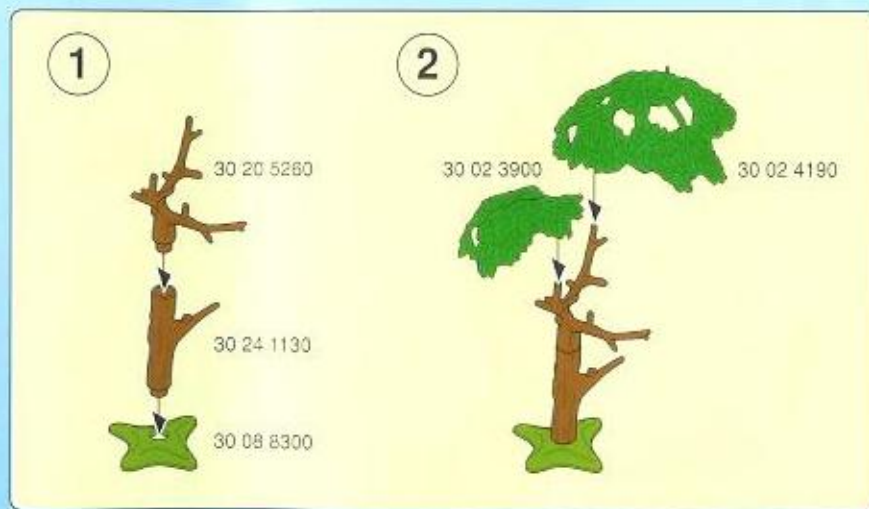
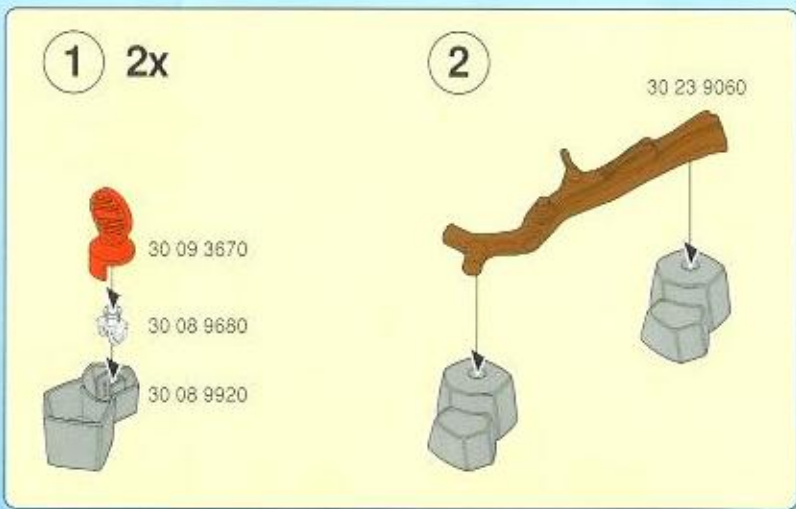
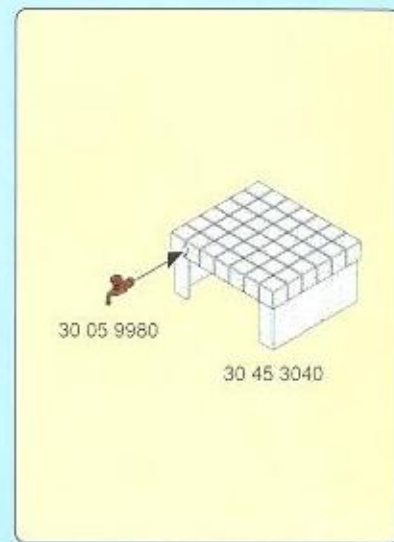
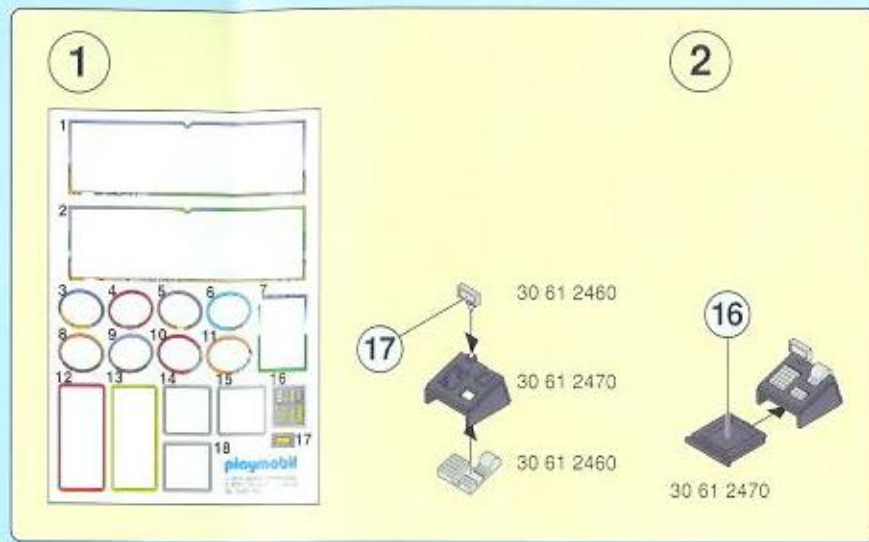
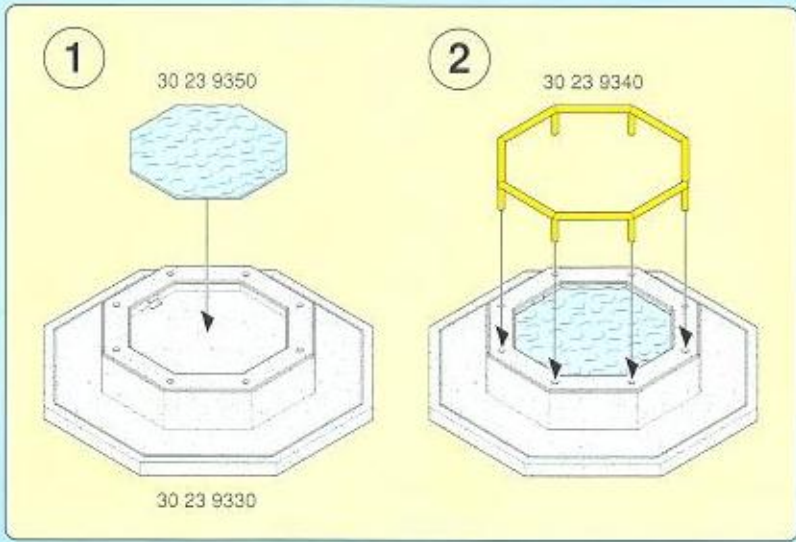

1 30 02 4170
30 23 9400

2 30 62 1922
30 02 4160

3

30 64 3090



30 00 0492

30 23 9020



30 14 2240

30 06 9720



30 00 0482



30 14 2230

30 06 6820



30 10 1570

30 22 3210



30 11 10 40



2x 30 04 1780



30 83 0030



30 83 0010



30 66 8950



30 83 0190



30 65 2250



30 83 0230



30 83 0020



30 09 7010



30 66 0070



2x 30 09 6760



30 07 0500



30 23 9000



30 21 7390



30 08 1190



30 02 6640



30 23 1740



30 23 9010

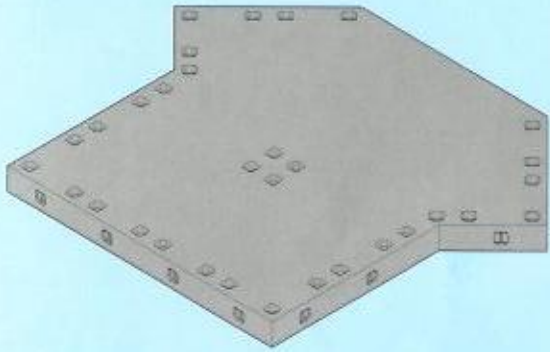

2x 30 22 7190

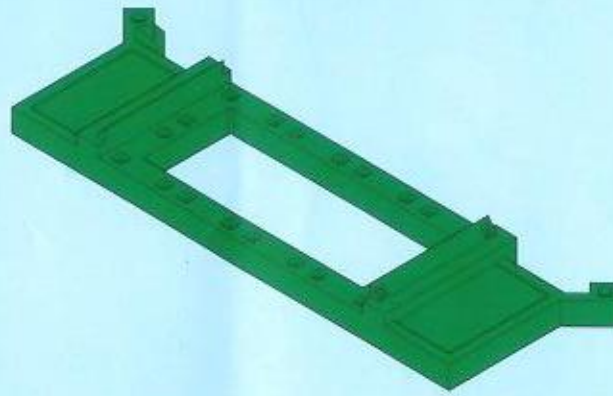

30 23 9250



30 23 9090



2x 30 22 7200



2x 30 22 7210



2x 30 22 7220



5x 30 67 5580



30 67 5850



4x 30 23 9170



2x 30 23 9180

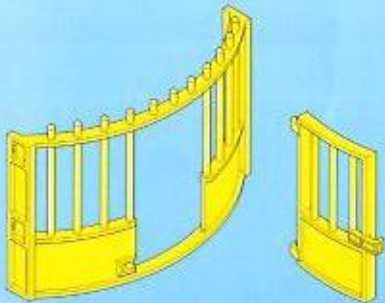

30 61 7160



5x 30 23 8190



2x 30 23 9100

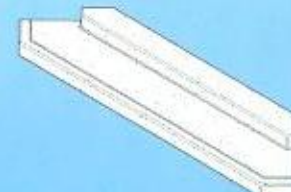

2x 30 23 9310



30 89 1992



30 23 9360

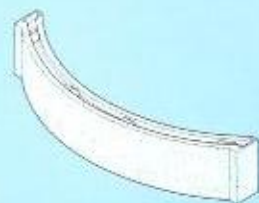

30 23 9320



3x 30 23 9220

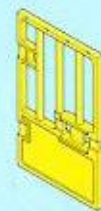

2x 30 23 9230



2x 30 23 9240

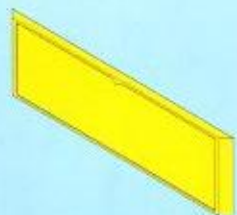

30 23 9260

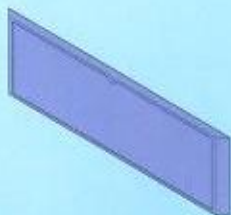

30 23 9270

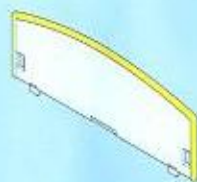

5x 30 23 9380

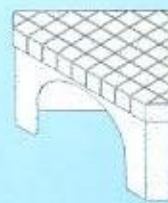

30 45 3050

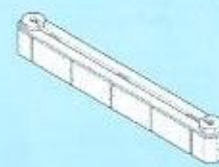

15x 30 23 8180



2x 30 45 3060



2x 30 45 3070



2x 30 23 9300



2x 30 23 9140



2x 30 23 9370



2x 30 23 9280



4x 30 23 9290



7x 30 23 8770

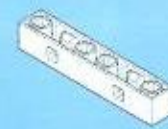

2x 30 23 9120

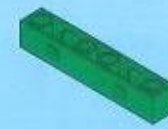

2x 30 23 9110



4x 30 23 9210



30 23 9070



30 23 9080



30 20 6090



30 23 9200



30 23 8480



30 23 8490



4x 30 23 8680



3x 30 23 8830



30 23 9040



30 23 9050



2x 30 61 7410



35 cm /
13,8 inch
30 89 2072



3x 30 02 3900



30 07 9710



30 07 9720



30 22 0920



2x 30 08 5670



30 02 4050



30 21 9200



20 cm /
7,9 inch
30 89 8940



30 23 6120



30 21 5460



30 22 3550



2x 30 04 1630



4x 30 03 2900



2x 30 23 9130



2x 30 23 9190



3x 30 22 7170



4x 30 03 2920



5x 30 05 7420



30 20 4720



30 20 4710



30 22 0420



2x 30 60 6610



30 61 4630



2x 30 04 2760



30 66 7350



2x 30 06 4570



2x 30 06 4560



2x 30 05 4980



2x 30 06 4580



4x 30 21 4450



8x 30 23 8200



30 21 0570



4x 30 23 1490



5x 30 21 0550



30 22 4750



144x 30 09 6900



56x 30 03 6600



16x 30 05 9730



16x 30 05 8710



16x 30 05 9720



16x 30 04 1930



6x 30 02 6600

Serviceadressen finden Sie in allen Playmobil-Prospekten

Addresses of Customer Service Departments are shown in all Playmobil catalogues

L'adresse du service consommateurs est indiquée dans tous les catalogues Playmobil

Troverete gli indirizzi dei centri di assistenza in tutti i cataloghi Playmobil

Las Direcciones de los Departamentos de Servicio al Consumidor se encuentran en todos los catálogos Playmobil

Η διεύθυνση του Γραφείου Εξυπηρέτησης Πελάτη είναι καταγεγραμμένη σε όλους τους καταλόγους Playmobil

pronounce: pläy-mö-bēl