

Instruction Manual

Important:

Read this instruction manual carefully before putting the chain saw into operation and strictly observe the safety regulations!
Keep this instruction manual!

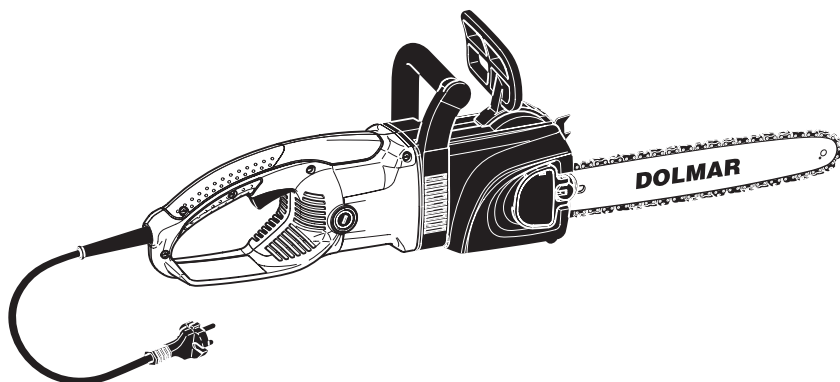

ES-2130 A
ES-2135 A
ES-2140 A
ES-2145 A

<http://www.dolmar.com>

DOLMAR



Thank you for your trust in our product

We congratulate you on your new DOLMAR electric chain saw. We are convinced that you will be satisfied with this modern machine.

DOLMAR electric chain saws are characterized by their robust, high-efficiency motors and high chain velocities which allow an excellent cutting efficiency. They are equipped with numerous state-of-the-art safety devices, are light, handy and can be put into operation immediately wherever electric power is provided.

In order to guarantee the optimal function and performance of your electric chain saw and to ensure your personal safety we would request you to perform the following:

Read this instruction manual carefully before putting the electric chain saw into operation for the first time and strictly observe the safety regulations. Failure to do so can result in serious injury to the operator and/or bystanders.



Symbols

You will notice the following symbols on the chain saw and in the instruction manual:

Table of contents

Page

Symbols	2
Delivery inventory	3
Packing/Disposal	3
Intended use	3
SAFETY PRECAUTIONS	
General precautions	4
Personal protective equipment	4
Putting into operation	4-5
Working behavior/method of working	5-7
Kickback	7
Transport and storage	8
Maintenance	8
First aid	8
Technical data	9
Denomination of components	9
PUTTING INTO OPERATION	
Mounting the guide bar and saw chain	10-11
Tightening the saw chain	11
Checking the chain tension	12
Chain brake, Run-out brake	12
Saw chain oil	13
Refilling the oil tank	14
Lubricating the saw chain	14
Switching on the motor	15
Checking the chain brake	16
Checking the run-out brake	16
Checking the chain lubrication	16
MAINTENANCE	
Sharpening the saw chain	17-18
Cleaning the guide bar/lubricating the sprocket nose	18
Replacing the saw chain	19
Inspecting and replacing the carbon brushes	19
Trouble shooting	20
Instructions for periodic maintenance	20
Service, spare parts and guarantee	21
Extract of spare parts list	22-23
Accessories	22-23
EU conformity declaration	23



Read instruction manual and follow the warnings- and safety precautions!



Particular care and attention!



Wear protective helmet, eye and ear protection!



Pull out the power supply plug!



Pull out the power supply plug if the cable is damaged!



Chain brake released



Chain brake actuated



Kickback!



Forbidden!

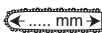

Maximum permissible cut length



Wear protective gloves!



Protect against moisture!



Direction of chain travel



Double protective insulation



Saw chain oil



First aid



Recycling



CE-Marking

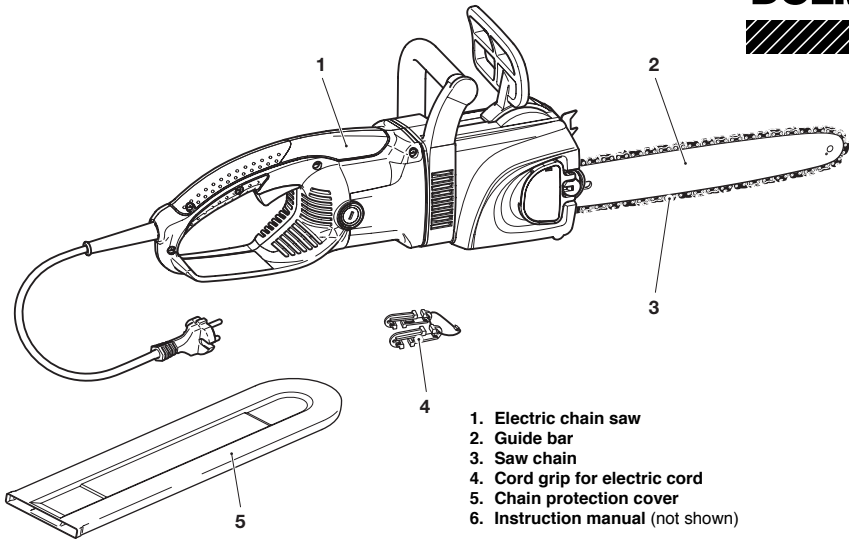

- 1. Electric chain saw
- 2. Guide bar
- 3. Saw chain
- 4. Cord grip for electric cord
- 5. Chain protection cover
- 6. Instruction manual (not shown)

In the case that one of the parts listed should not be included in the delivery inventory, please, consult your sales agent.

Packing/Disposal

The DOLMAR electric chain saw will be delivered in a protective cardboard box to prevent transport damages.

Cardboard is a basic raw material and is therefore consequently reuseable or suitable for recycling (waste paper recycling).



Be a good steward of the environment! Do not dispose of electrical appliances with the household trash!



If the saw is no longer operable or repairable, ask the appropriate waste disposal authority about the proper means of disposal.

In order to preclude any hazard to other persons from a defective electrical appliance, cut off the power cord next to the housing.

CAREFUL! Before cutting off the power cord, pull the plug. Otherwise you can be exposed to a life-threatening shock!

Intended use

Electric saws

This electric saw may be used only for sawing wood. It is intended for occasional use in thin wood, caring for fruit trees, felling, removing limbs, and trimming to length.

Persons who may not use the saw:

This saw must not be used by persons who are not familiar with this instruction manual, children, young people, or anyone under the influence of alcohol, drugs or medication.

SAFETY PRECAUTIONS

General precautions

- To ensure correct operation the user has to read this instruction manual to make himself familiar with the characteristics of the electric chain saw. Users insufficiently informed will risk danger to themselves as well as others due to improper handling.
- It is recommended only to lend the electric chain saw to people who have proven to be experienced with electric chain saws. Always hand over the instruction manual.
- First users should ask the dealer for basic instructions to become familiarized with the characteristics of engine powered sawing.
- Familiarize yourself with the use of an electric chain saw by cutting off lengths from a log on a sawhorse.
- Children and young persons aged under 18 years must not be allowed to operate the electric chain saw. Persons over the age of 16 years may, however, use the chain saw for the purpose of being trained while under supervision of a qualified trainer.
- Use electric chain saws always with the utmost care and attention.
- Operate the electric chain saw only if you are in good physical condition. Perform all work calm and carefully. The user has to accept liability for others.
- Never use the electric chain saw after the consumption of alcohol or drugs or medication.

Personal protective equipment

- In order to avoid head, eye, hand or foot injuries as well as to protect your hearing the following protective equipment must be used during operation of the electric chain saw.
- The kind of clothing should be appropriate, i. e. it should be tight-fitting but not be a hindrance. Do not wear jewellery or clothing which could become entangled with bushes or shrubs.
- The protective helmet (1) is to be checked in regular intervals for damage and is to be replaced after 5 years at the latest. Use only approved protective helmets. If you have long hair wear a hairnet.
- The face shield (2) of the protective helmet (or the goggles) protect against sawdust and wood chips. During operation of the electric chain saw always wear a goggle or a face shield to prevent eye injuries.
- Wear adequate noise protection equipment (ear muffs (3), ear plugs, etc.). Octave brand analysis upon request.
- The protective brace and bib overall (4) is made of a nylon structure with 22 layers and protects against cuts. We strongly recommend its use. In any case wear a long pair of trousers made of solid material during operation of the electric chain saw.
- Protective gloves (5) made of thick leather are part of the prescribed equipment and must always be worn during operation of the electric chain saw.
- During operation of the electric chain saw safety shoes or boots (6) fitted with anti skid sole, steel toe caps and protection for the leg are always to be used. Safety shoes equipped with a protective layer provide protection against cuts and ensure a secure footing.

Putting into operation

- Do not operate the electric chain saw when it rains or in wet or moist environment because the motor is not waterproof.
- If the electric chain saw is moist, it must not be put into operation.
- Avoid physical contact with grounded surfaces.
- Do not operate the electric chain saw next to inflammable gases or dusts. **Explosion hazard.**
- Do always lead the power supply cable behind the user. Take care that the cable is not clamped or cut by sharp-edged objects. Lay the cable such that nobody is endangered.
- Insert the plug only into safety sockets with approved installation. Make sure that the mains voltage corresponds to that on the identification plate. Back-up fuse 16 A. If the saw is going to be used outdoors connect it to a fault-current (FI) circuit breaker with max. 30 mA triggering current.

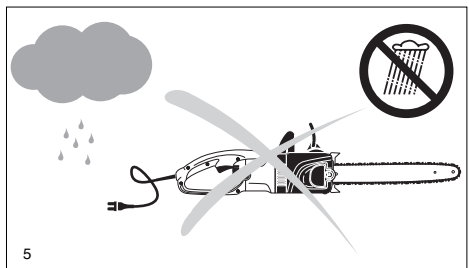
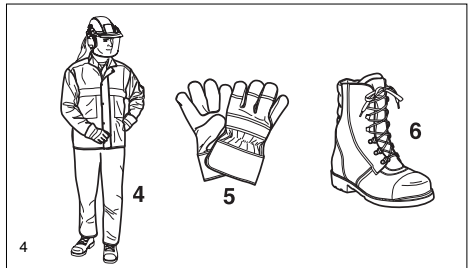
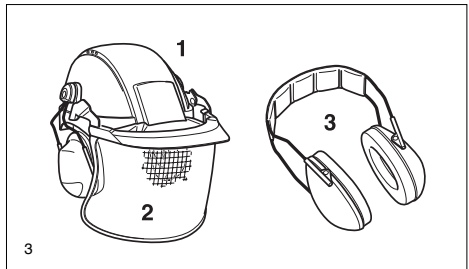
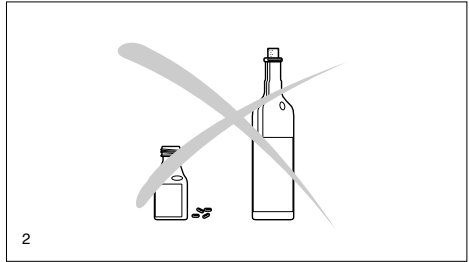
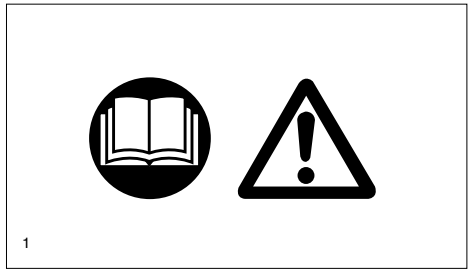

- Pay attention to the diameter of the extension cable. When using a cable roll the cable should be completely wound off. Use only extension cords that meet the specifications in "Technical data". If using the saw out of doors make sure that the extension cord is approved for such use.

Before starting work the electric chain saw must be checked for perfect function and operating safety according to the prescriptions.

Check especially the function of the chain brake, the correct mounting of the guide bar, the correct sharpening and tightening of the saw chain, the firm mounting of the sprocket guard, the easy motion of the power switch, the function of the locking button, the good mechanical condition of cable and plug and the cleanliness and dryness of the handles.

- Put the electric chain saw only into operation if it is completely assembled. Never use the electric chain saw when it is not completely assembled.
- Remove the adjusting tool before switching the saw on.
- All protective installations and guard supplied with the chain saw during operation.
- Make sure that there are no children or other persons within the working range. Also pay attention to any animals in the working vicinity (6).
- Before switching on the electric chain saw ensure that you have a safe footing.
- **When switching on the electric chain saw always hold it with both hands.** Take the back handle with the right hand and the tubular handle with the left hand. Hold the handles tightly with your thumbs facing your fingers. The bar and chain must indicate away from your body (7).
- Switch on the saw only in the manner described in this manual. Do not overload your saw. It will work better and more safely if you use it within its intended performance range.
- Switch off the electric chain saw immediately if you observe a change in its operating behavior.

CAUTION: When releasing the power switch the chain keeps on running for a short period of time (free-wheeling).

- Protect the power cord from heat, oil and sharp edges.
- Route the power cord in such a way that it cannot get caught in branches or other objects during sawing. - If the cable is being damaged or cut, pull out the power supply plug immediately.
- If the sawing device is hit by stones, nails or other hard objects, pull out the power supply plug and check the sawing device immediately.
- **Pull out the power supply plug before checking the chain tension, tightening the chain, replacing it or clearing malfunctions.**
- When stopping work or leaving the electric chain saw switch off the chain saw and pull out the power supply plug. Put the electric chain saw in a safe location to prevent danger to others.
- For refilling the oil tank the power supply plug must be pulled out. Do not smoke or light open fires.
- Avoid skin or eye contact with mineral oil products. Always wear gloves when refilling the oil tank.
- Take care that no chain oil oozes into the soil (environmental protection). Use an appropriate base.
- If oil has been spilled, clean the electric chain saw immediately.

Working behavior/method of working

- Do not work on your own. There must be someone around in case of an emergency (within shouting distance).
- During sawing operation always hold the electric chain saw with both hands. Thus you will be able to guide it safely.
- Only use the electric chain saw during good light and visibility periods. Be aware of slippery or wet areas, and of ice and snow (risk of slipping). The risk of slipping is extremely high when working on recently peeled wood (bark).
- Never work on unstable surfaces. Make sure that there are no obstacles in the working area, risk of stumbling. Always ensure that you have a safe footing.
- Never saw above your shoulder height.
- Never saw while standing on a ladder.
- Never climb up into trees to perform sawing with the electric chain saw.
- Never bend forward by far to perform sawing.

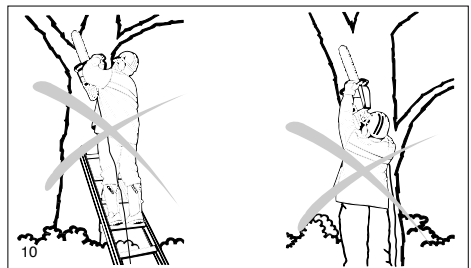
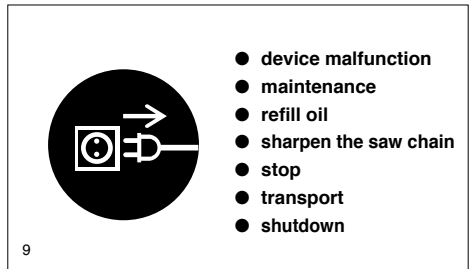
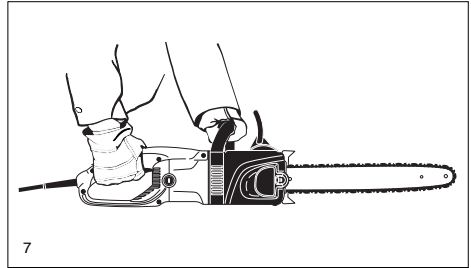
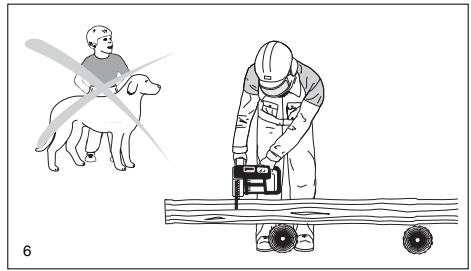

- Guide the electric chain saw in such a way that no part of your body is within the elongated swiveling range of the saw (11).
- Use the electric chain saw for sawing wood only.
- Do not let the chain touch the ground when it is running. If you are cutting wood lying directly on the ground, turn it over before completing the cut so that you do not cut into the ground.
- Clear the area of the cut of foreign objects such as sand, stones, nails, wire etc. Such objects can damage the blade and cause dangerous kickback.
- When sawing precut timber or thin woods use a safe support (sawing jack, 12). When sawing precut timber or thin pieces use a stable support (sawhorse, 12). Do not saw stacked timber! Do not let another person steady the timber, and do not steady it with your foot!
- Secure round timber.
- When working on slopes, always work facing the slope.

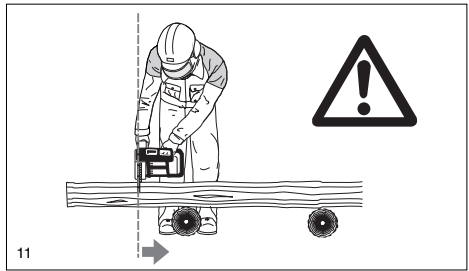

For performing crosscuts the toothed ledge (12,Z) must be applied to the timber to be cut.

- Before performing a **crosscut** firmly apply the toothed ledge to the timber, only then can the timber be cut with the chain running. For this the electric chain saw is lifted at the back handle and guided with the tubular handle. The toothed ledge serves as a center of rotation. Continue by slightly pressing down the tubular handle and simultaneously pulling backwards the electric chain saw. Apply the toothed ledge a little bit deeper and once again lift the back handle.
- The sawing device must be running whenever you remove the electric chain saw from the timber.
- When performing several cuts the electric chain saw must be switched off in between.

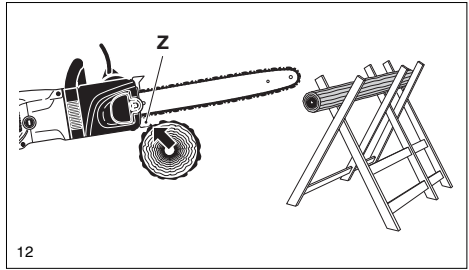

When the timber must be pierced for cutting or longitudinal cuts are to be performed it is urgently recommended to have these works carried out by specially trained persons only (high risk of kickbacks).

- For performing **longitudinal cuts** (13) apply the sawing device at an angle which is as small as possible. Be very careful when carrying out this kind of work because the toothed ledge cannot be used.
- When cutting with the bottom edge of the bar the electric chain saw may be pushed in the direction of the user if the chain is clamped. For this reason use the top edge of the bar whenever possible. The electric chain saw will then be pushed away from your body (14).

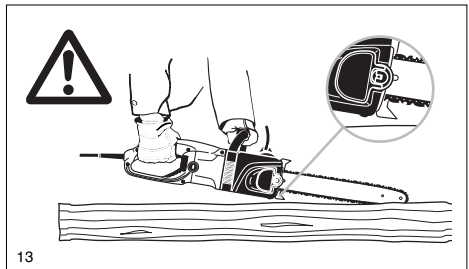

- If the timber is not free of tension (15), first cut the pressure side (A). Then the crosscut can be performed on the tension side (B). Thus clamping of the bar is avoided.
- Be very careful when cutting splintery wood. Cut pieces of wood may be pulled along (risk of injuries).
- Never use the electric chain saw for lifting up or removing pieces of wood or other objects.
- When releasing the tension the electric chain saw should be supported on the trunk (risk of kickbacks).

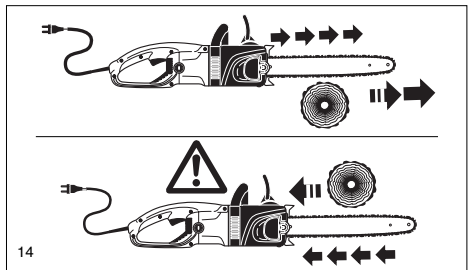

Tension releasing works must be carried out by trained persons. High risk of injuries.

- Be aware of branches under tension. Do not cut free branches from below.
- Never perform tension releasing works standing on the trunk.
- **Do not use the electric chain saw for works in the forest, i. e. for cutting down trees or carrying out tension releasing works. The user's mobility and safety necessary for this kind of work are not guaranteed due to the cable connection.**

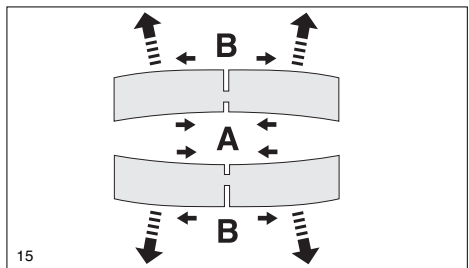

CAUTION:

Do not fell or debranch trees unless you are specially trained for it! There is a high risk of injury! Make sure to follow local regulations.

- Before cutting down a tree ensure that
 - a) only those persons are within the working range which are actually involved in cutting down the tree
 - b) all persons involved in the felling have an unobstructed retreat route (the retreat path should be about 45° diagonally and to the rear away from the direction of fall). Be aware of the increased risk of stumbling from electric cables!
 - c) the bottom part of the trunk is free from foreign bodies, underbrush and branches. Make sure to have a safe footing (risk of stumbling).
 - d) the next working place is at least 2 1/2 tree lengths away (16). Before cutting down the tree check the direction of fall and make sure that there are neither other persons nor any objects within a distance of 2 1/2 tree lengths (16).

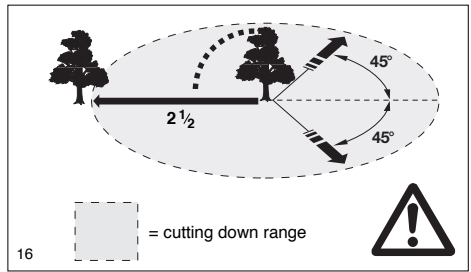

- Judging the tree:
 - Direction of hanging - loose or dry branches - height of the tree - natural hang over - is the tree rotten?
- Take into account the direction and the velocity of the wind. If strong gusts are occurring, do not perform any cutting down works.
- Cutting the roots:
 - Start with the strongest root. First perform the vertical and then the horizontal cut.
- Notching the trunk (A, 17):
 - The notch determines the direction of fall and guides the tree. The trunk is notched perpendicular to the direction of fall and penetrates 1/3 -1/5 of the trunk diameter. Perform the cut near the ground.
- When correcting the cut always do so over the whole width of the notch.
- Cut down the tree (B, 18) above the bottom edge of the notch (D). The cut must be exactly horizontal. The distance between both cuts must be approx. 1/10 of the trunk diameter.
- The material between both cuts (C) serves as a hinge. Never cut it through, otherwise the tree will fall without any control. Insert felling wedges in the cut (B, 18) in good time.
- Secure the cut only with wedges made of plastic or aluminium. Do not use iron wedges.
- When cutting down a tree always stay sideways of the falling tree.
- When withdrawing after having performed the cut down be aware of falling branches.
- When working on a sloping ground the user of the electric chain saw must stay above or sideways of the trunk to be cut or the already cut down tree.
- Be aware of trunks which may roll towards you.

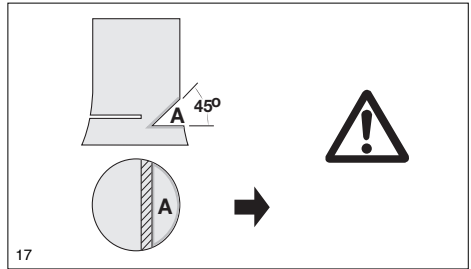

Kickback

- When working with the electric chain saw dangerous kickbacks may occur.
- Kickback occurs when the tip of the blade (especially the top quarter) inadvertently comes into contact with wood or other solid objects.
- In this case the electric chain saw is thrown without any control and with high energy potentials in the direction of the user (**risk of injuries**).
- In order to prevent kickbacks follow the indicated instructions:**
- Never apply the end of the bar when starting to make a cut. Always observe the end of the bar.
- Never use the bar end for sawing. Be careful when continuing to cut.
- When starting to perform a cut the chain must be running.
- Ensure that the chain is always sharpened correctly. Pay special attention to the height of the depth limiter (for detailed information see the chap. "Sharpening the saw chain").
- Never cut several branches at the same time. When cutting a branch ensure that no other branch is touched.
- When crosscutting a trunk be aware of the trunks next to it. It is recommended to use a saw jack.

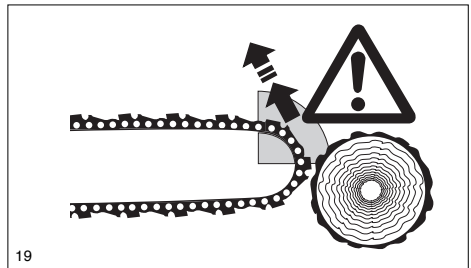
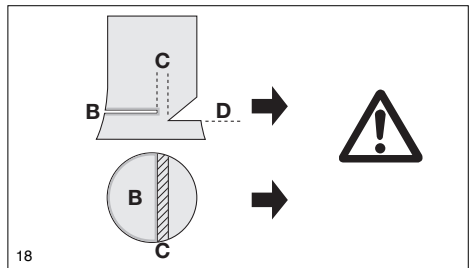

Transport and storage

- Carry the electric chain saw with the tubular handle. The saw bar indicates backwards. **Never carry or transport the electric chain saw with the chain running.**
- Never carry the saw by the power cord. Do not disconnect the plug by pulling on the power cord.
- When changing your position during work switch of the electric chain saw and actuate the chain brake in order to prevent an inadvertent start of the chain.
- When transporting the electric chain saw over long distances the power supply plug must be pulled out and the bar protection cover, included in the delivery, must be applied (20).
- Ensure safe positioning of the electric chain saw during car transportation to avoid oil leakage.
- Store the saw in a secure, dry, lockable room out of reach of children. It must not be stored outdoors.
- For storing the electric chain saw over a long period of time or shipping it the oil tank must be completely emptied.
- Only use approved and marked containers for transporting and storing chain oil.

Maintenance

- **For performing maintenance works switch of the electric chain saw, pull out the power supply plug and secure it (21).**
- Before starting to work, always make sure that the saw is in safe working order, in particular the chain brake and run-out brake. Make sure that the saw chain is always sharpened and tightened correctly (22).
- Have the chain brake and run-out brake inspected regularly (see "Chain brake, run-out brake").
- Regularly check the cable to the power supply for damage of the covering.
- Regularly clean the electric chain saw.
- If the plastic case is damaged, have it immediately repaired by a skilled person.
- Regularly check the tank cap for tightness.
- Do not use the saw if the ON/OFF switch is defective. Have it repaired by a qualified person.

Observe the accident prevention instructions issued by the competent trade federations and insurance companies.

Do not perform any modifications on the electric chain saw. You will endanger your safety.

Perform only the maintenance and repair works described in the instruction manual. All other works must be carried out by the DOLMAR service.

Use only original DOLMAR spare parts and accessories.

Applying spare parts which are not original DOLMAR parts or accessories and bar/chain combinations or lengths results in a high risk of accidents. For accidents and damage resulting from using sawing devices or accessories which have not been approved we cannot accept any responsibility.

First aid

For the event of a possible accident, please, make sure that a first aid box is always immediately available close by. Immediately replace any items used from the first aid box.

Should you ask for help, please, give the following information:

- place of accident
- what happened
- number of injured persons
- kind of injuries
- your name.

NOTE

Individuals with poor circulation who are exposed to excessive vibration may experience injury to blood vessels or the nervous system.

Vibration may cause the following symptoms to occur in the fingers, hands or wrists: "Falling asleep" (numbness), tingling, pain, stabbing sensation, alteration of skin colour or of the skin.

If any of these symptoms occur, see a physician!

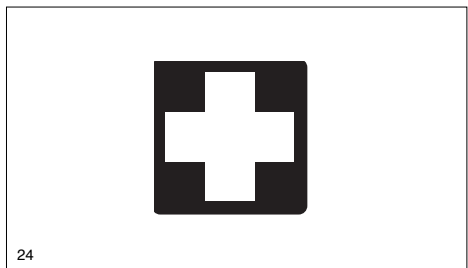
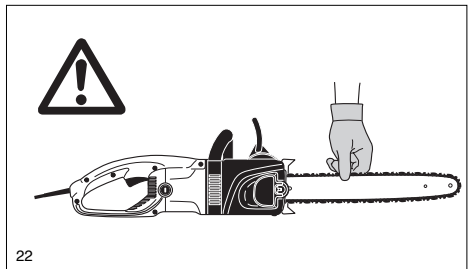
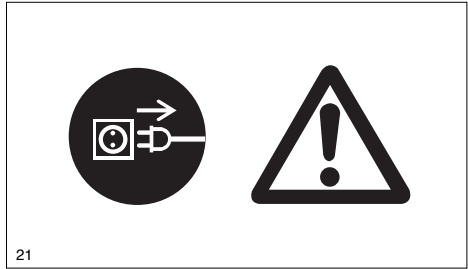
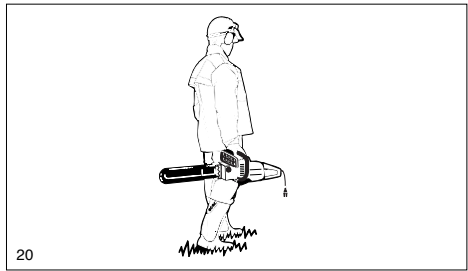

Technical data

		ES-2130 A	ES-2135 A	ES-2140 A	ES-2145 A
Power consumption	Watt	2000			
Nominal voltage	V	230 - 240 ~			
Mains frequency	Hz	50 - 60			
Nominal current	A	8,8			
Cable length	cm	30 / 500			
Chain type		092			
Chain pitch	inch	3/8"			
Length of a cut	cm	30	35	40	45
Max. chain speed	m/s	13,3			
Sound power level $L_{WA,av}$ per EN 60745-2-13	dB (A)	101,8			
Sound pressure level $L_{PA,av}$ at the workplace per EN 60745-2-13	dB (A)	90,8			
Vibration acceleration $a_{h,w,av}$ per EN 60745-2-13					
- Tubular handle	m/s ²	4,7			
- Rear handle	m/s ²	5,6			
Oil pump		automatic			
Oil tank capacity	ml	140			
Power transmission		direct			
Overload protection		electrical			
Chain brake		manually actuated			
Run-out brake		electrical			
Weight (without bar/chain)	kg	4,4			
Weight (with bar/chain)	kg	5,0	5,1	5,2	5,3
Radio interference suppression / EMC		Per EMC Directive 2004/108/EG			
Protective case		class II (double protective insulation)			
Extension cable (not included)		DIN 57282/ HO 7RN-F L= 30 m max., 3x1,5 mm ²			

Denomination of components

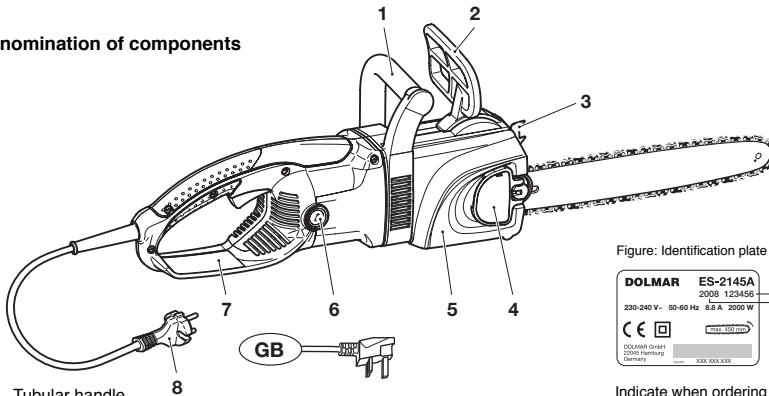
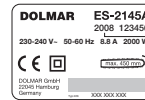

Figure: Identification plate ES-2145A



Serial number
Year of manufacture

Indicate when ordering spare parts!

- 1 Tubular handle
- 2 Hand guard (release for chain brake)
- 3 Spike bar
- 4 Sprocket guard quick tightener
- 5 Sprocket guard, chain brake
- 6 Carbon brush cover
- 7 Back hand guard
- 8 Power cord with plug
- 9 Guide bar
- 10 Oil tank cap
- 11 Identification plate
- 12 Locking button
- 13 Rear handle
- 14 Power switch
- 15 Sightglass for oil level
- 16 Saw chain
- 17 Cord grip for electric cord (pull relief)

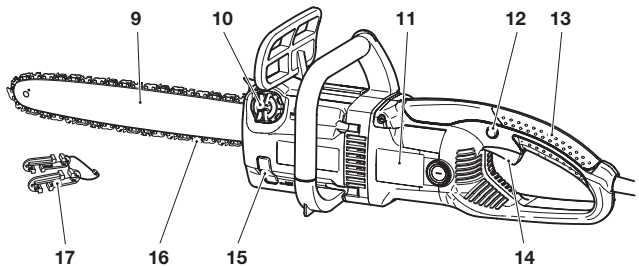

PUTTING INTO OPERATION



CAUTION: When working on the guide bar or saw chain always wear protective gloves and pull out the power supply plug.

CAUTION: Switch on the electric chain saw only after having assembled it completely and inspected!

A

Mounting the guide bar and saw chain

Put the electric chain saw on a stable surface and carry out the following operations for mounting the bar and chain:

Release chain brake. To do this, pull the hand guard (1) in the direction of the arrow.

Flip up the sprocket guard quick tightener (2) (see also Fig. G).

Push in the sprocket guard quick tightener firmly against spring pressure, and slowly turn it **counter-clockwise** until you feel it engage. Keep pushing in, and turn it as far as possible counter-clockwise.

Release the sprocket guard quick tightener (remove pressure) and now turn it **clockwise** to its original position. Repeat this procedure until the sprocket guard (3) is unscrewed.

Pull the sprocket guard (3) up slightly, pull out of the rear fittings (4) and remove.

B

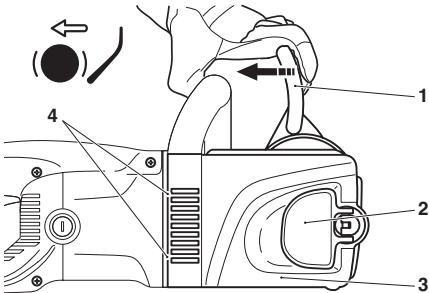

Position the guide bar (7) and push it against the sprocket (6).

C

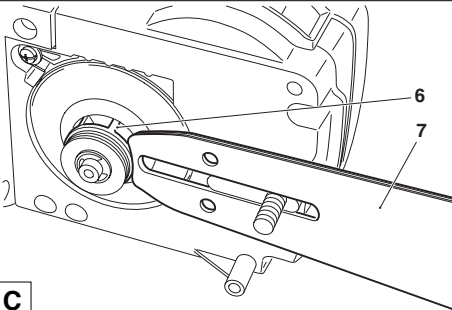

Place the saw chain (9) on the sprocket (6). Using your right hand, guide the saw chain into the upper guide groove (8) of the guide bar.

The cutting edges of the saw chain on the top of the guide bar must point in the direction of the arrow!

D

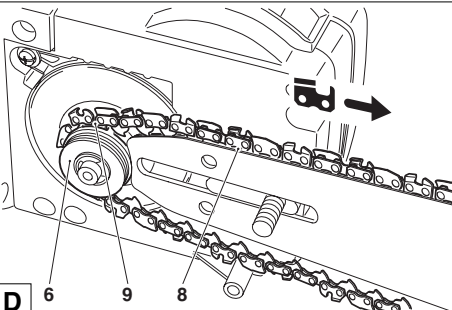

Using your left hand, lightly press the guide bar against the holder on the housing and guide the saw chain (9) around the nose sprocket (10) on the guide bar. While doing this, pull the saw chain slightly in the direction shown by the arrow.

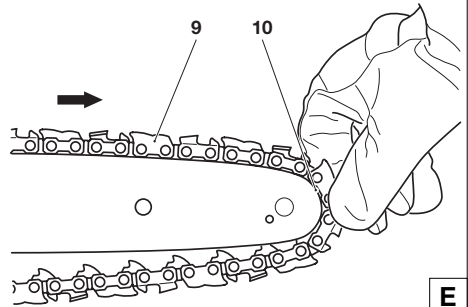

E

Line up the hole in the sprocket guard with the threaded pin (11).

Turn the chain tensioning screw (H/14) to align the chain tensioning pin (12) with the hole in the guide bar.

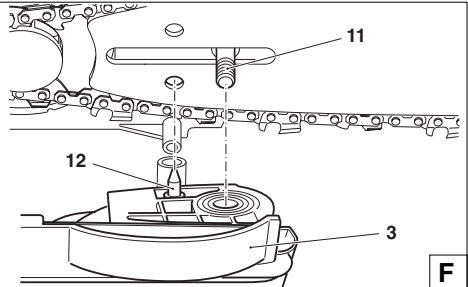

F

First press the sprocket guard (3) into the mounting (13) and then push it onto the threaded pin (11).

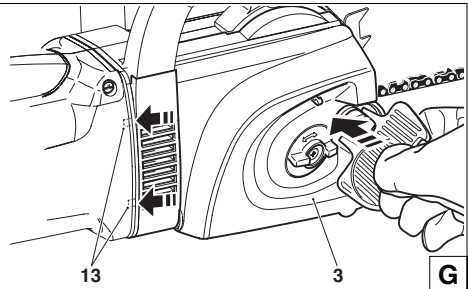

G

Tightening the saw chain

Firmly push in and simultaneously turn the sprocket guard quick tightener (2, clockwise) in order to screw on the sprocket guard (3), but do not tighten it yet.

Lift the tip of the guide bar slightly and turn the chain tenser (14) clockwise until the saw chain engages in the guide groove on the lower side of the guide bar (see the circle).

Push in the sprocket guard quick tightener (2) again and tighten by turning clockwise.

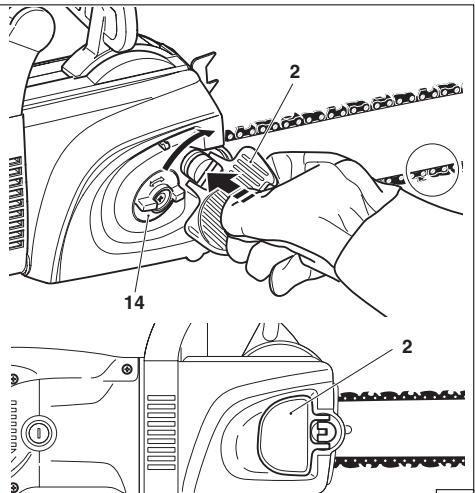

H

Release the sprocket guard quick tightener (2) (remove pressure) until it turns freely, then fold it in as shown in the illustration.



Checking the chain tension

The chain has the proper tension when it lies against the bottom edge of the guide bar and can be easily pulled by hand about 2-4 mm (about 1/8") up from the guide bar.

Check the chain tension frequently - new chains tend to get longer during use!

When checking the chain tension the motor must be **switched off** and the power supply plug **pulled out**. **If the chain is too loose:** Loosen the sprocket guard quick tightener by about a quarter turn. Tighten the chain as described under "Tightening the saw chain."

HINT:

Use 2 or 3 saw chains alternately for even wear of the chains, sprocket and guide bar running surfaces.

In order to guarantee a uniform wear of the groove in the bar the bar should be turned over whenever replacing the chain.



I

Chain brake

These models come with a chain brake as standard equipment. If there is a kickback resulting from the guide bar tip impacting the wood (see SAFETY INSTRUCTIONS, page 7), the back of the hand hitting the handguard will engage the chain brake.

The chain will stop within a fraction of a second.

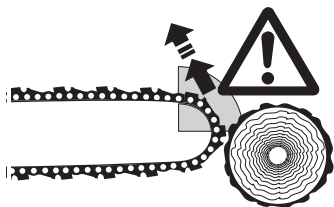

Run-out brake

The electric chain saw come with a run-out brake as standard equipment.

The run-out brake ensures that the chain comes to a stop immediately when the ON/OFF switch is released, thus preventing the chain from continuing to run and presenting a hazard.

Testing of the run-out brake is described on page 16.

DOLMAR

SERVICE

Chain and run-out brake maintenance

The brake systems are very important safety features, and like any other part they are subject to a certain amount of wear. Regular inspection and maintenance is important for your personal safety, and can be properly performed only by a DOLMAR service centre.

J

Engaging the chain brake (braking)

With your left hand, press the handguard (1) towards the tip of the guide bar (arrow 2).

Releasing the chain brake

Pull the hand guard (1) towards you (arrow 3) until you feel it catch. The brake is now released.

Note:

When the chain brake is actuated the power supply to the motor will be cut off. Testing of the chain brake is described on page 16.

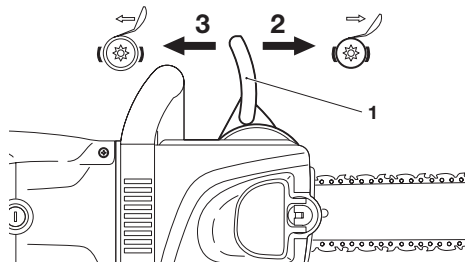

K

Saw chain oil



Use a special oil with adhesive addition for lubricating the saw chain and bar. The adhesive addition prevents that the oil is centrifuged too fast from the sawing device.

Do not use mineral oils. In order to protect the environment the use of biologically decomposable oil is prescribed.

The saw chain oil sold by DOLMAR, called BIOTOP, is made of special vegetable oils and is biologically decomposable to 100%. BIOTOP has been granted the "blue angel" for being particularly favourable to the environment (RAL UZ 48).



BIOTOP oil is available in the following packing sizes to suit your individual requirements:

1 liter	order number 980 008 210
5 liters	order number 980 008 211
20 liters	order number 980 008 213

Biologically decomposable oil is stable only for a limited period of time. It should be consumed within 2 years from the date of manufacture (printed on the container).

A

Important note on bio-degradable chain oils

If you are not planning to use the saw again for an extended period of time, empty the oil tank and put in a small amount of regular **engine oil** (SAE 30), and then run the saw for a time. This is necessary to flush out all remaining bio-degradable oil from the oil tank, oil-feed system, chain and guide bar, as many such oils tend to leave sticky residues over time, which can cause damage to the oil pump or other parts.

The next time you use the saw, fill the tank with BIOTOP chain oil again. In case of damage caused by using waste oil or inappropriate chain oil the product guarantee will be null and void.

Your salesman will inform you about the use of chain oil.

NEVER USE WASTE OIL

Waste oil is very dangerous for the environment.

Waste oil contains high amounts of carcinogenic substances.

The residues in the waste oil result in a high degree of wear and tear at the oil pump and the sawing device.

In the case of damage caused by using waste oil or inappropriate saw chain oil the product guarantee will be null and void.

Your salesman will inform you about the use of saw chain oil.



AVOID SKIN AND EYE CONTACTS

Mineral oil products as well as oil degrease the skin. If your skin repeatedly comes in contact with these substances for a longer period of time, it will desiccate. Various skin diseases may result. In addition, allergic reactions are known.

Eyes can be irritated by contact with oil. If oil gets into your eyes, immediately wash them with clear water. If your eyes are still irritated, go to see a doctor.



B

Refilling the oil tank



Only if the motor is switched off and the power supply plug is pulled out!

- Thoroughly clean the oil tank around the cap to prevent dirt from entering the tank.
- Unscrew the tank cap (1) and fill in chain oil until it is on a level with the bottom edge of the filler socket.
- Tightly screw on the tank cap.
- Thoroughly remove any oil that has overflowed.

Important!

Before operating the saw for the first time, the oil feed system must be completely filled, until the chain oil lubricates the chain and guide bar.

This procedure can take up to two minutes.

- The oil level can be controlled in the sight glass (2).

In order to ensure sufficient lubrication of the saw chain there must always be enough oil in the tank.

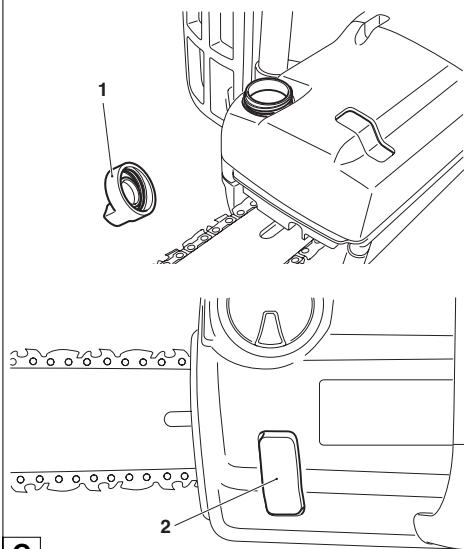

C

Lubricating the saw chain

Only if the motor is switched off and the power supply plug is pulled out!

To guarantee a troublefree operation of the oil pump the oil guide groove (3) as well as the oil inlet bore in the guide bar (4) must be cleaned in regular intervals.

Note:

After the saw has been turned off it is normal for residual chain oil to drip from the oil feed system, the guide bar and the chain for a time. This does **not** constitute a defect!

Place the saw on a suitable surface.

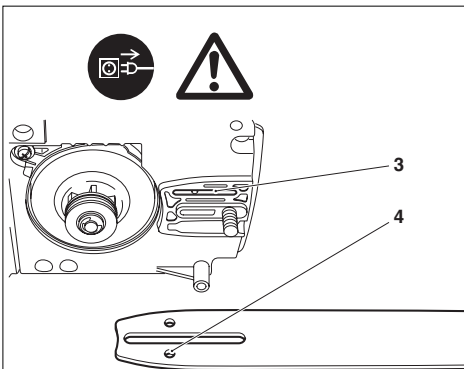

D

Plug in the saw

CAREFUL!

Before connecting the saw to a source of electricity, always make sure to check that when the ON/OFF switch (1) has been pressed in and released, it automatically comes back out to the "off" position. If it does not, do not under any circumstances connect the saw to a power source - do not plug it in. Take the saw to a DOLMAR service centre before doing any work with it.

Clip the extension cord and the saw's power cord into the cord grip (2).

Plug the saw plug (3) into the socket of the extension cable (4).

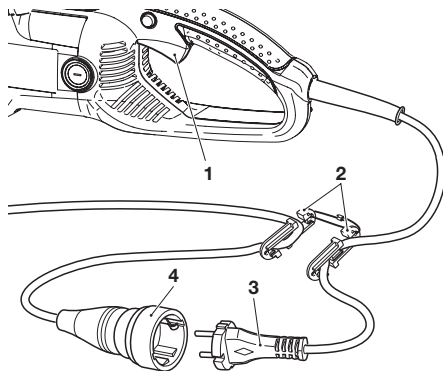

A

Switching on the motor

- Plug in the saw (see above).
- **When switching on the electric chain saw always hold it with both hands.** Take the back handle with the right hand and the tubular handle with the left hand. Hold the handles tightly with your thumbs facing your fingers. The bar and chain must not be in contact with any object.
- First depress the locking button (5) and then the power switch (1). Then release the locking button (5).
- **Attention: The chain starts running immediately.** Keep the power switch depressed as long as the motor is to run.

CAUTION:

Never lock the power switch in the ON position.



Switching off the motor

- Release the power switch (1).

NOTE:

When the chain brake is actuated the power supply to the motor will be cut off.

If the saw does not start when the ON/OFF switch (1) is actuated, it will be necessary to release the chain brake.

- Pull the hand guard (6) firmly in the direction of the arrow until you feel it catch.

Important:

These models are equipped with a starting current limiter. This electronic component prevents too abrupt starting of the electric motor.

Excess current cutoff: When the electrical current to the saw exceeds the permissible level, the power supply to the motor is automatically cut off. This prevents overheating of the motor and resulting damage. To start the saw up again, release the ON/OFF switch and press it again.

CAUTION: Do not use the saw if the current cutoff repeatedly switches off the saw. Consult a DOLMAR service centre.

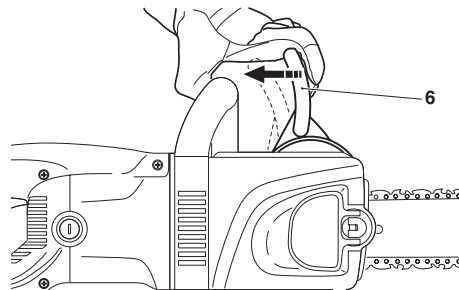
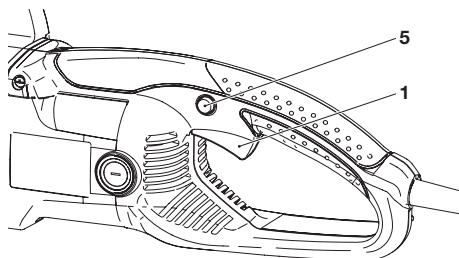

B

Checking the chain brake

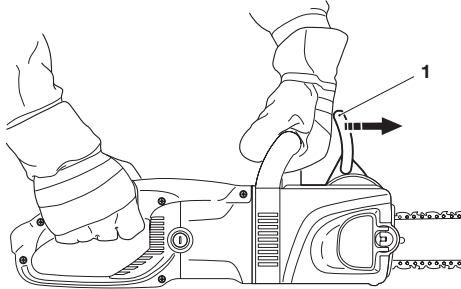

Do not work with the chain saw without first checking the chain brake!

- Start the motor as described (make sure you have a good footing, and place the chain saw on the ground in such a way that the guide bar is free of contact).
- Grasp the tubular handle firmly with one hand and hold the grip with the other.
- Switch on the motor and press the hand guard (1) in the direction of the arrow with the back of your hand until the chain brake engages. The chain should stop immediately.
- Switch the motor off immediately and release the chain brake.

Important: If the saw chain does not stop instantly when you carry out this test, do not under any circumstances use the saw! Take the chain saw to a DOLMAR service center.

C

Testing the run-out brake

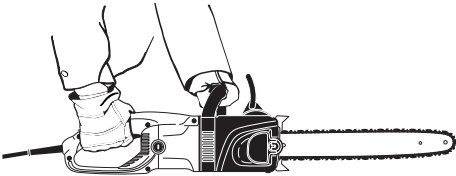

Do not work with the saw without first testing the run-out brake!

- Start the motor as described (make sure you have a good footing, and place the chain saw on the ground in such a way that the guide bar is free of contact).
- Grasp the tubular handle firmly with one hand and hold the grip with the other.
- Switch the motor on and then back off. The chain should come to a full stop within two second of switching off the motor.

Important: If the saw chain does not stop within two second when you carry out this test, do not use the saw! Inspect the carbon brushes (see page 19).

D

Checking the chain lubrication

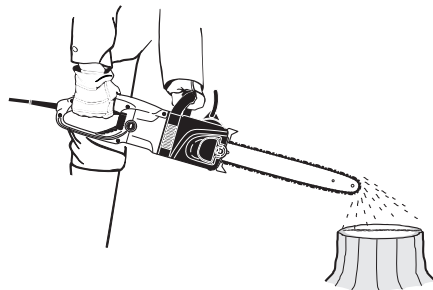

Never saw when a sufficient chain lubrication is not guaranteed. Otherwise the life of the sawing device will be reduced. Before starting work check the oil level in the tank and the oil feeding. Check the fed oil quantity by following the instructions below:

- Start the electric chain saw.
- Hold the running chain saw approx. 15 cm above a trunk or the ground (use an appropriate surface).

If the lubrication is sufficient, you will see a light oiltrace because oil will be centrifuged from the chain saw. Pay attention to the direction the wind is blowing and avoid unnecessary exposure to the oil spray!

E

MAINTENANCE

Sharpening the saw chain

When working on the saw chain you must always pull out the power supply plug and wear protective gloves.

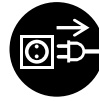

The chain needs sharpening when:

- the sawdust from sawing humid wood looks like wood flour.
- the saw chain penetrates the wood only under great pressure.
- the cutting edge is visibly damaged.
- the sawing device is pulled to the left or the right during the sawing operation. This is caused by uneven sharpening of the chain or by damage to one side of it.

Important: Sharpen frequently, but without removing too much metal!

Generally, 2-3 strokes of the file will be enough.

Have the chain resharpened in a service center when you have sharpened it yourself several times.

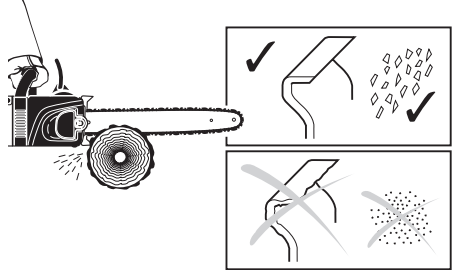

Proper sharpening:

CAUTION:

Use only chains and guide bars designed for this saw (see the Extract from the spare-parts list)!

- All cutters must be of the same length (dimension a). Cutters with different lengths result in rough running of the chain and can cause cracks in the chain.
- Minimum cutter length is 3 mm (0.11"). Do not resharpen the chain when the minimum cutter length has been reached; at this point, the chain must be replaced (see the Extract from the spare-parts list and "Replacing the chain").
- The depth of the cut is determined by the difference in height between the depth limiter (round nose) and the cutting edge.
- The best results are obtained with a depth-limiter depth of 0.64 mm (.025").

CAUTION:

Excessive depth increases the risk of kickback!

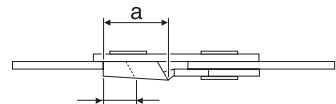
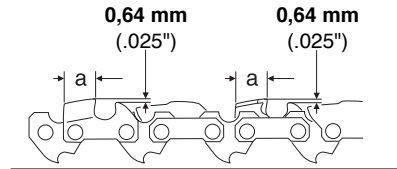
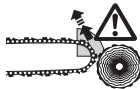

min.
3 mm (0.11")

- All cutters must be sharpened to the same angle, 30°. Different angles result in a roughly, irregularly running chain, increase wear and tear and cause chain beakage.
- The 85° front rake of the cutter results from the cut depth of the round file. If the proper file is used in the right manner, the correct front rake will be obtained automatically.

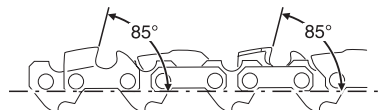
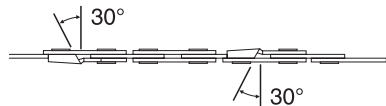

A

Files and how to work with them

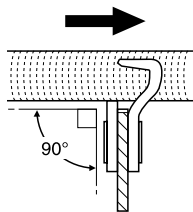

- Sharpen using a special file holder with a saw chain round file dia. 4.0 mm. Normal round files are not appropriate for this work. See "Accessories" for the order number.
- The file should cut only when pushed forwards (arrow). Lift the file when leading it backwards.
- First sharpen the shortest cutter. The length of this cutter is then the standard for all other cutters of the chain.
- Always guide the file as in fig. shown

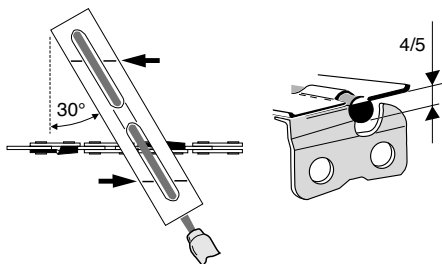

- The file holder makes file guidance easier. It is marked for the correct 30° sharpening angle (keep the marks parallel with the chain when filing, see illustration) and limits the cut depth to the correct 4/5 of the file diameter. See "Accessories" for the order number.

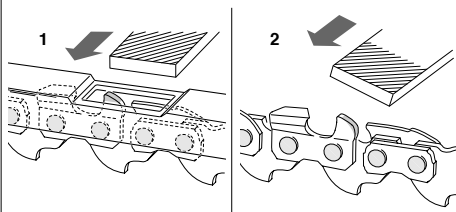

- After having sharpened the chain, the height of the depth limiter must be checked by means of a chain gauge. See "Accessories" for the order number.
- Correct even the smallest excess height with a special flat file (1). See "Accessories" for the order number.
- Round off the front of the depth limiter (2).

B

Cleaning the guide bar, lubricating the sprocket nose

CAUTION: Protective gloves must be worn.

Regularly inspect the bearing surfaces of the guide bar for damage, and clean them with a suitable tool.

If the saw is used intensively it will be necessary to lubricate the return sprocket bearings regularly (once a week). To do this, first **thoroughly** clean the 2 mm hole at the tip of the guide bar, and then press in a small amount of multi-purpose grease.

Multi-purpose grease and grease guns are available as accessories.

Multi-purpose grease (order no. 944 360 000)
Grease gun (order no. 944 350 000)

C

Replacing the saw chain

CAUTION:

Use only chains and guide bars designed for this saw (see the Extract from the spare parts list)!

Check the sprocket (1) before mounting a new chain.

CAUTION:

Worn out sprockets (2) may damage the new chain and must therefore be replaced.

Do not attempt to replace the sprocket yourself. Sprocket replacement requires special training and tools and must be done at a DOLMAR service centre.



SERVICE

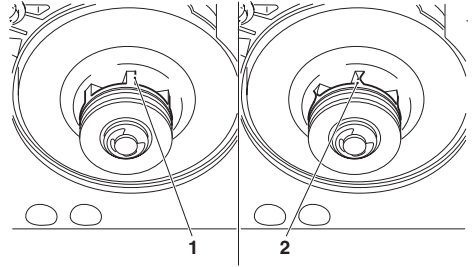
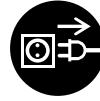

D

Inspecting and replacing the carbon brushes

Important:

Inspect the carbon brushes at regular intervals!
A notch on the brush shows the limit of wear.

NOTE:

The carbon brush is very delicate, so be careful not to let it drop. When taking it out, be sure to note the position it was installed in, since each brush is run in with the rotor.

- Use a slotted bit screwdriver to unscrew the cover (1), and then pull out the brush (2).
- If the wear limit has not yet been reached, put the brush back in the same position and screw the cover (1) back on.
- Run the saw briefly (about a minute) so the brushes can run in again.

Important: Now test the run-out brake (see page 16). If the saw chain does not come to a full stop within two second, run the saw again briefly and repeat the test until the brake functions properly.

NOTE: After installing new carbon brushes, run the saw about 5 minutes and then check the run-out brake.

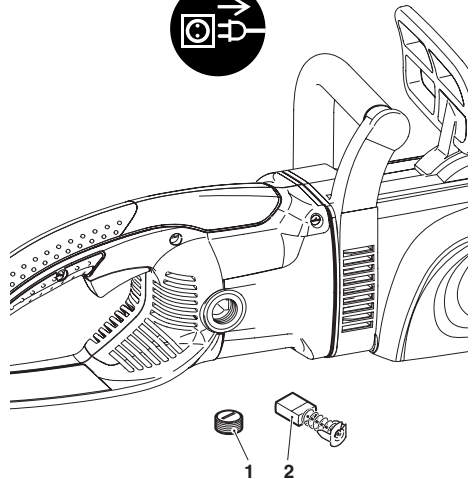
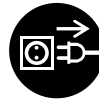

E

Trouble shooting

Malfunction	System	Observation	Cause
Chain saw does not work	total	electric motor does not function	no power supply, cable defective chain brake actuated Mains fuse blown
insufficient performance	Carbon brushes	low pulling power	Carbon brushes worn down
no chain lubrication	Oil tank, oil pump	no oil on the saw chain	oil tank empty,
Chain brake	Brake	Saw chain does not stop instantly	Brake band worn down
Run-out brake	Brake	Saw chain continues to run	Carbon brushes worn down

Instructions for periodic maintenance

To ensure long life, prevent damage and ensure the full functioning of the safety features the following maintenance must be performed regularly. Guarantee claims can be recognized only if this work is performed regularly and properly. Failure to perform the prescribed maintenance work can lead to accidents!

The user of the electric chain saw is not allowed to perform maintenance works which are not described in the instruction manual. All other works must be carried out by a DOLMAR service centre.

Page

General work	Electric chain saw Plastic case Saw chain Guide bar Sprocket Chain brake Run-out brake	Regularly clean the outside. Check for cracks and ruptures. In case of damage have it immediately repaired at a service centre. Resharpener regularly. Replace in time. Turn over after a certain period of time so that the bearing surfaces are uniformly worn. Replace in time. Have it replaced in time at a service centre. Have it inspected regularly at a service centre. Have it inspected regularly at a service centre.	
Each time before putting the saw into operation	Saw chain Guide bar Chain lubrication Chain brake Run-out brake Power switch Power supply cable Oil tank cap	Check for damage and sharpness. Check the chain tension. Check for damage, and remove burrs if necessary. Functional check. Functional check. Functional check. Functional check. In case of damage have it replaced at a service centre. Check for tightness.	17-18 12 16 16 16 15
After each shutdown	Guide bar Chain carrier	Clean the oil inlet bore. Clean, especially the oil guide groove.	14 18
Storage	Chain oil tank Saw chain/guide bar Electric chain saw	Empty. Demount, clean and lubricate slightly. Clean the guide groove of the guide bar. Store safely in a dry place. After a long storage time, have the electric chain saw checked at a service centre (residual oil can become resinic and the valve of the oil pump clogged).	14

Service, spare parts and guarantee

Maintenance and repair

The maintenance and repair work of modern electric motors as well as all safety related assemblies require qualified technical training and the availability of a special workshop equipped with special tools and testing devices.

Any work not described in this Instruction Manual must be performed only by a DOLMAR service centre.

The DOLMAR service centres are provided with all the necessary equipment and skilled and experienced personnel to work out correct customer solutions and to advise you in all matters accordingly.

Repair attempts by third parties or unauthorised persons void all warranty claims.

Spare parts

A reliable and continuous operation as well as the safety of your chain saw is also subject to the quality of the spare parts used. Use original DOLMAR spare parts only, marked:



Only original spare parts and accessories guarantee the highest quality in material, dimensions, functioning and safety. Original spare parts and accessories can be obtained from your local dealer. He will also have the relative spare part lists to determine the required spare part numbers, and will be constantly informed about the latest improvements and also about spare part innovations. To find your local distributor, please visit www.dolmar.com

Please, take in mind that in the case that foreign spare parts are used instead of the original DOLMAR spare parts this will automatically invalidate the DOLMAR product guarantee.

Guarantee

DOLMAR guarantees the highest quality and will therefore reimburse all costs for mending through replacement of damaged parts as a result of material or production faults, which occur within the guarantee time after purchase.

Please, note that in some countries particular guarantee conditions may exist. In case of any doubts, please, contact your salesman who is responsible for the guarantee of the product.

We ask for your understanding that we cannot accept any responsibility for damage caused by:

- Disregard of the instruction manual.
- Non-performance of the required maintenance and cleaning instructions.
- Normal wear and tear.
- Obvious overload due to permanent excess of the upper limits of capacity.
- Use of guide bars and saw chains which have not been approved.
- Use of guide bar and saw chain lengths which have not been approved.
- Use of force, improper use, misuse or accidents.
- Damage caused by overheating due to dirt obstructing the cool air supply at the motor case.
- Use of unsuitable spare parts or parts which are not original DOLMAR parts, as far as they have caused the damage.
- Use of unsuitable or old oil.
- Damage related to conditions arising from lease or rent contracts.
- Works on the chain saw by unskilled persons or performance of inappropriate repairs.

Cleaning, servicing and adjustment works are not covered by the guarantee. All repairs covered by the guarantee are to be performed by a DOLMAR service centre.

Extract from the spare parts list

Use original DOLMAR spare parts only. For performance of repairs and for replacement of other components your DOLMAR service centre should be consulted.

ES-2130 A, ES-2135 A

ES-2140 A, ES-2145 A

DOLMAR

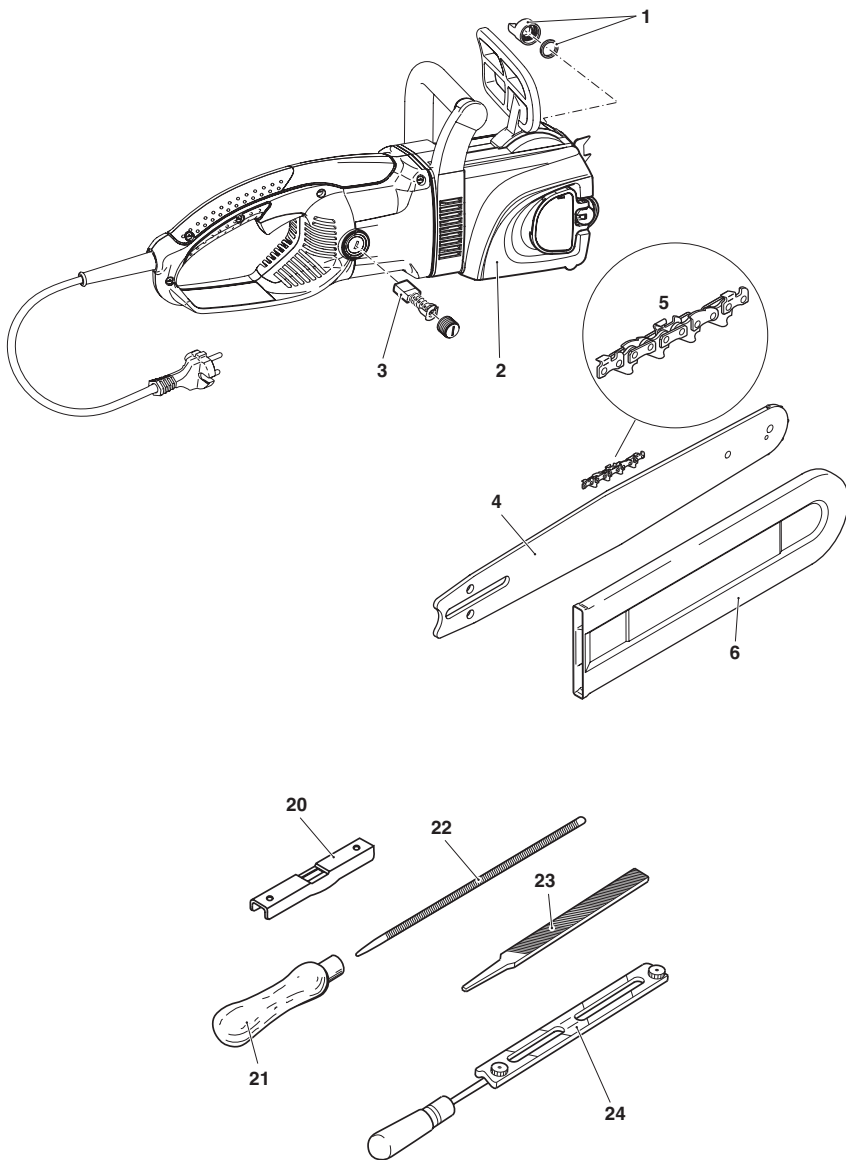

Extract from the spare parts list

Use original DOLMAR spare parts only. For performance of repairs and for replacement of other components your DOLMAR service centre should be consulted.

ES-2130 A, ES-2135 A
ES-2140 A, ES-2145 A

DOLMAR



Pos.	DOLMAR No.	Qty.	Denominatio
1	226 114 100	1	Oil tank cap compl.
2	226 213 200	1	Sprocket guard compl.
3	970 805 410	2	Carbon brushes
4	412 030 661	1	Sprocket nose bar 30 cm (12")
4	412 035 661	1	Sprocket nose bar 35 cm (14")
4	412 040 661	1	Sprocket nose bar 40 cm (16")
4	412 045 661	1	Sprocket nose bar 45 cm (18")
5	528 092 046	1	Saw chain 3/8", 30 cm
5	528 092 052	1	Saw chain 3/8", 35 cm
5	528 092 056	1	Saw chain 3/8", 40 cm
5	528 092 062	1	Saw chain 3/8", 45 cm
6	952 010 130	1	Chain protection cover (30-35 cm)
6	952 010 140	1	Chain protection cover (40-45 cm)

Accessories (not included in the delivery inventory)

20	953 100 090	1	Chain gauge 3/8"
21	953 004 010	1	File handle
22	953 003 090	1	Round file \varnothing 4 mm
23	953 003 060	1	Flat file
24	953 030 010	1	File holder compl. 3/8"

EU Conformity Declaration

The undersigned, Tamiro Kishima and Rainer Bergfeld, as authorized by DOLMAR GmbH, declare that the DOLMAR machines,

Type: 226 **EU prototype test certificate No.**

ES-2130 A **M6 06 07 24243 068**

ES-2135 A **M6 06 07 24243 068**

ES-2140 A **M6 06 07 24243 068**

ES-2145 A **M6 06 07 24243 068**

manufactured by DOLMAR GmbH, Jenfelder Str. 38, 22045 Hamburg, Germany, conforms to the basic safety and health requirements of the applicable EU guidelines:

EU Machinery Directive 98/37/EG, EU EMC Directive 2004/108/EG, Outdoor Noise Directive 2000/14/EG. Starting on 29 Dec. 2009, Guideline 2006/42/EG will come into force, replacing Guideline 98/37/EG. This product meets the requirements of the new Guideline.

The most important standards applied to properly meet the requirements of the above EU Directive were: EN 60745-2-13, EN 61000-3-2, EN 61000-3-3, EN 55014-1, EN 55014-2.

The conformity assessment procedure 2000/14/EG was performed per Annex V. The measured sound power level (L_{WA}) is 101,8 dB(A). The guaranteed sound power level (L_p) is 103 dB(A).

The EU-Type-Examination Certificate was performed by: TÜV Süd Product Service GmbH, Zertifizierungsstelle, Ridlerstr. 31, D-80339 München. The technical documentation is on file at DOLMAR GmbH, Jenfelder Straße 38, Abteilung FZ, D-22045 Hamburg.

Hamburg, 15.5.2008

For DOLMAR GmbH

Tamiro Kishima
Managing Director

Rainer Bergfeld
Managing Director

To find your local distributor, please visit
www.dolmar.com



DOLMAR GmbH
Postfach 70 04 20
D-22004 Hamburg
Germany
<http://www.dolmar.com>

Specifications subject to change without notice

Form: 995 702 303 (2.09 GB)