

Einbauhinweise	D
Installation instructions	GB
Instructions de montage	F
Cenni sull'installazione	I
Inbouwinstructies	NL
Monteringsanvisningar	S
Instrucciones de montaje	E
Instruções de montagem	P
Monteringsvejledning	DK

8 622 403 976 (06.05)

7 606 104 008

IC 104

(D) Allgemeines

Für unsere innerhalb der Europäischen Union gekauften Produkte geben wir eine Herstellergarantie. Die Garantiebedingungen können Sie unter www.blaupunkt.de abrufen oder direkt anfordern bei:

Blaupunkt GmbH
Hotline
Robert-Bosch-Str. 200
D-31139 Hildesheim

Sicherheitshinweise

Einbau- und Anschlussvorschriften

Vor dem Bohren der Befestigungslöcher sicherstellen, dass keine verlegten Kabel oder Fahrzeugteile beschädigt werden. Lautsprecherkabel sind zur Störsicherheit in genügendem Abstand von Kabelbäumen zu verlegen. An scharfkantigen Löchern Kabeldurchführungen verwenden.

Recycling und Entsorgung



Unser Produkt wurde aus Materialien hergestellt, die umweltschonend entsorgt und einem fachgerechten Recycling zugeführt werden können. Altprodukte müssen getrennt vom Hausmüll gesammelt werden. Bitte nutzen Sie zur Entsorgung des Produktes die zur Verfügung stehenden Rückgabe- und Sammelsysteme.

Technische Änderungen vorbehalten

(GB) GENERAL

We provide a manufacturer guarantee for our products bought within the European Union. You can view the guarantee conditions at www.blaupunkt.de or ask for them directly at:

Blaupunkt GmbH
Hotline
Robert-Bosch-Str. 200
D-31139 Hildesheim
Germany

Safety Notes

Installation and connecting instructions

Prior to drilling the mounting holes, make sure that no cables and parts of the vehicle will be damaged. Leave ample clearance between the cables and other harnesses. Use the cable ducts at sharp-edged holes.

Recycling and disposal



Our products are made from materials that can be disposed of in an environmentally sensitive manner and are suitable for appropriate recycling. Products that are to be scrapped must be collected separately from household waste. To dispose of the product, please use the available waste return and collection systems.

Subject to technical modification

(F) GÉNÉRALITÉS

Notre garantie s'étend à tous les produits achetés à l'intérieur de l'Union Européenne. Vous en trouverez les conditions sur notre site Internet : www.blaupunkt.de.

Vous pourrez aussi les obtenir en vous adressant à :

Blaupunkt GmbH
Hotline
Robert-Bosch-Str. 200
D-31139 Hildesheim

Recommandations de sécurité

Consignes de montage et de branchement

Avant de percer les trous de fixation, veiller à n'endommager ni câbles ni pièces déjà présents dans le véhicule. Poser tous les câbles à bonne distance des harnais de câbles afin d'éviter tout parasitage. Utiliser des passe-câbles si les trous sont coupants au bord.

Recyclage et récupération



Ce produit est fabriqué à partir de matériaux qui peuvent être récupérés de manière respectueuse de l'environnement et recyclés dans les règles de l'art. Les produits en fin de vie doivent être collectés et séparés des autres déchets. Nous vous invitons à utiliser les programmes de récupération et de collecte mis en place pour recycler le produit.

Sous réserve de modifications techniques

(I) NOTE GENERALI

Per i prodotti acquistati nell'ambito dell'Unione Europea concediamo una garanzia di produttore. Le condizioni di garanzia potete richiamarle all'indirizzo Internet www.blaupunkt.de oppure anche richiederle direttamente a noi:

Blaupunkt GmbH
Hotline
Robert-Bosch-Str. 200
D-31139 Hildesheim

Avvertenze di sicurezza

Istruzioni per il montaggio ed il collegamento

Prima di fare i fori per il fissaggio assicurarsi che non vi siano cavi oppure parti della vettura che potrebbero venire danneggiati. Per garantire un funzionamento senza disturbi i cavi devono essere posati ad una distanza sufficiente da gruppi di cavi elettrici. Per passare il cavo attraverso fori con spigoli vivi usare i passacavi.

Riciclaggio e smaltimento



Per la produzione del nostro prodotto sono stati impiegati materiali che si possono smaltire con rispetto dell'ambiente e inserire in un riciclaggio in corrispondenza del loro contenuto. I prodotti di scarto industriale si devono raccogliere separatamente e non assieme alla normale immondizia. Per lo smaltimento del prodotto servitevi per favore degli appositi sistemi di restituzione e raccolta.

Con riserva di apportare eventuali modifiche tecniche

(NL) ALGEMEEN

Voor onze producten die binnen de Europese Unie zijn gekocht, bieden wij een fabrieksgarantie. U kunt de garantievoorwaarden oproepen op www.blaupunkt.de of direct opvragen bij:

Blaupunkt GmbH
Hotline
Robert-Bosch-Str. 200
D-31139 Hildesheim

Veiligheidsinstructies

Inbouw- en aansluitvoorschriften

Vóór het boren van de bevestigingsgaten nagaan of geen aanwezige kabels of voertuigdelen worden beschadigd. Alle kabels moeten om storingen te voorkomen op voldoende afstand van de kabelbomen worden gelegd. Bij gaten met scherpe randen kabeldoorvoertulen gebruiken.

Recycling en afvalverwerking



Ons product is vervaardigd van materialen die milieuvriendelijk kunnen worden weggeworpen en worden toegevoerd aan deskundige recycling. De oude producten moet gescheiden van het huisvuil worden ingezameld. Gebruik voor het wegwerpen van het product de beschikbare teruggeef- en inzamelsystemen.

Technische wijzigingen voorbehouden

(S) ALLMÄNT

För produkter köpta inom Europeiska unionen ger vi en tillverkargaranti. Villkoren för vårt garantiåtagande publiceras på www.blaupunkt.de och kan beställas på följande adress.

Blaupunkt GmbH
Hotline
Robert-Bosch-Str. 200
D-31139 Hildesheim
Tyskland

Säkerhetsanvisning

Monterings- och anslutningsinformationer

Kontrollera innan fästhålens borrar att inga kabelstammar eller andra delar i bilen skadas. För att undvika störningar skall alla ledningar dras långt ifrån befintliga kabelstammar. Vid vassa hål använd kabelgenomföringar.

Återvinning och avfallshantering



Vår produkt är tillverkad av material som kan avfallshandteras på ett miljörätt sätt och återvinnas sakkunnigt. Uttjänta produkter får inte hamna i hushållsoporna. Vänligen använd de miljö- och återvinningsstationer som finns tillgängliga när Du avfallshandterar din produkt.

Rätt till tekniska ändringar förbehålles

(E) Generalidades

Para los productos adquiridos dentro de la Unión Europea, le ofrecemos una garantía del fabricante. Las condiciones de esta garantía pueden consultarse en www.blaupunkt.de o solicitarse directamente a:

Blaupunkt GmbH
Hotline
Robert-Bosch-Str. 200
D-31139 Hildesheim

Indicaciones de seguridad

Instrucciones de montaje y de conexión

Antes de taladrar los agujeros de montaje asegurarse de que cables o partes del vehículo no pueden ser estropeados. Todos los cables deben fijarse a una distancia suficiente de otros mazos de cable para evitar interferencias. Utilizar los pasadores en huecos de conto vivo.

Reciclaje y eliminación de residuos



Nuestro producto fue elaborado a base de materiales que pueden ser eliminados o reciclados de forma no contaminante y conforme a las reglas. Para eliminarlos, estos productos deben ser separados de la basura doméstica. Haga el favor de utilizar los sistemas de devolución y recolección que existan para la eliminación del producto.

Modificaciones técnicas reservadas

(P) INFORMAÇÕES GERAIS

A Blaupunkt concede aos produtos por ela fabricados e comprados na União Europeia uma garantia do fabricante. Os termos e condições da garantia poderão ser consultados sob o endereço www.blaupunkt.de ou requisitados directamente à:

Blaupunkt GmbH
Hotline
Robert-Bosch-Str. 200
D-31139 Hildesheim

Instruções de segurança

Instruções de montagem e de ligação

Antes da perfuração dos orifícios de fixação, assegurar que não ocorrem danos nos cabos instalados ou nas peças do veículo. Todos os cabos devem ser instalados a uma distância suficiente da cablagem pré-formada. Nos orifícios de ares-tas vivas, utilizar as passagens para os cabos.

Reciclagem e eliminação



O nosso produto foi fabricado a partir de materiais que podem ser eliminados de forma não nociva ao meio ambiente e que permitam uma reciclagem de acordo com as leis. Os produtos velhos devem ser seleccionados separadamente do lixo doméstico. Para uma eliminação deste produto, use, por favor, os sistemas de devolução e selecção colocados à disposição para o efeito.

Sob reserva de alterações!

(DK) ALMENT

Hvis produktet er købt i et EU-land, ydes en produktionsgaranti. Garantibestemmelserne kan læses på Internettet under www.blaupunkt.de eller rekvireres direkte hos:

Blaupunkt GmbH
Hotline
Robert-Bosch-Str. 200
D-31139 Hildesheim

Sikkerhedshenvisninger

Monterings- og tilslutningsforskrifter

Før boring af befæstelseshullerne skal det kontrolleres, at lagte kabler og køretøjsdele ikke beskadiges.











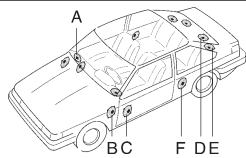



Højttalerkabler skal lægges i en tilstrækkelig afstand fra kabelbundet for at undgå forstyrrelser gennem støj. Ved huller med skarpe kanter skal kabelføringer anvendes.

Recirkulering og bortskaffelse











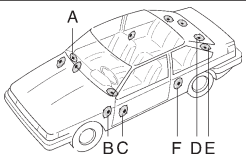





Vore produkter fremstilles af materialer, der kan bortskaffes på en miljørigtig måde og tilføres et recirkuleringssystem. Gamle produkter må ikke bortskaffes sammen med husholdningsaffald. Produkterne afleveres på kommunernes miljø- og opsamlingsstationer.











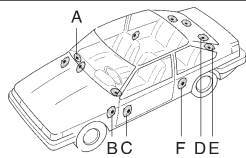



Ret til ændringer forbeholdes!

			4,2x9,5	4,2x14 (4,8x13)	4,2x22														
																			
Alfa	90		D			●		●											
Audi	100	10/82 - 11/90	A ⁵⁾		●						●								
	200	1/88 →	A ⁵⁾		●						●								
	80	10/86 →	A ⁵⁾		●						●								
	80	9/91 →	F ^{31), 5)}			●		●											
	80 Avant		F ^{31), 5)}			●		●											
	90	5/87 →	A ⁵⁾		●						●								
	Cabriolet		A		●						●								
	Coupe		A		●						●								
Austin	Maestro		E		●								●	●					
	Mini Metro		C ⁵⁾ , E	●	●							●	●	●					
	Montego		C, D		●								●	●					
Citroen	Saxo		F			●		●				●	●	●					
	Visa		E			●		●				●	●	●					
	Berlingo	2/97 →	A		●									●					
Daewoo	Espero	1/95 →	A		●														
	Nexia Fließheck	7/95 →	A, E		●														
	Nexia GLX Limousine		A		●														
	Nexia GTX Fließheck		A, E		●														
	Matiz	9/98 →	C ³⁷⁾ , E ²³⁾		●														
Daihatsu	Cuore	→ 9/90	C			●													
	Feroza, Rocky		C			●		●											
	YRV	1/01 →	A		●														
Fiat	Cinquecento		A		●					●									
	Marea		A		●														
	Panda		F			●		●											
	Punto		E		●			●			●	●	●						
	Tempra		A, D		●	●		●	●										
	Tempra Station		A, E	●								●	●	●					
	Tipo		E	●															
	Uno		E		●			●				●	●	●					
	Uno	90 →	A		●			●				●	●	●					
Ford	Escort	3/86 - 9/90	B			●		●											
	Escort Cabriolet	→ 9/90	B		●			●					●	●					
	Orion	10/90 →	D			●		●											
	Orion	3/86 - 9/90	B			●		●											
	Sierra Limousine		D ³¹⁾			●		●											
FSO	Polonez		C	●															
Honda	Accord	9/85 - 10/89	C					●					●	●					
	Civic	9/87 →	C		●								●	●					
	CRX	6/92 →	C		●								●	●					
	Logo	93 →	C ³⁷⁾		●							●		●					
	Prelude	11/87 - 4/90	C					●					●	●					











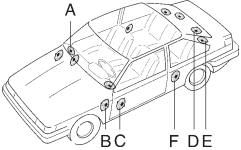

- 5) Evtl. sind 2 Befestigungsöhren zu entfernen • If necessary, remove the two securing tabs • Le cas échéant, retirer deux œillets de fixation • Eventualmente togliete due occhielli di fissaggio • Evt. moeten twee bevestigingslippen worden verwijderd • Ta vid behov bort 2 fästöglor • En caso necesario, retirar 2 lengüetas de fijación • Pode ser necessário remover 2 linguetas de fixação • Evt. skal 2 fastgørelsesflige fjernes • Reparar el hueco • Retrabalhar o recorte • Udskaeringen arbejdes efter
- 23) Ausschnitt nacharbeiten • Retouch the cut-out • Retoucher la découpe • Ritoccare l'apertura • Werk de uitsnede af • Efterarbete urtaget • Reparar el hueco • Retrabalhar o recorte • Udskaeringen arbejdes efter
- 31) Fahrzeuge ohne Lautsprechervorrüstung • Vehicles not pre-equipped for loudspeaker installation • Véhicules non préparés pour le montage de HP • Autoveicoli senza equipaggiamento di altoparlanti • Auto's zonder luidsprekervoorbereiding • fordon utan förmonterade högtalare • Vehículos no preparados para la instalación de altavoces • Veículos sem pré-instalação para altifalantes • Køretøjer uden forinstallerede højttalere
- 37) Montageplatte selbst anfertigen • Make your own mounting board • Fabriquer soi-même le panneau d'installation • Producete voi stessi la piastra di montaggio • Maak zelf de montageplaat • Egentilverka monteringsplatta • Fabricar la placa de montaje por cuenta propia • Fabricar por si próprio a placa de montagem • Monteringspladen skal selv laves

			4,2x9,5	4,2x14 (4,8x13)	4,2x22															
Hyundai	Pony	A ⁵⁾		●																
	S-Coupe	A ⁵⁾		●						●										
	Sonata	→ 9/93		●						●										
Kia	Pride	94 - 5/97	A, E	●																
	Sephia		C	●																
	Sportage	10/94 - 1/96	C	●																
Lancia	Dedra		A	●								●								
	Prisma		B			●			●											
	Y 10	→ 11/92	C ³¹⁾			●			●											
Mazda	121	→ 1/91	A, E	●						●			●	●	●					
	323 Hatchback	9/85 - 8/89	A, E	●																
	626	→ 1/92	A											●	●					
	929	5/87 →	A											●	●					
Mercedes	G-Modell		B			●														
	W201 190er		D ³¹⁾			●			●											
	W123		D	●				●												
	CLK Cabrio W210	7/99 →	C ³⁷⁾	●																
	CLK Coupe W210	5/97 →	C ³⁷⁾	●																
Mitsubishi	Carisma DX-44	10/96 →	A	●						●										
	Colt		A ⁵⁾	●						●										
	Galant		A ⁵⁾	●						●										
	L300	9/87 →	A ⁵⁾	●						●										
	Lancer		A ⁵⁾	●						●										
	Lancer Limousine		D ³¹⁾			●			●											
	Lancer Station	3/96 →	A ⁵⁾	●						●										
	Pajero		A ⁵⁾	●						●										
	Pajero	10/97 →	A	●						●										
	Space Runner		A ⁵⁾	●						●										
	Space Wagon	1/92 →	A ⁵⁾	●						●										
Nissan	100 NX		F ³¹⁾			●				●										
	Sunny Hatchback	2/91 →	E ³¹⁾			●				●										
Opel	Campo		A			●				●				●						
	Corsa	→ 8/90	A	●																
	Frontera		A			●				●				●						
	Kadett E		A ⁵⁾	●						●										
	Kadett E Cabriolet		A ⁵⁾	●						●										
	Kadett E Hatchback	9/84 - 12/90	E ⁵⁾	●																
	Monterey		E			●								●	●					

- 5) Evtl. sind 2 Befestigungsöhren zu entfernen • If necessary, remove the two securing tabs • Le cas échéant, retirer deux œilletons de fixation • Eventualmente togliete due occhielli di fissaggio • Evt. moeten twee bevestigingslippen worden verwijderd • Ta vid behov bort 2 fästöglor • En caso necesario, retirar 2 lengüetas de fijación • Pode ser necessário remover 2 linguetas de fixação • Evt. skal 2 fastgørelsesflige fjernes
- 31) Fahrzeuge ohne Lautsprechervorrüstung • Vehicles not pre-equipped for loudspeaker installation • Véhicules non préparés pour le montage de HP • Autoveicoli senza equipaggiamento di altoparlanti • Auto's zonder luidsprekervoorbereiding • fordon utan förmonterade högtalare • Vehículos no preparados para la instalación de altavoces • Veículos sem pré-instalação para altifalantes • Køretøjer uden forinstallerede højttalere
- 37) Montageplatte selbst anfertigen • Make your own mounting board • Fabriquer soi-même le panneau d'installation • Producete voi stessi la piastra di montaggio • Maak zelf de montageplaat • Egentillverka monteringsplatta • Fabricar la placa de montaje por cuenta propia • Fabricar por si próprio a placa de montagem • Monteringspladen skal selv laves

			4,2x9,5	4,2x14 (4,8x13)	4,2x22														
																			
Peugeot	106	→ 5/96	F		●														●
	405	9/92 →	A, F ²⁾		●														●
	406 Break	10/96 →	F		●														●
	406 Break	5/99 →	D ²⁸⁶⁾		●														●
					(4,8 x 13)														
Renault	19	9/88 - 3/92	A	●															●
	19 Cabriolet		F	●															●
	5	1/85 →	E			●		●					●						●
	5 Campus		A, E			●		●					●						●
	Clio		A, E	●	●														●
	Espace III	12/96 →	A		●														●
	Laguna Grandtour		Dach																●
	Kangoo	1/98 →	A, E		●														●
	Megane Coach	3/97 →	F			●		●											●
	Rapid, Express		A		●			●											●
	Twingo		A ⁴⁾																●
	Twingo	9/98 →	A			●													●
						(4,2 x 25)													
Rover	111, 114		E		●							●	●						●
	Mini		E		●							●	●						●
Saab	9000		A		●								●						●
					(4,8 x 13)														
Seat	Ibiza	10/84 - 6/93	C ²⁾		●							●	●						●
	Marbella		F			●		●											●
Subaru	Justy		A		●			●											●
Suzuki	Alto	12/94	C		●														●
	Alto 3 Türen		F			●													●
	Swift 3 Türen	12/96 →	A		●							●	●						●
	Swift 3 Türen	9/86 →	A		●							●	●						●
	Swift Limousine		D			●						●	●						●
	Vitara		A			●		●											●
Toyota	4Runner		A ⁵⁾		●														●
	Camry	1/87 - 8/91	A ⁵⁾		●														●
	Carina	4/88 - 4/92	A ⁵⁾		●														●
	Carina	12/95	D, F		●	●													●
	Carina Lim.	4/88 - 4/92	D ⁵⁾			●		●											●
	Celica	1/86 - 2/90	A ⁵⁾		●			●											●
	Corolla	9/87 - 7/92	A ⁵⁾		●														●
	Hilux		A ⁵⁾		●														●
	Land Cruiser Station																		
		5/90 →	A		●														●
	MR 2	10/85 - 4/90	A		●			●											●
	Starlet	3/90 →	A		●							●							●
Vauxhall	Astra	9/84 - 9/91	A ⁵⁾		●			●											●
	Astra Hatchb.	9/84 - 12/90	E		●														●
	Belmont	11/85 - 9/91	A ⁵⁾		●			●											●
	Nova	→ 8/90	A		●														●

- 2) Mit Lautsprechervorrichtung • Pre-equipped for loudspeaker installation • Prééquipé pour l'installation de haut-parleurs • Con equipaggiamento di altoparlanti • Met luidsprekervoorbereiding • med förmonterade högtalare • Equipado para la instalación de altavoces • Com pré-instalação para altifalantes • Med forinstallerede højtalere
- 4) LA-Einbausatz erforderlich • Loudspeaker installation kit is required • Kit de montage HP requis • Necessario kit di montaggio per altoparlanti • LA-inbouwsset vereist • Kräver monteringssett för högtalare • Requiere juego de montaje para altavoces • É necessário um de montagem AF • Monteringssett for højtalere nødvendig
- 5) Evtl. sind 2 Befestigungsöhren zu entfernen • If necessary, remove the two securing tabs • Le cas échéant, retirez deux œillets de fixation • Eventualmente togliete due occhielli di fissaggio • Evt. moeten twee bevestigingslippen worden verwijderd • Ta vid behov bort 2 fästögglor • En caso necesario, retirar 2 lengüetas de fijación • Pode ser necessário remover 2 linguetas de fixação • Evt. skal 2 fastgørelsesflige fjernes
- 286) D-Säule • D-pillar • Montant D • Montante D • D-zuil • D-stolpe • Columna D • Montante D • D-søjle

				4,2x9,5 	4,2x14 (4,8x13) 	4,2x22 												
VW	Bus	→ 8/90	C			●		●						●				
	Jetta	1/84	D			●		●						●				
	Taro		A ⁵⁾			●								●				
Yugo	45, 65		C			●		●						●				
	Florida		E		●							●	●	●				

5) Evtl. sind 2 Befestigungsohren zu entfernen • If necessary, remove the two securing tabs • Le cas échéant, retirer deux œillets de fixation • Eventualmente togliete due occhielli di fissaggio • Evt. moeten twee bevestigingslippen worden verwijderd • Ta vid behov bort 2 fästöglor • En caso necesario, retirar 2 lengüetas de fijación • Pode ser necessário remover 2 linguetas de fixação • Evt. skal 2 fastgørelsesflige fjernes

(D) Die aktuelle Fahrzeugliste finden Sie im Internet unter www.blaupunkt.com oder bei Ihrem Fachhändler.

(GB) You can obtain the current list of vehicles on the Internet at www.blaupunkt.com or from your dealer.

(F) Vous trouverez la liste actuelle des véhicules sur Internet à l'adresse www.blaupunkt.com ou chez votre revendeur.

(I) Troverete l'elenco attuale delle autovetture in Internet nel sito www.blaupunkt.com, oppure presso il vostro negoziante specializzato.

(NL) De actuele lijst van autotypes vindt u op het internet onder www.blaupunkt.com of bij uw vakhandel.

(S) Den aktuella listan över samtliga fordon hittar Du på nätet (www.blaupunkt.com). Du kan även kontakta din Blaupunkt återförsäljare.

(E) Si desea ver la lista actual de vehículos, vaya a nuestra página web www.blaupunkt.com o pídasela a su proveedor.

(P) Para a lista actual de veículos, visite a página na Internet www.blaupunkt.com ou contacte o seu revendedor.

(DK) Den aktuelle køretøjsliste kan du få på Internettet under www.blaupunkt.com eller hos din forhandler.

Vorgesehene Einbauorte • Intended place of installation • Endroits de montage prévus • Punti di montaggio previsti • Mogelijke inbouwplaatsen •
 Monteringsplaatser • Lugares previstos para el montaje • Locais de montagem previstos • Beregnede monteringssteder

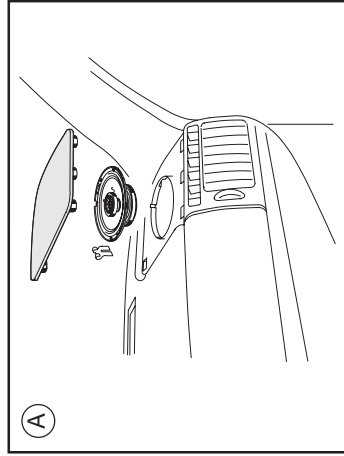

Armaturentafel • Dashboard • Tableau de
 bord • Cruscotto • Dashboard •
 Instrumentbräda • Tablero de instrumentos •
 Painel de instrumentos • Instrumentbræt

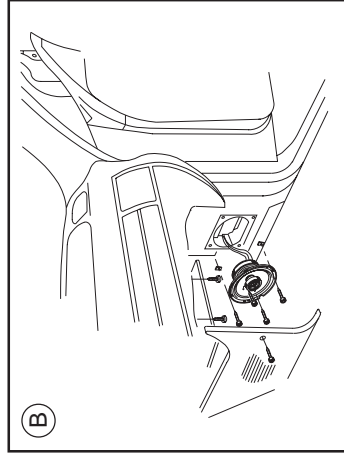

Fußraum • Leg area • Espace-pieds • Vano
 piedi • Voetenruimte • Fototrymme • Espacio
 de pies • Grupo do piso • Fodrum

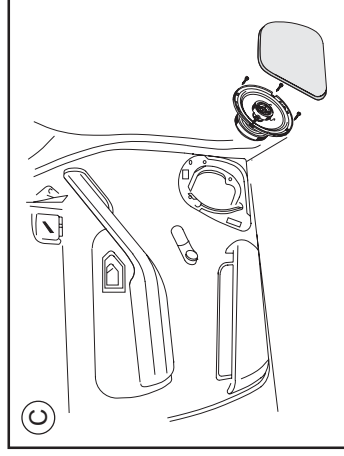

Tür • Door • Porte • Porta • Deur • Dörr •
 Puerta • Porta • Dør

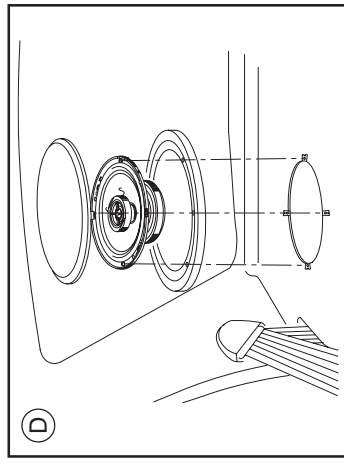

Heckablage • Rear shelf • Tablette arrière •
 Portaoggetti posteriore • Hoedenplank •
 Hatthylla • Panel trasero • Chapeleira •
 Hattenhylde

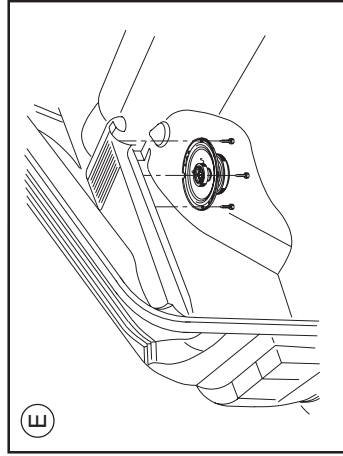

Seitensteg neben Gepäckraumabdeckung •
 Side shelf next to boot cover • Traverse latérale
 à côté de la tablette arrière • Nervatura laterale
 presso la copertura di bagagliaio • Zijsteun
 naast afdekking bagaeruite • Hatthyllans
 fasta sidodel • Alma lateral, al lado de tapa
 protectora de la maleta • Lateral da chapeleira
 ao lado da cobertura do porta-mala • Sidehylde
 ved siden af bagagerumsafdækning

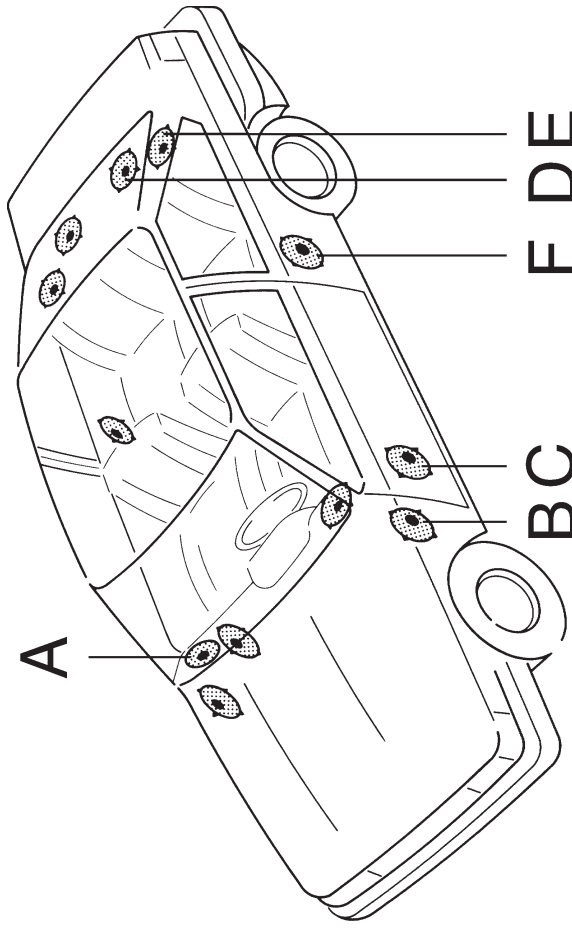

Seitenverkleidung hinten • Rear side panelling •
 Revêtement latéral arrière • Rivestimento
 laterale sul retro • Zijbekleding achter •
 Sidoklädsel bak • Rivestimiento lateral, atrás •
 Revestimento lateral traseiro • Sidebeklædning
 bagved

Technische Änderungen vorbehalten • Subject to technical modification • Sous réserve de modifications techniques • Con riserva di apportare eventuali modifiche tecniche • Technische wijzigingen voorbehouden • Rätt till tekniska ändringar förbehålles •
 Modificaciones técnicas reservadas • Reservado o direito a alterações técnicas • Ret til tekniske ændringer forbeholdes

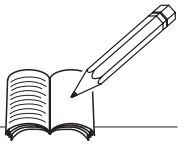

A series of horizontal lines for writing, starting from the top line and extending down to the bottom of the page.

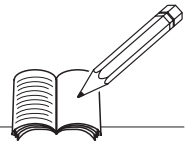

A series of horizontal lines for writing, starting from the top line and extending down to the bottom line of the page.

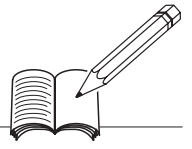

A series of horizontal lines for writing, starting from the top line and extending down to the bottom of the page.

Service-Nummern / Service numbers / Numéros du service après-vente / Numeri del servizio di assistenza / Servicenummers / Telefonnummer för service / Números de servicio / Número de serviço / Servicenumbre

Country:		Phone:	Fax:	WWW:
Germany	(D)	0180-5000225	05121-49 4002	http://www.blaupunkt.com
Austria	(A)	01-610 39 0	01-610 39 391	
Belgium	(B)	02-525 5444	02-525 5263	
Denmark	(DK)	44 898 360	44-898 644	
Finland	(FIN)	09-435 991	09-435 99236	
France	(F)	01-4010 7007	01-4010 7320	
Great Britain	(GB)	01-89583 8880	01-89583 8394	
Greece	(GR)	210 94 27 337	210 94 12 711	
Ireland	(IRL)	01-4149400	01-4598830	
Italy	(I)	02-369 62331	02-369 62464	
Luxembourg	(L)	40 4078	40 2085	
Netherlands	(NL)	023-565 6348	023-565 6331	
Norway	(N)	66-817 000	66-817 157	
Portugal	(P)	01-2185 00144	01-2185 11111	
Spain	(E)	902-52 77 70	91 410 4078	
Sweden	(S)	08-7501500	08-7501810	
Switzerland	(CH)	01-8471644	01-8471650	
Czech. Rep.	(CZ)	02-6130 0441	02-6130 0514	
Hungary	(H)	01-333 9575	01-324 8756	
Poland	(PL)	0800-118922	022-8771260	
Turkey	(TR)	0212-335 07 23	0212-276 06 46	
USA	(USA)	800-2662528	708-6817188	
Brasil (Mercosur)	(BR)	+55-19 3745 2769	+55-19 3745 2773	
Malaysia (Asia Pacific)	(MAL)	+604-6382 474	+604-6413 640	