

DENON

AV SURROUND RECEIVER

AVR-4310CI

Owner's Manual

GUI *Graphical User Interface*

Use this manual in combination with the operating guide displayed on the GUI screen.

GUI Menu Operation (☞ page 26)

GUI Menu Map (☞ page 25)

Language (☞ page 45)

Remote Control Unit Operations (☞ page 89)

SAFETY PRECAUTIONS



CAUTION
RISK OF ELECTRIC SHOCK
DO NOT OPEN



CAUTION:
TO REDUCE THE RISK OF ELECTRIC SHOCK, DO NOT REMOVE COVER (OR BACK). NO USER-SERVICEABLE PARTS INSIDE. REFER SERVICING TO QUALIFIED SERVICE PERSONNEL.



The lightning flash with arrowhead symbol, within an equilateral triangle, is intended to alert the user to the presence of uninsulated "dangerous voltage" within the product's enclosure that may be of sufficient magnitude to constitute a risk of electric shock to persons.



The exclamation point within an equilateral triangle is intended to alert the user to the presence of important operating and maintenance (servicing) instructions in the literature accompanying the appliance.

WARNING:
TO REDUCE THE RISK OF FIRE OR ELECTRIC SHOCK, DO NOT EXPOSE THIS APPLIANCE TO RAIN OR MOISTURE.



CAUTION:
HOT SURFACE. DO NOT TOUCH.

The top surface over the internal heat sink may become hot when operating this product continuously.

PRECAUTION:
SURFACE CHAUDE. NE PAS TOUCHER.

La surface supérieure du dissipateur de chaleur peut devenir chaude si vous utilisez ce produit en continu.

IMPOTANT SAFETY INSTRUCTIONS

1. Read these instructions.
2. Keep these instructions.
3. Heed all warnings.
4. Follow all instructions.
5. Do not use this apparatus near water.
6. Clean only with dry cloth.
7. Do not block any ventilation openings.
Install in accordance with the manufacturer's instructions.
8. Do not install near any heat sources such as radiators, heat registers, stoves, or other apparatus (including amplifiers) that produce heat.
9. Do not defeat the safety purpose of the polarized or grounding-type plug. A polarized plug has two blades with one wider than the other. A grounding type plug has two blades and a third grounding prong. The wide blade or the third prong are provided for your safety. If the provided plug does not fit into your outlet, consult an electrician for replacement of the obsolete outlet.
10. Protect the power cord from being walked on or pinched particularly at plugs, convenience receptacles, and the point where they exit from the apparatus.
11. Only use attachments/accessories specified by the manufacturer.
12. Use only with the cart, stand, tripod, bracket, or table specified by the manufacturer, or sold with the apparatus. When a cart is used, use caution when moving the cart/apparatus combination to avoid injury from tip-over.
13. Unplug this apparatus during lightning storms or when unused for long periods of time.
14. Refer all servicing to qualified service personnel. Servicing is required when the apparatus has been damaged in any way, such as power-supply cord or plug is damaged, liquid has been spilled or objects have fallen into the apparatus, the apparatus has been exposed to rain or moisture, does not operate normally, or has been dropped.
15. Batteries shall not be exposed to excessive heat such as sunshine, fire or the like.



CAUTION:

- The ventilation should not be impeded by covering the ventilation openings with items, such as newspapers, tablecloths, curtains, etc.
- No naked flame sources, such as lighted candles, should be placed on the unit.
- Observe and follow local regulations regarding battery disposal.
- Do not expose the unit to dripping or splashing fluids.
- Do not place objects filled with liquids, such as vases, on the unit.

ATTENTION:

- La ventilation ne doit pas être gênée en recouvrant les ouvertures de la ventilation avec des objets tels que journaux, rideaux, tissus, etc.
- Aucune flamme nue, par exemple une bougie, ne doit être placée sur l'appareil.
- Veillez à respecter les lois en vigueur lorsque vous jetez les piles usagées.
- L'appareil ne doit pas être exposé à l'eau ou à l'humidité.
- Ne pas poser d'objet contenant du liquide, par exemple un vase, sur l'appareil.

CAUTION:

To completely disconnect this product from the mains, disconnect the plug from the wall socket outlet. The mains plug is used to completely interrupt the power supply to the unit and must be within easy access by the user.

PRECAUTION:

Pour déconnecter complètement ce produit du courant secteur, débranchez la prise de la prise murale. La prise secteur est utilisée pour couper complètement l'alimentation de l'appareil et l'utilisateur doit pouvoir y accéder facilement.

FCC INFORMATION (For US customers)

1. COMPLIANCE INFORMATION

Product Name: AV Surround Receiver
Model Number: AVR-4310CI

This product complies with Part 15 of the FCC Rules. Operation is subject to the following two conditions: (1) this product may not cause harmful interference, and (2) this product must accept any interference received, including interference that may cause undesired operation.

Denon Electronics (USA), LLC
(a D & M Holdings Company)

100 Corporate Drive
Mahwah, NJ 07430-2041
Tel. (800) 497-8921

2. IMPORTANT NOTICE: DO NOT MODIFY THIS PRODUCT

This product, when installed as indicated in the instructions contained in this manual, meets FCC requirements. Modification not expressly approved by DENON may void your authority, granted by the FCC, to use the product.

3. IMPORTANT

When connecting this product to network hub or router, use only shielded STP or FTP LAN cables which is available at retailer.

Follow all installation instructions. Failure to follow instructions could void your authority, granted by the FCC, to use the product.

4. NOTE

This product has been tested and found to comply with the limits for a Class B digital device, pursuant to Part 15 of the FCC Rules. These limits are designed to provide reasonable protection against harmful interference in a residential installation.

This product generates, uses and can radiate radio frequency energy and, if not installed and used in accordance with the instructions, may cause harmful interference to radio communications. However, there is no guarantee that interference will not occur in a particular installation. If this product does cause harmful interference to radio or television reception, which can be determined by turning the product OFF and ON, the user is encouraged to try to correct the interference by one or more of the following measures:

- Reorient or relocate the receiving antenna.
- Increase the separation between the equipment and receiver.
- Connect the product into an outlet on a circuit different from that to which the receiver is connected.
- Consult the local retailer authorized to distribute this type of product or an experienced radio/TV technician for help.

For Canadian customers

This Class B digital apparatus complies with Canadian ICES-003.

Cet appareil numérique de la classe B est conforme à la norme NMB-003 du Canada.

NOTE ON USE / OBSERVATIONS RELATIVES A L'UTILISATION

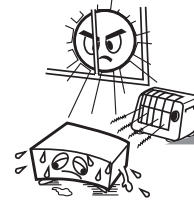

- Avoid high temperatures. Allow for sufficient heat dispersion when installed in a rack.
- Éviter des températures élevées. Tenir compte d'une dispersion de chaleur suffisante lors de l'installation sur une étagère.



- Keep the unit free from moisture, water, and dust.
- Protéger l'appareil contre l'humidité, l'eau et la poussière.



- Do not let foreign objects into the unit.
- Ne pas laisser des objets étrangers dans l'appareil.

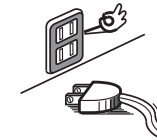

- Unplug the power cord when not using the unit for long periods of time.
- Débrancher le cordon d'alimentation lorsque l'appareil n'est pas utilisé pendant de longues périodes.

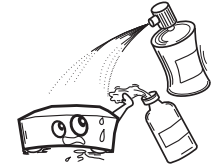

- Do not let insecticides, benzene, and thinner come in contact with the unit.
- Ne pas mettre en contact des insecticides, du benzène et un diluant avec l'appareil.

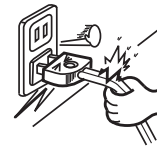

- Handle the power cord carefully. Hold the plug when unplugging the cord.
- Manipuler le cordon d'alimentation avec précaution. Tenir la prise lors du débranchement du cordon.

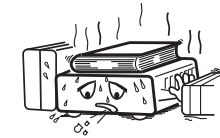

* (For apparatuses with ventilation holes)

- Do not obstruct the ventilation holes.
- Ne pas obstruer les trous d'aération.

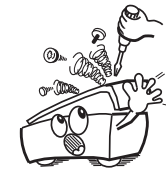

- Never disassemble or modify the unit in any way.
- Ne jamais démonter ou modifier l'appareil d'une manière ou d'une autre.

□ Contents

Getting Started	2
Flow of Operations Through Playback	2
Cautions on Handling	2
Cautions on Installation	2
Preparations	3
Accessories.....	3
Insert Batteries in the Remote Control Unit.....	3
Operating Range of the Remote Control Unit.....	3
Part Names and Functions	4
Front Panel.....	4
Display.....	5
Rear Panel.....	6
Remote Control Unit.....	7
Connections	9
Important Information	9
Cables Used for Connections.....	9
Converting Input Video Signals for Output (Video Conversion Function).....	10
Installing / Setting the Speakers	11
Speaker Connections	13
Connecting Devices	14
Connecting the Power Cord	24
Once Connections are Completed	24
Turning the Power On.....	24
Turning the Power Off.....	24
Settings	25
GUI Menu Map	25
GUI Menu Operation	26
Example of the Display of the GUI Mark at a Title.....	26
Examples of GUI Menu Screen Displays.....	26
Selecting the Input Source.....	27
Make the Optimal Speaker Settings, and Correct the Room Acoustics (Audyssey™ Auto Setup)	28
Making Detailed Settings (Manual Setup)	34
Making the Input Settings (Source Select)	46
Important Information.....	46

Playback	53
Important Information	53
Playing Components	53
Playing a Blu-ray Disc Player/DVD Player.....	53
Playing an iPod® Using a Control Dock for iPod.....	53
Playing an iPod® Connected Directly to the AVR-4310CI's USB Port 55.....	55
Tuning in Radio Stations	56
Important Information.....	56
Listening to XM Satellite Radio.....	57
Listening to SIRIUS Satellite Radio.....	58
Listening to HD Radio Stations.....	60
Playing Network Audio, USB Memory Devices	62
Important Information.....	62
Listening to Internet Radio.....	63
Playing Files Stored on a Computer.....	65
Playing Files Stored on USB Memory Devices.....	66
Listening to Napster.....	66
Listening to Rhapsody.....	68
Operations During Playback	70
Adjusting the Master Volume.....	70
Turning Off the Sound Temporarily (Muting).....	70
Listening with Headphones.....	70
To Stop.....	70
Stopping Playback Temporarily.....	70
Fast-forwarding or Fast-reversing.....	70
To Cue to the Beginning of a Track.....	70
Playing Repeatedly.....	70
Selecting Tracks.....	70
Shuffling Playback.....	70
Playing in Random Order.....	70
Searching Pages.....	70
Searching by First Letter.....	70
Selecting the Surround Mode (Surround Mode)	71
Adjusting the Sound and Picture Quality (Audio/Video Adjust)	73
Adjusting the Sound (Audio Adjust).....	73
Adjusting the Picture Quality (Picture Adjust).....	77

Checking the Status (Information)	78
--	----

Other Operations and Convenient Functions	79
--	----

Other Operations	79
Playing a Blu-ray Disc Player Compatible with DENON LINK 4th79.....	79
Playing Super Audio CD.....	79
Recording on an External Device (REC OUT mode).....	80
Convenient Functions	80
HDMI Control Function.....	80
Setting the Power to Standby After a Certain Amount of Time (Sleep Timer Function).....	81
Adjust the Volume of the Speakers.....	81
Saving Frequently Used Settings (Quick Select Function).....	82
Playing the Same Network Audio on Different Devices Connected in a Network (Party Mode Function).....	82
Operating a Wireless LAN-Compatible Mobile Terminal to Play Music and Still Pictures.....	83
Operating the AVR-4310CI with a Browser (Web Control Function).....	84
Various Memory Functions.....	85

Playing in ZONE2/ZONE3 (Multi-zone Function)	86
---	----

Audio Output	86
① Zone Playback by Speaker Output.....	86
② Zone Playback by Audio Output (PRE OUT).....	86
Video Output	86
Video Connection.....	86
Playback	87
Menu Operation	88
Quick Select Function	88
Sleep Timer Function	88

Operating the Connected Devices by Remote Control Unit.....89

Operating the Main Remote Control Unit89
Operating AV Equipment89
Presetting.....90
Operating Preset Components.....90
Setting the Remote ID.....93
Learning Function94
MACRO Function.....94
Punch Through Function.....95
Setting the Time the Backlight Stays Lit95
Adjusting the Backlight's Brightness.....95
Specifying the Zone Used with the Main Remote Control.....96
Resetting the Main Remote Control Unit.....96
Operating the Sub Remote Control Unit97
Switching Zones98
Switching the Multi-zone Input Source to the Same Input Source as Used in the MAIN ZONE.....98
Setting the Zone for Which the Sub Remote Control Unit is Used (ZONE SELECT LOCK Mode).....98
Setting the Remote ID.....98
Resetting the Settings98

Other Information99

Troubleshooting.....108

Restoring All the Settings to as They were at the Time of Purchase (Resetting the Microprocessor)111

Specifications112

List of preset codesEnd of this manual

Getting Started

Flow of Operations Through Playback

Perform the operations leading to playback on the AVR-4310CI in the order shown below.

Connections

Installing/Setting the Speakers (☞ page 11)



Speaker Connections (☞ page 13)



Connecting Devices (☞ page 14)



Turning the Power On (☞ page 24)



Settings

Audyssey™ Auto Setup (☞ page 28)



Manual Setup (☞ page 34)
※ Perform "Manual Setup" as necessary.



Source Select (☞ page 46)



Playback

Playing Components (☞ page 53)



Selecting the Surround Mode (☞ page 71)



Adjusting the Sound and Picture Quality (☞ page 73)

Cautions on Handling

• Before turning the power switch on

Check once again that all connections are correct and that there are no problems with the connection cables.

• Power is supplied to some of the circuitry even when the unit is set to the standby mode. When traveling or leaving home for long periods of time, be sure to unplug the power cord from the power outlet.

• About condensation

If there is a major difference in temperature between the inside of the unit and the surroundings, condensation (dew) may form on the operating parts inside the unit, causing the unit not to operate properly.

If this happens, let the unit sit for an hour or two with the power turned off and wait until there is little difference in temperature before using the unit.

• Cautions on using mobile phones

Using a mobile phone near this unit may result in noise. If so, move the mobile phone away from this unit when it is in use.

• Moving the unit

Turn off the power and unplug the power cord from the power outlet.

Next, disconnect the connection cables to other system units before moving the unit.

• Note that the illustrations in these instructions may differ from the actual unit for explanation purposes.

Cautions on Installation

Note:

For proper heat dispersal, do not install this unit in a confined space, such as a bookcase or similar enclosure.

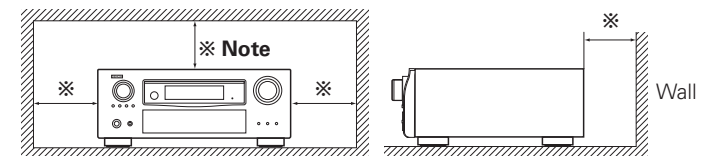

Preparations

Thank you for purchasing this DENON product. To ensure proper operation, please read this owner's manual carefully before using the product.

After reading them, be sure to keep them for future reference.

Accessories

Check that the following parts are supplied with the product.

① Owner's manual	1
② Getting started	1
③ Warranty (for North America model only).....	1
④ Service station list	1
⑤ Power cord (Cord length: Approx. 6.2 ft / 1.9 m)	1
⑥ Main remote control unit (RC-1116)	1
⑦ LR6/AA batteries (for RC-1116)	2
⑧ Sub remote control unit (RC-1121).....	1
⑨ R03/AAA batteries (for RC-1121).....	2
⑩ AM loop antenna (for HD Radio broadcasts)	1
⑪ Dipole antenna (for HD Radio broadcasts)	1
⑫ Setup microphone (DM-A409, Cord length: Approx. 25 ft / 7.6 m)	1

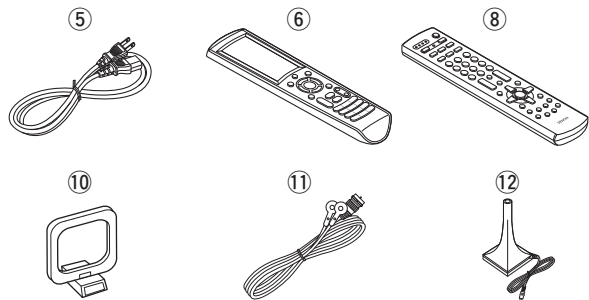

Insert Batteries in the Remote Control Unit

In addition to the AVR-4310CI, the included main remote control unit (RC-1116) can also be used to operate the equipment listed below.

- ① DENON system components
- ② Non-DENON system components
 - To operate component products other than DENON, you must set the preset code (☞ page 90 "Presetting").
 - When using component products other than DENON, if you cannot set the preset code, use the learning function (☞ page 94 "Learning Function").

Inserting the Batteries

- ① Lift the clasp and remove the rear lid.

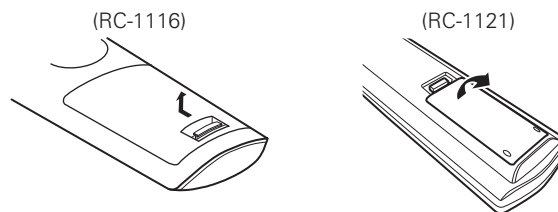

- ② Load the two batteries properly as indicated by the marks in the battery compartment.

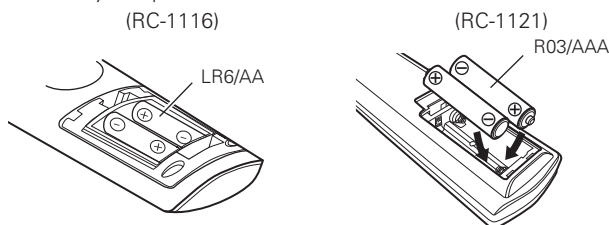

- ③ Put the rear cover back on.

NOTE

- Insert the specified batteries in the remote control unit.
- Replace the batteries with new ones if the set does not operate even when the remote control unit is operated close to the unit. (The supplied batteries are only for verifying operation.)
- When inserting the batteries, be sure to do so in the proper direction, following the "⊕" and "⊖" marks in the battery compartment.
- To prevent damage or leakage of battery fluid:
 - Do not use a new battery together with an old one.
 - Do not use two different types of batteries.
 - Do not attempt to charge dry batteries.
 - Do not short-circuit, disassemble, heat or dispose of batteries in flames.
- If the battery fluid should leak, carefully wipe the fluid off the inside of the battery compartment and insert new batteries.
- Remove the batteries from the remote control unit if it will not be in use for long periods.
- Used batteries should be disposed of in accordance with the local regulations regarding battery disposal.

Operating Range of the Remote Control Unit

Point the remote control unit at the remote sensor when operating it.

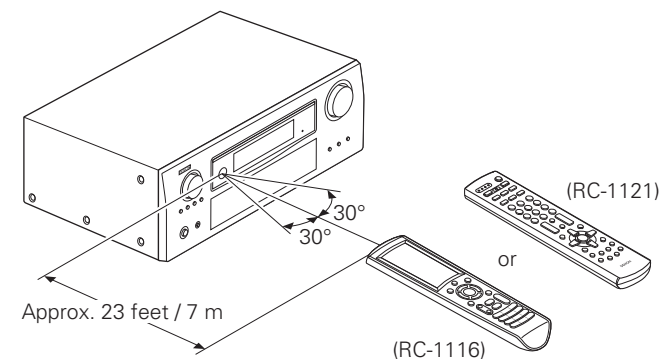

NOTE

The set may function improperly or the remote control unit may not operate if the remote control sensor is exposed to direct sunlight, strong artificial light from an inverter type fluorescent lamp or infrared light.

Part Names and Functions

Front Panel

For buttons not explained here, see the page indicated in parentheses ().

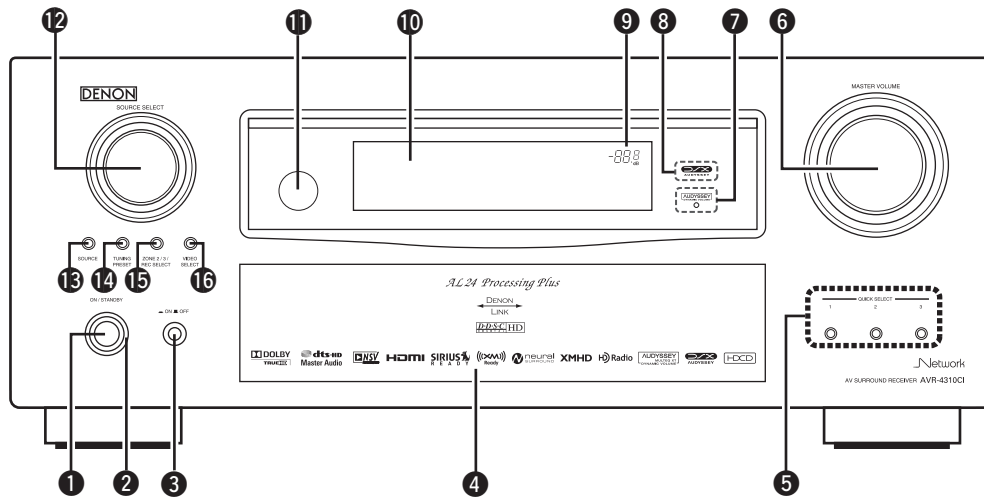

- 1 Power operation button (24)
- 2 Power indicator (24)
- 3 Power switch (24)
- 4 Door
When you are using buttons and/or terminals behind the door, press the bottom of the door to open it. When not using buttons and/or terminals behind the door, close it. Be careful not to catch your fingers when closing the door.
- 5 QUICK SELECT buttons (82)
- 6 MASTER VOLUME control knob (70)
- 7 AUDYSSEY DYNAMIC VOLUME™ indicator (75)
- 8 AUDYSSEY DSX indicator (76)
- 9 Master volume indicator
- 10 Display
- 11 Remote control sensor (3)
- 12 SOURCE SELECT knob (27)
- 13 SOURCE button (27)
- 14 TUNING PRESET button (58, 59, 61)
- 15 ZONE 2/3 / REC SELECT button (80, 87)
- 16 VIDEO SELECT button (48)

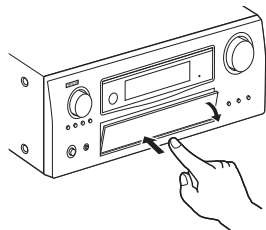

[With the door open]

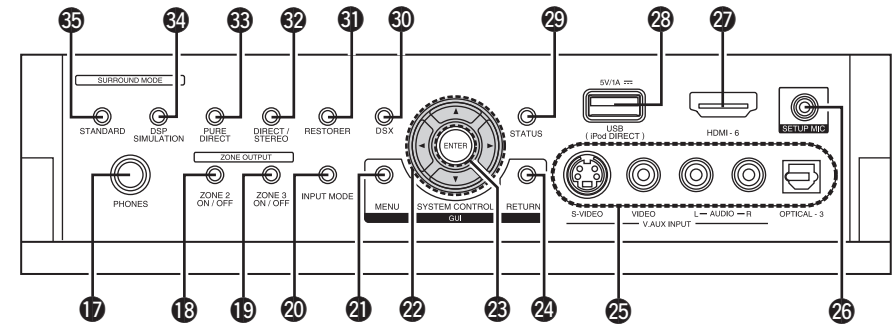

- 17 Headphones jack (70)
- 18 ZONE2 ON/OFF button (87)
- 19 ZONE3 ON/OFF button (87)
- 20 INPUT MODE button (49)
- 21 MENU button (26)
- 22 Cursor buttons (Δ ∇ ◀ ▶) (26)
- 23 ENTER button (26)
- 24 RETURN button (26)
- 25 V.AUX INPUT connectors (20)
- 26 SETUP MIC jack (29)
- 27 HDMI IN connector (14)
- 28 USB (iPod DIRECT) port (21)
- 29 STATUS button (78)
- 30 DSX button (76)
- 31 RESTORER button (77)
- 32 DIRECT/STEREO button (72)
- 33 PURE DIRECT button (72)
- 34 DSP SIMULATION button (72)
- 35 STANDARD button (71)

Display

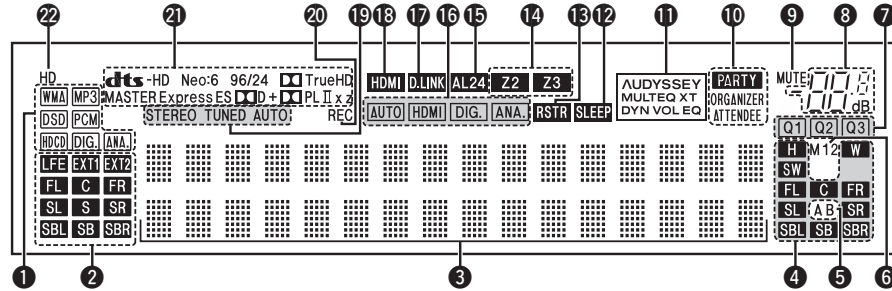
**1 Input signal indicators****2 Input signal channel indicators**

These light when digital signals are input. When playing HD Audio sources, the "EXT1" indicator lights when an extension channel (a channel other than the front, center, surround, surround back or LFE channel) is input. If there are two or more extension channels, the "EXT1" and "EXT2" indicators light.

3 Information display

The input source name, surround mode, setting values and other information are displayed here.

4 Output signal channel indicators**5 Surround speaker indicators**

These light according to the settings of the surround A and B speakers.

6 Monitor output indicators

These light according to the HDMI monitor output setting. When set to "Auto (Dual)", the indicators light according to the connection status.

7 QUICK SELECT indicators**8 Master volume indicator****9 MUTE indicator**

This lights when the mute mode is selected.

10 PARTY indicators

These indicators light during party mode.

- **ORGANIZER**

This lights to indicate that party mode has started as Organizer.

- **ATTENDEE**

This lights to indicate that party mode has started as Attendee.

11 AUDYSSEY MULTEQ XT indicators

Lighting is as follows, depending on the setting of "Dynamic EQ" (page 75) and "Dynamic Volume" (page 76).

- **AUDYSSEY MULTEQ XT DYN VOL**: When "DynamicEQ" and "Dynamic Volume" are "ON".
- **AUDYSSEY MULTEQ XT DYN EQ**: When the "Dynamic EQ" setting is "ON" and the "Dynamic Volume" setting is "OFF".
- **AUDYSSEY MULTEQ XT**: When "DynamicEQ" and "Dynamic Volume" are "OFF".

12 SLEEP indicator

This lights when the sleep mode is selected.

13 RESTORER indicator

This lights when the RESTORER mode is selected.

14 Multi zone indicators

These light when the power for the respective zone is turned on.

15 AL24 indicator

This lights when AL24 Processing Plus (page 101) is activated.

16 Input mode indicators**17 D.LINK indicator**

This lights when playing using DENON LINK connections.

18 HDMI indicator

This lights when playing using HDMI connections.

19 Tuner reception mode indicators

These light according to the reception conditions when the input source is set to "HD Radio".

- **STEREO**

In the FM mode, these light when receiving analog stereo broadcasts.

- **TUNED**

Lights when the broadcast is properly tuned in.

- **AUTO**

These light when in the auto tuning mode.

20 Recording output source indicator

This lights when the REC OUT mode is selected.

21 Decoder indicators

These light when the respective decoders are operating.

22 HD indicator

This lights during HD Radio reception.

Rear Panel

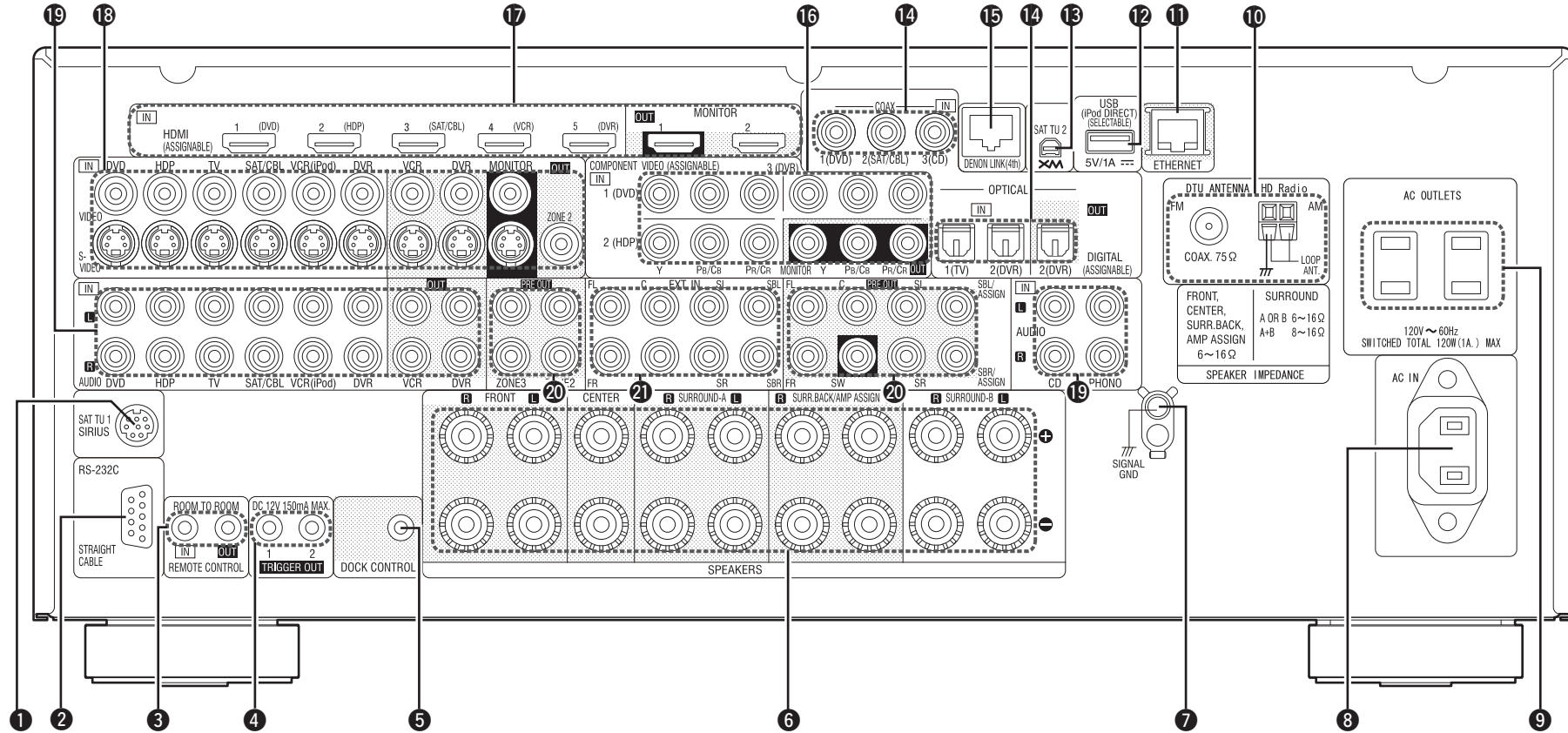

- | | | |
|--|---|--|
| 1 SIRIUS connector (19) | 8 AC inlet (24) | 15 DENON LINK connector (20) |
| 2 RS-232C connector (22) | 9 AC OUTLETS (24) | 16 COMPONENT VIDEO connectors (15, 17) |
| 3 REMOTE CONTROL jacks (22) | 10 HD Radio antenna terminals (19, 20) | 17 HDMI connectors (14) |
| 4 TRIGGER OUT jacks (22) | 11 ETHERNET connector (23) | 18 VIDEO / S-VIDEO connectors (15 ~ 18) |
| 5 DOCK CONTROL jack (16) | 12 USB (iPod DIRECT) port (21) | 19 Analog audio connectors (15 ~ 18) |
| 6 Speaker terminals (13) | 13 XM connector (18) | 20 PRE OUT connectors (22, 86) |
| 7 SIGNAL GND terminal (16) | 14 Digital audio connectors (15 ~ 19) | 21 EXT. IN connectors (21) |

Part Names and Functions

Remote Control Unit

Main Remote Control Unit (RC-1116)

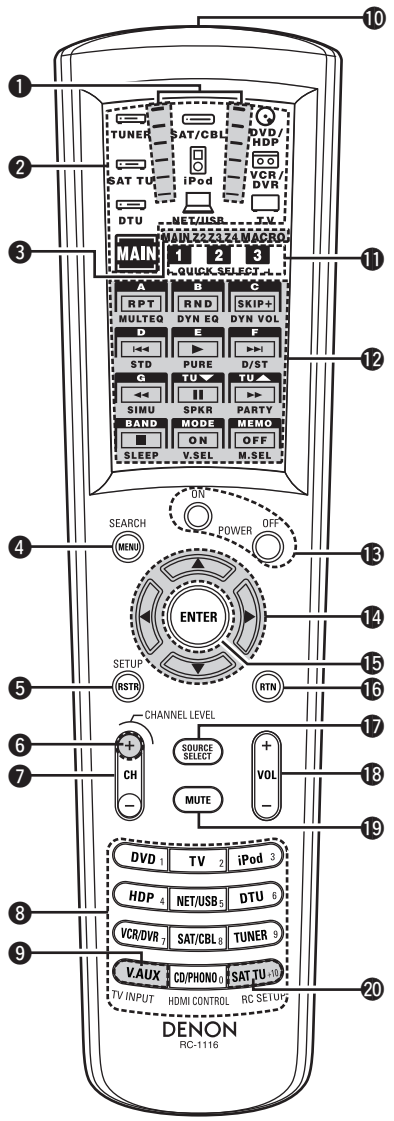

- 1 Signal transmission indicator (89)
- 2 Device select buttons (89)
- 3 Zone indicators / MACRO indicator (89)
- 4 MENU / SEARCH button (26)
- 5 RESTORER button (76)
- 6 CHANNEL LEVEL button (81)
- 7 Channel buttons (CH) (58 ~ 61)
- 8 Input source select buttons (27)
- 9 TV INPUT button (91)
- 10 Remote control signal transmitter (3)
- 11 QUICK SELECT button (82, 88)
- MACRO button (94)
- 12 Function buttons
See "Operations Possible by Main Remote Control Unit" (page 7, 8) for more information.
- 13 Power operation buttons (POWER ON / OFF) (24, 87)
- 14 Cursor buttons (Δ▽◀▶) (26)
- 15 ENTER button (26)
- 16 Return button (RTN) (26)
- 17 SOURCE SELECT button (27)
- 18 Master volume control buttons (VOL) (70)
- 19 Muting button (MUTE) (70)
- 20 RC SETUP button (90)

NOTE

The ZONE4 mode cannot be used.

Operations Possible by Main Remote Control Unit

Operations on the AVR-4310CI

Operations on 9 devices other than the AVR-4310CI

- Preset the remote control codes of the devices to be operated (page 90).
- The function button indicator changes depending on the Device select button you have selected.

Selected Device select button	Function button indicator	Button name
MAIN		21 MULTEQ® XT button (MULTEQ) (75)
		22 DSX button (SPKR) (76)
		23 Sleep timer button (SLEEP) (81, 88)
		24 DYNAMIC EQ™ button (DYN EQ) (75)
		25 DYNAMIC VOLUME™ button (DYN VOL) (75)
Z2		26 Surround mode buttons (71, 72)
		• STANDARD button (STD)
		• PURE DIRECT button (PURE)
Z3		• DIRECT / STEREO button (D/ST)
		• DSP SIMULATION button (SIMU)
Z4		27 PARTY button (82)
MACRO		28 Monitor select button (M.SEL) (37)
		29 Video select button (V.SEL) (48)
SAT/CBL iPod DVD/HDP VCR/DVR TV		30 Multi-zone power buttons (87)
		• Multi-zone power on button (ON)
		• Multi-zone power off button (OFF)
		31 Device power buttons (90, 91)
		• Device power on button (ON)
		• Device power off button (OFF)
		32 System buttons (70, 90 ~ 92)
		• Repeat button (RPT)
		• Random button (RND)
		• Disc skip up button (Skip+)
• Skip button (◀◀, ▶▶)		
• Play button (▶)		
• Search button (◀◀, ▶▶)		
• Still / Pause button ()		
• Stop button (■)		
		33 QUICK SELECT button (82, 88)
		34 MACRO button (94)

Selected Device select button	Function button indicator	Button name
TUNER		35 Preset Channel buttons(58 ~ 61, 64) 36 Tuner system buttons(57 ~ 60) <ul style="list-style-type: none"> • Tuning down / Channel down button (TU ▼) • Tuning up / Channel up button (TU ▲) • FM/AM band switching button (BAND) * • Tuning mode (Auto / Manual) button (MODE) • Preset memory button (MEMO) * : HD Radio only
SAT TU		
DTU		
NET/USB		

❑ **Multi-zone (ZONE2 / ZONE3) operations** (☞ page 86)

❑ **Punch through setting** (☞ page 95)



The time for which the backlight stays on can be changed (☞ page 95 “Setting the Time the Backlight Stays Lit”).

Sub Remote Control Unit (RC-1121)

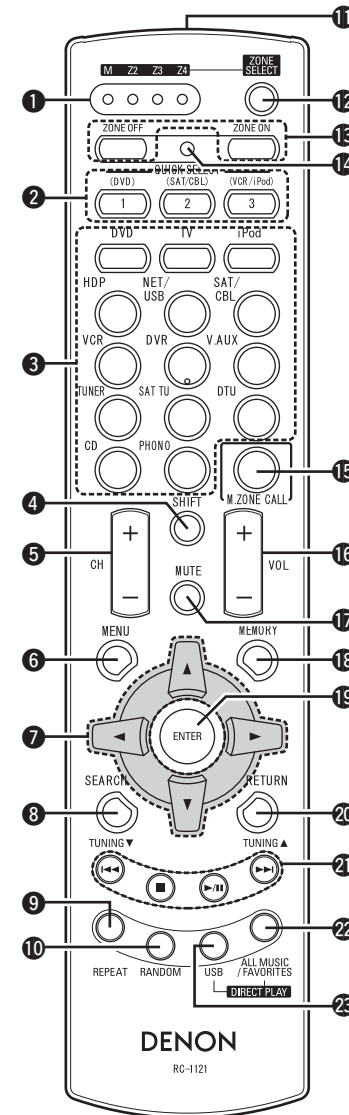

- 1** ZONE indicators (98)
- 2** QUICK SELECT buttons (82, 88)
- 3** Input source select buttons (97)
- 4** SHIFT button (57 ~ 59, 97)
- 5** CHANNEL button (97)
- 6** MENU button (88, 97)
- 7** Cursor buttons (▲▼◀▶) (97)
- 8** SEARCH button (70, 97)
- 9** REPEAT button (70, 97)
- 10** RANDOM button (70, 97)
- 11** Remote control signal transmitter (3)
- 12** ZONE SELECT button (98)
- 13** Zone power on/off buttons (87)
- 14** Advanced setup button (98)
- 15** MAIN ZONE call button (98)
- 16** Master volume control buttons (87)
- 17** Muting button (MUTE) (87)
- 18** MEMORY button (97)
- 19** ENTER button (97)
- 20** RETURN button (97)
- 21** System buttons (97)
- 22** ALL MUSIC/FAVORITES (DIRECT PLAY) button (97)
- 23** USB (DIRECT PLAY) button (66, 97)

Connections

Important Information

Connections for all compatible audio and video signal formats are described in this owner's manual. Please select the types of connections suited for the equipment you are connecting.

After connections are completed, certain settings must be made on the receiver. Make the settings indicated " **Set as Necessary** " for the individual items.

NOTE

- Do not plug in the power cord until all connections have been completed.
- When making connections, also refer to the operating instructions of the other components.
- Be sure to connect the left and right channels properly (left with left, right with right).
- Do not bundle power cords together with connection cables. Doing so can result in humming or noise.

Cables Used for Connections

Select the cables (sold separately) according to the equipment being connected.

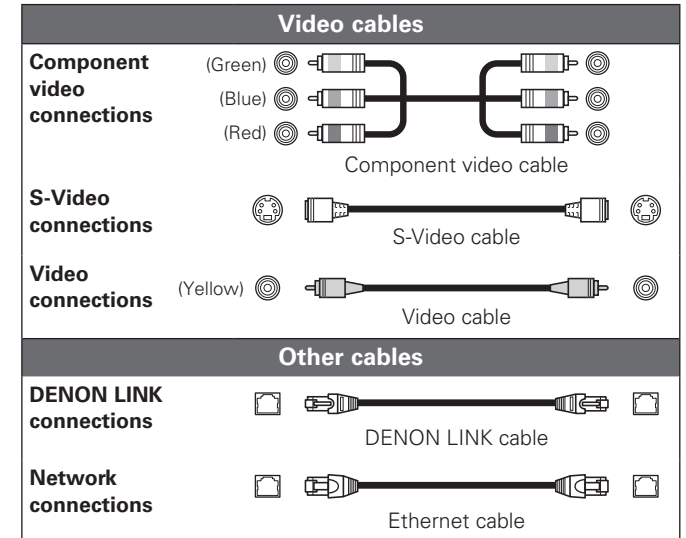
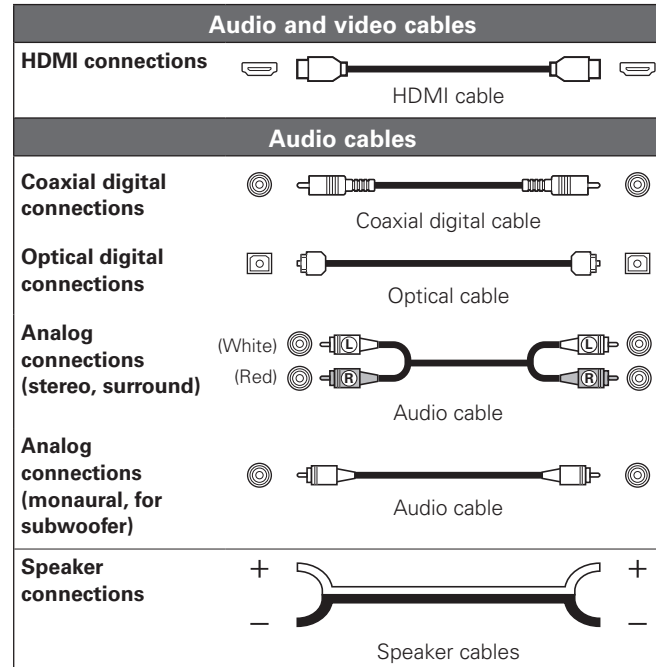

Converting Input Video Signals for Output (Video Conversion Function)

The AVR-4310CI has 4 different types of video input/output terminal (HDMI, Component video, S-Video, Video).

Use the terminals according to the devices to be connected.

This function automatically converts various formats of video signals input to the AVR-4310CI into the format used to output the video signals from the AVR-4310CI to a monitor. (☞ page 107 "Relationship Between Video Signals and Monitor Output").

[Flow of video signals for MAIN ZONE]

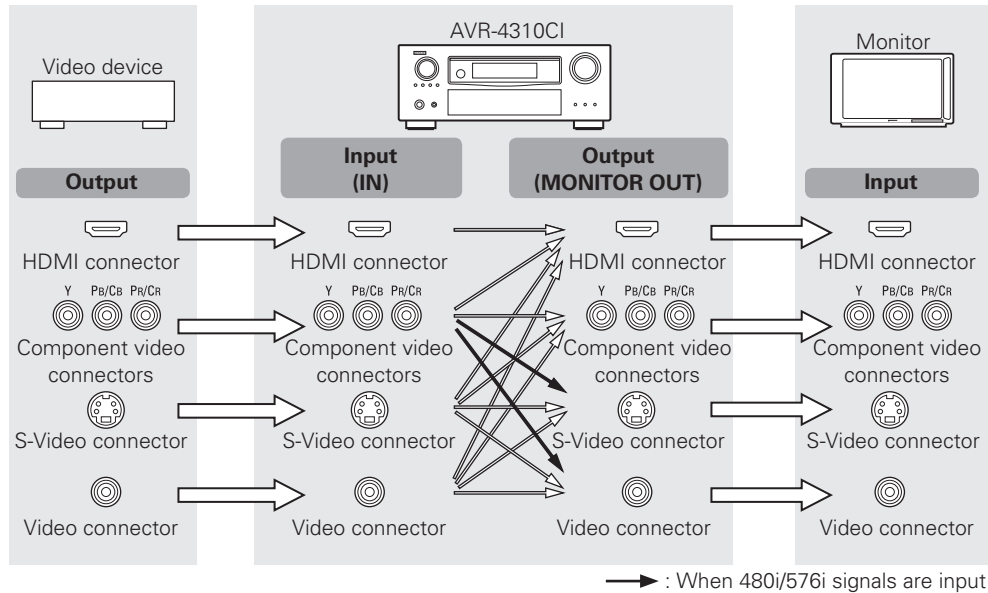

[Flow of video signals for ZONE2]

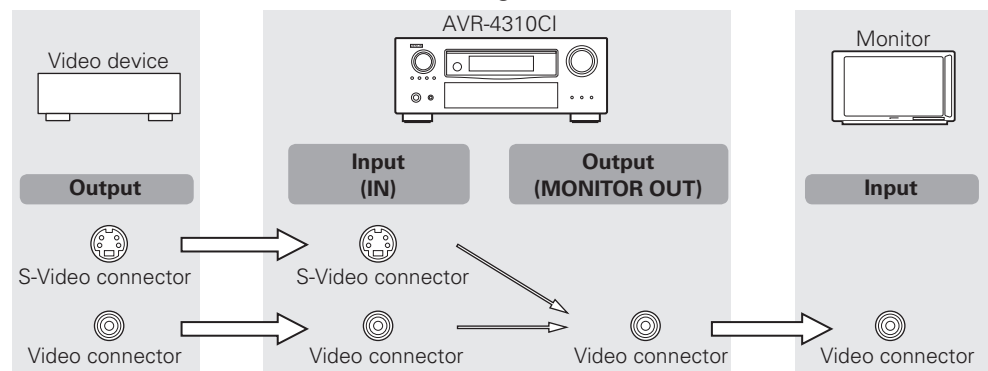

Set as Necessary

- Set when not using the video conversion function.
"Video Convert" (☞ page 49)
- Set when changing the resolution of the video signal.
"Resolution" (☞ page 49)



Resolutions of HDMI-compatible TVs can be checked at "HDMI Information" – "Monitor1" or "Monitor2" (☞ page 78).

NOTE

- HDMI signals cannot be converted into analog signals.
- When a non-standard video signal from a game machine or some other source is input, the video conversion function might not operate.
- 480p/576p/1080i/720p/1080p component video input signals cannot be converted into S-Video or Video format.

Installing / Setting the Speakers

The AVR-4310CI supports Audyssey DSX (page 100) and Dolby Pro Logic IIz (page 99), which use the surround space to create an even wider and deeper perspective.

To use Audyssey DSX, install front wide or front height speakers. To use Dolby Pro Logic IIz, install front height speakers.

1 Determine the Speaker Layout

Below we introduce examples of speaker layouts. Refer to these to arrange your speakers according to their type and how you want to use them.

Installing All the Speakers

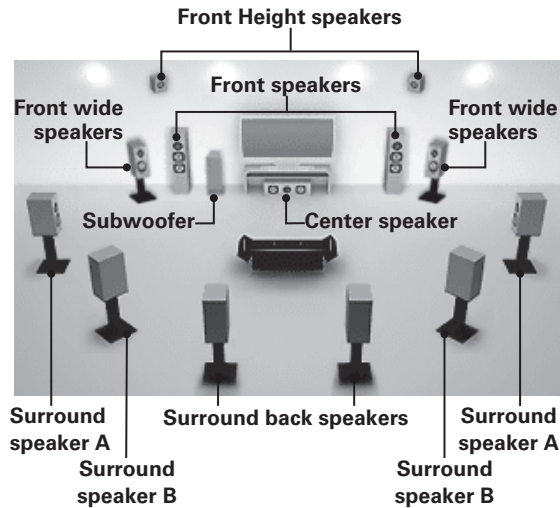

NOTE

- It is not possible to use the surround back speakers, front height speakers and front wide speakers simultaneously.
- Connect the surround speakers for watching movies to the surround A terminals, and the surround speakers for multichannel audio listening to the surround B terminals.
- The same surround signals are output from the surround A and surround B terminals.

When 7.1ch (Front Height Speaker) Connected

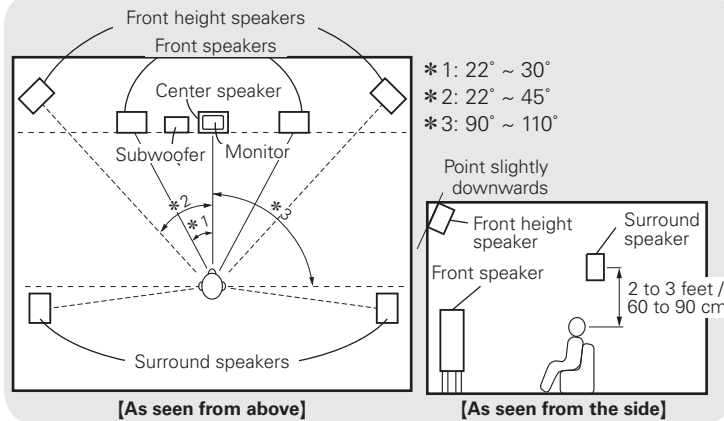

When 7.1ch (Front Wide Speaker) Connected

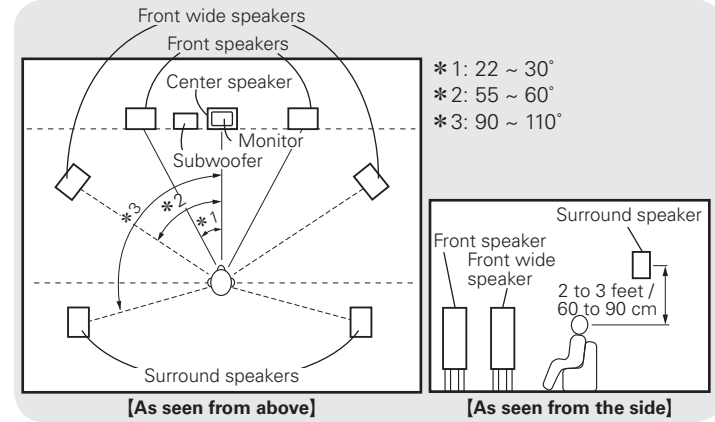

When 7.1ch (Surround Back Speaker) Connected

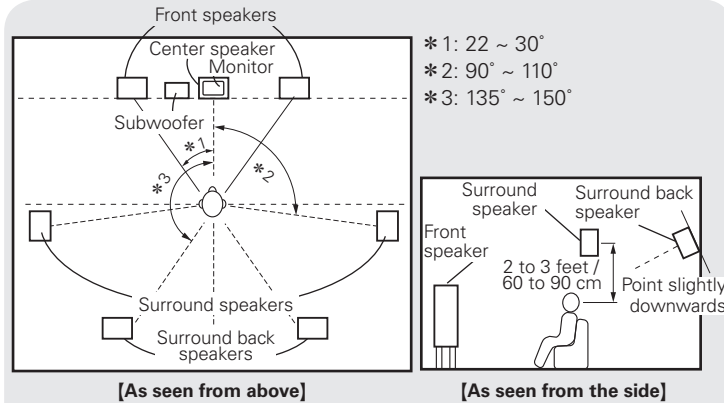

When 6.1ch (Surround Back Speaker) Connected

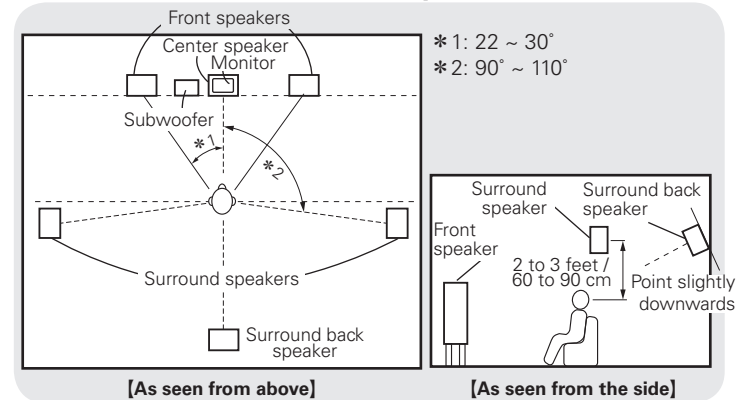



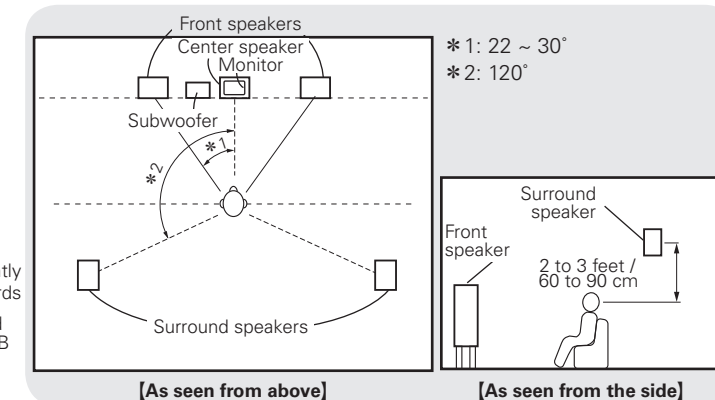







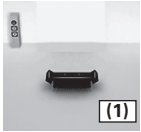

When 5.1ch Connected

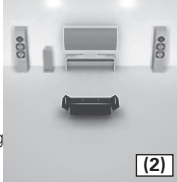

2 Set the "Amp Assign" Mode According to the Speaker Layout

The signals output from the AVR-4310CI's SURR. BACK/AMP ASSIGN speaker terminals can be switched (☞ page 34 "Amp Assign").

Amp assign mode (☞ page 34)	SURR. BACK / AMP ASSIGN Speaker connections	Example of speaker installation (Number of channels played)	Amp assign mode (☞ page 34)	SURR. BACK / AMP ASSIGN Speaker connections	Example of speaker installation (Number of channels played)
Normal	Surround Back Speakers (2 speakers)	 (7.1)	ZONE (MONO)	L ch : ZONE2 speaker R ch : ZONE3 speaker	<div style="display: flex; justify-content: space-around;"> <div style="text-align: center;"> <p>MAIN ZONE</p>  (5.1) </div> <div style="text-align: center;"> <p>ZONE2 or ZONE3</p>  (1) </div> </div>
Normal	Surround Back L Speaker (1 speaker) ※ Connect to the "L" speaker terminal. ※ Set "Surround Back" (☞ page 35) to "1spkr".	 (6.1)	Bi-Amp	Front Speakers ※ For connections, see "About Bi-amp Connections" (☞ page 13).	 (5.1)
Normal	Not connected ※ Set "Surround Back" (☞ page 35) to "None".	 (5.1)	2CH	Exclusively for 2-channel playback Front Speakers ※ Connect the speakers for 2-channel playback to the SURR. BACK/AMP ASSIGN terminal.	<div style="display: flex; justify-content: space-around;"> <div style="text-align: center;"> <p>Multi channel surround</p>  (5.1) </div> <div style="text-align: center;"> <p>DIRECT/STEREO</p>  (2) </div> </div> <p style="text-align: center;">↔ Switching</p>
ZONE2 (Default)	ZONE2 speakers	<div style="display: flex; justify-content: space-around;"> <div style="text-align: center;"> <p>MAIN ZONE</p>  (5.1) </div> <div style="text-align: center;"> <p>ZONE2</p>  (2) </div> </div>	Front Height	Front Height Speakers	 (7.1)
ZONE3	ZONE3 speakers	<div style="display: flex; justify-content: space-around;"> <div style="text-align: center;"> <p>MAIN ZONE</p>  (5.1) </div> <div style="text-align: center;"> <p>ZONE3</p>  (2) </div> </div>	Front Wide	Front Wide Speakers	 (7.1)

Speaker Connections

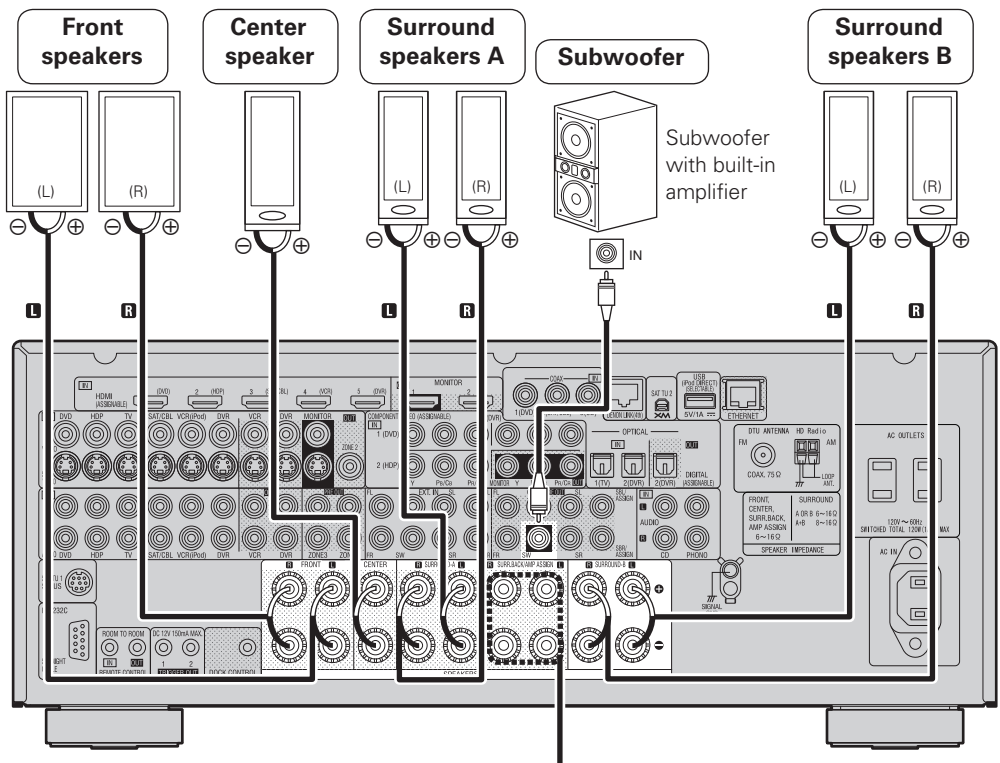

For connections of the SURR. BACK/AMP ASSIGN speaker terminals, see "Set the "Amp Assign" Mode According to the Speaker Layout" (page 12).





Protection Circuit

If the core wires touch the rear panel and the screws etc., or the \pm sides touch each other, the protection circuit will be activated and the power indicator will flash red at intervals of 0.5 secs. If the protection circuit is activated, the speaker output is isolated, and the power supply goes to the standby state. If the power supply is turned off, after the power supply cord is withdrawn, please confirm that speaker cable and input cable are connected. Also, if replaying large sound levels by using a speaker having an impedance less than that specified (eg, 4 Ω /ohms), the temperature will rise, and the protection circuit might be activated. The power supply will go into the standby state, and the power indicator will flash red at 2 second intervals.

In this case, please switch off the power supply, and wait until the AVR-4310CI has cooled down, and the surrounding ventilation is good. Even if there are no problems with the surrounding ventilation and connections, in the event of the protection circuit becoming activated, due to thinking that the AVR-4310CI has failed, please contact DENON Service center after switching off.

Connecting the Speaker Cables

Carefully check the left (L) and right (R) channels and + (red) and - (black) polarities on the speakers being connected to the AVR-4310CI, and be sure to interconnect the channels and polarities correctly.

- 1** Peel off about 0.03 ft/10 mm of sheathing from the tip of the speaker cable, then either twist the core wire tightly or terminate it. 
- 2** Turn the speaker terminal counterclockwise to loosen it. 
- 3** Insert the speaker cable's core wire to the hilt into the speaker terminal. 
- 4** Turn the speaker terminal clockwise to tighten it. 

- When using a banana plug**
Tighten the speaker terminal firmly before inserting the banana plug. 

 Use speakers with an impedance of 6 to 16 Ω /ohms. When using surround A and B speakers simultaneously, use speakers with an impedance of 8 to 16 Ω /ohms.

- NOTE**
 - Connect so that the speaker cable core wires do not protrude from the speaker terminal. The protection circuit may be activated if the core wires touch the rear panel or if the + and - sides touch each other (see "Protection Circuit").
 - Never touch the speaker terminals while the power supply is connected. Doing so could result in electric shock.

About Bi-amp Connections

These connections make for higher quality playback sound with no interference between the signals of the bass and treble units. When the "Amp Assign" setting (page 34) is "Bi-Amp", connect as follows.

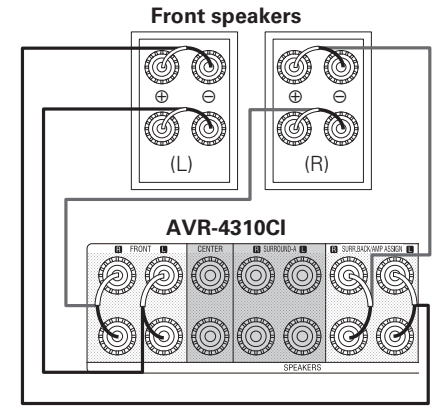

 When making a bi-amp connection, the same signal is output from the front speaker terminal and the SURR.BACK/AMP ASSIGN terminal.

- NOTE**
 - Use speakers compatible with bi-amp connections.
 - When making bi-amp connections, be sure to remove the short-circuiting plate or wire between the speaker's woofer and tweeter terminals.

Connecting Devices

Connecting Devices (🔗 page 14)

- ❑ **Connecting Devices Equipped with HDMI Terminals** (🔗 page 14)
- ❑ **Connecting the Monitor** (🔗 page 15)
- ❑ **Connecting the Playback Components**
 - Blu-ray Disc Player / DVD Player (🔗 page 15)
 - Control dock for iPod (🔗 page 16)
 - CD Player (🔗 page 16)
 - Record Player (🔗 page 16)
- ❑ **Connecting the Recording Components**
 - Digital Video Recorder (🔗 page 17)
 - Video Cassette Recorder (🔗 page 17)
- ❑ **Connect the Tuner**
 - TV (🔗 page 18)
 - Satellite Receiver / Cable Tuner (🔗 page 18)
 - XM (🔗 page 18)
 - SIRIUS (🔗 page 19)
 - HD Radio (🔗 page 19)
- ❑ **Connections to Other Devices**
 - Components Equipped with a DENON LINK connector (🔗 page 20)
 - Video Camera / Game Console (🔗 page 20)
 - USB Port (🔗 page 21)
 - Component with Multi-channel Output connectors (🔗 page 21)
 - External Power Amplifier (🔗 page 22)
 - External Controller (🔗 page 22)
- ❑ **Connecting to a Home Network (LAN)** (🔗 page 23)

Connecting Devices Equipped with HDMI Terminals

Important Information

❑ About HDMI

“HDMI” is the abbreviation of “High Definition Multimedia Interface”. This interface allows transfer of digital video signals and digital audio signals over a single HDMI cable.

“HDMI”, “HDMI logo” and “High-Definition Multimedia Interface” are trademarks or registered trademarks of HDMI Licensing LLC.

❑ Functions Usable with HDMI Connections

Deep Color

Eliminates on-screen color banding, for smooth tonal transitions and subtle gradations between colors. Enables increased contrast ratio.

x.v.Color

Lets HDTVs display colors more accurately. Enables displays with natural, vivid colors. “x.v.Color” is a Sony registered trademark.

Auto Lip Sync (🔗 page 37)

If you connect the receiver to a TV that supports the Auto Lip Sync function, it can automatically correct delay between the audio and video.

HDMI Control Function (🔗 page 80)

This function allows you to operate external devices from the receiver and operate the receiver from external devices.

NOTE

- These functions will not work if the device connected to the HDMI terminal does not support Deep Color or x.v.Color signal transfer or the Auto Lip Sync function.
- The HDMI control function may not work depending on the device it is connected to and its settings.
- You cannot operate a TV or Blu-ray Disc player / DVD player that is not compatible with the HDMI control function.

❑ Copyright Protection System (HDCP)

The AVR-4310CI supports HDCP (High-bandwidth Digital Contents Protection). HDCP is a copyright protection technology for digital video signals. The devices connected to the AVR-4310CI must also support HDCP.

NOTE

When a device that does not support HDCP is connected, video signals are not properly output.

Connections

The AVR-4310CI allows connection of inputs from up to 6 HDMI devices and output to 2 monitors.

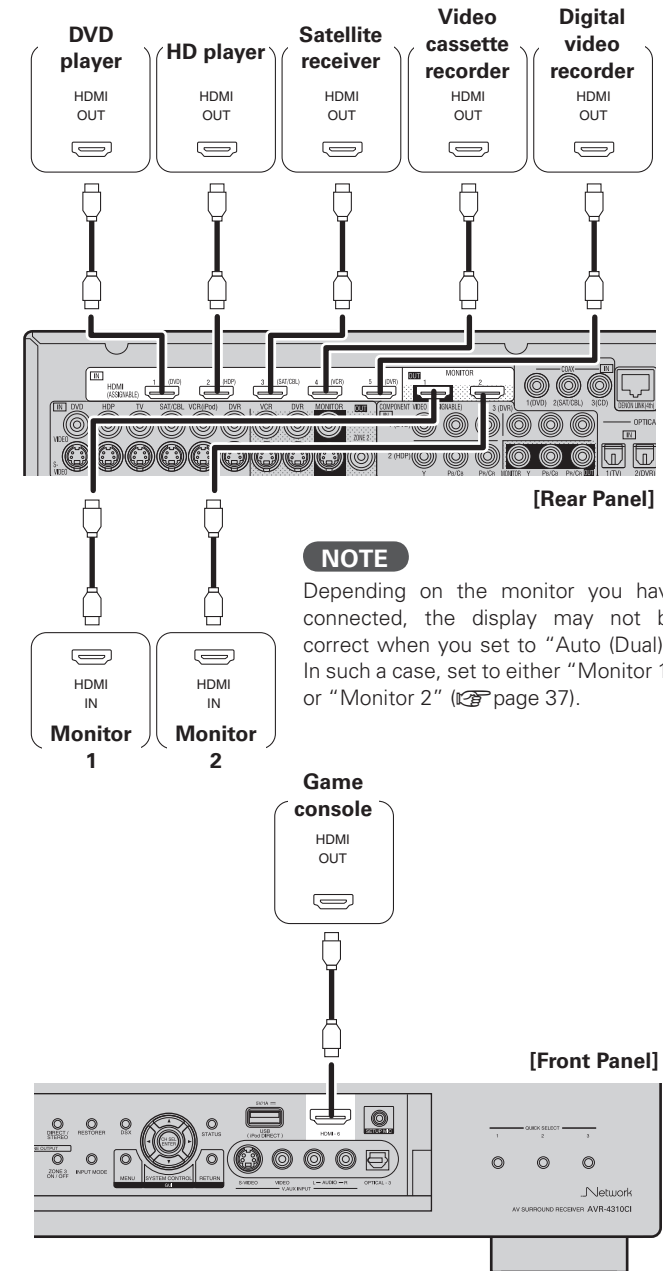

NOTE

Depending on the monitor you have connected, the display may not be correct when you set to “Auto (Dual)”. In such a case, set to either “Monitor 1” or “Monitor 2” (🔗 page 37).

Connecting Devices



- Use a cable on which the HDMI logo is indicated (a certified HDMI product) for connection to the HDMI connector. Normal playback may not be possible when using a cable other than one on which the HDMI logo is indicated (a non-HDMI-certified product).
- When the AVR-4310CI is connected to other devices with HDMI cables, also connect the AVR-4310CI and TV using an HDMI cable.
- When a device supporting Deep Color signal transfer is connected, use a cable compatible with HDMI version 1.3a.
- Video signals are not output if the input video signals do not match the monitor's resolution. In this case, switch the Blu-ray Disc/DVD player's resolution to a resolution with which the monitor is compatible.

NOTE

- If the GUI menu "HDMI Audio Out" setting (page 37) is set to "Amp", the sound may be interrupted when the monitor's power is turned off.
- The audio signal from the HDMI output terminal (sampling frequency, number of channels, etc.) may be limited by the HDMI audio specifications of the connected device regarding permissible inputs.

Connecting to a Device Equipped with a DVI-D Terminal

When an HDMI/DVI conversion cable (sold separately) is used, the HDMI video signals are converted to DVI signals, allowing connection to a device equipped with a DVI-D terminal.

NOTE

- No sound is output when connected to a device equipped with a DVI-D terminal. Also make the audio connections.
- Signals cannot be output to DVI-D devices that do not support HDCP.
- Depending on the combination of devices, the video signals may not be output.

Settings Related to HDMI Connections

Set as necessary. For details, see the respective reference pages.

Input Assign (page 46)

Set this to change the HDMI input terminal to which the input source is assigned.

HDMI Setup (page 37)

Make settings for HDMI video/audio output.

- RGB Range
- Vertical Stretch
- Auto Lip Sync
- HDMI Audio Out
- Monitor Out
- HDMI Control

NOTE

The audio signals output from the HDMI connectors are only the HDMI input signals.

Connecting the Monitor

- Select the terminal to use and connect the device.
- For video connections, see "Converting Input Video Signals for Output (Video Conversion Function)" (page 10).

For instructions on HDMI connections, see "Connecting Devices Equipped with HDMI Terminals" on page 14.

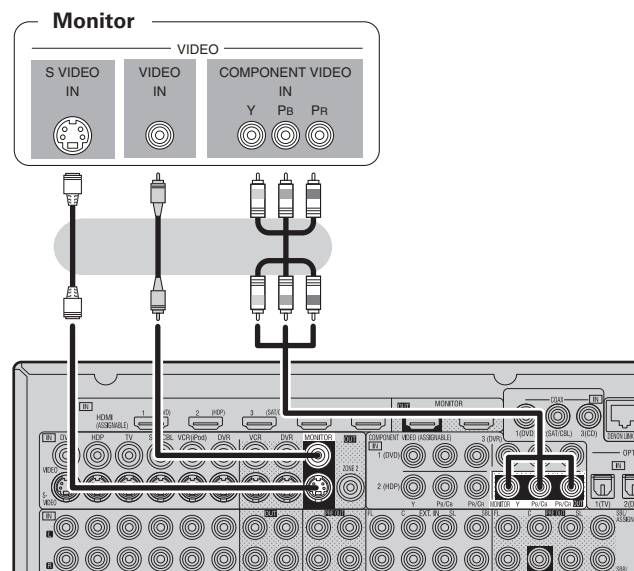

To listen to TV audio through this device, use the optical digital or analog connection.

Connecting the Playback Components

Blu-ray Disc Player / DVD Player

Select the terminal to use and connect the device.

For instructions on HDMI connections, see "Connecting Devices Equipped with HDMI Terminals" on page 14.

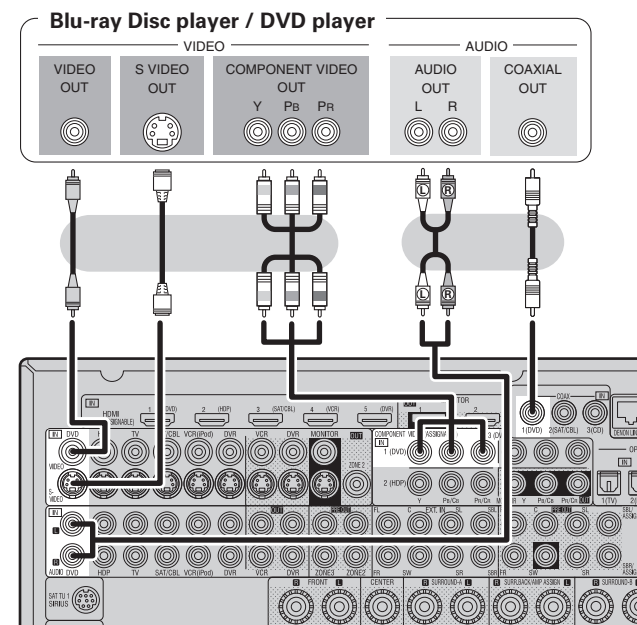

Set as Necessary

Set this to change the input signal to which the input source is assigned.

"Input Assign" (page 46)

NOTE

In the case of HD audio (Dolby TrueHD, DTS-HD and Dolby Digital Plus and DTS Express) audio playback, connect with HDMI (page 14, "Connecting Devices Equipped with HDMI Terminals").

Control Dock for iPod

Use a DENON control dock for iPod (ASD-1R or ASD-11R, sold separately) to connect the iPod to the AVR-4310CI. For instructions on the control dock for iPod settings, refer to the control dock for iPod's operating instructions.

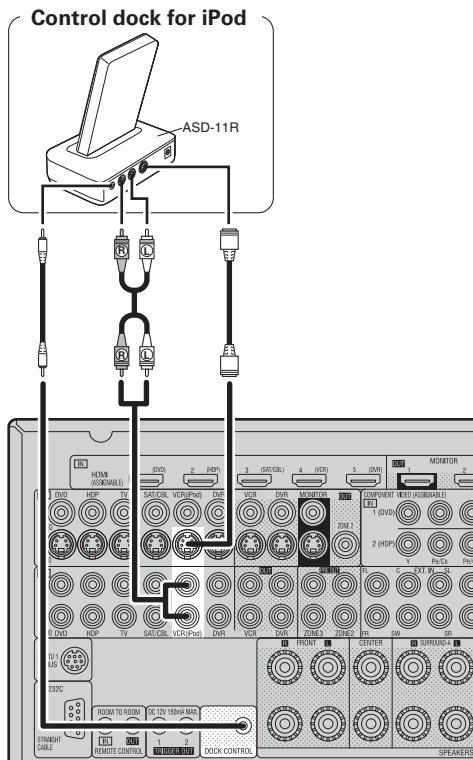

Set as Necessary

Set other than when iPod is assigned to the VCR (iPod) terminal. **"Input Assign" – "iPod dock"** (page 48)



- With the default settings, the iPod can be used connected to the VCR (iPod) connector.
- You can also connect the iPod you are using directly to the USB port of the AVR-4310CI (page 21 "USB Port").

CD Player

Select the terminal to use and connect the device.

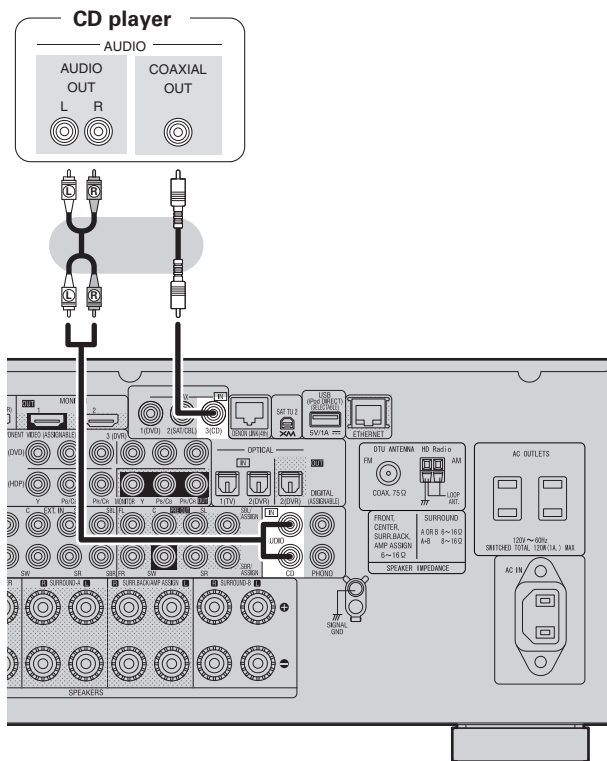

Set as Necessary

Set this to change the input signal to which the input source is assigned.

"Input Assign" (page 46)

Record Player

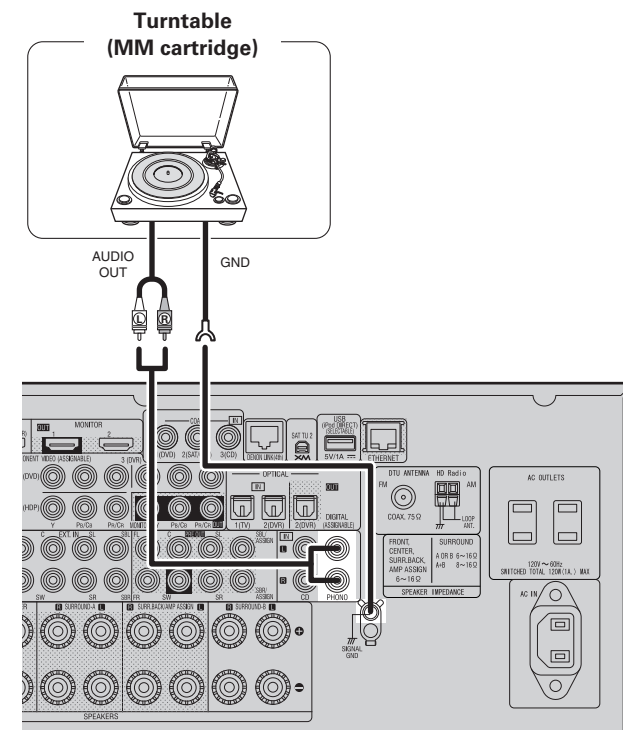

- The AVR-4310CI is compatible with record players with an MM cartridge. When you connect to a record player with an MC cartridge, use a commercially available MC head amp or a step-up transformer.
- When you increase the volume without connecting the record player, there may be "booming" noise from the speakers.

NOTE

The SIGNAL GND terminal of the AVR-4310CI is not a safety ground connection. Connect it to reduce noise when noise is excessive. Note that depending on the record player, connecting the ground line may have the reverse effect of increasing noise. In this case, it is not necessary to connect the ground line.

Connecting Devices

Connecting the Recording Components

Digital Video Recorder

Select the terminal to use and connect the device.

For instructions on HDMI connections, see “Connecting Devices Equipped with HDMI Terminals” on page 14.

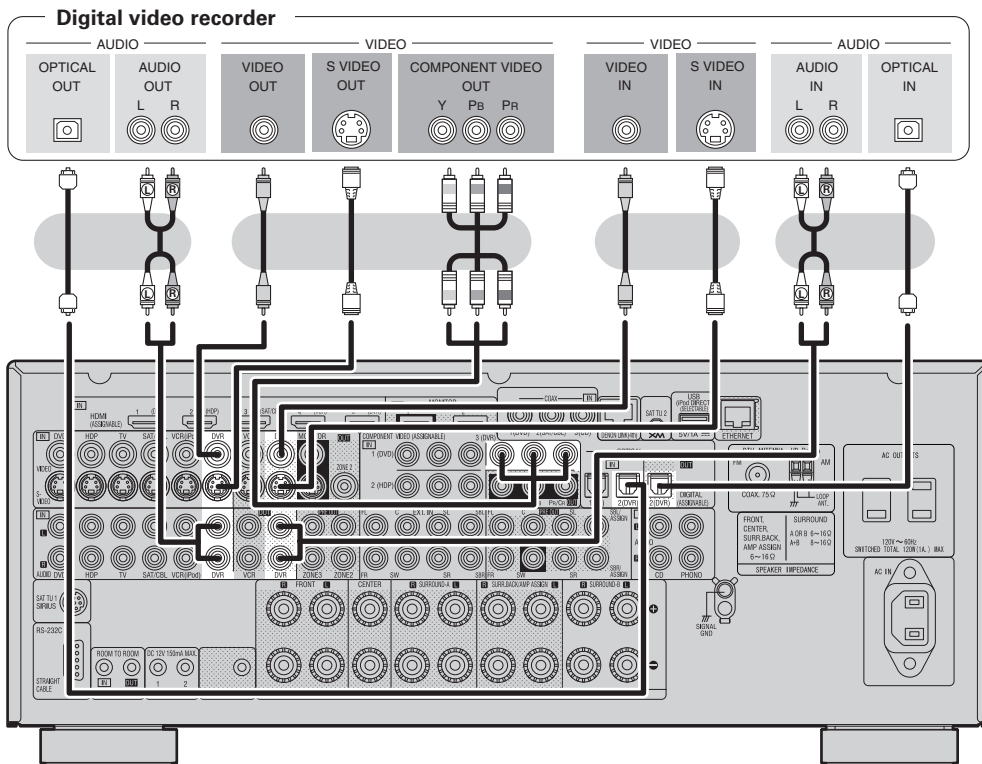

Set as Necessary

Set this to change the input signal to which the input source is assigned.

“Input Assign” (👉 page 46)

NOTE

- To record video signals through the AVR-4310CI, use the same type of video cable for connection between the AVR-4310CI and the player as the cable used for connection between the AVR-4310CI and the recorder.
- Do not connect the output of the component connected to the AVR-4310CI's OPTICAL2 (DVR) output connector to any input connector other than OPTICAL2 (DVR).

Video Cassette Recorder

Select the terminal to use and connect the device.

For instructions on HDMI connections, see “Connecting Devices Equipped with HDMI Terminals” on page 14.

Video cassette recorder

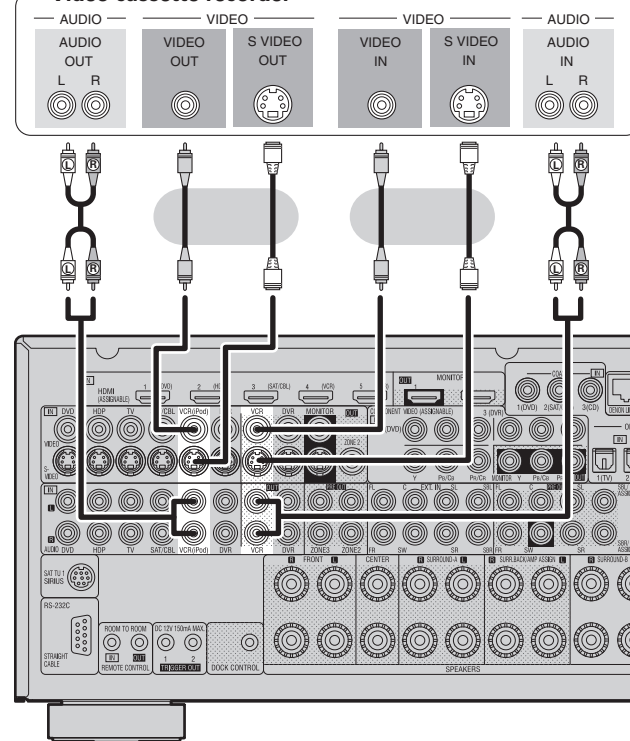

Set as Necessary

Set this to change the input signal to which the input source is assigned.

“Input Assign” (👉 page 46)

NOTE

To record video signals through the AVR-4310CI, use the same type of video cable for connection between the AVR-4310CI and the player as the cable used for connection between the AVR-4310CI and the recorder.

Connect the Tuner

TV

Select the terminal to use and connect the device.

For instructions on HDMI connections, see “Connecting Devices Equipped with HDMI Terminals” on page 14.

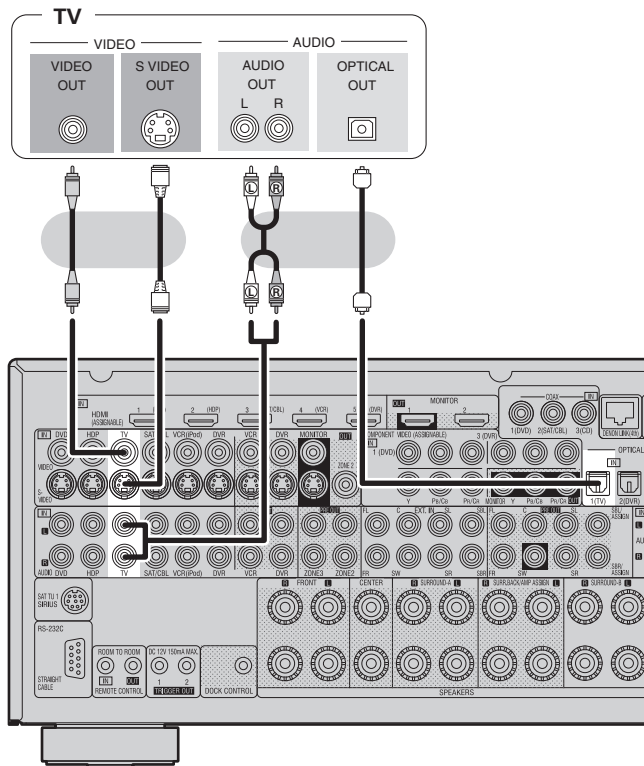

Set as Necessary

Set this to change the input signal to which the input source is assigned.
“Input Assign” (👉 page 46)

Satellite Receiver / Cable Tuner (Set Top Box)

Select the terminal to use and connect the device.

For instructions on HDMI connections, see “Connecting Devices Equipped with HDMI Terminals” on page 14.

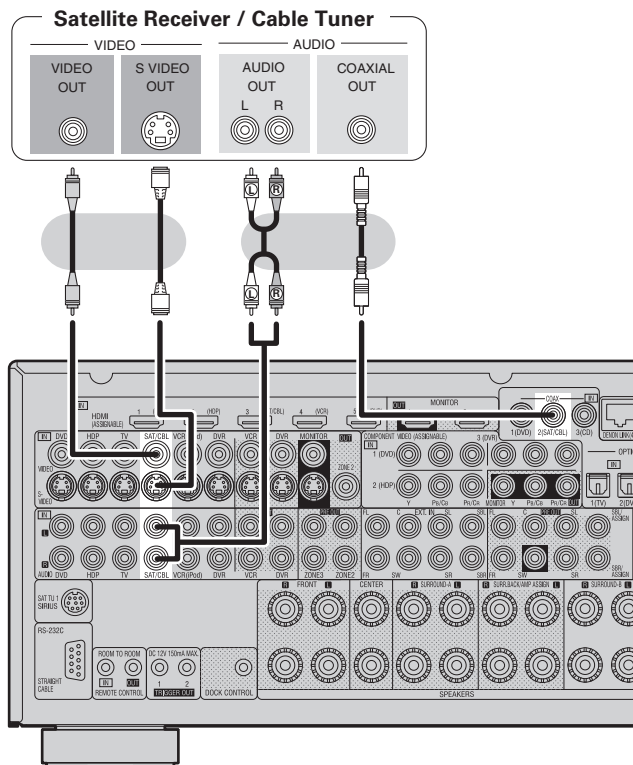

Set as Necessary

Set this to change the input signal to which the input source is assigned.
“Input Assign” (👉 page 46)

XM Connector

- The AVR-4310CI is an XM Ready® receiver. You can receive XM® Satellite Radio by connecting to the XM Mini-Tuner and Home Dock (includes home antenna, each sold separately) and subscribing to the XM service.
 - Plug the XM Mini-Tuner and Home Dock into the XM connector on the rear panel.
 - Position the Home Dock antenna near a south-facing window to receive the best signal.
- For details, see “Listening to XM Satellite Radio” (👉 page 57).
 When making connections, also refer to the operating instructions of the XM Mini-Tuner and Home Dock.

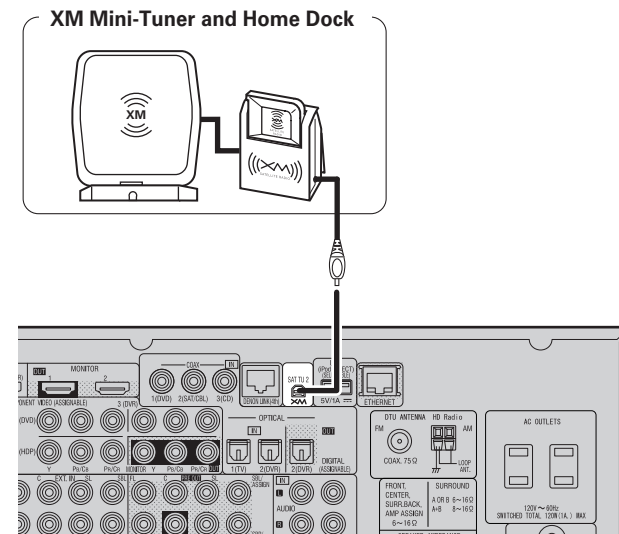

NOTE

Keep the power cord unplugged until the XM Mini-Tuner and Home Dock connection have been completed.

SIRIUS, XM and all related marks and logos are trademarks of Sirius XM Radio Inc. and its subsidiaries. All rights reserved. Service not available in Alaska and Hawaii.

Connecting Devices

SIRIUS Connector

- The AVR-4310CI is a SIRIUS Satellite Radio Ready® receiver. You can receive SIRIUS® Satellite Radio by connecting to the SiriusConnect Home Tuner and subscribing to the SIRIUS service.
- Plug the SIRIUS connector on the SIRIUS service.
- Position the Home Tuner antenna near a south-facing window to receive the best signal.

For details, see “Listening to SIRIUS Satellite Radio” (page 58). When making connections, also refer to the operating instructions of the SiriusConnect Home Tuner.

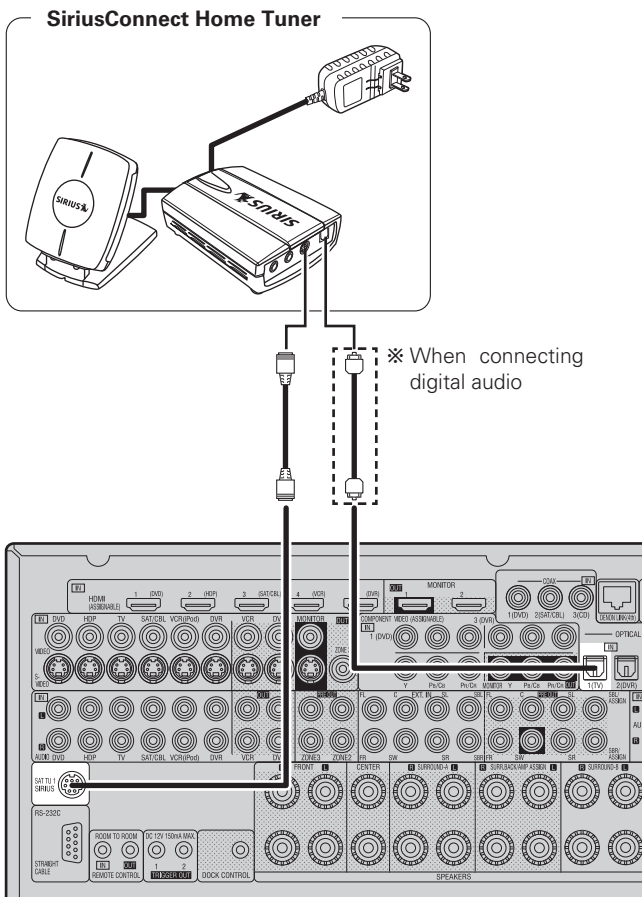

Set as Necessary

When connecting digital of the SiriusConnect Home Tuner, perform the setting “Digital”.
“Input Assign” (page 47)

NOTE

Keep the power cord unplugged until the SiriusConnect Home Tuner connection have been completed.

SIRIUS, XM and all related marks and logos are trademarks of Sirius XM Radio Inc. and its subsidiaries. All rights reserved. Service not available in Alaska and Hawaii.

Positioning the Antenna

For a consistent satellite signal, the antenna must be positioned correctly. Use the following map to determine which area you are in and position the antenna accordingly.

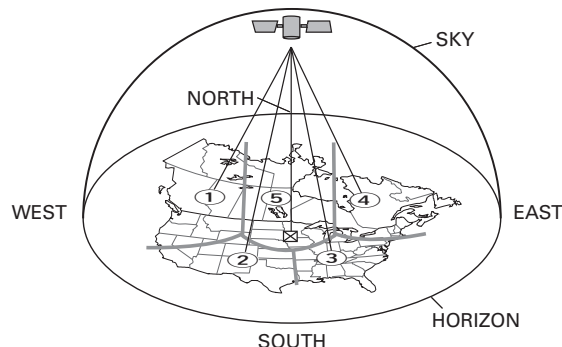

- Area 1** : Point the antenna toward the sky in the **east, northeast, or southeast**, either through a window or outside.
- Area 2** : Point the antenna toward the sky in the **north or northeast**, either through a window or outside.
- Area 3** : Point the antenna toward the sky in the **north or northwest**, either through a window or outside.
- Area 4** : Point the antenna toward the sky in the **west, northwest, or southwest**, either through a window or outside.
- Area 5** : Put the antenna outside and point it **straight up**. The antenna cannot be used indoors.

HD Radio Terminals

HD Radio is a service that is only available within the United States.

AM loop antenna (for HD Radio broadcasting, supplied)

- To prevent interference, install at least 3.3 feet/ 1 m away from the antenna connected to the AVR-4310CI’s other AM tuner terminal.

Direction of broadcasting station

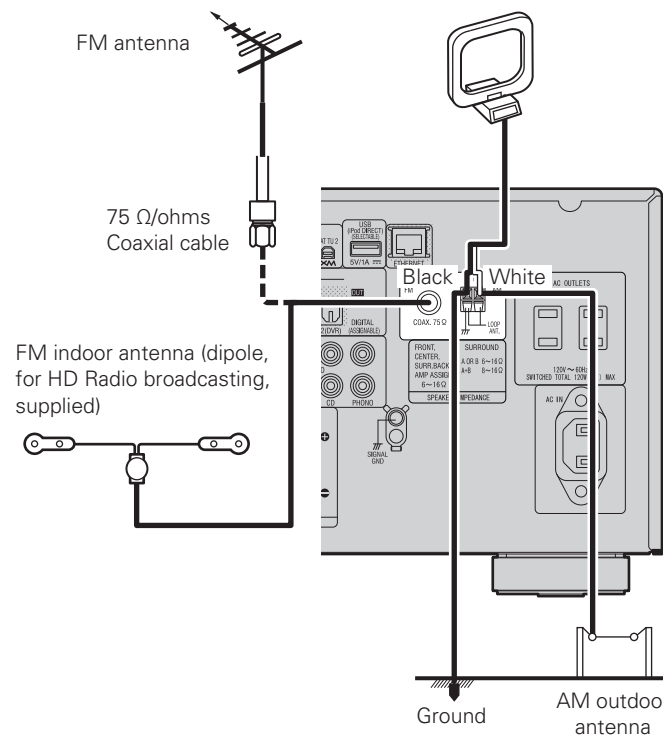

AM loop antenna assembly

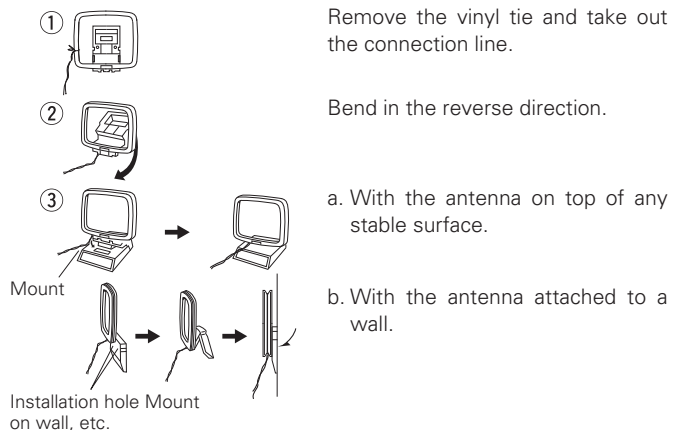

Connection of AM antennas

1. Push the lever.
2. Insert the conductor.
3. Return the lever.

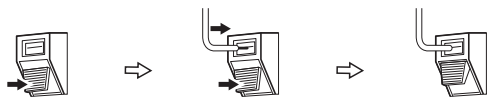

NOTE

- Do not connect two FM antennas simultaneously.
- Even if an external AM antenna is used, do not disconnect the AM loop antenna.
- Make sure the AM loop antenna lead terminals do not touch metal parts of the panel.

Connections to Other Devices

Components Equipped with a DENON LINK Connector

Multichannel playback is possible, including DVD-Audio and Super Audio CD (page 79 "Playing Super Audio CD"). In addition, refer to page 79 "Playing a Blu-ray Disc Player Compatible with DENON LINK 4th" for information on connecting a player that supports DENON LINK 4th edition.

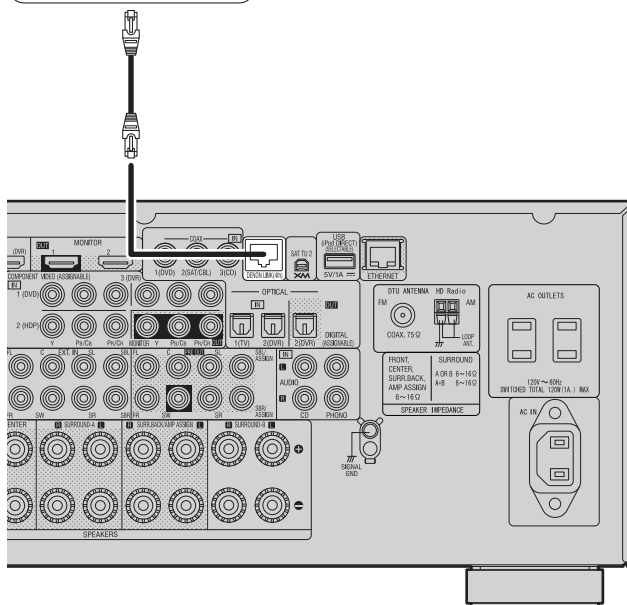

Set as Necessary

When connecting by use of DENON LINK, set "Digital" to "D.LINK".
"Input Assign" (page 47)

Video Camera / Game Console

Select the terminal to use and connect the device.

For instructions on HDMI connections, see "Connecting Devices Equipped with HDMI Terminals" on page 14.

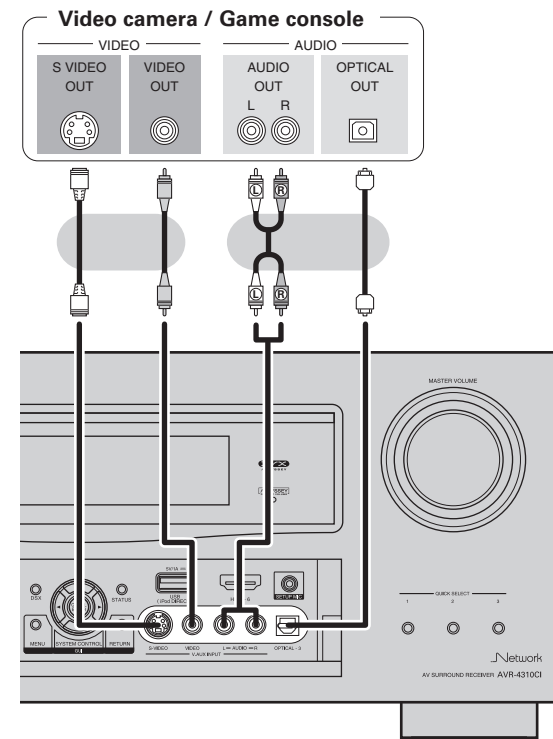

Set as Necessary

Set this to change the input signal to which the input source is assigned.
"Input Assign" (page 46)

NOTE

When a non-standard video signal from a game machine or some other source is input, the video conversion function might not operate.

USB Port

When you connect an iPod or USB memory device to the USB port, you can enjoy music, etc., stored on the iPod or USB memory device.

Front panel

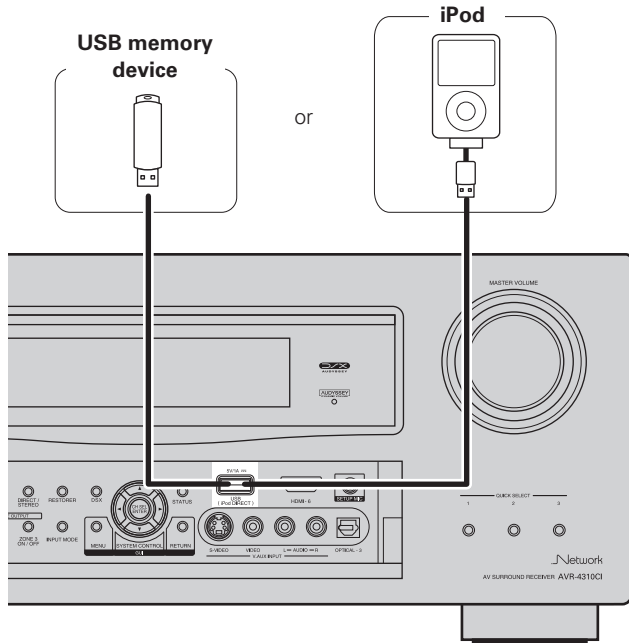

Rear panel

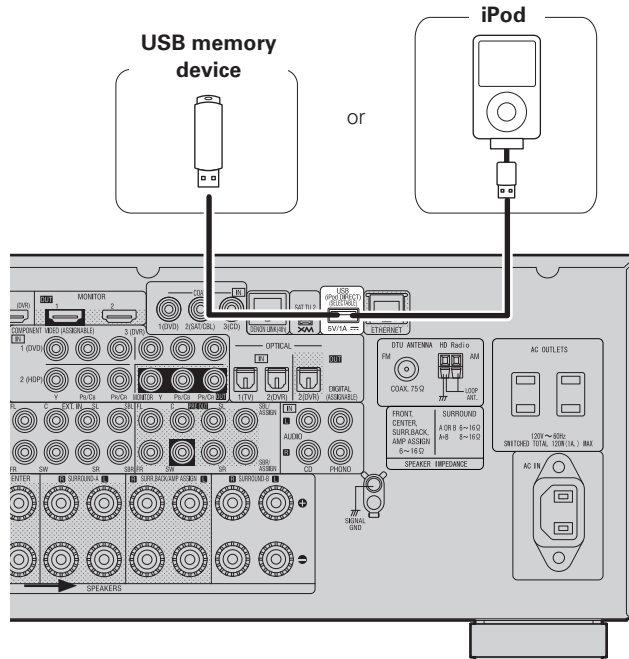

Set as Necessary

Set when you change the USB port for use.
"USB Select" (page 51)



- In the initial status, USB memory devices can be used by connecting them to the USB port on the front panel.
- To connect an iPod to the AVR-4310CI, use the USB cable supplied with the iPod.
- When you want to playback a movie file stored on the iPod, use the DENON control dock for iPod (ASD-11R or ASD-1R, sold separately) (page 16 "Control Dock for iPod").
- For iPods, playback is possible on iPod touch, classic and nano sold from generation 5 on. For details, check the Web or page 55.

NOTE

- **You cannot use the USB port on the front panel and rear panel simultaneously.** Select and connect the USB port you are to use.
- Do not use an extension cable when connecting a USB memory device. This may cause radio interference with other devices.

Component with Multi-channel Output connectors

The video signal can be connected in the same way as a Blu-ray Disc player / DVD player (page 15 "Blu-ray Disc Player / DVD Player").

Blu-ray Disc player / DVD player / External decoder

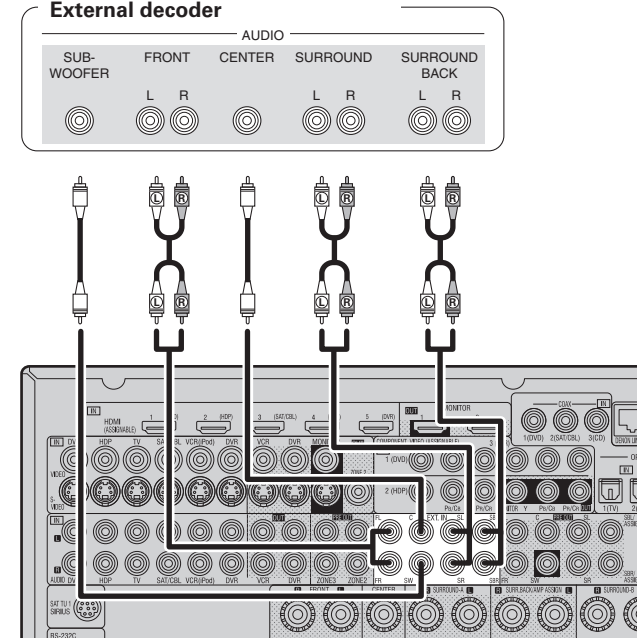

Set as Necessary

To play analog signals input from the external input (EXT. IN) terminal, set **"Input Mode"** (page 49) to "EXT. IN". "EXT. IN" can also be selected with **INPUT MODE** on the main unit.



When a device is connected to the SBL/SBR terminal of the external input terminals (EXT. IN), set **"Amp Assign"** (page 34) to "Normal".

External Power Amplifier

- Select the terminal to use and connect the device.
- Connect when using an external power amp or an amp you already have.

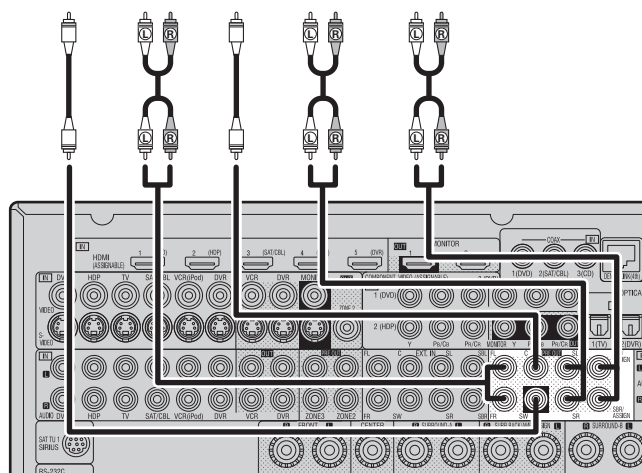
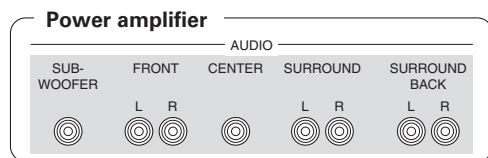

- When using just one surround back speaker, connect it to the left channel (L).
- Use the volume control on the subwoofer to control subwoofer volume.
- If the subwoofer volume sounds low, use the volume control provided on the subwoofer to adjust the volume.

NOTE

- When speakers have been connected to PRE OUT terminals, do not connect the speakers to the speaker terminals.
- The channel output from the PRE OUT SBL and SBR terminals changes depending on the "Amp Assign" setting (page 34).

External Controller

RS-232C connector

When you connect an external control device, you can control the AVR-4310CI with the external control device. Perform the operation below beforehand.

- ① Turn on the AVR-4310CI's power.
- ② Turn off the AVR-4310CI's power from the external controller.
- ③ Check that the AVR-4310CI is in the standby mode.

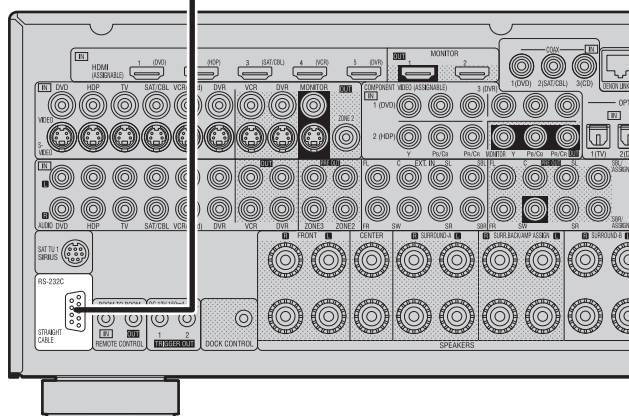

Set as Necessary

Set this to use the RS-232C connector for the DENON RF remote controller.
"232C Port" (page 44)



When using the AVR-4310CI in combination with the DENON RF remote controller (RC-7000CI, sold separately) or RF remote receiver (RC-7001RCI, sold separately), two-way communication is enabled. The AVR-4310CI's status information as well as iPod and Internet audio music files can be browsed watching the RF Remote Controller's display. For details, refer to the operating instructions of the respective devices.

NOTE

On the GUI menu, when setting "232C Port" to "2Way Remote", you cannot use the RS-232C connector as an external controller (page 44).

REMOTE CONTROL jacks

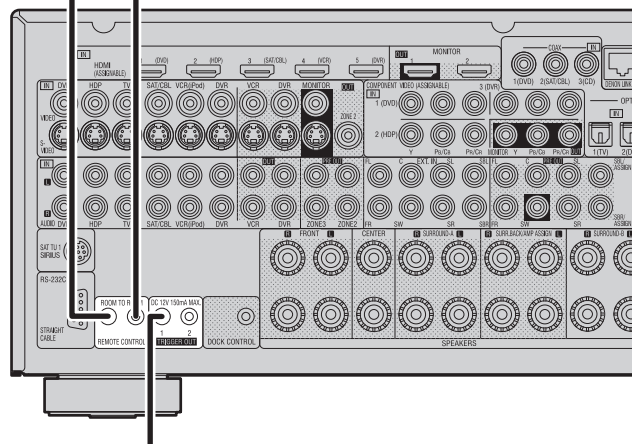
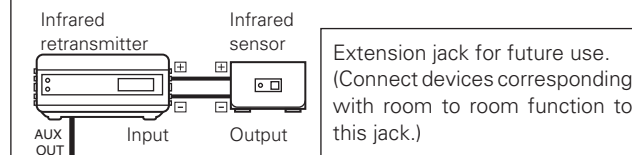

TRIGGER OUT jacks

The TRIGGER OUT output terminal outputs a maximum 12 V/150 mA electrical signal. When a device with TRIGGER IN terminal is connected via a monaural mini-plug, the connected device's power on/standby can be controlled through linked operation to the AVR-4310CI.

Set as Necessary

Set to change the conditions for linked operation via the TRIGGER OUT 1 or TRIGGER OUT 2 terminal.
"Trigger Out1" or "Trigger Out2" (page 44)



When connecting a 2nd device, connect to the TRIGGER OUT 2 terminal in the same way as the TRIGGER OUT 1 terminal.

Connecting Devices

Connecting to a Home Network (LAN)

When you connect the AVR-4310CI to a home network, you can enjoy listening to music files stored on your PC, internet radio audio and other sources. You can also control the AVR-4310CI from your PC via the Web browser.

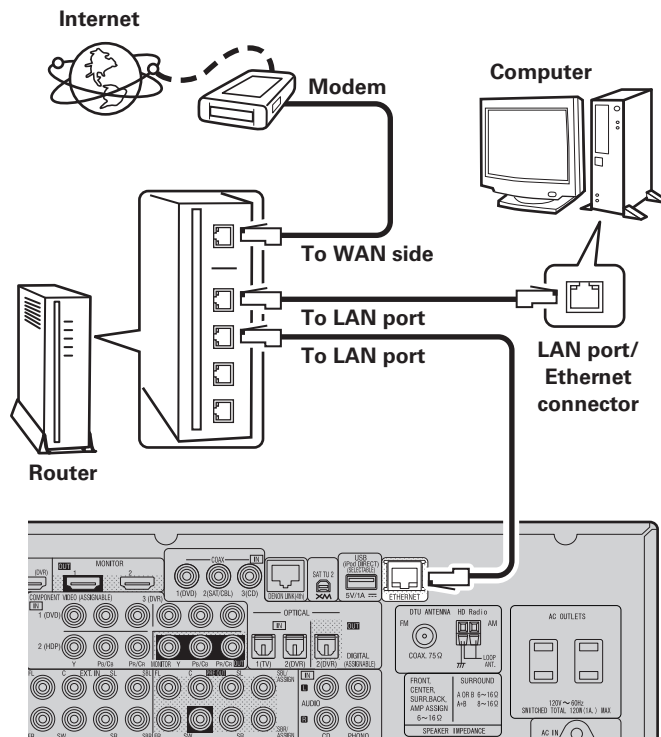

For connections to the Internet, contact an ISP (Internet Service Provider) or a computer shop.

Required system

Broadband Internet connection

Modem

Router

When using the AVR-4310CI, we recommend you use a router equipped with the following functions:

- Built-in DHCP server
This function automatically assigns IP addresses on the LAN.
- Built-in 100BASE-TX switch
When connecting multiple devices, we recommend a switching hub with a speed of 100 Mbps or greater.

Ethernet cable (CAT-5 or greater recommended)

Some flat type Ethernet cables are easily affected by noise. We recommend using a normal type cable.

Computer [Recommended system]

- **OS :**
Windows® XP Service Pack2 or later, Windows Vista
 - **Software (Prepare one of the following.)**
 - Windows Media Player ver.11
 - DLNA-compatible server software
 - **Internet browser :**
Microsoft Internet Explorer 6 or later
 - **LAN port**
 - **300 MB or more free disk space**
- ※ Operation is possible with DLNA servers other than the above, but such DLNA servers are not supported. For details, check the Web.

NOTE

- A contract with an ISP is required to connect to the Internet. No additional contract is needed if you already have a broadband connection to the Internet.
- The types of routers that can be used depend on the ISP. Contact an ISP or a computer shop for details.
- Depending on the server, video files may be displayed, but they cannot be played on the AVR-4310CI.



- If you have an Internet provider contract for a line on which network settings are made manually, make the settings at “Network Connecting” (page 39).
- With the AVR-4310CI, it is possible to use the DHCP and Auto IP functions to make the network settings automatically.
- When using the AVR-4310CI with the broadband router’s DHCP function enabled, the AVR-4310CI automatically performs the IP address setting and other settings. When using the AVR-4310CI connected to a network with no DHCP function, make the settings for the IP address, etc., at “Network Connecting” (page 39).
- The AVR-4310CI is not compatible with PPPoE. A PPPoE-compatible router is required if you have a contract for a line of the type with which the PPPoE is set.
- Depending on the ISP with which you have your contract, it may be necessary to make proxy server settings to use the Internet radio function. If you made proxy server settings on the computer to connect to the Internet, make the proxy server settings on the AVR-4310CI in the same way.

Symbols used to indicate buttons in this manual

- Button located on both the main unit and the remote control unit → **BUTTON**
- Button only on the main unit → **<BUTTON>**
- Button only on the remote control unit → **[BUTTON]**

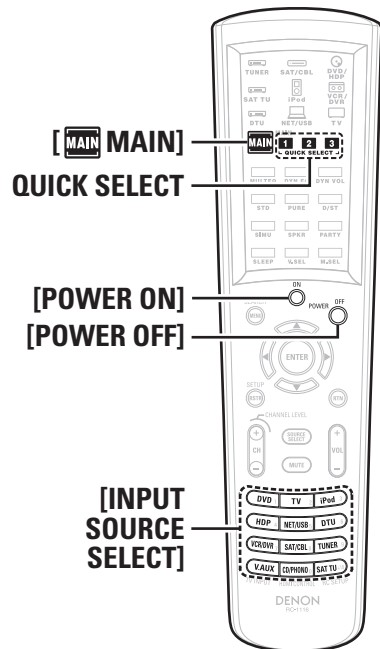
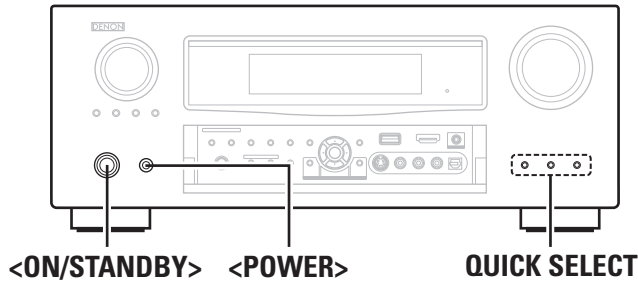

Connecting the Power Cord

Wait until all connections have been completed before connecting the power cord.

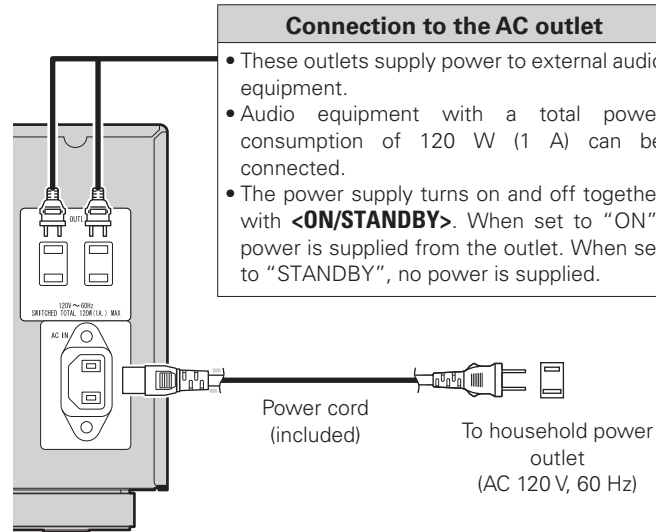

Connection to the AC outlet

- These outlets supply power to external audio equipment.
- Audio equipment with a total power consumption of 120 W (1 A) can be connected.
- The power supply turns on and off together with **<ON/STANDBY>**. When set to "ON", power is supplied from the outlet. When set to "STANDBY", no power is supplied.

NOTE

- Insert the AC plugs securely. Incomplete connections could cause noise.
- Only use the AC outlets to plug in audio equipment. Do not use them as power supplies for hairdryers or anything other than audio equipment.

Once Connections are Completed

Turning the Power On

- 1 Press <POWER>.**
The power indicator lights red and the power is set to the standby mode.
- 2 Press [MAIN] to switch the main remote control unit to "MAIN" mode** (page 89 "Operating the Main Remote Control Unit").
- 3 Press [POWER ON] or <ON/STANDBY>.**
The power indicator flashes green and the power turns on.

※ Also press [INPUT SOURCE SELECT] or **QUICK SELECT** when in standby mode, the power turns on.
When [INPUT SOURCE SELECT] has been pressed, the input source set with the [INPUT SOURCE SELECT] is set. If a **QUICK SELECT** has been pressed, the input source stored in the memory for the quick select function is set (page 82 "Saving Frequently Used Settings (Quick Select Function)").

Turning the Power Off

- 1 Press [MAIN] to switch the main remote control unit to "MAIN" mode** (page 89 "Operating the Main Remote Control Unit").
- 2 Press [POWER OFF] or <ON/STANDBY>.**
The power is set to the standby mode.
- 3 Press <POWER>.**
The power indicator turns off, and so does the power.

NOTE

Power continues to be supplied to some of the circuitry even when the power is in the standby mode. When leaving home for long periods of time or when traveling, either press **<POWER>** to turn off the power, or unplug the power cord from the power outlet.

Settings



Symbols used to indicate buttons in this manual

Button located on both the main unit and the remote control unit

→ **BUTTON**

Button only on the main unit

→ **<BUTTON>**

Button only on the remote control unit

→ **[BUTTON]**

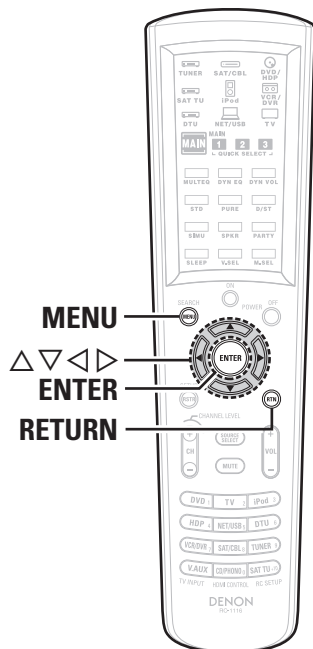
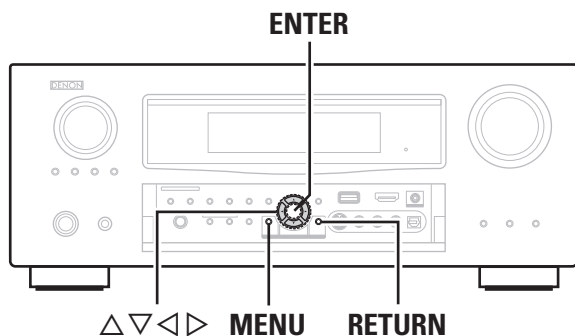

GUI Menu Map



Pressing **MENU** displays the GUI menu. From this menu, you can move to various setting screens.



Surround Mode (page 71)

Select the surround mode.

- | | |
|--|---|
| <input type="checkbox"/> STEREO | <input type="checkbox"/> WIDE SCREEN |
| <input type="checkbox"/> DIRECT | <input type="checkbox"/> SUPER STADIUM |
| <input type="checkbox"/> STANDARD | <input type="checkbox"/> ROCK ARENA |
| <input type="checkbox"/> DOLBY PLIIz | <input type="checkbox"/> JAZZ CLUB |
| <input type="checkbox"/> DOLBY PLIIx,
DOLBY PLII or
DOLBY PL | <input type="checkbox"/> CLASSIC
CONCERT |
| <input type="checkbox"/> DTS NEO:6 | <input type="checkbox"/> MONO MOVIE |
| <input type="checkbox"/> neural | <input type="checkbox"/> VIDEO GAME |
| <input type="checkbox"/> 7CH STEREO | <input type="checkbox"/> MATRIX |
| | <input type="checkbox"/> VIRTUAL |



Source Select (page 46)

SAT/CBL, VCR, DVR, V.AUX, NET/USB, Favorites, Internet Radio, Media Server, USB/iPod, Napster, Rhapsody, XM, SIRIUS, HD Radio, PHONO, CD, DVD, HDP, TV

Select input source and make playback settings.

※ The displayed menu differs according to the selected input source.

- | | |
|--|---|
| <input type="checkbox"/> Play | <input type="checkbox"/> Still Picture |
| <input type="checkbox"/> Playback Mode | <input type="checkbox"/> Auto Preset |
| <input type="checkbox"/> Input Assign | <input type="checkbox"/> Preset Skip |
| <input type="checkbox"/> Video | <input type="checkbox"/> Preset Name |
| <input type="checkbox"/> Input Mode | <input type="checkbox"/> Parental Lock |
| <input type="checkbox"/> Rename | <input type="checkbox"/> Antenna Aiming |
| <input type="checkbox"/> Source Level | |



Audio/Video Adjust (page 73)

Adjust various audio and video parameters.

- | | |
|---------------------------------------|---|
| <input type="checkbox"/> Audio Adjust | <input type="checkbox"/> Picture Adjust |
|---------------------------------------|---|



Auto Setup (page 28)

Optimize speaker settings and correct room acoustics problem.

- Audyssey™ Auto Setup
- Parameter Check



Manual Setup (page 34)

Make detailed settings for various parameters.

- | | |
|--|---|
| <input type="checkbox"/> Speaker Setup | <input type="checkbox"/> Option Setup (Continued) |
| <input type="checkbox"/> HDMI Setup | • Remote (SIRIUS/XM) |
| <input type="checkbox"/> Audio Setup | • Remote ID |
| <input type="checkbox"/> Network Setup | • 232C Port |
| <input type="checkbox"/> Zone Setup | • Dimmer |
| <input type="checkbox"/> Option Setup | • Setup Lock |
| • Volume Control | • Maintenance Mode |
| • Source Delete | • Firmware Update |
| • GUI | • Add New Feature |
| • Quick Select Name | <input type="checkbox"/> Language |
| • Zone Rename | |
| • Trigger Out 1 | |
| • Trigger Out 2 | |



Information (page 78)

Show information about receiver settings, input signals, etc.

- | | |
|---|---|
| <input type="checkbox"/> Status | <input type="checkbox"/> Auto Surround Mode |
| <input type="checkbox"/> Audio Input Signal | <input type="checkbox"/> Quick Select |
| <input type="checkbox"/> HDMI Information | <input type="checkbox"/> Preset Channel |

GUI Menu Operation



- When a TV is connected to the AVR-4310CI, the GUI menu, sound field parameters, etc., can be displayed on the TV.
- This allows you to operate the AVR-4310CI and make settings on it while looking at the GUI menu displayed on the TV.
- Operate with the main remote control unit switched to the "MAIN" mode (page 89 "Operating the Main Remote Control Unit").

1 Press MENU.

The GUI menu is displayed on the TV screen.

2 Press Δ ∇ \triangleright to select the menu to be set or operated.

※ To return to the previous item, press \triangleleft or RETURN.

3 Press ENTER to enter the setting.

❑ Exiting the GUI Menu

Press **MENU** while the GUI menu is displayed.
The GUI menu display disappears.

Example of the Display of the GUI Mark at a Title

Items for which this mark is indicated at the title can be operated from the GUI.
We recommend performing such operations from the GUI.



Making Detailed Settings (Manual Setup)

This is the GUI icon for this setting item or for the menu series to which this item belongs.

Examples of GUI Menu Screen Displays

Typical examples are described below.

[Example 1] Menu selection screen (Top menu)

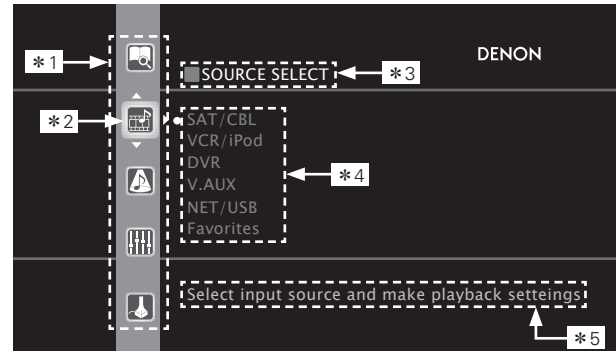

- * 1 : List GUI menu setup icons
- * 2 : Currently selected setup icon
- * 3 : Currently selected setup item
- * 4 : List of currently selected setup items
- * 5 : Guide text for the currently selected setup item

Press ∇ to select "A" and then press \triangleright .
(Or press ENTER.)

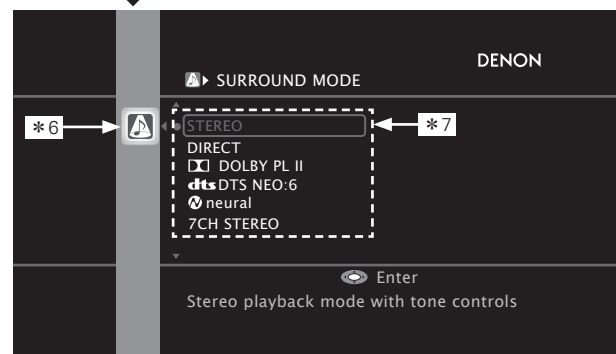

- * 6 : Selected setup icon
- * 7 : Options of the selected setup item

[Example 2] Audyssey Auto Setup screen (with illustration)



- * 8 : History icon
- * 9 : Operation guidance text
- * 10 : Operation step indicators
- * 11 : Illustration
- * 12 : Guide text for the currently selected setup item
- * 13 : Operation button guidance

❑ Icon

Switch the selected item (Use Δ to switch.)



Switch to the next item

Selected item (Use \triangleright or ENTER to switch.)

Switch the selected item (Use ∇ to switch.)

❑ List

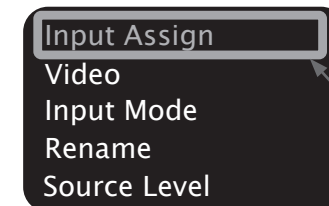

Switch to the next item (Use \triangleright or ENTER to switch.)

Selected item

※ Switch the selected item using Δ ∇ .

Selecting the Input Source

There are three ways to select the input source, as described below.

- ① Selecting the input source using the **Source Select** menu (GUI menu)
- ② Selecting the input source using the **[SOURCE SELECT]** (Main remote control unit)
- ③ Selecting the input source using the **<SOURCE SELECT>** (Main unit)

① Using the Source Select Menu

- The input source can also be selected using the source selection menu.
- Switch the main remote control unit to the "MAIN" or "MACRO" mode when performing this operation (page 89 "Operating the Main Remote Control Unit").
If the main remote control unit is in "ZONE2", "ZONE3" or "ZONE4" mode, the "Source Select" menu will not be displayed when **[SOURCE SELECT]** is pressed.

1 Press **[SOURCE SELECT]**.

Display the "Source Select" menu.

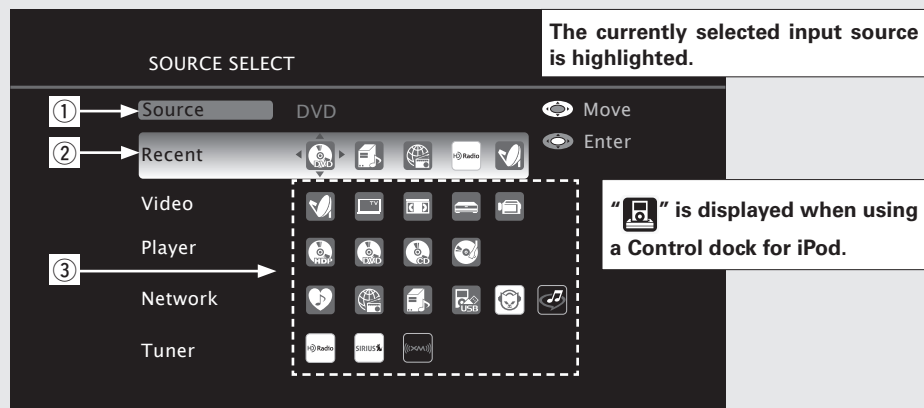

- ① **Input Source** : The name of the highlighted input source is displayed.
- ② **Recently used sources** : The recently used input sources (up to 5) are displayed.
- ③ Icons for the input sources in the different categories are displayed.
 - Video : (SAT/CBL), (TV), (VCR), (DVR), (V.AUX)
 - Player : (HDP), (DVD), (CD), (PHONO)
 - Network: (Favorites), (Internet Radio), (Media Server), (USB/iPod), (Napster), (Rhapsody)
 - Tuner : (XM), (SIRIUS), (HD Radio)

2 Use **△▽◀▶** to select the input source icon, then press **ENTER**.

The input source is set and the source selection menu is turned off.



- Use the device selection buttons on the main remote control unit to set the device to be operated beforehand.
- When using with an iPod connected directly to the AVR-4310CI's USB port, select "USB/iPod" for the input source.
- Input sources that are not going to be used can be set ahead of time. Make this setting at "Source Delete" (page 42).
- To turn off the source selection menu without selecting an input source, press **[SOURCE SELECT]** again.

② Operating on the Main Remote Control Unit

Press **[SOURCE SELECT]**.

The desired input source can be selected directly.

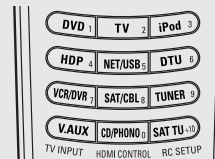

※ To operate the AVR-4310CI using the main remote control unit, set the remote control unit to the MAIN mode (page 89 "Operating the Connected Devices by Remote Control Unit").

※ Pressing the **VCR/DVR** button and the **CD/PHONO** button on the main remote control unit will switch between the following.

VCR/DVR : VCR ↔ DVR
CD/PHONO : CD ↔ PHONO

③ Operating on the Main Unit

Turn **<SOURCE SELECT>**.

※ If "ZONE2/3/ Rec Select", "Video Select" or "Tuning Preset" mode is selected for the input source, press **<SOURCE>** before turning the **<SOURCE SELECT>**.

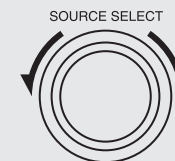



Make the Optimal Speaker Settings, and Correct the Room Acoustics (Audyssey™ Auto Setup)



The acoustic characteristics of the connected speakers and listening room are measured and the optimum settings are made automatically.

Audyssey Auto Setup Flow

1 Connect the Included Setup Microphone
(☞ page 29)



2 Audyssey Auto Setup Preparations
(☞ page 30)

- ☐ **Change the Amplifier Assignment (Amp Assign)**
(☞ page 30)
- ☐ **Set the Channels You will not Use (Channel Skip)**
(☞ page 30)



3 Perform Audyssey Auto Setup (☞ page 30)



Check the Measuring Results and Equalizer Type after Audyssey Auto Setup (Parameter Check) (☞ page 33)

Important information

Audyssey MultEQ® XT automatically measures the acoustical problems in the listening environment to create the best audio experience for your home theater.

- When performing Audyssey Auto Setup, the MultEQ® XT / Dynamic EQ™ / Dynamic Volume™ functions become valid (☞ page 75, 76).
- Use the included setup microphone (DM-A409) to perform Audyssey Auto Setup.
- Measurements are performed by placing the setup microphone successively at multiple positions throughout the entire listening area, as shown in **[Example ①]**. For best results, we recommend you measure in 6 or more positions, as shown in the illustration. Even if the listening environment is small as shown in **[Example ②]**, measuring at multiple points throughout the listening environment results in more effective correction.

When Using the Surround Back Speakers

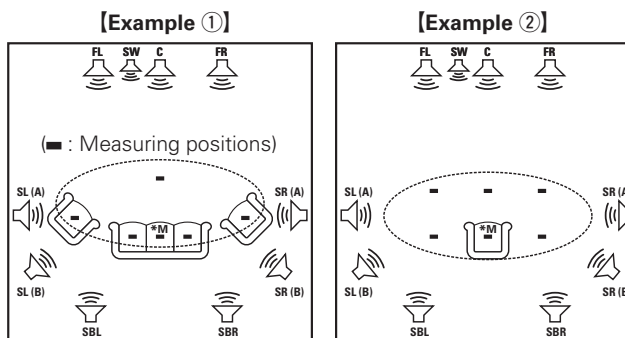

When Using the Front Height Speakers

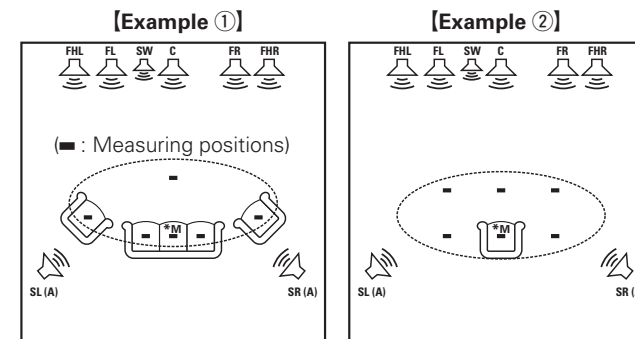

When Using the Front Wide Speakers

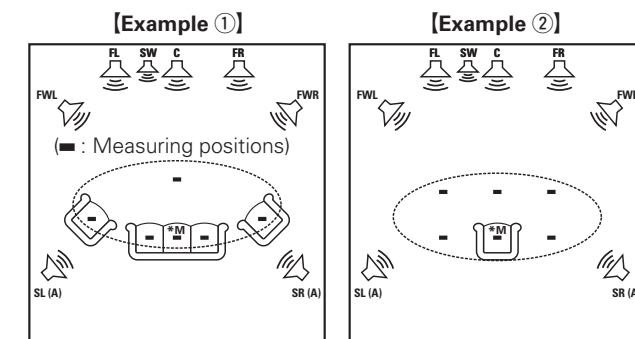

- | | |
|---------------------------------------|--|
| FL : Front speaker (L) | SW : Subwoofer |
| FR : Front speaker (R) | SL (A) : Surround A speaker (L) |
| FHL : Front height speaker (L) | SR (A) : Surround A speaker (R) |
| FHR : Front height speaker (R) | SL (B) : Surround B speaker (L) |
| FWL : Front wide speaker (L) | SR (B) : Surround B speaker (R) |
| FWR : Front wide speaker (R) | SBL : Surround back speaker (L) |
| C : Center speaker | SBR : Surround back speaker (R) |

About the main listening position (*M)

The main listening position refers to the position where listeners would normally sit or where one would normally sit alone within the listening environment.

Audyssey MultEQ XT uses the measurements from this position to calculate speaker distance, level, polarity, and the optimum crossover value for the subwoofer.

Make the Optimal Speaker Settings, and Correct the Room Acoustics (Audyssey™ Auto Setup)

NOTE

- Loud test sounds may be played during Audyssey Auto Setup. This is part of normal operation. If there is background noise in room, these test signals will increase in volume.
- Do not stand between the speakers and setup microphone or allow obstacles in the path while the measurements are being made. This will cause inaccurate readings.
- Make the room as quiet as possible. Background noise can disrupt the room measurements. Close windows, silence cell phones, televisions, radios, air conditioners, fluorescent lights, home appliances, light dimmers, or other devices as measurements may be affected by these sounds. Cell phones should be placed away from all audio electronics during the measurement process as Radio Frequency Interference (RFI) may cause measurement disruptions (even if the cell phone is not in use).
- Operating **MASTER VOLUME** during the measurements will cancel the measurements.

1 Connect the Included Setup Microphone

- Do not remove the setup microphone until Audyssey Auto Setup is completed.
- When using headphones, unplug the headphones before starting Audyssey Auto Setup.

1 Check the speaker connections.

(👉 page 13 "Speaker Connections")

2 Turn on the TV and subwoofer power.

Change the TV input to AVR-4310CI input.

3 Turn on the AVR-4310CI power.

(👉 page 24 "Turning the Power On")

4 Connect the setup microphone to the SETUP MIC jack of the AVR-4310CI.

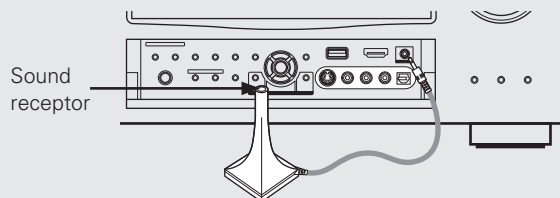

"Audyssey Auto Setup" screen is displayed when you connect the setup microphone.



5 Mount the setup microphone on a tripod or stand and place it in the main listening position.

When placing the setup microphone, adjust the height of the sound receiver part to the level of the listener's ear.

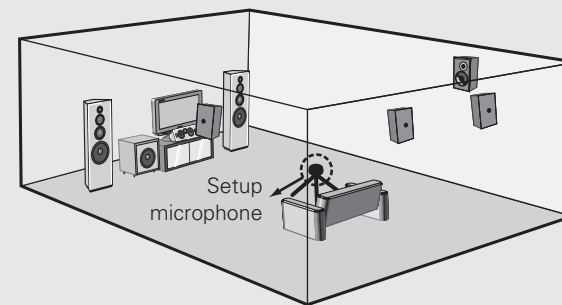

If your subwoofer provides volume and crossover settings, set these as shown below before starting Audyssey Auto Setup.

- Volume setting : "12 o'clock" position" or the middle of the gain knob's range.
- Low path filter setting is "Off", or Crossover Frequency setting is "Maximum/Highest Frequency"
- Phase setting : 0°
- Standby mode setting : "Off"

NOTE

- Do not hold the microphone in your hand during measurements.
- Avoid placing the microphone close to a seat back or wall as sound reflections may give inaccurate results.

2 Audyssey Auto Setup Preparations

 around items indicate the settings.

STEP1 Preparation

Perform the following settings if adjustments, etc., are required for the speaker environment you're using. If you do not need to perform the following settings, or have already completed them, select "Auto Setup Start" and then press **ENTER**. Proceed to "[STEP2]".

Change the Amplifier Assignment (Amp Assign)

The signal output from the SURR.BACK/AMP ASSIGN speaker terminal of the AVR-4310CI can be switched to match your speaker environment (page 34 "Amp Assign").

1 Select "Amp Assign" and then press **ENTER**.



2 Press Δ / ∇ to select an item, and then press **ENTER**.

- Normal** : Outputs surround back channel audio.
- ZONE2** : Outputs ZONE2 audio.
- ZONE3** : Outputs ZONE3 audio.
- ZONE (MONO)** : Outputs ZONE2 / ZONE3 monaural audio.
- Bi-Amp** : Outputs front channel audio for bi-amp use.
- 2CH** : Outputs front channel audio during 2-channel DIRECT and STEREO mode.
- Front Height** : Outputs front height channel audio.
- Front Wide** : Outputs front wide channel audio.

※ To cancel, press **RETURN**.



- When you are using surround back speakers with ZONE2/ZONE3, set to "ZONE2" or "ZONE3".
- You can set in the same way as described in "Amp Assign" on page 34.

NOTE

Since "Amp Assign" of AVR-4310CI is set to "ZONE2" by default, audio is not output from the surround back speakers. When using the surround back speakers with MAIN ZONE, change the "Amp Assign" setting to "Normal".

Set the Channels You will not Use (Channel Skip)

If you set the channels you will not use beforehand, those channels will not be measured. Therefore, you can save an amount of time commensurate with that which would have been taken to measure those channels.

1 Select "Channel Skip" and then press **ENTER**.

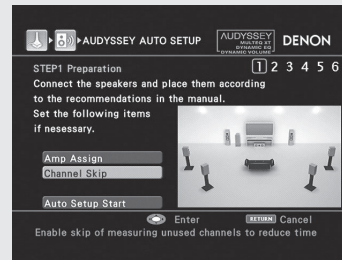

2 Press Δ / ∇ to select a channel, press \triangleleft / \triangleright to select the item, and then press **ENTER**.

Configurable channels

- Subwoofer** : Set the subwoofer channel.
- Surround B** : Set the surround B channel.
- Surround Back** : Set the surround back channel.

Settings

- Measure** : Default setting. Measure the selected channel.
- Skip** : Skip the selected channel and do not measure.

※ To cancel, press **RETURN**.



When "Amp Assign" is set to "Normal", only then is "Surround Back" displayed.

3 Perform Audyssey Auto Setup

- Audyssey Auto Setup detects the presence of each speaker and automatically calculates the speaker size, channel level, distance and crossover frequency settings. In addition, acoustical distortions are corrected within the listening area.
- When measuring begins, a test tone is output from each speaker.
- Position and connect all speakers before commencing Audyssey Auto Setup.

STEP2 Speaker Detection

1 Select "Measure" and then press **ENTER**.



① Measure the subwoofer level

※ To stop measuring, select "Cancel" and then press **ENTER**.

※ When "Subwoofer" is set to "Skip" with "Channel Skip", this measurement is not taken, and the process proceeds to "② Measure each speaker".

② Measure each speaker

※ Once the measurements in step ① are complete, the measurements in step ② start automatically.
 ※ The measuring channel changes depending on the setting of "Amp Assign" (page 30) and "Channel Skip" (page 30).

When an error message is displayed, check "Error Messages" for details (page 32).

③ Check the speaker detection results

When measuring ends, the speaker detection results are displayed.
 ※ Select "Next → Measurement" and press **ENTER** to proceed to "[STEP3]".
 ※ Press Δ to select "Retry", and when you press **ENTER**, measuring at the main listening position starts again.

See overleaf 

Main remote control operation buttons



:Displaying the menu
Cancel the menu



:Moves the cursor
(Up/Down/Left/Right)



:Confirm the setting



:Return to previous menu

STEP3 Measurement

2 Move the setup microphone to position 2, select “Measure”, and then press ENTER.

The measurement of the 2nd position starts.

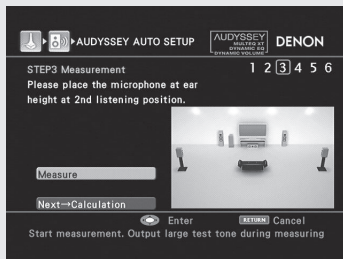

※ To skip this step, select “Next → Calculation” and proceed to [STEP4].

3 Repeat step 2, measuring positions 3 ~ 8.

When measurement of position 8 is completed, a “Measurements finished.” message is displayed.

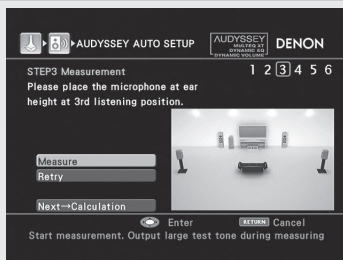

※ To skip this step, select “Next → Calculation” and proceed to [STEP4].

※ Measure in at least 6 positions in and around the main listening position. Even though you can complete measurement with at least 6 positions, it is advisable to use more than 6 (a maximum of 8 positions).

STEP4 Calculation

4 On the [STEP3] screen, select “Next → Calculation”, and then press ENTER.

Measuring results are analyzed, and the frequency response of each speaker in the listening room is determined.

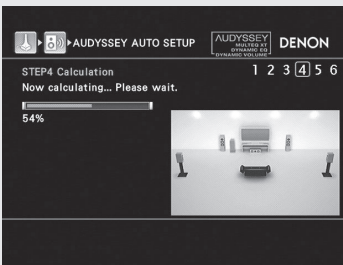

※ Analysis takes several minutes to complete. The time required for this analysis depends on the number of speakers connected. The more connected speakers there are, the longer it takes to perform analysis.

STEP5 Check

5 On the [STEP5] screen, press Δ / ∇ to select the item you want to check, and then press ENTER.

Speaker Config. Check

Distance Check

Channel Level Check

Crossover Freq. Check

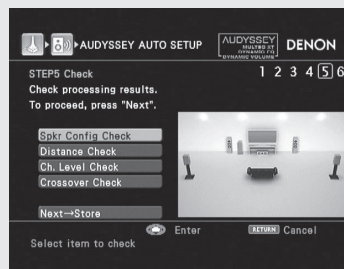

※ Subwoofers may measure a greater reported distance than the actual distance due to added electrical delay common in subwoofers.

6 Press Δ / ∇ to select the channel you want to check. The measurement result of each speaker is displayed.

※ If you want to check another item, press RETURN.

※ Select “Next → Store” and press ENTER to proceed to “[STEP6]”.

STEP6 Store

7 Select “Store” and then press ENTER.

Save the measuring results.

※ The save operation takes about 30 seconds to complete.

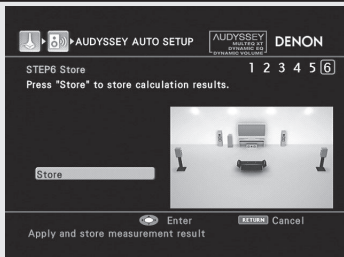

NOTE

During saving of measuring results, be sure not to turn off the power.

8 When the screen shown on the right appears, unplug the setup microphone from the AVR-4310CI SETUP MIC jack.



9 Select “Exit” and then press ENTER.

Exiting the GUI Menu

Press MENU while the GUI menu is displayed. The GUI menu display disappears.

NOTE

After performing Audyssey Auto Setup, do not change the speaker connections or subwoofer volume. In event of a change, perform Audyssey Auto Setup again.



• If there is a disparity between the results and the connection status, or if an error message is displayed, check the error message against the errors listed in the “Error Messages” section (page 32) and perform Audyssey Auto Setup again.

• If the result still differs from the actual connection status after remeasurement or the error message still appears, it is possible that the speakers are not connected properly. Turn the AVR-4310CI off, check the speaker connections and repeat the measurement process from the beginning. Turn the AVR-4310CI off, check the speaker connections and repeat the measurement process from the beginning.

• If you change a speaker position or orientation, perform Audyssey Auto Setup again to obtain optimal equalizer correction.



Error Messages

An error message is displayed if it was not possible to complete Audyssey Auto Setup due to speaker placement, the measurement environment, etc. If this happens, check the relevant items, be sure to take the necessary measures, then perform Audyssey Auto Setup over again.

NOTE

Be sure to turn off the power before checking speaker connections.

❑ When Performing Audyssey Auto Setup Over Again

Press $\Delta \nabla$ to select "Retry", and then press **ENTER**.

❑ When Measuring has Stopped

Press **RETURN**, the "Cancel auto setup?" prompt is displayed.

Press $\triangleleft \triangleright$ and select "Yes", then press **ENTER**.

Error messages (examples)	Error contents	Measures
	<ul style="list-style-type: none"> Correct measurement is not possible due to inappropriate subwoofer volume. 	<ul style="list-style-type: none"> When using a subwoofer with built-in amplifier (active type), use "SW Level Matching" to adjust the subwoofer volume (page 33). When using a subwoofer without a built-in amplifier, select "Skip", and then press ENTER.
	<ul style="list-style-type: none"> Included setup microphone is not connected. Not all speakers could be detected. The front L speaker was not properly detected. 	<ul style="list-style-type: none"> Connect the included setup microphone to the SETUP MIC jack of the AVR-4310CI. Check the speaker connections.
	<ul style="list-style-type: none"> Too much noise in the room for accurate measurements to be made. Speaker or subwoofer sound is too low for accurate measurements to be made. 	<ul style="list-style-type: none"> Either turn off any device generating noise or move it away. Perform again when the surroundings are quieter. Check the speaker installation and the direction in which the speakers are facing. Adjust the subwoofer's volume.
	<ul style="list-style-type: none"> Displayed speaker could not be detected. 	<ul style="list-style-type: none"> Check the connections of the displayed speaker.
	<ul style="list-style-type: none"> Displayed speaker connected with the polarities reversed. 	<ul style="list-style-type: none"> Check the polarities of the displayed speaker. For some speakers, this error message may be displayed even if the speaker is properly connected. If you are sure the connection is correct, press $\Delta \nabla$ to select "Skip", then press ENTER.



Subwoofer Level Error Message and How to Adjust

The optimal level of the subwoofer channel is 75 dB. During subwoofer level measurement ("3: Perform Audyssey Auto Setup, 1 - ① [STEP2] : Speaker Detection" (page 30)), an error message is displayed when the subwoofer level is outside the 72 ~ 78 dB range. When using a subwoofer with built-in amplifier (active type), adjust the subwoofer volume so that the subwoofer level is within the 72 ~ 78 dB range.

1 Select "SW Level Matching" and then press ENTER.

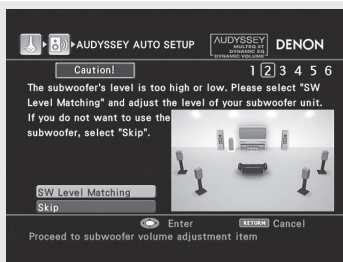

2 Select "SW Test Start" and then press ENTER.

Subwoofer level measurement begins. During measuring, a "Testing ..." message is displayed. The measured level appears on the level indicator after about 3 ~ 5 seconds.

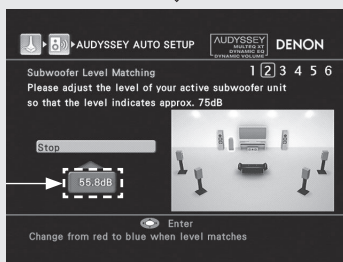
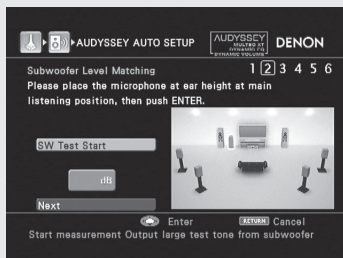

- ※ If the measured level is outside the 72 ~ 78 dB range, the level indicator is red.
- ※ When measuring stops, press **ENTER**.

3 Adjust the volume control on your subwoofer so that the measured level is within the 72 ~ 78 dB range.

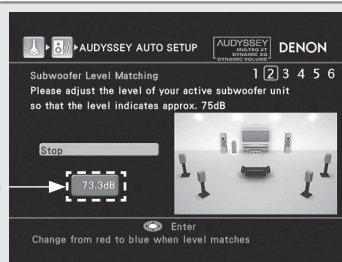

※ If the measured level is within the 72 ~ 78 dB range, the level indicator is blue.

4 When the measured level is within the 72 ~ 78 dB range, press ENTER.

5 Select "Next" and then press ENTER.

Proceed to "3: Perform Audyssey Auto Setup, 1 - ② [STEP2] : Speaker Detection" (page 30).

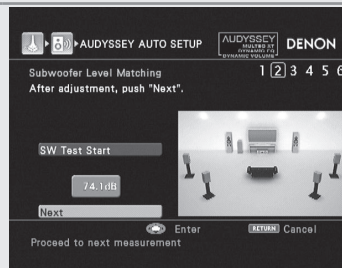

Check the Measuring Results and Equalizer Type after Audyssey Auto Setup (Parameter Check)

This is displayed after Audyssey Auto Setup is completed.

1 Press ∇ to select "Parameter Check", and then press ENTER or \triangleright .

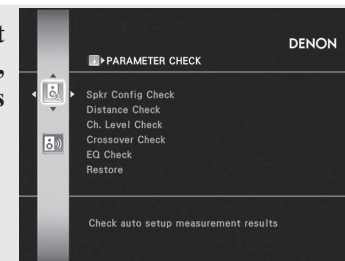

2 Press $\Delta \nabla$ to select the item you want to check, and then press ENTER or \triangleright .

- Speaker Config. Check
- Distance Check
- Channel Level Check
- Crossover Freq. Check
- EQ Check

3 Press $\Delta \nabla$ to select the channel you want to check.

The measurement result of each speaker is displayed.

- ※ When you selected "EQ Check" in step 2, press $\Delta \nabla$ to select the Correction curve you want to check ("Audyssey" or "Audyssey Flat").
- ※ When you want to check another item, press **RETURN**. Pressing **RETURN** returns you to step 2; from there, proceed to steps 2 and 3.



If you set "Restore" to "Yes", you can return to Audyssey Auto Setup measurement result (value calculated at the start by MultEQ XT) even when you have changed each setting manually.





Making Detailed Settings (Manual Setup)

GUI

For details on how to select, set and cancel settings for each menu, see "GUI Menu Operation" (page 26).

Items that can be set with the Manual Setup procedure



Making the speaker settings (Speaker Setup) page 34



Making the HDMI settings (HDMI Setup) page 37



Making the audio settings (Audio Setup) page 38



Making the network settings (Network Setup) page 39



Making the Multi-zone settings (Zone Setup) page 41



Making other settings (Option Setup) page 42



Making language settings (Language) page 45



Making the Speaker Settings (Speaker Setup)

GUI

Default settings are underlined.

Perform when setting the speakers manually or when changing settings made in Audyssey Auto Setup.

Setting items	Setting contents
Amp Assign Sets the signal output to the speaker connected to the SURR. BACK/AMP ASSIGN terminals.	Normal : Outputs surround back channel audio. <u>ZONE2</u> : Outputs ZONE2 audio. ZONE3 : Outputs ZONE3 audio. ZONE (MONO) : Outputs ZONE2 / ZONE3 monaural audio. Bi-Amp : Outputs front channel audio for bi-amp use. 2CH : Outputs front channel audio during 2-channel DIRECT and STEREO mode. Front Height : Outputs front height channel audio. Front Wide : Outputs front wide channel audio. Since "Amp Assign" of AVR-4310CI is set to "ZONE2" by default, audio is not output from the surround back speakers. When using the surround back speakers with MAIN ZONE, change the "Amp Assign" setting to "Normal".
Speaker Configuration Select speaker configuration and size (bass reproduction capability). NOTE Select "Large" or "Small" not according to the physical size of the speaker but according to the low frequency reproduction capabilities based on the frequency set at "Crossover Frequency" (page 36).	Front : Set the front speaker size. <ul style="list-style-type: none"> • Large : Use of a large speaker that can adequately playback low frequencies. • Small : Use of a small speaker that has inadequate playback capacity for low frequencies. <ul style="list-style-type: none"> • When "Subwoofer" is set to "No", "Front" can automatically set to "Large". • When "Front" is set to "Small", "Center", "Surround A", "Surround B", "Surround Back", "Front Height" and "Front Wide" can not be set to "Large". <hr/> Center : Set the presence and size of the center speaker. <ul style="list-style-type: none"> • Large : Use of a large speaker that can adequately playback low frequencies. • Small : Use of a small speaker that has inadequate playback capacity for low frequencies. • None : Select when a center speaker is not connected. "Large" is not displayed when "Front" is set to "Small".
	Subwoofer : Set the presence of a subwoofer. <ul style="list-style-type: none"> • Yes : Use a subwoofer. • No : Select when a subwoofer is not connected. When "Front" is set to "Small", "Subwoofer" can automatically set to "Yes".

See overleaf

Main remote control operation buttons



SEARCH :Displaying the menu
MENU :Cancel the menu



:Moves the cursor (Up/Down/Left/Right)









:Confirm the setting



:Return to previous menu



Making Detailed Settings (Manual Setup)



Setting items	Setting contents
Speaker Configuration (Continued)	<p>Surround A : Set the presence and size of the surround speakers A.</p> <ul style="list-style-type: none"> • Large : Use of a large speaker that can adequately playback low frequencies. • Small : Use of a small speaker that has inadequate playback capacity for low frequencies. • None : Select when the surround speakers A are not connected. <p></p> <ul style="list-style-type: none"> • When "Surround A" or "Surround B" is set to "Large", "Surround Back", "Front Height" and "Front Wide" can be set to "Large". • When "Surround A" is set to "None", "Surround B", "Surround Back", "Front Height" and "Front Wide" can automatically set to "None". <p>Surround B : Set the presence and size of the surround speakers B.</p> <ul style="list-style-type: none"> • Large : Use of a large speaker that can adequately playback low frequencies. • Small : Use of a small speaker that has inadequate playback capacity for low frequencies. • None : Select when the surround speakers B are not connected. <p></p> <p>When "Surround A" or "Surround B" is set to "Large", "Surround Back", "Front Height" and "Front Wide" can be set to "Large".</p> <p>Surround Back : Set the presence, size and number of surround back speakers.</p> <ul style="list-style-type: none"> • Large : Use of a large speaker that can adequately playback low frequencies. • Small : Use of a small speaker that has inadequate playback capacity for low frequencies. • None : Select when the surround back speakers are not connected. • 2spkrs : Use two surround back speakers. • 1spkr : Use only one surround back speaker. When you select this setting, connect the surround back speaker to the left (L) channel. <p></p> <ul style="list-style-type: none"> • When the "Amp Assign" setting (page 34) is other than "Normal", you cannot make the "Surround Back" setting. • Even when the Surround Back Speaker setting is other than "None", sound may not be emitted from the surround back speaker, depending on the playback source. In this case, "Surround Parameters" – "Surround Back" setting other than "OFF" (page 74).

Setting items	Setting contents
Speaker Configuration (Continued)	<p>Front Height : Set the presence and size of the front height speakers.</p> <ul style="list-style-type: none"> • Large : Use of a large speaker that can adequately playback low frequencies. • Small : Use of a small speaker that has inadequate playback capacity for low frequencies. • None : Select when the front height speakers are not connected. <p></p> <p>When the "Amp Assign" setting (page 34) is other than "Front Height", you cannot make the "Front Height" setting.</p> <p>Front Wide : Set the presence and size of the front wide speakers.</p> <ul style="list-style-type: none"> • Large : Use of a large speaker that can adequately playback low frequencies. • Small : Use of a small speaker that has inadequate playback capacity for low frequencies. • None : Select when the front wide speakers are not connected. <p></p> <p>When the "Amp Assign" setting (page 34) is other than "Front Wide", you cannot make the "Front Wide" setting.</p>
Bass Setting Settings for subwoofer and LFE signal range playback.	<p>Subwoofer Mode : Select low range signals to be reproduced by subwoofer.</p> <ul style="list-style-type: none"> • LFE : The low range signal of the channel set to "Small" speaker size is added to the LFE signal output from the subwoofer. • LFE+Main : The low range signal of all channels is added to the LFE signal output from the subwoofer. <p></p> <ul style="list-style-type: none"> • This can be set when "Speaker Configuration" – "Subwoofer" (page 34) is set to "Yes". • Play music or a movie source and select the mode offering the strongest bass. • Select "LFE+Main" if you want the bass signals to always be produced from the subwoofer. <p>LPF for LFE : Set LFE signal playback range.</p> <p>• 80Hz / 90Hz / 100Hz / 110Hz / 120Hz / 150Hz / 200Hz / 250Hz</p>
Distance Set distance from listening position to speakers. Measure beforehand the distance from the listening position to each speaker.	<p>Feet / Meters : Set the unit of distance.</p> <p>Step : Set the minimum variable width of the distance.</p> <ul style="list-style-type: none"> • 1ft / 0.1ft • 0.1m / 0.01m <p>Default : Reset all distance settings to factory default.</p> <ul style="list-style-type: none"> • Yes : Reset to the defaults. • No : Do not reset to the defaults. <p></p> <p>When you select "Default" and press ENTER, the "Return all settings to the default?" prompt is displayed. Select either "Yes" or "No", and press ENTER.</p>

See overleaf



Setting items	Setting contents
Distance (Continued)	<p>Front L / Front R / Center / Subwoofer / Surround A L / Surround A R / Surround B L / Surround B R / Surr. Back L* / Surr. Back R* / Front Height L / Front Height R / Front Wide L / Front Wide R : Select the speaker.</p> <p>*: When the "Speaker Configuration" – "Surround Back" setting (🔍 page 35) is set to "1spkr", "Surr. Back" is displayed.</p> <p>• 0.0ft ~ 60.0ft / 0.00m ~ 18.00m : Set the distance.</p> <p></p> <ul style="list-style-type: none"> • Speakers set to "None" in "Speaker Configuration" (🔍 page 34) are not displayed. • The speakers that can be selected differ depending on the "Amp Assign" (🔍 page 34) and "Speaker Configuration" (🔍 page 34) settings. • Default settings : Front / Center / Subwoofer / Front Height / Front Wide : 12.0 ft (3.60 m) Surround A / Surround B / Surround Back : 10.0 ft (3.00 m) • Set the difference in the distance between the speakers to less than 20 feet (6.0 meters).
Channel Level Set the volume of the test tone to be the same when it is output from each speaker.	<p>Surround Speaker : Set the surround speakers to output the test tone.</p> <ul style="list-style-type: none"> • A : Output test tone from surround speakers A. • B : Output test tone from surround speakers B. • A+B : Output test tone from surround speakers A and B. <p> Can be set when the "Speaker Configuration" – "Surround A" or "Surround B" setting is "Large" or "Small" (🔍 page 35).</p> <p>Test Tone : Output test tone.</p> <ul style="list-style-type: none"> • Front L / Front Height L / Center / Front Height R / Front R / Front Wide R / Surround R / Surr. Back R* / Surr. Back L* / Surround L / Front Wide L / Subwoofer : Select the speaker. <p>* : When the "Speaker Configuration" – "Surround Back" setting (🔍 page 35) is set to "1spkr", "Surr. Back" is displayed.</p> <p>• -12dB ~ +12dB (0dB) : Adjust the volume.</p> <p></p> <ul style="list-style-type: none"> • Speakers set to "None" in the "Speaker Configuration" (🔍 page 34) settings are not displayed. • When ◀ is pressed while the subwoofer volume is set to "-12 dB", the "Subwoofer" setting switches to "OFF". • When using surround speakers, be sure to adjust the volume of the different speakers. • When a headphones jack is inserted in the PHONES terminal of the AVR-4310CI, the "Channel Level" is not displayed. • You can also press CHANNEL LEVEL to set (🔍 page 81 "Adjust the Volume of the Different Speakers"). <p>Default : Reset all channel level settings to factory default.</p> <ul style="list-style-type: none"> • Yes : Reset to the defaults. • No : Do not reset to the defaults.

Setting items	Setting contents
Crossover Frequency Outputs at below set frequency, each speaker's bass signal output from the subwoofer. Set this according to the low frequency reproduction capabilities of the speakers you are using.	<p>40Hz / 60Hz / 80Hz / 90Hz / 100Hz / 110Hz / 120Hz / 150Hz / 200Hz / 250Hz : Set the crossover frequency.</p> <p>Advanced : Specify crossover frequency for each speaker.</p> <ul style="list-style-type: none"> • Front / Center / Surround A / Surround B / Surround A+B / Surround Back / Front Height / Front Wide : Select the speaker. • 40Hz / 60Hz / 80Hz / 90Hz / 100Hz / 110Hz / 120Hz / 150Hz / 200Hz / 250Hz : Set the crossover frequency. <p></p> <ul style="list-style-type: none"> • Can be set when the "Speaker Configuration" – "Subwoofer" (🔍 page 34) setting is "Yes", or when you have a speaker that is set to "Small". • Always set the crossover frequency to "80Hz". When using small speakers, however, we recommend setting the crossover frequency to a higher frequency. • For speakers set to "Small", sound below the crossover frequency is cut from the sound output. The cut bass sound is output from the subwoofer or front speakers. • The speakers that can be set when "Advanced" is selected differ according to the "Subwoofer Mode" setting (🔍 page 35). <ul style="list-style-type: none"> • When "LFE" is selected, speakers set to "Small" at "Speaker Configuration" can be set. If the speakers are set to "Large", "Full Band" is displayed and the setting cannot be made. • If set to "LFE+Main", this setting can be made regardless of the speaker size.
Surround Speaker Set the surround speakers to use for every surround mode.	<p>DOLBY/DTS Cinema : Set the surround speakers to use during Dolby/DTS Cinema mode.</p> <p>DOLBY/DTS Music : Set the surround speakers to use during Dolby/DTS Music mode.</p> <p>DOLBY Game : Set the surround speakers to use during Dolby Game mode.</p> <p>DOLBY Height : Set the surround speakers to use during Dolby Height mode.</p> <p>WIDE SCREEN : Set the surround speakers to use during WIDE SCREEN mode.</p> <p>7CH STEREO : Set the surround speakers to use during 7CH STEREO mode.</p> <p>DSP SIMULATION : Set the surround speakers to use during the DENON original surround mode.</p> <p>MULTI CH MODE : Set the surround speakers to use during PCM or DSD multi-channel mode.</p> <ul style="list-style-type: none"> • A : Use surround speakers A. • B : Use surround speakers B. • A+B : Use surround speakers A and B. <p> "Surround Speaker" is displayed when "Speaker Configuration" – "Surround A" and "Surround B" setting (🔍 page 35) is set to "Large" or "Small".</p>

See overleaf



Making Detailed Settings (Manual Setup)

Setting items	Setting contents
Surround Speaker (Continued)	 <ul style="list-style-type: none"> When using the PRE OUT terminal, set to "A" or "B". Make the surround speaker settings when the input mode is set to "EXT. IN" at "EXT. IN Setup" (page 38). When the "Speaker Configuration" – "Surround A" or "Surround B" setting (page 35) is "Small", and using surround speakers A and B simultaneously, playback is with the same output as when "Surround A" and "Surround B" are set to "Small".













Making the HDMI Settings (HDMI Setup)



Default settings are underlined.

Make settings for HDMI video/audio output.

Setting items	Setting contents
RGB Range Set the video range of RGB output from the HDMI terminal.	<p>Normal : Output with RGB video range (16 (black) to 235 (white)).</p> <p>Enhanced : Output with RGB video range (0 (black) to 255 (white)).</p>  This setting is valid when using a TV equipped with a DVI terminal.
Vertical Stretch Expand image signal in vertical direction.	<p>ON : Expand image signal in vertical direction.</p> <p>OFF : Do not expand signal in vertical direction.</p>  This setting is valid with respect to the HDMI output when using an HDMI-compatible TV. When not using an HDMI-compatible TV, it is valid with respect to the analog output.
Auto Lip Sync Automatic compensation for timing shift in audio and video output.	<p>ON : Compensated.</p> <p>OFF : Not compensated.</p>
HDMI Audio Out Select HDMI audio output device.	<p>Amp : Playback through speakers connected to the receiver.</p> <p>TV : Playback through TV connected to the receiver.</p>  When the HDMI control function is operating, the setting of audio playback in the connected TV takes priority (page 80 "HDMI Control Function").
Monitor Out Make settings for HDMI monitor output.	<p>Auto (Dual) : The presence of a TV connected to the MONITOR 1 or MONITOR 2 terminal is detected automatically, and that TV connection is used.</p> <p>Monitor 1 : A TV connected to the MONITOR 1 terminal is always used.</p> <p>Monitor 2 : A TV connected to the MONITOR 2 terminal is always used.</p>

Setting items	Setting contents
Monitor Out (Continued)	 <ul style="list-style-type: none"> If both the Monitor 1 and 2 connectors are connected and "Resolution" (page 49) is set to "Auto", the signals are output with a resolution compatible with both TV. With "Resolution" (page 49) not set to "Auto", check whether the TV you are using is compatible with the resolution under "HDMI Information" – "Monitor 1" and "Monitor 2" (page 78). Depending on the monitor you have connected, the display may not be correct when you set to "Auto (Dual)". In such a case, set to either "Monitor 1" or "Monitor 2". You can also set "Monitor Out" by pressing [M.SEL].
HDMI Control External devices can be controlled from the AVR-4310CI and the AVR-4310CI can be controlled from external devices.	<p>Control</p> <ul style="list-style-type: none"> ON : Use HDMI control function OFF : Do not use HDMI control function  When a device that is not compatible with the HDMI control function is connected, set "Control" to "OFF".
	<p>NOTE</p> <ul style="list-style-type: none"> Please consult the operating instructions for each connected device to check the settings. Refer to "HDMI Control Function" (page 80) for more information about the HDMI control function. When the "Control" setting has been changed, always turn off the power to the connecting devices afterwards and then turn back on.
NOTE	<p>The HDMI control function controls operations of a TV that is compatible with the HDMI control function. Make sure that the TV and HDMI are connected when you perform HDMI control.</p>
	<p>NOTE</p> <ul style="list-style-type: none"> When "Control" is set to "ON", it consumes more standby power. When not using this unit for a long period, we recommend that you press <POWER> on the main unit to turn off the power. "HDMI Control" does not work when the power to the equipment is off. Either power on or set to standby.
Standby Source : Set the HDMI connector for HDMI signal input during standby.	<ul style="list-style-type: none"> Last : Standby with last used input source during power on. HDMI1 / HDMI2 / HDMI3 / HDMI4 / HDMI5 / HDMI6 : The standby mode is set at the input source assigned to the respective.  This can be set when "Control" is set to "ON".
Control Monitor : Set the HDMI MONITOR terminal to output the HDMI control signal.	<ul style="list-style-type: none"> Monitor 1 : Output from the MONITOR 1 terminal. Monitor 2 : Output from the MONITOR 2 terminal.  This can be set when "Control" is set to "ON".
Power Off Control : The power of the AVR-4310CI and external device turn off together.	<ul style="list-style-type: none"> ON : Interlock. OFF : Do not interlock.  This can be set when "Control" is set to "ON".

See overleaf





Making the Audio Settings (Audio Setup)

GUI

Default settings are underlined.

Make settings for audio playback.

Setting items	Setting contents
EXT. IN Setup Setup playback method for analog signals inputted from external input connectors (EXT. IN).	<p>Surround Speaker : Set the surround speakers to use during playback in EXT. IN mode.</p> <ul style="list-style-type: none"> • A : Use surround speakers A. • B : Use surround speakers B. • A+B : Use surround speakers A and B. <p> Can be set when the "Speaker Configuration" – "Surround A" or "Surround B" setting (page 35) is "Large" or "Small".</p> <p>Subwoofer Level : Set playback level of subwoofer signal input from the external input connector (EXT. IN).</p> <ul style="list-style-type: none"> • +15dB : This is the recommended level. • +10dB / +5dB / 0dB : Select the level according to the player being used.
2ch Direct/Stereo Make speaker settings for 2-channel mode playback.	<p>Setting : Select the method for setting the speakers used in the 2-channel direct and stereo playback modes.</p> <ul style="list-style-type: none"> • Basic : The settings at "Speaker Setup" (page 34) are applied. • Custom : Make separate settings for 2-channel. <p>Front : Set the front speaker size.</p> <ul style="list-style-type: none"> • Large : Use of a large speaker that can adequately playback low frequencies. • Small : Use of a small speaker that has inadequate playback capacity for low frequencies. <p> If "Speaker Configuration" – "Subwoofer" (page 34) is set to "No", the setting is automatically set to "Large".</p> <p>Subwoofer : Set the presence of a subwoofer.</p> <ul style="list-style-type: none"> • Yes : Use a subwoofer. • No : Select when a subwoofer is not connected. <p> If "Speaker Configuration" – "Subwoofer" (page 34) is set to "No", the setting is automatically set to "No". If the "Front" setting is "Small", the setting is automatically "Yes".</p>

Setting items	Setting contents
2ch Direct/Stereo (Continued)	<p>SW Mode : Select low range signal to be reproduced by subwoofer.</p> <ul style="list-style-type: none"> • LFE : When the "2ch Direct/Stereo" – "Front" setting is set to "Large", the LFE signal alone is output from the subwoofer. Also, when the "2ch Direct/Stereo" – "Front" setting is set to "Small", the front channel low range signal is added to the LFE signal output from the subwoofer. • LFE+Main : The front channel low range signal is added to the LFE signal output from the subwoofer. <p> This can be set when "2ch Direct/Stereo" – "Subwoofer" is set to "Yes".</p> <p>Crossover : Outputs at below set frequency, each speaker's bass signal output from the subwoofer.</p> <ul style="list-style-type: none"> • 40Hz / 60Hz / 80Hz / 90Hz / 100Hz / 110Hz / 120Hz / 150Hz / 200Hz / 250Hz <p></p> <ul style="list-style-type: none"> • This can be set when "2ch Direct/Stereo" – "Subwoofer" is set to "Yes". • If the "2ch Direct/Stereo" – "Front" setting is "Large" and the "SW Mode" setting is "LFE", "Full Band" is displayed and the setting cannot be made. <p>Distance FL / Distance FR : Select the speaker.</p> <ul style="list-style-type: none"> • 0.0ft ~ 60.0ft (12.0ft) / 0.00m ~ 18.00m (3.60m) : Set the distance to the speaker. <p> Set so that the difference between the front left speaker and front right speaker distances is 6.0 m (20.0 ft) or less.</p> <p>Level FL / Level FR : Select the speaker.</p> <ul style="list-style-type: none"> • -12.0dB ~ +12.0dB (0.0dB) : Adjust the level of each channel.
Auto Surround Mode Make setting for memorizing surround mode setting for each input signal type.	<p>ON : Memorize settings. Automatically play with the last used surround mode.</p> <p>OFF : Do not memorize settings. Surround mode does not change according to input signal</p> <p></p> <ul style="list-style-type: none"> • The auto surround mode function lets you store in the memory the surround mode last used for playing the four types of input signals listed below. <ol style="list-style-type: none"> ① Analog and PCM 2-channel signals ② Dolby Digital and DTS 2-channel signals ③ Dolby Digital and DTS multi-channel signals ④ Multi-channel signals other than Dolby Digital and DTS (PCM, DSD, etc.) • When playing in the PURE DIRECT, the surround mode does not change even if the input signal is changed.

See overleaf



Main remote control
operation buttonsSEARCH
:Displaying the menu
Cancel the menu:Moves the cursor
(Up/Down/Left/Right)

:Confirm the setting



:Return to previous menu

Making Detailed Settings (Manual Setup)

Setting items	Setting contents
EQ Customize Set so that unused equalizer settings are not displayed when [MULTEQ XT] is pressed.	Audyssey Byp. L/R : Set when not using "Audyssey Byp L/R" equalizer. <ul style="list-style-type: none"> • Used : Use. • Not Used : Do not use.  Set so that "Audyssey Byp. L/R" settings can be made when Audyssey Auto Setup is performed.
 Equalizer settings for which "Not Used" is set with the Quick Select function cannot be stored and called out.	Audyssey Flat : Set when not using "Audyssey Flat" equalizer. <ul style="list-style-type: none"> • Used : Use. • Not Used : Do not use.  Set so that "Audyssey Flat" settings can be made when Audyssey Auto Setup is performed.
	Manual : Set when not using the "Manual" equalizer. <ul style="list-style-type: none"> • Used : Use. • Not Used : Do not use.





Making the Network Settings (Network Setup)



Default settings are underlined.

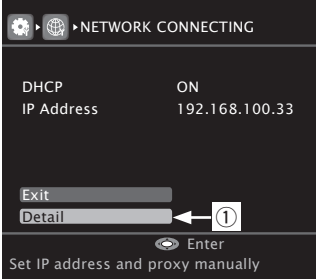
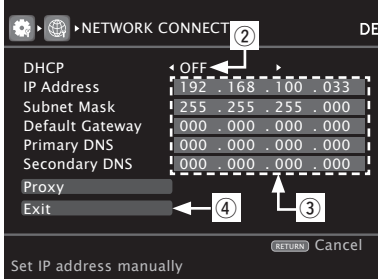

Make network settings.



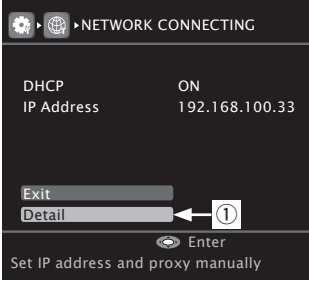
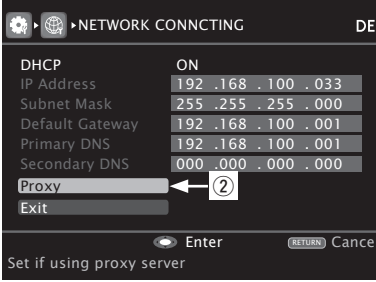
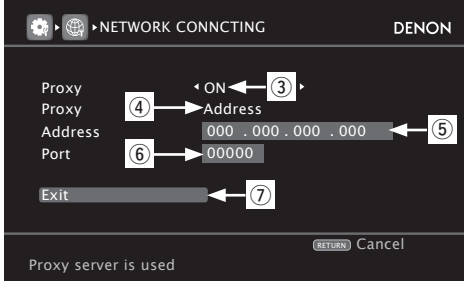

Setting items	Setting contents
Network Connecting Make settings for wired LAN.	<ol style="list-style-type: none"> 1. Connect the LAN cable (☞ page 23 "Connecting to a Home Network (LAN)"). 2. Turn on the AVR-4310CI (☞ page 24 "Turning the Power On"). AVR-4310CI performs automatic network setup due to the DHCP function. When connecting to a network that has no DHCP function, perform the setting in step 3. 3. Set the IP address at the "Network Connecting".
 <p> NETWORK CONNECTING DHCP: ON IP Address: 192.168.100.33 Exit Detail ← ① Enter Set IP address and proxy manually </p>	 <p> NETWORK CONNECT ② DE DHCP: OFF ← ② IP Address: 192.168.100.033 Subnet Mask: 255.255.255.000 Default Gateway: 000.000.000.000 Primary DNS: 000.000.000.000 Secondary DNS: 000.000.000.000 Proxy Exit ← ④ ③ (RETURN) Cancel Set IP address manually </p>

Setting items	Setting contents
Network Connecting Make settings for wired LAN.	<ol style="list-style-type: none"> ① On the GUI menu, select "Network Connecting" – "Detail" and press ENTER. ② Use ◀▶ to set "DHCP" to "OFF", then press ▽. The DHCP function is disabled. ③ Use ▲▼▶ to input the address and press ENTER. <ul style="list-style-type: none"> • IP Address : Set the IP address within the ranges shown below. The Network Audio function cannot be used if other IP addresses are set. CLASS A: 10.0.0.0 ~ 10.255.255.255 CLASS B: 172.16.0.0 ~ 172.31.255.255 CLASS C: 192.168.0.0 ~ 192.168.255.255 • Subnet Mask : When connecting an xDSL modem or terminal adapter directly to the AVR-4310CI, input the subnet mask indicated in the documentation supplied by your provider. Normally input 255.255.255.0. • Default Gateway : When connected to a gateway (router), input its IP address. • Primary DNS, Secondary DNS : If there is only one DNS address indicated in the documentation supplied by your provider, input it at "Primary DNS". If there are two or more DNS addresses, input the first one at "Secondary DNS". ④ Use ▽ to select "Exit" and press ENTER. Setup is complete. <p> ※ When connecting to the network via a Proxy server, select "Proxy" and press ENTER (☞ page 40 "Proxy settings"). </p>  <ul style="list-style-type: none"> • If you are using a broadband router (DHCP function), there is no need to make the settings at "IP Address" and "Proxy", since the DHCP function is set to "ON" in the AVR-4310CI's default settings. • If the AVR-4310CI is being used connected to a network without the DHCP function, the network settings must be made. In this case, some knowledge of networks is required. For details, consult a network administrator. • If you cannot connect to the Internet, recheck the connections and settings (☞ page 23). • If you do not understand about Internet connection, contact your ISP (Internet Service Provider) or the store from which you purchased your computer. • When you want to cancel the setting during IP address input, press RETURN.

See overleaf











Setting items	Setting contents
Network Connecting (Continued)	<p>Proxy settings : Make this setting when connecting to the Internet via a proxy server.</p>    <p>① On the GUI menu, select “Manual Setup” – “Network Setup” – “Network Connecting” – “Detail” and press ENTER.</p> <p>② Use $\Delta \nabla$ to set “Proxy” and press ENTER.</p> <p>③ Use $\triangleleft \triangleright$ to set “Proxy” to “ON” and press ∇. The proxy server is enabled.</p> <p>④ Use $\triangleleft \triangleright$ to select the proxy server input method, and then press ∇. Address : Select when inputting by address. Name : Select when inputting by domain name.</p> <p>⑤ Use $\Delta \nabla \triangleleft \triangleright$ to input the proxy server address or domain name and press ENTER. When “Address” is selected in step ④ : Input the address When “Name” is selected in step ④ : Input the domain name The types of characters that can be input are as shown below.</p> <div style="border: 1px solid black; padding: 5px;"> <p>[Lower case characters] abcdefghijklmnopqrstuvwxyz [Upper case characters] ABCDEFGHIJKLMNOPQRSTUVWXYZ [Symbols] ! # \$ % & ' () * + , - . / : ; < = > ? @ [\] ^ _ ` { } ~ (Space) [Numbers] 0123456789</p> </div> <p> You can change the character type when you press [SEARCH] or MENU during character input.</p>





Setting items	Setting contents
Network Connecting (Continued)	<p>⑥ Use $\Delta \nabla \triangleleft \triangleright$ to input the proxy server port number and press ENTER.</p> <p>⑦ Use ∇ to select “Exit” and press ENTER. Setup is complete.</p>
Other Network function on/off setting during standby, and PC language setting.	<p>Network Standby : Set the network function on/off during standby.</p> <ul style="list-style-type: none"> • ON : Network is on during standby. Main unit operable with a network-compatible controller. • OFF : Suspend network function during standby. <p> Set to “ON” when using the web control function.</p> <p>Character : When characters are not displayed correctly, set the MP3 ID3-Tag character code type reproduced by the USB memory device.</p> <ul style="list-style-type: none"> • Auto : Auto-select character code. • Latin : Select ISO 8859-1 Latin-1. • Japanese : Select Shift-JIS. <p> If the characters are not properly displayed when set to “Auto”, set to “Latin” or “Japanese”.</p> <p>PC Language : Select computer environment language.</p> <ul style="list-style-type: none"> • ara / chi (smpl) / chi (trad) / cze / dan / dut / eng / fin / fre / ger / gre / heb / hun / ita / jpn / kor / nor / pol / por / por(BR) / rus / spa / swe / tur <p>Friendly Name Edit : The Friendly Name is the name AVR-4310CI displayed on the network. Up to 63 characters can be input. The default Friendly Name on first use is “DENON:[AVR-4310CI]”. The types of characters that can be input are as shown below.</p> <div style="border: 1px solid black; padding: 5px;"> <p>[Lower case characters] abcdefghijklmnopqrstuvwxyz [Upper case characters] ABCDEFGHIJKLMNOPQRSTUVWXYZ [Symbols] ! # \$ % & ' () * + , - . / : ; < = > ? @ [\] ^ _ ` { } ~ (Space) [Numbers] 0123456789</p> </div> <p> You can change the character type when you press [SEARCH] or MENU during character input.</p> <p>Default : Reset all settings to factory default.</p> <ul style="list-style-type: none"> • Yes : Reset to the defaults. • No : Do not reset to the defaults. <p>Party Mode Function : Set the Party Mode function.</p> <ul style="list-style-type: none"> • OFF : Disable Party Mode function. • ON : Enable Party Mode function. <p> Refer to page 82, “Playing the Same Network Audio on Different Devices Connected in a Network (Party Mode Function)” for more information on the party mode function.</p>

See overleaf



Making Detailed Settings (Manual Setup)

Setting items	Setting contents
Other (Continued)	<p>Party Start Level : Make settings for volume level when the Party Mode is started.</p> <ul style="list-style-type: none"> • Last : The same volume as set before the party mode was started. • --- (0) : Always use the muting on condition when the Party Mode is started. • -80dB ~ 18dB (1 ~ 99) : Start party mode with your preferred volume. <p></p> <ul style="list-style-type: none"> • This can be set when "Party Mode Function" is set to "ON". • This is displayed from 0 to 99 when "Volume Display" ( page 42) is set to "Absolute". • You can set to the upper limit set with "Volume Limit" ( page 42) . <p>Network Status : Displays up to a maximum of 10 DENON products connected on the same network.</p> <ul style="list-style-type: none"> • Friendly Name / Model Name / Power ON/Standby / Select Source / Volume Level / Party Mode status <p></p> <p>"Network Status" is only displayed for DENON products supporting the Network Status function.</p> <p>Update Notification : Displays a notification message on the AVR-4310CI's GUI screen when the latest firmware is released with "Firmware Update". The notification message is displayed for about 20 seconds when the power is turned on. Connect to broadband Internet ( page 23) when using this function.</p> <ul style="list-style-type: none"> • ON : Display update message. • OFF : Do not display upgrade message. <p></p> <ul style="list-style-type: none"> • When you press ENTER during display of the notification message, the "Check for Update" screen is displayed. (Refer to page 44 for more information on "Firmware Update") • Press RETURN to erase the notification message. <p>Upgrade Notification : Display a notification message on the AVR-4310CI's GUI screen when downloadable firmware is released with "Add New Feature". The notification message is displayed for about 20 seconds when the power is turned on. Connect to broadband Internet ( page 23) when using this function.</p> <ul style="list-style-type: none"> • ON : Display update message. • OFF : Do not display upgrade message. <p></p> <ul style="list-style-type: none"> • When you press ENTER during display of the notification message, the "Add New Feature" screen is displayed. (Refer to page 45 for more information on "Add New Feature") • Press RETURN to erase the notification message.



Setting items	Setting contents
Rhapsody Account Set or change Username and Password ( page 68 "Listening to Rhapsody").	<p>Username / Password The types of characters that can be input are as shown below.</p> <div style="border: 1px solid black; padding: 5px;"> <p>[Lower case characters] abcdefghijklmnopqrstuvwxyz [Upper case characters] ABCDEFGHIJKLMNOPQRSTUVWXYZ [Symbols] ! # \$ % & ' () * + , - . / : ; < = > ? @ [\] ^ _ ` { } ~ (Space) [Numbers] 0123456789</p> </div> <p></p> <ul style="list-style-type: none"> • You can change the character type when you press [SEARCH] or MENU during character input. • The password may not contain underscores (_).
Napster Account Set or change Username and Password ( page 66 "Listening to Napster").	<p>Username / Password The types of characters that can be input are as shown below.</p> <div style="border: 1px solid black; padding: 5px;"> <p>[Lower case characters] abcdefghijklmnopqrstuvwxyz [Upper case characters] ABCDEFGHIJKLMNOPQRSTUVWXYZ [Symbols] ! # \$ % & ' () * + , - . / : ; < = > ? @ [\] ^ _ ` { } ~ (Space) [Numbers] 0123456789</p> </div> <p></p> <ul style="list-style-type: none"> • You can change the character type when you press [SEARCH] or MENU during character input. • The password may not contain underscores (_).
Network Information Display network information.	Friendly Name / DHCP= ON/OFF / IP Address / MAC Address



Making the Multi-zone Settings (Zone Setup)

Default settings are underlined.

Set the audio to playback with multi-zone (ZONE2, ZONE3).

Setting items	Setting contents
Bass Adjust low frequency range (bass).	-10dB ~ +10dB (0dB)
Treble Adjust high frequency range (treble).	-10dB ~ +10dB (0dB)
HPF Make settings for cutting the low range to reduce distortion in the bass.	OFF : The low range is not attenuated. ON : The low range is attenuated.
Lch Level Adjust the left channel output level.	-12dB ~ +12dB (0dB)  The "Lch Level" can be set when "Channel" ( page 42) is set to "Stereo".

See overleaf



Setting items	Setting contents
Rch Level Adjust the right channel output level.	-12dB ~ +12dB (0dB) ✎ The "Rch Level" can be set when "Channel" (🔗 page 42) is set to "Stereo".
Channel Set the signal output from multi-zone.	Stereo : Select stereo output. Mono : Select mono output. ✎ When "Amp Assign" (🔗 page 34) is set to "ZONE (MONO)", the "Channel" setting is automatically set to "Mono".
Volume Display Set how volume is displayed.	Relative : Display --- dB (Min), in the range -80 dB ~ 18 dB. Absolute : Display in the range 0 (Min) ~ 99. ✎ • The "Volume Display" setting is applied also to the "Volume Level", "Volume Limit" and "Power On Level" display method. • The "Volume Display" setting applies to all zones.
Volume Level Set the volume output level.	Variable : Volume adjustment enabled by main unit and remote controller. -40dB (41) : Fix volume at -40 dB. Set when adjusting volume by external amp. 0dB (81) : Fix volume at 0 dB. Set when adjusting volume by external amp. ✎ When "Amp Assign" (🔗 page 34) is set to "ZONE2", "ZONE3" or "ZONE (MONO)", the "Volume Level" setting is automatically set to "Variable".
Volume Limit Make a setting for maximum volume.	OFF : Do not set a maximum volume. -20dB (61) / -10dB (71) / 0dB (81) ✎ Can be set when the multi-zone "Volume Level" setting (🔗 page 42) is "Variable".
Power On Level Define the volume setting that is active when the power is turned on.	Last : Use the memorized setting from the last session. --- (0) : Always use the muting on condition when power is turned on. -80dB ~ 18dB (1 ~ 99) : The volume is adjusted to the set level. ✎ Can be set when the multi-zone "Volume Level" setting (🔗 page 42) is "Variable".
Mute Level Set the amount of attenuation when muting is on.	Full : The sound is muted entirely. -40dB : The sound is attenuated by 40 dB down. -20dB : The sound is attenuated by 20 dB down.



Making Other Settings (Option Setup)



Default settings are underlined.

Setting items	Setting contents
Volume Control Set the MAIN ZONE volume setting.	Volume Display : Set how volume is displayed. • Relative : Display ---dB (Min), in the range -80 dB ~ 18 dB. • Absolute : Display in the range 0 (Min) ~ 99. ✎ • The "Volume Display" setting is applied also to the "Volume Limit" and "Power On Level" display method. • The "Volume Display" setting applies to all zones. Volume Limit : Make a setting for maximum volume • OFF : Do not set a maximum volume. • -20dB (61) / -10dB (71) / 0dB (81) Power On Level : Define the volume setting that is active when the power is turned on. • Last : Use the memorized setting from the last session. • --- (0) : Always use the muting on condition when power is turned on. • -80dB ~ 18dB (1 ~ 99) : The volume is adjusted to the set level.
Source Delete Remove input sources that are not used from the display.	PHONO / CD / DVD / HDP / TV / SAT/CBL / VCR / DVR / V.AUX / NET/ USB / XM / SIRIUS / HD Radio : Select input source that is not used. • ON : Use this source. • Delete : Do not use this source. NOTE • Input sources being used in the various zones cannot be deleted. • Input sources set to "Delete" cannot be selected using SOURCE SELECT .
GUI Make GUI related settings.	Screensaver : Make screensaver settings. • ON : The screen saver is activated during GUI menu display or NET/ USB / iPod / XM / SIRIUS / HD Radio screen display if no operation is performed approximately for a continuous 3-minute period. When you press $\Delta \nabla \triangleleft \triangleright$, the screen saver is cancelled and the screen before that screen saver started is displayed. • OFF : Screen saver is not activated. Wall Paper : Set wallpaper to display the background when playback is stopped, etc. • Picture : Set the background to a picture (DENON logo). • Black : Set the background to black. • Gray : Set the background to gray. • Blue : Set the background to blue.

See overleaf

Main remote control operation buttons



:Displaying the menu
Cancel the menu



:Moves the cursor
(Up/Down/Left/Right)



:Confirm the setting



:Return to previous menu

Making Detailed Settings (Manual Setup)

Setting items	Setting contents
GUI (Continued)	<p>Format : Set the video signal format to be output for the TV you are using.</p> <ul style="list-style-type: none"> • NTSC : Select NTSC output. • PAL : Select PAL output. <p> The "Format" can also be set by the following procedure. However, the GUI screen is not displayed.</p> <ol style="list-style-type: none"> 1. Press and hold the <DSX> and <RETURN> for at least 3 seconds. "Video Format" appears on the display. 2. Press <Left> <Right> and set the video signal format. 3. Press the <ENTER>, <MENU> or <RETURN> to complete the setting. <p>NOTE</p> <p>When a format other than the video format of the connected TV is set, the picture will not be displayed properly.</p> <p>Text : Display the content of operation during switching of surround mode, input mode, etc.</p> <ul style="list-style-type: none"> • ON : Turn display on. • OFF : Turn display off. <p>Master Volume : Master volume display during adjustment.</p> <ul style="list-style-type: none"> • Bottom : Display at the bottom. • Top : Display at the top. • OFF : Turn display off. <p> When the master volume display is hard to see when superimposed on movie subtitles, set to "Top".</p> <p>NET/USB : Set the NET/USB screen display time when the input source is "NET/USB".</p> <ul style="list-style-type: none"> • Always : Show display continuously. • 30s : Show display for 30 seconds after operation. • 10s : Show display for 10 seconds after operation. • OFF : Turn display off. <p>iPod : Set the iPod screen display time when the input source is "iPod".</p> <ul style="list-style-type: none"> • Always : Show display continuously. • 30s : Show display for 30 seconds after operation. • 10s : Show display for 10 seconds after operation. • OFF : Turn display off. <p>Tuner : Set the tuner screen display time when the input source is "XM", "SIRIUS" or "HD Radio".</p> <ul style="list-style-type: none"> • Always : Show display continuously. • 30s : Show display for 30 seconds after operation. • 10s : Show display for 10 seconds after operation. • OFF : Turn display off.

Setting items	Setting contents
Quick Select Name Change the "Quick Select" display title to one you prefer.	<ol style="list-style-type: none"> 1. Use $\Delta \nabla$ to select the name of the Quick Select setting you want to change, then press \triangleright or ENTER. 2. Use $\triangleleft \triangleright$ to set the cursor to the character you want to change. 3. Use $\Delta \nabla$ to change the character, then press ENTER. <ul style="list-style-type: none"> • Up to 16 characters can be input. • You can change the character type when you press [SEARCH] or [MENU] during character input. • The types of characters that can be input are as shown below. <div style="border: 1px solid black; padding: 5px; margin: 5px 0;"> <p>[Upper case characters] ABCDEFGHIJKLMNOPQRSTUVWXYZ [Lower case characters] abcdefghijklmnopqrstuvwxyz [Symbols] ! # % & ' () * + , - . / : ; < = " > ? @ [\] (Space) [Numbers] 0 1 2 3 4 5 6 7 8 9</p> </div> 4. Repeat steps 1 ~ 3 to change the display name.
Zone Rename Change the display title of each zone to one you prefer.	<ol style="list-style-type: none"> 1. Use $\Delta \nabla$ to select the zone name (MAIN ZONE, ZONE2 or ZONE3) you want to change, then press \triangleright or ENTER. 2. Use $\triangleleft \triangleright$ to set the cursor to the character you want to change. 3. Use $\Delta \nabla$ to change the character, then press ENTER. <ul style="list-style-type: none"> • Up to 10 characters can be input. • You can change the character type when you press [SEARCH] or [MENU] during character input. • The types of characters that can be input are as shown below. <div style="border: 1px solid black; padding: 5px; margin: 5px 0;"> <p>[Upper case characters] ABCDEFGHIJKLMNOPQRSTUVWXYZ [Lower case characters] abcdefghijklmnopqrstuvwxyz [Symbols] ! # % & ' () * + , - . / : ; < = " > ? @ [\] (Space) [Numbers] 0 1 2 3 4 5 6 7 8 9</p> </div> 4. Repeat steps 1 ~ 3 to change the display name.

See overleaf



Setting items	Setting contents
Trigger Out 1 Select the condition for activating Trigger Out 1 for the input source, surround mode, etc. See "TRIGGER OUT jacks" (page 22) for more information on trigger out.	<ul style="list-style-type: none"> ❑ When Setting for Zone (MAIN ZONE / ZONE2 / ZONE3) Trigger out is activated through linkage to the power of the zone set to "ON". ❑ When Setting for Input Source Activate trigger out when the input source set to "ON" is selected. <ul style="list-style-type: none"> 🔧 Valid for the zone set to "ON" with "When Setting for Zone". ❑ When Setting for Surround Mode Activate trigger out when the surround mode set to "ON" is selected. <ul style="list-style-type: none"> 🔧 Valid when the "MAIN ZONE" set to "ON" with "When Setting for Zone" is selected, and when the input source set to "ON" with "When Setting for Input Source" is selected. ❑ When Setting for HDMI Monitor Activate trigger out when the HDMI monitor set to "ON" is selected. <ul style="list-style-type: none"> 🔧 Valid when the "MAIN ZONE" set to "ON" with "When Setting for Zone" is selected, and when the input source set to "ON" with "When Setting for Input Source" is selected. ❑ When setting for "Vertical Stretch" Activate trigger out through linkage when "Vertical Stretch" (page 37) is set to "ON". <ul style="list-style-type: none"> • ON : Activate trigger on this mode. • --- : Do not activate trigger on this mode.
Trigger Out 2 As with "Trigger Out 1", select the condition for activating Trigger Out 2.	
Remote (SIRIUS / XM) Set to SAT TU operating mode on the included remote control unit.	SAT TU : XM : Set when operating XM. SAT TU : SIRIUS : Set when operating SIRIUS.
Remote ID Set when you operate another DENON AV amplifier with the remote control unit of the AVR-4310CI. Match the remote control unit you are using with the remote ID of the AVR-4310CI.	1 / 2 / 3 / 4 <ul style="list-style-type: none"> 🔧 When changing the remote ID, also change the "MAIN", "iPod", "SAT TU", "DTU" and "NET/USB" modes of the main remote control unit at the same time. Also change the sub remote control unit at the same time (page 93, 98 "Setting the Remote ID").
232C Port Set when using an external controller or two-way remote control connected to the RS-232C terminal.	Serial Control : Set when using an external controller. 2Way Remote : Set when using a 2-way remote control unit. <ul style="list-style-type: none"> 🔧 When using a DENON two-way remote control (RC-7000CI or RC-7001RCI, sold separately), set to "2Way Remote". <div style="border: 1px solid black; padding: 5px; margin-top: 10px;"> NOTE When setting to "2Way Remote", you can not use the RS-232C connector as an external controller. </div>

Setting items	Setting contents												
Dimmer Adjust display brightness of the receiver.	Bright : Normal display brightness. Dim : Reduced display brightness. Dark : Very low display brightness. OFF : Turns the display off.												
Setup Lock Protect settings from inadvertent change.	OFF : Turn protection off. ON : Turn protection on. <ul style="list-style-type: none"> 🔧 • When "Setup Lock" is set to "ON", the settings listed below can no longer be changed. Also, "SETUP LOCKED!" is displayed if you attempt to operate related settings. <table style="width: 100%; border: none;"> <tr> <td>·GUI menu operations</td> <td>·Dynamic Volume</td> </tr> <tr> <td>·RESTORER</td> <td>·Channel Level</td> </tr> <tr> <td>·Audio/Video Adjust</td> <td>·Audio Delay</td> </tr> <tr> <td>·MultEQ XT</td> <td>·Input Mode</td> </tr> <tr> <td>·Dynamic EQ</td> <td></td> </tr> </table> • When canceling the setting, set "Setup Lock" to "OFF". 	·GUI menu operations	·Dynamic Volume	·RESTORER	·Channel Level	·Audio/Video Adjust	·Audio Delay	·MultEQ XT	·Input Mode	·Dynamic EQ			
·GUI menu operations	·Dynamic Volume												
·RESTORER	·Channel Level												
·Audio/Video Adjust	·Audio Delay												
·MultEQ XT	·Input Mode												
·Dynamic EQ													
Maintenance Mode Used when receiving maintenance from a DENON service engineer or custom installer.	<div style="border: 1px solid black; padding: 5px; margin-bottom: 10px;"> NOTE Only use this function if so instructed by a DENON serviceperson or installer. </div>												
Firmware Update Update the firmware of the receiver.	Check for Update : You can check for firmware updates. You can also check approximately how long it will take to complete an update. Start : Execute the update process. When updating starts, the power indicator becomes red and the GUI screen is shut down. The amount of update time which has elapsed is displayed. When updating is complete the power indicator becomes green and normal status is resumed. ※ If updating fails, the set automatically retries, but if updating is still not possible, one of the messages shown below is displayed. If the display reads as shown below, check the settings and network environment, then update again. <table border="1" style="width: 100%; border-collapse: collapse; margin-top: 10px;"> <thead> <tr> <th>Display</th> <th>Description</th> </tr> </thead> <tbody> <tr> <td>Updating failed</td> <td>Updating failed.</td> </tr> <tr> <td>Login failed</td> <td>Failure to log into server.</td> </tr> <tr> <td>Server is busy</td> <td>Server is busy. Wait a while then try again.</td> </tr> <tr> <td>Connection fail</td> <td>Failure connecting to server.</td> </tr> <tr> <td>Download fail</td> <td>Downloading of the firmware has failed.</td> </tr> </tbody> </table>	Display	Description	Updating failed	Updating failed.	Login failed	Failure to log into server.	Server is busy	Server is busy. Wait a while then try again.	Connection fail	Failure connecting to server.	Download fail	Downloading of the firmware has failed.
Display	Description												
Updating failed	Updating failed.												
Login failed	Failure to log into server.												
Server is busy	Server is busy. Wait a while then try again.												
Connection fail	Failure connecting to server.												
Download fail	Downloading of the firmware has failed.												

➔ See overleaf

Making Detailed Settings (Manual Setup)

Setting items	Setting contents
Add New Feature Display the new functions (payment required) which can be purchased for downloading to the AVR-4310CI and upgrade. When you purchase a new function and register your user information, "Registered" is displayed on this menu and you can proceed with the upgrade.	Upgrade : Execute the upgrade process. When updating starts, the power indicator becomes red and the GUI screen is shut down. The amount of update time which has elapsed is displayed. When updating is complete the power indicator becomes green and normal status is resumed. ※ If the upgrade is not successful, an error message identical to those in "Firmware Update" will appear on the display, check the settings and network environment, then update again. Upgrade Status : A list of the additional functions provided by the Upgrade will be displayed.  When "Not Registered" is displayed on the Add New Feature screen, you cannot upgrade. To use the upgrade function, you should purchase an upgrade package from the DENON website. To purchase the package, you will need the ID number shown on this screen. To display the ID number on the screen, hold <D> and <STATUS> down for 3 seconds or more.

Notes concerning use of "Firmware Update" and "Add New Feature"

- In order to use these functions, you must have the correct system requirements and settings for a broadband Internet connection.
- Do not turn off the power until updating or upgrading is completed.
- Even with a broadband connection to the Internet, approximately 1 hour is required for the updating/upgrading procedure to be completed.
 Once updating/upgrade starts, normal operations on the AVR-4310CI cannot be performed until updating/upgrading is completed.
 Furthermore, updating/upgrading the firmware may reset the backup data for the parameters, etc., set for the AVR-4310CI.
- The following backup data may be erased after an update or upgrade.
 - Internet radio preset channel
 - Internet radio Recently Played data
 - Care of data in Internet radio, media server and USB memory device
- In the event of an update error during update or upgrade, turn the AVR-4310CI's power off and then on again. "Update Retry" appears on the display and update restarts from the point at which update failed. If the error continues despite this, check the network environment.



- Information regarding the "Firmware Update" function and "Add New Feature" will be announced on the DENON web site each time related plans are defined.
- When usable new firmware is released with "Firmware Update" or "Add New Feature", a notification message is displayed on the GUI screen. When you do not want to be notified, set "Update Notification" (page 41) and "Upgrade Notification" (page 41) to "OFF".



Making Language Settings (Language)



Default settings are underlined.

Set the language for display on the GUI screen.

Setting contents

English / Français

 The "Language" can also be set by the following procedure. However, the GUI screen is not displayed.

1. Press and hold the <DSX> and <RETURN> for at least 3 seconds.
 "Video Format" appears on the display.
2. Use $\Delta \nabla$ to set "GUI Language".
3. Press <D> and set the language.
4. Press the <ENTER>, <MENU> or <RETURN> to complete the setting.





Making the Input Settings (Source Select)



For details on how to select, set and cancel settings for each menu, see "GUI Menu Operation" (page 26).

Select input source and make playback settings.

Items that can be set with the Source Select procedure

Changing the Input Terminal Assignments (Input Assign) (page 46)

Making the Video Settings (Video) (page 48)

Changing the Input Mode and Decoding Mode (Input Mode) (page 49)

Changing the Input Source's Display Name (Rename) (page 50)

Correcting the Input Source's Playback Level (Source Level) (page 50)

Displaying the Playback Screen for the Different Input Sources (Play) (page 50)

Setting the Playback Mode (Playback Mode) (page 50)

- iPod (page 50)
- NET/USB (page 51)
- Media Server, USB/iPod, Napster and Rhapsody (page 51)

Making the Settings to Play Still Pictures (Still Picture) (page 51)

Automatically Presetting Radio Stations (Auto Preset) (page 51)

Setting Preset Channels so that They are not Displayed When Tuning (Preset Skip) (page 51)

Giving Names to Preset Stations (Preset Name) (page 52)

Check the XM Radio and SIRIUS Radio Reception Sensitivity (Antenna Aiming) (page 52)

Setting SIRIUS Radio Reception Restrictions (Parental Lock) (page 52)

Important Information

About the Display of Input Sources in This Manual

In this manual, the names of input sources that can be set at the different items are indicated as shown below.

PHONO	CD	DVD	HDP	TV	SAT/CBL	VCR	DVR	V.AUX	NET/USB	Internet Radio
Media Server	USB/iPod	Napster	Rhapsody	XM	SIRIUS	HD Radio				

NOTE

Input sources that have been set to "Delete" at "Source Delete" (page 42) cannot be selected.

Changing the Input Terminal Assignments (Input Assign)



Default settings are underlined.

Examples of Input Assign Menu Screen Displays

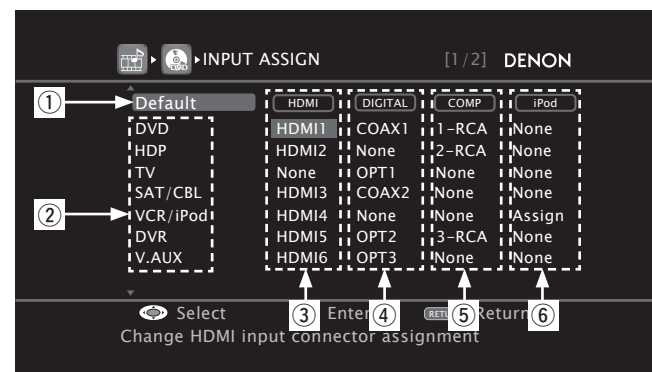

- ① Default button
- ② Input Source
- ③ HDMI input
- ④ Digital audio input
- ⑤ Component video input
- ⑥ iPod dock



Input Assignments Menu Operations

1 Press MENU.
The GUI menu is displayed on the TV screen.

Use the $\Delta \nabla$ to select “SOURCE SELECT”, then press **ENTER** or \triangleright .

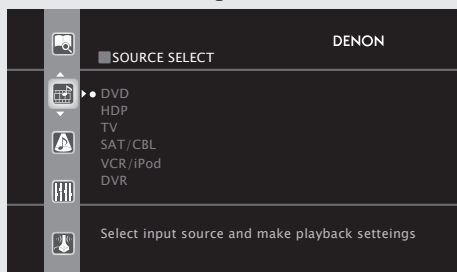

2 Press $\Delta \nabla$ to select the input source you want to set, then press \triangleright .

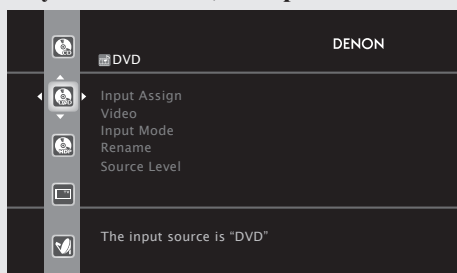

3 Select “Input Assign”, then press **ENTER or \triangleright .**
The “INPUT ASSIGN” screen is displayed.

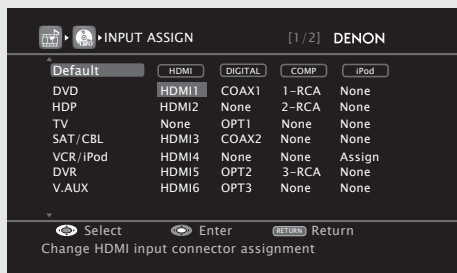

4 Use $\Delta \nabla \triangleleft \triangleright$ to move the gray highlight to the item you want to set.

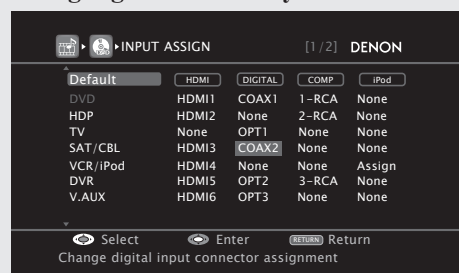

5 Press **ENTER, then use $\triangleleft \triangleright$ to select the input terminal to be assigned.**

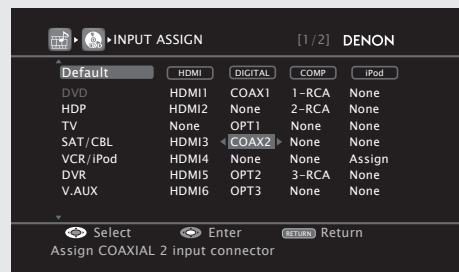

6 Press **ENTER to enter the setting.**

Setting items

Setting contents

HDMI HDMI
Set this to change the HDMI input terminals assigned to the input sources.

The DVD HDP TV SAT/CBL VCR DVR V.AUX input sources are assigned to the HDMI input terminals as shown below.

HDMI 1 / HDMI 2 / HDMI 3 / HDMI 4 / HDMI 5 / HDMI 6

None : Do not assign an HDMI input terminal to the selected input source.

※ Upon purchase, the settings of the different input sources are as shown below.

Input source	DVD	HDP	TV	SAT/CBL	VCR	DVR	V.AUX
Default setting	HDMI 1	HDMI 2	None	HDMI 3	HDMI 4	HDMI 5	HDMI 6



- An input source to which an HDMI input terminal cannot be assigned is displayed as “---”.
- To play the video signal assigned at “HDMI” combined with the audio signal assigned at “Input Assign – Digital”, select “Digital” at “Input Mode” (page 49).
- When the AVR-4310CI and monitor are connected with an HDMI cable, if the monitor is not compatible with HDMI audio signal playback, only the video signals are output to the monitor.
- The audio signals input from the analog, digital and EXT. IN connectors are not output to the monitor.
- When control dock for iPod is used as the input source, assignment of the HDMI input terminal is disabled, even if it is assigned.
- When “HDMI Control” – “Control” (page 37) is set to “ON”, HDMI input terminal cannot be assigned to “TV”.

Digital DIGITAL

Set this to change the digital input terminals assigned to the input sources.

The CD DVD HDP TV SAT/CBL VCR DVR V.AUX SIRIUS input sources are assigned to the digital input terminals as shown below.

COAX 1 (COAXIAL) / COAX 2 / COAX 3 / OPT 1 (OPTICAL) / OPT 2 / OPT 3 / D.LINK (DENON LINK) *

* : “D.LINK” is set when the AVR-4310CI is connected by DENON LINK to a DENON Blu-ray disc / DVD player (page 20 “Components Equipped with a DENON LINK Connector”).

None : Do not assign a digital input terminal to the selected input source.

See overleaf



Setting items	Setting contents						
Digital DIGITAL (Continued)	※ Upon purchase, the settings of the different input sources are as shown below.						
	Input source	CD	DVD	HDP	TV	SAT/CBL	VCR
	Default setting	COAX 3	COAX 1	None	OPT 1	COAX 2	None
	Input source	DVR	V.AUX	SIRIUS			
	Default setting	OPT 2	OPT 3	None			
	✎ When control dock for iPod is used as the input source, assignment of the digital input terminal is disabled, even if it is assigned.						

Setting items	Setting contents							
Component COMP Set this to change the component video input terminals assigned to the input sources.	The DVD HDP TV SAT/CBL VCR DVR V.AUX input sources are assigned to the component video input terminals as shown below.							
	1-RCA (Component video 1) / 2-RCA (Component video 2) / 3-RCA (Component video 3)							
	None : Do not assign a component video input terminal to the selected input source.							
	※ Upon purchase, the settings of the different input sources are as shown below.							
	Input source	DVD	HDP	TV	SAT/CBL	VCR	DVR	V.AUX
	Default setting	1-RCA	2-RCA	None	None	None	3-RCA	None
	✎							
	<ul style="list-style-type: none"> An input source to which a component video input terminal cannot be assigned is displayed as "---". When control dock for iPod is used as the input source, assignment of the component video input terminal is disabled, even if it is assigned. 							

Setting items	Setting contents						
iPod dock iPod Assign the control dock for iPod input.	The control dock for iPod can be assigned to the CD DVD HDP TV SAT/CBL VCR DVR V.AUX input sources.						
	Assign : Assign the control dock for iPod to the selected input source.						
	None : Do not assign the control dock for iPod to the selected input source.						
	✎						
	<ul style="list-style-type: none"> By default on first use, it is assigned to "VCR (iPod)". An input source to which control dock for iPod cannot be assigned is displayed as "---". If control dock for iPod is not connected to the AVR-4310CI, assignment of the "iPod dock" is disabled, and you can use it as a standard input source. 						
Default Reset all settings to factory default.	Yes : Reset to the defaults.						
	No : Do not reset to the defaults.						
	✎						
	If you select "Default" and press ENTER the message "Return all settings to the default?" is displayed. Select "Yes" or "No", and then press ENTER .						





Making the Video Settings (Video) GUI

Default settings are underlined.

Setting items	Setting contents						
Video Select Change video input to your preferred input source.	SOURCE : Play the picture and sound of the input source.						
	DVD / HDP / TV / SAT/CBL / VCR / DVR / V.AUX : Select video input source to view. This can be set for individual input sources.						
	✎						
	Set by either pressing <VIDEO SELECT> on the main unit or [VIDEO SELECT] on the main remote control.						
	<ul style="list-style-type: none"> When operating from the main remote control unit Press [VIDEO SELECT] repeatedly until the picture you want to see is displayed. To cancel, press [VIDEO SELECT], and select "SOURCE" When operating from the main unit After pressing <VIDEO SELECT> on the main unit, turn the <SOURCE SELECT> on the main unit until the picture you want to see is displayed. To cancel, press <VIDEO SELECT>, then turn <SOURCE SELECT> and select "SOURCE". 						
	NOTE						
	<ul style="list-style-type: none"> It is not possible to select HDMI input signals. The video select function does not work with HDMI signals. Input sources for which "Delete" is selected at "Source Delete" (page 42) cannot be selected. 						

See overleaf

Making the Input Settings (Source Select)

Setting items	Setting contents
Video Convert The input video signal is converted automatically in function of the connected TV (page 10 "Converting Input Video Signals for Output (Video Conversion Function)").	This can be set when the input source is DVD HDP TV SAT/CBL VCR DVR V.AUX . ON : The input video signal is converted. OFF : The input video signal is not converted.  <ul style="list-style-type: none"> When a non-standard video signal from a game machine or some other source is input, the video conversion function might not operate. In this case set "Video Convert" to "OFF". When "Video Convert" is set to "OFF", the video conversion function does not work. In this case, connect the AVR-4310CI and TV with the same type of cable.
i/p Scaler The input source's resolution is converted to the resolution set at "Resolution".	Analog : Use i/p scaler function for analog video signal. Analog & HDMI : Use i/p scaler function for analog and HDMI video signal. OFF : Do not use i/p scaler function.  <ul style="list-style-type: none"> This can be set when "Video Convert" is set to "ON". "Analog & HDMI" can be set for input sources for which an HDMI input terminal is assigned. When "i/p Scaler" is set to "Analog & HDMI", it has no effect on the x.v. Color signal or computer resolutions.
Resolution Set resolution of the video signal output to HDMI.	<ul style="list-style-type: none"> Auto : The number of pixels the TV connected to the HDMI output terminal supports is detected automatically and the appropriate output resolution is set. 480p/576p / 1080i / 720p / 1080p / 1080p:24Hz : Set the output resolution.  <ul style="list-style-type: none"> This can be set when "i/p Scaler" is set to anything other than "OFF". When "i/p Scaler" is set to "Analog & HDMI", the resolution of both the analog video input signal and HDMI input signal can be set. To watch 1080p/24Hz pictures, use a TV that supports 1080p/24Hz video signals. When set to "1080p/24Hz", you can enjoy film-like pictures for film sources (in 24 Hz). For video sources and mixed sources, we recommend setting the resolution to "1080p". It is not possible to convert a 50 Hz signal into 1080p/24Hz. It is output at a resolution of 1080p/50Hz.
Progressive Mode Select optimum progressive mode for video material.	This can be set when the input source is DVD HDP TV SAT/CBL VCR DVR V.AUX . Auto : The video material is automatically detected and the appropriate mode is set. Video 1 : Select mode suitable for video playback Video 2 : Select mode suitable for video and 30-frame film material playback.  This can be set when "i/p Scaler" is set to anything other than "OFF".



Setting items	Setting contents
Aspect Set the aspect ratio for the video signals output to the HDMI.	This can be set when the input source is DVD HDP TV SAT/CBL VCR DVR V.AUX NET/USB . Full : Output at 16:9 aspect ratio. Normal : Output at 4:3 aspect ratio.  This can be set when "i/p Scaler" is set to anything other than "OFF".

Changing the Input Mode and Decoding Mode (Input Mode)



Default settings are underlined.

The selectable input modes depend on the input source and "Input Assign" (page 46) setting.

Setting items	Setting contents
Input Mode Set the audio input modes for the different input sources.	Auto : Automatically detect input signal and perform playback. HDMI : Play only signals from HDMI input. Digital : Play only signals from digital input. Analog : Play only signals from analog input. EXT. IN : Play only signals from EXT. IN input.  <ul style="list-style-type: none"> "HDMI" can be set for input sources for which "HDMI" is assigned at "Input Assign". "Digital" can be set for input sources for which "Digital" is assigned at "Input Assign". When digital signals are properly input, the "DIG." indicator lights on the display. If the "DIG." indicator does not light, check the digital input connector assignment and the connections. The surround mode cannot be set if the input mode is set to "EXT. IN". This can also be set by pressing <INPUT MODE>. Each time you press the button, the input mode display will change. <div style="text-align: center;">  <pre> graph LR Auto --> HDMI HDMI --> Digital Digital --> Analog Analog --> EXT_IN[EXT. IN] EXT_IN --> Auto </pre> </div>

See overleaf



Setting items	Setting contents
Decode Mode Set the decode mode for input source	This can be set when the input source is CD DVD HDP TV SAT/CBL VCR DVR V.AUX . Auto : Detect type of digital input signal and decode and play automatically. PCM : Decode and play only PCM input signals. DTS : Decode and play only DTS input signals.  <ul style="list-style-type: none"> This can be set for input sources for which “HDMI” or “Digital” is assigned at “Input Assign” (page 47). Normally set this to “Auto”. Set “PCM” and “DTS” when inputting the corresponding input signal.

Changing the Input Source’s Display Name (Rename) GUI

Setting items	Setting contents
Rename Change the display name of the selected input source.	<ol style="list-style-type: none"> Press ▷ or ENTER. Use ◀▶ to set the cursor to the character you want to change. Use △▽ to change the character, then press ENTER. <ul style="list-style-type: none"> Up to 8 characters can be input. The input character type can be switched by pressing [SEARCH] or MENU while the display name is being changed. The types of characters that can be input are as shown below. <div style="border: 1px solid black; padding: 5px; margin: 5px 0;"> <p>[Upper case characters] ABCDEFGHIJKLMNOPQRSTUVWXYZ [Lower case characters] abcdefghijklmnopqrstuvwxyz [Symbols] ! # % & ' () * + , - . / : ; < = " > ? @ [\] (Space) [Numbers] 0123456789</p> </div> Repeat steps 2 and 3 to change the display name.
Default Reset all settings to factory default.	Yes : Reset to the defaults. No : Do not reset to the defaults.

Correcting the Input Source’s Playback Level (Source Level) GUI

Default settings are underlined.

- Corrects the playback level of the selected input source’s audio input.
- Set this if there are differences in the input volume levels between the different sources.

Setting contents

-12dB ~ +12dB (0dB)

-  The analog input level and digital input level can be adjusted independently for input sources for which “HDMI” or “Digital” is assigned at “Input Assign” (page 47).

Displaying the Playback Screen for the Different Input Sources (Play) GUI

When the input source is “**NET/USB** **(Favorites)** **Internet Radio** **Media Server** **USB/iPod** **Napster** **Rhapsody** **XM** **SIRIUS** **HD Radio** **(iPod)**”, the corresponding screen can be displayed.

Setting the iPod with iPod Dock Playback Mode (Playback Mode) GUI

This can be set for the input source for which “iPod dock” is assigned at “Input Assign” (page 48).

Setting items	Setting contents
Repeat Make settings for repeat mode.	All : Repeat all songs. One : Repeat the current song. OFF : Cancel repeat mode.
Shuffle Make settings for shuffle mode.	Songs : Shuffle all songs. Albums : Shuffle songs from current album only. OFF : Cancel shuffle mode.

See overleaf 



SEARCH : Displaying the menu
MENU : Cancel the menu



Moves the cursor (Up/Down/Left/Right)



: Confirm the setting



: Return to previous menu

Making the Input Settings (Source Select)

Setting the NET/USB Playback Mode (Playback Mode) GUI

Default settings are underlined.

This can be set when the input source is **NET/USB**.

Setting items	Setting contents
USB Select Set the USB port to be used.	Front : Select front-panel port. Rear : Select rear-panel port.
Direct Play Use DIRECT PLAY on the sub remote control unit to set the folder to be played.	Favorites : Play songs registered as "Favorites". All Music : Play the songs saved on the PC media.

Setting the Media Server, USB/iPod, Napster and Rhapsody Playback Mode (Playback Mode) GUIThis can be set when the input source is **Media Server** **USB/iPod** **Napster** **Rhapsody**.

Setting items	Setting contents
Repeat Make settings for repeat mode.	All : Repeat all files. One : Repeat the current file. OFF : Cancel repeat mode.
Random Make random mode settings.	ON : Enable random playback. OFF : Disable random playback.

Making the Settings to Play Still Pictures (Still Picture) GUI

Default settings are underlined.

This can be set when the input source is **NET/USB**.

Setting items	Setting contents
Slide Show Make slide show settings.	ON : Display still picture images in a slide show. OFF : Display only the selected still picture image.
Interval Set the playback time per image.	5s ~ 60s (5s)

Automatically Presetting Radio Stations (Auto Preset) GUI

Default settings are underlined.

Setting items	Setting contents
Start Start the auto preset process.	This can be set when the input source is HD Radio .  If an FM station cannot be preset automatically, select the desired station by tuning it in manually, then preset it manually.

Setting Preset Channels so that They are not Displayed When Tuning (Preset Skip) GUI

Default settings are underlined.

Setting items	Setting contents
A ~ G Set the preset channels that you do not want to display.	This can be set when the input source is XM SIRIUS HD Radio . All : All the preset channels in the selected memory block are skipped. 1 ~ 8 : Set the preset channels you do not want to displayed. • ON : Display the selected preset channel. • Skip : Do not display the selected preset channel.  When set to "All" to "Skip", it is possible to skip entire preset memory blocks (A to G).

[See overleaf](#)

Giving Names to Preset Stations (Preset Name)

GUI

Default settings are underlined.

Setting items	Setting contents
A1 ~ G8 Select the preset channel.	This can be set when the input source is HD Radio . <ol style="list-style-type: none"> Press ▷ or ENTER. Use ◀ ▷ to set the cursor to the character you want to change. Use △▽ to change the character, then press ENTER. <ul style="list-style-type: none"> Up to 8 characters can be input. The input character type can be switched by pressing [SEARCH] or MENU while the display name is being changed. The types of characters that can be input are as shown below. Repeat steps 2 and 3 to change the display name. <div style="border: 1px solid black; padding: 5px; margin: 10px 0;"> <p>[Upper case characters] ABCDEFGHIJKLMNOPQRSTUVWXYZ [Lower case characters] abcdefghijklmnopqrstuvwxyz [Symbols] ! # % & ' () * + , - . / : ; < = " > ? @ [\] (Space) [Numbers] 0123456789</p> </div>
Default Reset all settings to factory default.	Yes : Reset to the defaults. No : Do not reset to the defaults.

Check the XM Radio and SIRIUS Radio Reception Sensitivity (Antenna Aiming)

GUI

Default settings are underlined.

- This can be set when the input source is **XM** **SIRIUS**.
- Install the antenna with radio reception sensitivity set to maximum.

Setting items	Setting contents												
Satellite Indicate satellite signal strength.	<input type="checkbox"/> When the input source is XM <table border="1" style="margin-top: 10px;"> <thead> <tr> <th>Display</th> <th>Condition</th> </tr> </thead> <tbody> <tr> <td>▣▣▣▣</td> <td>Signal strength is strong</td> </tr> <tr> <td>▣▣▣</td> <td>Signal strength is good</td> </tr> <tr> <td>▣▣</td> <td>Signal strength is marginal</td> </tr> <tr> <td>▣</td> <td>Signal strength is weak</td> </tr> <tr> <td></td> <td>No signal</td> </tr> </tbody> </table>	Display	Condition	▣▣▣▣	Signal strength is strong	▣▣▣	Signal strength is good	▣▣	Signal strength is marginal	▣	Signal strength is weak		No signal
Display	Condition												
▣▣▣▣	Signal strength is strong												
▣▣▣	Signal strength is good												
▣▣	Signal strength is marginal												
▣	Signal strength is weak												
	No signal												
Terrestrial Indicate terrestrial signal strength.	<input type="checkbox"/> When the input source is SIRIUS <table border="1" style="margin-top: 10px;"> <thead> <tr> <th>Display</th> <th>Condition</th> </tr> </thead> <tbody> <tr> <td>▣▣▣▣</td> <td>Signal strength is excellent</td> </tr> <tr> <td>▣▣▣</td> <td>Signal strength is good</td> </tr> <tr> <td>▣</td> <td>Signal strength is weak</td> </tr> <tr> <td></td> <td>No signal</td> </tr> </tbody> </table>	Display	Condition	▣▣▣▣	Signal strength is excellent	▣▣▣	Signal strength is good	▣	Signal strength is weak		No signal		
Display	Condition												
▣▣▣▣	Signal strength is excellent												
▣▣▣	Signal strength is good												
▣	Signal strength is weak												
	No signal												

Setting SIRIUS Radio Reception Restrictions (Parental Lock)

GUI

Default settings are underlined.

- This can be set when the input source is **SIRIUS**.
- For any channel, set the radio reception limits.

Setting items	Setting contents
Lock Setting Set the channel radio reception limits.	<ol style="list-style-type: none"> Press △▽ to select "Lock Setting", and then press ▷ or ENTER. Pressing △▽◀▷, input the password (4 digits number) and press ENTER. Select channel by pressing △▽, and set the lock by pressing ◀▷. Unlock : Do not lock selected channel(s). Lock : Lock selected channel(s). When a Parental Locked channel is tuned, "Enter Lock Code" is displayed, then input the password. <ul style="list-style-type: none"> The default password is "0000". If the password is wrong, "Lock Code is incorrect" is displayed. Input the correct password. While listening to the channel being played, you can also set parental lock (page 60).
Edit Lock Code Change the password.	<ol style="list-style-type: none"> Press △▽ to select "Edit Lock Code", and then press ▷ or ENTER. Input current lock code (4 digits) using △▽◀▷, and press ENTER. Input new lock code (4 digits) using △▽◀▷, and press ENTER. Input new lock code (4 digits) again using △▽◀▷, and press ENTER. Press △▽ to select "Execute", and then press ENTER. If the correct password is input, "Completed" is displayed, and the new password is modified. <ul style="list-style-type: none"> If the old password is incorrectly input, "Current Lock Code is incorrect" is displayed, and proceed again from step 1. If the password input is 3 digits or less, "Enter 4 digits number" is displayed, and input again with a 4 digit password. If the new password is not correctly input, "New Lock Codes do not match" is displayed and the password does not change.

Main remote control operation buttons



:Displaying the menu
Cancel the menu



:Moves the cursor (Up/Down/Left/Right)



:Confirm the setting



:Return to previous menu

Playback



Symbols used to indicate buttons in this manual

- Button located on both the main unit and the remote control unit → **BUTTON**
- Button only on the main unit → **<BUTTON>**
- Button only on the remote control unit → **[BUTTON]**

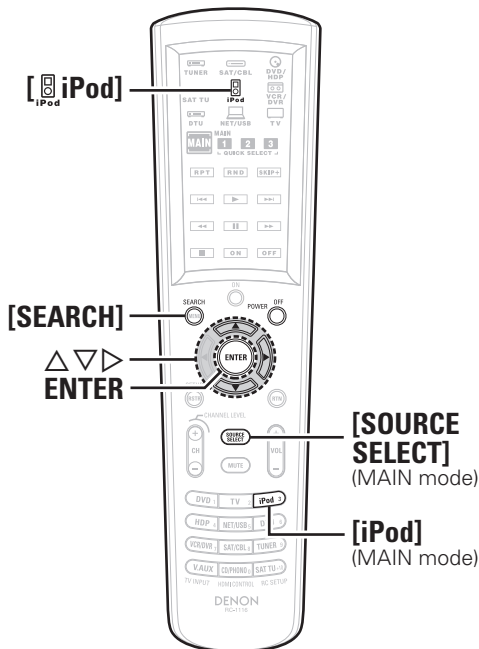
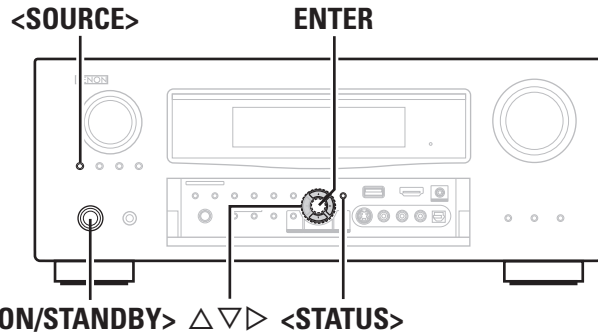

Important Information

Before starting playback, make the connections between the different components and the settings on the receiver.

NOTE

- Also refer to the operating instructions of the connected components when playing them.
- External devices can be controlled by remote control unit (☞ page 89 “Operating the Connected Devices by Remote Control Unit”).

Playing Components

Playing a Blu-ray Disc Player/DVD Player

- The following describes the procedure for playing Blu-ray disc player / DVD player. Use the same procedure to play other components.
- Switch the main remote control unit to the “MAIN” mode when performing this operation (☞ page 89 “Operating the Main Remote Control Unit”).

1 Playback preparation.

- ① Turn on the power of the TV, subwoofer and player.
- ② Switch the TV's input to the AVR-4310CI.
- ③ Load the disc in the player.

2 Turn the AVR-4310CI power on.

(☞ page 24 “Turning the Power On”)

3 Press [SOURCE SELECT] and select the input source.

Display the source select menu (☞ page 27).

4 Play the component connected to the AVR-4310CI.

Make the necessary settings on the player (language setting, subtitles setting, etc.) beforehand.

5 Adjust the items below.

- Adjusting the master volume (☞ page 70)
- Selecting the surround mode (☞ page 71)
- Adjusting the Sound and Picture Quality (☞ page 73)

Playing an iPod® Using a Control Dock for iPod

When a DENON control dock for iPod (ASD-1R or ASD-11R, sold separately) is used, you can play images and music stored on an iPod®.

Listening to music on an iPod®

1 Playback preparation.

- ① Connecting the DENON control dock for iPod to the AVR-4310CI (☞ page 16 “Control Dock for iPod”).
- ② Set the iPod® in the DENON control dock for iPod.

2 Turn the AVR-4310CI power on.

(☞ page 24 “Turning the Power On”)

3 Press [SOURCE SELECT] to display the GUI Source Select menu, then select “iPod” (☞ page 27).

The input source switches to the source to which the control dock for iPod is assigned and the iPod menu is displayed.

– GUI screen –

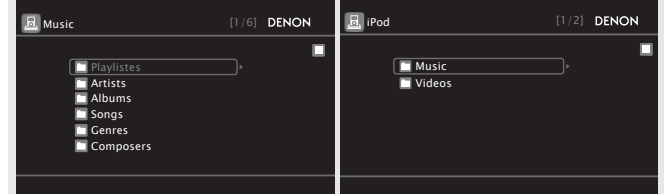

(When using an ASD-1R)

(When using an ASD-11R)

※ When using an ASD-11R, the “Music” and “Videos” folders are displayed on the top menu.

※ Once communications between the AVR-4310CI and the iPod are completed, the connections screen is displayed on the iPod.

※ If the connections screen is not displayed, the iPod may not be properly connected. Reconnect it.

4 Set the main remote control unit to the “iPod” mode (☞ page 89 “Operating the Main Remote Control Unit”).

5 Press [SEARCH] and hold it down for a 2 seconds or more to select the display mode.

※ There are two modes for display the contents recorded on the iPod.

Browse mode :

This is the mode for displaying the iPod information on the GUI screen to operate the iPod. In this mode, you cannot perform operations directly on the iPod itself.

* With the AVR-4310CI's display, only English letters and numbers and certain symbols can be displayed. Any characters that cannot be displayed are replaced with ". (period)".

Remote mode :

This is the mode for performing operations directly on the iPod itself while watching the screen displayed on the iPod. In this mode, the GUI screen is not displayed.

* "Remote iPod" is displayed on the AVR-4310CI's display.

Display mode		Browse mode	Remote mode
Playable files	Audio file	○	○
	Picture file	×	○*2
	Movie file	○*1	○*2
Active buttons	Main remote control unit (AVR-4310CI)	○	○
	iPod®	×	○

*1 : When using an ASD-11R DENON control dock for iPod.

*2 : Video may not be output, depending on the combination of ASD-1R or ASD-11R DENON control dock for iPod and iPod.

6 Use Δ ∇ to select the item, then press ENTER or \triangleright to select the file to be played.

7 Press ENTER, \triangleright or \blacktriangleright . Playback starts.

8 Adjust the items below.

- Adjusting the master volume (📖 page 69)
- Selecting the surround mode (📖 page 71)
- Adjusting the Sound and Picture Quality (📖 page 73)

To stop (📖 page 70)

Stopping playback temporarily (📖 page 70)

Fast-forwarding or fast-reversing (📖 page 70)

To cue to the beginning of a track (📖 page 70)

Playing repeatedly (📖 page 70)

Shuffling playback (📖 page 70)

Searching pages (📖 page 70)



- Use the RESTORER mode to expand the low and high frequency components of compressed audio files and achieve a richer sound (📖 page 77). The default setting is "Mode 3".
- The title name, artist name and album name can be checked by pressing <STATUS> during playback.
- The time (default : 30 sec) for which the GUI menus are displayed can be set at "GUI" – "iPod" (📖 page 43). Press Δ ∇ \triangleleft \triangleright to return to the original screen.
- Press [POWER OFF] or <ON/STANDBY> and set the AVR-4310CI's power to the standby mode before disconnecting the iPod. Also switch the input source to one to which the menu "iPod" is not assigned before disconnecting the iPod.

NOTE

- Depending on the type of iPod and the software version, some functions may not operate.
- DENON will accept no responsibility whatsoever for any loss of iPod data.

Viewing Videos on an iPod® in the Browse Mode

When an iPod equipped with a video function is connected to a DENON ASD-11R control dock for iPod, image files can be played in the browse mode.

1 Use Δ ∇ to select "Videos", then press ENTER or \triangleright .

2 Use Δ ∇ to select the search item or folder, then press ENTER or \triangleright .

3 Use Δ ∇ to select the video file, then press ENTER or \triangleright .

Playback starts.

Viewing Still Pictures and Videos on an iPod® in the Remote Mode

Photos and videos on an iPod® equipped with a slide show or video function can be played using a DENON ASD-1R control dock for iPod.

1 Press and hold [SEARCH] to set the Remote mode.
"Remote iPod" is displayed on the AVR-4310CI's display.

2 Watching the iPod's screen, use Δ ∇ to select "Photos" or "Videos".

※ Depending on the iPod model, it may be necessary to operate the iPod unit directly.

3 Press ENTER until the image you want to view is displayed.



"TV Out" at the iPod's "Slide show Settings" or "Video Settings" must be set to "On" in order to display the iPod's photo data or videos on the monitor. For details, see the iPod's operating instructions.

NOTE

Video may not be output, depending on the combination of ASD-1R or ASD-11R DENON control dock for iPod and iPod.

Playing Components

Symbols used to indicate buttons in this manual

- Button located on both the main unit and the remote control unit → **BUTTON**
- Button only on the main unit → **<BUTTON>**
- Button only on the remote control unit → **[BUTTON]**

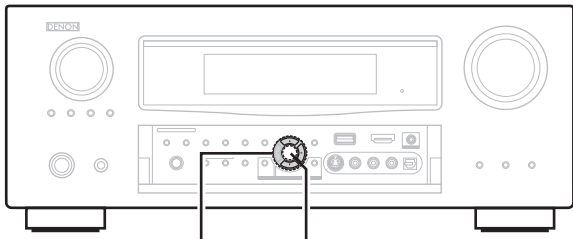

ENTER

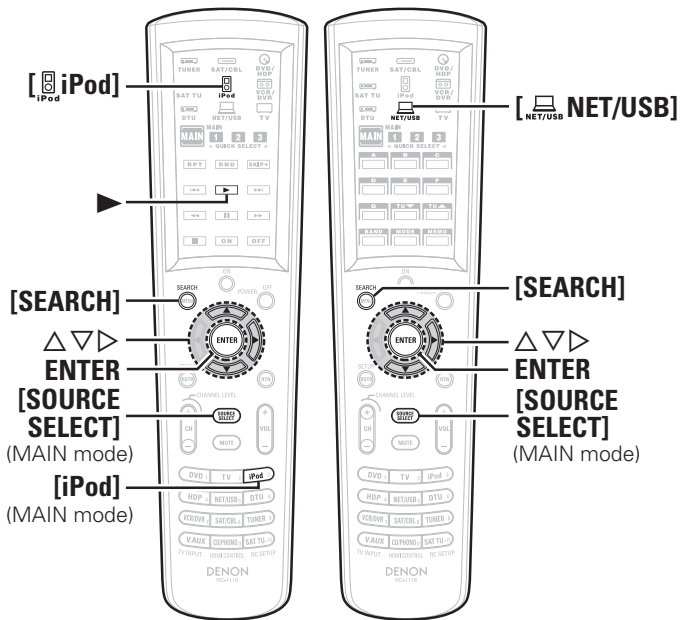

※ When no control dock for iPod is connected, this operation is also possible in the "iPod" mode.

Playing an iPod® Connected Directly to the AVR-4310CI's USB Port

- Music stored on an iPod can be played on the AVR-4310CI when the AVR-4310CI and iPod are connected by USB cable.
- The AVR-4310CI supports the audio on iPods of generations 5 and later and iPod nano, iPod classic and iPod touch (not iPod shuffle). For some models, however, some of the functions may be restricted.
- The operation may not work properly if the iPod's software is old. Be sure to use the latest version of iPod software.
- With iPods, non-copyrighted material and material for which duplication and playback is authorized by law can be duplicated and played by individuals for their personal enjoyment. Infringement of copyrights is prohibited by law.
- Note that DENON will accept no responsibility whatsoever for any problems arising with the data on an iPod when using the AVR-4310CI in conjunction with the iPod.

Listening to music on an iPod®

- 1** Connect the iPod® to the AVR-4310CI's USB port using the USB cable included with the iPod (☞ page 21 "USB Port").
- 2** Turn the AVR-4310CI power on. (☞ page 24 "Turning the Power On")
- 3** Press **[SOURCE SELECT]** to display the GUI Source Select menu, then select "**USB**" (☞ page 27).

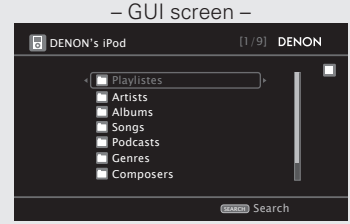

- ※ When the iPod is connected directly to the USB port, menus under "Music" are displayed.
- ※ If the screens above are not displayed, the iPod may not be properly connected. Try connecting again.
- ※ When no control dock for iPod is connected, this can also be selected by pressing **[iPod]**.

4 Set the main remote control unit to the "NET/USB" mode (☞ page 89 "Operating the Main Remote Control Unit").

※ When no control dock for iPod is connected, this operation is also possible in the "iPod" mode.

5 Press **[SEARCH]** and hold it down for a 2 seconds or more to select the display mode.

※ There are two modes for display the contents recorded on the iPod.

Browse mode :

This is the mode for displaying the iPod information on the GUI screen to operate the iPod. In this mode, you cannot perform operations directly on the iPod itself.

※ With the AVR-4310CI's display, only English letters and numbers and certain symbols can be displayed. Any characters that cannot be displayed are replaced with ". (period)".

Remote mode :

This is the mode for performing operations directly on the iPod itself while watching the screen displayed on the iPod. In this mode, the GUI screen is not displayed.

※ "Remote iPod" appears on the main unit's display.
 ※ The Remote mode is not supported on 5th generation iPods or iPod nanos.

Display mode		Browse mode	Remote mode
Playable files	Audio file	○	○
	Picture file	×	×
	Movie file	×	×*
Active buttons	Main remote control unit (AVR-4310CI)	○	○
	iPod®	×	○

* : Only the sound is played.

6 Use **△▽** to select the item, then press **ENTER** or **▷** to select the file to be played.

7 Press **▶**, **ENTER** or **▷**.
 Playback starts.

8 Adjust the items below.

- Adjusting the master volume** (🔊 page 70)
 - Selecting the surround mode** (🔊 page 71)
 - Adjusting the Sound and Picture Quality** (🔊 page 73)
- To stop** (🔊 page 70)
 - Stopping playback temporarily** (🔊 page 70)
 - Fast-forwarding or fast-reversing** (🔊 page 70)
 - To cue to the beginning of a track** (🔊 page 70)
 - Playing repeatedly** (🔊 page 70)
 - Playing in random order** (🔊 page 70)
 - Searching pages** (🔊 page 70)



- The Remote mode is not supported on 5th generation iPods or iPod nanos.
- Use the RESTORER mode to expand the low and high frequency components of compressed audio files and achieve a richer sound (🔊 page 77). The default setting is "Mode3".
- The title name, artist name and album name can be checked by pressing STATUS during playback.
- The time (default : 30 sec) for which the GUI menus are displayed can be set at "GUI" – "iPod" (🔊 page 43). Press △▽◀▶ to return to the original screen.

NOTE

- Depending on the type of iPod and the software version, some functions may not operate.
- DENON will accept no responsibility whatsoever for any loss of iPod data.



"Made for iPod" means that an electronic accessory has been designed to connect specifically to iPod and has been certified by the developer to meet Apple performance standards. Apple is not responsible for the operation of this device or its compliance with safety and regulatory standards. iPod is a trademark of Apple Inc., registered in the U.S. and other countries.

- ※ The iPod may only be used to copy or play contents that are not copyrighted or contents for which copying or playback is legally permitted for your private use as an individual. Be sure to comply with applicable copyright legislation.

Tuning in Radio Stations

Important Information

About SIRIUS XM Radio

To listen to Satellite Radio, you'll need to connect either a SIRIUS or XM Satellite Radio tuner (sold separately) to your satellite-ready receiver. Satellite Radio is available to residents of the US (except Alaska and Hawaii) and Canada.

Satellite Radio delivers a variety of commercial-free music from categories ranging from Pop, Rock, Country, R&B, Dance, Jazz, Classical and many more plus coverage of all the top professional and college sports including play by play games from select leagues and teams. Additional programming includes expert sports talk, uncensored entertainment, comedy, family programming, local traffic and weather and news from your most trusted sources.

Whether you purchase a SIRIUS or XM tuner, you'll need to activate and subscribe to begin enjoying the service. Easy to follow installation and setup instructions are provided with the satellite tuners. Whichever service you choose, there are a variety of programming packages available, including the option of adding "The Best of SIRIUS" programming to your XM tuner or "The Best of XM" programming to your SIRIUS tuner, enabling you to enjoy the most popular programming among both services. The "Best of" packages are not available to SIRIUS or XM Canada subscribers at this time.

Family friendly packages are also available to restrict channels featuring content that may be inappropriate for children.

To subscribe to XM, U.S. customers should visit xmradio.com or call 1-800-XMRADIO (1-800-967-2346); Canadian customers should visit xmradio.ca or call XM Listener Care at 1-877-GETXMSR (1-877-438-9677).

To subscribe to SIRIUS, U.S. and Canadian customers can call 1-888-539-SIRI (1-888-539-7474) or visit sirius.com (US) or siriuscanada.ca (Canada).

SIRIUS XM Radio Legal

SIRIUS, XM and all related marks and logos are trademarks of Sirius XM Radio Inc. and its subsidiaries. All other marks and logos are the property of their respective owners. All rights reserved. SIRIUS and XM subscriptions sold separately. Taxes and a one-time activation fee may apply. XM tuners and home docks or SIRIUS tuners (each sold separately) are required to receive the SIRIUS or XM satellite radio service. All programming and fees subject to change. It is prohibited to copy, decompile, disassemble, reverse engineer, hack, manipulate or otherwise make available any technology or software incorporated in receivers compatible with the SIRIUS or XM Satellite Radio Systems. **Service not available in Alaska and Hawaii.**

Using the HD Radio™ Receiver

HD radio stations offer higher sound quality than conventional FM/AM broadcasts. It is also possible to receive data services and select broadcasts from among up to eight multicast programs.

HD Radio technology provides higher quality sound than conventional broadcasts and allows reception of data services.

- FM sounds as sensational as CDs
- AM sounds as rich as analog FM stereo
- A variety of "data services", including text-based information, song title, artist name, album name, genre, etc. can be received.

Furthermore, in addition to conventional broadcasts, with HD Radio broadcasting it is possible to choose from up to 8 multicast programs.

For detailed information on HD Radio technology, please go to "www.ibiquity.com".



HD Radio™ technology manufactured under license from iBiquity Digital Corporation. iBiquity Digital, the HD Radio logo, and the HD logo are registered trademarks of iBiquity Digital Corporation. HD Radio™ is a trademark of iBiquity Digital Corporation. U.S. and Foreign Patents.

Symbols used to indicate buttons in this manual

- Button located on both the main unit and the remote control unit → **BUTTON**
- Button only on the main unit → **<BUTTON>**
- Button only on the remote control unit → **[BUTTON]**

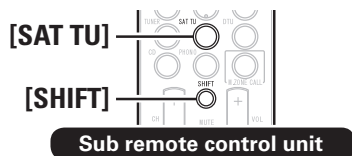
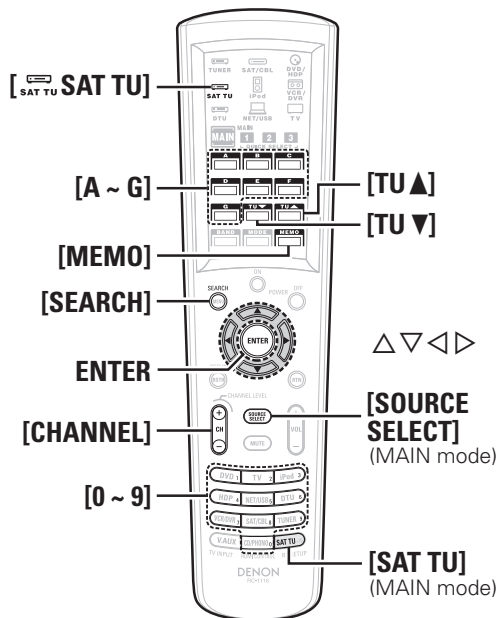
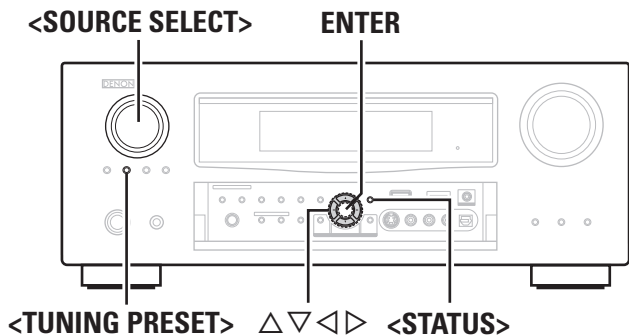

Listening to XM Satellite Radio

When operating XM with the AVR-4310CI via the main remote control unit or sub remote control unit, use **[SAT TU]**.
 Before operating, set to **[SAT TU]** operating mode.
[SAT TU] of **[SOURCE SELECT]** and **[SAT TU]** of **[DEVICE SELECT]** mode can use only either XM or SIRIUS. The default setting is for SIRIUS operation.

- 1 Set GUI menu “Option Setup” – “Remote (SIRIUS/XM)” (☞ page 44) to “SAT TU : XM”.
- 2 Press **[SOURCE SELECT]** to display the GUI Source Select menu, then select “(XM)” (☞ page 27).
The input source becomes that set in step 1.
- 3 Set the main remote control unit to the “SAT TU” mode (☞ page 89 “Operating the Main Remote Control Unit”).
You can then operate the input source you set in step 1.
- 4 Use **[TU ▲]** or **[TU ▼]** to select the channel.
When the channel is tuned in, the name of the song and artist are displayed.
- 5 Adjust the items below.
 - ☐ Adjusting the master volume (☞ page 70)
 - ☐ Selecting the surround mode (☞ page 71)
 - ☐ Adjusting the Sound and Picture Quality (☞ page 73)



- The channel switches continuously when **[TU ▲]** or **[TU ▼]** is pressed and held.
- The artist name, song title, category and reception level can be checked by pressing **<STATUS>**.
- The time (default : 30 sec) for which the GUI menus are displayed can be set “GUI” – “Tuner” (☞ page 43). Press **△▽◁▷** to return to the original screen.

Checking the XM Signal Strength and Radio ID

1 Press **<STATUS>** until “SIGNAL” appears on the display.

The display will switch as shown below, depending on the reception conditions.

Display	GUI	Status
GOOD	📶	Signal strength is good
MARGINAL	📶	Signal strength is marginal
WEAK	📶	Signal strength is weak
NO	📶	No signal

2 Adjust the position of the antenna until “SIGNAL: GOOD” is shown on the display.

3 Press **<STATUS>** until the channel (example: “XM001”) is displayed.

4 Press **[TU ▲]** or **[TU ▼]** and select channel 0 (XM000).
The radio ID is shown on the display.

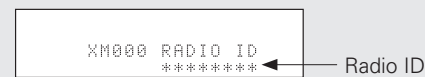

The strength of both the XM satellite and terrestrial signals can be checked “Antenna Aiming” (☞ page 52).

Presetting Radio Channels (Preset Memory)

Your favorite broadcast channels can be preset so that you can tune them in easily. Up to 56 stations can be preset.

1 Tune in the broadcast channel you want to preset.

2 Press [MEMO].

3 Press [A ~ G] to select the block in which the channel is to be preset, then press [CHANNEL] or [1 ~ 8] to select the preset number.

※ The memory block can also be selected by pressing [SHIFT] on the sub-remote unit.

4 Press [MEMO] again to complete the setting.



To preset other channels, repeat steps 1 to 4.

NOTE

Preset channels are erased by overwriting them.

Listening to Preset Channels

1 Press [A ~ G] to select the memory block.

2 Press [CHANNEL] or [1 ~ 8] to select the desired preset channel.



You can also operate via the main unit. In this case, perform the following operations.

Press <TUNING PRESET>, then turn <SOURCE SELECT> to select the preset radio channel.

Searching Categories

1 Press <◀▶>.



2 Use <◀▶> to select the category, to use <△▽> to select the desired channel.

Accessing XM Radio Channels Directly

1 Press [SEARCH].

2 Press [0 ~ 9] to input the channel.
Example: Accessing channel "XM123": Press [1], [2] and [3].

※ If no button is pressed within several seconds, the channel automatically switches to the one whose number has been input.

3 Press ENTER to set that channel.
 Reception switches to the selected channel.



- "LOADING" is displayed while channels or data are being received.
- Refer to "Troubleshooting" – "XM Satellite Radio" (page 111) regarding other messages.

Listening to SIRIUS Satellite Radio

When operating SIRIUS with the AVR-4310CI via the main remote control unit or sub remote control unit, use [SAT TU].

Before operating, set to [SAT TU] operating mode.

[SAT TU] of [SOURCE SELECT] and [SAT TU] of [DEVICE SELECT] mode can use only either XM or SIRIUS. The default setting is for SIRIUS operation.

1 Set GUI menu "Option Setup" – "Remote (SIRIUS/XM)" (page 44) to "SAT TU : SIRIUS".

2 Press [SOURCE SELECT] to display the GUI Source Select menu, then select "SIRIUS XM" (page 27).
 The input source becomes that set in step 1.

3 Set the main remote control unit to the "SAT TU" mode (page 89 "Operating the Main Remote Control Unit").
 You can then operate the input source you set in step 1.

4 Use [TU ▲] or [TU ▼] to select the channel.
 When the channel is tuned in, the name of the song and artist are displayed.

5 Adjust the items below.

- Adjusting the master volume (page 70)
- Selecting the surround mode (page 71)
- Adjusting the Sound and Picture Quality (page 73)



- The channel switches continuously when [TU ▲] or [TU ▼] is pressed and held.
- The song title, artist name, composer name, category and reception level can be checked by pressing <STATUS>.
- The time (default : 30 sec) for which the GUI menu are displayed can be set "GUI" – "Tuner" (page 43). Press <△▽◀▶> to return to the original screen.

Hand icon Symbols used to indicate buttons in this manual

- Button located on both the main unit and the remote control unit → **BUTTON**
- Button only on the main unit → **<BUTTON>**
- Button only on the remote control unit → **[BUTTON]**

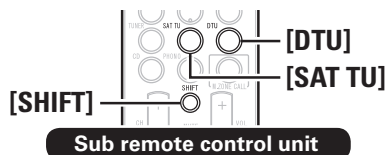
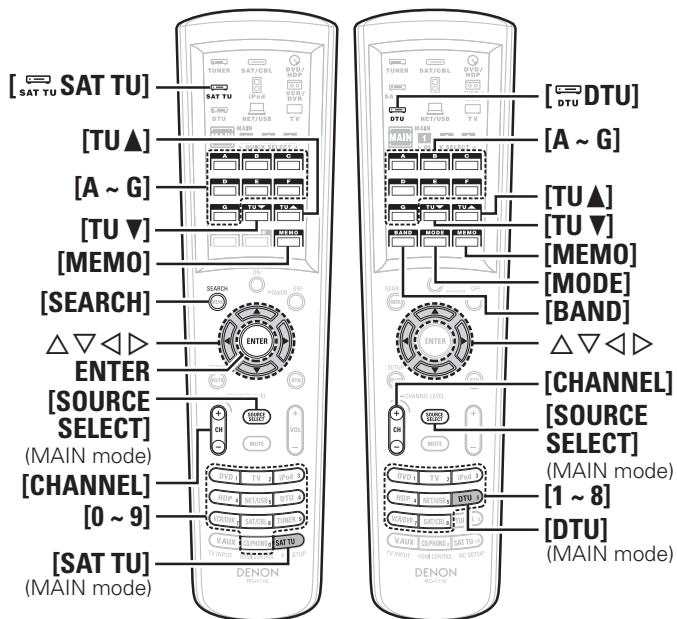
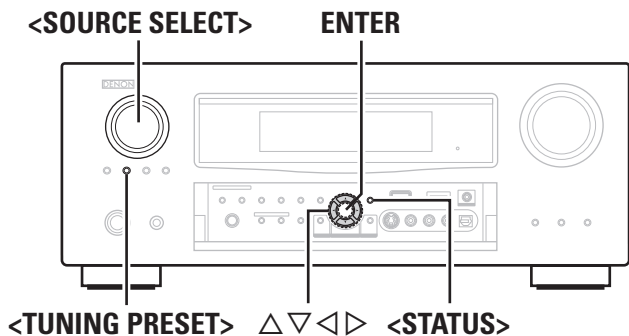

Checking the SIRIUS Signal Strength and Radio ID

1 Press **<STATUS>** until “SIGNAL” appears on the display.

The display will switch as shown below, depending on the reception conditions.

Display	Status
EXCELLENT	Signal strength is excellent
GOOD	Signal strength is good
WEAK	Signal strength is weak
NO SIGNAL	No signal

2 Adjust the position of the antenna until “SIGNAL: EXCELLENT” is shown on the display.

3 Press **<STATUS>** until the channel (example: “SR001”) is displayed.

4 Press **[TU ▲]** or **[TU ▼]** and select channel 0 (SR000). Channel No. and Sirius ID are alternately shown on the display.

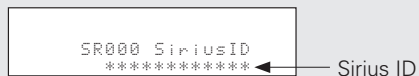

※ Write your own SIRIUS ID for storage use.

Sirius ID : _____



The strength of both the SIRIUS satellite and terrestrial signals can be checked “Antenna Aiming” (page 52).

Presetting Radio Channels (Preset Memory)

Your favorite broadcast channels can be preset so that you can tune them in easily. Up to 56 channels can be preset.

1 Tune in the broadcast channel you want to preset.

2 Press **[MEMO]**.

3 Press **[A ~ G]** to select the block in which the channel is to be preset, then press **[CHANNEL]** or **[1 ~ 8]** to select the preset number.

※ The memory block can also be selected by pressing **[SHIFT]** on the sub-remote unit.

4 Press **[MEMO]** again to complete the setting.



To preset other channels, repeat steps 1 to 4.

NOTE

Preset channels are erased by overwriting them.

Listening to Preset Channels

Press **[CHANNEL]** to select the desired preset channel, then press **ENTER**.

※ Selection is still possible if you press **[1 ~ 8]** after pressing **[A ~ G]**.



You can also operate via the main unit. In this case, perform the following operations.

Press **<TUNING PRESET>**, then turn **<SOURCE SELECT>** to select the preset radio channel.

Searching Categories

1 Press ◀▶.



2 Use ◀▶ to select the category, to use ▲▼ to select the desired channel.

Accessing SIRIUS Satellite Radio Channels Directly

1 Press [SEARCH].

2 Press [0 ~ 9] to input the channel.
Example: Accessing channel “SR123”: Press [1], [2] and [3].

※ If no button is pressed within several seconds, the channel automatically switches to the one whose number has been input.

3 Press ENTER to set that channel.
Reception switches to the selected channel.



- “UPDATING” is displayed while the encoding code is being updated.
- “SIRIUS UPDATING” is displayed when updating SIRIUS tuner firmware.
- Refer to “Troubleshooting” – “SIRIUS Satellite Radio” (page 111) regarding other messages.

Parental Lock

1 Tune to the channel you want to lock.

2 Press ENTER for at least 3 seconds.
“Enter Lock Code” is displayed.

3 Enter the 4-digit lock code using ▲▼◀▶.
When you enter the correct code, the corresponding channel is locked.

4 Press ENTER.



- Channels under Parental Lock cannot be tuned in by performing Tuning Up/Down or by category search.
- Channels stored in preset memory can be tuned in by the preset channel select operation, even if Parental Lock is applied.
- When a channel to which Parental Lock is applied is being played, Parental Lock for that channel is cancelled by performing step 2.
- See “Edit Lock Cord” (page 52) for the method of changing Parental Lock Cord.
- You can also set “Parental Lock” (page 52) from the menu.

Listening to HD Radio Stations

1 Press [SOURCE SELECT] to display the GUI Source Select menu, then select “ Radio” (page 27).

2 Set the main remote control unit to the “DTU” mode (page 89 “Operating the Main Remote Control Unit”).

3 Press [BAND] to select “FM” or “AM”.

4 Tune in the desired broadcast station.

① To tune in automatically (Auto Tuning)

Press [MODE] to select “HD-AUTO” or “AUTO”, then use [TU ▲] or [TU ▼] to select the station you want to hear.

- The “HD” indicator lights on the display when an HD Radio station is tuned in.
- When “HD-AUTO” (tuning mode) is selected, only HD Radio stations are tuned in.
- If “AUTO” (tuning mode) is selected, both HD Radio and analog stations are tuned in.

② To tune in manually (Manual Tuning)

Press [MODE] to select “MANUAL”, then use [TU ▲] or [TU ▼].

5 Adjust the items below.

- Adjusting the master volume (page 70)
- Selecting the surround mode (page 71)
- Adjusting the Sound and Picture Quality (page 73)



- If the desired station cannot be tuned in with auto tuning, tune it in manually.
- When tuning in stations manually, press and hold [TU ▲] or [TU ▼] to change frequencies continuously.
- The time (default : 30 sec) for which the GUI menu is displayed can be set “GUI” - “Tuner” (page 43). Press ▲▼◀▶ to return to the original screen.

Selecting Audio Programs

HD Radio includes up to 9 audio programs (HD1 to HD8 and Analog). The different audio programs also have data programs.

Press ▲▼ to select the audio program.

If the station you are listening to has multiple audio programs, “HD1” is indicated on the display. If it only has one audio program, “HD” is indicated.

Presetting Radio Stations (Preset Memory)

Your favorite broadcast stations can be preset so that you can tune them in easily. Up to 56 stations can be preset.

1 Tune in the broadcast station you want to preset.

2 Press [MEMO].

3 Press [A ~ G] to select the block in which the channel is to be preset, then press [CHANNEL] or [1 ~ 8] to select the preset number.

※ The memory block can also be selected by pressing [SHIFT] on the sub remote control unit.

4 Press [MEMO] again to complete the setting.



- To preset other stations, repeat steps 1 to 4.
- Multicasts can also be preset.
- Stations can be preset automatically at “Auto Preset” (page 51).

NOTE

Preset stations are erased by overwriting them.

Symbols used to indicate buttons in this manual

- Button located on both the main unit and the remote control unit → **BUTTON**
- Button only on the main unit → **<BUTTON>**
- Button only on the remote control unit → **[BUTTON]**

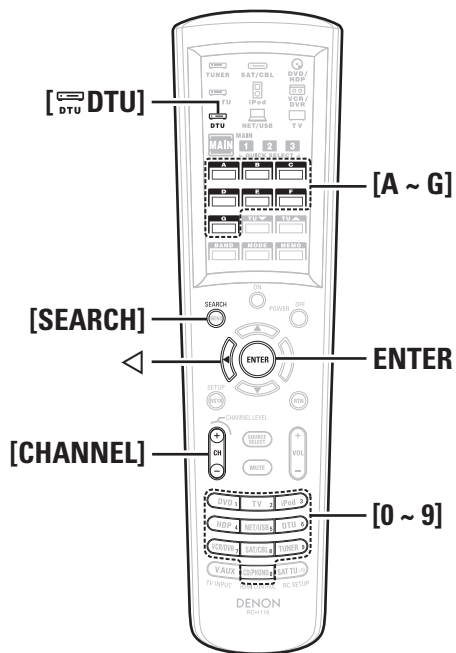
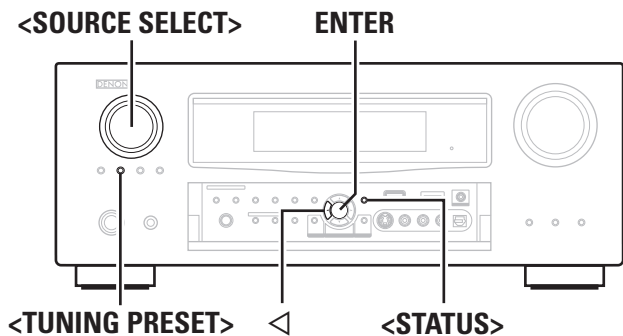

Listening to Preset Stations

- 1 Press **[A ~ G]** to select the memory block (A to G).
- 2 Press **[CHANNEL]** or **[1 ~ 8]** to select the desired preset station.



- You can also operate via the main unit. In this case, perform the following operations. Press **<TUNING PRESET>**, then turn **<SOURCE SELECT>** to select the preset radio station.
- If an audio program from HD2 to HD8 has been interrupted or if a program is called out using the preset buttons after it has been interrupted, HD1 is automatically selected after about 20 seconds.

Default settings

Tuner presets	
A1 ~ A8	87.5 / 87.9 / 89.1 / 93.3 / 97.9 / 98.1 / 98.9 / 100.1 MHz
B1 ~ B8	101.9 / 102.7 / 107.9 / 90.1 / 90.1 / 90.1 / 90.1 / 90.1 MHz
C1 ~ C8	530 / 600 / 930 / 1000 / 1120 / 1210 / 1400 / 1710 kHz
D1 ~ D8	90.1 MHz
E1 ~ E8	90.1 MHz
F1 ~ F8	90.1 MHz
G1 ~ G8	90.1 MHz

Direct Frequency Tuning

You can enter the receiving frequency directly to tune in.

- 1 Press **[SEARCH]**.
- 2 Input frequencies by means of **[0 ~ 9]**.
 ※ If **<** is pressed, the immediately preceding input is cancelled.
- 3 When setting is completed, press **ENTER**.
 The preset frequency is tuned in.

Check the HD Radio Reception Information

Press **<STATUS>** while an HD Radio broadcast is being received.

The current reception information is shown on the display.

- ① Normal
↓
- ② Frequency / Signal strength
↓
- ③ Long station name / Program and Program type
↓
- ④ Title name / Artist name
↓
- ⑤ Album name / Genre name

NOTE

If the station signal weakens while receiving a digital broadcast (while "HD" and text is displayed), the mode automatically switches to the analog reception mode (the reception frequency is displayed). Because of this, the "HD" indicator and text may flicker if the station signal level is weak and unstable.

Playing Network Audio, USB Memory Devices

This procedure can be used to play Internet radio stations or music or still picture (JPEG) files stored on a computer or USB memory device.

Important Information

About the Internet Radio Function

- Internet radio refers to radio broadcasts distributed over the Internet. Internet radio stations from around the world can be tuned in. The AVR-4310CI is equipped with the following Internet radio functions:
 - Stations can be selected by genre and region.
 - Up to 56 Internet radio stations can be preset.
 - Internet radio stations in MP3 and WMA (Windows Media Audio) format can be listened to.
 - Your favorite radio stations can be registered by accessing an exclusive DENON Internet radio URL from a Web browser on a computer.
- ※ The function is managed for individual users, so you must provide your MAC or e-mail address.
Exclusive URL: <http://www.radiodenon.com>
- ※ The radio station database service may be suspended without notice.
- The AVR-4310CI's Internet radio station list is created using a radio station database service (vTuner). This database service provides a list edited and created for the AVR-4310CI.

Media Player

This function lets you play music files and playlists (m3u, wpl) stored on a computer (media server) connected to the AVR-4310CI via a network.

With the AVR-4310CI's network audio playback function, connection to the server is possible using one of the technologies below.

- Windows Media Player Network Sharing Service
- Windows Media DRM10

❑ Album Art Function

When a WMA (Windows Media Audio), MP3 or MPEG-4 AAC file includes album art data, the album art can be displayed while the music files are playing.



For music files in WMA (Windows Media Audio) format, the album art is only played when using Windows Media Player ver. 11.

❑ Slide Show Function

Still picture (JPEG) files stored in folders on a media server can be played as slide shows. The time for which each picture is displayed can be set.



When still picture (JPEG) files are played on the AVR-4310CI, they are played in the direction in which they are stored in the folder, so store in them in the direction in which you want them to play.

USB Memory Devices

A USB memory device can be connected to the AVR-4310CI's USB port to play music and still picture (JPEG) files stored on the USB memory device.

Also, files stored on an iPod can be played when the iPod is connected directly to the AVR-4310CI's USB port. See "Playing an iPod® Connected Directly to the AVR-4310CI's USB Port" (page 55).

- Only USB memory devices conforming to mass storage class and MTP (Media Transfer Protocol) standards can be played on the AVR-4310CI.
- The AVR-4310CI is compatible with USB memory devices in "FAT16" or "FAT32" format.

❑ Album Art Function

When an MP3 music file includes album art data, the album art can be displayed while playing the file.

❑ Slide Show Function

Still picture (JPEG) files stored on USB memory devices can be played as slide shows.

The time for which each picture is displayed can be set.



When still picture (JPEG) files are played on the AVR-4310CI, they are played in the direction in which they are stored in the folder, so store in them in the direction in which you want them to play.

[Compatible formats]

	Internet radio	Media server * 1	USB memory devices * 1
WMA (Windows Media Audio)	○	○	○ * 3
MP3 (MPEG-1 Audio Layer-3)	○	○	○
WAV	–	○	○
MPEG-4 AAC	–	○ * 2	○ * 2
FLAC (Free Lossless Audio Codec)	–	○	○
JPEG	–	○	○

A server or server software compatible with distribution in the corresponding formats is required to play music files via a network.

* 1 : Media server and USB

- The AVR-4310CI is compatible with MP3 ID3-Tag (Ver. 2) standards.
- The AVR-4310CI is compatible with WMA META tags.
- WAV format Quantization bit rate: 16 bits.

* 2 : Only files that are not protected by copyright can be played on the AVR-4310CI.

Contents downloaded from pay sites on the Internet are copyright protected. Also, files encoded in WMA format when ripped from a CD, etc., on a computer may be copyright protected, depending on the computer's settings.

* 3 : Copyright-protected files can be played on certain portable players compatible with MTP.

Playing Network Audio, USB Memory Devices

Symbols used to indicate buttons in this manual

- Button located on both the main unit and the remote control unit → **BUTTON**
- Button only on the main unit → **<BUTTON>**
- Button only on the remote control unit → **[BUTTON]**

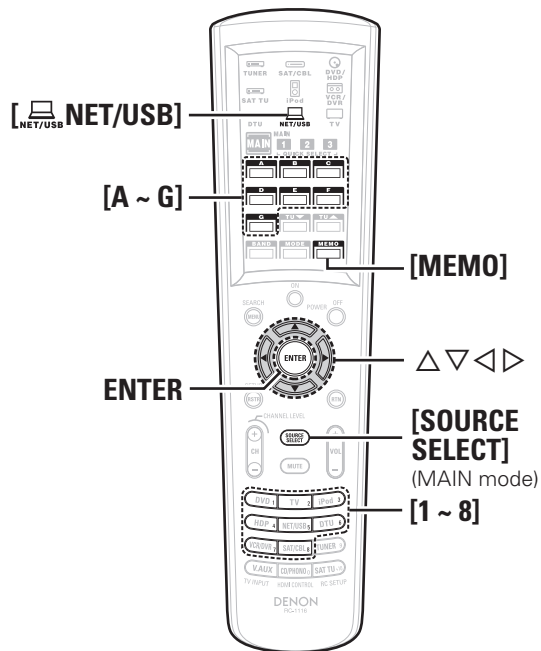
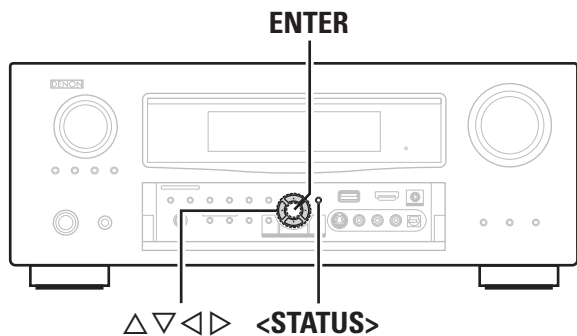

[Compatible formats]

	Sampling frequency	Bit rate	Extension
WMA (Windows Media Audio)	32/44.1/48kHz	48 ~ 192kbps	.wma
MP3 (MPEG-1 Audio Layer-3)	32/44.1/48kHz	32 ~ 320kbps	.mp3
WAV	32/44.1/48kHz	-	.wav
MPEG-4 AAC	32/44.1/48kHz	16 ~ 320kbps	.aac/ .m4a/ .mp4
FLAC (Free Lossless Audio Codec)	32/44.1/48kHz	-	.flac

About Napster

Napster is a monthly subscription music distribution service provided by Napster. This service allows users to download and play pieces of music they want to hear on the AVR-4310CI. Before you can use Napster, you will need to visit the Napster website on your PC to create an account and register as a member. For details, access the following site:

http://www.napster.com/choose/index_default.html

About Rhapsody

Rhapsody is a paid music broadcast service of RealNetworks. When you first listen to Rhapsody, it is necessary to subscribe to a Rhapsody account at the Rhapsody homepage by your PC and register this machine. See the Rhapsody homepage for details.

www.rhapsody.com/denon

Listening to Internet Radio

- Playback preparation.**
 - Check the network environment, then turn on the AVR-4310CI's power (☞ page 23 "Connecting to a Home Network (LAN)").
 - If settings are required, make the "Network Connecting" (☞ page 39).
- Press **[SOURCE SELECT]** to display the GUI Source Select menu, then select "🌐" (☞ page 27).
- Set the main remote control unit to the "NET/USB" mode (☞ page 89 "Operating the Main Remote Control Unit").
- Press Δ ∇ to select the item you want to play, then press **ENTER** or \triangleright .
The station list is displayed.
- Press Δ ∇ to select the station, then press **ENTER** or \triangleright .
Playback starts once buffering reaches "100%".
- Adjust the items below.**
 - Adjusting the master volume** (☞ page 70)
 - Selecting the surround mode** (☞ page 71)
 - Adjusting the Sound and Picture Quality** (☞ page 73)

- To stop** (☞ page 70)
- Searching up or down pages** (☞ page 70)
- Searching by first letter** (☞ page 70)



- There are many Internet radio stations on the Internet, and the quality of the programs they broadcast as well as the bit rate of the tracks varies widely. Generally, the higher the bit rate, the higher the sound quality, but depending on the communication lines and server traffic, the music or audio signals being streamed may be interrupted. Inversely, lower bit rates mean a lower sound quality but less tendency for the sound to be interrupted.
- “Server Full” or “Connection Down” is displayed if the station is busy or not broadcasting.
- On the AVR-4310CI, folder and file names can be displayed as titles. Any characters that cannot be displayed are replaced with “. (period)”.
- Use the RESTORER mode to expand the low and high frequency components of compressed audio files and achieve a richer sound “RESTORER” (page 77). The default setting is “Mode 3”.
- When <STATUS> is pressed, the display can be switched between the title name and radio station name.
- The time (default : 30 sec) for which the GUI menu are displayed can be set at GUI menu “GUI” – “NET/USB” (page 43). Press $\Delta \nabla \triangleleft \triangleright$ to return to the original screen.

Recently Played Internet Radio Stations

Recently played internet radio stations can be selected from “Recently Played”.

Up to 20 stations stored in “Recently Played”.

- 1 Press $\Delta \nabla$ to select “Recently Played”, then press **ENTER** or \triangleright .
- 2 Press $\Delta \nabla$ to select the item you want to play, then press **ENTER** or \triangleright .

Search Stations by Keyword (Alphabetic Strings)

- 1 Press $\Delta \nabla$ to select “Search by Keyword”, then press **ENTER** or \triangleright .

The search display appear.

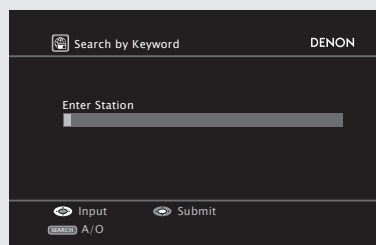

- 2 Enter the characters, then press **ENTER**.

Presetting Internet Radio Stations

Preset Internet radio stations can be selected directly.

- 1 While the Internet radio station you want to preset is playing, press **[MEMO]**.
- 2 Press $\Delta \nabla$ to select “Preset”, then press **ENTER**.
- 3 Press **[A ~ G]**, then press **[1 ~ 8]** to select the desired preset number.
- 4 Press **[MEMO]** again to complete the setting.
The Internet radio station is now preset.

NOTE

If registered at a number that has already been preset, the previously registered setting is cleared.

Listening to Preset Internet Radio Stations

After pressing **[A ~ G]**, press **[1 ~ 8]** to select the registered preset number.

The AVR-4310CI automatically connects to the Internet and playback begins.

Registering Internet Radio Stations as Your Favorites

Favorites are listed at the top of the menu screen, so when a station is registered as a favorite it can be tuned in easily.

- 1 Press **[MEMO]** while the Internet radio station you want to register is playing.
- 2 Press $\Delta \nabla$ to select “Favorites”, then press **ENTER**.
- 3 Press \triangleleft to select “Yes”.

The Internet radio station is registered.

※ If you do not want to register it, press \triangleright .

Listening to Internet Radio Stations Registered in Your Favorites

- 1 Press **[SOURCE SELECT]** to display the GUI Source Select menu, then select “

Clearing Internet Radio Stations from Your Favorites

- 1 Press **[SOURCE SELECT]** to display the GUI Source Select menu, then select “

The selected Internet radio station is cleared.

※ To cancel the operation without clearing the station, press \triangleright .

Playing Network Audio, USB Memory Devices

Symbols used to indicate buttons in this manual

- Button located on both the main unit and the remote control unit → **BUTTON**
- Button only on the main unit → **<BUTTON>**
- Button only on the remote control unit → **[BUTTON]**

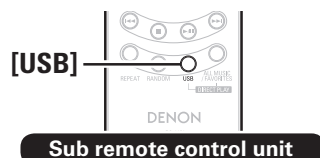
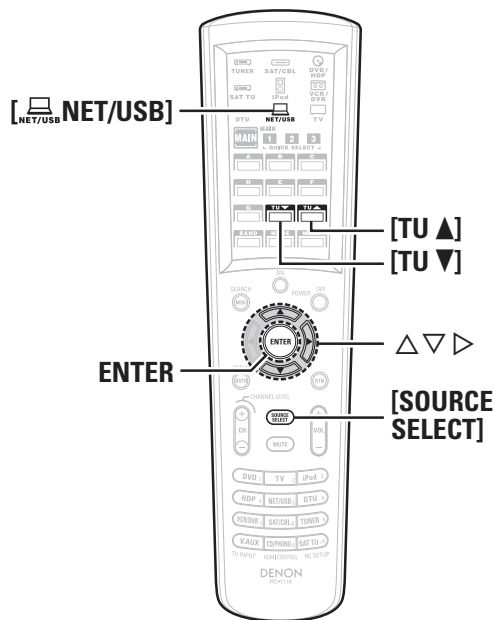
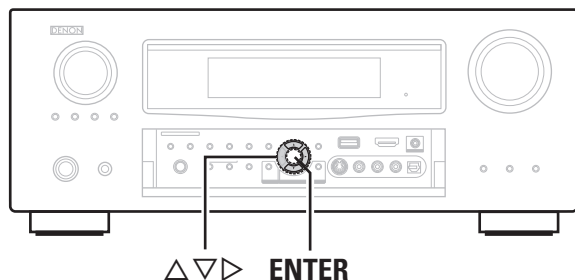

Sub remote control unit

Playing Files Stored on a Computer

Use this procedure to play music files, image files or playlists.

1 Playback preparation.

- ① Check the network environment, then turn on the AVR-4310CI's power (☞ page 23 "Connecting to a Home Network (LAN)").
- ② If settings are required, make the "Network Connecting" (☞ page 39).
- ③ Prepare the computer (☞ Computer's operating instructions).

2 Press **[SOURCE SELECT]** to display the GUI Source Select menu, then select "**[FILE]**" (☞ page 27).

3 Switching the main remote control unit to the "NET/USB" mode (☞ page 89 "Operating the Main Remote Control Unit").

4 Use **△▽** to select the server including the file to be played, then press **ENTER** or **▷**.

5 Press **△▽** to select the search item or folder, then press **ENTER** or **▷**.

6 Press **△▽** to select the file, then press **ENTER** or **▷**. Playback starts once buffering reaches "100%".

7 Adjust the items below.

- Adjusting the master volume** (☞ page 70)
- Selecting the surround mode** (☞ page 71)
- Adjusting the Sound and Picture Quality** (☞ page 73)

To stop (☞ page 70)

Stopping playback temporarily (☞ page 70)

Selecting tracks (☞ page 70)

Playing repeatedly (☞ page 70)

Playing in random order (☞ page 70)

Searching pages (☞ page 70)

Searching by first letter (☞ page 70)



• When playing still picture (JPEG) files, files can also be selected using the operation described below.

During playback, either press **[TU ▲]** (previous file) or **[TU ▼]** (next file).

• Connections to the required system and specific settings must be made in order to play music files (☞ page 23).

• Before starting, you must launch the computer's server software and set the files as server contents. For details, see the operating instructions of your server software.

• Depending on the size of the still picture (JPEG) file, some time may be required for the file to be displayed.

• The order in which the tracks/files are displayed depends on the server specifications. If due to the server specifications the tracks/files are not displayed in alphabetical order, searching by the first letter may not work properly.

• WMA Lossless files can be played when using a server supporting transcoding, such as Windows Media Player Ver. 11.

• Use the RESTORER mode to expand the low and high frequency components of compressed audio files and achieve a richer sound. The default setting is "Mode3".

• The time (default : 30 sec) for which the GUI menus are displayed can be set at "GUI" - "NET/USB".

• Use **<STATUS>** to switch between displaying the title name, artist name or album name.

Playing files that have been Preset or Registered in Your Favorites

Files can be preset, registered in your favorites and played using the same operations as for Internet radio stations (☞ page 64).

NOTE

• Presettings are erased by overwriting them.

• When the operation described below is performed, the media server's database is updated and it may no longer be possible to play preset or favorite music files.

• When you quit the media server and then restart it.

• When music files are deleted or added on the media server.

• When using an ESCIENT server, place "ESCIENT" before the server name.

Playing Files Stored on USB Memory Devices

Only USB memory devices conforming to mass storage class and MTP (Media Transfer Protocol) standards can be played on the AVR-4310CI.

1 Playback preparation.

- ① At "USB Select" (☞ page 51), select the USB port to be used.
- ② Connect the USB memory device to the USB port set in ①.

2 Press [SOURCE SELECT] to display the GUI Source Select menu, then select "USB" (☞ page 27).

3 Set the main remote control unit to the "NET/USB" mode (☞ page 89 "Operating the Main Remote Control Unit").

4 Press $\Delta \nabla$ to select the search item or folder, then press ENTER or \triangleright .

5 Press $\Delta \nabla$ to select the file, then press ENTER or \triangleright . Playback starts once buffering reaches "100%".

6 Adjust the items below.

- Adjusting the master volume (☞ page 70)
- Selecting the surround mode (☞ page 71)
- Adjusting the Sound and Picture Quality (☞ page 73)

To stop (☞ page 70)

Stopping playback temporarily (☞ page 70)

Selecting tracks (☞ page 70)

Playing repeatedly (☞ page 70)

Playing in random order (☞ page 70)

Searching pages (☞ page 70)

Searching by first letter (☞ page 70)



- By default, the front panel's USB port will be used.
- Depending on the size of the still picture (JPEG) file, some time may be required for the file to be displayed.
- During playback of still picture (JPEG) files, the files can also be switched using [TU ▲] (previous file) and [TU ▼] (next file).
- If the USB memory device is divided into multiple partitions, only the top partition can be selected.
- The AVR-4310CI is compatible with MP3 files conforming to "MPEG-1 Audio Layer-3" standards.
- When [USB] on the sub remote control unit is pressed, playback starts from the first file stored on the USB memory device.

NOTE

- The AVR-4310CI is equipped with two USB ports, one each on the front and rear panels. It is not possible to use the set with USB memory devices connected to both the ports at the same time. Select the USB port you want to use at "USB Select" (☞ page 51).
- DENON will accept no responsibility whatsoever for any loss or damage to data on USB memory devices when using the USB memory device connected to the AVR-4310CI.
- USB memory devices will not work via a USB hub.
- DENON does not guarantee that all USB memory devices will operate or receive power. When using a portable USB connection type HDD of the kind to which an AC adapter can be connected to supply power, use the AC adapter.
- It is not possible to connect and use a computer via the AVR-4310CI's USB port using a USB cable.
- The AVR-4310CI is not compatible with the iPod shuffle.

Listening to Napster

1 Playback preparation.

- ① Check the network environment, then turn on the AVR-4310CI's power (☞ page 23 "Connecting to a Home Network (LAN)").
- ② If settings are required, make the "Network Connecting" (☞ page 39).

2 Press [SOURCE SELECT] to display the GUI Source Select menu, then select "Net" (☞ page 27).

3 Set the main remote control unit to the "NET/USB" mode (☞ page 89 "Operating the Main Remote Control Unit").

4 Use $\Delta \nabla \triangleright$ to input "Username" and "Password".

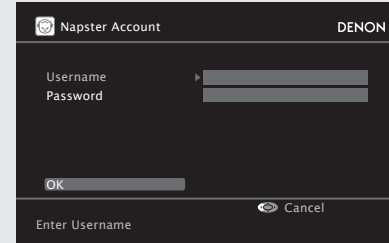

5 After inputting the "Username" and "Password", select "OK", then press ENTER.

If the "Username" and "Password" match, the top menu for Napster is displayed.

Username :

[Input characters]

[Lower case characters] abcdefghijklmnopqrstuvwxyz
 [Upper case characters] ABCDEFGHIJKLMNOPQRSTUVWXYZ
 [Symbols] ! " \$ % & ' () * + , - . / : ; < = > ? @ [\] ^ _ ` { | } ~
 (Space)
 [Numbers] 0123456789

Password :

[Input characters]

[Lower case characters] abcdefghijklmnopqrstuvwxyz
 [Upper case characters] ABCDEFGHIJKLMNOPQRSTUVWXYZ
 [Symbols] ! " \$ % & ' () * + , - . / : ; < = > ? @ [\] ^ _ ` { | } ~
 (Space)
 [Numbers] 0123456789

6 Adjust the items below.

- Adjusting the master volume (☞ page 70)
- Selecting the surround mode (☞ page 71)
- Adjusting the Sound and Picture Quality (☞ page 73)

Search From Napster Menu

1 Use $\Delta \nabla$ to select search item or folder, then press ENTER or \triangleright .

2 Use $\Delta \nabla$ to select the track item, then press ENTER or \triangleright .

Playing Napster

Symbols used to indicate buttons in this manual

- Button located on both the main unit and the remote control unit → **BUTTON**
- Button only on the main unit → **<BUTTON>**
- Button only on the remote control unit → **[BUTTON]**

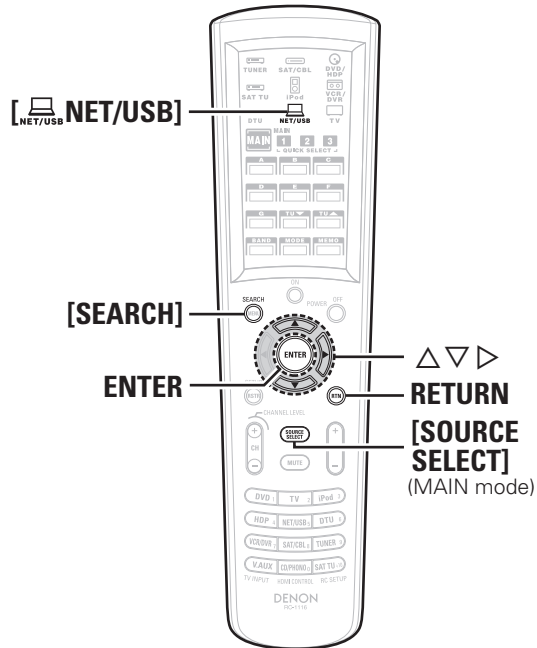
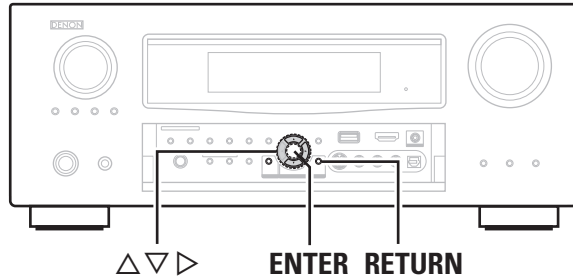

Enter a Character Search For the Track You Want to Listen to

1 Press **[SEARCH]**.

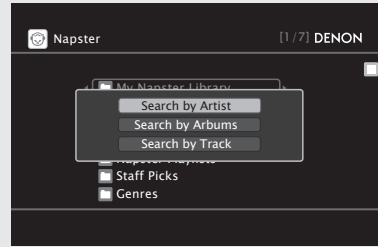

※ You can search by artist name, album name or track name.

2 Use Δ / ∇ to select the search item, then press **ENTER**.
The search display appears.

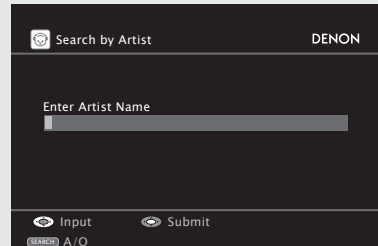

3 Enter the characters, then press **ENTER**.

Registering Tracks in My Napster Library

1 Press \triangleright while the track you wish to register is playing.

2 Select “Add to My Library”, then press **ENTER** or \triangleright .
The track is entered in the Library.

Listening to Tracks Registered In My Napster Library

1 Use Δ / ∇ to select “My Library”, then press **ENTER** or \triangleright .

2 Use Δ / ∇ to select the information or track, then press **ENTER**.
After selecting, the information is displayed.

To stop (page 70)

Selecting tracks (page 70)

Playing repeatedly (page 70)

Playing in random order (page 70)

Searching pages (page 70)



- Use the RESTORER mode to expand the low and high frequency components of compressed audio files and achieve a richer sound. The default setting is “Mode 3”.
- The time (default : 30 sec) for which the GUI menus are displayed can be set at “GUI” – “NET/USB” (page 43).
- Use **<STATUS>** to switch between displaying the title name, artist name or album name.

Listening to Rhapsody

1 Playback preparation.

- ① Check the network environment, then turn on the AVR-4310CI's power (☞ page 23 "Connecting to a Home Network (LAN)").
- ② If settings are required, make the "Network Connecting" (☞ page 39).

2 Press [SOURCE SELECT] to display the GUI Source Select menu, then select "R" (☞ page 27).

3 Switching the main remote control unit to the "NET/USB" mode (☞ page 89 "Operating the Main Remote Control Unit").

4 Use Δ / ∇ to select "Sign in your account", then press ENTER or \triangleright .

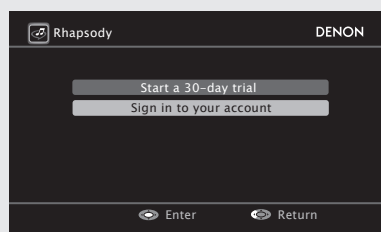

5 Enter Username and Password.

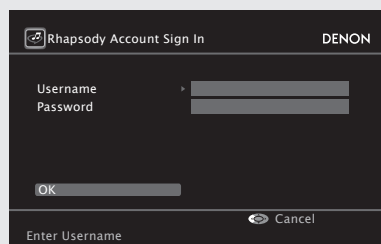

6 After inputting the "Username" and "Password", select "OK", then press ENTER.

If the "Username" and "Password" match, the top menu for Rhapsody is displayed.

Username : _____

[Input characters]

[Lower case characters] abcdefghijklmnopqrstuvwxyz
 [Upper case characters] ABCDEFGHIJKLMNOPQRSTUVWXYZ
 [Symbols] ! # " \$ % & ' () * + , - . / : ; < = > ? @ [\] ^ _ ` { | } ~
 (Space)
 [Numbers] 0123456789

Password : _____

[Input characters]

[Lower case characters] abcdefghijklmnopqrstuvwxyz
 [Upper case characters] ABCDEFGHIJKLMNOPQRSTUVWXYZ
 [Symbols] ! # " \$ % & ' () * + , - . / : ; < = > ? @ [\] ^ _ ` { | } ~
 (Space)
 [Numbers] 0123456789

7 Adjust the items below.

- Adjusting the master volume (☞ page 70)
- Selecting the surround mode (☞ page 71)
- Adjusting the Sound and Picture Quality (☞ page 73)

NOTE

- The password should be no longer than 99 characters.
- The password may not contain underscores (_).
- Press **RETURN** to cancel the input. When "Cancel input?" is displayed, select "Yes", then press **ENTER**.

Select the Search Mode

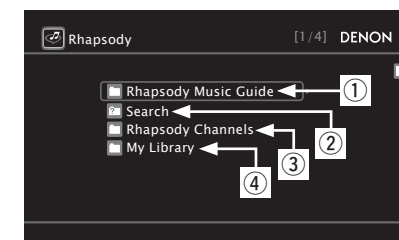

① Search From Rhapsody Latest Information

1 Use Δ / ∇ to select "Rhapsody Music Guide", then press ENTER or \triangleright

2 Use Δ / ∇ to select the information for track selection, then press ENTER or \triangleright .

After selecting, the information is displayed

3 Use Δ / ∇ to select the track, then press ENTER or \triangleright .

② Enter a Character Search For the Track You Want to Listen to

1 Use Δ / ∇ to select "Search", then press ENTER or \triangleright .

2 Use Δ / ∇ to select the search item, then press ENTER or \triangleright .

The search display appears.

※ You can search by artist name, album name, track name or keyword.

3 Enter the characters, then press ENTER.

Playing Rhapsody

Symbols used to indicate buttons in this manual

Button located on both the main unit and the remote control unit → **BUTTON**
 Button only on the main unit → **<BUTTON>**
 Button only on the remote control unit → **[BUTTON]**

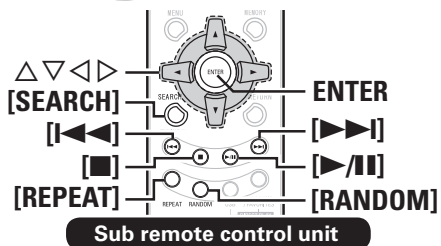
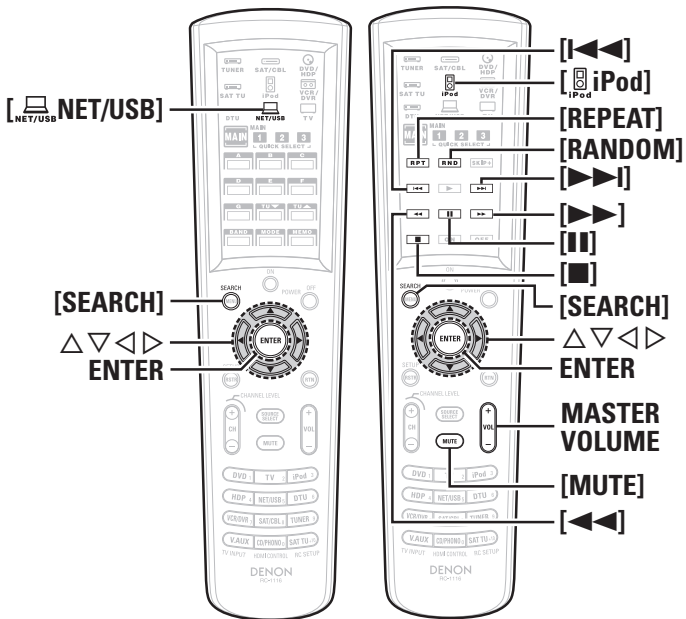
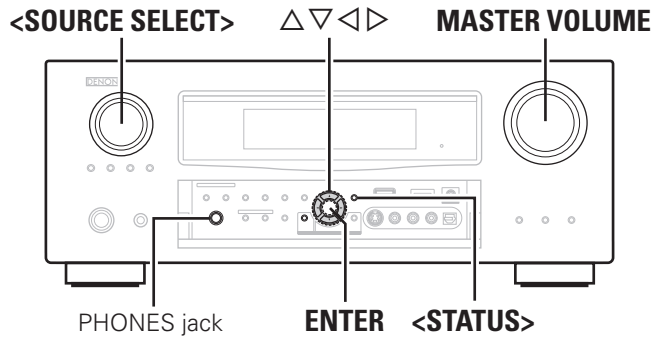

③ Search From the Rhapsody Internet Radio Station

- 1 Use $\Delta \nabla$ to select “Rhapsody Channels”, then press **ENTER** or \triangleright .
- 2 Use $\Delta \nabla$ to select radio station, then press **ENTER** or \triangleright .

④ Listening to Tracks Registered In My Library

- 1 Use $\Delta \nabla$ to select “My Library”, then press **ENTER** or \triangleright .
- 2 Use $\Delta \nabla$ to select the information or track, then press **ENTER** or \triangleright .
After selecting, the information is displayed

Track Menu

Press \triangleright during playback to display the Track Menu.

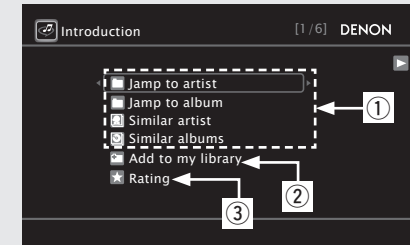

① Search From the Similar Music

Use $\Delta \nabla$ to select the search item, then press **ENTER** or \triangleright .

② Registering Tracks in My Library

Use $\Delta \nabla$ to select “Add to My Library”, then press **ENTER** or \triangleright .
The track is entered in the Library.

③ Rating Function

- 1 Use $\Delta \nabla$ to select “Rating”, then press **ENTER** or \triangleright .
- 2 Use $\triangleleft \triangleright$ to select the rating, then press **ENTER**.



- Use the RESTORER mode to expand the low and high frequency components of compressed audio files and achieve a richer sound. The default setting is “Mode3”.
- The time (default : 30 sec) for which the GUI menus are displayed can be set at “GUI” – “NET/USB” (page 43).
- Use **<STATUS>** to switch between displaying the title name, artist name or album name.

Operations During Playback

Adjusting the Master Volume

Use **MASTER VOLUME** to adjust the volume.

- When the “Volume Display” setting (☞ page 42) is “Relative”
[Adjustable range] --- -80.5dB ~ 18.0dB
- When the “Volume Display” setting (☞ page 42) is “Absolute”
[Adjustable range] 0.0 ~ 99.0

※ The adjustable range depends on the input signal, the channel level settings, etc.

Turning Off the Sound Temporarily (Muting)

Press **[MUTE]**.



- The sound is reduced to the level set at “Mute Level” (☞ page 42).
- To cancel, press **[MUTE]** again. Muting can also be canceled by adjusting the master volume.

Listening with Headphones

Plug the headphones into the PHONES jack on the main unit.

The sound from the speakers and pre-out connectors is automatically cut.

NOTE

- To prevent hearing loss, do not raise the volume level excessively when using headphones.
- Remove your headphones when performing Audyssey Auto Setup or adjusting the speaker volume.

To Stop

During playback, either press and hold **ENTER** or press **[■]**.

Stopping Playback Temporarily

During playback, press **ENTER**, **[⏏]** or **[▶/⏏]** on the sub remote control unit.

Press again to resume playback.

Fast-forwarding or Fast-reversing

During playback, press and hold **[◀◀]** (fast-reverse) or **[▶▶]** (fast-forward), or press and hold **△▽**.

To Cue to the Beginning of a Track

During playback, either press **[|◀◀]** (to search for previous tracks) or **[▶▶|]** (to search for subsequent tracks), or press **△▽**.

Playing Repeatedly

Press **[REPEAT]**.

- All** : Repeat all songs.
- One** : Repeat the current song.
- OFF** : Disable repeat playback.

※ GUI menu “Repeat” (☞ page 50, 51) can be set in the same way.



The repeat mode applies when playing tracks on the USB memory device and on the media server.

Selecting Tracks

During playback, either press **△** (previous track) or **▽** (next track).

Shuffling Playback

Press **[RANDOM]**.

- Albums** : Shuffle songs from current album only.
- Songs** : Shuffle all songs.
- OFF** : Cancel shuffle mode.

※ GUI menu “Shuffle” (☞ page 50) can be set in the same way.

Playing in Random Order

Press **[RANDOM]**.

- ON** : Enable random playback.
- OFF** : Disable random playback.

※ GUI menu “Random” (☞ page 51) can be set in the same way.



The random mode applies when playing tracks on the USB memory device and on the media server.

Searching Pages

Press **[SEARCH]**, then press **◀** (previous page) or **▶** (next page).

※ To cancel, press **△▽** or **[SEARCH]**.

Searching by First Letter

This operation is convenient for choosing items from the menu screens for Internet radio stations or files stored on the computer.

When the menu screen is displayed, press [SEARCH] twice, then press ◀ ▶ to select the first letter you want to search for.

- If there are multiple items starting with the selected letter, they are displayed in alphabetical order.
- If it is not possible to search the list, “unsorted list.” is displayed.

※ To cancel, press **△▽** or **[SEARCH]**.



If the list is not in alphabetical order, you may not be able to perform a character search.



Selecting the Surround Mode (Surround Mode)



Symbols used to indicate buttons in this manual

- Button located on both the main unit and the remote control unit → **BUTTON**
- Button only on the main unit → **<BUTTON>**
- Button only on the remote control unit → **[BUTTON]**

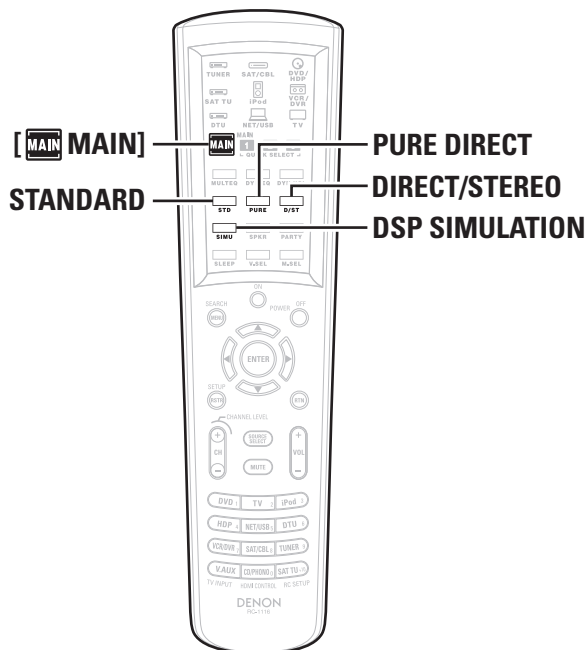
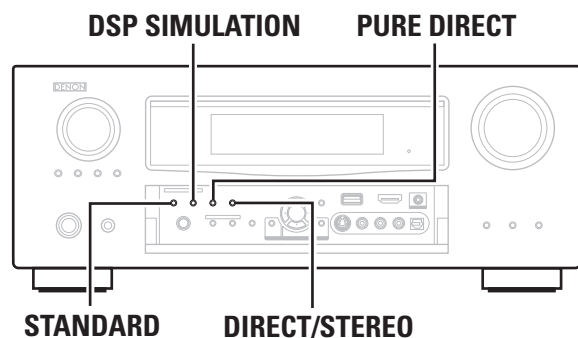

① Playing Sources According to the Sources' Audio Signal Format/ Number of Channels (Standard Playback)

Operations

The selectable surround modes depend on the following:

- Format of the audio signals being input
- Number of channels of the audio signals being input
- The set amplifier assignment (page 34)

1 Playing the source (page 53).

2 Press **STANDARD** to select the surround mode.

❑ Surround Playback of 2-channel Sources

① The mode switches as shown below each time **STANDARD** is pressed.

DOLBY PLIIz *1 : The signals are decoded in DOLBY PLIIz for playback.

DOLBY PLIIx *2 : The signals are decoded in DOLBY PLIIx for playback.

DOLBY PLII : The signals are decoded in DOLBY PLII for playback.

DTS NEO:6 : The signals are decoded in DTS NEO:6 for playback.

neural : It is possible to play analog input signals and PCM (2-channel, 48 kHz or less) in the surround mode.
This is the optimum mode for playing sources recorded in XM HD Surround (page 100).

*1 : This can be set when "Amp Assign" is set to "Front Height" and "Speaker Configuration" – "Front Height" is set to something other than "None".

*2 : This can be set when "Amp Assign" is set to "Normal" and "Speaker Configuration" – "Surround Back" is set to something other than "None".

② Select the mode for the source at "Mode" (page 73).

- Cinema** : This mode is suited for movie sources.
- Music** : This mode is suited for music sources.
- Game** : This mode is suited for games.
- Pro Logic** : This is the Pro Logic playback mode. This can be selected when playing with a DOLBY PLII decoder.
- Height** : This is the Front Height playback mode. Set "Front Height" to "ON" (page 74).

※ The modes that can be selected depend on the input source being played.

❑ Surround Playback of Multi-channel Sources (Dolby Digital, DTS, etc.)

In the case of standard playback of multi channel sources, the AVR-4310CI recognizes the format of the multi-channel audio input signal and automatically operates the appropriate decoder for surround sound.

Displaying the Currently Playing Surround Mode

Input signal	Display
DOLBY DIGITAL (other than 2ch) / DOLBY DIGITAL EX	DOLBY DIGITAL
	DOLBY DIGITAL EX
	DOLBY DIGITAL+PLIIx CINEMA
	DOLBY DIGITAL+PLIIx MUSIC
DOLBY DIGITAL Plus	DOLBY DIGITAL+PLIIz HEIGHT
	DOLBY DIGITAL+
	DOLBY DIGITAL+ +EX
	DOLBY DIGITAL+ + PLIIx CINEMA
DOLBY TrueHD	DOLBY DIGITAL+ + PLIIx MUSIC
	DOLBY DIGITAL+ + PLIIz HEIGHT
	DOLBY TrueHD
	DOLBY TrueHD+EX
DTS (5.1ch) / DTS-ES Discrete 6.1 / DTS-ES Matrix 6.1 / DTS 96/24	DOLBY TrueHD+PLIIx CINEMA
	DOLBY TrueHD+PLIIx MUSIC
	DOLBY TrueHD+PLIIz HEIGHT
	DTS SURROUND
DTS (5.1ch) / DTS-ES Discrete 6.1 / DTS-ES Matrix 6.1 / DTS 96/24	DTS+PLIIx CINEMA
	DTS+PLIIx MUSIC
	DTS+PLIIz HEIGHT
	DTS+NEO:6
	DTS ES MTRX6.1 (*1)
	DTS ES DSCRT6.1 (*2)
	DTS 96/24 (*3)

*1 : This is displayed when the input signal is "DTS-ES Matrix 6.1" and the AVR-4310CI's "AFDM" setting is set to "ON"

*2 : This is displayed when the input signal is "DTS-ES Discrete 6.1".

*3 : This is displayed when the input signal is "DTS 96/24".

For details, see page 104.

Input signal	Display
DTS-HD	DTS-HD HI RES
	DTS-HD MSTR
	DTS-HD+NEO:6
	DTS-HD+PLIIx CINEMA
	DTS-HD+PLIIx MUSIC
	DTS-HD+PLIIz HEIGHT
PCM (multi ch) / DSD (multi ch)	DTS EXPRESS
	MULTI CH IN
	MULTI IN+PLIIx CINEMA
	MULTI IN+PLIIx MUSIC
	MULTI IN+PLIIz HEIGHT
	MULTI CH IN 7.1

② Playing in a DENON Original Surround Mode

The desired mode according to the program source and viewing situation can be selected from among 10 DENON original surround modes.

1 Playing the source (👉 page 53).

2 Select the surround mode by pressing **DSP SIMULATION**.

7CH STEREO : This mode is for enjoying stereo sound from all speakers.

WIDE SCREEN : This mode is for enjoying the atmosphere of viewing a movie on a large screen.

SUPER STADIUM : This mode is suited for viewing sports programs.

ROCK ARENA : This mode is for enjoying the atmosphere of a live concert in an arena.

JAZZ CLUB : This mode is for enjoying the atmosphere of a live concert in a jazz club.

CLASSIC CONCERT : This mode is for appreciating classical concert programs.

MONO MOVIE * : This mode is for playing monaural movie sources with surround sound.

VIDEO GAME : This mode is suited for achieving surround sound with video games.

MATRIX : This mode lets you add a sense of expansion to stereo music sources.

VIRTUAL : This mode is for enjoying surround effects using only the front speakers or headphones.

* : When playing sources recorded in monaural in the "MONO MOVIE" mode, the sound will be off balance with a single channel (left or right), so input to both channels.



Depending on the program source being played, it may not be possible to achieve a satisfactory surround effect. In this case, try other modes to achieve a sound field suited to your tastes.

③ Direct Playback

In this mode the signals bypass the tone control circuitry for high quality sound.

The sound is output to the same channels as the input signal.

1 Playing the source (👉 page 53).

2 Press **DIRECT/STEREO** to select the "DIRECT".

Displaying the Currently Playing Surround Mode

Input signal	Display
Analog signal / PCM (2ch) / Dolby Digital source / DTS source / Other 2-channel digital signals	DIRECT
DSD (2ch)	DSD DIRECT (*)
PCM (multi ch)	MULTI CH DIRECT
	MULTI CH DIRECT + Dolby EX
	MULTI CH DIRECT + PLIIx CINEMA
	MULTI CH DIRECT + PLIIx MUSIC
	MULTI CH DIRECT + PLIIz HEIGHT
MULTI CH DIRECT 7.1	
DSD (multi ch)	DSD MULT DIRECT (*)

* : When DSD signals are converted to PCM signals as set by the audio parameters and speaker settings, "DIRECT" or "MULTI CH DIRECT" is displayed.



For details, see page 105.

④ Stereo Playback

This is the mode for playing in stereo. The tone can be adjusted. Sound is output from the front left and right speakers and subwoofer.

1 Playing the source (👉 page 53).

2 Press **DIRECT/STEREO** to select the "STEREO".

⑤ Playing the Pure Direct Mode

This is the mode that recreates the original sound most faithfully, providing extremely high quality sound.

1 Playing the source (👉 page 53).

2 Press **PURE DIRECT**.



- To cancel, press **PURE DIRECT** again.
- During playback in PURE DIRECT mode, the surround parameters are the same as in DIRECT mode.
- Video signals are only output when HDMI signals are played in the PURE DIRECT mode.

NOTE

When in the PURE DIRECT mode, the GUI menu display is not displayed and the display on the main unit is turned off.



Adjusting the Sound and Picture Quality (Audio/Video Adjust)

For details on how to select, set and cancel settings for each menu, see "GUI Menu Operation" (page 26).



Adjusting the Sound (Audio Adjust)



Default settings are underlined.



The sound being played in the surround mode can be adjusted to your liking. The items (parameters) that can be adjusted depend on the signal being input and the currently set surround mode. For details on the adjustable parameters, see "Surround Modes and Parameters" (page 102).





Setting items	Setting contents
Surround Parameters Adjust surround sound parameters.	<p>Mode : Set the play modes for the different surround modes.</p> <p><input type="checkbox"/> In the PLIIx or PLII mode</p> <ul style="list-style-type: none"> Cinema : Surround sound mode optimized for movie sources. Music : Surround sound mode optimized for music sources. Game : Surround sound mode optimized for games. Pro Logic : Dolby Pro Logic playback mode (PLII mode only). <p><input type="checkbox"/> In the PLIIz mode</p> <p>Height : Dolby PLIIz Height playback mode.</p> <p><input type="checkbox"/> In the DTS NEO:6 mode</p> <ul style="list-style-type: none"> Cinema : Surround sound mode optimized for movie sources. Music : Surround sound mode optimized for music sources. <p></p> <ul style="list-style-type: none"> When "Surround Parameters" – "Front Height" (page 74) is set to "ON", the "Height" mode is set automatically. The "Music" mode is also effective for movie sources including a lot of stereo music. <p>Cinema EQ : Soften the treble range of movie soundtracks for better understanding.</p> <ul style="list-style-type: none"> OFF : "Cinema EQ" is not used. ON : "Cinema EQ" is used. <p>DRC : Compress dynamic range (difference between loud and soft sounds)</p> <ul style="list-style-type: none"> Auto : Automatic dynamic range compression on/off control according to source. This can be set in the Dolby TrueHD mode. Low / Middle / High : These set the compression level. OFF : Dynamic range compression always off <p>D.COMP : Compress dynamic range (difference between loud and soft sounds).</p> <ul style="list-style-type: none"> OFF : Turn dynamic range compression off. Low / Middle / High : These set the compression level.

Setting items	Setting contents
Surround Parameters (Continued)	<p>LFE : Adjust the low-frequency effects level (LFE).</p> <ul style="list-style-type: none"> -10dB ~ 0dB <p></p> <p>For proper playback of the different sources, we recommend setting to the values below.</p> <ul style="list-style-type: none"> Dolby Digital sources : "0dB" DTS movie sources : "0dB" DTS music sources : "-10dB" <p>Center Image : Assign center channel signal to front left and right channels for wider sound.</p> <ul style="list-style-type: none"> 0.0 ~ 1.0 (0.3) <p>Panorama : Assign front L/R signal also to surround channels, for wider sound.</p> <ul style="list-style-type: none"> OFF : Do not set. ON : Set. <p>Dimension : Shift sound image center to front or rear, to adjust playback balance.</p> <ul style="list-style-type: none"> 0 ~ 6 (3) <p>Center Width : Assign center channel signal to front left and right channels for wider sound.</p> <ul style="list-style-type: none"> 0 ~ 7 (3) <p>Delay Time : Adjust delay time to control sound stage size.</p> <ul style="list-style-type: none"> 0ms ~ 300ms (30ms) <p>Effect : Switch effect signal for multi-surround speakers on and off.</p> <ul style="list-style-type: none"> ON : Create a wider sound stage. OFF : The effect is not set. <p>Effect Level : Adjust effect signal level.</p> <ul style="list-style-type: none"> 1 ~ 15 (10) <p></p> <p>Set to a lower level if the positioning and sense of phase of the surround signals seems unnatural.</p> <p>Room Size : Determine size of acoustic environment.</p> <ul style="list-style-type: none"> Small : Simulate acoustics of a small room. Medium small : Simulate acoustics of a medium-small room. Medium : Simulate acoustics of a medium room. Medium large : Simulate acoustics of a medium-large room. Large : Simulate acoustics of a large room <p>NOTE</p> <p>"Room Size" does not indicate the size of the room in which sources are played.</p>

See overleaf







Setting items	Setting contents
Surround Parameters (Continued)	<p>Front Height : Set the Dolby PLIIz Height mode to ON or OFF.</p> <ul style="list-style-type: none"> • ON : Switch to Dolby PLIIz Height mode. • OFF : Do not switch to Dolby PLIIz Height mode. <p></p> <ul style="list-style-type: none"> • "Front Height" is not displayed with the settings listed below. <ul style="list-style-type: none"> • When the "Amp Assign" setting (page 34) is set to something other than "Front Height" • When the "Speaker Configuration" – "Front Height" setting (page 35) is set to "None" • When "Surround Mode" (page 71) is set to something other than "STANDARD" • "Front Height" cannot be set if the HD Audio source being played includes a front height channel. In this case, the Front height channel is played back without decoding in PLIIz mode, using the input signal. <p>AFDM (Auto flag detect mode) : Detects the source's surround back channel signal and sets the optimum surround mode automatically.</p> <ul style="list-style-type: none"> • OFF : Do not set. • ON : Set. <p>[Example] Playing Dolby Digital software (with EX flag)</p> <ul style="list-style-type: none"> • When "AFDM" is set to "ON", the surround mode is automatically set to the DOLBY D + PLIIx C mode. • To play in the DOLBY DIGITAL EX mode, set "AFDM" to "OFF" and "Surround Back" to "MTRX ON". <p></p> <ul style="list-style-type: none"> • Some Dolby Digital EX sources do not include EX flags. If the playback mode does not switch automatically even when "AFDM" is set to "ON", set "Surround Back" to "MTRX ON" or "PLIIx CINEMA". • If the setting in "Speaker Configuration" – "Surround Back" (page 35) is "None", "Surround Back" is not displayed. <p>Surround Back : Sets the method of generating of the surround back channel.</p> <p><input type="checkbox"/> For 2-channel sources</p> <ul style="list-style-type: none"> • ON : The surround back channel is used. • OFF : No signal is played from the surround back channels. <p><input type="checkbox"/> For multi-channel sources</p> <p>Set the decoding method for the surround back channel.</p> <p>DSCRT ON : Play the surround back signals included in the 7.1-channel source.</p> <p>MTRX ON : Generate and play the surround back signals from the surround channel signals.</p> <p>ES MTRX *1 : Generate and play the surround back signals from the surround channel signals of the DTS source.</p> <p>ES DSCRT *2 : Play the surround back signals included in the 6.1-channel DTS source.</p>



Setting items	Setting contents
Surround Parameters (Continued)	<p>PLIIx CINEMA *3 : Generate and play the surround back signals by decoding the signals in the Dolby Pro Logic IIx Cinema mode.</p> <p>PLIIx MUSIC : Generate and play the surround back signals by decoding the signals in the Dolby Pro Logic IIx Music mode.</p> <p>OFF : The surround back channel is not played.</p> <ul style="list-style-type: none"> *1 : This can be selected when playing DTS sources. *2 : This can be selected when playing DTS sources including a signal to identify discrete 6.1-channel signals. *3 : This can be selected when "Speaker Configuration" – "Surround Back" (page 35) is set to "2spkr". <p></p> <ul style="list-style-type: none"> • This can also be set by pressing [STANDARD]. • If the source being played contains a surround back signal, the decoder type is automatically selected by the AFDM function. Set "AFDM" to "OFF" to switch to your preferred decoder. • If the setting in "Speaker Configuration" – "Surround Back" (page 35) is "None", "Surround Back" is not displayed. <p>Subwoofer Att. : Attenuate subwoofer level when using EXT. IN input.</p> <ul style="list-style-type: none"> • ON : Set. • OFF : Do not set. Usually use in this mode. <p></p> <p>Set this to "ON" if the subwoofer channel level seems too high when playing audio signal.</p> <p>Subwoofer : Turn subwoofer output on and off.</p> <ul style="list-style-type: none"> • ON : The subwoofer is used. • OFF : The subwoofer is not used. <p>Default : Restores all the surround parameter settings to their defaults.</p> <ul style="list-style-type: none"> • No : Do not reset to the defaults. • Yes : Reset to the defaults.
Tone Adjust the tonal quality of the sound.	<p>Tone Control : Sets the tone control function ON and OFF.</p> <ul style="list-style-type: none"> • ON : Allow tone adjustment (treble, bass). • OFF : Playback without tone adjustment. <p></p> <ul style="list-style-type: none"> • This can be set when "Dynamic EQ" (page 75) is set to "OFF". • The tone cannot be adjusted in the direct mode. <p>Bass : Adjust low frequency range (bass).</p> <ul style="list-style-type: none"> • -6dB ~ +6dB <p></p> <p>This can be set when "Tone Control" (page 74) is set to "ON".</p> <p>Treble : Adjust high frequency range (treble).</p> <ul style="list-style-type: none"> • -6dB ~ +6dB <p></p> <p>This can be set when "Tone Control" (page 74) is set to "ON".</p>

See overleaf







Adjusting the Sound and Picture Quality (Audio/Video Adjust)

Setting items	Setting contents
Audyssey Settings Set MultEQ XT, Dynamic EQ and Dynamic Volume.	<p>MultEQ XT : Corrects both time and frequency response problems in the listening area.</p> <ul style="list-style-type: none"> • Audyssey : Optimize the frequency response of all speakers. • Audyssey Byp.L/R : Optimize frequency response of speakers except front L and R speakers. • Audyssey Flat : Optimize frequency response of all speakers to flat response. • Manual : Apply frequency response set with "Manual EQ" (page 76). • OFF : Turn "MultEQ XT" equalizer off. <p> "Audyssey", "Audyssey Byp. L/R" and "Audyssey Flat" can be selected after Audyssey Auto Setup has been performed. "Audyssey" is automatically selected after performing Audyssey Auto Setup. "When "Audyssey", "Audyssey Byp.L/R" or "Audyssey Flat" is selected,  lights.</p> <ul style="list-style-type: none"> • After running Audyssey Auto Setup, if the Speaker Configuration, Distance, Channel Level, and Crossover Frequency have changed without increasing the number of speakers measured, only  lights. • If "Dynamic EQ" or "Dynamic Volume" is set to "ON" when "MultEQ XT" is set to either "OFF" or "Manual", "MultEQ XT" is automatically set to "Audyssey". • You can also press [MULTEQ XT] to set. <p>NOTE</p> <ul style="list-style-type: none"> • "MultEQ XT" and "Manual EQ" cannot be selected when "EQ Customize" is set to "Not Used" (page 39). • When using headphones, "MultEQ XT" is set to "OFF". <p>Dynamic EQ : Solves the problem of deteriorating sound quality as volume is decreased by taking into account human perception and room acoustics.</p> <ul style="list-style-type: none"> • ON : Use the Dynamic EQ equalizer. • OFF : Do not use the Dynamic EQ equalizer. <p> After performing "Audyssey Auto Setup", the "Dynamic EQ" setting automatically becomes "ON".</p> <ul style="list-style-type: none"> •  is displayed when set to "ON". • When "MultEQ XT" is set to "OFF" or "Manual", "Dynamic EQ" is automatically set to "OFF". • If "Dynamic Volume" is set to "ON", "Dynamic EQ" is automatically set to "ON". • When you set "Dynamic EQ" to "ON", "Tone Control" is switched "OFF". • You can also press [DYNAMIC EQ] to set.

Setting items	Setting contents
Audyssey Settings (Continued)	<p>Dynamic EQ : ON/Volume : OFF → Dynamic EQ / Volume : OFF</p> <div style="display: flex; justify-content: space-around; align-items: center;"> <div style="text-align: center;">  "Red" </div> <div style="text-align: center;">  "Off" </div> </div> <p>About Dynamic EQ</p> <p>Audyssey Dynamic EQ™ solves the problem of deteriorating sound quality as volume is decreased by taking into account human perception and room acoustics. Audyssey Dynamic EQ works in tandem with Audyssey MultEQ® XT to provide well-balanced sound for every listener at any volume level.</p> <p>Reference Level Offset : Audyssey Dynamic EQ is referenced to the standard film mix level. It makes adjustments to maintain the reference response and surround envelopment when the volume is turned down from 0 dB. However, film reference level is not always used in music or other non-film content. The Dynamic EQ Reference Level Offset provides three offsets from the film level reference (5 dB, 10 dB, and 15 dB) that can be selected when the mix level of the content is not within the standard.</p> <ul style="list-style-type: none"> • 0dB (Film Ref) : This is the default setting and should be used when listening to movies. • 5dB : Select this setting for content that has a very wide dynamic range, such as classical music. • 10dB : Select this setting for jazz or other music that has a wider dynamic range. This setting should also be selected for TV content as that is usually mixed at 10 dB below film reference. • 15dB : Select this setting for pop/rock music or other program material that is mixed at very high listening levels and has a compressed dynamic range. <p> Setting is enabled when "Dynamic EQ" is "ON" (page 75).</p>

See overleaf



Setting items	Setting contents
Audyssey Settings (Continued)	<p>Dynamic Volume : Solves the problem of large variations in volume level between TV, movies and other content (between quiet passages and loud passages, etc.) by automatically adjusting to the user's preferred volume setting.</p> <ul style="list-style-type: none"> • ON : Use the "Dynamic Volume" equalizer. The Dynamic Volume effect will be at the level of the "Setting" (page 76). • OFF : Do not use the "Dynamic Volume" equalizer. <p> "AUDYSSEY MULTIEQ XT DYN VOL" is displayed when set to "ON".</p> <ul style="list-style-type: none"> • When "MultEQ XT" is set to "OFF", "Dynamic Volume" is automatically set to "OFF". • You can also press [DYNAMIC VOLUME] to set. <div style="border: 1px solid black; padding: 5px; text-align: center;"> <p>Dynamic EQ / Volume : ON Dynamic EQ : ON / Volume : OFF</p> <div style="display: flex; justify-content: space-around; align-items: center;"> <div style="text-align: center;">  "Green" </div> <div style="text-align: center;">  "Red" </div> </div> </div> <div style="border: 1px solid black; padding: 5px; margin-top: 10px;"> <p style="text-align: center;">About Dynamic Volume</p> <p>Audyssey Dynamic Volume™ solves the problem of large variations in volume level between television programs, commercials, and between the soft and loud passages of movies.</p> <p>Audyssey Dynamic EQ™ is integrated into Dynamic Volume so that as the playback volume is adjusted automatically, the perceived bass response, tonal balance, surround impression, and dialog clarity remain the same.</p> </div> <p>Setting : Set "Dynamic Volume" equalizer effect.</p> <ul style="list-style-type: none"> • Midnight : High setting affects volume the most, causing all sounds to be of equal loudness. • Evening : Middle setting prevents loud and soft sounds from being much louder and softer respectively than average sounds. • Day : Low setting provides the least adjustments to the loudest and softest of sounds. <p> Can be set when "Dynamic Volume" is set to "ON".</p>

Setting items	Setting contents
Audyssey DSX Settings Adjust DSX setting and sound stage parameters.	<p>DSX : Provides more immersive surround sound by adding the new channels.</p> <ul style="list-style-type: none"> • ON : Set Audyssey DSX to expand surround. • OFF : Do not set Audyssey DSX. <hr/> <p>Stage Width : Adjust sound stage width when using front wide speakers.</p> <ul style="list-style-type: none"> • -10 ~ 0 <p>Stage Height : Adjust sound stage height when using front height speakers.</p> <ul style="list-style-type: none"> • -10 ~ 0 <p> "Audyssey DSX Settings" cannot be configured if the HD Audio source being played includes Front height and Front wide channels. In this case, the respective channels are played back using the input signals.</p> <ul style="list-style-type: none"> • "DSX" can be set when you are using front height speakers or front wide speakers. • "DSX" is only valid when using a center speaker. • "DSX" is valid when surround mode is STANDARD mode other than PLIIz Height. • "DSX" can be operated by <DSX> and [SPEAKER]. The "DSX" indicator lights on the display. • "Audyssey DSX Settings" cannot be configured if the HD Audio source being played includes Front height and Front wide channels. In this case, the respective channels are played back using the input signals. <div style="border: 1px solid black; padding: 5px; margin-top: 10px;"> <p style="text-align: center;">About Audyssey Dynamic Surround Expansion (DSX)</p> <p>Audyssey DSX is a scalable surround expansion system that adds new channels to improve the surround impression. Based on research in human hearing DSX adds a pair of Wide channels in the front because that information is critical in the rendering of a realistic soundstage. DSX then adds a pair of Height channels above the main front channels to reproduce the next most important acoustical and perceptual cues related to soundstage depth. In addition to creating these new channels, DSX applies Surround Envelopment Processing to enhance the blend between the front and side/back surround channels. The result is a much more seamless and enveloping home theater experience.</p> </div>

See overleaf 

Adjusting the Sound and Picture Quality (Audio/Video Adjust)

Setting items	Setting contents
Manual EQ Use the graphic equalizer to adjust the tone of each speaker.	<p>Adjust CH : Correct the tone of each speaker.</p> <ol style="list-style-type: none"> Select the speaker tone adjustment method. All : Adjust the tone of all speakers together. L/R : Adjust the tone of left and right speakers together. Each : Adjust the tone of each speaker. Select the speaker. Select the adjustment frequency band. 63Hz / 125Hz / 250Hz / 500Hz / 1kHz / 2kHz / 4kHz / 8kHz / 16kHz ※ Select the speakers you want to adjust when "L/R" or "Each" is selected. Adjust the level. -20.0dB ~ +6.0dB (0dB) <p> Can be set when "MultEQ XT" setting (page 75) is "Manual".</p> <p>Curve Copy : Copy "Audyssey Flat" curve from MultEQ® XT. Yes : Copy. No : Do not copy.</p> <p> "Curve Copy" is displayed after Audyssey Auto Setup has been performed.</p> <p>Default : Reset the settings to the default values. Yes : Reset. No : Do not Reset.</p>
RESTORER This function restores compressed audio signals to how they were before compression and corrects the sense of volume of the bass and treble to obtain richer playback sound.	<p>OFF : Do not use RESTORER. Mode 1 (RESTORER 64) : Optimized mode for compressed sources with very weak highs. Mode 2 (RESTORER 96) : Apply suitable bass and treble boost for all compressed sources. Mode 3 (RESTORER HQ) : Optimized mode for compressed sources with normal highs.</p> <p></p> <ul style="list-style-type: none"> This can be set with analog signals or when a PCM signal (fs = 44.1/48 kHz) is input. <p>This cannot be set when the input mode is set to "EXT. IN" or when the surround mode is set to "DIRECT".</p> <ul style="list-style-type: none"> The default setting for "iPod" and "NET/USB" are "Mode 3". All others are set to "OFF". When set to something other than "OFF", "RSTR" is displayed. This can also be set by pressing [RESTORER] during playback. <pre> graph LR OFF --> Mode1["Mode 1 (RESTORER 64)"] Mode1 --> Mode2["Mode 2 (RESTORER 96)"] Mode2 --> Mode3["Mode 3 (RESTORER HQ)"] Mode3 --> OFF </pre>

Setting items	Setting contents
RESTORER (Continued)	<p>About the RESTORER function</p> <ul style="list-style-type: none"> Such compressed audio formats as MP3, WMA (Windows Media Audio) and MPEG-4 AAC reduce the amount of data by eliminating signal components that are hard for the human ear to hear. The RESTORER function generates the signals eliminated upon compression, restoring the sound to conditions near those of the original sound before compression. It also corrects the sense of volume of the bass to obtain richer sound with compressed audio signals. This is displayed on the GUI menu and can be set when the input source is set to "XM", "HD Radio" or "NET/USB", or when analog signals (including FM/AM signals) or PCM signals (fs = 44.1/48 kHz) are input.
Audio Delay While viewing video, manually adjust the time to delay audio output.	<p>0ms ~ 200ms</p> <p></p> <ul style="list-style-type: none"> This can be set within the range of 0 to 100 ms when "Auto Lip Sync" is set to "ON" and when a TV compatible with Auto Lipsync is connected. Store "Audio Delay" for each input source.



Adjusting the Picture Quality (Picture Adjust)



Default settings are underlined.

- This can be set when the input source is **DVD** **HDP** **TV** **SAT/CBL** **VCR** **DVR** **VAUX** **NET/USB**.
 ※ With input sources other than the ones above, this can be set when "Video Select" is selected. In this case, the original input source settings are called out.
- Can be set when the "Video Convert" setting (page 49) is "ON".

Setting items	Setting contents
Contrast Adjust picture contrast.	-6 ~ <u>0</u> ~ +6
Brightness Adjust picture brightness.	<u>0</u> ~ +12
Chroma Level Adjust picture chroma level (saturation).	-6 ~ <u>0</u> ~ +6
Hue Adjust color hue.	-6 ~ <u>0</u> ~ +6
DNR Reduce overall picture noise.	<u>OFF</u> / Low / Middle / High
Enhancer Emphasize picture contours.	<u>0</u> ~ +12



- "DNR" and "Enhancer" are each effective with HDMI output.
- The value set at "Picture Adjust" is stored in the memory individually for each input source.





Checking the Status (Information)



Setting items	Setting contents
Status Shows information about current settings.	<input type="checkbox"/> MAIN ZONE Shows information about settings for MAIN ZONE. The items displayed differ according to the input source. Select Source / Name / Zone Rename / Surround Mode / Input Mode / Decode Mode / HDMI / Digital / Component / iPod dock / Rec Select / Video Select / Video Convert / i/p Scaler / Resolution / Progressive Mode / Aspect etc.
	<input type="checkbox"/> ZONE2 / ZONE3 Shows information about settings for multi-zone. Zone Rename / Power / Select Source / Volume Level
Audio Input Signal Shows information about audio input signals.	Surround Mode : The currently set surround mode Signal : The input signal type fs : The input signal's sampling frequency Format : The number of channels in the input signal (front, surround, LFE) Offset : The dialogue normalization correction value Flag : This is displayed when inputting signals including a surround back channel. "MATRIX" is displayed with Dolby Digital EX and DTS-ES Matrix signals, "DISCRETE" with DTS-ES Discrete signals.
	<div style="border: 1px solid black; padding: 5px;"> <p style="text-align: center;">Dialogue normalization function</p> <p>This is automatically activated when playing Dolby Digital sources. This function automatically corrects the standard signal level for individual program sources. The correction value can be checked using the <STATUS>.</p> <div style="border: 1px solid black; padding: 5px; text-align: center; margin: 10px auto; width: fit-content;"> Dial.Norm Offset - 4dB </div> <p>The figure is the correction value when the standard level is corrected.</p> </div>
HDMI Information Shows information about HDMI input/output signals and monitor.	Signal Info. <ul style="list-style-type: none"> • Resolution / Color Space / Pixel Depth Monitor 1 / Monitor 2 <ul style="list-style-type: none"> • Interface / Supported resol.
Auto Surround Mode Shows information about auto surround mode settings.	Analog/PCM 2ch / Digital 2ch / Digital 5.1ch / Multi ch This can be displayed when "Auto Surround Mode" is set to "ON".

Setting items	Setting contents
Quick Select Shows information about "Saving Frequently Used Settings (Quick Select Function)" (page 82) settings.	Quick Select 1 / Quick Select 2 / Quick Select 3 / ZONE2 Quick Select / ZONE3 Quick Select <ul style="list-style-type: none"> • Select Source / Video Select / MultEQ XT / Dynamic EQ / Dynamic Volume / Auto Surround Mode (Analog/PCM 2ch / Digital 2ch / Digital 5.1ch / Multi ch) / Volume Level
Preset Channel Shows information about preset channels.	This can be checked when the input source is set to NET/USB XM SIRIUS HD Radio A / B / C / D / E / F / G <ul style="list-style-type: none"> • A1 ~ A8 / B1 ~ B8 / C1 ~ C8 / D1 ~ D8 / E1 ~ E8 / F1 ~ F8 / G1 ~ G8

Main remote control operation buttons



:Displaying the menu
Cancel the menu



:Moves the cursor
(Up/Down/Left/Right)



:Confirm the setting



:Return to previous menu

Other Operations and Convenient Functions



Symbols used to indicate buttons in this manual

- Button located on both the main unit and the remote control unit → **BUTTON**
- Button only on the main unit → **<BUTTON>**
- Button only on the remote control unit → **[BUTTON]**

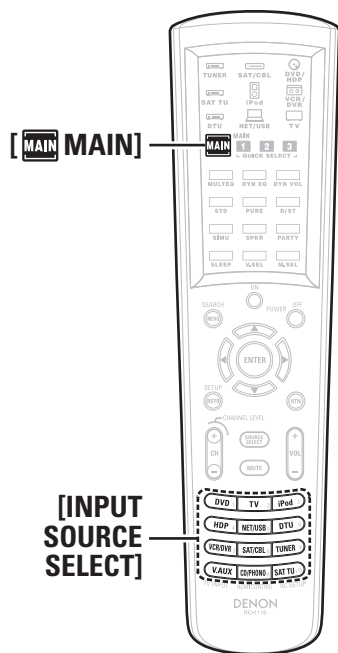
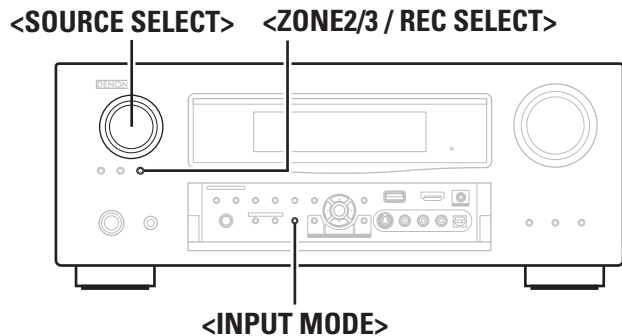

Other Operations

Playing a Blu-ray Disc Player Compatible with DENON LINK 4th

To play DENON LINK 4th signals, make HDMI and DENON LINK connections with the compatible Blu-ray disc player.

DENON LINK 4th uses the clock of the AV amplifier connected by DENON LINK to achieve HDMI signal transfer with little jitter when playing BD.

- 1** Assign “HDMI” to the input source to be used, and assign “D.LINK” to the “Digital” setting (☞ page 47 “Input Assign”).
- 2** Set “HDMI Control” – “Control” (☞ page 37) to “ON”.
- 3** Either turn <SOURCE SELECT> or press [INPUT SOURCE SELECT] to select the input source assigned in step 1.
The “HDMI” indicator lights on the display.
- 4** Select “AUTO” for the <INPUT MODE> (☞ page 49 “Input Mode”).
- 5** Select the surround mode (☞ page 71 “Selecting the Surround Mode (Surround Mode)”).
- 6** Start playing the BD.
Playback starts.

NOTE

- Set the Blu-ray disc player’s “HDMI Control” setting to “ON”, the “DENON LINK” setting to “4th”. For instructions on operation, refer to the Blu-ray disc player’s manual.
- The jitter-free function does not work except during BD playback. In this case, the video signal is output from the HDMI OUT terminal, and the audio signal from the DENON LINK terminal.
- When a BD is played with the input mode set to “Auto”, playback is performed in the DENON LINK 4th mode. When a disc other than a BD is played with the input mode set to “Auto”, playback is automatically performed in the DENON LINK 3rd mode.
- When the input mode is set to “HDMI”, normal HDMI playback is performed.
- When the input mode is set to “Digital”, playback is fixed to the DENON LINK 3rd mode and BDs cannot be played.

Playing Super Audio CD

- 1** Either assign the input source to be used to “HDMI” (☞ page 47), or assign “D.LINK” at the “Digital” setting (☞ page 47 “Input Assign”).
- 2** Either turn <SOURCE SELECT> or press [INPUT SOURCE SELECT] to select the input source assigned in step 1.
The “D.LINK” or “HDMI” indicator lights on the display.
- 3** Select the surround mode (☞ page 71 “Selecting the surround mode”).
※ We recommend playing in the DIRECT mode.
- 4** Start playing the Super Audio CD.
The “DSD” indicator lights on the display.
※ For operating instructions, refer to the respective equipment’s operating instructions.



- When playing DSD signals in the DIRECT or PURE DIRECT mode, the DSD signals are converted as such into analog signals. When playing in other surround modes, the DSD signals are first converted into PCM format, then into analog signals.
- “DSD DIRECT” is shown on the display when playing DSD 2-channel signals in the DIRECT mode. “DSD MULTI DIRECT” is shown on the display when playing DSD multi-channel signals in the DIRECT mode.

Recording on an External Device (REC OUT mode)

You can listen to one program source while recording a different program source.

- 1 Press **<ZONE2/3 / REC SELECT>**.
“ZONE2 SOURCE” is shown on the display.

- 2 Turn **<SOURCE SELECT>** until **“RECOUT SOURCE”** is displayed.
The “REC” indicator lights.

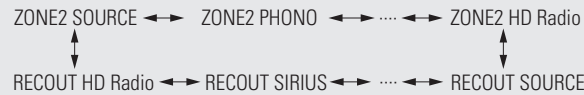

- 3 Turn **<SOURCE SELECT>** to choose the input source to be recorded.

- 4 Play the program source.

※ For operating instructions, refer to the respective equipment’s operating instructions.

- 5 Start recording.

※ For operating instructions, refer to the respective equipment’s operating instructions.



- To cancel, press **<ZONE2/3 / REC SELECT>**, then turn **<SOURCE SELECT>** until “ZONE2 SOURCE” is displayed.
- Make a test recording before starting the actual recording.
- Signals are only output to the analog REC OUT connectors when the digital signals input to the digital input connectors (OPTICAL/COAXIAL) are PCM (2-channel) signals.
- Digital audio signals input to the DENON LINK or HDMI connectors are not output to the REC OUT connectors, so connect using the OPTICAL or COAXIAL connectors.
- Sources selected with the REC OUT mode are output from ZONE2 as well.
- In the REC OUT mode, the remote control unit’s ZONE2 mode buttons cannot be operated.
- The “XM” and “HD Radio” digital audio output signals are not output from the OPTICAL2 output connectors. Also, network audio signals (Internet radio, music server, USB) are not output if they are copyright-protected.

NOTE

- Recordings you make are for your personal enjoyment and should not be used for other purposes without permission of the copyright holder.
- Input sources for which “Delete” is selected at “Source Delete” (page 42) cannot be selected.

Convenient Functions

HDMI Control Function

When you make an HDMI connection with a TV or player compatible with AVR-4310CI and HDMI control functions, you can perform the following operations by setting the HDMI control function of each device.

- AVR-4310CI power off can be linked to the TV power off step.**
When you set “Output audio from amp” in the TV audio output setup operation, you can switch the amp power on.
- You can switch audio output devices with a TV operation.**
- You can adjust AVR-4310CI volume in the TV volume adjustment operation.**
- You can switch AVR-4310CI input source through linkage to TV input switching.**
- When playing the player, the AVR-4310CI input function switches to the function of that player.**



- When you want to listen to TV audio by AVR-4310CI, connect optical digital or analog audio (page 18 “Connecting the TV”).
- When using these functions set as follows: “HDMI Control” – “Control” (page 37) set to “ON”.

NOTE

- When “Control” is set to “ON”, it consumes more standby power.
- The HDMI control function controls operations of a TV that is compatible with the HDMI control function. Make sure that the TV and HDMI are connected when you perform HDMI control.
- When you power off AVR-4310CI, the HDMI control function does not operate. Either power on or set to standby.
- Some functions may not operate depending on the connected TV or player. Check the owner’s manual of each device for details beforehand.
- When “Control” is set to “ON”, it is not possible to assign an HDMI terminal to “TV” at “Input Assign” (page 47).

- 1 Turn the power on for all the equipment connected by HDMI cable.

- 2 Set the HDMI control function for all equipment connected by HDMI cable.

Set “HDMI Control” – “Control” (page 37) to “ON”.

※ Please consult the operating instructions for the connected equipment to check the settings.

※ Carryout steps 1 and 2 should any of the equipment be plugged out.

- 3 Switch the television input to the HDMI connected to the AVR-4310CI.

- 4 Switch the AVR-4310CI input to the HDMI input source and check if the picture from the player is ok.

- 5 When you turn the TV’s power to standby, check that the power of the AVR-4310CI and player also goes on standby.



If the HDMI control function does not operate properly, check the following points.

- Is the TV or player compatible with the HDMI control function?
- Is the AVR-4310CI properly set?
 - Is the “HDMI Control” – “Control” (page 37) set to “ON”?
 - Is the “Power Off Control” (page 37) set to “ON”?
 - Is the “Control Monitor” (page 37) set for the monitor output connected to television?
- Are the HDMI control function settings of all equipment correct?

NOTE

Should any of the operations below be performed, the interlocking function may be reset, in which case, repeat step’s 1 and 2.

- “Input Assign” – “HDMI” (page 47) setting has changed.
- “Monitor Out” (page 37) setting is changed.
- There is a change to the connection between the equipment and the HDMI, or an increase in equipment.

Convenient Functions



Symbols used to indicate buttons in this manual

Button located on both the main unit
and the remote control unit

→ **BUTTON**

Button only on the main unit

→ **<BUTTON>**

Button only on the remote control unit

→ **[BUTTON]**

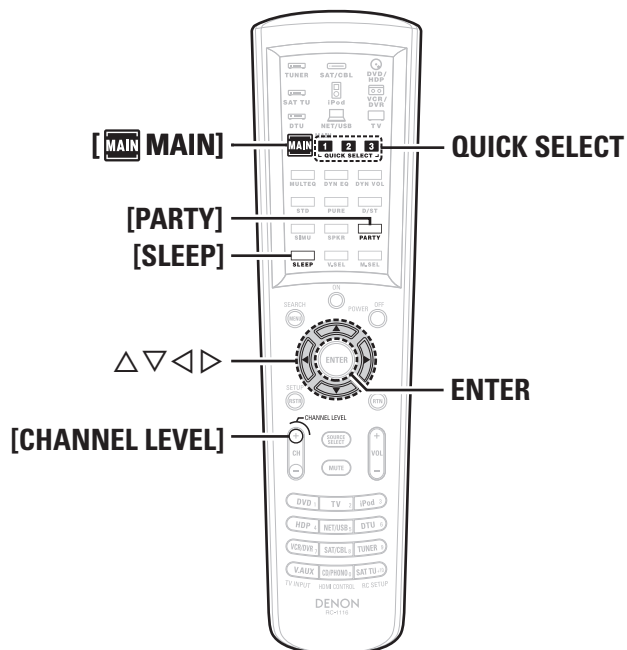
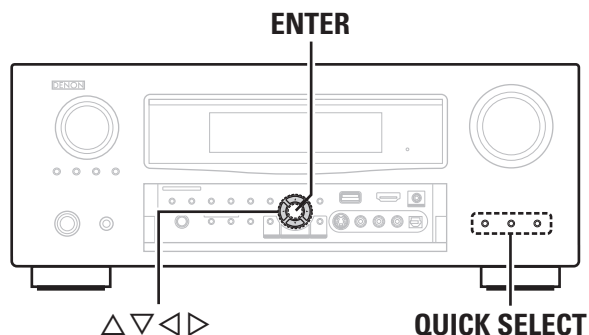

Setting the Power to Standby After a Certain Amount of Time (Sleep Timer Function)

With this function, you can set the AVR-4310CI so that the power is automatically switched to standby after the set amount of time has passed.

This is convenient for playing sources while going to sleep.

Press [SLEEP] and display the time you want to set.

The "SLEEP" indicator on the display lights.

- The time switches as shown below each time [SLEEP] is pressed.

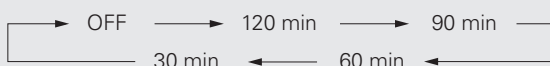

To cancel the sleep timer

Press [SLEEP] to set "OFF".

The "SLEEP" indicator on the display turns off.



- The sleep timer setting is canceled if the AVR-4310CI's power is set to standby or turned off.
- The sleep timer function can be set separately for the different zones (☞ page 88 "Sleep Timer").

Adjust the Volume of the Speakers

You can adjust the channel level either according to the playback sources or to suit your taste, as described below.

Adjust the Volume of the Different Speakers

1 Press [CHANNEL LEVEL].

2 Use Δ ∇ to select the speaker.

The speaker that can be set switches each time one of the buttons is pressed.

3 Use \triangleleft \triangleright to adjust the volume.

※ In the case of a subwoofer, press \triangleleft when it is at "-12 dB" will change the setting to "OFF".



When a headphone jack is inserted, the headphone channel level can be adjusted.

Adjusting the Volume of Groups of Speakers (Fader Function)

This function lets you adjust (fade) the sound from all the front (Front speaker / Front height speaker / Front wide speaker / Center speaker) or rear (Surround speaker / Surround Back speaker) speakers at once.

1 Use ∇ to select "Fader", then select the item to be adjusting using \triangleleft or \triangleright .

2 Use \triangleleft \triangleright to adjust the volume of the speakers. (\triangleleft : front, \triangleright : rear)



- The fader function does not affect the subwoofer.
- The fader can be adjusted until the volume of the speaker adjusted to the lowest value is -12 dB.

Saving Frequently Used Settings (Quick Select Function)

All of the settings in step 1 can be memorized together. By memorizing frequently used settings, you can quickly access and enjoy a playback environment that is consistently the same.

Saving the Settings

1 Set the items below to the settings you want to save.

- ① Input Source (☞ page 27)
- ② Volume Level (☞ page 70)
- ③ Surround Mode (☞ page 71)
- ④ Audyssey Setting (MultEQ[®] XT, Dynamic EQ[™], Dynamic Volume[™]) (☞ page 75, 76)
- ⑤ Video Select (☞ page 48)

2 Press and hold the desired QUICK SELECT until “Memory” appears on the display.

The current settings will be memorized.

[Quick Select Defaults]

	Input Source	Volume
Quick Select 1	DVD	-40dB
Quick Select 2	SAT/CBL	-40dB
Quick Select 3	VCR	-40dB

Calling the Settings Out

Press QUICK SELECT at which the settings you want to call out are saved.

The “[Q1]”, “[Q2]” or “[Q3]” indicator lights on the display.

❑ Naming Quick Select settings

See “Quick Select Name” (☞ page 43).



The Quick Select function can be set separately for the different zones (☞ page 88 “Quick Select Function”).

NOTE

Input sources stored with the quick select function cannot be selected if they have been deleted at “Source Delete” (☞ page 42). In this case, store them again.

Playing the Same Network Audio on Different Devices Connected in a Network (Party Mode Function)

The same network audio (Internet Radio, Media Server or iPod DIRECT) can be played on multiple DENON products equipped with the Party Mode function and connected in a network.

The party mode consists of one organizer and up to four attendees. When one unit starts the party mode as the organizer, up to four devices on which the party mode function is activated automatically participate in the party as attendees. “Party Mode Function” (☞ page 40) must be set to “ON” ahead of time in order to use the party mode function.

Starting the Party Mode as the Organizer

1 Press [PARTY] to become the organizer.

“Enter Party Mode?” is displayed.

※ An error message is displayed when you are not connected to a network.

2 Press ◀▶ to select “Yes”, then press ENTER.

The “**PARTY ORGANIZER**” indicator on the display lights. The input source automatically switches to “NET/USB” and the attendees are automatically selected.

3 Play the desired track.

❑ To Cancel the Party Mode

1 While in the party mode, press [PARTY].

“Exit Party Mode?” is displayed on the GUI screen.

2 Press ◀▶ to select “Yes”, then press ENTER.

“Power off Attendees component?” is displayed.

3 Press ◀▶ to select “Yes” or “No”, then press ENTER.

Yes : The power of the attendees is turned off and the party mode is canceled.

No : The party mode is canceled without turning off the power of the attendees.

Participating in the Party Mode as an Attendee

- When the organizer starts the party mode, up to four attendees are selected automatically. No operation is required.
- When a device becomes an attendee, “**PARTY ATTENDEE**” appears on the display. The input source automatically switches to “NET/USB” and the same network audio as on the organizer is played.
- If there are fewer than four attendees, a device can join the party mode after it has started. To participate in the party mode, perform the operation described below.

1 Press [PARTY].

“Enter Party Mode?” is displayed.

※ An error message is displayed when you are not connected to a network.

2 Press ◀▶ to select “Yes”, then press ENTER.

❑ To Cancel the Party Mode

1 While in the party mode, press [PARTY].

“Exit Party Mode?” is displayed on the GUI screen.

2 Press ◀▶ to select “Yes”, then press ENTER.

In this case, the other devices remain in the party mode.



“Rhapsody”, “Napster” and “USB” are not available in the Party Mode.

There can only be one organizer in the network. To form a new party mode, first cancel the current party mode.

Convenient Functions

Operating a Wireless LAN-Compatible Mobile Terminal to Play Music and Still Pictures

- Perform this procedure using a wireless LAN-compatible mobile terminal conforming to the DLNA (Digital Living Network Alliance) standard.
- This function allows you to play contents located on a computer (music server) or mobile terminal device connected in a network by operating a mobile terminal device in the same network.
- There are two types of operations on the mobile terminal device.

Playing Contents on a Computer (Media Server)

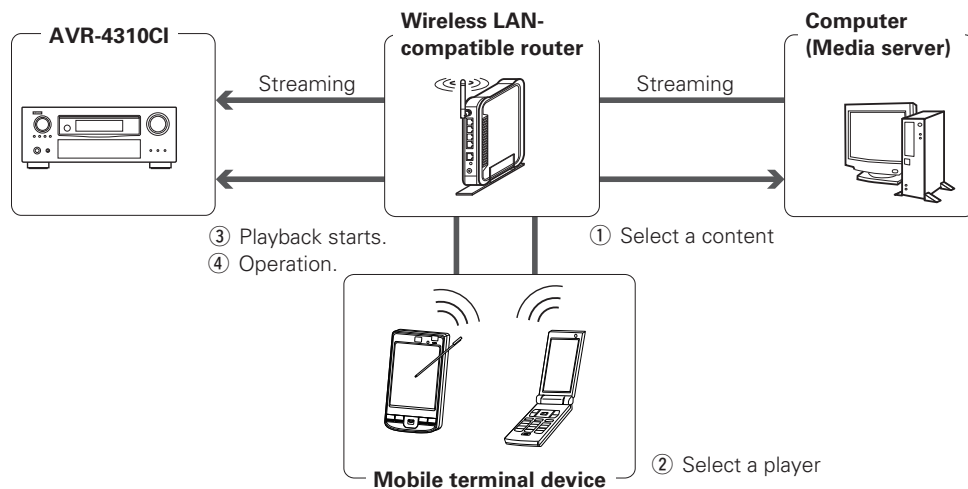

1 From the mobile terminal device, browse the media server in the same network and choose the contents you want to play.

2 From the mobile terminal device, select the AVR-4310CI among the products in the network.

Playback of the contents selected in step 1 begins.

※ When selecting the AVR-4310CI from the mobile terminal device, the name of the AVR-4310CI is displayed at "Friendly Name" (☞ page 40 "Friendly Name Edit").

※ The following operations are possible from the mobile terminal device:

- File operations (play, stop, pause, track search)
- Play mode settings (repeat/random)
- Volume adjustment

Playing Contents on a Mobile Terminal Device

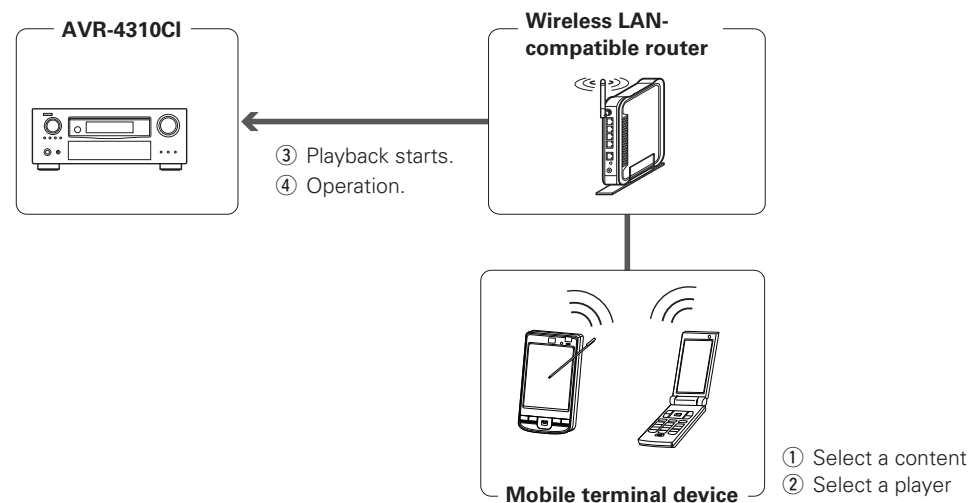

1 Select the contents you want to play from among the mobile terminal devices.

2 From the mobile terminal device, select the AVR-4310CI among the products in the network.

Playback of the contents selected in step 1 begins.

※ When selecting the AVR-4310CI from the mobile terminal device, the name of the AVR-4310CI is displayed at "Friendly Name" (☞ page 40 "Friendly Name Edit").

※ The following operations are possible from the mobile terminal device:

- File operations (play, stop, pause, track search)
- Play mode settings (repeat/random)
- Volume adjustment



- "📶" is displayed on the GUI screen while the mobile terminal device is being operated.
- For the various settings and operating procedures, see the operating instructions of the mobile terminal devices being used.
- When selecting the AVR-4310CI from the mobile terminal device, the name of the AVR-4310CI is displayed at "Friendly Name". "Friendly Name" can be edited at "Friendly Name Edit" (☞ page 40) as desired so that it is easily distinguishable from other devices.
- When playback is started from the mobile terminal device, the AVR-4310CI's input source automatically switches to "NET/USB". Also, when the "Network Standby" setting (☞ page 40) is set to "ON", the power automatically turns on.

NOTE

When operations related to browsing or playback (play, stop, pause, track search) are performed on the AVR-4310CI while operating the mobile terminal device, the connection to the network is disconnected. The network connection is also disconnected when the party mode is started.

Operating the AVR-4310CI with a Browser (Web Control Function)

You can operate the AVR-4310CI using a browser.

1 Switch “ON” the “Network Standby” setting (☞ page 40).

2 Check the AVR-4310CI’s IP address with “Network Information” (☞ page 41).

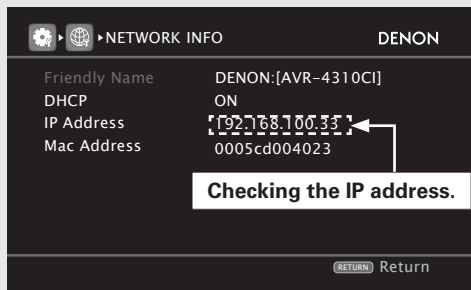

3 Enter the AVR-4310CI IP address in browser’s address box.

For example, if the IP address of AVR-4310CI is “192.168.100.33”, enter “http://192.168.100.33”.

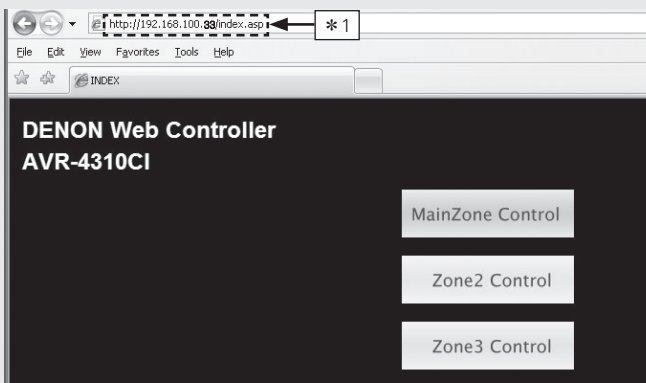

* 1: Entering the IP address.

4 When the top menu is displayed, click on the menu you want to operate.

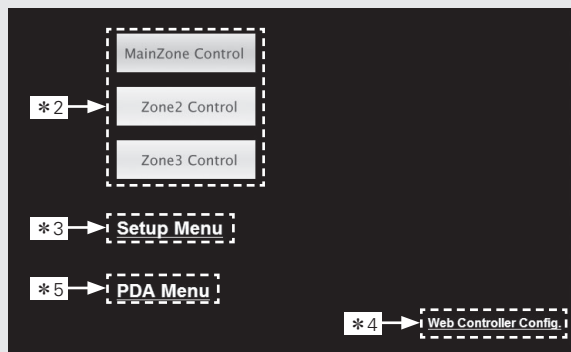

- * 2: Click when you operate each zone (☞ [Example 1])
- * 3: Click when you operate the setup menu (☞ [Example 2])
- * 4: Click to change the Web control screen setting. (☞ [Example 3])
- * 5: Click when you operate a small screen such as a PDA screen, etc. (☞ [Example 4])

5 Operate.

[Example 1] Main zone control screen

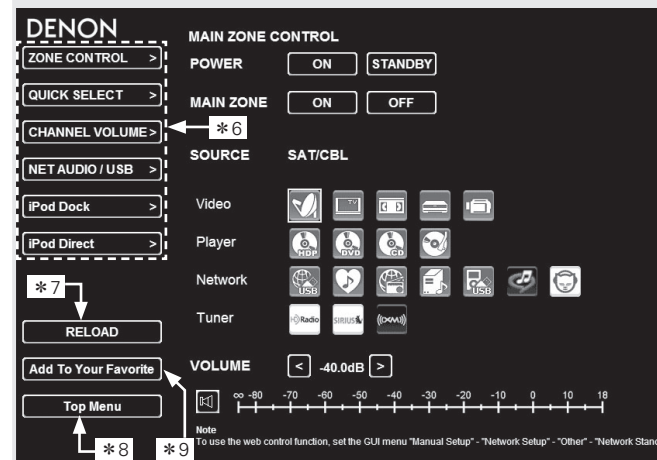

- * 6: Click to perform each operation. Changes to each operation screen (☞ [Example 5])
- * 7: Click when you update to the latest information. Normally, there is a change to the latest information each time you operate. When operated from the main unit, click because the screen is not updated.
- * 8: Click to return to the top menu. Displayed when setting “Top Menu Link Setup” to “ON” in [Example 3]
- * 9: Click to add a setting to the “Favorites” in your browser. We recommend registering the setting screens for the different zones in the browser’s favorites so as not to accidentally perform menu operations for zones you do not intend to operate.

Convenient Functions

[Example 2] Setup menu screen

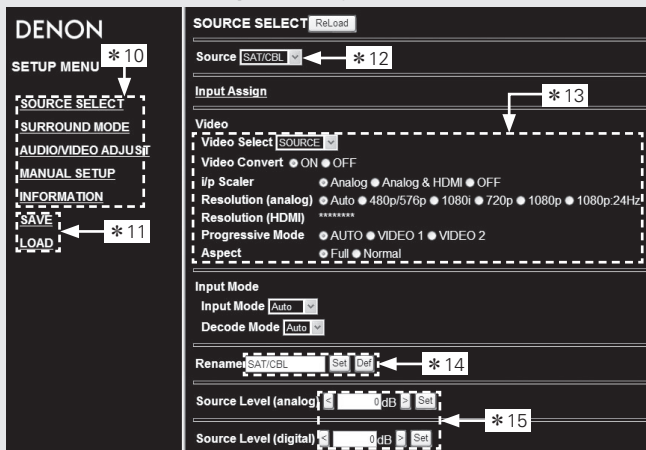

- * 10: Click the menu from which you want to make settings. The display on the right becomes each setting screen.
- * 11: Click "SAVE" when you want to save settings, and click "LOAD" when you want to call settings. Becomes each operation screen.
- * 12: Click "v" and select from the displayed items.
- * 13: Click to determine a setting.
- * 14: After entering characters, click "Set" to set, or click "Def" to return to initial setting.
- * 15: Enter figures or click "<" or ">" to make the setting, and then click "Set".

[Example 3] Web configuration screen

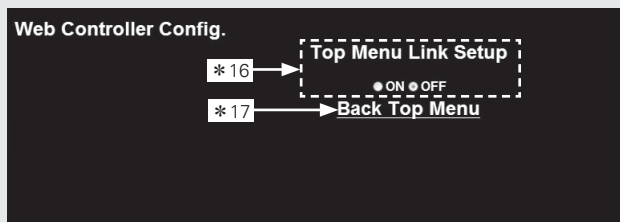

- * 16: Click "ON" when performing Top Menu Link Setup. When set up, return to the top menu from each operation screen. (Default setting: "OFF")
- * 17: Click to return to the top menu.

[Example 4] PDA menu screen

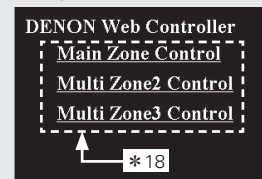

- * 18: Select to operate each zone.

NOTE

You cannot change setup menu operations and zone name on the PDA menu screen.

[Example 5] Net Audio operating screen

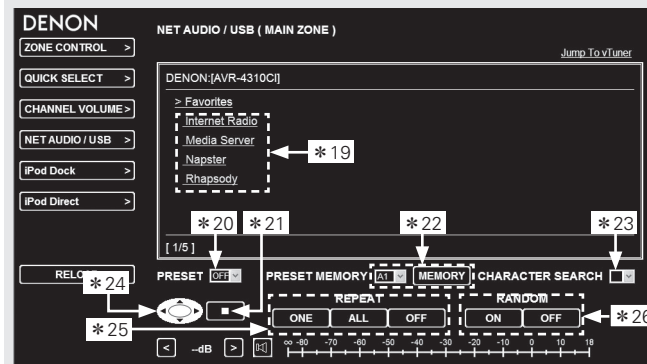

- * 19: Click the menu from which you want to make settings.
- * 20: Click "v" to select the preset channel you want to play.
- * 21: Click to stop play.
- * 22: When registering presets, click "v" to select the channel you want to register, and then click "MEMORY".
- * 23: When searching using an acronym, click "v" and select from the displayed characters.
- * 24: Click when selecting menu.
- * 25: Click to repeat play.
- * 26: Click to random play.

[Example 6] Dedicated iPod Touch screen

※ When accessed from the iPod Touch browser, an optimized operation screen is displayed.

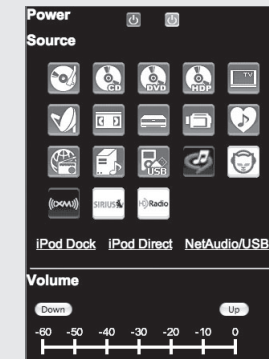

Various Memory Functions

Personal Memory Plus Function

This function sets the settings (input mode, surround mode, MultEQ XT, Dynamic EQ, Dynamic Volume, audio delay etc.) last selected for the individual input sources.

Last Function Memory

This stores the settings as they were directly before the standby mode was set. When the power is turned back on, the settings are restored to as they were directly before the standby mode was set.

Playing in ZONE2/ZONE3 (Multi-zone Function)

This function allows you to play sound in rooms other than the main zone where multi-channel sound is played.



The source selected for ZONE2 is also output from the recording output connectors.

Audio Output

There are two methods to do this, as described below. Choose one of the methods.

- ① Zone playback by speaker output
- ② Zone playback by audio output (PRE OUT)
Use an external amplifier.

① Zone Playback by Speaker Output

The ZONE2 and ZONE3 audio signals are output from the AVR-4310CI's SURR BACK/AMP ASSIGN speaker terminals using the amplifier assignment function.

Connecting and Setting the Speakers

	Amp Assign mode setting (page 34) and the audio signals that are output	Connecting the speakers
ZONE2	ZONE2 Output signal : Stereo (L / R)	
ZONE3	ZONE3 Output signal : Stereo (L / R)	
ZONE2 and ZONE3	ZONE2 (MONO) Output signal : Monaural	

② Zone Playback by Audio Output (PRE OUT)

Audio Connections (ZONE2, ZONE3)

The audio signals of the AVR-4310CI's ZONE2 and ZONE3 audio output terminals are output to the ZONE2 and ZONE3 amplifiers and played on these amplifiers.

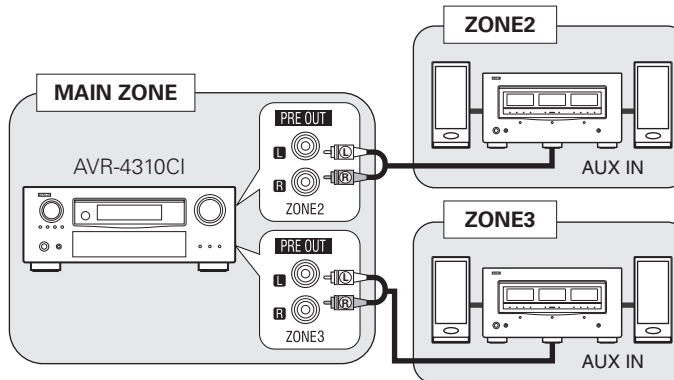

Adjust the volume on the connected amplifier. Also be sure to read the operating instructions of the connected devices.

NOTE

- We recommend using high quality pin-plug cables for audio connections in order to prevent noise.
- When the input source to which the digital input connectors (OPTICAL/COAXIAL) are assigned is selected in ZONE2 or ZONE3, playback is only possible if the digital signal being input is in PCM (2-channel) format.
- It is not possible to play the digital audio signals input from the HDMI or DENON LINK terminals in ZONE2 and ZONE3.
- When certain digital signals are being input, noise may be output from the ZONE2 and ZONE3 audio output connectors.

Video Output

Video Connection

The video signals of the AVR-4310CI's ZONE2 video output terminal are played by the ZONE2 TV.

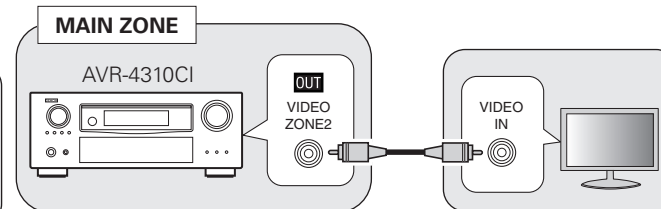

NOTE

It is not possible to output video signals input to the HDMI or component terminals to ZONE2.

Symbols used to indicate buttons in this manual

Button located on both the main unit and the remote control unit → **BUTTON**
 Button only on the main unit → **<BUTTON>**
 Button only on the remote control unit → **[BUTTON]**

<SOURCE SELECT>
<ZONE2/3/ REC SELECT> **<MASTER VOLUME>**

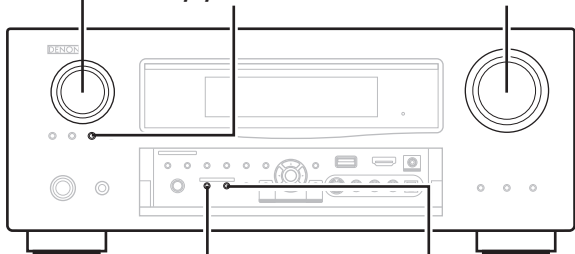

<ZONE2 ON/OFF> **<ZONE3 ON/OFF>**

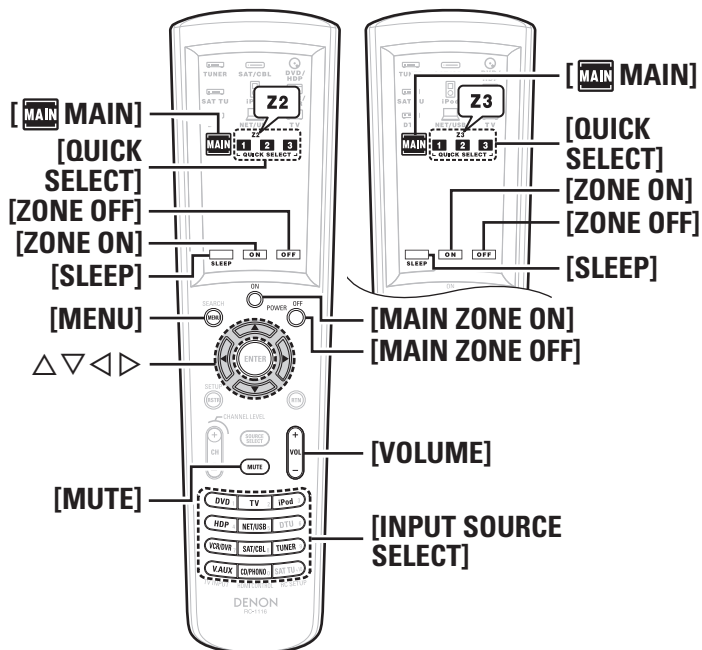

Sub remote control unit

Playback

The operating procedure is the same for "① Zone Playback by Speaker Output" and "② Zone Playback by Audio Output (PRE OUT)".

- 1 Turn on the AVR-4310CI's power.**
 (☞ page 24 "Turning the Power On")

- 2 Turn on the zone power.**

Operation on the main unit

Press **<ZONE2 ON/OFF>** or **<ZONE3 ON/OFF>** for the zone to be operated.

When the power turns on, the "**Z2**" or "**Z3**" indicator lights on the display.

Operation on the remote control unit

Press **[MAIN]** to display the mode for the zone to be operated, the press **[ZONE ON]**.

When the power turns on, the "**Z2**" or "**Z3**" indicator lights on the display.

※ Also press **[INPUT SOURCE SELECT]** when in standby mode, the power turns on.

※ When using ZONE2 or ZONE3, it is possible to turn the power for the MAIN ZONE only on or off by pressing **[MAIN ZONE ON]** or **[MAIN ZONE OFF]**.

- 3 Select the input source.**

Operation on the main unit

- ① Press **<ZONE2/3/ REC SELECT>** and select the zone to be adjusted.
 ② Turn **<SOURCE SELECT>** to choose the input source.

Operation on the remote control unit

In the zone mode you want to operate, press **[INPUT SOURCE SELECT]**.

※ The same input source as in the main zone can be selected easily by pressing the **[M.ZONE CALL]** on the sub remote control unit.

- 4 Adjust the item below.**

- ❑ **Adjust the Volume**

Operation on the main unit

- ① Press **<ZONE2/3/ REC SELECT>** and select the zone to be adjusted.
 ② Turn **<MASTER VOLUME>** to adjust.

Operation on the remote control unit

In the zone mode whose volume you want to adjust, press **[VOLUME]**.

[Adjustable range] --- **-80dB ~ -40dB ~ 18dB**
 (When the "Volume Display" setting is "Relative")

[Adjustable range] **0 ~ 41 ~ 99**
 (When the "Volume Display" setting is "Absolute")

※ Upon purchase, "Volume Limit" is set to "-10dB (71)".

- ❑ **Turning off the Sound Temporarily (MUTE)**

In the zone mode for which you want to mute the sound, press **[MUTE]**.

The sound is reduced to the level set at menu "Mute Level" (☞ page 42).

- ※ To cancel, either adjust the volume or press **[MUTE]** again.
 ※ The setting is canceled when the zone's power is turned off.

Menu Operation

The settings related to tone adjustment and volume can be made.

1 In the zone mode for which you want to operate, press [MENU].

The ZONE2 or ZONE3 menu is displayed on the ZONE2 monitor.

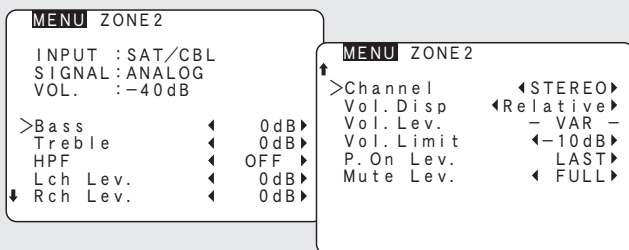

2 Press Δ ∇ \triangleleft \triangleright to select the menu to be set or operated.

3 Press [MENU] to enter the setting.

The on-screen display disappears.



For ZONE2, the "Zone Setup" can be made while watching the on-screen display.

Also, when ZONE3 is operated, the on-screen display appears on the ZONE2 monitor, so operation can be performed watching this on-screen display.

Quick Select Function

It is also possible to save three settings for multi-zone.

1 Set the items below to the settings you want to save.

- ① Input Source (☞ page 87)
- ② Volume Level (☞ page 87)

2 In the zone mode for which you want to operate, press and hold the desired [QUICK SELECT] until "Memory" appears on the on-screen display.

The current settings will be memorized.

[Quick Select Defaults]

	Input Source	Volume
Z2/Z3 Quick Select 1	DVD	-40dB
Z2/Z3 Quick Select 2	SAT/CBL	-40dB
Z2/Z3 Quick Select 3	VCR	-40dB

Calling the Settings Out

Press [QUICK SELECT] at which the settings you want to call out are saved.

Naming Quick Select settings

See "Quick Select Name" (☞ page 43).

Sleep Timer Function

This is convenient for playing sources while going to sleep.

1 Press [MAIN] to display the mode for the zone to be operated.

2 Press [SLEEP] and display the time you want to set.

The time switches as shown below each time [SLEEP] is pressed.

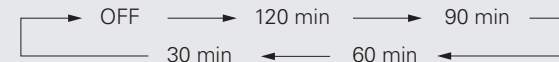

To cancel the sleep timer

Press [SLEEP] to set "OFF".



The sleep timer is also canceled when the AVR-4310CI is set to the standby mode or the ZONE2 or ZONE3 power is turned off.

Operating the Connected Devices by Remote Control Unit

Operating the Main Remote Control Unit

- On the main remote control unit, the display switches according to the device being operated and the mode.
- In the "MAIN", "SAT TU", "DTU", "iPod" and "NET/USB" modes, when the remote ID is set, the AVR-4310CI can be used independently even in an environment containing multiple DENON amplifiers. (See page 93 "Setting the Remote ID")

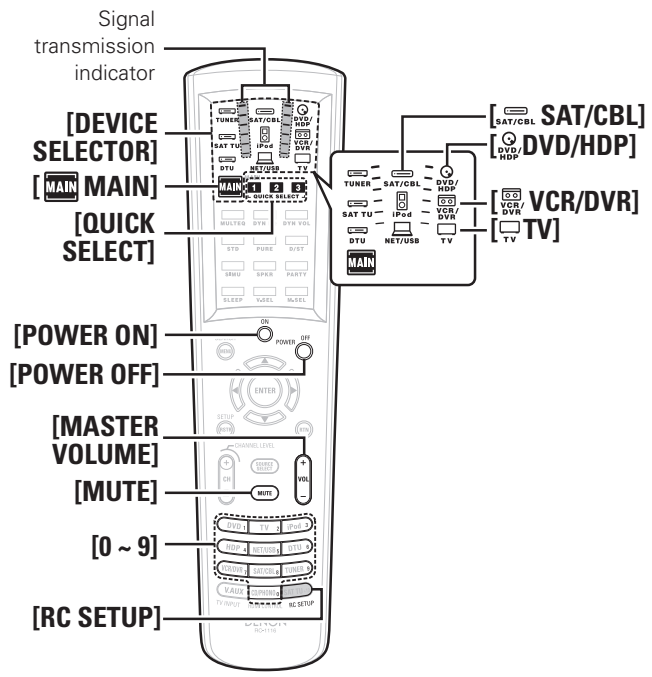

Operating AV Equipment

1 Press [DEVICE SELECTOR] for the component to be operated.
The indicator for the component to be operated flashes.

- : MAIN / ZONE2 / ZONE3 / ZONE4* / MACRO
- : Cannot be used.
- : XM / SIRIUS
- : HD Radio (Digital Tuner)
- : Satellite Receiver / Cable Tuner / IPTV / HDTV (Set Top Box)
- : iPod
- : Network / USB
- : Blu-ray Disc Player / HD DVD Player / DVD Player (Recorder) / CD Player (Recorder)
- : Digital Video Recorder
- : TV

* : The AVR-4310CI cannot be used in the ZONE4 mode.

※ The mode switches each time [MAIN] is pressed.

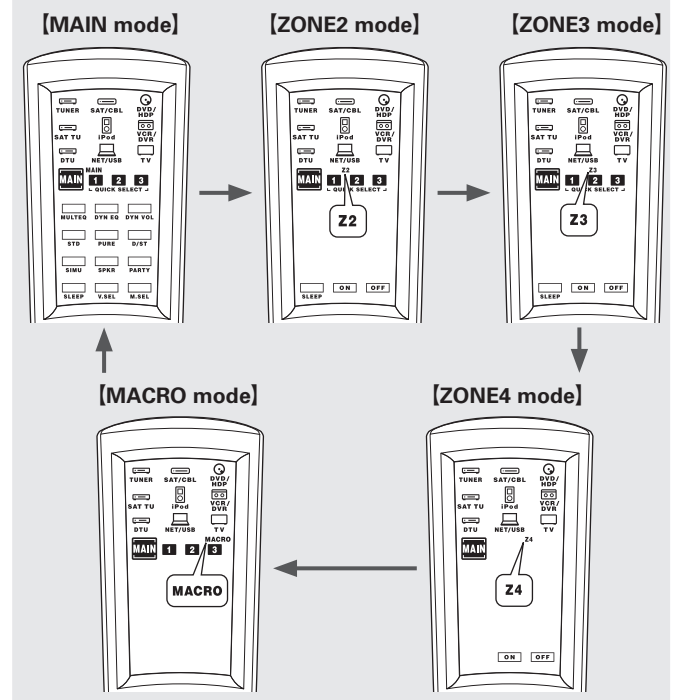

2 Operate the component.

※ For details, refer to the component's operating instructions.

- In ZONE2, ZONE3 and ZONE4 modes, you can switch the main zone power on or off by pressing [POWER ON] or [POWER OFF].
- [QUICK SELECT], [MUTE] and [MASTER VOLUME] can also be operated when the device selected is something other than [MAIN]. In this case, the zone you used last can be operated. Check using the zone indicator.

Presetting

The included main remote control unit can be preset to operate devices of various brands.

1 Press [DVD/HDP], [VCR/DVR], [TV] or [SAT/CABLE] for the device you want to preset.

2 Press and hold in [RC SETUP] for at least 3 seconds. The signal transmission indicator flashes twice.

3 Press [0 ~ 9] and input the 5-digit number of the brand of the component to be preset. The numbers are shown in the Preset Code Table (👉 End of this manual).

When the code is registered, the signal transmission indicator flashes twice.

When the preset code is transmitted, the mode indicator for the component to which that code belongs flashes.

※ The input mode is canceled if no button is operated for 10 seconds.



• Some brands have more than one preset code. If the component does not operate, try inputting a different code.

※ Depending on the model and year of manufacture of your equipment, some buttons may not operate. In such cases we recommend using the learning function. (👉 page 94 "Learning Function")

Operating Preset Components

1 Press [DEVICE SELECTOR] for the component to be operated.
The mode indicator of the device to be operated flashes.

2 Operate the component.

※ For details, refer to the component's operating instructions.

Blu-ray Disc Player / HD DVD Player / DVD Player / DVD Recorder

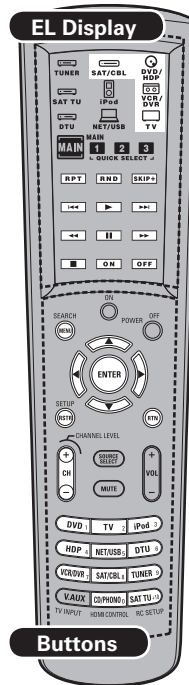

EL Display	
Device select button	DVD/HDP (SAT/CBL VCR/DVR TV) *1
RPT	Repeat
RND	Random
SKIP+	Disc Skip (For charger-compatible devices)
⏮⏪⏩⏭	Auto search (cue)
▶	Playback
⏮⏪⏩⏭	Manual search (fast-reverse/fast-forward)
⏸	Still/Pause
■	Stop
ON	Power on *2
OFF	Power off *2
Buttons	
MENU/SEARCH	(Popup) Menu
△▽◀▶	Cursor
ENTER	Enter
SETUP/RSTR	Setup
RTN	Return
CH +, -	Switch channels (up/down)
0 ~ 9, +10	Select title or chapter or channel selection

*1: Preset registration is also possible for the Device Select buttons in ().

*2: This may power some devices ON/OFF.

CD Player / CD Recorder

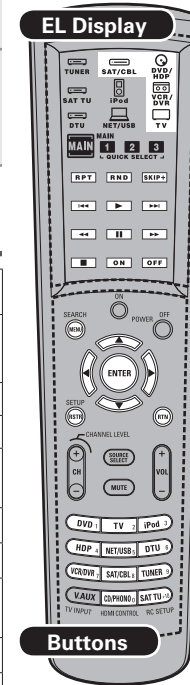

EL Display	
Device select button	DVD/HDP (SAT/CBL VCR/DVR TV) *1
RPT	Repeat
RND	Random
SKIP+	Disc Skip (For charger-compatible devices)
⏮⏪⏩⏭	Auto search (cue)
▶	Playback
⏮⏪⏩⏭	Manual search (fast-reverse/fast-forward)
⏸	Pause
■	Stop
ON	Power on *2
OFF	Power off *2
Buttons	
MENU/SEARCH	Amp menu
△▽◀▶	Amp cursor
ENTER	Amp enter
SETUP/RSTR	RESTORER
RTN	Amp return
0 ~ 9, +10	Track Selection

*1: Preset registration is also possible for the Device Select buttons in ().

*2: This may power some devices ON/OFF.

Digital Video Recorder / Video cassette Recorder / Cassette Deck

TV

Set top box for Satellite / Cable / IP TV / HD TV

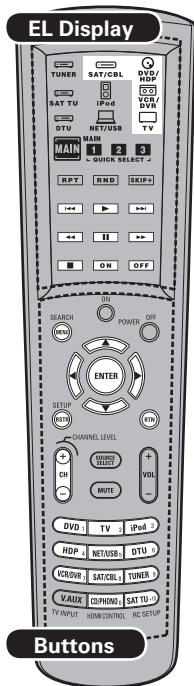

EL Display	
Device select button	* 1
	Auto search (cue)
	Playback
	Manual search (fast-reverse/fast-forward)
	Still/Pause
	Stop
ON	Power on * 2
OFF	Power off * 2
Buttons	
MENU/SEARCH	Menu/guide
	Cursor
ENTER	Enter
SETUP/RSTR	Setup
RTN	Return
CH +, -	Switch channels (up/down)
0 ~ 9, +10	Channel Selection

* 1: Preset registration is also possible for the Device Select buttons in ().
 * 2: This may power some devices ON/OFF.

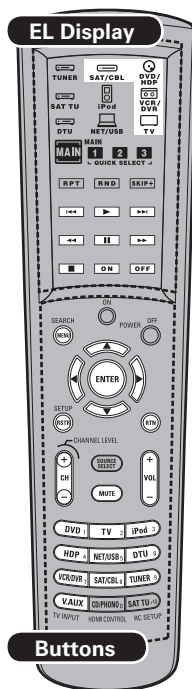

EL Display	
Device select button	* 1
	Auto search (cue)
	Playback
	Manual search (fast-reverse/fast-forward)
	Still/Pause
	Stop
ON	Power on * 2
OFF	Power off * 2
Buttons	
MENU/SEARCH	Menu/guide
	Cursor
ENTER	Enter
SETUP/RSTR	RESTORER
RTN	Return
CH +, -	Switch channels (up/down)
MUTE	TV mute
VOL +, -	TV Volume +, -
1 ~ 9	Channel Selection
TV INPUT	TV inputs

* 1: Preset registration is also possible for the Device Select buttons in ().
 * 2: This may power some devices ON/OFF.

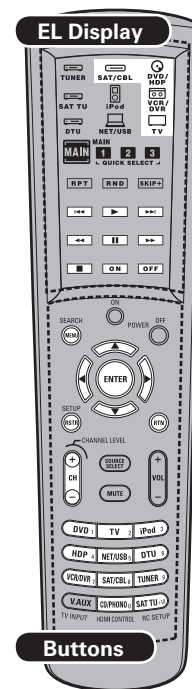

EL Display	
Device select button	* 1
	Auto search (cue)
	Playback
	Manual search (fast-reverse/fast-forward)
	Still/Pause
	Stop
ON	Power on * 2
OFF	Power off * 2
Buttons	
MENU/SEARCH	Menu
	Cursor
ENTER	Enter
SETUP/RSTR	Guide
RTN	Return
CH +, -	Switch channels (up/down)
0 ~ 9, +10	Channel Selection

* 1: Preset registration is also possible for the Device Select buttons in ().
 * 2: This may power some devices ON/OFF.

iPod

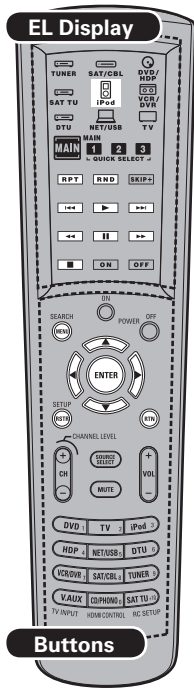

EL Display	
Device select button	iPod
RPT	1-track/All-track repeat play
RND	1-track/album shuffle play
	Auto search (cue)
	Playback
	Manual search (fast-reverse/fast-forward)
	Still/Pause
	Stop
Buttons	
MENU/SEARCH (Press and release)	Page search mode
(Press and hold)	Browse / Remote mode switching
	Cursor
ENTER	Enter
SETUP/RSTR	RESTORER
RTN	Return

XM / SIRIUS

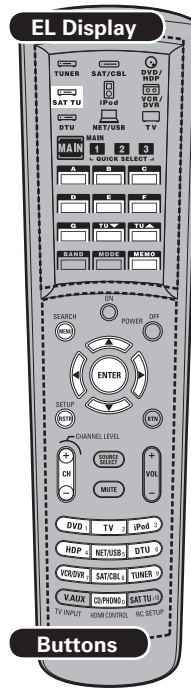

EL Display	
Device select button	SAT TU
A ~ G	Preset memory block selection
TU	Channel selection
MEMO	Preset memory registration
Buttons	
MENU/SEARCH	Direct search
	Category search
ENTER (press and hold)	To parental lock password check screen (SIRIUS)
SETUP/RSTR	RESTORER
CH +/-	Preset channel selection
0 ~ 9	Preset channel selection (1 ~ 8) / Direct channel search (0 ~ 9)

HD Radio

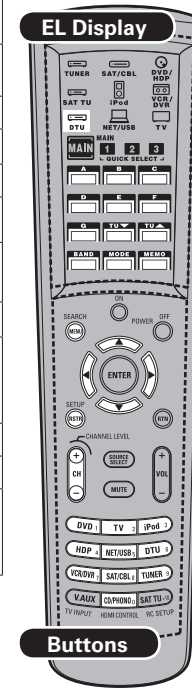

EL Display	
Device select button	DTU
A ~ G	Preset memory block selection
TU	Tuning +/-
BAND	AM/FM switching
MODE	Switch search modes
MEMO	Preset memory registration
Buttons	
MENU/SEARCH	Direct Frequency tuning
	Multi cast switching ()
SETUP/RSTR	RESTORER
CH +/-	Preset channel selection
0 ~ 9	Preset channel selection (1 ~ 8) / Direct frequency tuning (0 ~ 9)

NET/USB

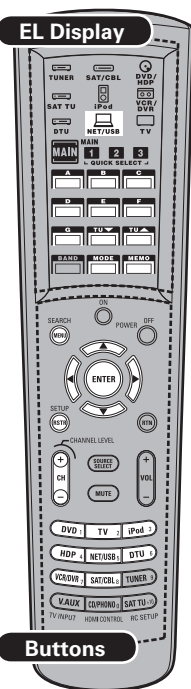

EL Display	
Device select button	NET/USB
A ~ G	Preset memory block selection
TU ▲▼	Switching picture
MODE	Direct play (Rhapsody)
MEMO	Preset memory registration
Buttons	
MENU/SEARCH	Page Search / Character Search
△▼◀▶	Cursor
ENTER	Enter
SETUP/RSTR	RESTORER
CH +/-	Preset channel selection
1 ~ 8	Preset channel selection (1 ~ 8)

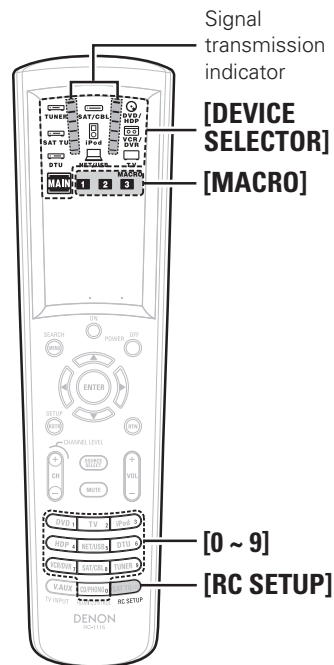
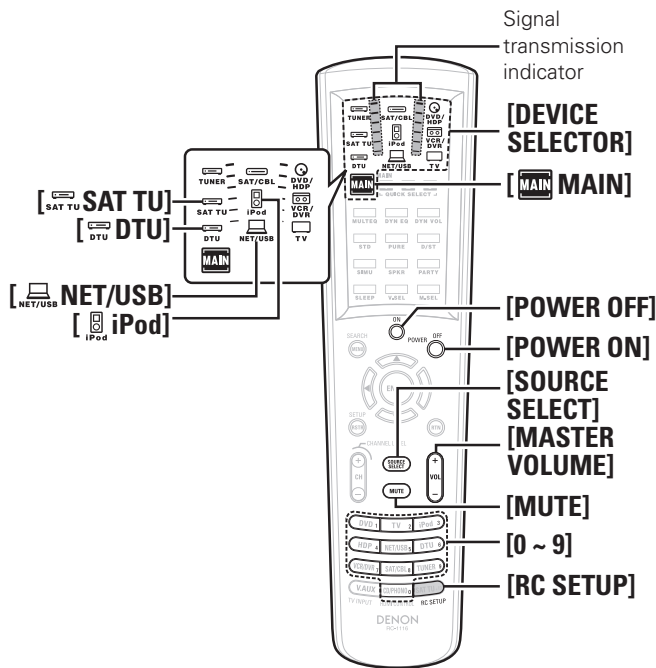

Setting the Remote ID

When using multiple DENON AV receivers in the same room, make this setting so that only the desired AV receiver operates.

- 1 Press [MAIN] to light the “MAIN” zone indicator.
- 2 Press and hold in [RC SETUP] for at least 3 seconds. The signal transmission indicator flashes twice.
- 3 Refer to the table at the right, and use [0 ~ 9] to input the 5-digit number corresponding to the remote ID to be changed. The signal transmission indicator flashes twice.
- 4 Press [SAT TU], [DTU], [iPod] or [NET/USB] to select the mode to be set.
- 5 Repeat steps 2 to 4 to set the remote IDs for all modes.

Remote ID	DEVICE SELECTOR				
	MAIN	SATTU (SIRIUS, XM)	iPod	DTU	NET/USB
1 (Default)	81001	52415	72815	62840	62865
2	82001	52416	72816	62841	62837
3	83001	52417	72817	62842	62838
4	84001	52418	72818	62843	62839

NOTE

- When changing a setting, be sure to set the same remote ID as the AVR-4310CI's (page 44).
- When changing the MAIN mode's remote ID, also change the “SAT TU”, “DTU”, “iPod”, and “NET/USB” remote ID at the same time.

Learning Function

If your AV devices are of a brand other than DENON or if they cannot be operated with the preset memory function, their remote control signals can be transferred to stored in the AVR-4310CI's main remote control unit.

1 Press and hold in [RC SETUP] for at least 3 seconds.
The signal transmission indicator flashes twice.

2 Press [9], [7] and [5], in that order.
The signal transmission indicator flashes twice and the learning mode is set.

3 Press [DEVICE SELECTOR] for the device you want to set

4 Press the button to be set.
The main remote control unit's display turns off.

※ If a button that cannot be learned is pressed, the signal transmission indicator lights but the signal is not learned.

5 Point the main remote control units directly at each other and press and hold the button on the other device's remote control unit that you want to learn.
Once learning is completed normally, the display lights and the signal transmission indicator flashes twice.

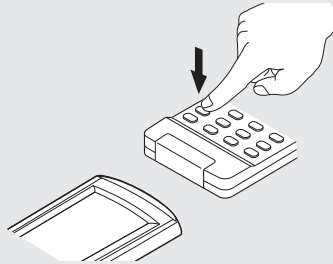

※ If you want to learn other buttons, repeat steps 4 and 5.
 ※ The mode can be switched by pressing [DEVICE SELECTOR].
 ※ The signal transmission indicator lights once for a long time if learning was not possible

6 Press and hold in [RC SETUP] for at least 3 seconds.
The signal transmission indicator flashes twice and the setting is completed.



- With some remote control units, the signals cannot be learned or the device will not operate properly even when the signals have been learned. In this case, use the device's own remote control unit.
- Learned buttons have priority over the preset memory. If you no longer need the learned setting, reset the learning function (☞ page 96).

NOTE

- [POWER ON], [POWER OFF] and [SOURCE SELECT] cannot be learned.
- Do not learn any remote control signals at [RC SETUP].
- The MAIN, ZONE2, ZONE3, ZONE4 and MACRO modes cannot be learned.
- Codes cannot be learned at [MASTER VOLUME] or [MUTE] when the main remote control unit is set to "TUNER", "SAT TU", "DTU", "NET/USB" or "iPod".

MACRO Function

This function lets you register a series of operations at a single button.

For example, the amplifier can be turned on, the input source selected, the monitor's power turned on, the source device's power turned on and the play mode set all by pressing a single button.

Up to 32 signals each can be registered at [MACRO] (1 ~ 3).

Registering

1 Press and hold in [RC SETUP] for at least 3 seconds.
The signal transmission indicator flashes twice.

2 Press [9], [7] and [8], in that order.
The signal transmission indicator flashes twice and the system call registration mode is set.

3 Press [MACRO] (1 ~ 3) at which you want to register the signals.

4 Press the buttons you want to register in the same sequence as the operations you want to perform.
The signal transmission indicator lights when a button is pressed.

Example : Press [POWER ON].



Press [DEVICE SELECTOR] – [DVD/HDP].



Press [▶].

※ The mode can be switched by pressing [DEVICE SELECTOR].

※ Perform the registration procedure for all the buttons you want to register.

5 Press and hold in [RC SETUP] for at least 3 seconds.
The signal transmission indicator flashes twice and the setting is completed.

NOTE

Registration is not possible in ZONE2, ZONE3, ZONE4 and MACRO modes.

Operating the Main Remote Control Unit

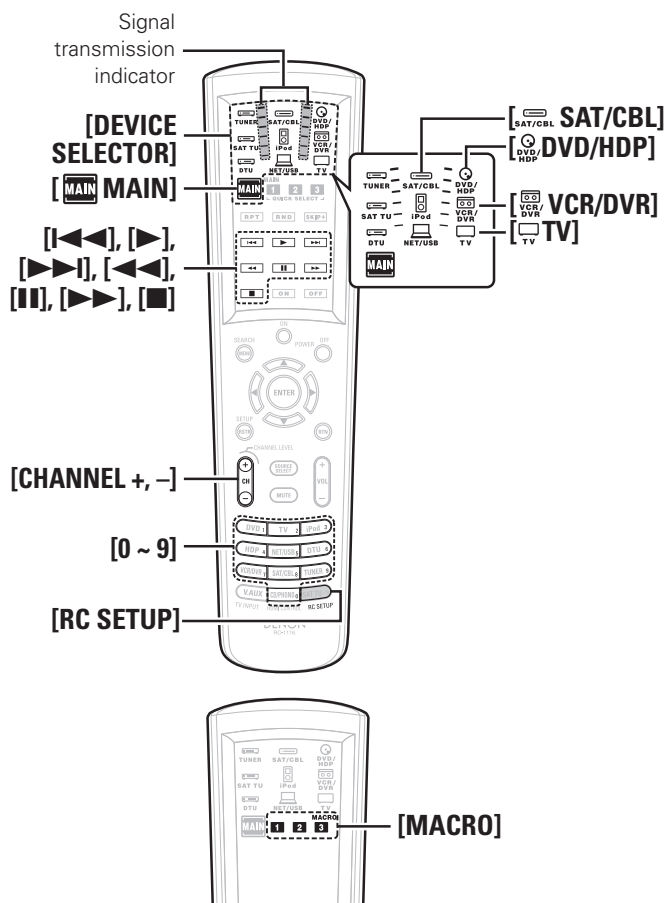

Calling out

- 1 Press [MAIN], to select “MACRO”.
- 2 Press [MACRO] (1 ~ 3) at which the signals were registered.
The registered signals are transmitted in the registered sequence.

Punch Through Function

DVD/HDP (including BD and CD) or VCR/DVR mode buttons can be stored at unused TV or SAT/CBL mode buttons. For example, when DVD mode buttons are assigned to the TV mode, the DVD mode operations can be performed while in the TV mode.

- 1 Press and hold in [RC SETUP] for at least 3 seconds.
The signal transmission indicator flashes twice.
- 2 Press [9], [8] and [4], in that order.
The signal transmission indicator flashes twice and the punch through setting mode is set.
- 3 Press [DEVICE SELECTOR] for the device you want to punch through ([DVD/HDP] or [VCR/DVR]).
- 4 Press the button you want to punch through ([>>], [II], [<<<], [>>>], [I<<<], [I>>>] or [III]).
Each time the button is pressed, the signal transmission indicator flashes once.
- 5 Press [DEVICE SELECTOR] for the device you want to punch through ([TV] or [SAT/CBL]).
- 6 Press and hold in [RC SETUP] for at least 3 seconds.
The signal transmission indicator flashes twice and the setting is completed.

Setting the Time the Backlight Stays Lit

- 1 Press and hold in [RC SETUP] for at least 3 seconds.
The signal transmission indicator flashes twice.
- 2 Press [9], [7] and [3], in that order.
The signal transmission indicator flashes twice and the backlight on time setting mode is set.
- 3 Set the light on time.
The signal transmission indicator flashes twice.
[Settable times] : [1] : 5 sec.
[2] : 10 sec. (Default)
[3] : 15 sec.
[4] : 20 sec.
[5] : 25 sec.

Adjusting the Backlight's Brightness

The display's brightness can be adjusted in 5 steps.
(Default: Step 5)

- 1 Press and hold in [RC SETUP] for at least 3 seconds.
The signal transmission indicator flashes twice.
- 2 Press [CHANNEL +] or [CHANNEL -].
The display gets one step brighter when [CHANNEL +] is pressed.
The display gets one step darker when [CHANNEL -] is pressed.
- 3 Press [RC SETUP] to complete the setting.

Specifying the Zone Used with the Main Remote Control

When the [MAIN] Device Select button is pressed, only the set zone can be operated with the main remote control unit.

1 Press [MAIN] to light the “MAIN” zone indicator.

2 Press and hold in [RC SETUP] for at least 3 seconds.
The signal transmission indicator flashes twice.

3 Press [9], [9] and [9], in that order.
The signal transmission indicator flashes twice and the backlight on time setting mode is set.

4 Press [1 ~ 4] to set.
The signal transmission indicator flashes twice.

[Settable items]

[1] : When only using “MAIN” / “MACRO”

[2] : When using “MAIN” / “Z2” / “MACRO”

[3] : When using “MAIN” / “Z2” / “Z3” / “MACRO”

[4] : When using “MAIN” / “Z2” / “Z3” / “Z4” / “MACRO”
(Default)

Resetting the Main Remote Control Unit

Learning Function

❑ Resetting Button by Button

1 Press and hold in [RC SETUP] for at least 3 seconds.
The signal transmission indicator flashes twice.

2 Press [9], [7] and [6], in that order.
The signal transmission indicator flashes twice.

3 Press the button you want to reset twice.
The signal transmission indicator flashes twice.

❑ Resetting by Device Mode

1 Press and hold in [RC SETUP] for at least 3 seconds.
The signal transmission indicator flashes twice.

2 Press [9], [7] and [6], in that order.
The signal transmission indicator flashes twice.

3 Press [DEVICE SELECTOR] for the device you want to reset twice.
The signal transmission indicator flashes twice.

MACRO Function

1 Press and hold in [RC SETUP] for at least 3 seconds.
The signal transmission indicator flashes twice.

2 Press [9], [7] and [8], in that order.
The signal transmission indicator flashes twice.

3 Press [MACRO] (1 ~ 3) you want to reset.

4 Press and hold in [RC SETUP] for at least 3 seconds.
The signal transmission indicator flashes twice.

Punch-Through Function

1 Press and hold in [RC SETUP] for at least 3 seconds.
The signal transmission indicator flashes twice.

2 Press [9], [8] and [4], in that order.
The signal transmission indicator flashes twice.

3 Press and hold in [RC SETUP] for at least 3 seconds.
The signal transmission indicator flashes twice.

All Settings

1 Press and hold in [RC SETUP] for at least 3 seconds.
The signal transmission indicator flashes twice.

2 Press [9], [8] and [1], in that order.
The signal transmission indicator flashes 4 times.
All the settings are restored to their defaults.

Operating the Sub Remote Control Unit

- The sub remote control unit is equipped with frequently used buttons, so it can be used for simple remote control unit operations.
- The sub remote control unit can also be used for multi-zone, so you can use it to control the AVR-4310CI from other rooms.
- The operations listed below can be performed with the sub remote control unit.
 - Switching the input source
 - Adjusting the volume
 - XM, SIRIUS, HD Radio and iPod operations
 - NET/USB direct play
 - GUI menu and ZONE2 on-screen display operations
 - Zone power on/off
- It is not possible to operate devices other than the amplifier.



The AVR-4310CI cannot be used in the ZONE4 mode.

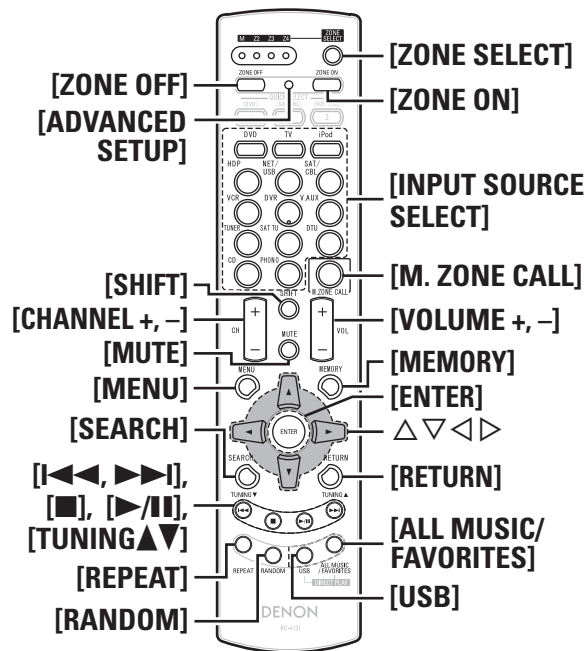

Functions of Buttons by Component

Device operated	DTU (HD Radio)			SAT TU (XM, SIRIUS)			NET/USB			iPod		
	M	Z2	Z3	M	Z2	Z3	M	Z2	Z3	M	Z2	Z3
ZONE SELECT	Zone operation mode selection											
ZONE OFF	Power turned off (※1)											
ZONE ON	Power turned on (※1)											
INPUT SOURCE SELECT	Input source selection											
CHANNEL + / -	Preset channel selection									-		
SHIFT	Preset channel memory block selection									-		
VOLUME + / -	Adjustment of volume (※1)											
MUTE	Muting (※1)											
MENU	Selected zone menu											
MEMORY	Preset memory registration									-		
△ ∇ ◀ ▶	Multicast switching (△ ∇) / Cursor			Category search / Cursor			Cursor					
ENTER	-			To Parental Lock password check screen			Enter					
SEARCH	-			-			Page forward screen / Character search			Page forward screen / Browse/Remote mode switching (press and hold)		
RETURN	-			-			Return			Return		
I<<< >>>I, TUNING Δ ∇	Tuning			Channel selection			Track search					
■	-			-			Stop					
▶/II	-			-			Play/pause					
REPEAT	-			-			1-track/All-track repeat play			1-track/All-track repeat play		
RANDOM	-			-			1-track random play			1-track/album shuffle play		
USB	-			-			※2					
ALL MUSIC * (Music server only)	-			-			※3					
FAVORITES *	-			-			※4					

※1: Affects the currently selected zone.

※2: The input source switches to "NET/USB" and the files on the USB memory device are played.

※3: The input source switches to "NET/USB" and the files in "All Music" on the music server are played.

※4: The input source switches to "NET/USB" and the files in "Favorites" are played.

*: Whether "All Music" or "Favorites" is selected depends on the "Direct Play" setting (page 51).

DIRECT PLAY button

- Playback is possible in the mode selected at GUI menu "Direct Play".
- FAVORITES:** Playback starts from the first track registered in the favorites.
- ALL MUSIC:** Playback starts from the first track registered in the "All Music" folder.
- When **[USB]** is pressed, playback starts from the first track on the USB memory device.

NOTE

When the music server is stopped or restarted, it may no longer be possible to play tracks stored in the favorites.

Switching Zones

Use this procedure to select the zone to be operated by the sub remote control unit.

1 Press [ZONE SELECT].

The currently selected multi-zone indicator lights.

2 While the multi-zone indicator is light, press [ZONE SELECT] to select the zone to be operated.

The currently selected multi-zone indicator lights.

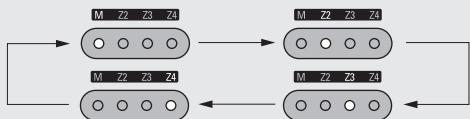

Switching the Multi-zone Input Source to the Same Input Source as Used in the MAIN ZONE

This function is convenient for example when you want to listen to the same song as the one playing in the MAIN ZONE while in a different zone.

1 Press [ZONE SELECT] and set to ZONE2 or ZONE3.

The currently selected multi-zone indicator lights.

2 Press [M.ZONE CALL] on the sub remote control unit.

The multi-zone input source switches to the MAIN ZONE's input source.

NOTE

- This cannot be used for the MAIN ZONE or ZONE4.
- When [M.ZONE CALL] is pressed while the multi-zone power is off, the multi-zone power turns on and the input source switches to the MAIN ZONE's input source.

Setting the Zone for Which the Sub Remote Control Unit is Used (ZONE SELECT LOCK Mode)

We recommend always using the sub remote control unit for the same room. When this is done, the unit can be set so that the zone does not switch when buttons are operated.

1 Use the tip of a pen to press [ADVANCED SETUP].

All the multi-zone indicators light.

2 Select the multi-zone to be set.

The selected multi-zone indicator lights.

- ① To set to "MAIN ZONE" : Press [REPEAT].
- ② To set to "ZONE2" : Press [RANDOM].
- ③ To set to "ZONE3" : Press [USB].
- ④ To set to "ZONE4" : Press [ALL MUSIC/FAVORITES].

3 Use the tip of a pen to press [ADVANCED SETUP].

The multi-zone indicator turns off.

To Cancel

1 Use the tip of a pen to press [ADVANCED SETUP].

The currently selected multi-zone indicator lights.

2 Press [ZONE SELECT].

All the multi-zone indicators light.

3 Use the tip of a pen to press [ADVANCED SETUP].

The multi-zone indicator turns off.

Setting the Remote ID

When using multiple DENON AV receivers in the same room, make this setting so that no AV receiver other than the desired one operates.

1 While pressing [MENU], press [ADVANCED SETUP] with the tip of a pen.

The multi-zone indicator corresponding to the currently selected remote ID flashes.

2 Select the remote ID to be set.

- ① To set to 1 : Press [REPEAT].
The "M" indicator flashes.
- ② To set to 2 : Press [RANDOM].
The "Z2" indicator flashes.
- ③ To set to 3 : Press [USB].
The "Z3" indicator flashes.
- ④ To set to 4 : Press [ALL MUSIC/FAVORITES].
The "Z4" indicator flashes.

3 While pressing [MENU], press [ADVANCED SETUP] with the tip of a pen.

The multi-zone indicator turns off.

NOTE

When changing a setting, be sure to set the same remote ID as the AVR-4310CI's (page 44).

Resetting the Settings

While pressing [ZONE OFF], press [ADVANCED SETUP] with the tip of a pen.

All the multi-zone indicators flash 4 times, then all the settings are restored to their defaults.

Other Information

Explanation of Terms

The AVR-4310CI is equipped with a digital signal processing circuit that lets you play program sources in the surround mode to achieve the same sense of presence as in a movie theater.

Dolby Digital

Dolby Digital

Dolby Digital is a multi-channel digital signal format developed by Dolby Laboratories.

A total of 5.1-channels are played: 3 front channels (“FL”, “FR” and “C”), 2 surround channels (“SL” and “SR”) and the “LFE” channel for low frequencies.

Because of this, there is no crosstalk between channels and a realistic sound field with a “three-dimensional” feeling (sense of distance, movement and positioning) is achieved.

A real, overpowering sense of presence is achieved when playing movie sources in AV rooms as well.

Dolby Digital Plus

Dolby Digital Plus is an improved Dolby Digital signal format that is compatible with up to 7.1-channels of discrete digital sound and also improves sound quality thanks to extra data bit rate performance. It is upwardly compatible with conventional Dolby Digital, so it offers greater flexibility in response to the source signal and the conditions of the playback equipment.

Dolby TrueHD

Dolby TrueHD is a high definition audio technology developed by Dolby Laboratories, using lossless coding technology to faithfully reproduce the sound of the studio master.

This format is compatible with a maximum sampling frequency of 96 kHz and up to 7.1-channels, so it is used for applications particularly prioritizing sound quality.

Dolby Pro Logic II

Dolby Pro Logic II is a matrix decoding technology developed by Dolby Laboratories.

Regular music such as that on CDs is encoded into 5-channels to achieve an excellent surround effect.

The surround channel signals are converted into stereo and full band signals (with a frequency response of 20 Hz to 20 kHz or greater) to create a “three-dimensional” sound image offering a rich sense of presence for all stereo sources.

Dolby Pro Logic IIx

Dolby Pro Logic IIx is a further improved version of the Dolby Pro Logic II matrix decoding technology.

Audio signals recorded in 2-channels are decoded to achieve a natural sound with up to 7.1-channels.

There are 3 modes: “Music” suited for playing music, “Cinema” suited for playing movies, and “Game” which is optimized for playing games.

Dolby Digital EX

Dolby Digital EX is a 6.1-channel surround format proposed by Dolby Laboratories that allows users to enjoy in their homes the “DOLBY DIGITAL SURROUND EX” audio format jointly developed by Dolby Laboratories and Lucas Films.

The 6.1 channels of sound, including surround back channels, provide improved sound positioning and expression of space.

Dolby Pro Logic IIz

Dolby Pro Logic IIz introduces a new dimension to Home Entertainment through the addition of a pair of front height channels. Compatible with stereo, 5.1 and 7.1 content, Dolby Pro Logic IIz provides enhanced spaciousness, depth and dimension to movies, concert video and video game playback while maintaining the full integrity of the source mix.

Dolby Pro Logic IIz identifies and decodes spatial cues that occur naturally in all content, directing this information to the front height channels, complementing the performance of left and right surround sound speakers. Content that is encoded with Dolby Pro Logic IIz height channel information can be even more revealing, with perceptually discrete height channel information bringing an exciting new dimension to home entertainment.

Dolby Pro Logic IIz, with front height channels is also an ideal alternative for households that cannot support the placement of back surround speakers of a typical 7.1 channel system but may have bookshelf space available to support the addition of height speakers.

Manufactured under license from Dolby Laboratories. “Dolby”, “Pro Logic” and the double-D symbol are trademarks of Dolby Laboratories.

DTS Surround

DTS Digital Surround

DTS Digital Surround is the standard digital surround format of DTS, Inc., compatible with a sampling frequency of 44.1 or 48 kHz and up to 5.1-channels of digital discrete surround sound.

DTS-HD High Resolution Audio

DTS-HD High Resolution Audio is an improved version of the conventional DTS, DTS-ES and DTS 96/24 signals formats, compatible with sampling frequencies of 96 or 48 kHz and up to 7.1-channels of discrete digital sound. High data bit rate performance provides high quality sound. This format is fully compatible with conventional products, including conventional DTS digital surround 5.1-channel data.

DTS-HD Master Audio

DTS-HD Master Audio is DTS, Inc.’s lossless audio format compatible with up to 96 kHz/7.1-channels. The lossless audio coding technology faithfully reproduces the sound of the studio master. It is fully compatible with conventional products, including conventional DTS digital surround 5.1-channel data.

DTS-ES™ Discrete 6.1

DTS-ES™ Discrete 6.1 is a 6.1-channel discrete digital audio format adding a surround back (SB) channel to the DTS digital surround sound.

Decoding of conventional 5.1-channel audio signals is also possible according to the decoder.

DTS-ES™ Matrix 6.1

DTS-ES™ Matrix 6.1 is a 6.1-channel discrete digital audio format inserting a surround back (SB) channel to the DTS digital surround sound through matrix encoding. Decoding of conventional 5.1-channel audio signals is also possible according to the decoder.

DTS NEO:6™ Surround

DTS NEO:6™ is a matrix decoding technology for achieving 6.1-channel surround playback with 2-channel sources. It includes “DTS NEO:6 Cinema” suited for playing movies and “DTS NEO:6 Music” suited for playing music.

DTS 96/24

DTS 96/24 is a digital audio format enabling high sound quality playback in 5.1-channels with a sampling frequency of 96 kHz and 24 bit quantization on DVD-Video.

DTS Express

DTS Express is an audio format supporting low bit rates (max. 5.1-channels, 24 to 256 kbps).

Manufactured under license under U.S. Patent #'s: 5,451,942; 5,956,674; 5,974,380; 5,978,762; 6,226,616; 6,487,535; 7,212,872; 7,333,929; 7,392,195; 7,272,567 & other U.S. and worldwide patents issued & pending. DTS is a registered trademark and the DTS logos, Symbol, DTS-HD and DTS-HD Master Audio are trademarks of DTS, Inc. © 1996-2008 DTS, Inc. All Rights Reserved.

Neural Surround

Neural Surround™, a breakthrough in audio technology, will bring the excitement of surround music to more of America's listening audience. It provides the rich envelopment and discrete image detail of surround sound in a format 100 % compatible with stereo. With superior spectral resolution and channel separation, Neural Surround™ draws the brain's attention to sonic details in musical instruments, vocals, and ambience that are typically masked by other playback systems. This allows the listener to fully experience the richness and subtleties in recorded performance as never before. As the chosen format for XM Satellite Radio's new XM HD surround programming, Neural Surround will help deliver more surround music to more listeners than any other broadcast format. XM Satellite Radio will be the first radio company to broadcast surround sound on the radio 24 hours a day and will offer three channels fully dedicated to Neural Surround™ music. This alone will amount to more than 25,000 hours of Neural Surround™ music each year.



This product is manufactured under license from Neural Audio Corporation.

D&M Holdings Inc. hereby grants the user a non-exclusive, nontransferable, limited license right exercisable to use the NA SURROUND Technology and other US and World Wide Patents Pending technology.

"Neural" and "Neural Audio" and "Neural Surround" are trademarks of Neural Audio Corporation. All Rights Reserved.

Audyssey

Audyssey MultEQ® XT

Audyssey MultEQ XT is a room equalization solution that calibrates any audio system so that it can achieve optimum performance for every listener in a large listening area. Based on several room measurements, MultEQ XT calculates an equalization solution that corrects for both time and frequency response problems in the listening area and also performs a fully automated surround system setup.

Audyssey Dynamic EQ™

Audyssey Dynamic EQ solves the problem of deteriorating sound quality as volume is decreased by taking into account human perception and room acoustics. Audyssey Dynamic EQ works in tandem with Audyssey MultEQ XT to provide well-balanced sound for every listener at any volume level.

Audyssey Dynamic Volume™

Audyssey Dynamic Volume solves the problem of large variations in volume level between television programs, commercials, and between the soft and loud passages of movies.

Audyssey Dynamic EQ is integrated into Dynamic Volume so that as the playback volume is adjusted automatically, the perceived bass response, tonal balance, surround impression, and dialog clarity remain the same.

Audyssey Dynamic Surround Expansion™ (DSX)

Realistic reproduction of sound relies on the ability of audio systems to match human hearing performance. Three key requirements are: (1) frequency response; (2) dynamic range; and (3) accurate spatial reproduction. The requirements for frequency response have already been surpassed with sampling rates that exceed human hearing. The dynamic range limits of human perception have also been met with current digital audio systems operating capable of signal to noise ratios that approach 120 dB. Accurate spatial sound rendering, however, has not yet reached the limits of perception as human perception relies on the combination of sounds arriving from many more directions than what 5.1 surround sound systems provide. Audyssey DSX technology was developed to overcome the spatial sound rendering limitations faced by 5.1 surround sound formats.

The ITU 5.1 channel standard recommends three front loudspeakers and two rear loudspeakers. The Left (L) and Right (R) front loudspeakers should be placed at $\pm 30^\circ$ relative to the central listening position. The Center (C) loudspeaker should be at 0° and the surround loudspeakers (SL, SR) should be placed between 100° and 120° . All loudspeakers must be equidistant from the center listening position or compensated with time delay if that is not possible. A separate low-frequency effects (LFE) channel is used to reproduce additional bass content from the subwoofer.

There are certain things that 5.1 surround sound systems do well compared to 2-channel stereo. For example, it is possible to move sounds across the front seamlessly. It is also possible to create ambience behind the listener. But 5.1 channel surround systems do not provide enough channels from which to render the required reflected sound components for a seamless and enveloping soundstage. Unfortunately, the additional two back surround channels in 7.1 systems are not in the right place to provide a significant perceptual improvement.

Adding more channels to a surround system is not for special effects. Accurate spatial sound reproduction requires rendering of directional sound cues and non-directional ambient cues. Reflections arriving after the direct sound play a critical role in the perception of soundstage width and depth. To have the most impact, additional surround channels should be used to control the direction, time of arrival, and frequency response of the reflected sound to render an expanded soundstage that reproduces sound with better localization and envelopment than what 5.1 systems provide.

Explanation of Terms

Research in the perception of auditory source width has shown that there are strong preferences in the direction of reflected sound and the perception of soundstage width and spaciousness. The single most important direction of side-wall reflections is $\pm 60^\circ$. DSX provides a pair of Wide channels (LW and RW) at $\pm 60^\circ$ with appropriate frequency response and perceptual processing to match the requirements of human hearing. In fact, the Wide channels are much more critical in the presentation of a realistic soundstage than then Back Surround channels found in traditional 7.1 systems. A more enveloping 7.1 channel system is one in which Wide speakers are used instead of Back Surround speakers. Adding surround channels behind the listener has a very small impact compared to the increase in envelopment and soundstage width that the front wide channels will provide.

After side reflections, the next most important acoustical and perceptual cues come from reflections above the front stage. DSX provides a pair of Height channels (LH and RH) at a $\pm 45^\circ$ azimuth angle and elevated to a 45° angle in the median plane.

In addition to creating new Wide and Height channels, DSX also provides Surround Processing to enhance the envelopment of the Surround and Back Surround channels (if present). DSX Surround Processing processes the standard surround signals in the time and frequency domains to improve the perceived sense of envelopment and blending with the other speakers in the surround system.

Audyssey Dynamic Surround Expansion is a scalable system that can adapt to the practical needs of the user. The first level of surround stage enhancement comes from adding the Wide channels. The second level comes from adding the Height channels. If it is practical to have both Wides and Heights then the surround performance will be further enhanced. DSX automatically reconfigures its processing to optimize surround rendering over any number of available speakers beyond 5.1.



Manufactured under license from Audyssey Laboratories. U.S. and foreign patents pending. Audyssey MultEQ[®] XT is a registered trademark of Audyssey Laboratories. Audyssey Dynamic EQ[™] is a trademark of Audyssey Laboratories. Audyssey Dynamic Volume[™] is a trademark of Audyssey Laboratories. Audyssey Dynamic Surround Expansion[™] is a trademark of Audyssey Laboratories.

HDCD[®]

HDCD[®] is an encoding/decoding technology that greatly reduces the distortion that occurs upon digital recording while maintaining compatibility with the conventional CD format, thus expanding the dynamic range and achieving a high resolution. Conventional CDs and HDCD compatible CDs are identified automatically to select the optimum digital processing.

HDCD[®], HDCD[®], High Definition Compatible Digital[®] and Microsoft[®] are either registered trademarks or trademarks of Microsoft Corporation, Inc. in the United States and/or other countries. HDCD system manufactured under license from Microsoft Corporation, Inc. This product is covered by one or more of the following: In the USA: 5,479,168, 5,638,074, 5,640,161, 5,808,574, 5,838,274, 5,854,600, 5,864,311, 5,872,531, and in Australia: 669114. Other patents pending.

DENON LINK

DENON LINK is a unique digital, balanced transfer type interface developed by DENON. It offers high speed, high quality transfer of digital audio data with low signal loss. It can be used together with DENON AV Amplifier equipped with a special DENON LINK connector using a single cable to enable playback with high sound quality. It allows digital transfer of the 192 kHz/24 bit 2-channel digital signals of DVD-Audio discs, PCM multi-channel signals, etc. Full-spec digital transfer of the audio contents of Super Audio CD is possible by connecting a player equipped for DENON LINK 3rd Edition.

During processing of DENON LINK, the “**D.LINK**” indicator of the display lights.

DENON LINK 4th uses the clock of the AV amplifier connected by DENON LINK to achieve HDMI signal transfer with little jitter when playing BD.

AL24 Processing Plus

AL24 Processing for All Channels

DENON has further developed its proprietary AL24 Processing, an analog waveform reproduction technology, to support the 192 kHz sampling frequency. AL24 Processing Plus, thoroughly suppresses quantization noise associated with D/A conversion of LPCM signals to reproduce the low-level signals with optimum clarity that will bring out all the delicate nuances of the music.

Equipped for not only front left and right channels but also for the surround left and right, center and subwoofer channels.

About Networks

Windows Media Player Ver.11

This is a media player distributed free of charge by Microsoft Corporation.

It can be used to play playlists created with Windows Media Player Ver. 11 as well as files in such formats as WMA, DRM WMA, MP3 and WAV.

vTuner

This is a free online contents server for Internet radio. Note that usage fees are included in upgrade costs.

For inquiries about this service, visit the vTuner site below.

vTuner website: <http://www.radiodemon.com>

This product is protected by certain intellectual property rights of Nothing Else Matters Software and BridgeCo. Use or distribution of such technology outside of this product is prohibited without a license from Nothing Else Matters Software and BridgeCo or an authorized subsidiary.

DLNA

- DLNA and DLNA CERTIFIED are trademarks and/or service marks of Digital Living Network Alliance.
- Some contents may not be compatible with other DLNA CERTIFIED[™] products.

Windows Media DRM

A copyright-protected technology developed by Microsoft.

Content providers are using the digital rights management technology for Windows Media contained in this device (WM-DRM) to protect the integrity of their content (Secure Content) so that their intellectual property, including copyright, in such content is not misappropriated. This device uses WM-DRM software to play Secure Content (WM-DRM Software). If the security of the WM-DRM Software in this device has been compromised, owners of Secure Content (Secure Content Owners) may request that Microsoft revoke the WM-DRM Software's right to acquire new licenses to copy, display and/or play Secure Content. Revocation does not alter the WM-DRM Software's ability to play unprotected content. A list of revoked WM-DRM Software is sent to your device whenever you download a license for Secure Content from the Internet or from a PC. Microsoft may, in conjunction with such license, also download revocation list onto your device on behalf of Secure Content Owners.

Surround

Surround Modes and Parameters

Surround Mode	Signals and adjustability in the different modes															
	Channel output							Parameter (default values are shown in parentheses)								
	Front L/R	Center	Surround L/R	Surround Back L/R	Subwoofer	Front Wide L/R	Front Height L/R	D. COMP *1	DRC *2	LFE *3	AFDM *3	Surround Back	Cinema EQ.	Mode	Room Size	Effect Level
PURE DIRECT, DIRECT (2ch)	○	×	×	×	◎*4	×	×	○ (OFF)	○ (Auto)	○ (0 dB)	×	×	×	×	×	×
DSD DIRECT	○	×	×	×	×	×	×	×	×	×	×	×	×	×	×	×
DSD MULTI DIRECT	○	◎	◎	◎	◎	×	×	×	×	○ (0 dB)	×	○	×	×	×	×
MULTI CH DIRECT	○	◎	◎	◎	◎	×	×	×	×	○ (0 dB)	○ (ON)	○	×	×	×	×
STEREO	○	×	×	×	◎	×	×	○ (OFF)	○ (Auto)	○ (0 dB)	×	×	×	×	×	×
EXT. IN	○	◎	◎	◎	◎	×	×	×	×	×	×	×	×	×	×	×
MULTI CH IN	○	◎	◎	◎	◎	◎ (NOTE4)	◎ (NOTE4)	×	×	○ (0 dB)	○ (ON)	○	○ (OFF)	×	×	×
WIDE SCREEN	○	◎	◎	◎	◎	◎	◎	○ (OFF)	○ (Auto)	○ (0 dB)	×	○	○ (OFF)	×	×	○ (ON, 10)
DOLBY PRO LOGIC IIz	○	◎	◎	×	◎	×	◎	○ (OFF)	○ (Auto)	×	×	×	○ (OFF)	○ (Height)	×	×
DOLBY PRO LOGIC IIx	○	◎	◎	◎	◎	×	×	○ (OFF)	○ (Auto)	×	×	○	○ (NOTE1)	○ (Cinema)	×	×
DOLBY PRO LOGIC II	○	◎	◎	×	◎	◎ (NOTE4)	◎ (NOTE4)	○ (OFF)	○ (Auto)	×	×	○	○ (NOTE2)	○ (Cinema)	×	×
DTS NEO:6	○	◎	◎	◎	◎	◎ (NOTE4)	◎ (NOTE4)	○ (OFF)	○ (Auto)	×	×	○	○ (NOTE1)	○ (Cinema)	×	×
DOLBY DIGITAL	○	◎	◎	◎	◎	◎ (NOTE4)	◎ (NOTE3)	○ (OFF)	×	○ (0 dB)	○ (ON)	○	○ (OFF)	×	×	×
DOLBY DIGITAL Plus	○	◎	◎	◎	◎	◎ (NOTE4)	◎ (NOTE3)	○ (OFF)	×	○ (0 dB)	○ (ON)	○	○ (OFF)	×	×	×
DOLBY TrueHD	○	◎	◎	◎	◎	◎ (NOTE4)	◎ (NOTE3)	×	○ (Auto)	○ (0 dB)	○ (ON)	○	○ (OFF)	×	×	×
DTS SURROUND	○	◎	◎	◎	◎	◎ (NOTE4)	◎ (NOTE3)	○ (OFF)	×	○ (0 dB)	○ (ON)	○	○ (OFF)	×	×	×
DTS 96/24	○	◎	◎	◎	◎	◎ (NOTE4)	◎ (NOTE3)	○ (OFF)	×	○ (0 dB)	○ (ON)	○	○ (OFF)	×	×	×
DTS-HD	○	◎	◎	◎	◎	◎ (NOTE4)	◎ (NOTE3)	○ (OFF)	×	○ (0 dB)	○ (ON)	○	○ (OFF)	×	×	×
DTS EXPRESS	○	◎	◎	◎	◎	◎ (NOTE4)	◎ (NOTE3)	○ (OFF)	×	○ (0 dB)	○ (ON)	○	○ (OFF)	×	×	×
neural	○	◎	◎	◎	◎	◎ (NOTE4)	◎ (NOTE4)	×	×	×	×	○	×	×	×	×
7CH STEREO	○	◎	◎	◎	◎	◎	◎	○ (OFF)	○ (Auto)	○ (0 dB)	×	○	×	×	×	×
SUPER STADIUM	○	◎	◎	◎	◎	◎	◎	○ (OFF)	○ (Auto)	○ (0 dB)	×	○	×	×	○ (Medium)	○ (10)
ROCK ARENA	○	◎	◎	◎	◎	◎	◎	○ (OFF)	○ (Auto)	○ (0 dB)	×	○	×	×	○ (Medium)	○ (10)
JAZZ CLUB	○	◎	◎	◎	◎	◎	◎	○ (OFF)	○ (Auto)	○ (0 dB)	×	○	×	×	○ (Medium)	○ (10)
CLASSIC CONCERT	○	◎	◎	◎	◎	◎	◎	○ (OFF)	○ (Auto)	○ (0 dB)	×	○	×	×	○ (Medium)	○ (10)
MONO MOVIE	○	◎	◎	◎	◎	◎	◎	○ (OFF)	○ (Auto)	○ (0 dB)	×	○	×	×	○ (Medium)	○ (10)
VIDEO GAME	○	◎	◎	◎	◎	◎	◎	○ (OFF)	○ (Auto)	○ (0 dB)	×	○	×	×	○ (Medium)	○ (10)
MATRIX	○	◎	◎	◎	◎	◎	◎	○ (OFF)	○ (Auto)	○ (0 dB)	×	○	×	×	×	×
VIRTUAL	○	×	×	×	◎	×	×	○ (OFF)	○ (Auto)	○ (0 dB)	×	×	×	×	×	×

○ : Signal / Adjustable

× : No signal / Not adjustable

◎ : Turned on or off by speaker configuration setting

NOTE1 : This parameter is available when the "Mode" is set to "Cinema" (page 73).

NOTE2 : This parameter is available when the "Mode" is set to "Cinema" or "ProLogic" (page 73).

NOTE3 : This parameter is available when the "Front Height" is set to "ON" or "DSX" is set to "ON" (page 74, 76).

NOTE4 : This parameter is available when the "DSX" is set to "ON" (page 76).

NOTE:

* 1 : When playing Dolby Digital and DTS signals.

* 2 : When playing Dolby TrueHD signal.

* 3 : When playing Dolby Digital, DTS, DVD-Audio and Super Audio CD.

* 4 : When the "Subwoofer Mode" is set to "LFE+Main" (page 35) only.

Surround

Surround Mode	Signals and adjustability in the different modes													
	Parameter (default values are shown in parentheses)													
	Delay Time	Subwoofer	Front Height	PRO LOGIC II/IIx MUSIC mode only			NEO:6 MUSIC mode only	EXT. IN only	Tone Control	MultEQ XT	Dynamic EQ	Dynamic Volume	RESTORER	DSX
Panorama				Dimension	Center Width	Center Image	Subwoofer Att.							
PURE DIRECT, DIRECT (2ch)	×	○	×	×	×	×	×	×	×	×	×	×	×	×
DSD DIRECT	×	×	×	×	×	×	×	×	×	×	×	×	×	×
DSD MULTI DIRECT	×	×	×	×	×	×	×	×	×	×	×	×	×	×
MULTI CH DIRECT	×	×	×	×	×	×	×	×	×	×	×	×	×	×
STEREO	×	×	×	×	×	×	×	×	○ (OFF)	○ (OFF)	○	○	○	×
EXT. IN	×	×	×	×	×	×	×	○	×	×	×	×	×	×
MULTI CH IN	×	×	○	×	×	×	×	×	○ (OFF)	○ (OFF)	○	○	×	○
WIDE SCREEN	×	×	×	×	×	×	×	×	○ (OFF)	○ (OFF)	○	○	○	×
DOLBY PRO LOGIC IIz	×	×	○	×	×	×	×	×	○ (OFF)	○ (OFF)	○	○	○	×
DOLBY PRO LOGIC IIx	×	×	○	○ (OFF)	○ (3)	○ (3)	×	×	○ (OFF)	○ (OFF)	○	○	○	×
DOLBY PRO LOGIC II	×	×	○	○ (OFF)	○ (3)	○ (3)	×	×	○ (OFF)	○ (OFF)	○	○	○	○
DTS NEO:6	×	×	×	×	×	×	○ (0.3)	×	○ (OFF)	○ (OFF)	○	○	○	○
DOLBY DIGITAL	×	×	○	×	×	×	×	×	○ (OFF)	○ (OFF)	○	○	×	○
DOLBY DIGITAL Plus	×	×	○	×	×	×	×	×	○ (OFF)	○ (OFF)	○	○	×	○
DOLBY TrueHD	×	×	○	×	×	×	×	×	○ (OFF)	○ (OFF)	○	○	×	○
DTS SURROUND	×	×	○	×	×	×	×	×	○ (OFF)	○ (OFF)	○	○	×	○
DTS 96/24	×	×	○	×	×	×	×	×	○ (OFF)	○ (OFF)	○	○	×	○
DTS-HD	×	×	○	×	×	×	×	×	○ (OFF)	○ (OFF)	○	○	×	○
DTS EXPRESS	×	×	○	×	×	×	×	×	○ (OFF)	○ (OFF)	○	○	×	○
neural	×	×	×	×	×	×	×	×	○ (OFF)	○ (OFF)	○	○	○	○
7CH STEREO	×	×	×	×	×	×	×	×	○ (OFF)	○ (OFF)	○	○	○	×
SUPER STADIUM	×	×	×	×	×	×	×	×	○ (NOTE5)	○ (OFF)	○	○	○	×
ROCK ARENA	×	×	×	×	×	×	×	×	○ (NOTE6)	○ (OFF)	○	○	○	×
JAZZ CLUB	×	×	×	×	×	×	×	×	○ (OFF)	○ (OFF)	○	○	○	×
CLASSIC CONCERT	×	×	×	×	×	×	×	×	○ (OFF)	○ (OFF)	○	○	○	×
MONO MOVIE	×	×	×	×	×	×	×	×	○ (OFF)	○ (OFF)	○	○	○	×
VIDEO GAME	×	×	×	×	×	×	×	×	○ (OFF)	○ (OFF)	○	○	○	×
MATRIX	○ (30 ms)	×	×	×	×	×	×	×	○ (OFF)	○ (OFF)	○	○	○	×
VIRTUAL	×	×	×	×	×	×	×	×	○ (OFF)	○ (OFF)	○	○	○	×

○ : Signal / Adjustable

×

NOTE5 : BASS +6 dB, TREBLE 0 dB

NOTE6 : BASS +6 dB, TREBLE +4 dB

Differences in Surround Mode Names Depending on the Input Signals

Button	Surround Mode	Note	Input signals																				
			ANALOG	LINEAR PCM / WAV	WMA (Windows Media Audio) / MP3 / MPEG-4 AAC / FLAC	DTS-HD		DTS					DOLBY		DOLBY DIGITAL					MULTI CH PCM		Super Audio CD	
						DTS-HD Master Audio	DTS-HD High Resolution Audio	DTS EXPRESS	DTS ES DSCRT (With Flag)	DTS ES MTRX (With Flag)	DTS (5.1ch)	DTS 96/24	DOLBY TrueHD	DOLBY DIGITAL Plus	DOLBY DIGITAL EX (With Flag)	DOLBY DIGITAL EX (With no Flag)	DOLBY DIGITAL (5.1/5/4ch)	DOLBY DIGITAL (4/3ch)	DOLBY DIGITAL (2ch)	PCM (multi ch)	PCM (2ch)	DSD (multi ch)	DSD (2ch)
STANDARD																							
DTS SURROUND																							
	DTS-HD MSTR		×	×	×	●	×	×	×	×	×	×	×	×	×	×	×	×	×	×	×	×	
	DTS-HD HI RES		×	×	×	×	●	×	×	×	×	×	×	×	×	×	×	×	×	×	×	×	
	DTS ES DSCRT6.1	*1	×	×	×	×	×	×	●◎	×	×	×	×	×	×	×	×	×	×	×	×	×	
	DTS ES MTRX6.1	*1	×	×	×	×	×	×	●◎	×	×	×	×	×	×	×	×	×	×	×	×	×	
	DTS SURROUND		×	×	×	×	×	×	○	○	●	×	×	×	×	×	×	×	×	×	×	×	
	DTS 96/24		×	×	×	×	×	×	×	×	●	×	×	×	×	×	×	×	×	×	×	×	
	DTS (-HD) + PLIIx CINEMA	*2	×	×	×	○	○	○	○	○	○	×	×	×	×	×	×	×	×	×	×	×	
	DTS (-HD) + PLIIx MUSIC	*1	×	×	×	○	○	○	○	○	○	×	×	×	×	×	×	×	×	×	×	×	
	DTS (-HD) + PLIIz HEIGHT	*3	×	×	×	○	○	○	○	○	○	×	×	×	×	×	×	×	×	×	×	×	
	DTS EXPRESS		×	×	×	×	×	●	×	×	×	×	×	×	×	×	×	×	×	×	×	×	
	DTS (-HD) + NEO:6	*1	×	×	×	○	○	○	×	○	○	○	×	×	×	×	×	×	×	×	×	×	
	DTS NEO:6 CINEMA		○	○	○	×	×	×	×	×	×	×	×	×	×	×	×	×	○	×	○	×	
	DTS NEO:6 MUSIC		○	○	○	×	×	×	×	×	×	×	×	×	×	×	×	×	○	×	○	×	
DOLBY SURROUND																							
	DOLBY TrueHD		×	×	×	×	×	×	×	×	×	×	●	×	×	×	×	×	×	×	×	×	
	DOLBY DIGITAL+		×	×	×	×	×	×	×	×	×	×	×	●	×	×	×	×	×	×	×	×	
	DOLBY DIGITAL EX	*1	×	×	×	×	×	×	×	×	×	×	×	×	○	○	○	×	×	×	×	×	
	DOLBY (D+) (HD) +EX	*1	×	×	×	×	×	×	×	×	×	×	○	○	×	×	×	×	×	×	×	×	
	DOLBY DIGITAL		×	×	×	×	×	×	×	×	×	×	×	×	○	●	●	●	×	×	×	×	
	DOLBY (D) (D+) (HD) +PLIIx CINEMA	*2	×	×	×	×	×	×	×	×	×	○	○	●◎	○	○	○	×	×	×	×	×	
	DOLBY (D) (D+) (HD) +PLIIx MUSIC	*1	×	×	×	×	×	×	×	×	×	○	○	○	○	○	○	×	×	×	×	×	
	DOLBY (D) (D+) (HD) +PLIIz HEIGHT	*3	×	×	×	×	×	×	×	×	×	○	○	○	○	○	○	×	×	×	×	×	
	DOLBY PRO LOGIC IIz HEIGHT	*3	○	○	○	×	×	×	×	×	×	×	×	×	×	×	×	○	×	○	×	○	
	DOLBY PRO LOGIC IIx CINEMA	*1	○	○	○	×	×	×	×	×	×	×	×	×	×	×	×	○	×	○	×	○	
	DOLBY PRO LOGIC IIx MUSIC	*1	○	○	○	×	×	×	×	×	×	×	×	×	×	×	×	○	×	○	×	○	
	DOLBY PRO LOGIC IIx GAME	*1	○	○	○	×	×	×	×	×	×	×	×	×	×	×	×	○	×	○	×	○	
	DOLBY PRO LOGIC II CINEMA		○	○	○	×	×	×	×	×	×	×	×	×	×	×	×	○	×	○	×	○	
	DOLBY PRO LOGIC II MUSIC		○	○	○	×	×	×	×	×	×	×	×	×	×	×	×	○	×	○	×	○	
	DOLBY PRO LOGIC II GAME		○	○	○	×	×	×	×	×	×	×	×	×	×	×	×	○	×	○	×	○	
	DOLBY PRO LOGIC		○	○	○	×	×	×	×	×	×	×	×	×	×	×	×	○	×	○	×	○	
	neural		○	○	○	×	×	×	×	×	×	×	×	×	×	×	×	○	×	○	×	○	

NOTE:

- *1: This mode is not available when the surround back speaker setup is set to "None".
- *2: This mode is not available when the surround back speaker setup is set to "1sprkr" or "None".
- *3: This mode is not available when the front height speaker setup is set to "None".

- : Mode selectable in initial status
- ◎ : Mode fixed when "AFDM" is "ON"
- : Selectable mode
- × : Non-selectable mode

Surround

Button	Surround Mode	Note	Input signals																					
			ANALOG	LINEAR PCM / WAV	WMA (Windows Media Audio) / MP3 / MPEG-4 AAC / FLAC	DTS-HD		DTS					DOLBY		DOLBY DIGITAL					MULTI CH PCM		Super Audio CD		
						DTS-HD Master Audio	DTS-HD High Resolution Audio	DTS EXPRESS	DTS ES DSCRT (With Flag)	DTS ES MTRX (With Flag)	DTS (5.1ch)	DTS 96/24	DOLBY TrueHD	DOLBY DIGITAL Plus	DOLBY DIGITAL EX (With Flag)	DOLBY DIGITAL EX (With no Flag)	DOLBY DIGITAL (5.1/5/4ch)	DOLBY DIGITAL (4/3ch)	DOLBY DIGITAL (2ch)	PCM (multi ch)	PCM (2ch)	DSD (multi ch)	DSD (2ch)	
STANDARD																								
MULTI CH IN																								
	MULTI CH IN		×	×	×	×	×	×	×	×	×	×	×	×	×	×	×	×	×	×	●	×	●	×
	MULTI IN + PLIIx CINEMA	*2	×	×	×	×	×	×	×	×	×	×	×	×	×	×	×	×	×	×	○	×	○	×
	MULTI IN + PLIIx MUSIC	*1	×	×	×	×	×	×	×	×	×	×	×	×	×	×	×	×	×	×	○	×	○	×
	MULTI IN + PLIIz HEIGHT	*3	×	×	×	×	×	×	×	×	×	×	×	×	×	×	×	×	×	×	○	×	○	×
	MULTI IN + DOLBY EX	*1	×	×	×	×	×	×	×	×	×	×	×	×	×	×	×	×	×	×	○	×	○	×
	MULTI CH IN 7.1	*1	×	×	×	×	×	×	×	×	×	×	×	×	×	×	×	×	×	×	● ◎ (7.1)	×	×	×
DIRECT																								
	DIRECT		○	○	○	○	○	○	○	○	○	○	○	○	○	○	○	○	○	○	×	○	×	○
	DSD DIRECT		×	×	×	×	×	×	×	×	×	×	×	×	×	×	×	×	×	×	×	×	×	○
	DSD MULTI DIRECT		×	×	×	×	×	×	×	×	×	×	×	×	×	×	×	×	×	×	×	×	○	×
	MULTI CH DIRECT		×	×	×	×	×	×	×	×	×	×	×	×	×	×	×	×	×	×	○	×	○	×
	M DIRECT + PLIIx CINEMA	*2	×	×	×	×	×	×	×	×	×	×	×	×	×	×	×	×	×	×	○	×	○	×
	M DIRECT + PLIIx MUSIC	*1	×	×	×	×	×	×	×	×	×	×	×	×	×	×	×	×	×	×	○	×	○	×
	M DIRECT + DOLBY EX	*1	×	×	×	×	×	×	×	×	×	×	×	×	×	×	×	×	×	×	○	×	○	×
	M DIRECT 7.1	*1	×	×	×	×	×	×	×	×	×	×	×	×	×	×	×	×	×	×	○ (7.1)	×	×	×
PURE DIRECT																								
	PURE DIRECT		○	○	○	○	○	○	○	○	○	○	○	○	○	○	○	○	○	○	×	○	×	○
	DSD PURE DIRECT		×	×	×	×	×	×	×	×	×	×	×	×	×	×	×	×	×	×	×	×	×	○
	DSD MULTI PURE DIRECT		×	×	×	×	×	×	×	×	×	×	×	×	×	×	×	×	×	×	×	×	○	×
	MULTI CH PURE DIRECT		×	×	×	×	×	×	×	×	×	×	×	×	×	×	×	×	×	×	○	×	○	×
	M PURE D + PLIIx CINEMA	*2	×	×	×	×	×	×	×	×	×	×	×	×	×	×	×	×	×	×	○	×	○	×
	M PURE D + PLIIx MUSIC	*1	×	×	×	×	×	×	×	×	×	×	×	×	×	×	×	×	×	×	○	×	○	×
	M PURE D + DOLBY EX	*1	×	×	×	×	×	×	×	×	×	×	×	×	×	×	×	×	×	×	○	×	○	×
	M CH PURE DIRECT 7.1	*1	×	×	×	×	×	×	×	×	×	×	×	×	×	×	×	×	×	×	○ (7.1)	×	×	×

NOTE :

- *1: This mode is not available when the surround back speaker setup is set to "None".
- *2: This mode is not available when the surround back speaker setup is set to "1spkr" or "None".
- *3: This mode is not available when the front height speaker setup is set to "None".

● : Mode selectable in initial status

○ : Selectable mode

× : Non-selectable mode

Relationship Between Video Signals and Monitor Output

Video Convert	MAIN ZONE MONITOR OUT															
	Input Signals				Output Signals				GUI menu displayed							
	HDMI	COMPONENT	S-VIDEO	VIDEO	HDMI	COMPONENT	S-VIDEO	VIDEO	HDMI	COMPONENT	S-VIDEO	VIDEO				
ON/OFF	×	×	×	×	×	×	×	×	Only the GUI menu is displayed							
ON	×	×	×	○	VIDEO	VIDEO	VIDEO	VIDEO	○ (VIDEO)	○ (VIDEO)	○ (VIDEO)	○ (VIDEO)				
ON	×	×	○	×	S-VIDEO	S-VIDEO	S-VIDEO	S-VIDEO	○ (S-VIDEO)	○ (S-VIDEO)	○ (S-VIDEO)	○ (S-VIDEO)				
ON	×	×	○	○ (S-VIDEO)					○ (S-VIDEO)	○ (S-VIDEO)	○ (S-VIDEO)					
ON	×	○ (1080p)	×	×	COMPONENT	COMPONENT	×	×	○ (COMPONENT)	×	×	×				
ON	×	○ (1080i ~ 480p)	×	×			COMPONENT	COMPONENT		×	×	○ (COMPONENT)	○ (COMPONENT)	○ (COMPONENT)		
ON	×	○ (480i/576i)	×	×			×	×	×	×	×	×	×			
ON	×	○ (1080p)	×	○			VIDEO	VIDEO	×	×	○ (VIDEO)	○ (VIDEO)	○ (VIDEO)			
ON * 1	×	○ (1080p)	×	○			×	×	×	×	○ (VIDEO)	○ (VIDEO)	○ (VIDEO)			
ON	×	○ (1080i ~ 480p)	×	○			×	×	×	×	×	×	×			
ON	×	○ (480i/576i)	×	○			COMPONENT	COMPONENT	○ (COMPONENT)	○ (COMPONENT)	○ (COMPONENT)	○ (COMPONENT)	○ (COMPONENT)			
ON	×	○ (1080p)	○	×			×	×	×	×	×	×	×			
ON * 1	×	○ (1080p)	○	×			S-VIDEO	S-VIDEO	×	×	○ (S-VIDEO)	○ (S-VIDEO)	○ (S-VIDEO)			
ON	×	○ (1080i ~ 480p)	○	×			×	×	×	×	×	×	×			
ON	×	○ (480i/576i)	○	×	COMPONENT	COMPONENT	○ (COMPONENT)	○ (COMPONENT)	○ (COMPONENT)	○ (COMPONENT)	○ (COMPONENT)					
ON	×	○ (1080p)	○	×	×	×	×	×	×	×	×					
ON * 1	×	○ (1080p)	○	×	S-VIDEO	S-VIDEO	×	×	○ (S-VIDEO)	○ (S-VIDEO)	○ (S-VIDEO)					
ON	×	○ (1080i ~ 480p)	○	×	×	×	×	×	×	×	×					
ON	×	○ (480i/576i)	○	×	COMPONENT	COMPONENT	○ (COMPONENT)	○ (COMPONENT)	○ (COMPONENT)	○ (COMPONENT)	○ (COMPONENT)					
ON	○	×	×	×	HDMI	×	×	×	○ (HDMI)	×	×	×				
ON	○	×	×	○			VIDEO	VIDEO			×	×	×	×		
ON	○	×	○	×			S-VIDEO	S-VIDEO			×	×	×	×		
ON	○	×	○	×			×	×			×	×	×	×		
ON	○	×	○	×			×	×			×	×	×	×		
ON	○	○	×	×		COMPONENT	×	×		×	×	×	×	×		
ON	○	○	○	×				VIDEO		VIDEO			×	×	×	×
ON	○	○	○	×				S-VIDEO		S-VIDEO			×	×	×	×
ON	○	○	○	×				×		×			×	×	×	×
ON	○	○	○	×				×		×			×	×	×	×
OFF	×	×	×	○	×	×	×	VIDEO	Only the GUI menu is displayed		×	×				
OFF	×	×	○	×			S-VIDEO	VIDEO				×				
OFF	×	○	×	×			×	×				×				
OFF	×	○	×	×			×	×				×				
OFF	×	○	×	×			×	×				×				
OFF	○	×	×	×		COMPONENT	×	×			VIDEO	×	×			
OFF	○	×	○	×				VIDEO			VIDEO	×				
OFF	○	×	○	×				S-VIDEO			VIDEO	×				
OFF	○	×	○	×				×			×	×				
OFF	○	×	○	×				×			×	×				
OFF	○	○	×	×	HDMI	×	×	VIDEO	Only the GUI menu is displayed		×	×				
OFF	○	×	○	×			S-VIDEO	VIDEO				×				
OFF	○	○	×	×			×	×				×				
OFF	○	○	×	×			×	×				×				
OFF	○	○	○	×			×	×				×				

○ : Video signal input present

× : No video signal input

* 1 : When no HDMI monitor is connected or the HDMI monitor's power is not on

○ () : Superimposed on the picture indicated in ().

× () : Only the picture in () is output.

× : Neither the picture nor the GUI menu is output.

* 2 : Only the GUI menu is displayed when no HDMI monitor is connected or the HDMI monitor's power is not on.

ZONE2 MONITOR OUT			
INPUT		OUTPUT	On-screen display
S-VIDEO	VIDEO	×	Only the OSD menu is displayed
×	×	VIDEO	○ (VIDEO)
○	×	S-VIDEO	○ (S-VIDEO)
○	○	S-VIDEO	○ (S-VIDEO)

○ () : Superimposed on the picture indicated in ().

Troubleshooting

If a problem should arise, first check the following:

1. Are the connections correct?

2. Is the set being operated as described in the owner's manual?

3. Are the other components operating properly?

If this unit does not operate properly, check the items listed in the table below. Should the problem persist, there may be a malfunction.

In this case, disconnect the power immediately and contact your store of purchase.

[General]

Symptom	Cause / Countermeasure	Page
Set does not operate properly.	<ul style="list-style-type: none"> Reset the microprocessor. 	111
Power does not turn on, or turns off directly after it was turned on.	<ul style="list-style-type: none"> Check that the power plugs are securely inserted into the AVR-4310CI's AC inlet and the wall power outlet. 	24
No sound is produced from speakers.	<ul style="list-style-type: none"> Check the connections to the input devices and the speaker cable connections. 	13 ~ 23
	<ul style="list-style-type: none"> Check the connections to the playback devices and select the appropriate input source. 	14 ~ 23, 27
	<ul style="list-style-type: none"> Adjust the master volume to an appropriate level. 	70
	<ul style="list-style-type: none"> Cancel the mute mode. 	70
	<ul style="list-style-type: none"> Disconnect the headphones. No sound is output from the speakers or the PRE OUT terminals when headphones are connected. 	70
Display is off.	<ul style="list-style-type: none"> Select an input source for which the digital input setting has been made. 	47, 48
	<ul style="list-style-type: none"> Match the terminal to which the digital input terminal is assigned with the input mode. 	49
"DOLBY DIGITAL" indicator does not appear on display.	<ul style="list-style-type: none"> Set the dimmer function to a setting other than "OFF". 	44
	<ul style="list-style-type: none"> Cancel the PURE DIRECT mode. The display turns off when in the Pure Direct mode. 	72
"DOLBY DIGITAL" indicator does not appear on display.	<ul style="list-style-type: none"> Check the Blu-ray Disc player / DVD player's audio output setting. For details, read the Blu-ray Disc player / DVD player's operating instructions. 	-

Symptom	Cause / Countermeasure	Page
Power switches off suddenly while you are using the AVR-4310CI, the power indicator will flash in red at intervals of approximately 2 seconds.	<ul style="list-style-type: none"> The protection circuit will be activated depending upon the temperature rise in the internal parts of the unit. Please switch off power at once, and re-apply the power after the body temperature has fallen sufficiently. Please re-install AVR-4310CI in a place having good ventilation. 	-
Power switches off suddenly while you are using the AVR-4310CI, the power indicator will flash red at intervals of approximately 0.5 seconds.	<ul style="list-style-type: none"> Please use speakers which have the specified impedance. 	13
	<ul style="list-style-type: none"> The protection circuit has been activated because the core wires of different speaker cables have touched each other or a core wire has slipped out of the terminal and is touching the AVR-4310CI's rear panel. Unplug the power cord, then after twisting the core wires together tightly again, or effecting termination treatments etc, please reconnect once again. 	13
Even applying power, the power display flashes red at intervals of approximately 0.5 seconds.	<ul style="list-style-type: none"> The AVR-4310CI amplifier circuit has failed. Switch off the power and please contact the DENON service adviser. 	-

[Remote Control Unit]

Symptom	Cause / Countermeasure	Page
Set does not work properly when remote control unit operated.	<ul style="list-style-type: none"> Batteries are worn. Replace with new batteries. 	3
	<ul style="list-style-type: none"> Operate the remote control unit within a distance of about 7 m from the AVR-4310CI and at an angle of within 30°. 	3
	<ul style="list-style-type: none"> Remove the obstacle between the AVR-4310CI and the remote control unit. 	-
	<ul style="list-style-type: none"> Insert the batteries in the proper direction, checking the ⊕ and ⊖ marks. 	3
	<ul style="list-style-type: none"> The set's remote control sensor is exposed to strong light (direct sunlight, inverter type fluorescent bulb light, etc.). Move the set to a place in which the remote control sensor will not be exposed to strong light. 	3
	<ul style="list-style-type: none"> Make sure the remote control IDs of the main unit and remote control unit match. 	44, 93, 98
	<ul style="list-style-type: none"> Set the remote control unit's function button properly. 	7

[Audio]

Symptom	Cause / Countermeasure	Page
No sound is produced from center speaker.	<ul style="list-style-type: none"> When playing monaural audio sources, select a surround mode other than "STANDARD" (Dolby/DTS Surround). 	71, 72
No sound is produced from surround speakers.	<ul style="list-style-type: none"> Set the surround mode to a mode for surround playback. 	71, 72
No sound is produced from surround back speaker.	<ul style="list-style-type: none"> Check that the surround back speaker's power amplifier assignment is set to "Normal". 	34
	<ul style="list-style-type: none"> Set the surround back speakers to something other than "None". 	35
	<ul style="list-style-type: none"> Set "Surround Parameter" – "Surround Back" to something other than "OFF". 	74
No sound is produced from subwoofer.	<ul style="list-style-type: none"> Set the surround mode to the surround playback mode. 	71, 72
	<ul style="list-style-type: none"> Turn on the subwoofer's power. Set the subwoofer to "Yes". Check the subwoofer connections. Increase the subwoofer's channel level. 	– 34 13 36
DTS sound is not output.	<ul style="list-style-type: none"> Set the Blu-ray disc/DVD player's audio output setting to "Bit-stream". For details, refer to the Blu-ray disc/DVD player's operating instructions. 	–
	<ul style="list-style-type: none"> Use a DTS-compatible Blu-ray disc player/DVD player. Set the decode mode to "Auto" or "DTS". 	– 50
Dolby TrueHD, DTS-HD, Dolby Digital Plus audio is not output.	<ul style="list-style-type: none"> Make HDMI connections. 	14
	<ul style="list-style-type: none"> Set the Blu-ray disc/DVD player's audio output setting to "Bit-stream". For details, refer to the Blu-ray disc/DVD player's operating instructions. Use a DTS-compatible Blu-ray disc player. 	– –

[Control dock for iPod]

Symptom	Cause / Countermeasure	Page
iPod cannot be played.	<ul style="list-style-type: none"> Connect to the terminal to which "iPod dock" was assigned and switch the input source. 	27, 48
	<ul style="list-style-type: none"> Check the iPod connections. 	16
	<ul style="list-style-type: none"> Plug the control dock for iPod's AC adapter into a power outlet. Communications with the AVR-4310CI are not possible unless the AC adapter is plugged in. Some iPods do not support being used connected directly to the USB port. 	– 21

[Video]

Symptom	Cause / Countermeasure	Page
No picture appears.	<ul style="list-style-type: none"> Check the connections of the AVR-4310CI's video output terminals and the TV's input terminals. 	14, 15
	<ul style="list-style-type: none"> Make the proper input setting for the input terminals of the TV connected to the AVR-4310CI. 	–
	<ul style="list-style-type: none"> Cancel the PURE DIRECT mode. 	72
	<ul style="list-style-type: none"> High definition (1080i/720p) and progressive (480p/576p) video signals are not down-converted. Set the player to interlace (480i/576i) signals. Check the "Video Select" setting. 	– 48
Picture cannot be recorded.	<ul style="list-style-type: none"> The REC OUT video terminal does not have a video conversion function, so use a video cable to input video signals, an S-Video cable to input S-Video signals. 	17
DVDs cannot be copied on a VCR.	<ul style="list-style-type: none"> This is not a malfunction. Most movie software includes copy prevention signals and cannot be copied. 	–
GUI is not displayed.	<ul style="list-style-type: none"> Set "Format" according to the format (NTSC or PAL) of the TV being used. 	43

[HDMI]

Symptom	Cause / Countermeasure	Page
HDMI audio signals are not output from speakers.	<ul style="list-style-type: none"> Set "HDMI Audio Out" to "AMP" to output HDMI audio signals from the speakers. 	37
No picture appears with HDMI connections.	<ul style="list-style-type: none"> Check the connection of the HDMI connectors. 	14
	<ul style="list-style-type: none"> Select the input source assigned to the HDMI terminal at "HDMI". 	27, 47
	<ul style="list-style-type: none"> Connect a monitor that is compatible with copyright protection (HDCP). 	14
	<ul style="list-style-type: none"> Check that the output format (HDMI FORMAT) of the connected player, etc., matches the TV's compatible input formats. Depending on the monitor you have connected, the display may not be correct when you set to "Auto (Dual)". In such a case, set to either "Monitor 1" or "Monitor 2". 	14, 15 37
No sound is output from the monitor connected with HDMI connections.	<ul style="list-style-type: none"> Set "HDMI Audio Out" to "TV" to output HDMI audio signals from the TV. 	37
When performing the following operations on a connected device, AVR-4310CI has the same operations.	<ul style="list-style-type: none"> Set "HDMI Control" – "Control" to "OFF". When you only want to operate the power on/off each device, set "Power Off Control" to "OFF". 	37
<ul style="list-style-type: none"> Power ON/OFF Switching audio output devices Adjust volume Switch input source 		

[NET/USB / Rhapsody/ Napster]

Symptom	Cause / Countermeasure	Page
When a USB memory device is connected, "USB" is not displayed on the GUI menu.	• The set cannot recognize a USB memory device. Check the connection.	21
	• A USB memory device not conforming to mass storage class or MTP standards is connected. Connect a USB memory device conforming to mass storage class or MTP standards.	–
	• The set port and the connected port do not match. Connect to the port set at "USB Select".	51
	• A USB memory device that the set cannot recognize is connected. This is not a malfunction. DENON does not guarantee that all USB memory devices will operate or receive power.	–
Files on a USB memory device cannot be played.	• USB memory device is in format other than FAT16 or FAT32. Set the format to FAT16 or FAT32. For details, refer to the USB memory device's operating instructions.	–
	• USB memory device is divided into multiple partitions. When divided into multiple partitions, only files stored in the top partition can be played.	–
	• Files are stored in a non-compatible format. Record the files in a compatible format.	62, 63
The file names are not displayed properly (".." etc.).	• You are attempting to play a file that is copyright protected. Files that are copyright protected cannot be played on this set.	62
	• Characters that cannot be displayed are used. This is not a malfunction. On this set, characters that cannot be displayed are replaced with a "." (period).	–
Internet radio cannot be played.	• Ethernet cable is not properly connected or network is disconnected. Check the connection status.	23
	• Program is being broadcast in non-compatible format. Only Internet radio programs in MP3 and WMA can be played on this set.	62, 63
	• The computer's or router's firewall is activated. Check the computer's or router's firewall settings.	–
	• Radio station is not currently broadcasting. Choose a radio station that is currently broadcasting.	63, 64
Files stored on a computer cannot be played.	• IP address is wrong. Check the set's IP address.	41
	• Files are stored in a non-compatible format. Record in a compatible format.	62, 63
	• You are attempting to play a file that is copyright protected. Files that are copyright protected cannot be played on this set.	62
	• Set and computer are connected by USB cable. The set's USB port cannot be used for connection to a computer.	–

Symptom	Cause / Countermeasure	Page
Server is not found, or it is not possible to connect to the server.	• The computer's or router's firewall is activated. Check the computer's or router's firewall settings.	–
	• Computer's power is not turned on. Turn on the power.	–
	• Server is not running. Launch the server.	–
	• Set's IP address is wrong. Check the set's IP address.	41
Cannot connect to preset or favorite radio stations.	• Radio station is not currently broadcasting. Wait a while before trying again.	–
	• Radio station is not currently in service. It is not possible to connect to radio stations that are no longer in service.	–
For some radio stations, "Server Full" or "Connection Down" is displayed and station cannot be connected to.	• Station is congested or not currently broadcasting. Wait a while before trying again.	–
Sound is broken during playback.	• Network's signal transfer speed is slow or communications lines or radio station is congested. This is not a malfunction. When playing broadcast data with a high bit rate, the sound may be broken, depending on the communications conditions.	–
Sound quality is poor or played sound is noisy.	• File being played has a low bit rate. This is not a malfunction.	–
Cannot login to Rhapsody. ("Incorrect Username or Password" is displayed.)	• Login information is incorrect. Check if the Username for Rhapsody has been properly entered. Re-enter the Password. (Password is not displayed.) www.rhapsody.com/denon	41
Cannot compile Playlist.	• The AVR-4310CI does not respond to playlist compilation. When the playlist is compiled in "PC Application", it is registered to "My Library". In this way, the playlist can be played in AVR-4310CI.	–
Cannot delete Rhapsody Channel registered in "My Channels".	• Cannot be done with AVR-4310CI. Delete from "PC Application".	–
Cannot delete Tracks, Playlists, Channels registered in "My Library".	• Cannot be done with AVR-4310CI. Delete from "PC Application".	–
Cannot login to Napster. ("Incorrect Username or Password" is displayed.)	• Login information is incorrect. Check if the Username for Napster has been properly entered. Re-enter the Password. (Password is not displayed.) http://www.napster.com/choose/index_default.html	41

[XM Satellite Radio]

Symptom	Cause / Countermeasure	Page
"CHECK XM TUNER" is displayed.	• The XM Mini-Tuner is not installed or not fully seated in the XM Mini-Tuner Dock or the XM Mini-Tuner dock is not connected to the AVR-4310CI. Confirm the XM Mini-Tuner is fully seated in the dock and check the XM Mini-Tuner dock cable is connected to the AVR-4310CI.	18
"CHECK ANTENNA" is displayed.	• The XM antenna is not connected to the XM Mini-Tuner Dock or the XM antenna cable is damaged. Check that the XM antenna is securely connected to the XM Mini-Tuner Dock and check the antenna cable for damage. Replace the XM antenna if the cable is damaged.	18
"NO SIGNAL" is displayed.	• The signal cannot be received. Reposition your XM Mini-Tuner and Home Dock antenna.	–
"OFF AIR" is displayed.	• The selected channel is not currently broadcasting. Select another channel.	–
Receiving only XM channels 0 and 1.	• The XM Mini-Tuner is not activated. Contact XM Radio.	–
"XM ---" is displayed.	• The selected channel is not available. The channel may have been reassigned to a different channel number. This message may occur initially with a new radio or a radio that has not received XM's signal for an extended period. Consult the latest channel guide at www.xmradio.com or www.xmradio.ca for the current list of channels. For cases of a new radio or a radio that has not received XM's signal for an extended period, allow the radio to receive the XM satellite signal for at least 5 minutes and then try to select the channel again.	–
"CH UNAVAILABLE" is displayed.	• Channel is not present. Select another channel.	–
"CH UNAUTHORIZED" is displayed.	• You selected an XM channel that is blocked or cannot be received with your XM subscription package. Consult the latest channel guide at www.xmradio.com or www.xmradio.ca for the current list of channels. For information on receiving this channel, visit www.xmradio.com or www.xmradio.ca contact XM Satellite Radio at 1-800-967-2346 or 1-877-438-9677.	–
"UPGRADE XM TUNER" is displayed.	• The connected XM Mini-Tuner is not compatible with the AVR-4310CI. Please use an XM Rev4x-compatible XM Mini-Tuner.	–

[SIRIUS Satellite Radio]

Symptom	Cause / Countermeasure	Page
"CHECK SIRIUS TUNER" is displayed.	• The SiriusConnect Home Tuner unit is not connected. Check that the connections are correct.	19
"ANTENNA ERROR" is displayed.	• The antenna is not connected. Check that the connections are correct.	19
"NO SIGNAL" is displayed.	• The signal cannot be received. Reposition the antenna.	–
"INVALID CHANNEL" is displayed.	• Channel is not present. Select another channel.	–
"ACQUIRING SIGNAL" is displayed.	• The signal cannot be received. Reposition your SiriusConnect Home Tuner and Home Dock antenna. • Displays while SiriusConnect Home Tuner is connected. Reposition your SiriusConnect Home Tuner and Home Dock antenna.	–
"Call SIRIUS" * is displayed.	• Channels are not subscribed to. If you subscribe to the channel, you can receive the channel.	–
"SUBSCRIPTION UPDATED" is displayed.	• While updating contract information.	–
"Enter Lock Code []" is displayed.	• Selected channels are locked. Please insert pass word (4 digits) into "[]".	–

*: After scroll displays "Call 888-539-...." twice, displays "Call SIRIUS".

Restoring All the Settings to as They were at the Time of Purchase (Resetting the Microprocessor)

Perform this procedure if the display is abnormal or if operations cannot be performed. When the microprocessor is reset, all the settings are reset to their default values.

1 Turn off the power using <POWER>.

2 Press <POWER> while simultaneously pressing <STANDARD> and <DSP SIMULATION>.

3 Once the display starts flashing at intervals of about 1 second, release the two buttons.



If in step 3 the display does not flash at intervals of about 1 second, start over from step 1.

Specifications

Audio section

Power amplifier

Rated output:

Front:
130 W + 130 W (8 Ω/ohms, 20 Hz ~ 20 kHz with 0.05 % T.H.D.)
170 W + 170 W (6 Ω/ohms, 1 kHz with 0.7 % T.H.D.)

Center:
130 W (8 Ω/ohms, 20 Hz ~ 20 kHz with 0.05 % T.H.D.)
170 W (6 Ω/ohms, 1 kHz with 0.7 % T.H.D.)

Surround (A + B):
130 W + 130 W (8 Ω/ohms, 20 Hz ~ 20 kHz with 0.05 % T.H.D.)
170 W + 170 W (6 Ω/ohms, 1 kHz with 0.7 % T.H.D.)

Surround back / Front height / Front wide:
130 W + 130 W (8 Ω/ohms, 20 Hz ~ 20 kHz with 0.05 % T.H.D.)
170 W + 170 W (6 Ω/ohms, 1 kHz with 0.7 % T.H.D.)

Dynamic power:

140 W x 2ch (8 Ω/ohms)

210 W x 2ch (4 Ω/ohms)

Output connectors:

Front, Center, Surround back 6 ~ 16 Ω/ohms
Surround: A or B 6 ~ 16 Ω/ohms
A + B 8 ~ 16 Ω/ohms

Analog

Input sensitivity / Input impedance: 200 mV / 12 kΩ/kohms (except for EXT. IN (SW / S / SB), CD, PHONO, V. AUX)
200 mV / 47 kΩ/kohms (EXT. IN (SW / S / SB), CD, PHONO, V. AUX)

Frequency response: 10 Hz ~ 100 kHz +1, -3 dB (DIRECT mode)

S/N: 102 dB (IHF-A weighted, DIRECT mode)

Distortion: 0.005 % (20 Hz ~ 20 kHz) (DIRECT mode)

Rated output: 1.2 V

Digital

D/A output:

Rated output — 2 V (at 0 dB playback)
Total harmonic distortion — 0.008 % (1 kHz, at 0 dB)
S/N ratio — 102 dB
Dynamic range — 100 dB
Format — Digital audio interface

Digital input:

Phono equalizer (PHONO input — REC OUT)

Input sensitivity: 2.5 mV

RIAA deviation: ±1 dB (20 Hz to 20 kHz)

S/N: 74 dB (A weighting, with 5 mV input)

Rated output: 150 mV

Distortion factor: 0.03 % (1 kHz, 3 V)

Video section

Standard video connectors

Input / output level and impedance: 1 Vp-p, 75 Ω/ohms

Frequency response: 5 Hz ~ 10 MHz — +0, -3 dB (when video convert set to "OFF")

S-Video connectors

Input / output level and impedance: Y (brightness) signal — 1 Vp-p, 75 Ω/ohms

C (color) signal — 0.286 Vp-p, 75 Ω/ohms

Frequency response: 5 Hz ~ 10 MHz — +0, -3 dB (when video convert set to "OFF")

Color component video connector

Input / output level and impedance: Y (brightness) signal — 1 Vp-p, 75 Ω/ohms

P_B / C_B signal — 0.7 Vp-p, 75 Ω/ohms

P_R / C_R signal — 0.7 Vp-p, 75 Ω/ohms

Frequency response: 5 Hz ~ 100 MHz — +0, -3 dB (when video convert set to "OFF")

HD Radio section

[FM]

[AM]

(note: μV at 75 Ω/ohms, 0 dBf = 1 × 10⁻¹⁵ W)

Receiving Range: 87.5 MHz ~ 107.9 MHz

530 kHz ~ 1710 kHz

Usable Sensitivity: 1.5 μV (14.8 dBf)

20 μV

S/N (IHF-A): MONO 78 dB

STEREO 68 dB

HD 85 dB

85 dB

Total harmonic Distortion (at 1 kHz): MONO 0.1 %

STEREO 0.2 %

HD 0.02 %

0.02 %

General

Power supply: AC 120 V, 60 Hz

Power consumption: 8.1 A

0.1 W (Standby)

Maximum external dimensions: 434 (W) x 171 (H) x 414 (D) mm (17-3/32" x 6-47/64" x 16-19/64")

Weight: 15.8 kg (34 lbs 13 oz)

Main remote control unit (RC-1116)

Batteries: LR6/AA Type (two batteries)

Maximum external dimensions: 63 (W) x 238 (H) x 31 (D) mm (2-31/64" x 9-3/8" x 1-7/32")

Weight: 190 g (Approx 6.7 oz) (including batteries)

Sub remote control unit (RC-1121)

Batteries: R03/AAA Type (two batteries)

Maximum external dimensions: 49 (W) x 220 (H) x 24.5 (D) mm (1-59/64" x 8-21/32" x 31/32")

Weight: 114 g (Approx 4 oz) (including batteries)

※ For purposes of improvement, specifications and design are subject to change without notice.

List of preset codes / Liste de codes préréglés

Blu-ray Disc Player

D	Denon	32258
I	Insignia	30675
	Integra	32147
L	LG	30741
M	Magnavox	30675
	Marantz	32414
O	Olevia	32331
	Onkyo	32147
P	Panasonic	31641
	Philips	32084, 32434
	Pioneer	30142, 32442
S	Samsung	30199
	Sharp	32250
	Sony	31516
	Sylvania	30675

HD-DVD Player

I	Integra	31769
L	LG	30741
M	Microsoft	32083
O	Onkyo	31769
R	RCA	31769
T	Toshiba	31769
X	Xbox	32083

DVD Player

1	3D LAB	30503, 30539
A	A-Trend	30714
	Accurian	30675
	AEG	30788
	Aiwa	30533, 30641
	Akai	30695, 30705, 30770, 30899
	Alba	30672
	Allegro	30869
	Amstrad	30713
	Apex Digital	30533, 30672, 31056, 31061
	Argo	31023
B	BBK	31224
	Bel Canto Design	31571
	Black Diamond	30713
	Blue Parade	30571
	Blue Sky	30695, 30713
	Bose	32023
	Brandt	30651
	Broksonic	30695, 31419
	Bush	30690
C	California Audio Labs	30490

	Cambridge Soundworks	30690
	Cat	30789
	Centrex	30672
	Cinea	30831
	CineVision	30833, 30869, 31483
	Citizen	30695
	Clairtone	30571
	Clatronic	30788
	Coby	31086, 31321
	Craig	30831
	Creative	30503, 30539
	CyberHome	30714, 30816, 31023, 31129, 31502
	Cytron	30705

D	Daewoo	30705, 30714, 30770, 30833, 30869, 31172
	Dansai	30770
	Decca	30770
	Denon	30490, 30634, 31634, 31844, [32134]*
	Digitor	31005
	Digitrex	30672
	Disney	30675
	DiViDo	30705
	Dual	30675
	Durabrand	30713, 31023
	DVD2000	30521

E	Elta	30690
	Emerson	30591, 30675, 30821, 31268
	Enterprise	30591
	Entivo	30503, 30539
	Enzer	30770
	ESA	30821, 31268

F	Firstline	30651
	Fisher	30670
	Funai	30675, 31268
G	Gateway	31158
	GE	30522, 30815
	GFM	30675, 31268
	Go Video	30573, 30715, 30741, 30744, 30783, 30833, 30869, 31044, 31075, 31099, 31158, 31483, 31730

	GoldStar	30741, 30869
	Gradiente	30490, 30651
	Grundig	30539, 30705, 30775
H	H & B	30850
	Harman/Kardon	30582, 30702, 31229
	Helios	32192
	Hello Kitty	30831
	HiMAX	30843
	Hitachi	30573, 30664, 31748
	Hiteker	30672

	Humax	31588
	Hyundai	30850
I	Insignia	30675, 31268
	Integra	30571, 30627, 31634, 31769
	IRT	30783

J	JBL	30702, 31926
	JMB	30695
	JVC	30558, 30623, 30867, 31164, 31275, 31550, 31597, 31602, 31901

K	Kenwood	30490, 30534, 30682
	Kiiro	30770
	Kiss	30841
	Kloss	30533
	Koss	30651, 31061

L	Lasonic	30627, 30789
	Lecson	31533
	Lenco	30774
	Lenoxx	30838
	LG	30591, 30741, 30869, 31906
	LiteOn	31058, 31158
	Loewe	30511, 30741
	Logix	30783

M	Magnasonic	30651, 30675
	Magnavox	30503, 30539, 30646, 30675, 30713, 30821, 30885, 31268, 31354, 31506
	Marantz	30503, 30539, 30675
	McIntosh	31533, 31273
	Medion	30651
	Memorex	30695, 30831, 32213
	MiCO	30723, 30751
	Microsoft	30522, 32083
	Minato	30752
	Mitsubishi	30521, 31521

N	NAD	30741
	Naiko	30770
	NEC	30869
O	Onkyo	30503, 30627, 31612, 31769, 31985
	Oppo	30575, 31224, 32185
	Optimus	30571
	Orion	31695
	Oritron	30651

P	Palsonic	30672
	Panasonic	30490, 30503, 30571, 30632, 30703, 31362, 31462, 31490, 31579, 31641, 31762, 31834
	Philco	30675, 30690, 30733, 30862
	Philips	30503, 30539, 30646, 30675, 30713, 30854, 30885, 31158, 31267, 31340, 31354, 31506, 32084
	Pioneer	30142, 30525, 30571, 30631, 30632, 31460, 31571, 31965

	Polaroid	31061, 31086
	Polk Audio	30539
	Portland	30770
	Presidian	30675
	Proceed	30672
	Proscan	30522

Q	Qwestar	30651
R	Radionette	30741
	RadioShack	30571
	RCA	30522, 30571, 30822, 31022, 31132, 31769, 31965

	Realistic	30571
	Redstar	30763
	Reoc	30752
	Rio	30869
	Rotel	30623
S	Saba	30651
	Sampo	30752

	Samsung	30199, 30490, 30573, 30744, 30899, 31044, 31075, 31748, 31932
	Sansui	30695
	Schneider	30783
	Schwaiger	30752
	Sensory Science	31158

	Sharp	30630, 30675, 30752, 31256, 31419, 32015
	Sherwood	30770
	Shinsonic	30533
	Simaudio	30885
	Singer	30751
	Skyworth	30898
	SM Electronic	30690

	Sonic Blue	30573, 30715, 30783, 30869, 31099
	Sony	30533, 30772, 30864, 31033, 31070, 31431, 31433, 31516, 31533, 31536, 31633, 31981
	Superscan	30821

	Sylvania	30675, 30821, 31268
	Symphonic	30675, 30821, 31268
T	Tatung	30770
	Teac	30571, 30759, 31006
	Technics	30490, 30703

	Technika	30770
	Tevion	30651
	Theta Digital	30571
	Thomson	30511, 30522, 30551
	Tivo	31503, 31588

	Toshiba	30503, 30539, 30573, 30695, 31045, 31154, 31503, 31510, 31588, 31769
	Tredex	30843
U	Unimax	30770
	United	30788

	Universum	30591
	Urban Concepts	30503, 30539
W	Wharfedale	30686
X	Xbox	30522, 32083
Y	Yamaha	30490, 30539, 30545, 30646, 30817, 31840
Z	Zenith	30503, 30591, 30741, 30869, 31906

DVD Recorder

A	Accurian	30675, 31416
	Apex Digital	31056
B	Broksonic	31419
C	Coby	31086
	CyberHome	31129, 31502

F	Funai	30675
G	Gateway	31158
	Go Video	30741, 31158, 31730
H	Humax	31588
J	JVC	31164, 31275

K	Kreisen	31421
L	LG	30741
	LiteOn	31158, 31416
M	Magnavox	30646, 30675, 61506

P	Packard Bell	31321
P	Panasonic	30490, 31579
	Philips	30646, 31340
	Pioneer	30631, 31460
	Polaroid	31086

R	RCA	30522
S	Samsung	30490
	Sanyo	30670
	Sensory Science	31158
	Sharp	30675

	Sony	31033, 31070, 31431, 31433, 31516, 31533, 31536, 31633, 31981
	Sylvania	30675
T	Toshiba	31510, 31588
Z	Zenith	30741

CD Player

A	Acoustic Research	40420
	Aiwa	40157
	Arcam	40157
	Burdio Research	40157
B	Burmester	40420
C	Cairn	40157

	California Audio Labs	40029, 40303
	Cambridge Soundworks	40157
	Carver	40157, 40179

	Curtis Mathes	40032
D	Denon	40003, 40766, 40873, 42867, 42868, 43867, 43868
	DKK	40000
	DMX Electronics	40157
F	Fisher	40000, 40179
G	Garrard	40393, 40420
	Genexxa	40032
	Grundig	40157
H	Hafler	40173
	Harman/Kardon	40100, 40157, 40173
	Hitachi	40032
I	Inkel	40157
	Integra	40101
J	Jerrold	40003
	JVC	40032, 40072
K	Kenwood	40000, 40028, 40029, 40037, 40190, 40681
	KLH	41318
	Krell	40157
L	Linn	40157
	LXI	40179
M	Magnavox	40157
	Marantz	40029, 40157
	Matsui	40157
	MCS	40029
	Memorex	40000, 40032, 40179, 40420, 40468
	Micromega	40157
	Miro	40000
	Mission	40157
	Modulaire	40000, 40032, 40087, 40179, 40420, 40468
	MTC	40420
	Musical Fidelity	40393
	Myryad	40157
N	NAD	40721
	NSM	40157
O	Onkyo	40101, 40868
	Optimus	40000, 40032, 40037, 40087, 40179, 40393, 40420, 40468
P	Panasonic	40029, 40303, 40388, 40752
	Parasound	40420
	Penney	40029
	Philips	40157
	Pioneer	40032, 40468
	Polk Audio	40157
	Proceed	40420
	Proton	40157
Q	QED	40157
	Quad	40157
	Quasar	40029
R	Radiola	40157
	RadioShack	40000, 40032, 40179, 40420, 40468

	RCA	40032, 40053, 40179, 40420, 40468
	Realistic	40000, 40032, 40087, 40179, 40420, 40468
	Revox	40157
	Rotel	40157, 40420
S	SAE	40157
	Sansui	40000, 40157
	Sanyo	40000, 40087, 40179
	Sears	40179
	Sharp	40037
	Sonic Frontiers	40157
	Sony	40000, 40100, 40185, 40490
	Sugden	40157
	Sylvania	40157
T	TAG McLaren	40157
	Tandy	40032
	Tascam	40393, 40420
	Teac	40390, 40420, 40490
	Technics	40029, 40303
	Techwood	40303
	Thule Audio	40157
V	Victor	40072
W	Wards	40032, 40053, 40087, 40157, 40179
Y	Yamaha	40036, 40490, 40868
	Yorx	40000

CD Recorder

D	Denon	42868, 43868
R	RCA	40053, 40420
S	Sony	40000, 40100, 41364
T	Teac	40420

Video Cassette Recorder

A	A-Mark	20037, 20240, 20278
	ABS	21972
	Admiral	20048, 20060
	Adventura	20037, 20240
	Aiko	20278
	Aiwa	20037, 20742, 21137
	Akai	20315
	Alba	20278
	Alienware	21972
	Allegro	21137
	America Action	20278
	American High	20081
	Anam National	20226
	Asha	20240
	Astra	20240
	Audiovox	20037, 20278
B	Beaumarck	20240

	Bell & Howell	20048
	Broksonic	20348
C	Calix	20037
	Candle	20037
	Carrera	20240
	Carver	20081
	CCE	20278
	Cineral	20278
	CineVision	21137
	Citizen	20037, 20240, 20278
	Classic	20037
	Colortyme	20045, 20060, 20278
	Craig	20037, 20240
	Crosley	20081
	Crown	20278
	Curtis Mathes	20060, 20240, 20278
	Cybermex	20240
	CyberPower	21972
D	Daewoo	20037, 20045, 20278, 21137
	Daytron	20037, 20278
	Dell	21972
	Denon	20042, 20081
	DirecTV	20739
	Dynatech	20240
E	Electrohome	20037, 20043, 20060, 20240
	Electroponic	20037
	Emerex	20032
	Emerson	20037, 20043, 20240, 20278, 20348, 20593, 21593
	ESA	21137
F	Funai	20037, 20278, 20593, 21593
G	Gateway	21972
	GE	20048, 20060, 20240
	Gemini	20060
	Genexxa	20037, 20278
	GFM	21593
	Go Video	20240, 20614, 21137
	GoldStar	20037, 20278, 21137
	Goodmans	20037, 20278, 21137
	Granada	20042, 20081
	Grundig	20081, 20226
H	Harman/Kardon	20081
	Hewlett Packard	21972
	Hitachi	20037, 20042, 20045, 20089
	Howard Computers	21972
	HP	21972
	Hughes Network Systems	20042, 20739
	Humax	20739
	Hush	21972
I	iBUYPOWER	21972
	Instant Replay	20226
	ITT Nokia	20240

J	Janeil	20240
	Jensen	20067
	JVC	20067, 21162
K	KEC	20037, 20278
	Kenwood	20067
	Kodak	20037
L	LG	20037, 20240, 21137
	Lifetec	20348
	Linksys	21972
	Lloyd's	20240
	Loewe	20081
	Logik	20240
	Lumatron	20278
	LXI	20037, 20042, 20067
M	M Electronic	20240
	Magnasonic	20037, 20240, 20278, 20593
	Magnavox	20037, 20048, 20081, 20226, 20240, 20593, 20618, 21593
	Magnin	20240
	Marantz	20081
	Marta	20037
	Matsui	20037, 20348
	Matsushita	20081, 21162
	Media Center PC	21972
	Medion	20348
	Memorex	20037, 20048, 20240, 20278, 20348, 21162
	Metz	20037
	MGA	20043, 20060, 20240
	MGN Technology	20240
	Microsoft	21972
	Midland	20240
	Mind	21972
	Minolta	20042
	Mitsubishi	20042, 20043, 20048, 20060, 20067
	Motorola	20048
	MTC	20240
N	NAD	20240
	NEC	20067
	Nikko	20037, 20278
	Nikkodo	20037, 20278
	Nishi	20240
	Niveus Media	21972
	Noblex	20240
	Northgate	21972
O	Olympus	20226
	Optimus	20037, 20048, 20240, 20593, 21162
	Orion	20240, 20278
P	Panasonic	20225, 20226, 20614, 20616, 20837, 21162
	Penney	20037, 20042, 20067, 20081, 20240
	Pentax	20042

	Philco	20081
	Philips	20045, 20048, 20081, 20616, 20618, 20739
	Pilot	20037
	Pioneer	20042, 20067, 20081, 21337
	Polk Audio	20081
	Portland	20278
	Presidian	21593
	Profitronic	20240
	Proscan	20060
	Pulsar	20240, 20278
	Pulser	20240
Q	Quasar	20226, 21162
R	RadioShack	20037, 20048, 20240, 21162
	Radix	20037
	Randex	20037
	RCA	20042, 20045, 20048, 20060, 20240, 20890
	Realistic	20037, 20048, 20240, 20278, 21162
	ReplayTV	20614, 20616
	Ricavision	21972
	Rio	21137
S	Samsung	20045, 20060, 20240, 20739
	Samtron	20240
	Sanky	20048
	Sansui	20067, 20240
	Sanyo	20240
	Scott	20043, 20045
	Sears	20037, 20042, 20043, 20045, 20048, 20060, 20067
	Sharp	20032, 20048
	Shintom	20240
	Shogun	20240
	Siemens	20037
	Signature	20037, 20048, 20060
	Singer	20037, 20240
	Sonic Blue	20614, 20616, 21137
	Sony	20032, 20067, 20226, 20636, 21032, 21972
	Stack 9	21972
	STS	20042
	Sylvania	20043, 20081, 20593, 21593
	Symphonic	20240, 20539, 21593
	Systemax	21972
T	Tagar Systems	21972
	Tashiko	20037
	Tatung	20048, 20067, 20081
	Teac	20067
	Technics	20037
	Teknika	20037
	Telecorder	20240
	Thomson	20060
	Tisonic	20278

Tivo	20618, 20636, [20739] *, 21337, 21996
TMK	20240
TNIX	20037
Tocom	20240
Toshiba	20043, 20045, 20240, 21008, 21972, 21996
Tosonic	20278
Totevision	20037, 20240
Touch	21972
Trix	20037
Ultra	20045, 20278
Unitech	20240
Vector	20045
Victor	20067
Video Concepts	20045
Videomagic	20037
Videosonic	20240
Viewsonic	21972
Voodoo	21972
Wards	20037, 20042, 20043, 20045, 20048, 20060, 20081, 20240
Wharfedale	20593
White Westinghouse	20278
XR-1000	20240
Zenith	20037, 20278, 21137
ZT Group	21972

Digital(Personal) Video Recorder

ABS	21972
Alienware	21972
CyberPower	21972
Dell	21972
DirecTV	20739
Gateway	21972
Go Video	20614
Hewlett Packard	21972
Howard Computers	21972
HP	21972
Hughes Network Systems	20739
Humax	20739
Hush	21972
iBUYPOWER	21972
Linksys	21972
Media Center PC	21972
Microsoft	21972
Mind	21972
Niveus Media	21972
Northgate	21972
Panasonic	20614, 20616

Philips	20618, 20739
Pioneer	21337
RCA	20880
ReplayTV	20614, 20616
Samsung	20739
Sonic Blue	20614, 20616
Sony	20636, 21972
Stack 9	21972
Systemax	21972
Tagar Systems	21972
Tivo	20618, 20636, 20739, 21337
Toshiba	21008, 21972, 21996
Touch	21972
Viewsonic	21972
Voodoo	21972
ZT Group	21972

Digital (Personal) Video Recorder/Satellite Combination

Bell ExpressVu	00775
DirecTV	00099, 00392, 00639, 01076, 01142, 01377, 01442, 20739
Dish Network System	00775, 01505
Dishpro	00775, 01505
Echostar	00775, 01505
Expressvu	00775
Hughes Network Systems	01142, 01442, 20739
Motorola	00869
Philips	01142, 01442, 20739
Proscan	00392
Samsung	01442, 20739
Sony	00639
Star Choice	00869
Tivo	01142, 01442, 20739
ViewSat	01994

Digital(Personal) Video Recorder/cable Combination

Cisco	01877
Digeo	01187
Motorola	01187, 01376
Pace	00237, 01877
Pioneer	01877
Scientific Atlanta	01877
Supercable	00276

Tape Deck

Aiwa	20029, 20197, 20200
------	---------------------

Akai	20283
Carver	20029
Denon	20076, 20371, 22471
Garrard	20308
Grundig	20029
Harman/Kardon	20029, 20182
JVC	20244, 20273
Kenwood	20070
Magnavox	20029
Marantz	20009, 20029
Mitsubishi	20283
Onkyo	20135, 20282
Optimus	20027, 20220
Panasonic	20229
Philips	20029
Pioneer	20027, 20099, 20220
Polk Audio	20029
RCA	20027, 20220
Sansui	20009, 20029
Sony	20170, 20243, 20291
Teac	20308
Technics	20229
Technovox	20229
Victor	20273
Wards	20027
Yamaha	20094, 20097

Television

A-Mark	10047, 10054
A.R. Systems	10352, 10556
Accuscan	10047
Accuscreen	10001
Acoustic Research	11269
Action	10030
Acura	10009
Admiral	10017, 10047, 10051, 10054, 10163, 10264, 10418
Advent	10761, 11933
Adventuri	10000
Adyson	10217
Agna	10150
Aiko	10092
Aiwa	10701
Akai	10009, 10030, 10060, 10145, 10208, 10672, 10702, 10812, 11207, 11537, 11675, 11676, 11903, 12078
Alaron	10170
Alba	10009, 10037, 10073, 10163, 10218, 10352, 10371
Alfide	10672
Alleron	10030, 10170
Ambassador	10150

American High	10000, 10060
Amstrad	10009, 10011, 10163, 10171, 10371, 10433
Amtron	10000
Anam	10009
AOC	10030
Apex Digital	10156, 10765, 11217, 11943
AR	10352, 10556
Aristocrat	10163
Asuka	10218
Audiovox	10092, 10623, 10802, 10875, 11937, 11951, 11952
Aventura	10171
Awa	10009
Axion	11937
Bang & Olufsen	10565
Barco	10556
Basic Line	10009, 10218
Beaumarck	10017, 10030, 10178
Beko	10714, 10715
Belcor	10030
Bell & Howell	10054, 10154
BenQ	11032
Blue Sky	10556
Boots	10217
Brionvega	10362
Brockwood	10030, 10178
Broksonic	11911, 11938
Brother	10264
Bush	10698, 11556
By:sign	11309
Candle	10030
Capehart	10017, 10030, 10036, 10092, 10178
Carnivale	10030
Carver	10054, 10170
CCE	10037, 10217
Celebrity	10000
Celera	10765
Centrex	10780
Changhong	10156, 10765, 10820, 10821
Cineral	10092
Citek	10047
Citizen	10000, 10001, 10030, 10035, 10054, 10060, 10092, 10171
Classic	10030, 10092
Colortyme	10017, 10030, 10047, 10054, 10060, 10178
Commercial Solutions	10047, 11447
Conic	10178
Craig	10171
Crosley	10000, 10030, 10054, 10074, 10171, 10370
Crown	10672
Crown Mustang	10672

Curtis Mathes	10000, 10030, 10035, 10037, 10047, 10051, 10054, 10060, 10145, 10154, 10166, 10178, 10702, 11147, 11347
Daewoo	10009, 10036, 10092, 10109, 10178, 10264, 10623, 10634, 10661, 10672, 11661, 11755, 11756
Dayton	10092
Daytron	10030, 10036, 10092, 10178
Decca	10217
Dell	11080, 11178, 11264, 11403, 11863
Denon	10145
Dream Vision	11164
Dumont	10017, 10178
Durabrand	10171, 10178
Dynatech	10217
Dynex	11463
Eaton	10060
Electroband	10000
Electrograph	11755
Electrohome	10000, 10030, 10073, 10150, 10154, 10178
Elite	10218
Elta	10009, 10264
Emerald	10178
Emerson	10017, 10036, 10047, 10073, 10150, 10154, 10170, 10171, 10178, 10195, 10623, 11394, 11911, 11944
Encross	10876
Envision	10030, 10813
ESA	10171, 10812, 11944
Ferguson	10625
Fisher	10000, 10054, 10154, 10217
Fujitsu	10217, 10683, 10809, 10853, 12008
Funai	10000, 10171, 11271, 11904
Gateway	11755, 11756
GE	10000, 10030, 10035, 10047, 10051, 10060, 10178, 10560, 11147, 11347, 11447, 11917, 11922
Gemini	10047
GFM	10171
Gibraltar	10000, 10017, 10030
Go Video	10886
Go Vision	11937
GoldStar	10001, 10009, 10030, 10036, 10037, 10047, 10054, 10073, 10178
Goodmans	10037
Gradiente	10053, 10170
Granada	10037
Grundig	10037, 10070, 10163, 10195, 10672, 10683, 10706
Grundy	10195
Haier	11749

Hallmark	10178
Hanseatic	10556
Harley Davidson	10000, 10030, 10060, 10178, 11904
Harman/Kardon	10054
Harsper	11206
Heathkit	10017
Helios	10865
Hewlett Packard	11494
Hikone	10218
Hitachi	10000, 10017, 10035, 10036, 10047, 10051, 10054, 10109, 10145, 10163, 11145, 11576, 11643, 11904, 11960
HP	11494
Hyundai	10849, 10865
ICE	10264
Ima	10178
Infinity	10054
InFocus	11164
Innova	10037
Insignia	10171, 11423, 11517, 11564
Inteq	10017, 10145
ITT Nokia	10070, 10163, 10195, 10361
IX	10877
JBL	10054
JCB	10000
Jensen	10761, 11933
JIL	10030
Jinxing	10037, 10556
Johnson	10455
Jutan	10030
JVC	10030, 10036, 10053, 10054, 10070, 10371, 10650, 10653, 10731, 11253, 11774, 11923
Kamp	10017, 10217
Kawasho	10030
KDS	11498
KEC	10060
Kennex	10668
Kenwood	10030
Kioto	10556
KLH	10156, 10765, 11962
Kloss	10030
Konka	10218, 10371
Kreisen	10876
KTV	10030, 10217
Lark	10154
LG	10017, 10030, 10037, 10054, 10060, 10178, 10856, 11178, 11423, 11637, 11768
Lloyd's	10030, 11904
Loewe	10512, 10633, 10790
Logik	10011

Lumatron	10037, 10073, 10163, 10217, 10264, 10361, 10556
Luxor	10163
LXI	10000, 10001, 10017, 10030, 10035, 10036, 10037, 10047, 10051, 10053, 10054, 10060, 10154, 10156, 10166, 10171, 10178, 10208
MAG	11498
Magnasonic	10000, 10030, 10054, 10092, 10109, 10156
Magnavox	10000, 10030, 10035, 10036, 10037, 10047, 10051, 10054, 10060, 10092, 10154, 10171, 10706, 10780, 10802, 11254, 11454, 11755, 11866, 11904, 11944
Majestic	10017
Marantz	10030, 10037, 10054, 10556, 10704, 10854, 10855, 11454
Mark	10037
Matsui	10009, 10011, 10035, 10036, 10037, 10163, 10217, 10352, 10371, 10443
Matsushita	10051, 10650
Maxent	11755, 11756
Megatron	10009, 10047, 10145, 10178
Memorex	10030, 10035, 10037, 10150, 10154, 10178, 10195, 10877, 11037, 11903, 11911
Mermaid	10037
MGA	10030, 10150, 10178
MGN Technology	10178
Micro Genius	10150
Micromaxx	10714, 10808
Midland	10017, 10047, 10051
Minato	10037, 10556
Mitsubishi	10011, 10030, 10036, 10108, 10150, 10154, 10178, 10195, 10250, 10836, 11917
Motorola	10051, 10054, 10150
MTC	10011, 10030, 10060, 10092
Multitech	10217
NAD	10037, 10156, 10166, 10178, 10361, 10866, 11156
National	10226
NEC	10030, 10036, 10047, 10170, 10178, 10455, 10704, 11270, 11704, 11797
NetTV	11755
Nikko	10030, 10092, 10178
Nikkodo	10030, 10092, 10178
Niko	11618
Nishi	10030
Nokia	10606, 10631
Norcent	10824
NTC	10092
NuVision	11657, 12158
Nyon	10000
Olevia	11144, 11240, 11331, 11610

Onwa	10602
Optimus	10030, 10150, 10154, 10166, 10178, 10650
Optoma	10887
Orion	10017, 10178, 10443, 10880, 11463, 11911
Pace	10092
Pacific	10037, 10556, 10714, 11037, 11137
Palsonic	10264, 10773
Panasonic	10000, 10030, 10035, 10051, 10054, 10156, 10163, 10226, 10367, 10650, 11291, 11310, 11457, 11480, 11941, 11946, 11947
Panda	10698, 10706, 10780
Pausa	10009
Paxonic	10030, 10060
PCE	10060, 10156
Penney	10000, 10030, 10035, 10036, 10037, 10047, 10051, 10060, 10070, 10108, 10156, 10178, 11347
Petters	11523
Philco	10030, 10054, 10074, 10145, 10171, 11271, 11394
Philips	10030, 10037, 10054, 10171, 10374, 10512, 10556, 10690, 11254, 11454, 11744, 11961
Pilot	10011, 10030, 10051, 10060, 10178
Pioneer	10109, 10163, 10166, 10287, 10679, 10866, 11260, 11457
Polaroid	10765, 10865, 11276, 11316, 11341, 11498, 11523, 11962, 12120
Portland	10092
Prima	10761, 11933
Prism	10051
Proscan	10047, 11347, 11447, 11922
Protec	10009, 10037, 10217, 10264
Proton	10009, 10178
Proview	11498
ProVision	10037, 10556, 11037
Pulsar	10017, 10092
Pulser	10092, 10178
Quartz	10150, 10178
Quasar	10035, 10051, 10650
R-Line	10037
Rabbit	10047
RadioShack	10030, 10047, 10150, 10154, 10178, 11904
RCA	10000, 10047, 10051, 10054, 10090, 10178, 10679, 11047, 11147, 11247, 11347, 11447, 11547, 11781, 11917, 11922, 11953, 11958, 12247
Realistic	10030, 10047, 10150, 10154, 10178
Reoc	10714
Revox	10037
Rowa	10698, 10712

Runco	10017, 10030, 10060, 11629
Saisho	10011
Sampo	10030, 10047, 11755, 11756
Samsung	10009, 10017, 10030, 10035, 10036, 10037, 10047, 10054, 10060, 10154, 10178, 10208, 10217, 10264, 10362, 10370, 10618, 10650, 10702, 10766, 10812, 10814, 11060, 11903, 11959
Sanky	10030, 10060
Sansui	10030, 10060, 10171, 10371, 11904, 11911
Sanyo	10000, 10011, 10036, 10037, 10047, 10054, 10154, 10170, 10171, 10208, 11142, 11755
Saville	10060
Sceptre	10878, 11217, 11599
Schneider	10070
Scotch	10178
Scott	10030, 10178, 11711
Sears	10000, 10001, 10017, 10030, 10035, 10036, 10037, 10047, 10051, 10053, 10054, 10060, 10154, 10156, 10166, 10171, 10178, 10208, 11904
Sharp	10036, 10054, 10668, 10818, 11393, 11602, 11917
Shivaki	10037, 10178, 10374, 10556
Siemens	10145, 10195, 10200, 10327
Signature	10030, 10047
Simpson	10011, 10030, 10178
Singer	10060, 10092
Sky-North	10037
Solar Drape	10000
Sole	10813
Sony	10000, 10011, 10017, 10036, 10053, 10150, 10154, 10353, 10810*, 11505, 11651, 11685, 11751, 11904
Soundesign	10178
Sova	11952
Soyo	11826, 11834
Spectravision	10156, 10178
Spectroniq	11498
Squareview	10171
SR2000	10154, 10171
Standard Components	10009, 10218
Superscan	10864, 11944
Supreme	10000
SV2000	10054
SVA	10865
Sylvania	10000, 10030, 10036, 10037, 10047, 10051, 10054, 10092, 10154, 10171, 10178, 10876, 11271, 11886, 11864, 11886, 11904, 11944
Symphonic	10000, 10171, 10178, 11904, 11944
Syntax	11144, 11240, 11331, 11610

Tandy	10217, 10218
Tatung	10000, 10037, 10051, 10217, 11756
Teac	10009, 10037, 10154, 10264, 10418, 10455, 10698, 10706, 10712, 11037
Technics	10051, 10054, 10226
Technovox	10030, 10217
Techwood	10051, 10060
Teco	11040
Tedex	10698
Teknika	10054, 10060, 10092, 10150, 10178
Telecolor	10017
Telefunken	10074, 10109, 10335, 10343, 10625, 10702
Tevion	10037, 10556, 10668, 11137
Thomas	10001, 10047, 10178, 11904
Thomson	10047, 10109, 10287, 10343, 10625, 11447
TMK	10178
TNCi	10017
Tocom	10156
Toshiba	10011, 10035, 10036, 10060, 10070, 10145, 10150, 10154, 10156, 10166, 10217, 10264, 10508, 10650, 10718, 10845, 11145, 11156, 11164, 11256, 11356, 11508, 11524, 11656, 11704, 11945
Totevision	10051
Toyomenka	10178
Transonic	10698, 10712
Truetone	10051
Ultra	10092
Universal	10047
Universum	10009, 10011, 10036, 10037, 10070, 10170, 10217, 10264, 10361, 10418, 10512, 10631
V	10885, 11755, 11756
Vector Research	10030
Victor	10053
Vidikron	10054, 11629
Vidtech	10036, 10178
Viewpia	10876
Viewsonic	10857, 10864, 10885, 11330, 11578, 11627, 11755, 12087
Viking	10060
Viore	10054, 11207
Vizio	10864, 10885, 11755, 11756, 11758
Wards	10000, 10001, 10017, 10030, 10035, 10037, 10047, 10051, 10054, 10154, 10166, 10178, 10195, 10866, 11156
Waycon	10156
Welton	10178
Westinghouse	10000, 10885, 10889, 11282, 11577, 11712
White Westinghouse	10623, 10889

X	XR-1000	10154, 10171
Y	Yamaha	10030, 10650
	Yorx	10030
Z	Zenith	10000, 10017, 10030, 10037, 10047, 10092, 10145, 10171, 10178, 10812, 11145, 11423, 11904, 11911

Television/DVD Combination

A	Advent	11933
	Akai	11675, 30695
	Apex Digital	11943
	Audiovox	11937, 11951, 11952
	Axion	11937
B	Broksonic	30695
C	Citizen	30695
E	Emerson	11394, 30675, 31268
	ESA	31268
F	Funai	31268
G	GFM	31268
H	Hitachi	11960, 31247
I	Insignia	31268
J	Jensen	11933
K	KLH	11962
M	Magnavox	11866, 31268
P	Panasonic	11941, 31490
	Philips	11961, 30854, 31260
	Polaroid	11523, 11962
	Prima	11933
R	RCA	11948, 11958, 31022
S	Samsung	11903, 30899
	Sansui	30695
	Sharp	10818
	Sova	11952
	Sylvania	11394, 11864, 11886, 30675, 31268, 32194
T	Toshiba	11524, 30695

Television/DVD/Video deck Combination

A	Akai	11903, 30899
B	Broksonic	11938
E	Emerson	11944, 30821
	ESA	11944, 30821
M	Magnavox	11944, 30821
P	Panasonic	11946, 11947, 31362, 31462
R	RCA	11953, 31132
S	Sharp	11917, 30630
	Sylvania	11944
	Superscan	30821
	Sylvania	30821

	Symphonic	11944, 30821
T	Toshiba	11945, 31045

Television/Video deck Combination

A	America Action	20278
	Audiovox	20278
B	Broksonic	11911
D	Daewoo	11909
E	Emerson	11909, 11911, 20593
F	Funai	11904
G	GE	11917, 11922, 20240
H	Harley Davidson	11904
	Hitachi	11904
J	JVC	11923
L	Lloyd's	11904
M	Magnasonic	20593
	Magnavox	11904, 20593
	Magnin	20240
	Memorex	21162, 21262
	MGA	20240
	Mitsubishi	11917
O	Optimus	20593, 21162, 21262
	Orion	11911
P	Panasonic	21162, 21262
	Penney	20240
Q	Quasar	21162
R	RadioShack	11904
	RCA	11917, 11922, 20240
S	Samsung	11959
	Sansui	11904, 11911
	Sanyo	20240
	Sears	11904
	Sony	11904
	Symphonic	11904, 20593
T	Thomas	11904
W	White Westinghouse	11909
Z	Zenith	11904, 11909, 11911

Satellite Set Top Box

A	A-Mark	00345
	ABsat	00123
	ADB	01259, 01367
	AGS	00710
	Akai	00200
	Alba	00455, 00713
	Allsat	00200
	Alltech	00713
	Amstrad	00345, 00847, 01113

	Asat	00200
	Aston	00142
	Atlantic Telephone	01333
	Austar	00497, 00863, 01176

B	Bell ExpressVu	00775
	British Sky Broadcasting	00847

C	Canal	00853
	Chaparral	00216
	CNS	01367

D	Digenius	00299
	Digiwave	01631

	DirecTV	00099, 00247, 00392, 00566, 00639, 00749, 01076, 01109, 01142, 01371*, 01414, 01442, 01609, 01749, 01856
--	---------	--

	Dish Network System	00775, 01505, 01775
	Dishpro	00775, 01505, 01775

E	Echostar	00455, 00775, 00871, 01505, 01775
	Expressvu	00775, 01775

F	Fracapro Planet	00871
	France Telecom	00871
	Funai	01377

G	Galaxis	00863
	GE	00566
	General Instrument	00869

	GOI	00775, 01775
	Gradiente	00887

	Grundig	00173, 00847
H	Hitachi	00749, 01250
	Houston	00775

	HTS	00775, 01775
	Hughes Network Systems	00749, 01142, 01442, 01749

	Humax	01790
	Hyundai	01159

I	Indovision	00887
	Innova	00099
	ISkyB	00887

J	Jerrold	00869
	JVC	00775, 01775

K	Kathrein	00249, 00658
L	Lava	01631
	LG	01414

M	Marantz	00200
	McIntosh	00869
	Mitsubishi	00749

	Motorola	00869
	Multichoice	01333

N	Netsat	00099, 00887
	Next Level	00869
	Nokia	00723, 00873, 01023, 01127

O	Omega	00887
P	Pace	00455, 00497, 00847, 00887, 01175

	Panarex	01159
	Panasonic	00247, 00701, 00847
	Pansat	01159

	Philips	00099, 00200, 00749, 00775, 00847, 01076, 01142, 01442, 01749
	Pioneer	00329, 01308

	Plasmatic	00442
	Primestar	00869
	Proscan	00392, 00566

R	RadioShack	00566, 00775, 00869
	Radix	00882

	RCA	00143, 00392, 00566, 00775, 01142, 01291, 01442
S	Saba	00710

	Sagem	00820, 01114
	Samsung	01109, 01142, 01276, 01377, 01442, 01609

	Satstation	01083
	Schwaiger	00394, 01111
	Siemens	00173

	SKY	00099, 00847, 00887, 01175
	Sky Television	01014
	SM Electronic	00713

	Sony	00639, 00847
	Star	00887
	Star Choice	00869

	Star Trak	00869
T	Televisa	00887
	Thomson	00392, 00566

	Tivo	01142, 01442
	Toshiba	00749, 00790, 01749
	TPS	00820

U	UEC	01333
V	ViewSat	01232
	Voom	00869

Z	Zenith	01856
----------	--------	-------

	Director	00476
F	Fosgate	00276
G	General Instrument	00003, 00276, 00476
	Gibraltar	00003
H	Hitachi	00003, 00008
I	Insight	00476
J	Jerrold	00003, 00276, 00476
M	Macab	00817
	Mitsubishi	00003
	Motorola	00276, 00476, 01187, 01376
N	Noos	00817
	Nova Vision	00008
	Novaplex	00008
O	Ono	01068
P	Pace	00008, 00237, 00877, 01060, 01068, 01877
	Panasonic	00008
	Paragon	00008
	Pioneer	00877, 01877
R	Regal	00276
S	Samsung	00003
	Scientific Atlanta	00003, 00008, 00237, 00477, 00877, 01877
	Starcom	00003
	Supercable	00276
T	Torx	00003
U	United Cable	00003, 00276
	US Electronics	00003, 00008, 00276

IPTV/HDTV Set Top Box





A	ABS	01272
	ADB	02254, 02586
	Alienware	01272
	Amino	01481, 02482
	AT&T	00858
C	Cisco	02345
	CyberPower	01272
E	Epson	01563
G	Gateway	01272
H	Hewlett Packard	01272
	Howard Computers	01272
	HP	01272
	Hush	01272
I	iBUYPOWER	01272
	Insignia	01415
I	KoolConnect	01481
L	LG	01415
	Linksys	01272
M	Magnavox	01563
	Media Center PC	01272
	Microsoft	01272, 02049
	Mind	01272

Motorola	00858, 01998
N Niveus Media	01272
Northgate	01272
P Philco	01563
R Ricavision	01272
S Scientific Atlanta	00858, 02345
Sony	01272, 01324
Stack 9	01272
SureWest	01481
Sylvania	01563
Systemax	01272
T Tagar Systems	01272
Toshiba	01272
Touch	01272
V Viewsonic	01272, 01329
Voodoo	01272
X Xbox	02049
Z Zenith	01415
ZT Group	01272

DVD preset codes Codes pré-réglés DVD	32134			30490
DENON				
Model No.	DVD-555	DVD-1730	DVD-5910	DVD-800
Modèle numéro	DVD-556	DVD-1740	DVD-5910CI	DVD-1600
	DVD-557	DVD-1910	DVD-9000	DVD-2000
	DVD-558	DVD-1920	DVM-715	DVD-2500
	DVD-755	DVD-1930CI	DVM-735	DVD-3000
	DVD-756	DVD-1940CI	DVM-745	DVD-3300
	DVD-757	DVD-2200	DVM-1800	
	DVD-758	DVD-2800	DVM-1805	
	DVD-900	DVD-2800II	DVM-1815	
	DVD-910	DVD-2900	DVM-1835	
	DVD-955	DVD-2910	DVM-1845	
	DVD-1000	DVD-2930CI	DVM-2815	
	DVD-1200	DVD-3800	DVM-2845CI	
	DVD-1500	DVD-3910	DVM-4800	
	DVD-1710	DVD-3930CI		
	DVD-1720	DVD-5900		

Blu-Ray preset codes Codes pré-réglés Blu-Ray	32258
DENON	
Model No.	DVD-1800BD
Modèle numéro	DVD-2500BT
	DVD-3800BD
	DVD-A1UDCI

[]*: Preset codes set upon shipment from the factory.
: Les codes pré-réglés diffèrent en fonction des livraisons de l'usine.

 DVD/HDP	DVD Player DENON [32134]
 VCR/DVR	Video Cassette Recorder Tivo [20739]
 TV	Television SONY [10810]
 SAT/CBL	Satellite Set Top Box DirecTV [01377]



DENON

www.denon.com

D&M Holdings Inc.
Printed in Japan 5411 10299 109DA