

FLAT
VISION





FLAT
VISION

**LA TECNOLOGIA SI METTE IN MOSTRA.
LA TECNOLOGIA SCOPRE IL DESIGN.**

Flat Vision Meliconi una linea completa di supporti per TV LCD e Plasma studiata nei minimi dettagli per offrire massima funzionalità con una speciale attenzione al design.





TECHNOLOGY ON DISPLAY. TECHNOLOGY DISCOVERS DESIGN.

Flat Vision Meliconi a complete line of LCD and Plasma television supports, well thought out in every detail to offer maximum functionality with special attention to design.

DIE TECHNOLOGIE STELLT SICH ZUR SCHAU. DIE TECHNOLOGIE ENTDECKT DAS DESIGN.

Flat Vision Meliconi - eine komplette Serie von Ständern für LCD- und Plasma-Fernseher, perfekt bis ins kleinste Detail durchdacht, in der ein Höchstmaß an Funktionalität in perfektem Einklang mit einem besonderen Design steht.

LA TECHNOLOGIE S'EXPOSE. LA TECHNOLOGIE DÉCOUVRE LE DESIGN.

Flat Vision Meliconi une ligne de supports soignés dans les moindres détails pour téléviseurs LCD et plasma. Une ligne complète, conçue dans les moindres détails pour offrir une fonctionnalité maximale conjuguée à une esthétique sophistiquée.

LA TECNOLOGÍA SE HACE NOTAR. LA TECNOLOGÍA DESCUBRE EL DISEÑO.

Flat Vision Meliconi una línea completa de soportes para TV LCD y Plasma, estudiada en los más mínimos detalles, para ofrecer la máxima funcionalidad con una especial atención a la estética.







FLAT VISION Fly

TV LCD



Fly 50



Fly 100



Fly 200



Supporto universale per TV LCD fino a 40"

Elegante colonna in alluminio e ampia base in MDF.

Compatibile VESA 50, 75, 100, 200.

Piani in vetro regolabili in altezza.

CABLESS System per raccogliere e nascondere i fili di collegamento tra i vari apparecchi.

TV orientabile in qualsiasi direzione.

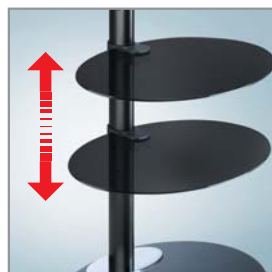
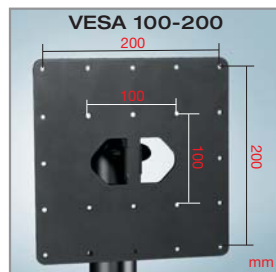
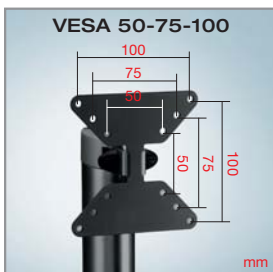

Universal support for LCD TVs up to 40"

Elegant aluminium column and wide MDF base.

Vesa 50, 75, 100, 200 mm compliant.

Adjustable glass shelves.

The CABLESS system bundles and hides the cables connecting all devices.

TV adjustable in any direction.

Universal-Ständer für LCD-TV bis 40"

Formschöne Alu-Säule und großer MDF-Fuß.

Geeignet für VESA-Befestigungen 50, 75, 100, 200.

Höhenverstellbare Glasauflagen.

CABLESS System für eine ordentliche und unsichtbare Kabelführung zwischen den verschiedenen Geräten.

TV in alle Richtungen schwenkbar.

Pied universel inclinable et orientable pour téléviseurs LCD jusqu'à 40"

Colonne en aluminium et large embase MDF.

Fixation compatible avec la norme vesa 50/75/100/200.

Tablettes en verre trempé réglables en hauteur.

Le cableless system permet de regrouper et de dissimuler, dans la colonne en aluminium, les câbles de liaison des différents appareils.

Télé orientable en toute direction.

Pie universal inclinable y orientable para televisores de LCD de hasta 40"

Columna de aluminio y amplia base de MDF.

Fijación norma VESA 50/75/100/200.

Baldas de cristal templado con alturas regulables.

El sistema cubre cables permite agrupar y ocultar dentro de la columna de aluminio los cables de los diferentes aparatos.

TV giratorio en todas las direcciones.

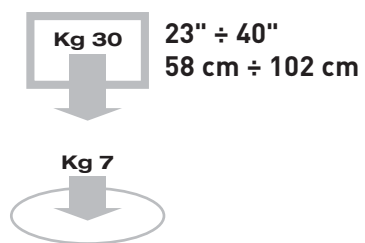
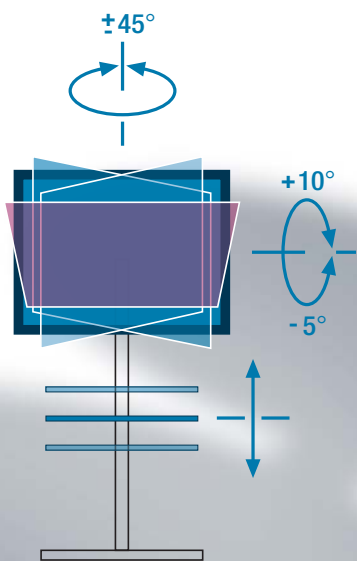



FLAT VISION Nice

TV LCD



Nice 200

Supporto universale per TV LCD fino a 43"

Elegante colonna in alluminio.

Compatibile VESA 100, 200.

CABLESS System per raccogliere e nascondere i fili di collegamento tra i vari apparecchi.

TV orientabile in qualsiasi direzione.

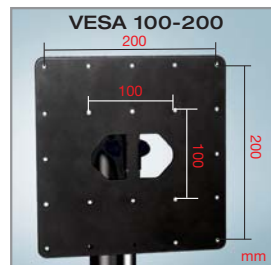

Universal support for LCD TVs up to 43"

Elegant aluminium column.

Vesa 100, 200 mm compliant.

CABLESS System conceals all cables and wires.

TV adjustable in any direction.

Pied universel pour LCD jusqu'à 43"

Colonne en aluminium.

Fixation orientable et inclinable compatible avec la norme Vesa 100/200.

Le CABLESS system permet de regrouper et de dissimuler, dans la colonne en aluminium, les câbles de liaison des différents appareils.

Universal-Ständer für LCD-TV bis 43"

Formschöne Alu-Säule und großer MDF-Fuß.

Geeignet für VESA-Befestigungen 100, 200.

CABLESS System für eine ordentliche und unsichtbare Kabelführung zwischen den verschiedenen Geräten.

TV in alle Richtungen schwenkbar.

Pie universal para televisores de LCD de hasta 43"

Columna de aluminio.

Fijación norma VESA 100/200.

El sistema cubre cables permite agrupar y ocultar dentro de la columna de aluminio los cables de los diferentes aparatos.

TV giratorio en todas las direcciones.



±45°

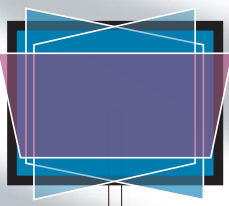

+10°



-5°

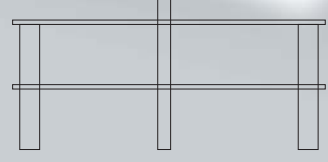

Kg 40

23" ÷ 40"
58 cm ÷ 109 cm

Kg 25





FLAT
VISION
Sky
TV LCD-PLASMA



Sky 100



Sky 200

Supporto universale per TV LCD e Plasma

Solida colonna in metallo e ampia base in MDF.

Piani in vetro temperato.

Piastra di sostegno universale con aste regolabili, adatta per televisori fino a 43".

CABLESS System per raccogliere e nascondere i fili di collegamento tra i vari apparecchi.

TV orientabile in qualsiasi direzione.

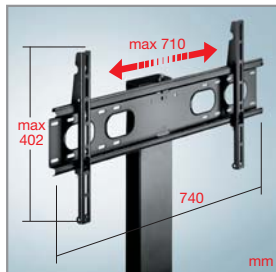

**Disponibile anche
nella versione
con ruote**

**Available also
with castors**



● Art. 500114

Universal support for LCD and Plasma TVs

Solid metal column and wide MDF base.

Toughened glass shelves.

Universal mount with adjustable shafts, suitable for televisions up to 43".

The CABLESS system bundles and hides the cables connecting all devices.

TV adjustable in any direction.

Universal-Ständer für LCD- und Plasma-TV

Stabile Metall-Säule und großer MDF-Fuß.

Auflagen aus Sicherheitsglas.

Universal-Auflageplatte mit verstellbaren Stangen, passend für TV-Geräte bis 43".

CABLESS System für eine ordentliche und unsichtbare Kabelführung zwischen den verschiedenen Geräten.

TV in alle Richtungen schwenkbar.

Pied universel orientable pour téléviseurs LCD et Plasma

Colonne en metal et large embase MDF.

La platine de fixation est compatible avec des écrans jusqu'à 43".

Tablettes en verre trempé.

Le cabless system permet de regrouper et de dissimuler dans la colonne les câbles de liaison des différents appareils.

Télé orientable en toute direction.

Pie universal orientable para televisores de LCD y Plasma.

Columna de metal y amplia base de MDF.

El soporte de fijación es compatible con las pantallas de hasta 43".

Baldas de cristal templado.

El sistema cubre cables permite agrupar y ocultar dentro de la columna los cables de los diferentes aparatos.

TV giratorio en todas las direcciones.

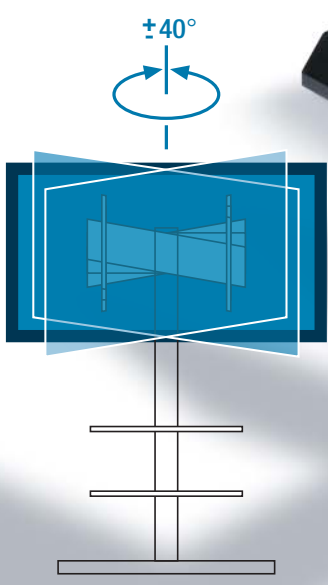



FLAT
VISION
Star
TV LCD-PLASMA



Star 100



Star 200



Supporto universale per TV LCD e Plasma

Robusta ed elegante colonna in alluminio e ampia base in MDF.

Piani in vetro temperato, 10 mm di spessore.

Piastra di sostegno universale con aste regolabili, adatta per televisori fino a 65".

CABLESS System per raccogliere e nascondere i fili di collegamento tra i vari apparecchi.

TV orientabile in qualsiasi direzione.

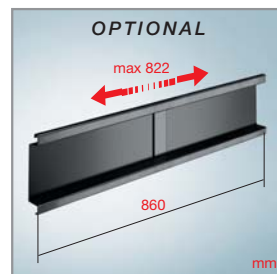
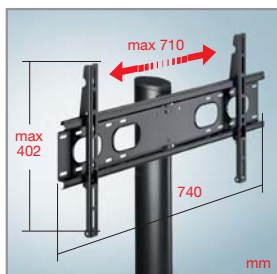

● Art. 500199 ● Art. 480185 ● Art. 500198 ● Art. 500196



Universal support for LCD and Plasma TVs

Sturdy elegant aluminium column and wide MDF base.

Toughened 10 mm thick glass shelves.

Universal mount with adjustable shafts, suitable for televisions up to 65".

The CABLESS system bundles and hides the cables connecting all devices.

TV adjustable in any direction.

Universal-Ständer für LCD- und Plasma-TV

Stabile und formschöne Alu-Säule und großer MDF-Fuß.

Auflagen aus Sicherheitsglas, 10 mm dick.

Universal-Auflageplatte mit verstellbaren Stangen, passend für TV-Geräte bis 65".

CABLESS System für eine ordentliche und unsichtbare Kabelführung zwischen den verschiedenen Geräten.

TV in alle Richtungen schwenkbar.

Pied universel orientable pour téléviseurs LCD et Plasma

Résistante colonne en aluminium et large embase MDF.

Plateaux en verre trempé de 10 mm d'épaisseur.

La platine de fixation est compatible avec des écrans jusqu'à 65".

Le cabless system permet de regrouper et de dissimuler, dans la colonne en aluminium, les câbles de liaison des différents appareils.

Télé orientable en toute direction.

Pie universal orientable para televisores de LCD y Plasma

Resistente columna de aluminio y amplia base de MDF.

Baldos de cristal templado de 10 mm de espesor.

El soporte de fijación es compatible con las pantallas de hasta 65".

El sistema cubre cables permite agrupar y ocultar dentro de la columna de aluminio los cables de los diferentes aparatos.

TV giratorio en todas las direcciones.

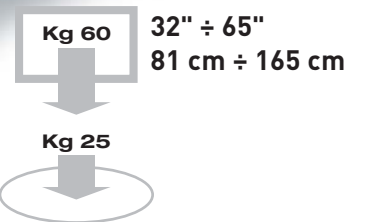
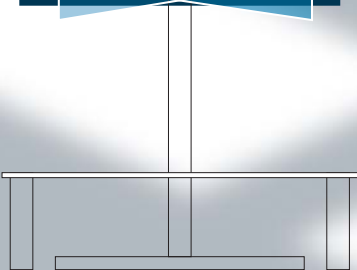
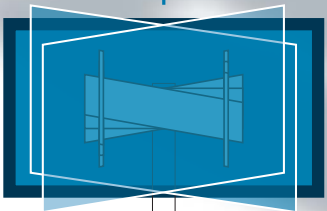



FLAT
VISION
Expò
TV LCD-PLASMA



Expò 200



Expò 200



Expò 300



Expò 300

*con ruote / with castors
avec roulette / con ruedas*

Mobile per TV LCD e Plasma

Struttura robusta ed elegante in alluminio.
Piani in vetro temperato.
CABLESS System per raccogliere
e nascondere i fili di collegamento
tra i vari apparecchi.



Stand for LCD and Plasma TVs

Tough elegant aluminium structure.
Toughened glass shelves.
The CABLESS system bundles and hides the cables connecting all devices.

Table en aluminium et verre pour téléviseurs LCD et Plasma

Structure solide et élégante en aluminium.
Plateaux en verre trempé.
Le cableless system permet de regrouper et de dissimuler les câbles de liaison
des différents appareils.

Möbel für LCD-TV - Plasma-TV

Stabiler und formschöner Alu-Aufbau.
Auflagen aus Sicherheitsglas.
CABLESS System für eine ordentliche und unsichtbare Kabelführung zwischen
den verschiedenen Geräten.

Mesa de aluminio y cristal para televisores de LCD y Plasma

Estructura robusta y elegante de aluminio.
Baldas de cristal templado.
El sistema cubre cables permite agrupar y ocultar los cables de los
diferentes aparatos.

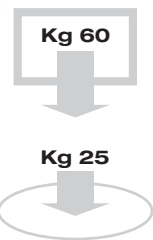



FLAT
VISION
Club
TV LCD-PLASMA



Club 200

Supporto universale per TV LCD e Plasma

Piani in vetro temperato.

Piastra di sostegno universale con aste regolabili, adatta per televisori fino a 65".

CABLESS System per raccogliere e nascondere i fili di collegamento tra i vari apparecchi.

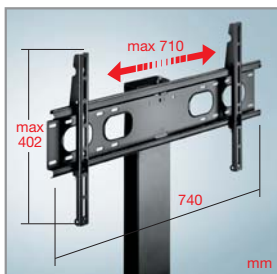

Art. 500199

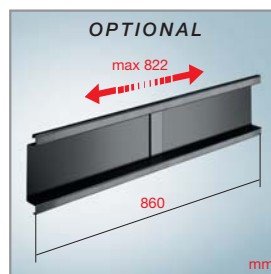

Art. 500197



Universal support for LCD and Plasma TVs

Toughened glass shelves.

Universal mount with adjustable shafts, suitable for televisions up to 65".

The CABLESS system bundles and hides the cables connecting all devices.

Pied universel orientable pour téléviseurs LCD et Plasma

Plateaux en verre trempé.

La platine de fixation est compatible avec des écrans jusqu'à 65".

Le cableless system permet de regrouper et de dissimuler dans la colonne les câbles de liaison des différents appareils.

Universal-Ständer für LCD- und Plasma-TV

Auflagen aus Sicherheitsglas.

Universal-Auflageplatte mit verstellbaren Stangen, passend für TV-Geräte bis 65".

CABLESS System für eine ordentliche und unsichtbare Kabelführung zwischen den verschiedenen Geräten.

Pie universal orientable para televisores de LCD y Plasma.

Baldas de cristal templado.

El soporte de fijación es compatible con las pantallas de hasta 65".

El sistema cubre cables permite agrupar y ocultar dentro de la columna los cables de los diferentes aparatos.



Kg 45 32" ÷ 65"
81 cm ÷ 165 cm

Kg 25



FLAT
VISION
Zen
TV LCD-PLASMA



Zen 300

Mobile per TV LCD e Plasma

Piani in vetro temperato.
CABLESS System per raccogliere e nascondere i fili di collegamento tra i vari apparecchi.



Stand for LCD and Plasma TVs

Toughened glass shelves.
The CABLESS system bundles and hides the cables connecting all devices.

Table en aluminium et verre pour téléviseurs LCD et Plasma

Plateaux en verre trempé.
Le cableless system permet de regrouper et de dissimuler les câbles de liaison des différents appareils.

Möbel für LCD-TV - Plasma-TV

Auflagen aus Sicherheitsglas.
CABLESS System für eine ordentliche und unsichtbare Kabelführung zwischen den verschiedenen Geräten.

Mesa de aluminio y cristal para televisores de LCD y Plasma

Baldas de cristal templado.
El sistema cubre cables permite agrupar y ocultar los cables de los diferentes aparatos.



Kg 60



Kg 25





FLAT
VISION
Air
TV LCD-PLASMA



Air 200

Supporto universale per TV LCD e Plasma

Piani in vetro temperato.

Piastra di sostegno universale con aste regolabili, adatta per televisori fino a 43".

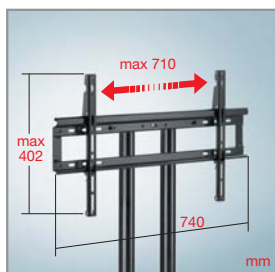

Universal support for LCD and Plasma TVs

Toughened glass shelves.

Universal mount with adjustable shafts, suitable for televisions up to 43".

Pied universel pour téléviseurs LCD et Plasma

Plateaux en verre trempé.

La platine de fixation est compatible avec des écrans jusqu'à 43"

Universal-Ständer für LCD- und Plasma-TV

Auflagen aus Sicherheitsglas.

Universal-Auflageplatte mit verstellbaren Stangen, passend für TV-Geräte bis 43".

CABLESS System für eine ordentliche und unsichtbare Kabelführung zwischen den verschiedenen Geräten.

Pie universal orientable para televisores de LCD y Plasma

Baldas de cristal templado.

El soporte de fijación es compatible con las pantallas de hasta 43".



Kg 45 32" ÷ 43"
81 cm ÷ 109 cm

Kg 25

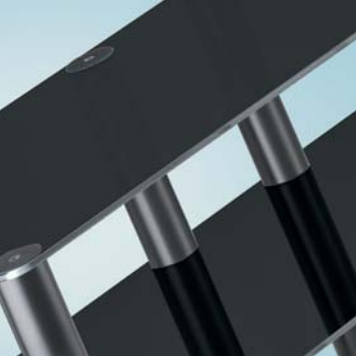

FLAT
VISION

Sun
TV LCD-PLASMA



Sun 200

Mobile per TV LCD e Plasma
Piani in vetro temperato.

Stand for LCD and Plasma TVs
Toughened glass shelves.

Table en aluminium et verre pour téléviseurs LCD et Plasma
Plateaux en verre trempé.

Möbel für LCD-TV - Plasma-TV
Auflagen aus Sicherheitsglas.

Mesa de aluminio y cristal para televisores de LCD y Plasma
Baldas de cristal templado.

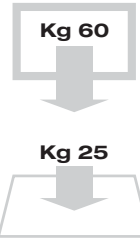



FLAT
VISION
Flexi
TV LCD-PLASMA



Flexi 300



*con ruote / with castors
avec roulette / con ruedas*

Mobile per TV LCD e Plasma

Piani in vetro temperato.
CABLESS System per raccogliere e nascondere i fili di collegamento tra i vari apparecchi.



Stand for LCD and Plasma TVs

Toughened glass shelves.
The CABLESS system bundles and hides the cables connecting all devices.

Table en aluminium et verre pour téléviseurs LCD et Plasma

Plateaux en verre trempé.
Le cableless system permet de regrouper et de dissimuler les câbles de liaison des différents appareils.

Möbel für LCD-TV - Plasma-TV

Auflagen aus Sicherheitsglas.
CABLESS System für eine ordentliche und unsichtbare Kabelführung zwischen den verschiedenen Geräten.

Mesa de aluminio y cristal para televisores de LCD y Plasma

Baldas de cristal templado.
El sistema cubre cables permite agrupar y ocultar los cables de los diferentes aparatos.

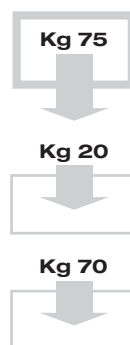



FLAT
VISION

Night
TV LCD-PLASMA



Night 300

Mobile per TV LCD e Plasma

Piani in vetro temperato.
CABLESS System per raccogliere e nascondere i fili di collegamento tra i vari apparecchi.



*con ruote / with castors
avec roulette / con ruedas*



Stand for LCD and Plasma TVs

Toughened glass shelves.
The CABLESS system bundles and hides the cables connecting all devices.

Table en aluminium et verre pour téléviseurs LCD et Plasma

Plateaux en verre trempé.
Le cableless system permet de regrouper et de dissimuler les câbles de liaison des différents appareils.

Möbel für LCD-TV - Plasma-TV

Auflagen aus Sicherheitsglas.
CABLESS System für eine ordentliche und unsichtbare Kabelführung zwischen den verschiedenen Geräten.

Mesa de aluminio y cristal para televisores de LCD y Plasma

Baldas de cristal templado.
El sistema cubre cables permite agrupar y ocultar los cables de los diferentes aparatos.

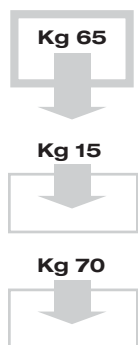

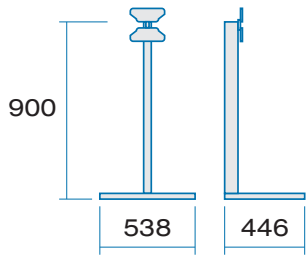

Fly 50
Supporto per LCD
LCD TV support

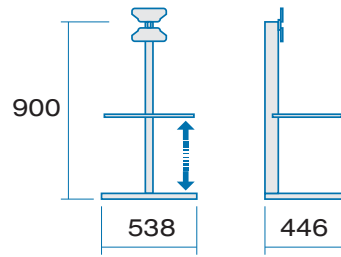

Fly 100
Supporto per LCD
1 piano in vetro
LCD TV support
1 glass shelf

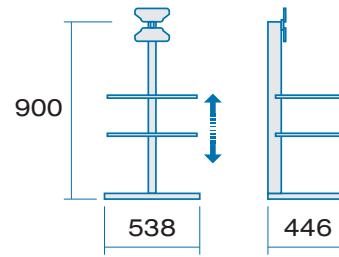

Fly 200
Supporto per LCD
2 piani in vetro
LCD TV support
2 glass shelves

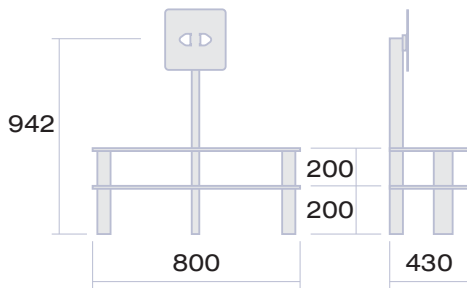
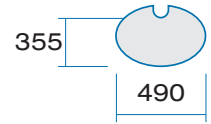

Nice 200
Supporto per LCD
2 piani in vetro
LCD TV support
2 glass shelves

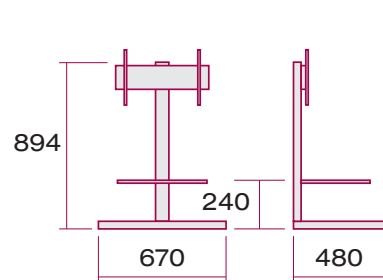
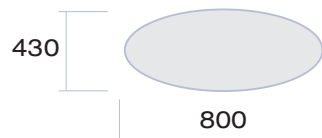

Sky 100
Supporto per LCD e Plasma
1 piano in vetro
LCD and Plasma TV support
1 glass shelf

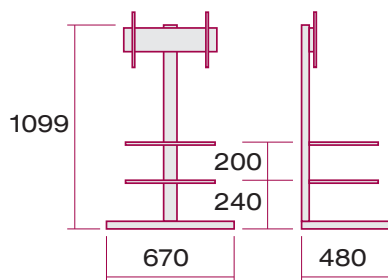

Sky 200
Supporto per LCD e Plasma
2 piani in vetro
LCD and Plasma TV support
2 glass shelves

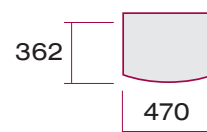

FLAT
VISION
Star

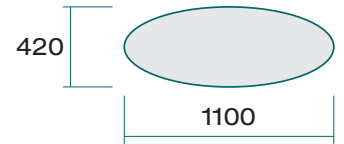
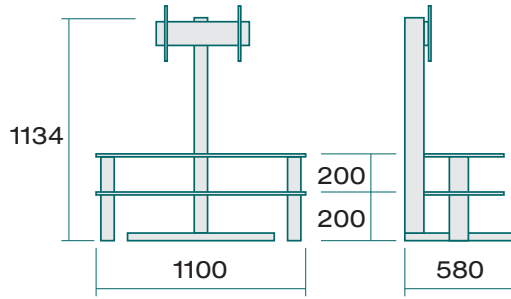
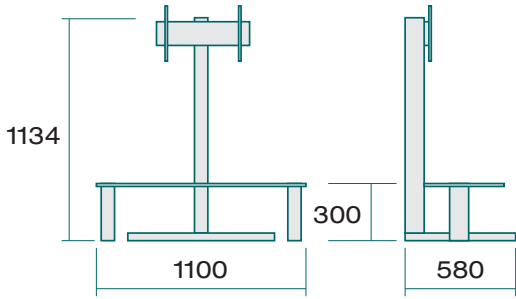

Star 100

Supporto per LCD e Plasma
1 piano in vetro
LCD and Plasma TV support
1 glass shelf

Star 200

Supporto per LCD e Plasma
2 piani in vetro
LCD and Plasma TV support
2 glass shelves

FLAT
VISION
Expò

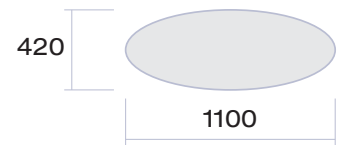
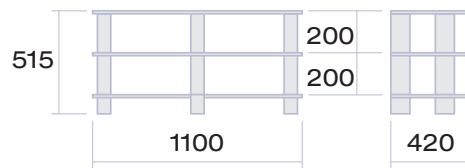
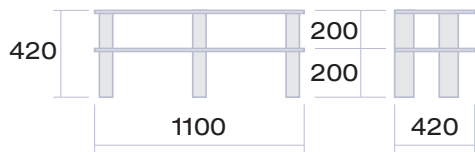

Expò 200

Mobile per LCD e Plasma
2 piani in vetro
LCD and Plasma TV unit
2 glass shelves

Expò 300

Mobile per LCD e Plasma
3 piani in vetro
LCD and Plasma TV unit
3 glass shelves

FLAT
VISION
Club

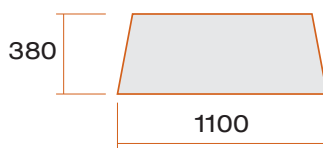
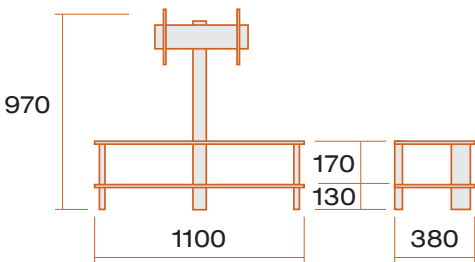

Club 200

Mobile per LCD e Plasma
2 piani in vetro
LCD and Plasma TV unit
2 glass shelves

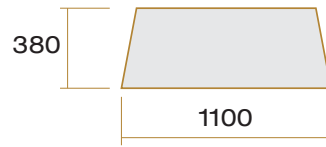
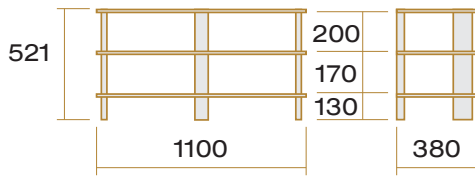

Zen 300
Mobile per LCD e Plasma
3 piani in vetro
LCD and Plasma TV unit
3 glass shelves

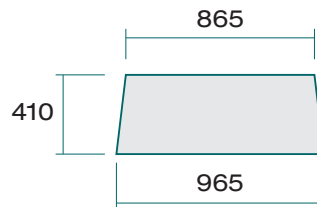
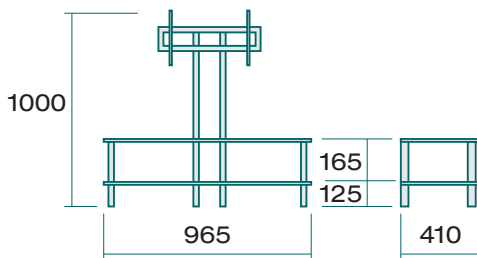

Air 200
Supporto per LCD e Plasma
2 piani in vetro
LCD and Plasma TV support
2 glass shelves

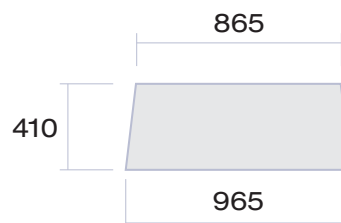
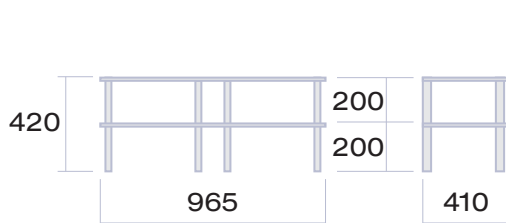

Sun 200
Mobile per LCD e Plasma
2 piani in vetro
LCD and Plasma TV unit
2 glass shelves

FLAT
VISION
Night

Dimensioni: mm
Dimension: mm

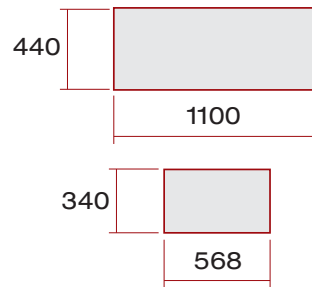
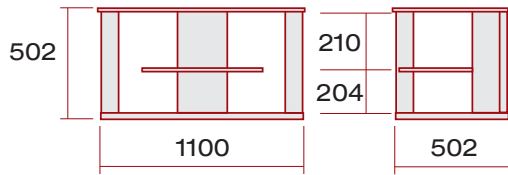

Flexi 300

Mobile per LCD e Plasma
2 piani in vetro, 1 in legno
LCD and Plasma TV unit
2 glass shelves, 1 wood shelf

FLAT
VISION
Flexi

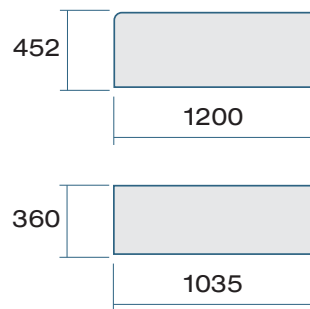
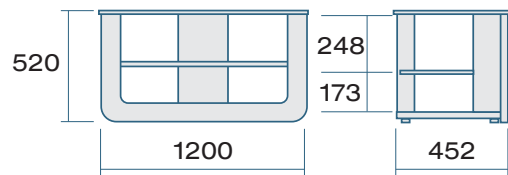

Night 300

Mobile per LCD e Plasma
2 piani in vetro, 1 in legno
LCD and Plasma TV unit
2 glass shelves, 1 wood shelf

Prodotto	Colore	Cod. prodotto	Pz. x cartone	Dimensioni imballo (cm)	Codice EAN
Article description	Colour	Art. code	Pcs x carton	Carton sizes (cm)	EAN code
Flat Vision Fly 50	●	500100	1	93,5 x 50,5 x 6,9	8006023043873
Flat Vision Fly 100	●	500101	1	93,5 x 50,5 x 6,9	8006023043897
Flat Vision Fly 100	●	500103	1	93,5 x 50,5 x 6,9	8006023045730
Flat Vision Fly 200	●	500102	1	93,5 x 50,5 x 6,9	8006023043927
Flat Vision Fly 200	⚡	500104	1	93,5 x 50,5 x 6,9	8006023045754
Flat Vision Nice 200	●	500107	1	81,5 x 61,5 x 12	8006023057146
Flat Vision Sky 100	●	500111	1	116,5 x 60,5 x 19,5	8006023044511
Flat Vision Sky 100	●	500113	1	116,5 x 60,5 x 19,5	8006023046829
Flat Vision Sky 200	●	500110	1	116,5 x 60,5 x 19,5	8006023044375
Flat Vision Sky 200	●	500112	1	116,5 x 60,5 x 19,5	8006023046805
Flat Vision Sky 200 <small>con ruote with castors</small>	●	500114	1	116,5 x 60,5 x 19,5	8006023059805
Flat Vision Star 100	●	500120	1	116,5 x 60,5 x 20,5	8006023044399
Flat Vision Star 200	●	500121	1	116,5 x 60,5 x 20,5	8006023044412
Flat Vision Star 200	●	500123	1	116,5 x 60,5 x 20,5	8006023049073
Flat Vision Expò 200	●	500130	1	116,5 x 56,5 x 20,5	8006023044436
Flat Vision Expò 200	●	500136	1	116,5 x 56,5 x 20,5	8006023050055
Flat Vision Expò 300	●	500131	1	116,5 x 56,5 x 20,5	8006023044450
Flat Vision Expò 300	●	500132	1	116,5 x 56,5 x 20,5	8006023049097
Flat Vision Club 200	●	500150	1	114 x 43 x 13	8006023048427
Flat Vision Zen 300	●	500160	1	114 x 43 x 13	8006023049325
Flat Vision Air 200	●	500250	1	110 x 45 x 10,5	8006023054930
Flat Vision Sun 200	●	500255	1	110 x 45 x 10,5	8006023054954
Flat Vision Flexi 300	○	500170	1	124 x 54,5 x 17	8006023065851
Flat Vision Flexi 300	●	500171	1	124 x 54,5 x 17	8006023065875
Flat Vision Flexi 300	●	500172	1	124 x 54,5 x 17	8006023065899
Flat Vision Flexi 300	●	500173	1	124 x 54,5 x 17	8006023065912
Flat Vision Night 300	●	500165	1	114 x 48 x 15,5	8006023065820



La sicurezza e la qualità dei supporti Meliconi sono state certificate dal gruppo TÜV dopo il superamento di una serie di severi test. In particolare il carico massimo dichiarato è stato verificato con un fattore di sicurezza pari a 3 volte il peso.

The safety and quality of Meliconi's supports are certified by TÜV upon successful completion of severe tests. Load-bearing capacity has been tested loading the product with three times the maximum weight stated on it.

