

KENWOOD

KAC-X401M

MONO POWER AMPLIFIER ▶ Page 2-13

INSTRUCTION MANUAL

AMPLIFICATEUR DE PUISSANCE MONAURAL ▶ Page 14-25

MODE D'EMPLOI

AMPLIFICADOR DE POTENCIA MONOFONICO ▶ Page 26-37

MANUAL DE INSTRUCCIONES

KENWOOD CORPORATION

Take the time to read through this instruction manual.

Familiarity with installation and operation procedures will help you obtain the best performance from your new power amplifier.

For your records

Record the serial number, found on the back of the unit, in the spaces designated on the warranty card, and in the space provided below.

Refer to the model and serial numbers whenever you call upon your KENWOOD dealer for information or service on the product.

Model KAC-X401M Serial number _____

Safety precautions

▲WARNING

To prevent injury or fire, take the following precautions:

- When extending the ignition, battery, or ground wires, make sure to use automotive-grade wires or other wires with a 5mm² (AWG10) or more to prevent wire deterioration and damage to the wire coating.
- To prevent a short circuit, never put or leave any metallic objects (such as coins or metal tools) inside the unit.
- If the unit starts to emit smoke or strange smells, turn off the power immediately and consult your Kenwood dealer.
- Do not touch the unit during use because the surface of the unit becomes hot and may cause burns if touched.

▲CAUTION

To prevent damage to the machine, take the following precautions:

- Be sure the unit is connected to a 12V DC power supply with a negative ground connection.
- Do not open the top or bottom covers of the unit.
- Do not install the unit in a spot exposed to direct sunlight or excessive heat or humidity. Also avoid places with too much dust or the possibility of water splashing.
- When replacing a fuse, only use a new one with the prescribed rating. Using a fuse with the wrong rating may cause your unit to malfunction.
- To prevent a short circuit when replacing a fuse, first disconnect the wiring harness.

NOTE

- If you experience problems during installation, consult your Kenwood dealer.
- If the unit does not seem to be working right, consult your Kenwood dealer.

Cleaning the unit

If the front panel gets dirty, turn off the power and wipe the panel with a dry silicon cloth or soft cloth.



▲CAUTION

Do not wipe the panel with a hard cloth or a cloth dampened by volatile solvents such as paint thinner and alcohol. They can scratch the surface of the panel and/or cause the indicator letters to peel off.

FCC WARNING

This equipment may generate or use radio frequency energy. Changes or modifications to this equipment may cause harmful interference unless the modifications are expressly approved in the instruction manual. The user could lose the authority to operate this equipment if an unauthorized change or modification is made.

Accessories

Part name	External View	Number of Items
Terminal cover (Power terminal)		1
Self-tapping screws (ø5 × 18 mm)		4

Installation procedure

Since there are large variety of settings and connections possible according to applications, read the instruction manual well to select the proper setting and connection.

1. Remove the ignition key and disconnect the negative ⊖ terminal of the battery to prevent short circuits.
2. Set the unit according to the intended usage.
3. Connect the input and output wires of the units.
4. Connect the speaker wires and sigma servo feed back wires.
5. Connect the power wire, power control wire and grounding wire following this order.
6. Install the unit in the car.
7. Connect the negative ⊖ terminal of the battery.

▲CAUTION

- If sound is not output normally, immediately turn power off and check connections. Be sure to perform the sigma servo connection correctly.
- Be sure to make correct connections of the sigma servo terminals.
- Be sure to turn the power off before changing the setting of any switch.
- If the fuse blows, check wires for shorts, then replace the fuse with one of the same rating.
- Check that no unconnected wires or connectors are touching the car body. Do not remove caps from unconnected wires or connectors to prevent short circuits.

Installation procedure

- Connect the speaker wires to appropriate speaker connectors separately. Sharing the negative wire of the speaker or grounding speaker wires to the metal body of the car can cause this unit to fail.

- After installation, check that the brake lamps, wipers, and wipers work properly.

Installation

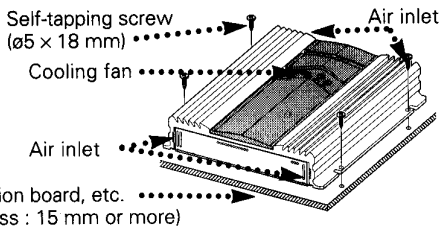
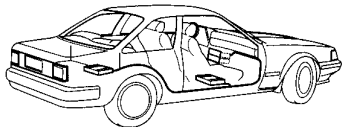

- Since the power amplifier has no parts which require operation, it can be installed at a position away from the driver's seat without any hindrances. As generally accepted positions for its installation, places such as inside the trunk, etc. can be considered.
- Use the extension cables. (Optional.)

Type	Length	0.5m	1m	2m	4m	5m	6m
RCA cable		CA-2SL	CA-12SL	CA-22SL	—	CA-52SL	—
RCA cable (ø7mm)		CA-3WL	CA-13WL	CA-23WL	—	CA-53WL	—
RCA cable (ø12mm)		CA-5W	CA-15W	CA-25W	CA-45W	—	CA-65W

CAUTION

- Do not install the unit under the carpet. Otherwise heat build-up occurs and the unit may be damaged.
- Install this unit in a location which allows heat to easily dissipate. Once installed, do not place any object on top of the unit.
- The surface temperature of the amplifier will become hot during use. Install the amplifier in a place where people, resins, and other substances that are sensitive to heat will not come into contact with it.
- This unit has cooling fans to decrease the internal temperature. Be careful not to block the cooling fan openings when installing the unit. Blocking these openings will inhibit the cooling of the internal temperature and result in malfunction.
- When making a hole under a seat, inside the trunk, or somewhere else in the vehicle, check that there is nothing hazardous on the opposite side such as a gasoline tank, brake pipe, or wiring harness, and be careful not to cause scratches or other damage.
- Do not install near the dashboard, rear tray, or air bag safety parts.
- The installation to the vehicle should securely fasten the unit to a place in which it will not obstruct driving. If the unit comes off due to a shock and hits a person or safety part, it may cause injury or an accident.
- After installing the unit, check to make sure that electrical equipment such as the brake lamps, turn signal lamps and windshield wipers operate normally.

Controls

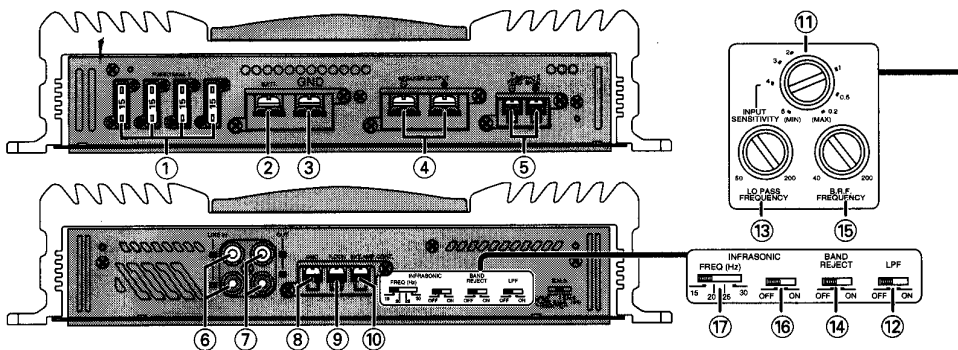

① Fuse (15 A × 4)

② Battery terminal

③ Ground terminal

④ SPEAKER OUTPUT terminals

As this unit accepts speakers with a minimum impedance of 2 ohms, connect speakers with 2-ohm or higher impedance to these terminals.

⚠ CAUTION

The rated input of the speakers should be no less than the maximum output of the amplifier. Otherwise malfunction may result.

⑤ SIGMA SERVO FEED BACK terminals (See p.11)

⚠ CAUTION

Be sure to make proper connections to the SIGMA SERVO FEED BACK terminals. Incorrect connection may result in lack of sound output or other malfunctions.

⑥ RCA cable ground lead terminal

⑦ LINE IN terminal

⑧ LINE OUT terminal

⑨ Power control terminal

⑩ EXT.AMP.CONT. (external amplifier control) terminal

This controls the B.M.S. (See P.6).

⑪ INPUT SENSITIVITY control

Adjust this control according to the pre-out level of the center unit connected to this amplifier.

NOTE

Refer to "Specifications" on the center unit's instruction manual about the pre-out level.

⑫ Low Pass Filter switch

When this switch is set to ON, the bass is boosted because the frequencies of the lower frequency band than the cutoff frequency set with the LPF FREQUENCY control are output.

⑬ LPF FREQUENCY control

Sets the cutoff frequency when the FILTER switch is set to LPF.

⑭ BAND REJECT filter switch

When this switch is set to ON, frequencies in the band set with the BAND REJECT FREQUENCY control are rejected and eliminated. The band rejection allows to reduce resonance inside the vehicle compartment and standing waves. (See P.12)

⑮ BAND REJECT FREQUENCY control

Sets the rejection frequency when the BAND REJECT switch is set to ON. (See P.12)

⑯ INFRASONIC FILTER switch

When this switch is set to ON, the inaudible, ultralow frequencies below the frequency set with the INFRASONIC FILTER FREQUENCY control are cut off. This improves the reproduction performance of the speakers by eliminating unnecessary oscillations which will not become sound.

⑰ INFRASONIC FILTER FREQUENCY switch

Switches the cutoff frequency when the INFRASONIC FILTER switch is set to ON.

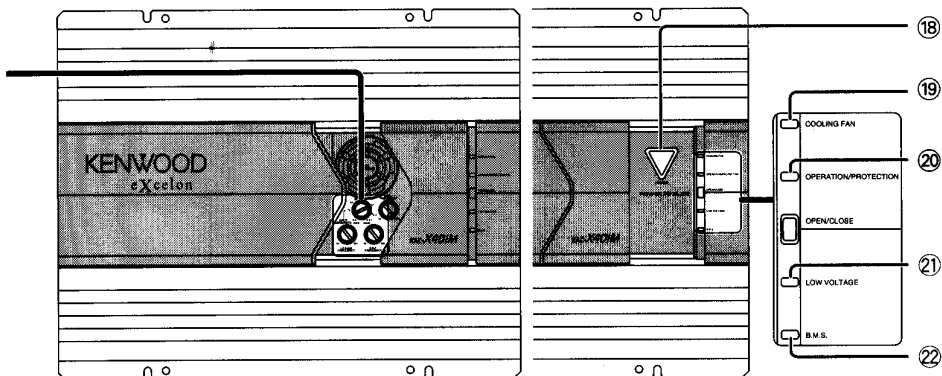

18 POWER indicator

This indicator glows when the unit's power is turned ON.

19 COOLING FAN indicator

When the unit's internal temperature rises, the slide panel opens automatically and the cooling fan is activated.

The cooling fan is also activated when the slide panel is opened.

While the cooling fan is in operation, the COOLING FAN indicator blinks.

20 OPERATION/PROTECTION indicator

This indicator glows when the power comes ON normally.

If the PROTECTION function is activated, the indicator blinks or goes out.

21 LOW VOLTAGE indicator

This indicator glows when the power voltage falls below 11V (volts).

If the power supply voltage returns to full after a voltage drop, this indicator will blink to alert the user that a voltage drop has occurred.

The number of blinks indicates the number of times the voltage has dropped (up to a maximum of 10).

22 B.M.S. indicator

This indicator glows when the bass boost is turned ON using the B.M.S. (See P.6).

NOTE

If indicators 19 to 22 light up in succession or blink in unison, the system is in DEMO mode. If this happens, cancel DEMO mode by pressing the OPEN/CLOSE button.

PROTECTION function

This unit incorporates a protection function which protects the main unit and speakers from troubles. The unit stops to function when the protection function is activated.

When the OPERATION/PROTECTION indicator blinks:

- A speaker wire may be short-circuited.
- A speaker output may be in contact with the ground.
- The temperature of the internal parts may be higher than 120°C (248°F)
- The fuse of this unit may be blown.
- The unit may be malfunctioning and sending DC signal to the speaker output.
- The sigma servo connection may be erroneous.

Canceling: turn the accessory power source (ACC) OFF, then back ON.

When the POWER indicator and the OPERATION/PROTECTION function both go out:

- The fuse of this unit may be blown.

When the LOW VOLTAGE indicator glows or blinks:

- Is the battery exhausted?
- The car battery has a small capacity.
- If the battery wire is too thin or too long, it will not be able to supply enough power.
- Is the battery wire deteriorated?

B.M.S. (Bass Management System)

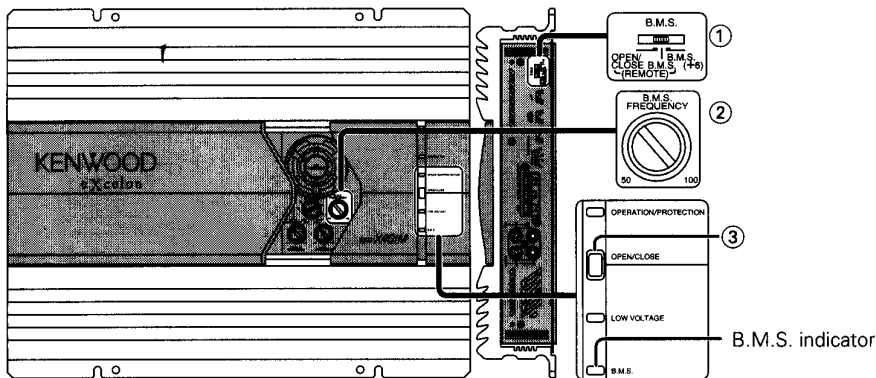

■ If the unit is not going to be operated from the outside:

① B.M.S. switch

This boosts the bass, focusing mainly on the frequency setting determined using the B.M.S. FREQUENCY control.

• (REMOTE) OPEN/CLOSE or (REMOTE) B.M.S. position:

When the switch is in this position, the bass is not boosted.

Bass boost	Flat (OFF)
Slide panel	Operations using the OPEN/CLOSE button

• B.M.S. (+6) position:

When the switch is in this position, the bass is boosted by 6dB.
The B.M.S. indicator glows.

Bass boost	+6dB (ON)
Slide panel	Operations using the OPEN/CLOSE button

② B.M.S. FREQUENCY control

When the B.M.S. switch is set to the B.M.S. (+6) position, this control can be used to adjust the central frequency that you want to emphasise.

③ OPEN/CLOSE button

Each time you press this button, the slide panel either opens or closes.

NOTE

- If the slide panel meets an obstacle while sliding, the slide operation will be halted. If this happens, remove the obstacle and then press the OPEN/CLOSE button again.
- If the center unit power is switched OFF, or the vehicle engine is switched OFF, while the slide panel is open, the slide panel will then close automatically. The next time the power is turned ON or the vehicle engine is turned ON, the slide panel will return to its original open state.
- If the B.M.S. switch setting is changed to (REMOTE), the slide panel will close in preparation for remote operation, even if the EXT.AMP.CONT. terminal is not connected.

CAUTION

Take care not to allow your finger or any other object to be trapped by the slide panel while it is sliding.

■ If the unit is going to be operated from the center unit:

The amount of bass boost and the opening/closing of the slide panel can be controlled from the center unit. Additionally, up to 3 power amplifiers can be set at the same time.

NOTE

Kenwood center units released in 1999 or later having an "EXT.AMP.CONT." wire operate this unit. Instructions on how to operate the center unit will be found in the instruction manual supplied with the center unit.

① **B.M.S. switch**

This switch is used to select the range of control operations that can be carried out from the center unit.

When the bass boost is switched ON, the B.M.S. indicator glows.

• (REMOTE) OPEN/CLOSE position:

When the switch is in this position, only the opening/closing of the slide panel can be controlled from the center unit; the bass cannot be boosted.

Center unit setting status	AMP BASS Flat	AMP BASS +6	AMP BASS +12
Bass boost	Flat (OFF)		
Slide panel	CLOSE	OPEN	

• (REMOTE) B.M.S. position:

When the switch is in this position, any of the three bass boost settings — FLAT, +6dB and +12dB — can be selected from the center unit. If "+6 dB" or "+12 dB" is selected, the slide panel will open.

Center unit setting status	AMP BASS Flat	AMP BASS +6	AMP BASS +12
Bass boost	Flat (OFF)	+6dB (ON)	+12dB (ON)
Slide panel	CLOSE	OPEN	

• B.M.S. (+6) position:

When the switch is in this position, the bass is boosted by 6dB, regardless of any operation carried out from the center unit.

Center unit setting status	AMP BASS Flat	AMP BASS +6	AMP BASS +12
Bass boost	+6dB (ON)		
Slide panel	Operations using the OPEN/CLOSE button		

② **B.M.S. FREQUENCY control**

This control allows you to use the B.M.S. to adjust the central frequency that you want to emphasise.

③ **OPEN/CLOSE button**

- When the B.M.S. switch is in the B.M.S. (+6) position, the slide panel will open or close each time the button is pressed.
- When the B.M.S. switch is set to the (REMOTE) position, the center unit will control the slide panel.

If you want to adjust the control inside the slide panel, you can open/close the slide panel temporarily by pressing the OPEN/CLOSE button.

NOTE

- If the slide panel meets an obstacle while sliding, the slide operation will be halted. If this happens, remove the obstacle and then press the OPEN/CLOSE button again.
- When the B.M.S. is in the (REMOTE) position, and control operations are carried out on the center unit, the slide panel will return to the status set on the center unit even if it is opened/closed using the OPEN/CLOSE button.
- If the center unit power is switched OFF, or the vehicle engine is turned OFF, when the slide panel is open, the slide panel will automatically close. When the power is turned back ON, or when the vehicle engine is turned ON, the slide panel will carry out an action depending on the setting status of the B.M.S. switch, as follows.
 - * If the B.M.S. switch is in the (REMOTE) position, the slide panel will obey the setting on the center unit.
 - * If the B.M.S. switch is in the B.M.S. (+6) position, the slide panel will return to its original open state.

CAUTION

Take care not to allow your finger or any other object to be trapped by the slide panel while it is sliding.

Connection

■ RCA cable connection

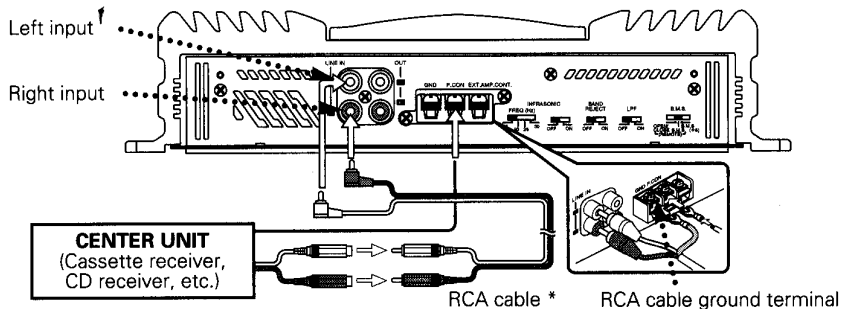

RCA cable ground terminal

When using an RCA cable with a ground lead attached, connect the ground lead to this terminal.

▲CAUTION

Do not use this terminal for power source grounding. This unit will be damaged if the power source grounding cable is connected to this terminal.

■ Speakers wire connection

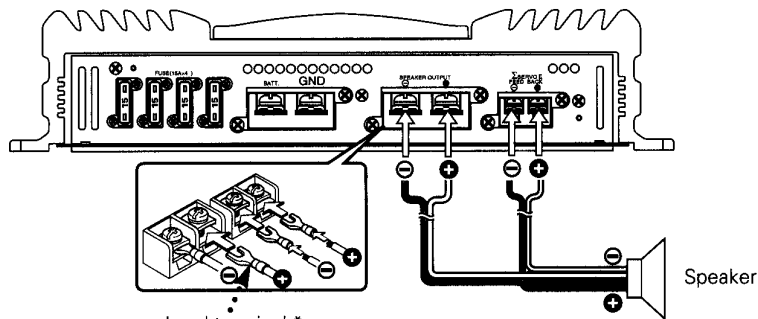

* : Commercially available parts

NOTE

Distribute the speaker wires and sigma servo wires along the same paths.

■ Speaker Selection

- The rated input power of the speakers that are going to be connected should be greater than the maximum output power (in Watts) of the amplifier. Use of speakers having input power ratings that are less than the output power of the amplifier will cause smoke to be emitted as well as damage.
- Use speakers that have an impedance of 2Ω or greater. When more than one set of speakers are going to be used, calculate the combined impedance of the speakers and then connect suitable speakers to the amplifier.

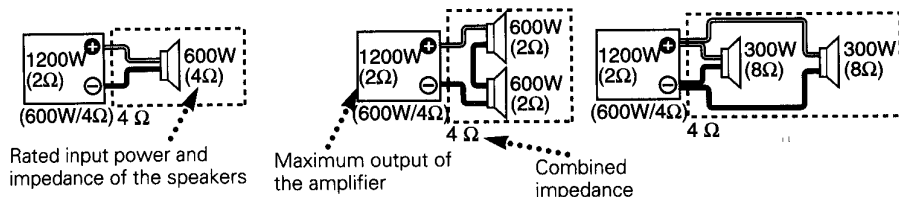

■ Control terminal

Attach the connection terminal to a commercially available wiring wier for in-car use, and connect it to the unit.

NOTE

An EXT.AMP.CONT. terminal can only be attached if Kenwood center unit is a model released in 1999 or latter, and has an "EXT.AMP.CONT." wire. Using the external amp control, up to 3 power amplifiers can be operated simultaneously (although this may not be possible, depending on the type of wiring wier used, and its length).

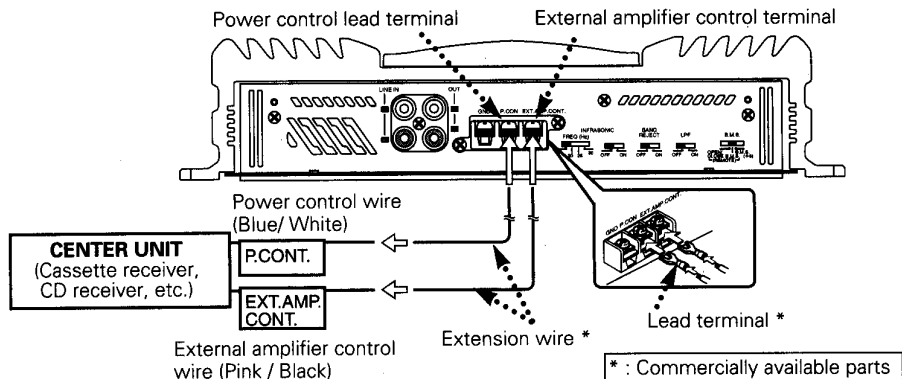

Connection

■ Power wire connection

⚠ WARNING

To prevent fire caused by a short in the wiring, connect a fusible link or breaker nearby the battery's positive terminal.

Wiring

- If a buzzing noise is heard from the speakers when the engine is running, connect a line noise filter (optional) to each of the battery wire.
- Do not allow the wire to directly contact the edge of the iron plate by using Grommets.
- Connect the ground wire to a metal part of the car chassis that acts as an electrical ground passing electricity to the battery's negative terminal. Do not turn the power on if the ground wire is not connected.
- Please be sure to install a protective fuse in the power wire, near the battery. Use a fuse which has a capacity about 10A higher than the capacity of the fuse in the unit.
- For the power wire and the earth wire, use (flame-resistant) power wiring wires for in-car use. For the power wire, use a power wiring wire with a current capacity about 10A higher than the capacity of the protective fuse (about 20A higher than the capacity of the fuse in the unit).
- When more than one power amplifier are going to be used, use a power supply wiring wire and protective fuse of greater current-handling capacity than the total maximum current drawn by each amplifier.

Example: One Power Amplifier Is Used

Fuse capacity	Protective Fuse	Cross-sectional Area of Wiring Wire (AWG)
60 A	75 A x 1 [25 A x 3]	5 mm ² (AWG 10) or greater x 1

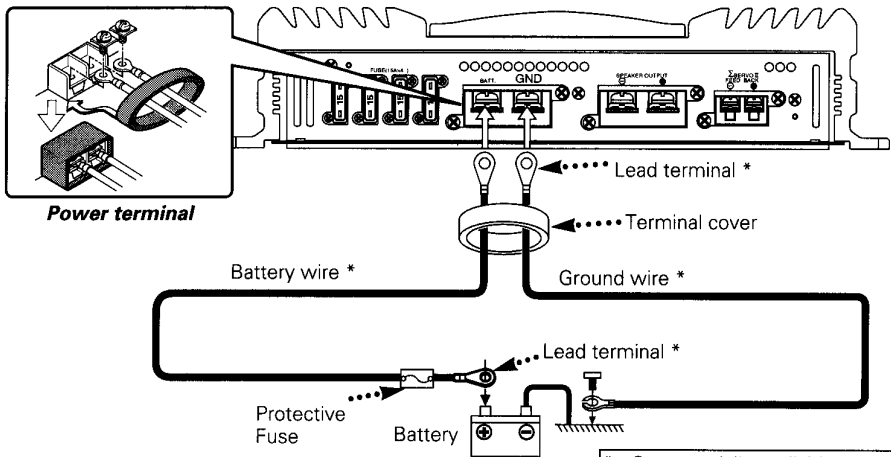
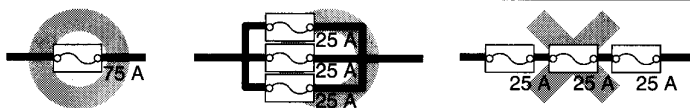

* : Commercially available parts

Power terminal

Pass battery and ground wires through supplied terminal cover and connect to respective terminals. After completing connections, fasten terminal cover over terminal bracket.

Sigma servo feed back

The sound reproduced through conventional amplifiers is distorted due to the counterelectromotive force produced in the oscillating system of the speaker. The counterelectromotive force is particularly high with the woofer which requires a large drive mass. The sigma servo connection reduces distortion caused by the counterelectromotive force by including the circuit up to the speaker terminals in the negative feedback loop. This makes it possible to drive speakers with more fidelity to the input signals and create a sharp bass sound image with few feeling of noise interference.

NOTE

The speaker wires and sigma servo wires should be distributed along the same paths.

CAUTION

- The extension of the negative feedback loop to include the speaker terminals makes it necessary to connect the sigma servo terminals correctly. Incorrect connection may result in sound degradation or other malfunction. If sound is not reproduced normally, check the connection of the sigma servo terminals, etc.
- If the Sigma servo terminals are not connected, the sound may fluctuate or noise may occur. Be sure to connect the Sigma servo terminals correctly.
- When connecting speakers in a parallel configuration, use speakers with an impedance of 4 ohms or more. Connecting speakers with smaller impedance than 4 ohms will cause malfunction.
- The rated input of the speakers connected to this unit should be no less than the maximum output of the amplifier. Otherwise malfunction may result. Be specially careful in this when connecting speakers in a parallel configuration.

Basic sigma servo connection

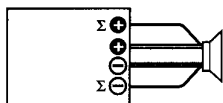

Series connection

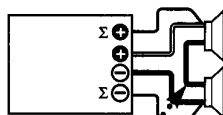

CAUTION

Make this wire as short as possible.

Parallel connection (1)

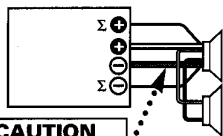

CAUTION

The speaker wires connected to this unit should be thick enough to supply the current capacity of two speakers.

Parallel connection (2)

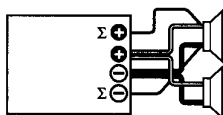

CAUTION

This connection is possible only when the speakers are identical and the speaker wires are also of the same type and length.

Simplified sigma servo connection

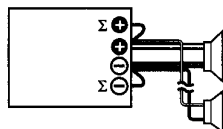

In case any of the connection examples above cannot be used or if the speakers cannot be connected to the speaker terminals, connect them to this unit as shown in the figure.

Connection

The acoustic properties of vehicle compartment tend to cause oscillation due to resonance or unclearness of sound due to standing waves at certain frequencies. The band reject filter can solve the problems of resonance or unclear sound with minimum influence on the sound quality because it eliminates only the frequencies causing resonance or standing waves.

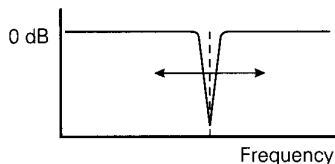

■ Adjustment method:

The band reject filter cuts only the limited frequencies to minimize influence on the sound quality. Therefore, its effect cannot be obtained unless the cutoff frequencies are set accurately to the frequencies causing resonance and standing waves. The band reject filter can be adjusted according to what you feel through your ears, but we recommend the use of a signal generator or a spectrum analyzer with a fine frequency measurement capability for the adjustment.

• Adjustment using a signal generator:

Output a sine wave, vary its frequency to find the frequencies at which the vehicle compartment resonates or volume increases (standing waves occur), and set the BAND REJECT FREQUENCY control to the position with which the resonance and standing waves disappear.

• Adjustment using a spectrum analyzer:

Output white noise (sound in which all frequencies are at a certain level), find the peak frequency observed on the spectrum analyzer, and set the BAND REJECT FREQUENCY control to the position with which the peak observed on the spectrum analyzer disappears.

Troubleshooting Guide

What might appear to be a malfunction in your unit may just be the result of slight misoperation or miswiring. Before calling service, first check the following table for possible problems.

PROBLEM	POSSIBLE CAUSE	SOLUTION
No sound. (No sound from one side.)	<ul style="list-style-type: none">• Input (or output) cables are disconnected.• Protection circuit may be activated.• The fuse may be blown because the volume was too high.	<ul style="list-style-type: none">• Connect the input (or output) cables.• Check connections by referring to "Controls".• Replace the fuse with a new fuse and use a lower volume.
The output level is too small (or too large).	The input sensitivity adjusting control is not set to the correct position.	Adjust the control correctly referring to "Controls".
The sound quality is bad. (The sound is distorted.)	<ul style="list-style-type: none">• The speakers wire are connected with wrong \oplus / \ominus polarity.• A speaker wire is pinched by a screw in the car body.• The switches may be set improperly.	<ul style="list-style-type: none">• Connect them properly checking the \oplus / \ominus of the terminals and wires well.• Connect the speaker wire again so that it is not pinched by anything.• Set switches properly by referring to "Controls".

Troubleshooting Guide

PROBLEM	POSSIBLE CAUSE	SOLUTION
If the slide panel moves of its own accord.	<ul style="list-style-type: none">• The system is in DEMO mode.• The slide panel has gone into remote operation mode.	<ul style="list-style-type: none">• Cancel DEMO mode by pressing the OPEN/CLOSE button.• Check the B.M.S. and operate the slide panel remotely or manually.
The external amplifier controller (B.M.S.) will not work.	<ul style="list-style-type: none">• The B.M.S. switch is set to "B.M.S. (+6)".• The external amplifier control wire has come loose.	<ul style="list-style-type: none">• The B.M.S. switch is set to "(REMOTE)".• Check that the external amplifier control wire is properly connected.

Specifications

Specifications subject to change without notice.

Audio Section

Max Power Output (2 Ω)	1200 W \times 1
Rated Power Output (+B = 12.0 V)	
(4 Ω)	200 W \times 1 (20 Hz ~ 20 kHz, 0.05 % THD)
(2 Ω)	400 W \times 1 (1 kHz, 0.5 % THD)
Rated Power Output (+B = 14.4 V)	
(4 Ω)	300 W \times 1 (20 Hz ~ 20 kHz, 0.05 % THD)
(2 Ω)	600 W \times 1 (1 kHz, 0.5 % THD)
Frequency Response (+ 0 , - 3 dB)	5 Hz ~ 50 kHz
Total Harmonic Distortion (Rated power)*	0.002 % (1 kHz)
Sensitivity (rated output) (MAX.)	0.2 V
(MIN.)	5.0 V
Signal to Noise Ratio	105 dB
Input Impedance	10 k Ω
Damping Factor	More than 9900 (at Σ connect)
Low Pass Filter Frequency (24 dB/oct.)	50 ~ 200 Hz (variable)
Infrasonic Filter Frequency (24 dB/oct.)	15 / 20 / 25 / 30 Hz
Band Reject Filter Frequency	40 ~ 200 Hz (variable)

* Sensitivity = Mini., Through LPF (30 kHz)

General

Operating Voltage	12.0 V (11 ~ 16 V allowable)
Current Consumption (4 Ω , +B = 12.0 V, 10 % THD)	36 A
Dimensions (W \times H \times D)	272 \times 64 \times 380 mm
	10-11/16 \times 2-1/2 \times 14-15/16 inch
Weight	7.0 kg (15.5 lbs)