

# ▲seb®

## DELICE 30 L

FR

NL

DE



[www.seb.fr](http://www.seb.fr)

## Sommaire - Beknopt overzicht - Inhaltsverzeichnis

1. Description - Beschrijving - Beschreibung	3
2. Consignes de sécurité	5
Veiligheidsvoorschriften	7
Sicherheitshinweise	9
3. Installation - Installatie - Erste Inbetriebnahme	11
4. Modes de cuisson - Bereidingsmogelijkheden - Backarten	12
5. Conseils de nettoyage	19
Reinigungsvoorschriften	
Reinigungshinweise	
6. Guide de cuisson - Bereidingsgids - Garzeitentabelle	22

# 1. Description - Beschrijving - Beschreibung

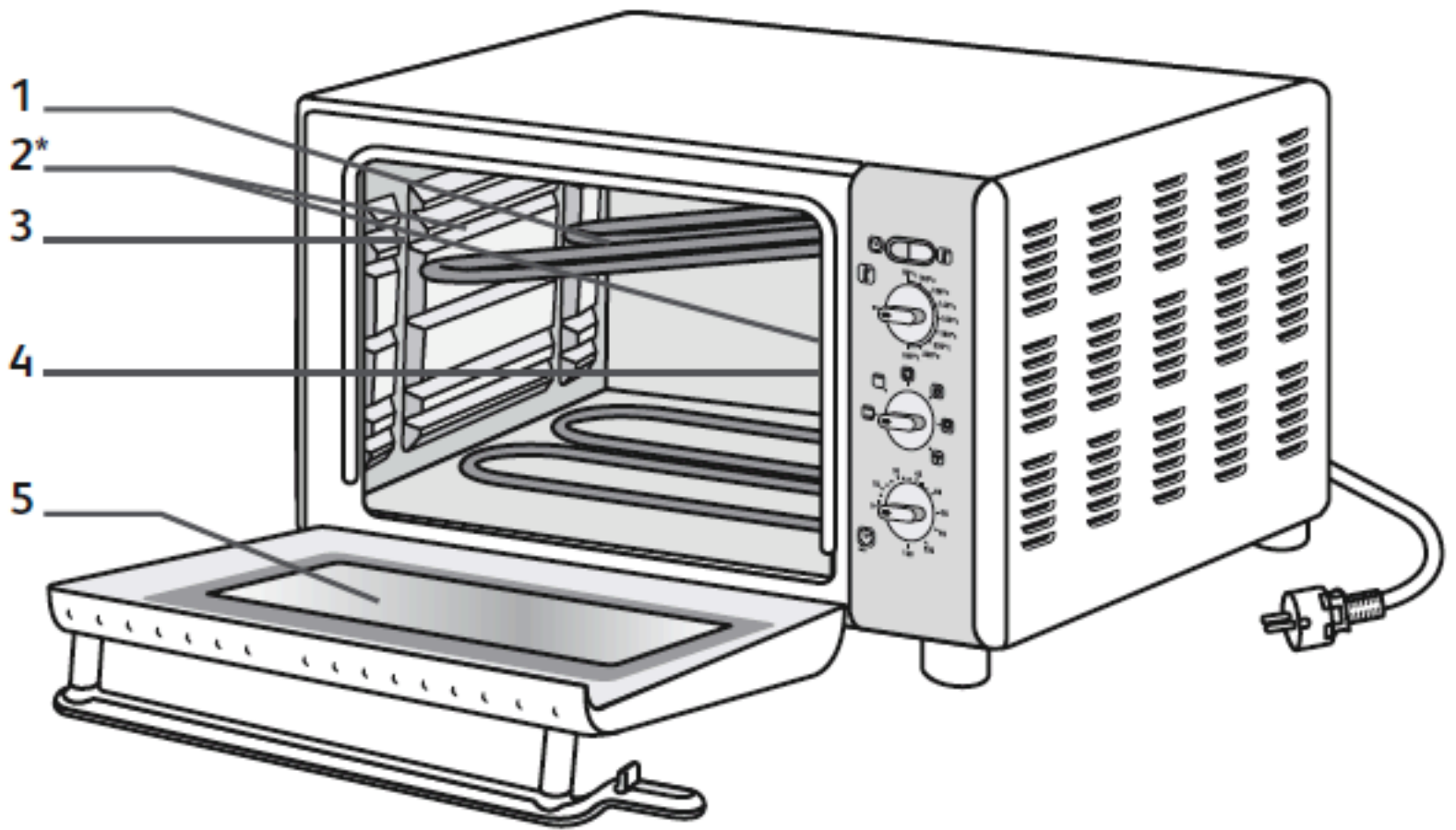

OF2731 Grill

OF2758 Turbo

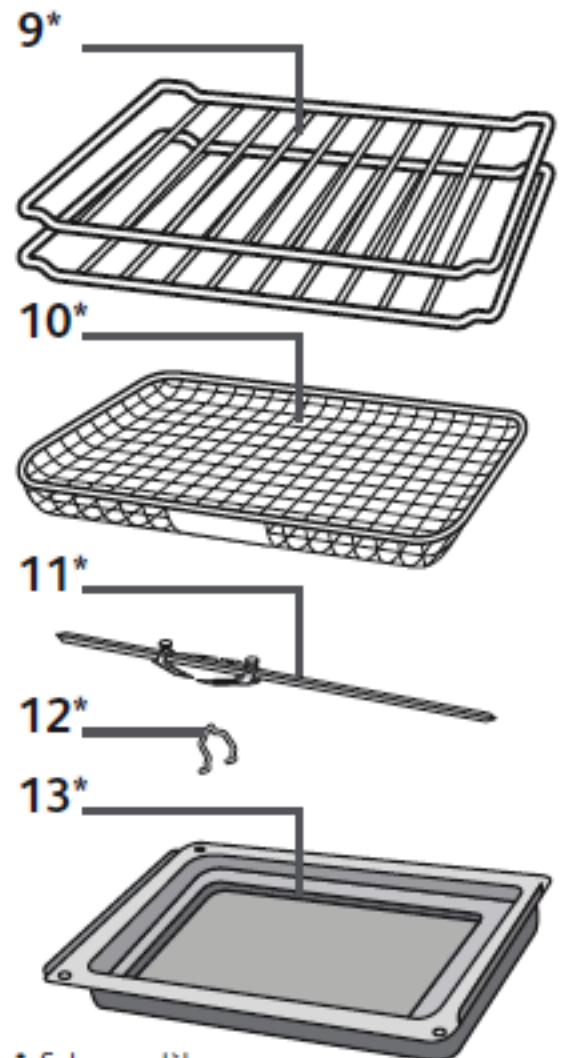
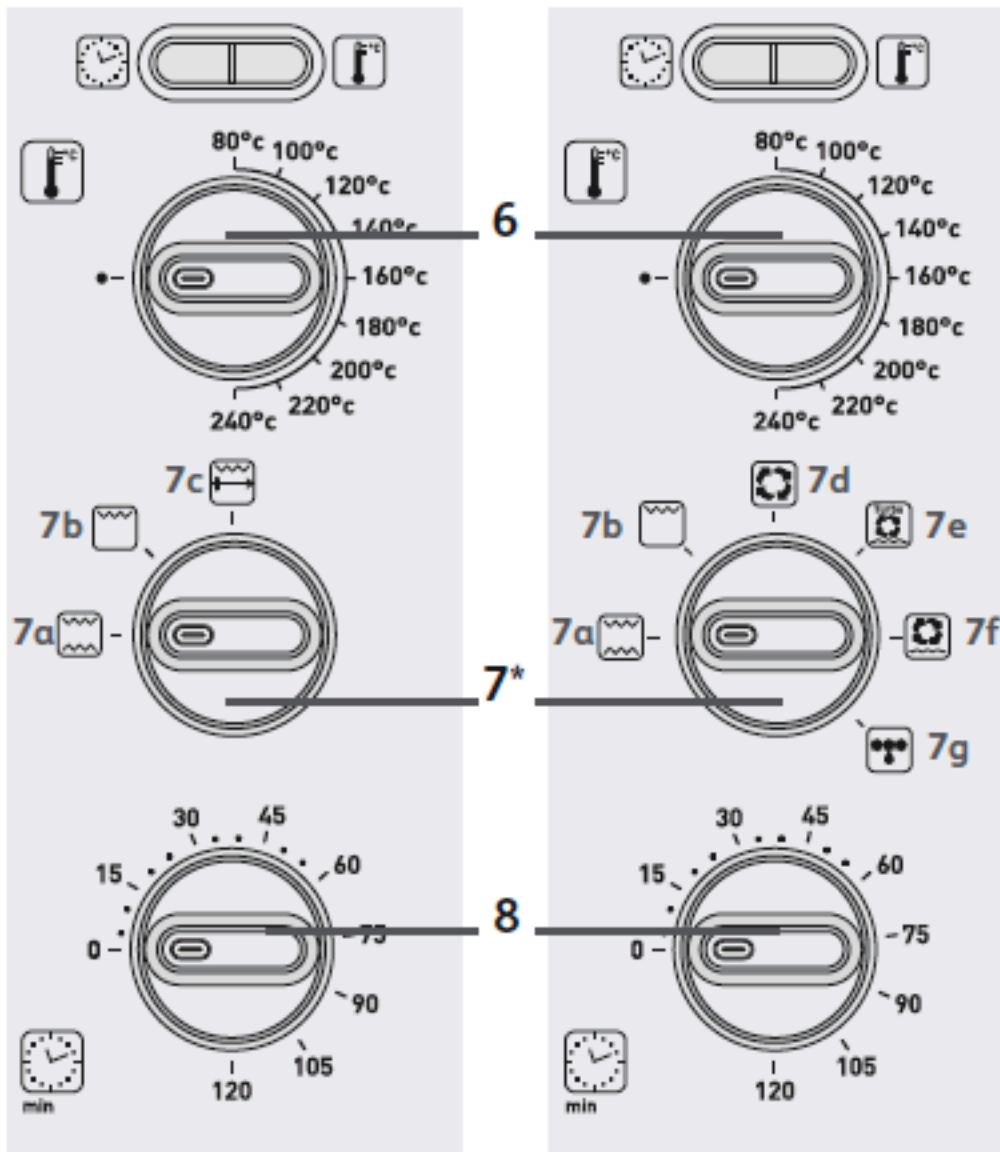

\* Selon modèle  
Afhankelijk van het model  
Je nach Modell

- 1 Résistance supérieure rabattable
- 2 Ouverture support tournebroche\*
- 3 Parois intérieures auto-nettoyantes
- 4 Lumière intérieure
- 5 Porte double parois
- 6 Bouton de réglage de la température
- 7 Boutons de sélection de fonctions
  - a - Four traditionnel
  - b - Grill
  - c - Tournebroche\*
  - d - Chaleur tournante\*
  - e - Turbo\*
  - f - Pâtisserie\*
  - g - Décongélation\*
- 8 Bouton minuterie
- 9 Grilles réversibles\*
- 10 Panier Turbo\*
- 11 Kit tournebroche\*
- 12 Support broche\*
- 13 Plat Lèche-frite

- 1 Inklapbaar verwarmingselement
- 2 Opening voor het bevestigen van de draaispithouder\*
- 3 Zelfreinigende wanden
- 4 Verlichting binnen
- 5 Deur met dubbele wand
- 6 Knop voor instellen temperatuur
- 7 Selectieknop van de functies
  - a - Traditionele oven
  - b - Grill
  - c - Draaispits\*
  - d - Heteluchtoven\*
  - e - Turbo\*
  - f - Patisserie\*
  - g - Ontdooien\*
- 8 Knop timer
- 9 Tweezijdig te gebruiken rooster\*
- 10 Schaal Turbo\*
- 11 Draaispitsset\*
- 12 Draaispithouder\*
- 13 Opvangbak voor vet

- 1 Oberes herunterklappbares Grillelement
- 2 Öffnungen zur Befestigung des Spießhalters\*
- 3 Selbstreinigende Wände
- 4 Innenbeleuchtung
- 5 Doppelwandige Tür
- 6 Regler zur Temperatureinstellung
- 7 Funktionswahlschalter
  - a - Traditioneller Ofen (Ober- und Unterhitze)
  - b - Grill
  - c - Drehspieß\*
  - d - Umluft\*
  - e - Turbo\*-Umluftfunktion
  - f - Backwaren\*
  - g - Auftauen\*
- 8 Zeitschaltuhr
- 9 Beidseitig verwendbarer Backrost\*
- 10 Gitterschale Turbo\*
- 11 Drehspießkit\*
- 12 Drehspießhalter\*
- 13 Emaillierte Bratschale

### FR Précautions importantes

Prenez le temps de lire toutes les instructions et reportez vous au “Guide de cuisson”.

- Cet appareil n'est pas destiné à être mis en fonctionnement au moyen d'une minuterie extérieure ou par un système de commande à distance séparé.
- **⚠ Pour votre sécurité, cet appareil est conforme aux normes et réglementations applicables (Directives Basse Tension, Compatibilité Electromagnétique, Matériaux en contact des aliments, Environnement...).**
- **⚠ Cet appareil n'est pas prévu pour être utilisé par des personnes (y compris les enfants) dont les capacités physiques, sensorielles ou mentales sont réduites, ou des personnes dénuées d'expérience ou de connaissance, sauf si elles ont pu bénéficier, par l'intermédiaire d'une personne responsable de leur sécurité, d'une surveillance ou d'instructions préalables concernant l'utilisation de l'appareil.**
- **⚠ Il convient de surveiller les enfants pour s'assurer qu'ils ne jouent pas avec l'appareil.**
- Ne déplacez pas l'appareil pendant son utilisation.
- Cet appareil n'est pas prévu pour être encastré. Placez votre four sur un plan de travail stable ou sur un meuble de cuisine qui supporte une température d'au moins 90°C. Laissez une libre circulation de l'air tout autour de votre appareil.
- **⚠ Lors de l'utilisation la face arrière de l'appareil doit être placée contre un mur.**
- Prévoyez une distance de 2 cm au minimum entre les aliments et la résistance supérieure
- Il est normal qu'un dégagement de fumée ou odeurs de neuf se dégagent lorsque vous utilisez votre appareil pour la première fois, ce phénomène tout à fait normal disparaîtra rapidement.
- Nous vous conseillons de faire fonctionner la première fois votre four à vide (**sans grille**), pendant 20 minutes environ.
- Vérifiez que la tension du réseau correspond bien à celle indiquée sur l'appareil (**courant alternatif seulement**).
- N'utilisez pas l'appareil si :
  - celui-ci a un câble défectueux ou endommagé,
  - l'appareil est tombé et présente des détériorations visibles ou des anomalies de fonctionnement,
  - si le câble d'alimentation est endommagé, il doit être remplacé par le fabricant, son service après-vente ou des personnes de qualification similaire afin d'éviter un danger.Dans chacun de ces cas, l'appareil doit être envoyé au centre de service après-vente agréé le plus proche afin d'éviter tout danger.
- Assurez-vous que l'installation électrique est suffisante pour alimenter un appareil de cette puissance.
- Branchez toujours l'appareil sur une prise reliée à la terre.
- Ne laissez pas le câble pendre ou toucher les parties chaudes du four.
- Ne débranchez pas l'appareil en tirant sur le câble.
- N'utilisez qu'une rallonge en bon état, avec une prise reliée à la terre, et avec un fil conducteur de section au moins égale au fil fourni avec le produit.
- Débranchez l'appareil lorsqu'il ne sert pas et avant de le nettoyer.
- Afin d'éviter les chocs électriques, ne plongez pas le fil électrique, la prise de courant ou l'appareil dans l'eau ou un autre liquide.
- Ne placez pas l'appareil à proximité d'une source de chaleur ou à proximité d'éléments électriques. Ne le mettez pas sur d'autres appareils.
- **⚠ Les surfaces sont susceptibles de devenir chaudes au cours de l'utilisation. Cet appareil électrique fonctionne avec des températures élevées qui pourraient occasionner des brûlures. Ne pas toucher les parties métalliques ni la vitre.**

- **⚠ La température de la porte et de la surface extérieure peut-être élevée lorsque l'appareil fonctionne.**
- **⚠ Utilisez les poignées et boutons. Utilisez des gants si nécessaire.**
- Manipulez avec précaution la porte de votre four : tout choc brutal ou contraintes thermiques excessives peuvent générer la casse de la vitre. Celle-ci est en verre trempé afin d'éviter tout risque de projection et, donc tout danger pour l'utilisateur.
- Lorsque la porte est ouverte, ne pas poser de plat sur la vitre.
- S'il arrivait que certaines parties du produit s'enflamment. Débranchez l'appareil et n'ouvrez pas la porte. Ne tentez jamais de les éteindre avec de l'eau. Éteufez les flammes avec un linge humide.
- Ne rangez pas de produits inflammables à proximité ou sous le meuble où est placé l'appareil.
- Ne faites pas fonctionner l'appareil sous un meuble mural, une étagère, ou à proximité de matériaux inflammables tels que stores, rideaux, tentures...
- N'utilisez pas l'appareil comme source de chaleur.
- Ne placez jamais de papier, carton ou plastique dans l'appareil et ne posez rien dessus (**ustensiles, grille, objets, plat chaud sorti du four...**).
- Ne mettez pas de feuille d'aluminium sous l'appareil pour protéger le plan de travail, ni entre les éléments chauffants, ni en contact avec les parois intérieures ou les résistances, vous risqueriez d'endommager gravement le fonctionnement du four ou **dégrader le plan de travail.**
- N'introduisez rien dans les ouïes de ventilation, ne les obstruez pas.
- Pour les parois et la sole : n'utilisez ni produit d'entretien agressif (**notamment les décappants à base de soude**), ni éponge-grattoir, ni tampon abrasif. N'utilisez pas de produit d'entretien spécifique pour métaux.
- Pour votre sécurité, ne démontez jamais l'appareil vous-même ; faites appel à un Centre Service Agréé.
- Votre appareil a été conçu pour un usage domestique seulement. Il n'a pas été conçu pour être utilisé dans les cas suivants qui ne sont pas couverts par la garantie :
  - dans des coins de cuisines réservés au personnel dans des magasins, bureaux et autres environnements professionnels,
  - dans des fermes,
  - par les clients des hôtels, motels et autres environnements à caractère résidentiel,
  - dans des environnements de type chambres d'hôtes.
- La lampe\* doit être exclusivement utilisée pour l'éclairage du four. Elle ne doit pas être utilisée sur des luminaires pour l'éclairage des locaux.
- **⚠ Utilisation de la minuterie : tournez à fond et revenez en arrière sur le temps désiré.**

## Gardez précieusement ces consignes



### Participons à la protection de l'environnement !

- ① Votre appareil contient de nombreux matériaux valorisables ou recyclables.
- ➡ Confiez celui-ci dans un point de collecte pour que son traitement soit effectué.



### 3. Première utilisation - Eerste gebruik - Erste Inbetriebnahme

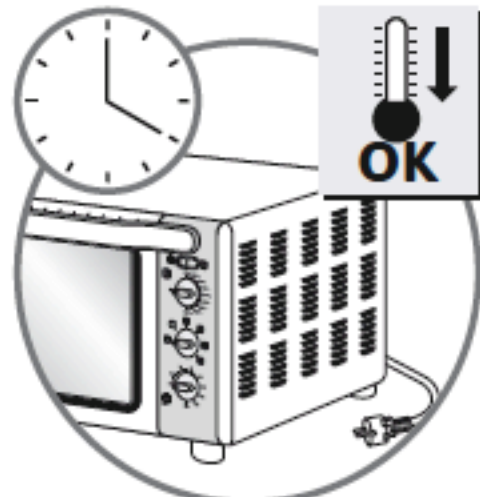
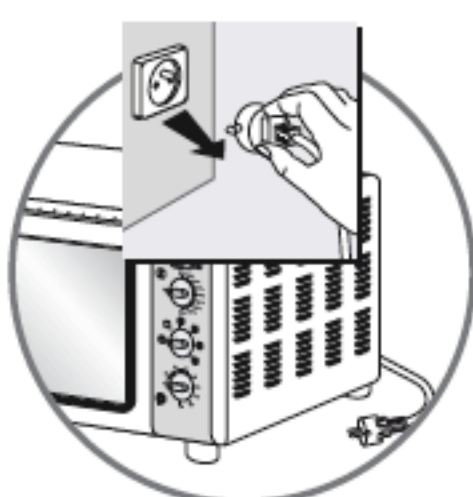
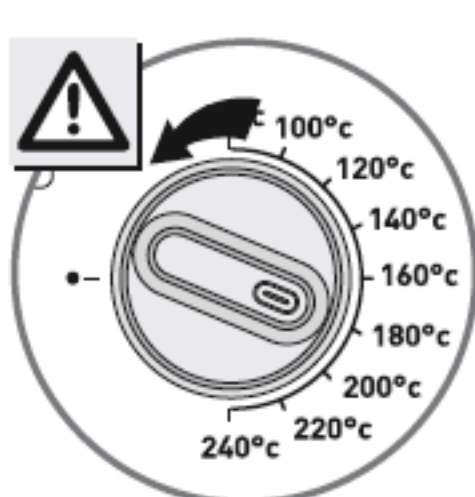
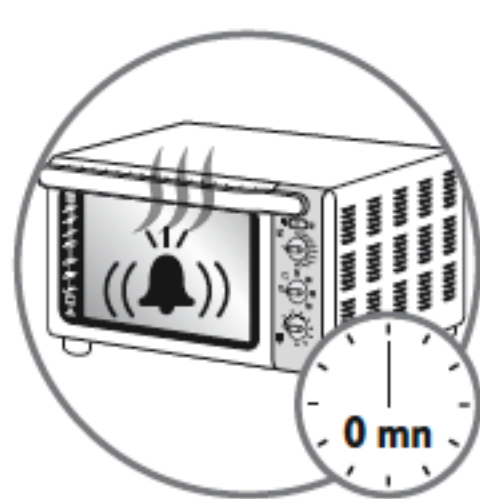
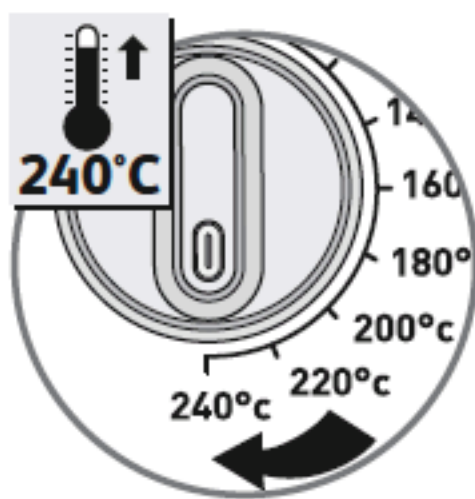
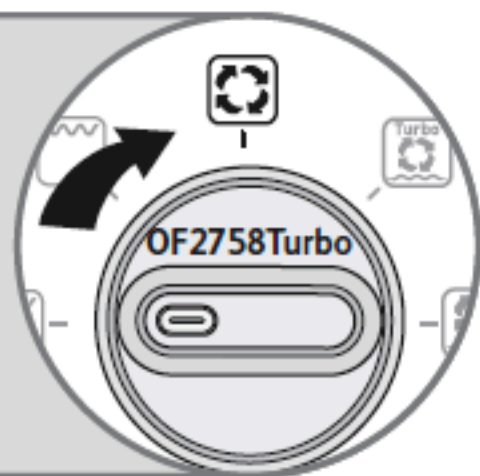
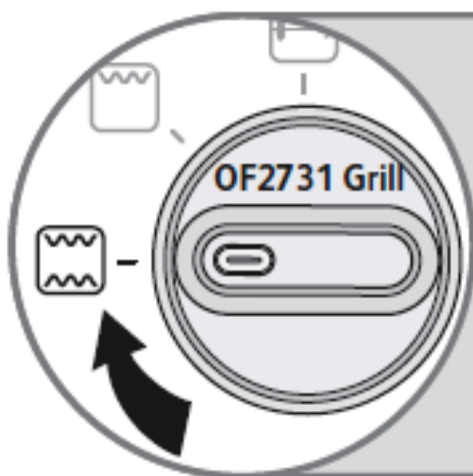
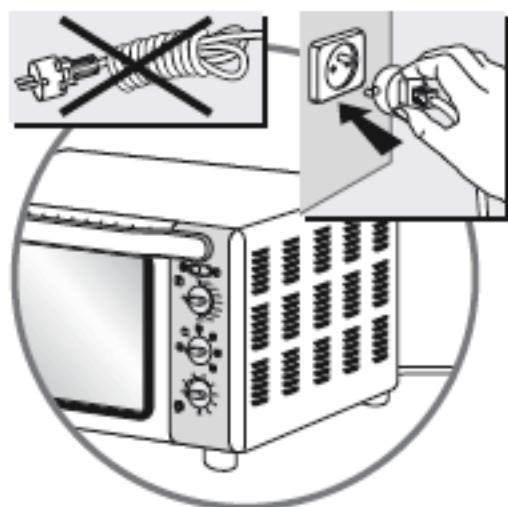
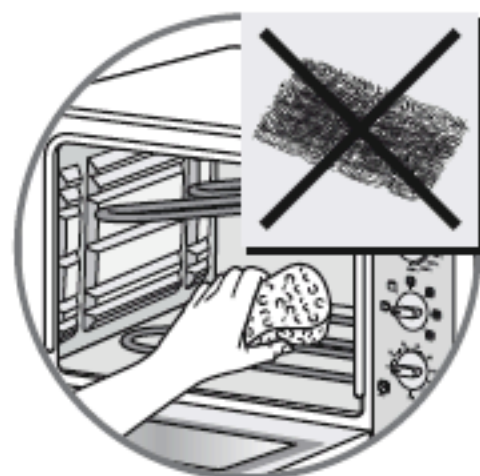
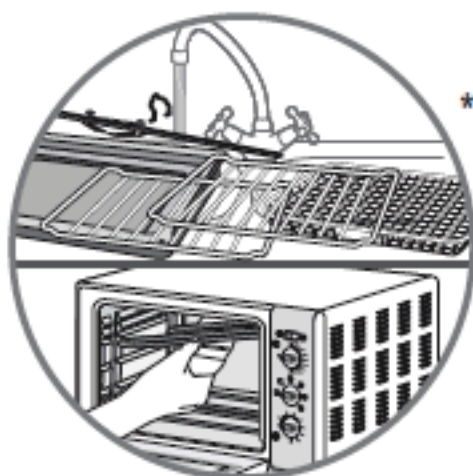
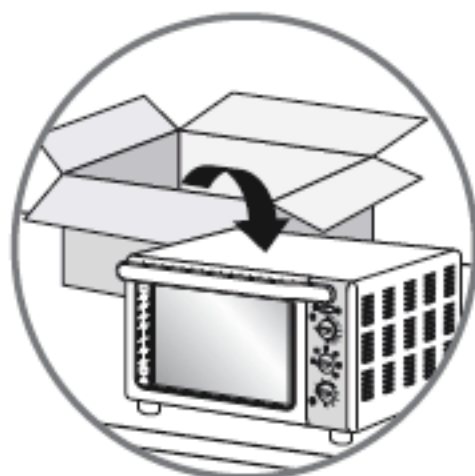
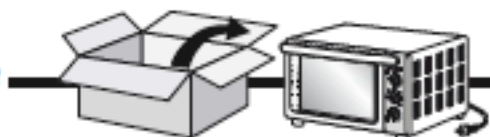

\* Selon modèle - Afhankelijk van het model - Je nach Modell

## 4. Modes de cuisson - Manieren van koken - Backarten

 Four traditionnel - Traditionele oven - Traditioneller Ofen (Ober- und Unterhitze)

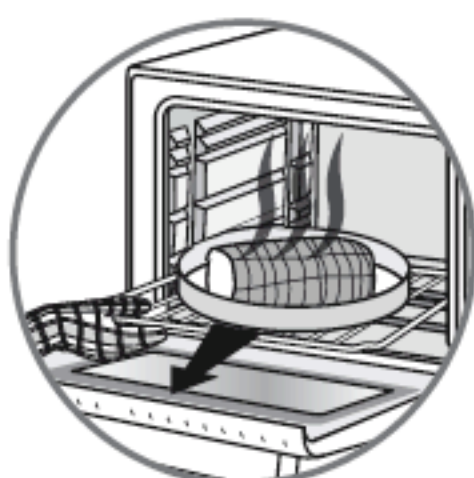
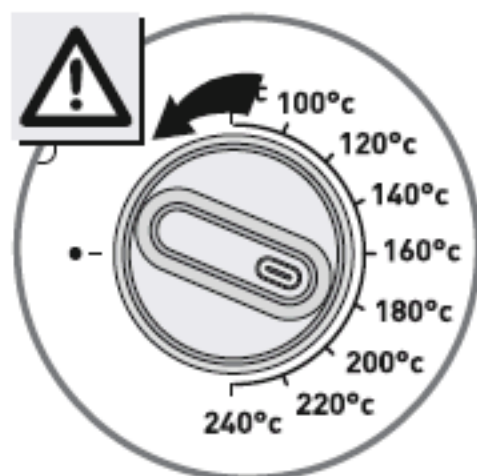
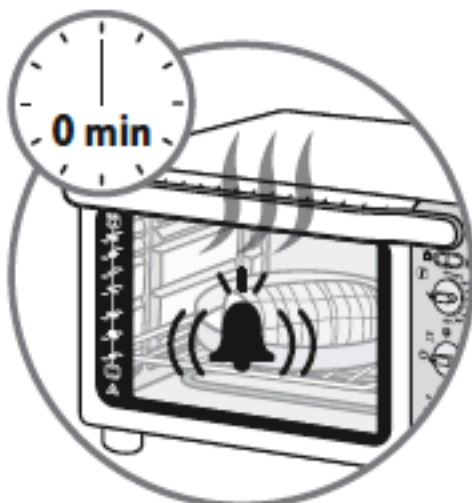
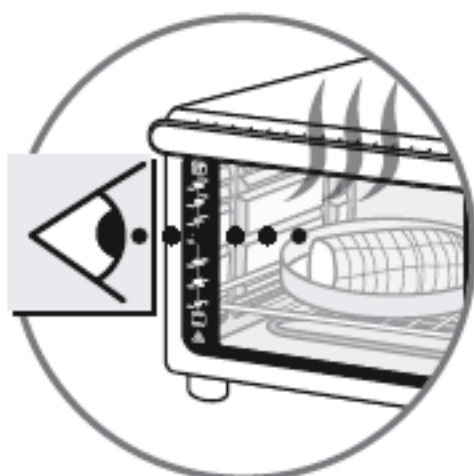
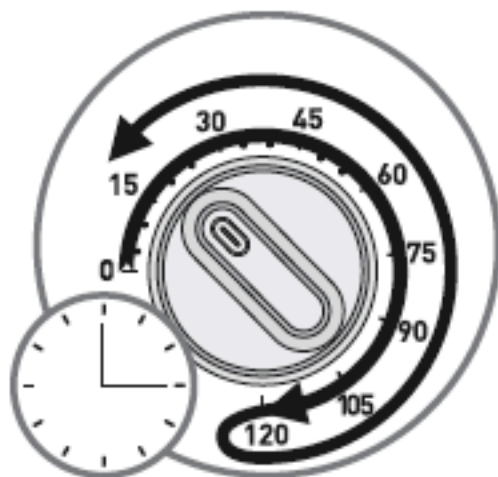
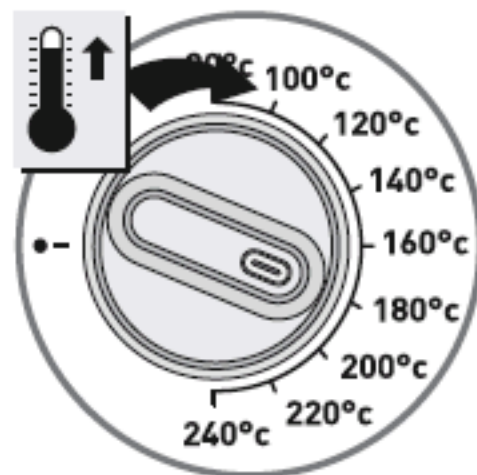
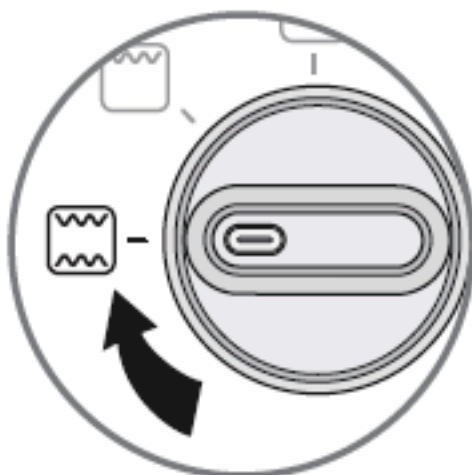
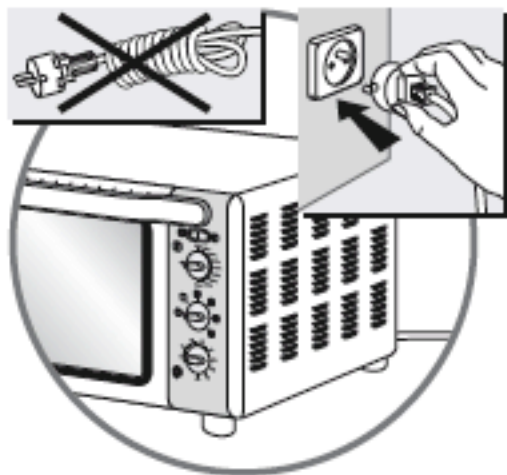



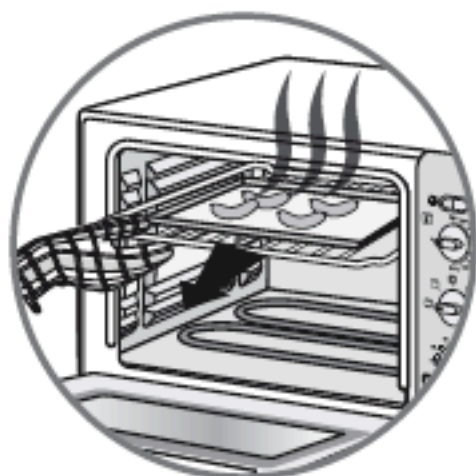
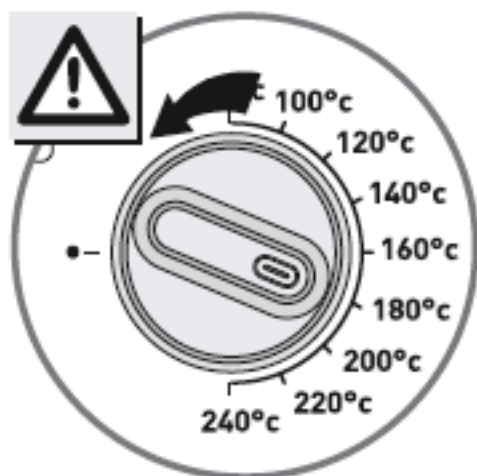
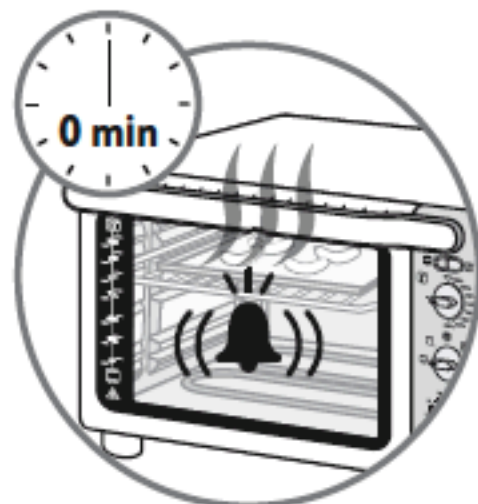
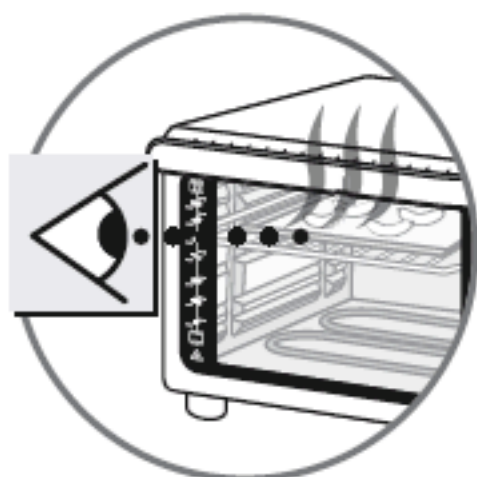
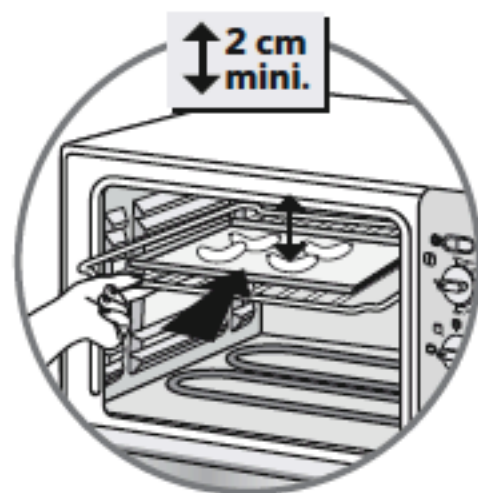
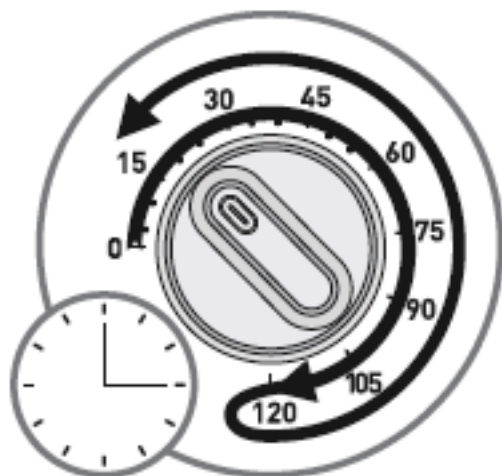
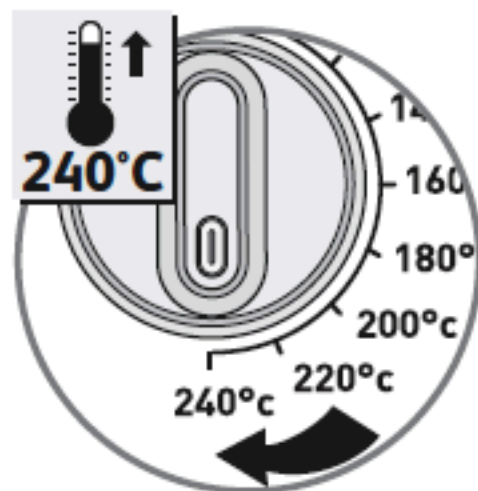
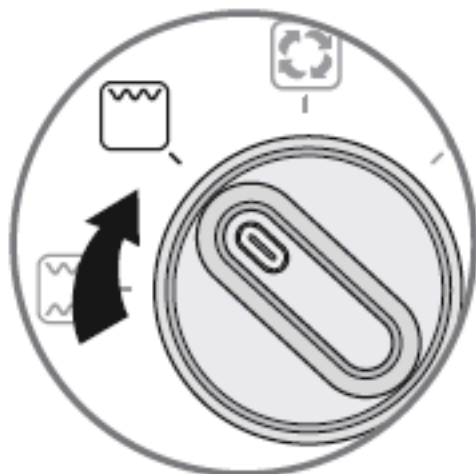
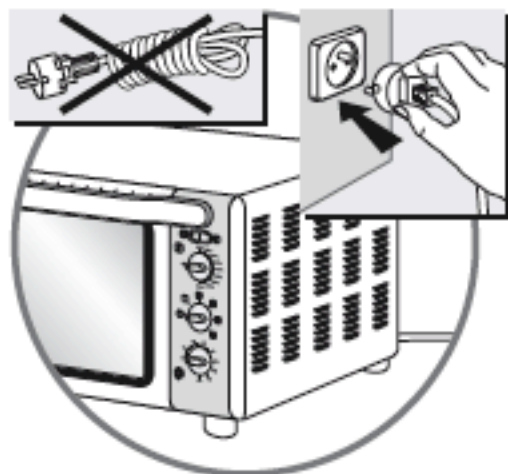

 Grill

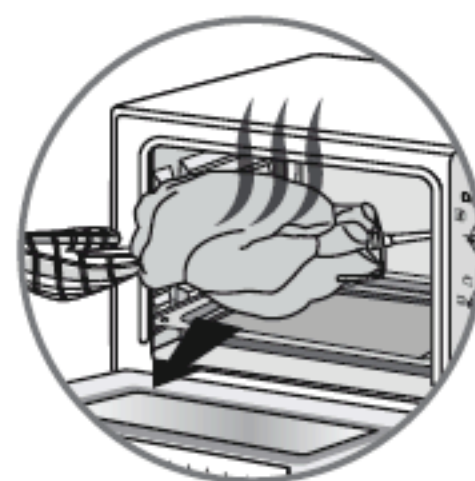
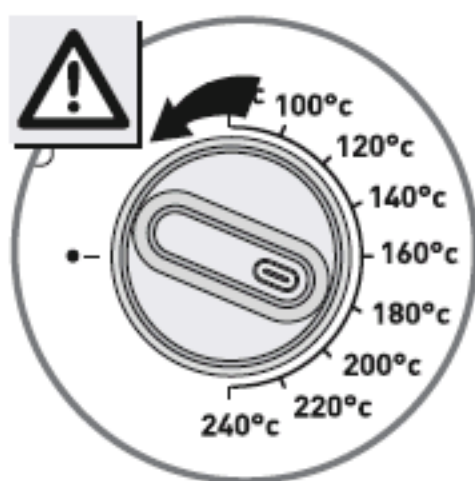
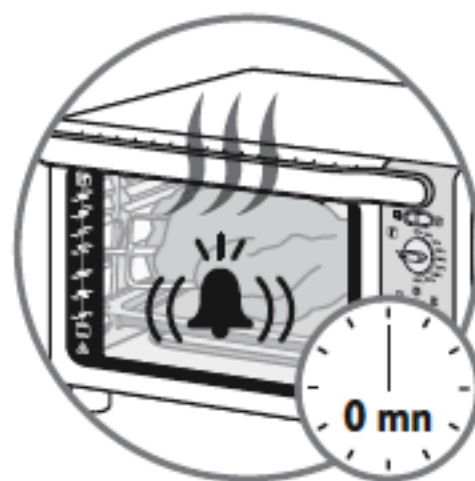
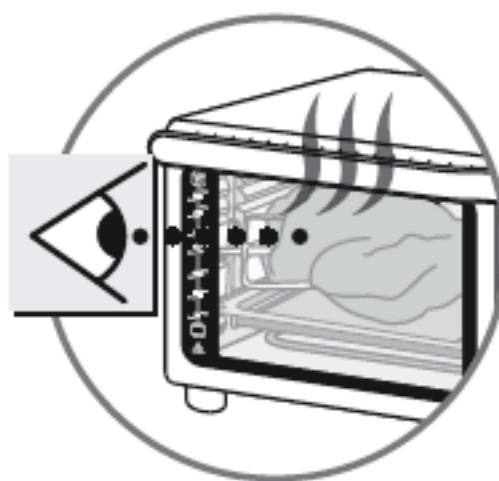
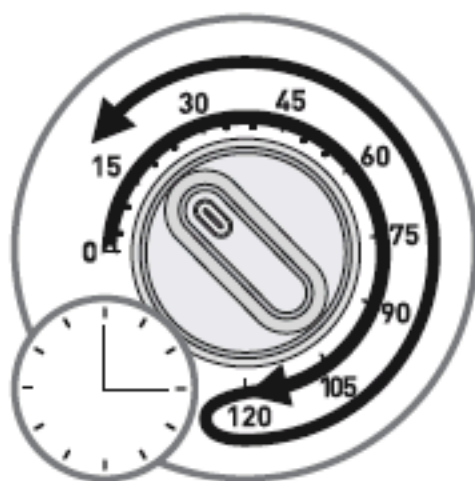
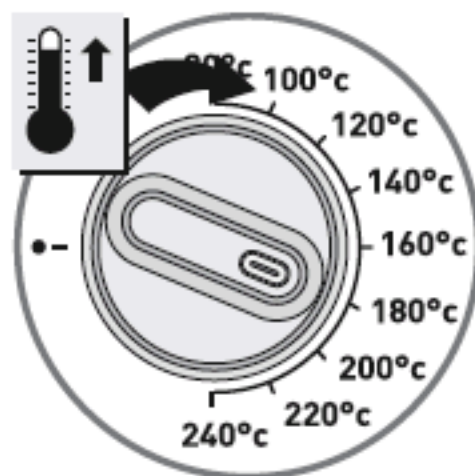
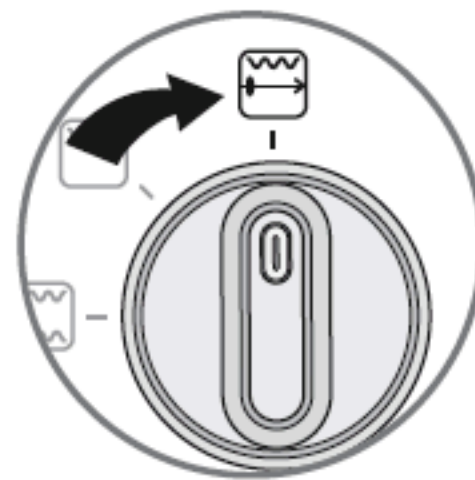
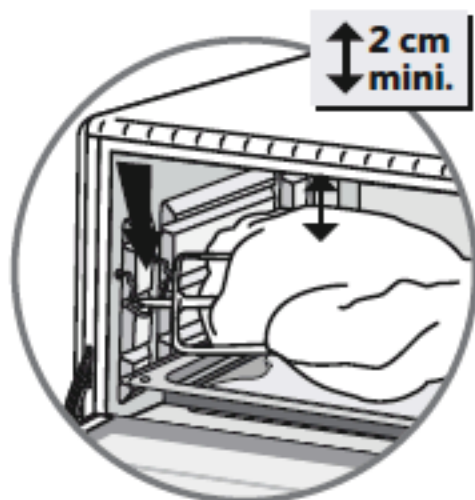
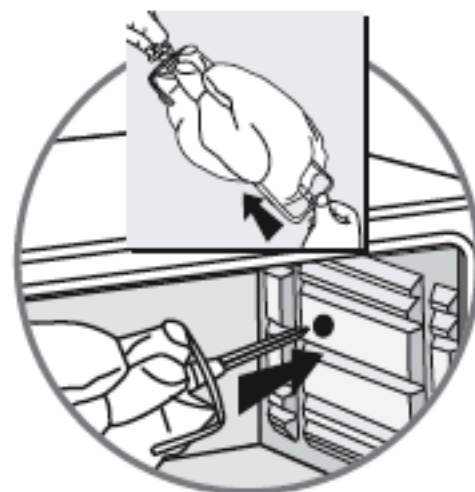
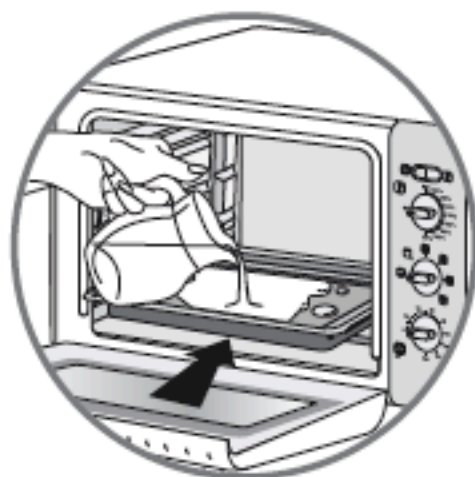
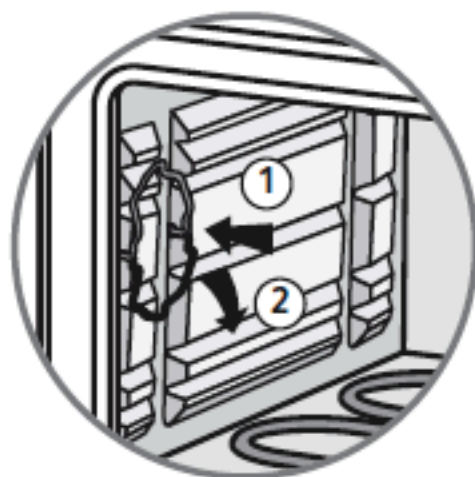

 Tournebroche\* - Draaispit\* - Drehspieß\*





 Chaleur tournante\* - Heteluchtoven\* - Umluft\*

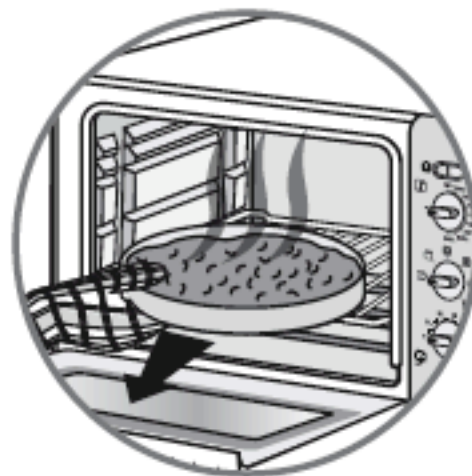
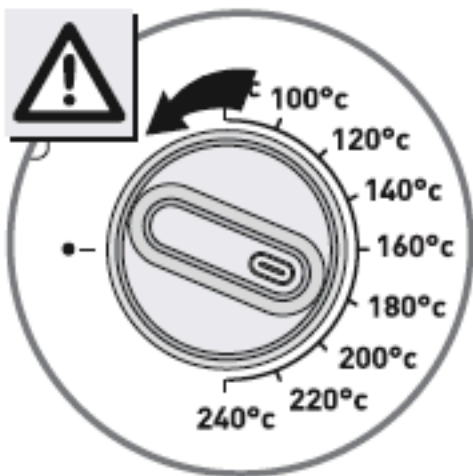
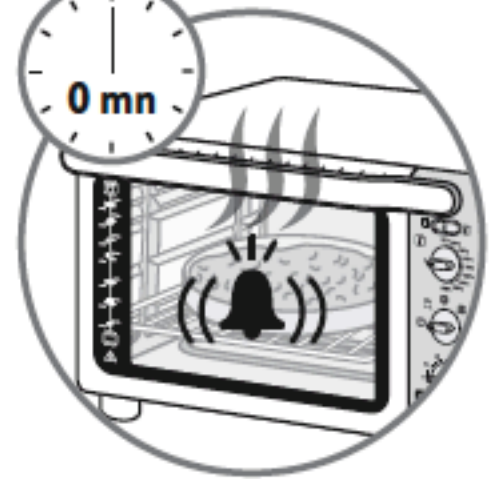
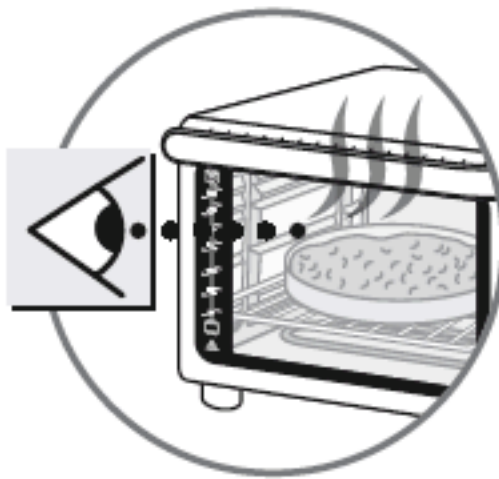
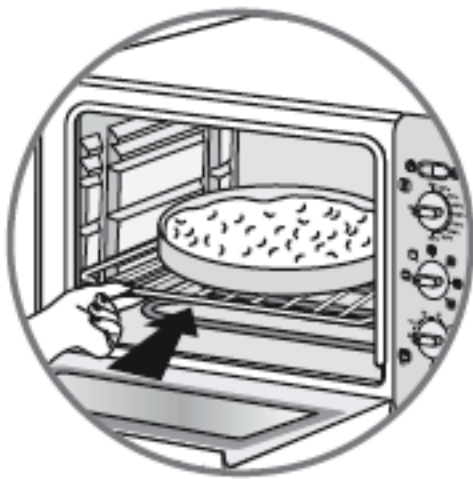
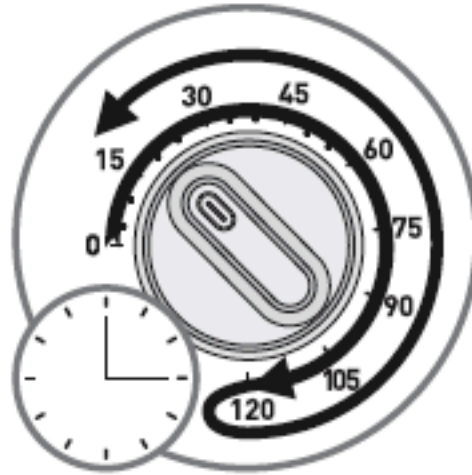
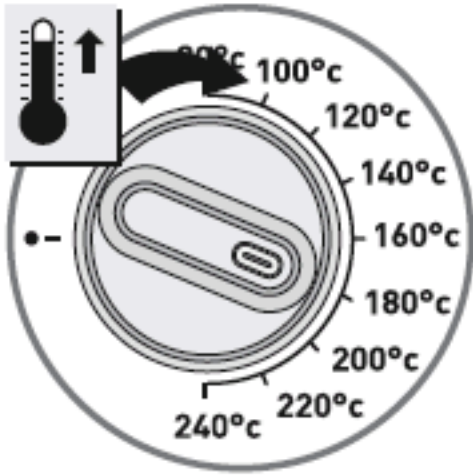
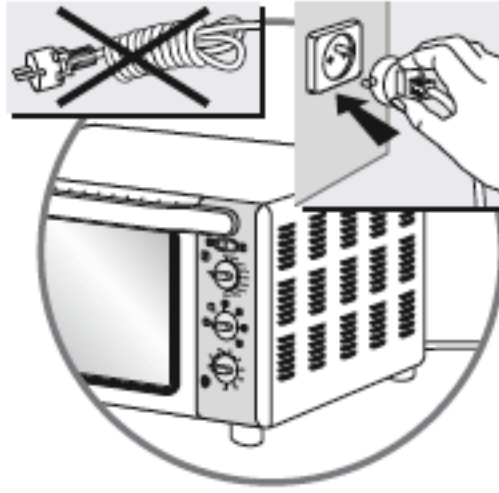

\* Selon modèle - Afhankelijk van het model - Je nach Modell

 Pâtisserie\* - Patisserie\* - Backwaren\*

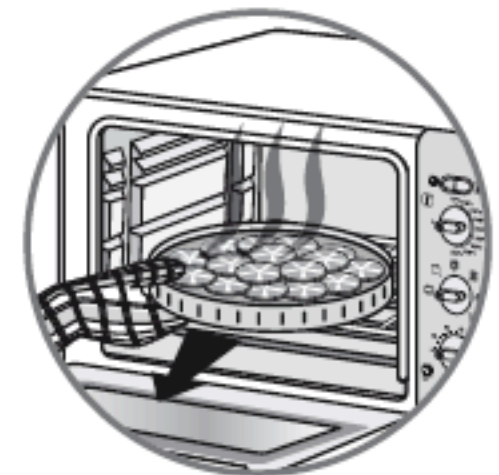
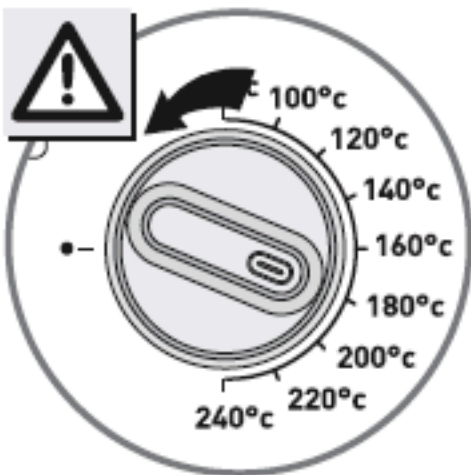
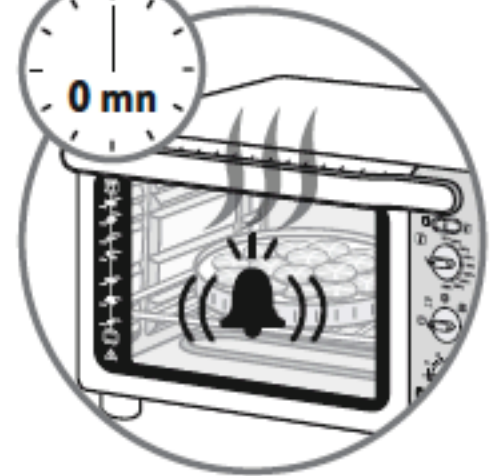
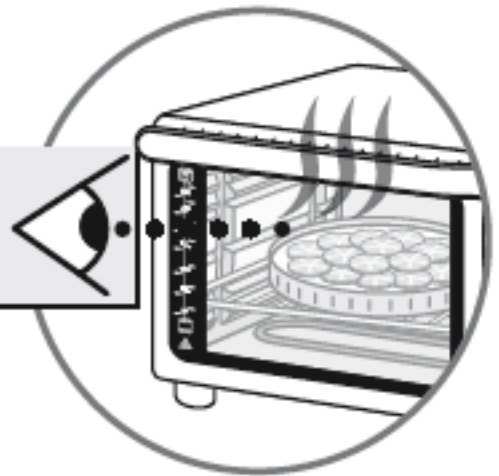
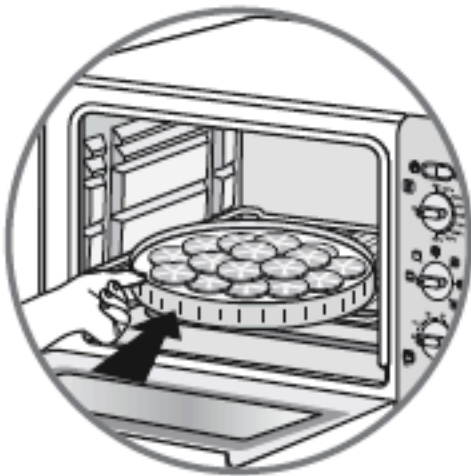
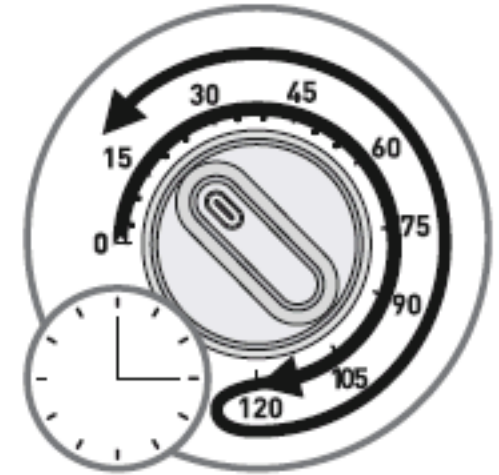
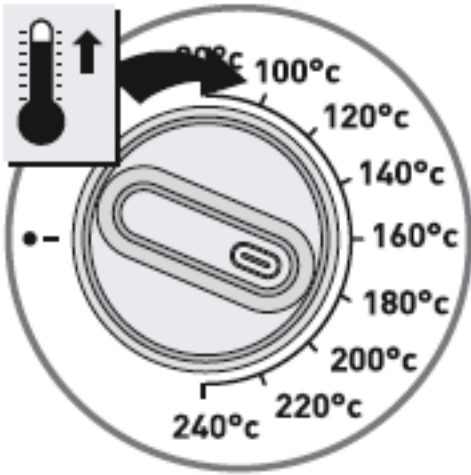
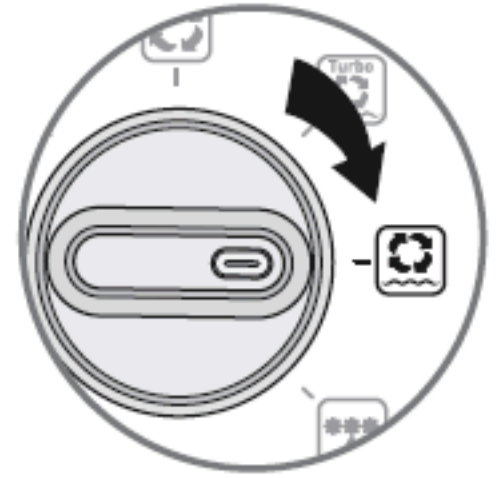
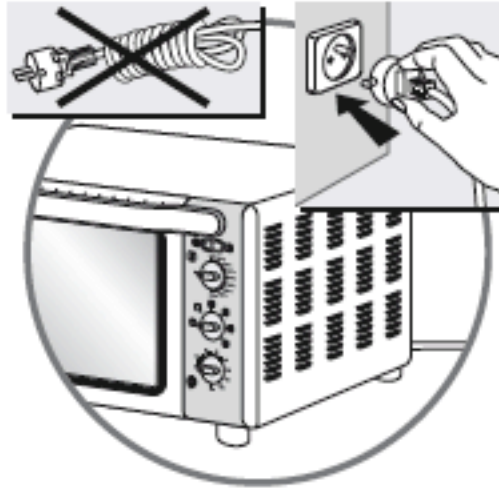
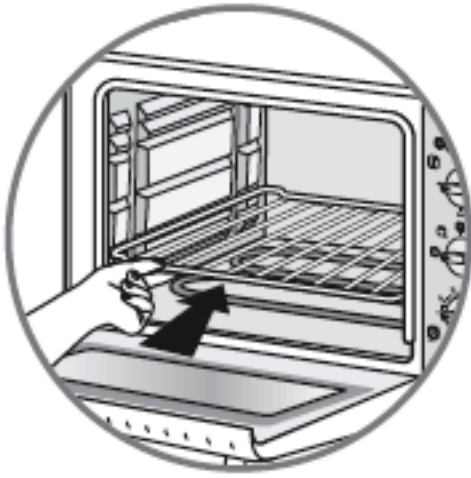



 Turbo\* -Umluftfunktion

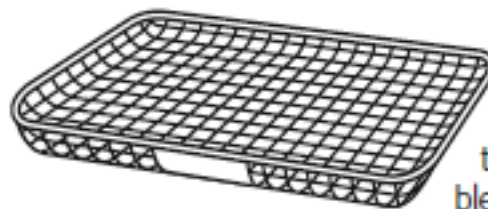
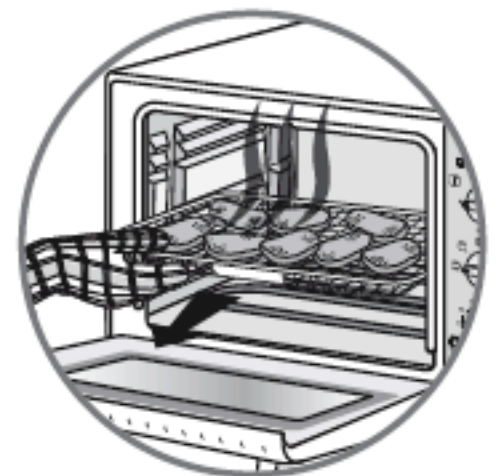
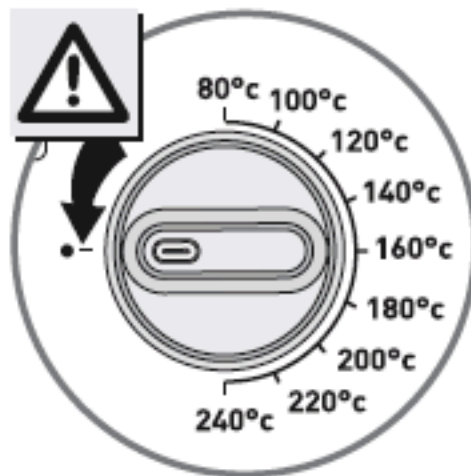
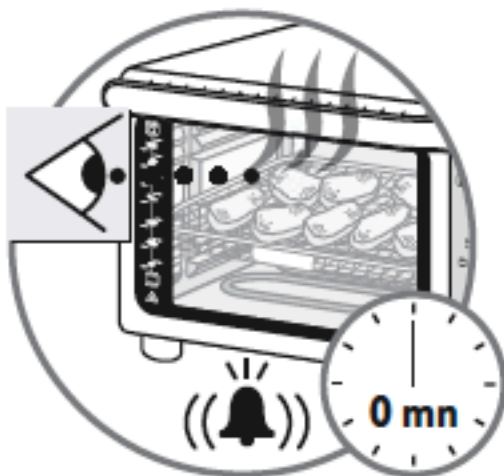
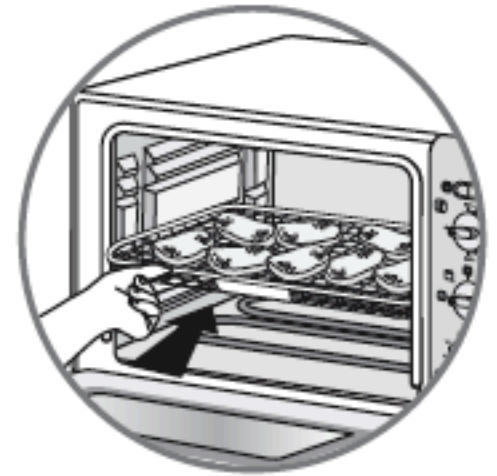
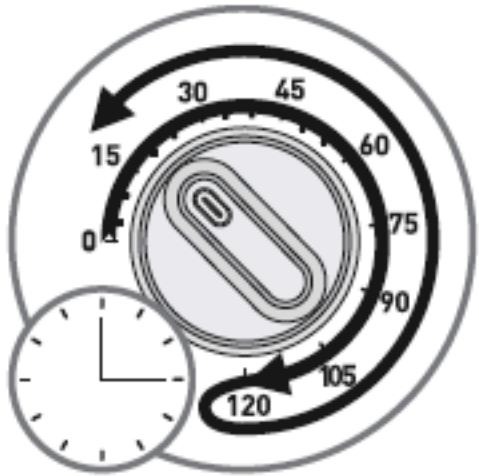
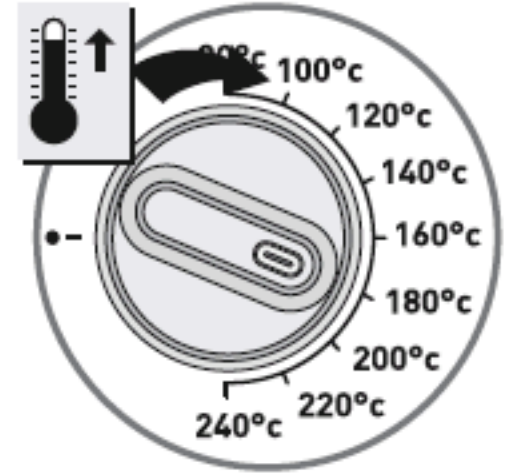
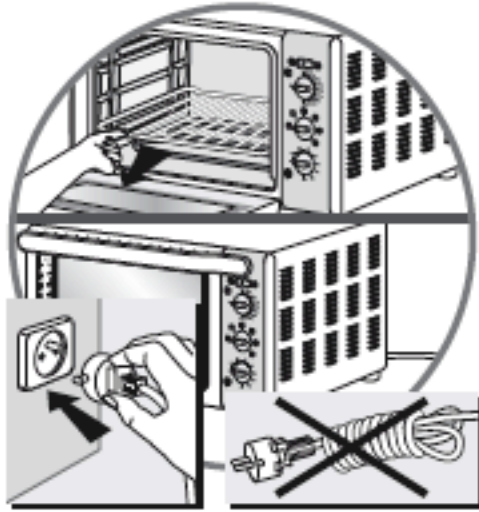

**Le panier micro-maillé\***

permet de cuire avec une diffusion optimale de la chaleur en conservant tout leur croustillant : nuggets, cordons bleus, frites précuites, etc.

**Fijnmazige ovenschaal\*** Hiermee kunt u nuggets en dergelijke ovensnacks, voorgebakken ovenfrites enz. bakken. Hij zorgt voor optimale warmteverdeling terwijl het product lekker krokant blijft.  
**Gitterschale\*** Sie ermöglicht das Garen von Nuggets, Cordons bleus, vorfrittierten Pommes frites usw. für knusprige und gleichmäßige Garergebnisse.

\* Selon modèle - Afhankelijk van het model - Je nach Modell

 Décongélation\* - Ontdooien\* - Auftauen\*

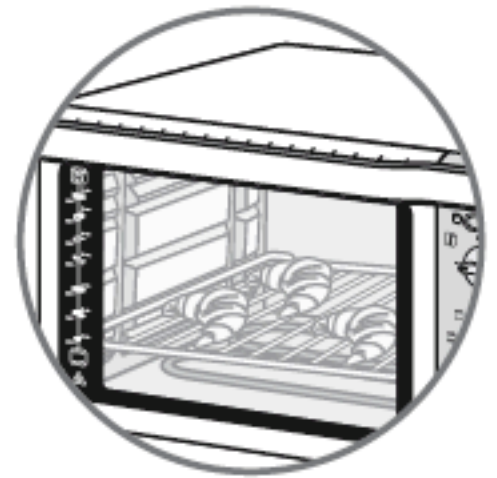
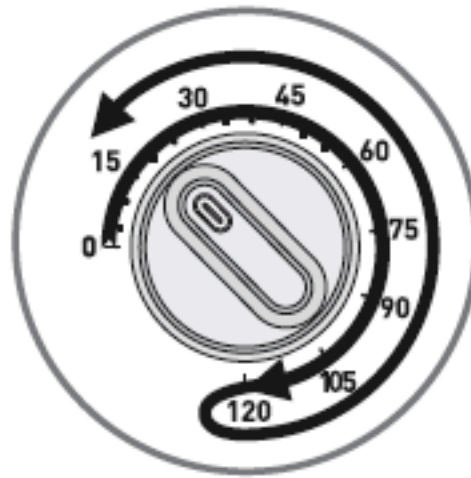
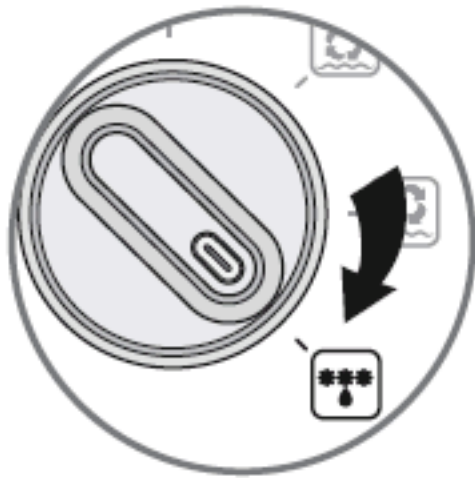
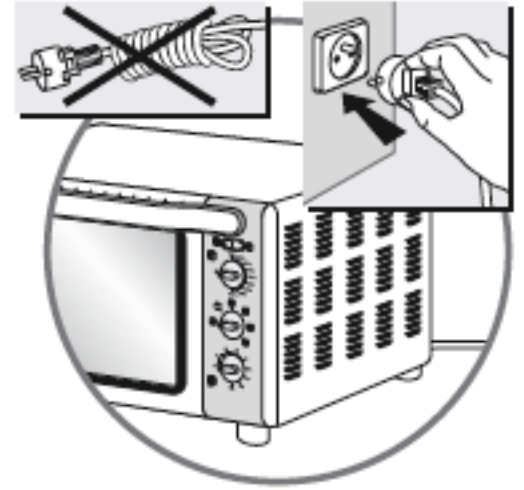
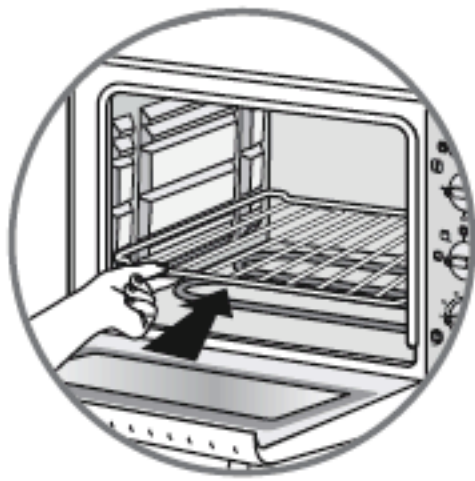



## 5. Conseils de nettoyage - Reinigingsvoorschriften - Reinigungshinweise

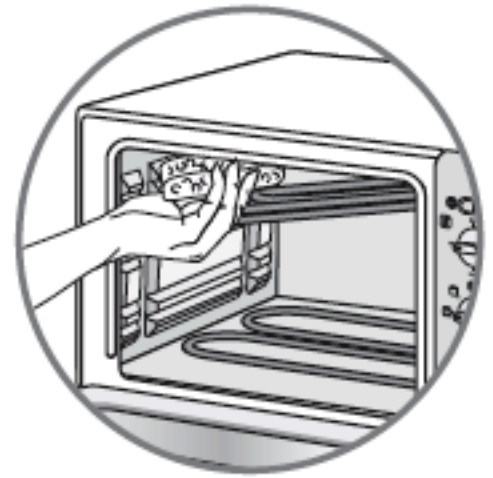
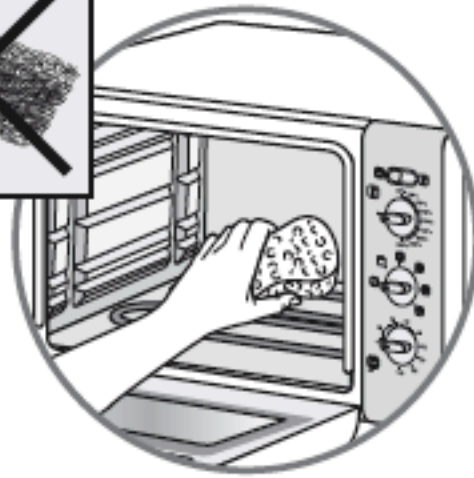
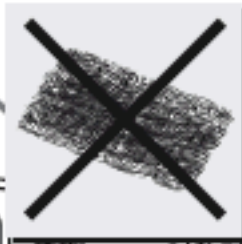
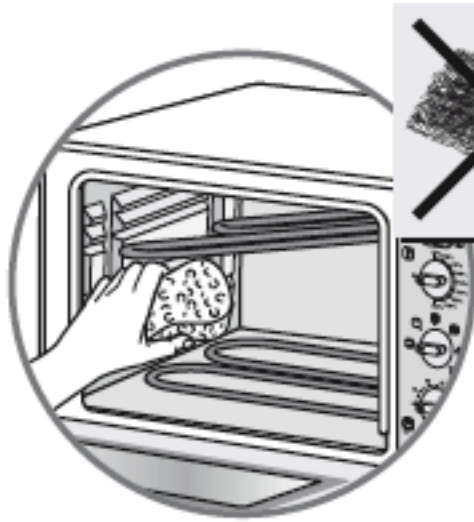



CleanTech

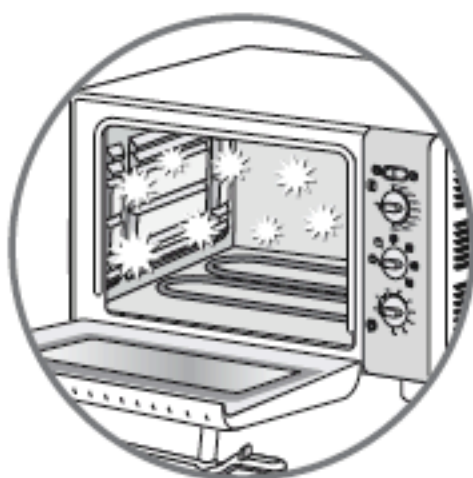
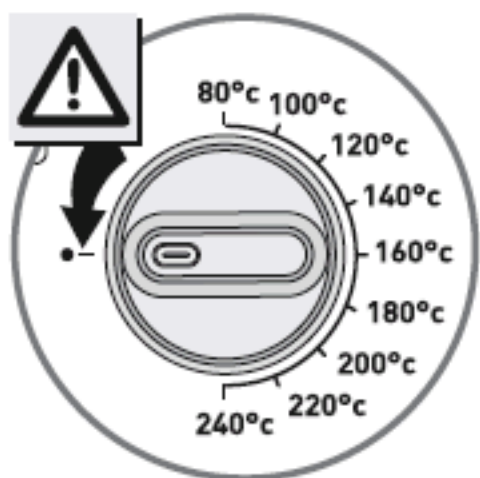
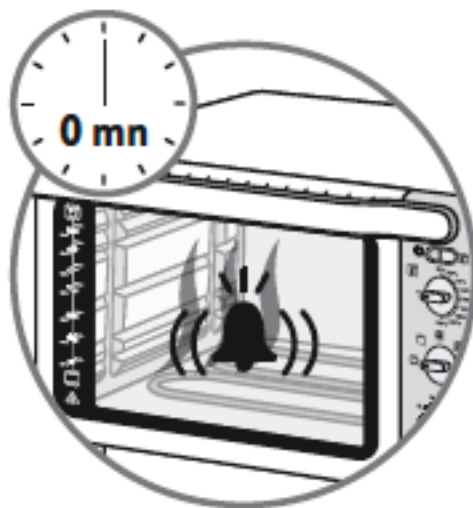
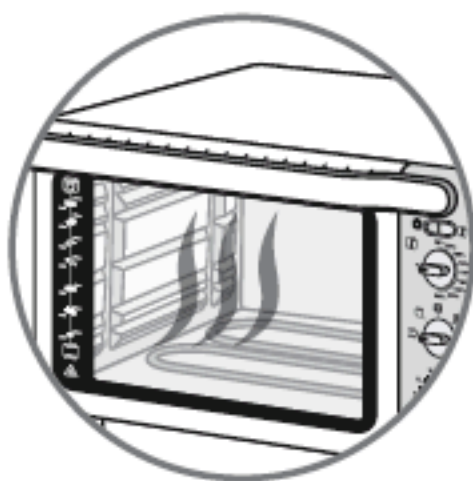
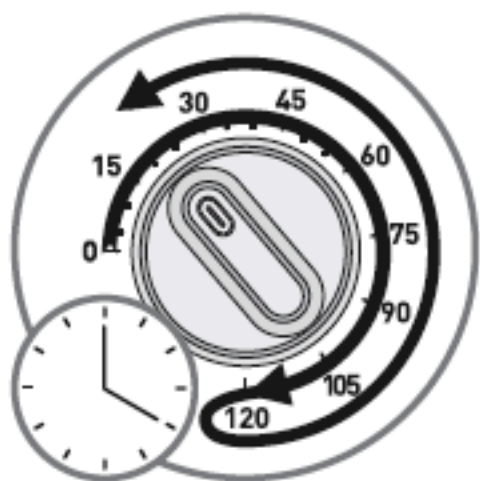
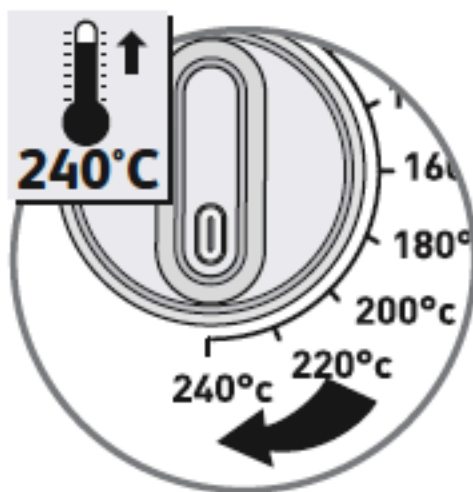
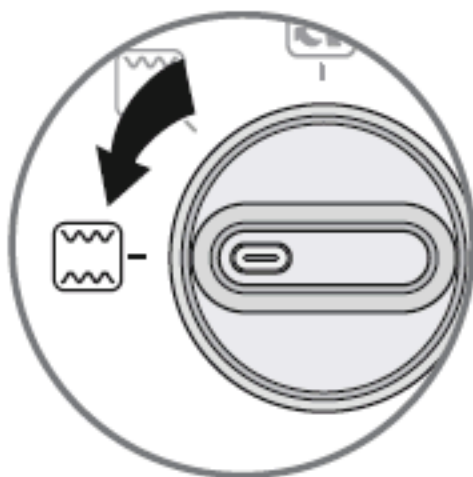
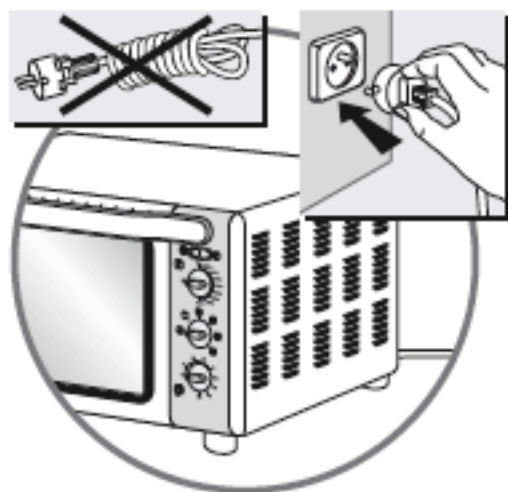
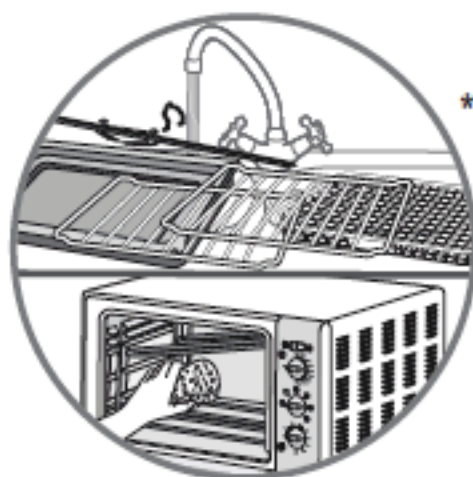
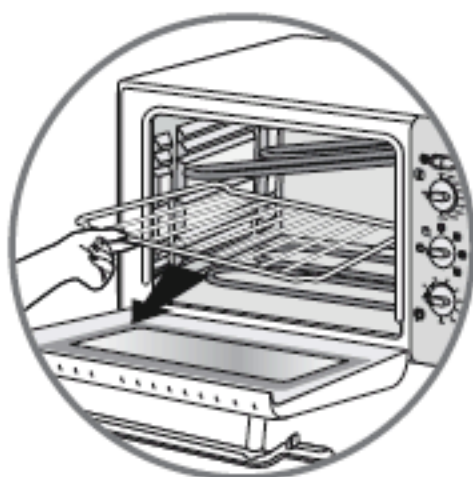
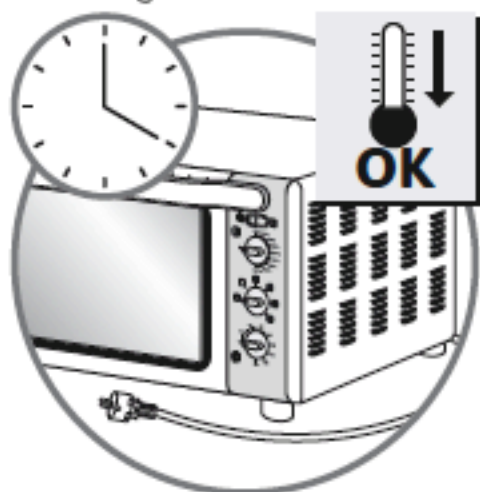





# Démontage de la vitre intérieure - Deurtje vervangen - Entfernung der Tür

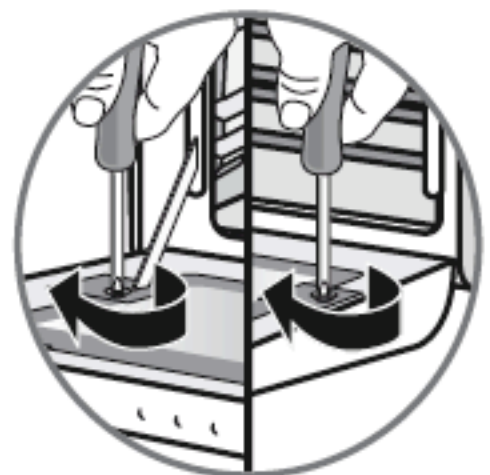
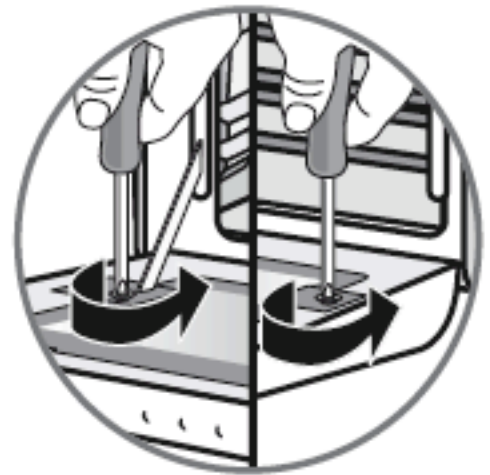
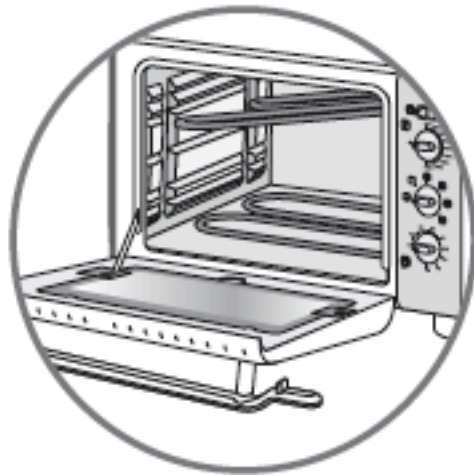
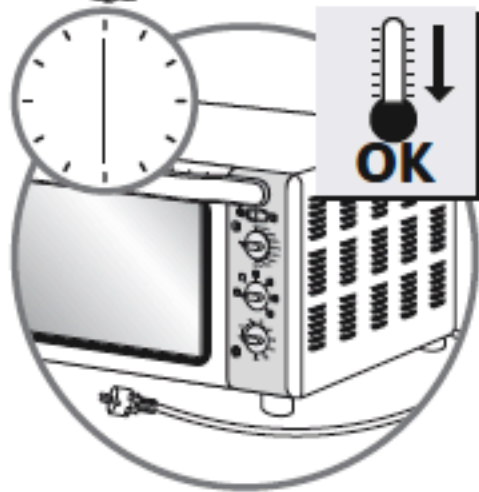









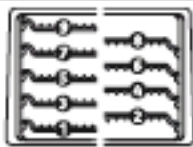











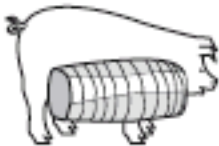



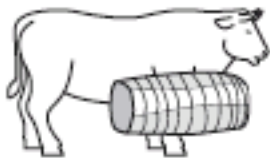









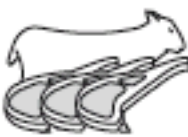
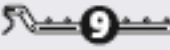

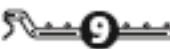

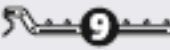
## 6. Guide de cuisson - Bereidingsgids - Garzeitentabelle

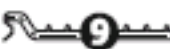











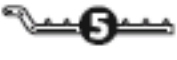







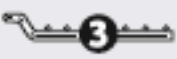

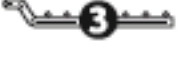

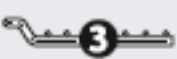



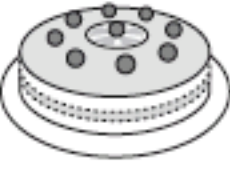





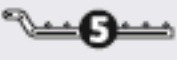



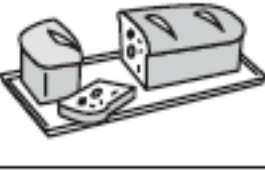

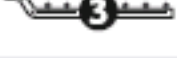

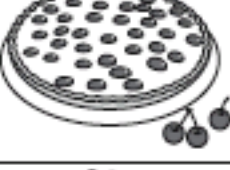

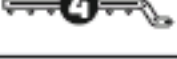













- Les temps indiqués peuvent varier en fonction du poids, de la taille ou de l'épaisseur ainsi que de la température initiale des aliments. Ils pourront être augmentés ou diminués en fonction du goût de chacun. Les températures indiquées dans le tableau ci-dessous sont données à titre indicatif.
- De aangegeven tijden kunnen variëren al naar gelang het gewicht, de hoeveelheid, de dikte of de temperatuur van de voedingswaren. U kunt naar eigen wens kortere of langere tijden aanhouden. De temperaturen die op de oven vermeld staan zijn richtwaarden.
- Die angegebenen Zeiten können je nach Gewicht, Größe oder Dicke sowie je nach ursprünglicher Temperatur der Nahrungsmittel von den empfohlenen Angaben abweichen. Sie können je nach Geschmack erhöht oder reduziert werden. Bei den an Ihrem Backofen angegebenen Temperaturen handelt es sich um Richtwerte.

Tableau de cuisson - Baktijd - Garzeiten

							
	225 g x 2	OF2731 Grill			210°C	10 min.	25 min.
		OF2758 Turbo			230°C	10 min.	20 min.
	1,3 Kg	OF2731 Grill			240°C	-	65 min.
	1,6 Kg	OF2758 Turbo			230°C	-	65 min.
		OF2731 Grill			220°C	-	80 min.
	1,05 Kg	OF2758 Turbo			230°C	-	75 min.
	1 Kg	OF2731 Grill			220°C	-	40 min.
	1,08 Kg	OF2758 Turbo			220°C	-	40 min.
	760 g	OF2731 Grill			220°C	-	65 min.
	950 g	OF2758 Turbo			220°C	-	65 min.
		OF2731 Grill			240°C	-	11+5 min.
		OF2758 Turbo			240°C	-	11+5 min.
	1 Kg	OF2731 Grill			240°C	-	13+5 min.
	1,08 Kg	OF2758 Turbo			240°C	-	13+5 min.
		OF2731 Grill			205°C	10 min.	10 min.
		OF2758 Turbo			200°C	10 min.	10 min.



	OF2731 Grill			215°C	15 min.	20 min.
	OF2758 Turbo			230°C	10 min.	18 min.
	OF2731 Grill			200°C	-	45 min.
	OF2758 Turbo			200°C	-	50 min.
	OF2731 Grill			200°C	-	55 min.
	OF2758 Turbo			200°C	-	50 min.
	OF2731 Grill			200°C	10 min.	40 min.
	OF2758 Turbo			200°C	10 min.	50 min.
	OF2731 Grill			180°C	10 min.	25 min.
	OF2758 Turbo			200°C	10 min.	23 min.
	OF2731 Grill			220°C	10 min.	25 min.
	OF2758 Turbo			220°C	10 min.	30 min.
	OF2731 Grill			180°C	10 min.	50 min.
	OF2758 Turbo			200°C	10 min.	50 min.
	OF2731 Grill			200°C	10 min.	35 min.
	OF2758 Turbo			210°C	10 min.	45 min.
	OF2731 Grill			150°C	-	30 min.
	OF2758 Turbo			180°C	-	30 min.
	OF2731 Grill			180°C	10 min.	40 min.
	OF2758 Turbo			190°C	10 min.	45 min.
	OF2731 Grill			220°C	10 min.	20-25 min.
	OF2758 Turbo			220°C	10 min.	20-25 min.
	OF2731 Grill			220°C	10 min.	10-15 min.
	OF2758 Turbo			220°C	10 min.	8-12 min.