

m4000

FR

NL

DE

EN

ES

PT

IT

TH



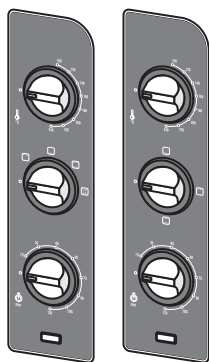
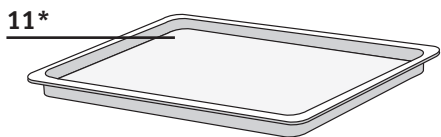
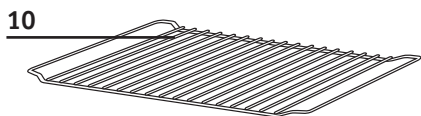
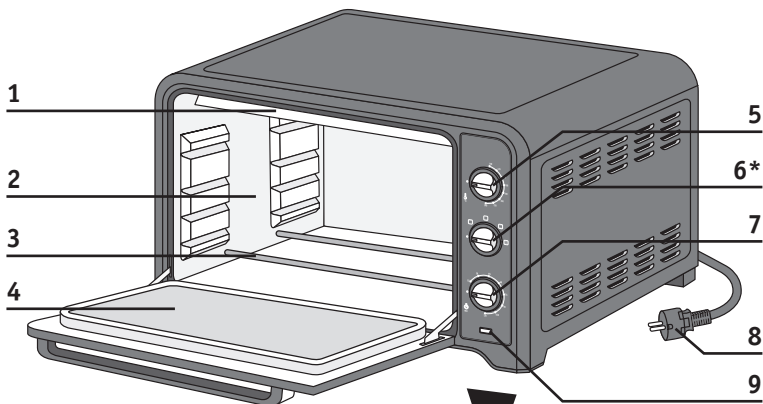

* selon modèle
afhankelijk van het model
je nach Modell
depending on the model
según el modelo
consoante o modelo
in base al modello
ขึ้นอยู่กับรุ่น

1 Description - Beschrijving - Beschreibung Descripción - Descrição - Descrizione - คำอธิบาย

- 1 Résistance supérieure
- 2 Parois aluminium
- 3 Résistance inférieure
- 4 Porte double parois
- 5 Bouton de réglage température
- 6 Bouton des fonctions
- 7 Bouton de minuterie
- 8 Cordon d'alimentation
- 9 Voyant de fonctionnement
- 10 Grille réversible
- 11 Plat lèche-frite*

- 1 Oberes Heizelement
- 2 Aluminiumwände
- 3 Unteres Heizelement
- 4 Doppelwandige Tür
- 5 Temperaturregler
- 6 Funktionsknopf
- 7 Timer-Knopf
- 8 Netzkabel
- 9 Betriebskontrollleuchte
- 10 Umkehrbarer Rost
- 11 Emaillierte Bratschale*

- 1 Resistencia superior
- 2 Paredes aluminio
- 3 Resistencia inferior
- 4 Puerta de doble cristal
- 5 Botón de ajuste de temperatura
- 6 Botón de funciones
- 7 Botón de temporizador
- 8 Cable de alimentación
- 9 Indicador de funcionamiento
- 10 Rejilla reversible
- 11 Bandeja*

- 1 Resistenza superiore
- 2 Pareti alluminio
- 3 Resistenza inferiore
- 4 Sportello a parete doppia
- 5 Bottone di regolazione della temperatura
- 6 Bottone di selezione delle funzioni
- 7 Bottone del timer
- 8 Cavo d'alimentazione
- 9 Spia di funzionamento
- 10 Griglia reversibile
- 11 Piatto leccarda*

- 1 Bovenste verwarmingselement
- 2 Aluminium wanden
- 3 Onderste verwarmingselement
- 4 Dubbelwandige deur
- 5 Regelbare thermostaatknop
- 6 Functieknop
- 7 Timerknop
- 8 Snoer
- 9 Aan/uit-controlelampje
- 10 Omkeerbaar rooster
- 11 Opvangbak voor vet*

- 1 Top heating element
- 2 Aluminium walls
- 3 Bottom heating element
- 4 Double-wall door
- 5 Temperature control button
- 6 Functions button
- 7 Timer button
- 8 Power cord
- 9 Power indicator light
- 10 Reversible shelf
- 11 Drip tray*

- 1 Resistência superior
- 2 Paredes alumínio
- 3 Resistência inferior
- 4 Porta de parede dupla
- 5 Botão deregulação da temperatura
- 6 Botão das funções
- 7 Botão temporizador
- 8 Cabo de alimentação
- 9 Luz piloto de funcionamento
- 10 Grelha reversível
- 11 Tabuleiro*

- 1 องค์ประกอบความร้อนข้างบน
- 2 ผนังอลูมิเนียม
- 3 องค์ประกอบความร้อนข้างล่าง
- 4 ประตูผนัง 2 ชั้น
- 5 ปุ่มควบคุมอุณหภูมิ
- 6 ปุ่มฟังก์ชันการใช้งาน
- 7 ปุ่มตั้งเวลา
- 8 สายไฟ
- 9 ไฟแสดงสถานะการใช้งาน
- 10 ชั้นวางของกลับได้
- 11 ถาดหยด*

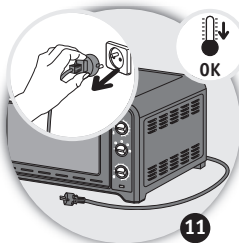
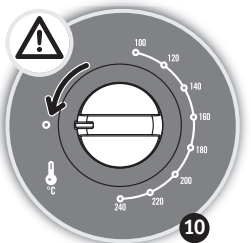
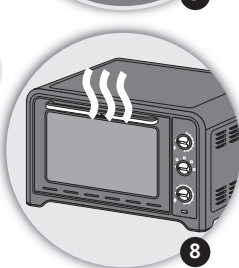
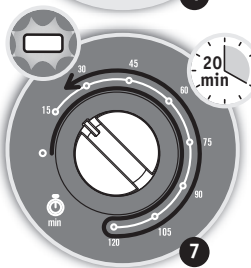
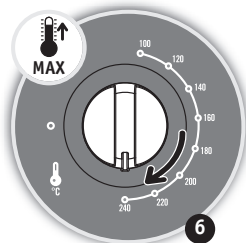
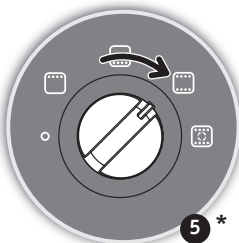
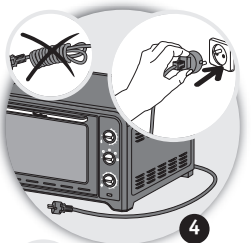
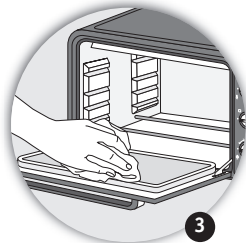
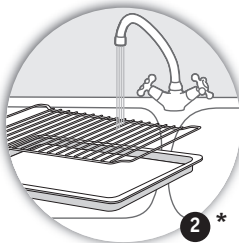
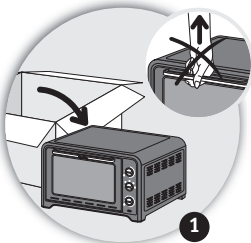

* selon modèle - afhankelijk van het model
je nach Modell - depending on the model
según el modelo - consoante o modelo
in base al modello - ขึ้นอยู่กับรุ่น

** Plat non fourni avec l'appareil
Schaal niet inclusief bij het apparaat
Platte nicht im Lieferumfang inbegriffen
The dish is not supplied with the appliance
El plato no es suministrado con el aparato
Travessa não fornecida com o aparelho
Il piatto non è fornito con l'apparecchio
จานไม่ได้มาพร้อมกับเครื่อง

3

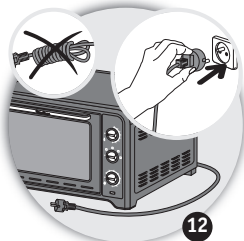

12

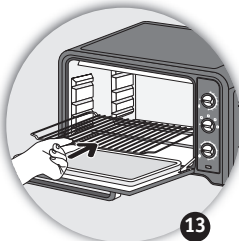

13

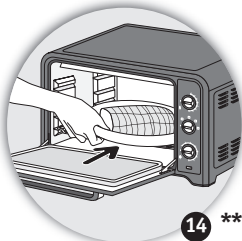

14 **

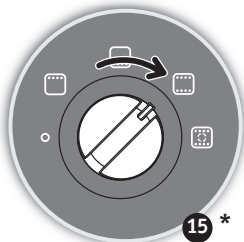

15 *

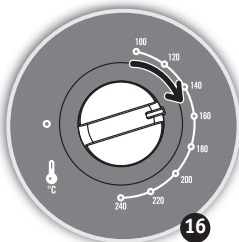

16

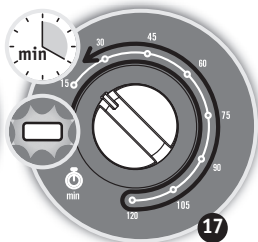

17

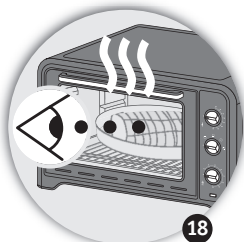

18

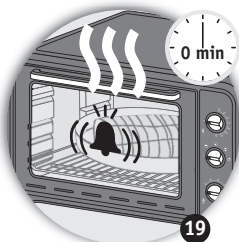

19

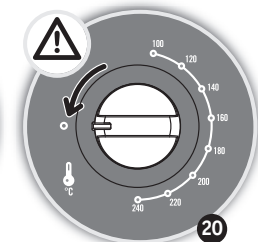

20

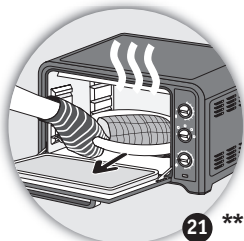

21 **

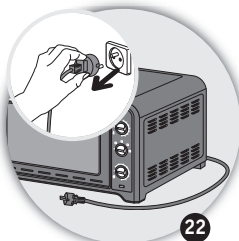

22

* selon modèle - afhankelijk van het model
je nach Modell - depending on the model
según el modelo - consoante o modelo
in base al modello - ขึ้นอยู่กับรุ่น

** Plat non fourni avec l'appareil
Schaal niet inclusief bij het apparaat
Platte nicht im Lieferumfang inbegriffen
The dish is not supplied with the appliance
El plato no es suministrado con el aparato
Travessa não fornecida com o aparelho
Il piatto non è fornito con l'apparecchio
จานไม้ได้มาพร้อมกับเครื่อง

4

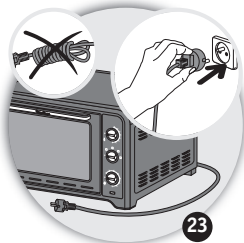

23

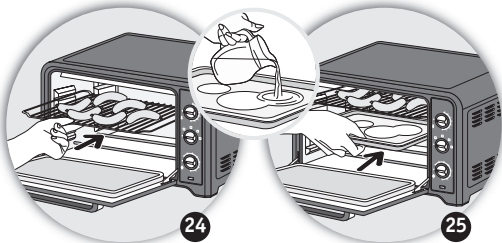

24

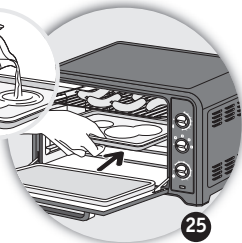

25

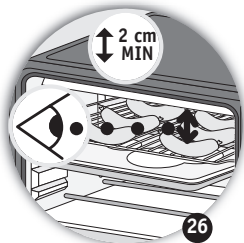

26

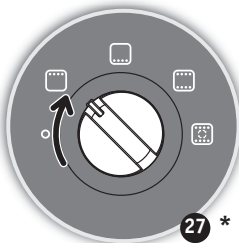

27 *

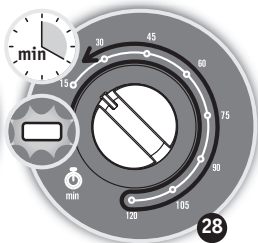

28

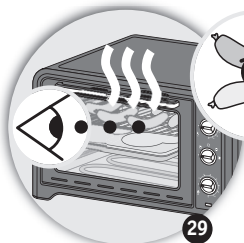

29

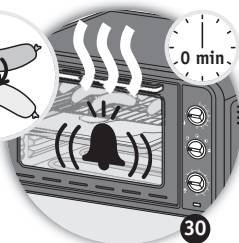

30

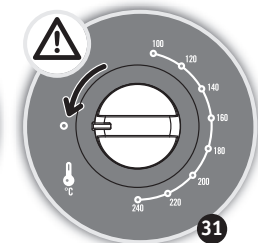

31

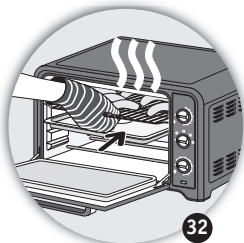

32

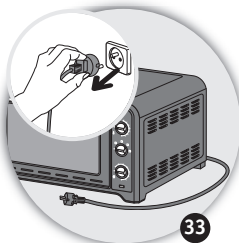

33

5  *

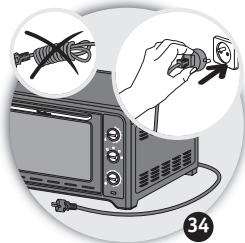

34

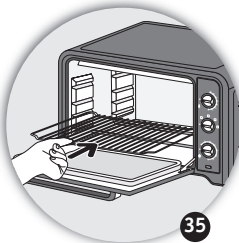

35

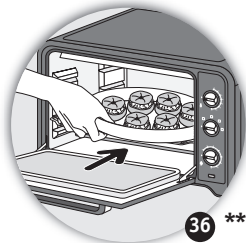

36 **

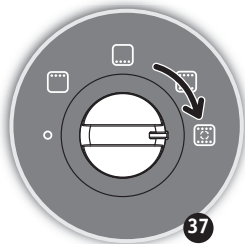

37

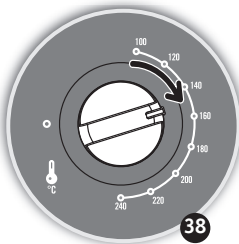

38

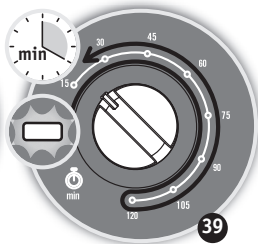

39

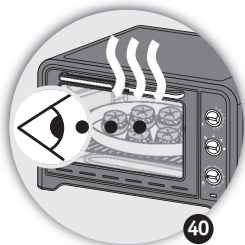

40

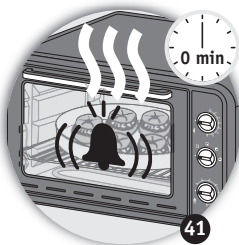

41

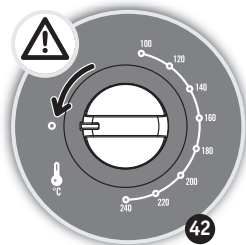

42

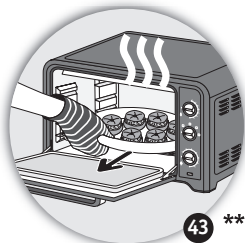

43 **

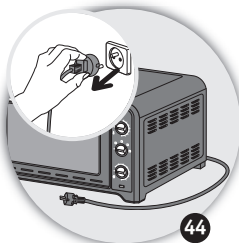

44

* selon modèle - afhankelijk van het model
je nach Modell - depending on the model
según el modelo - consoante o modelo
in base al modello - ขึ้นอยู่กับรุ่น

** Plat non fourni avec l'appareil
Schaal niet inclusief bij het apparaat
Platte nicht im Lieferumfang inbegriffen
The dish is not supplied with the appliance
El plato no es suministrado con el aparato
Travessa não fornecida com o aparelho
Il piatto non è fornito con l'apparecchio
จานไม่ได้มาพร้อมกับเครื่อง

6

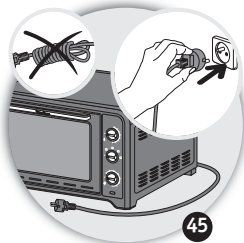

45

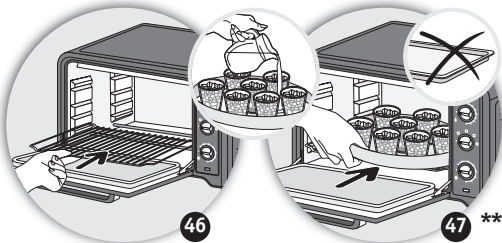

46

47 **

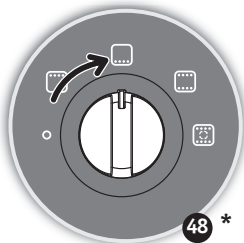

48 *

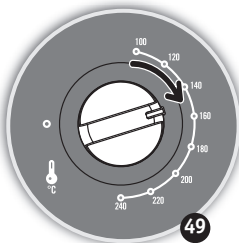

49

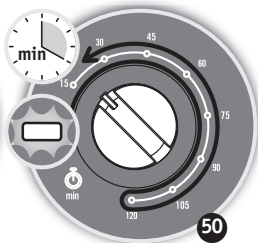

50

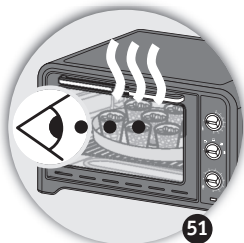

51

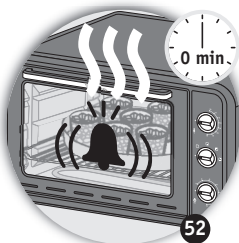

52

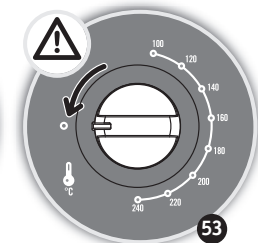

53

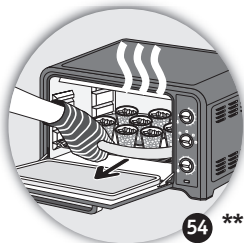

54 **

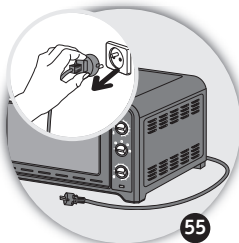

55

* selon modèle - afhankelijk van het model
je nach Modell - depending on the model
según el modelo - consoante o modelo
in base al modello - ขึ้นอยู่กับรุ่น

** Plat niet fourni avec l'appareil
Schaal niet inclusief bij het apparaat
Platte nicht im Lieferumfang inbegriffen
The dish is not supplied with the appliance
El plato no es suministrado con el aparato
Travessa não fornecida com o aparelho
Il piatto non è fornito con l'apparecchio
จานไม่ได้มาพร้อมกับเครื่อง



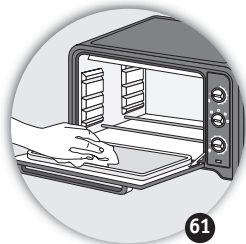
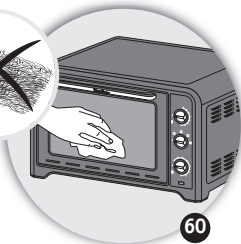
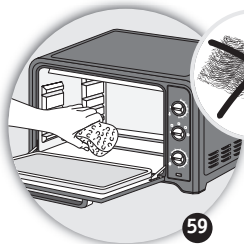
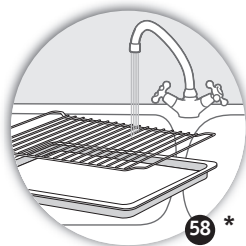
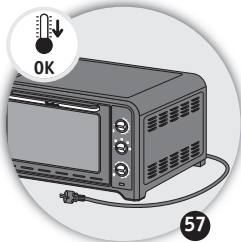
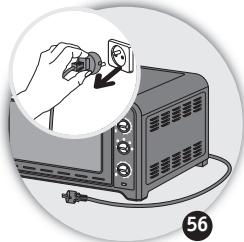

























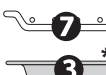





















7



* selon modèle - afhankelijk van het model - je nach Modell - depending on the model - según el modelo - consoante o modelo - in base al modello - ផ្អែកលើគំរូ

8



						
	x 4			10 min	240	20
	1,5 Kg			10 min	230	60
	750 gr			10 min	240	25
	1 Kg			---	230	80
	x 4			---	240	22 
	x 8			---	240	15 
	350 gr			10 min	210	15
				10 min	240	45
	650 gr			10 min	240	16
				---	240	28
				10 min	200	45
				10 min	200	20
				---	135	53
				10 min	230	55
				10 min	240	25

* selon modèle - afhankelijk van het model - je nach Modell - depending on the model - según el modelo - consoante o modelo - in base al modello - ផ្អែកលើគំរូ

9

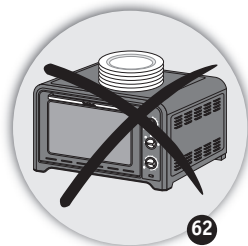

62

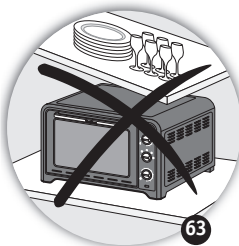

63



64



65



66

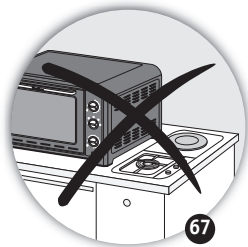

67

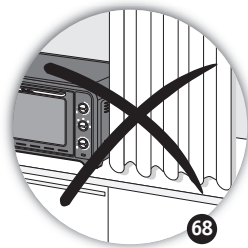

68

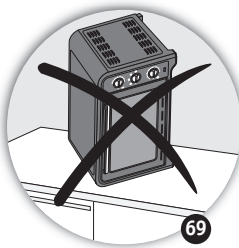

69

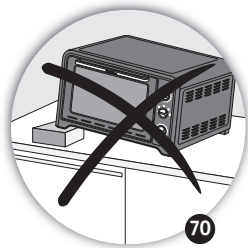

70



71

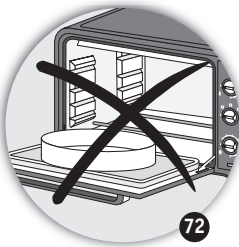





72







73

GUARANTEE COUNTRY LIST

			
ARGENTINA	0800-122-2732	2 años 2 years	GRUPE SEB ARGENTINA S.A. Billinghurst 1833 3° C1425DTK Capital Federal Buenos Aires
ՀԱՅԱՍՏԱՆ ARMENIA	010 55-76-07	2 տարի 2 years	ՓԲԸ «ՀԳՈՒՊՊԱ ՍԵԲ» 125171, ՄՈՍԿՎԱ, ԼԵՆԻՆՎՈՐԴՍԿԱՆ ԽՆՃՈՒՂԻ, 16A, ՇԻՆ.3
AUSTRALIA	1300307824	1 year	GRUPE SEB AUSTRALIA PO Box 7535, Silverwater NSW 2128
ÖSTERREICH AUSTRIA	01 890 3476	2 Jahre 2 years	SEB ÖSTERREICH GmbH Campus 21 - Businesspark Wien Süd, Liebermannstr. A02 702 2345 Brunn am Gebirge
البحرين BAHRAIN	17716666	1 year	www.tefal-me.com
БЕЛАРУСЬ BELARUS	017 2239290	2 года 2 years	ЗАО «Группа СЕБ-Восток», 125171, Москва, Ленинградское шоссе, д. 16А, стр. 3
BELGIQUE BELGIE BELGIUM	070 23 31 59	2 ans 2 jaar 2 years	GRUPE SEB BELGIUM SA NV 25 avenue de l'Espérance - ZI 6220 Fleurus
BOSNA I HERCEGOVINA	Info-linija za potrošače 033 551 220	2 godine 2 years	SEB Developpement Predstavništvo u BiH Vrazova 8/II 71000 Sarajevo
BRASIL BRAZIL	11 2915-4400	1 ano 1 year	SEB COMERCIAL DE PRODUTOS DOMÉSTICOS LTDA Rua Venâncio Aires, 433, Pompéia, São Paulo/SP
БЪЛГАРИЯ BULGARIA	0700 10 330	2 години 2 years	ГРУП СЕБ БЪЛГАРИЯ ЕООД бул. България 81 В, ет. 5 1404 София
CANADA	1-800-418-3325	1 an 1 year	GRUPE SEB CANADA 345 Passmore Avenue Toronto, ON M1V 3N8
CHILE	12300 209207	2 años 2 years	GRUPE SEB CHILE Comercial Ltda Av. Providencia, 2331, piso 5, oficina 501 Santiago
COLOMBIA	018000520022	2 años 2 years	GRUPE SEB COLOMBIA Apartado Aereo 172, Kilometro 1 Via Zipaquira Cajica Cundinamarca
HRVATSKA CROATIA	01 30 15 294	2 godine 2 years	SEB mku & p d.o.o. Vodnjanska 26, 10000 Zagreb
ČESKÁ REPUBLIKA CZECH REPUBLIC	731 010 111	2 roky 2 years	Groupe SEB ČR s.r.o. Futurama Business Park (budova A) Sokolovská 651/136a 186 00 Praha 8
DANMARK DENMARK	44 663 155	2 år 2 years	GRUPE SEB NORDIC AS Tempovej 27 2750 Ballerup
مصر EGYPT	16622	سنة واحدة 1year	جروب سب ايجيبت القاهرة: ١٢١ شارع الحجاز، مصر الجديدة الإسكندرية: طريق أمبايو، سموحة

			
EESTI ESTONIA	668 1286	2 aastat 2 years	GRUPE SEB POLSKA Sp. z o.o. ul. Bukowińska 22b 02-703 Warszawa
SUOMI FINLAND	09 622 94 20	2 Vuotta 2 years	Groupe SEB Finland Kutojantie 7 02630 Espoo
France Continentale + Guadeloupe, Martinique, Réunion, Saint-Martin	09 74 50 47 74	1 an 1 year	GRUPE SEB France Service Consommateur Tefal 112 Ch. Moulin Carron, TSA 92002 69134 ECULLY Cedex
DEUTSCHLAND GERMANY	0212 387 400	2 Jahre 2 years	GRUPE SEB DEUTSCHLAND GmbH / KRUPS GmbH Theodor-Stern-Kai 1 60486 Frankfurt am Main
ELLADA GREECE	2106371251	2 χρόνια 2 years	SEB GROUPE ΕΛΛΑΔΟΣ Α.Ε. Οδός Καβαλιεράτου 7 Τ.Κ. 145 64 Κ. Κηφισιά
香港 HONG KONG	8130 8998	1 year	SEB ASIA Ltd. Room 903, 9/F, South Block, Skyway House 3 Sham Mong Road, Tai Kok Tsui, Kowloon Hong-Kong
MAGYARORSZÁG HUNGARY	06 1 801 8434	2 év 2 years	GRUPE SEB CENTRAL-EUROPE Kft. Táviró köz 4 2040 Budaörs
INDONESIA	+62 21 5793 7007	1 year	GRUPE SEB INDONESIA (Representative office) Sudirman Plaza, Plaza Marein 8th Floor JL Jendral Sudirman Kav 76-78, Jakarta 12910, Indonesia
ITALIA ITALY	1 99 207 354	2 anni 2 years	GRUPE SEB ITALIA S.p.A. Via Montefeltro, 4 20156 Milano
日本 JAPAN	0570-077772	1 year	株式会社グループセブジャパン 〒144-0042 東京都大田区羽田旭町11-1 羽田クロノゲート事務棟5F
الأردن JORDAN	5665505	1 year	www.tefal-me.com
ҚАЗАҚСТАН KAZAKHSTAN	727 378 39 39	2 жыл 2 years	ЖАҚ «Группа СЕБ- Восток» 125171, Мәскеу, Ленинградское шоссесі, 16А, 3 үйі
한국어 KOREA	1588-1588	1 year	(유)그룹 세브 코리아 서울시 종로구 청계천로 35 관정빌딩 2층 110- 790
الكويت KUWAIT	24831000	1 year	www.tefal-me.com
LATVIJA LATVIA	6 616 3403	2 gadi 2 years	GRUPE SEB POLSKA Sp. z o.o. ul. Bukowińska 22b, 02-703 Warszawa
لبنان LEBANON	4414727	1 year	www.tefal-me.com
LIETUVA LITHUANIA	5 214 0057	2 metai 2 years	GRUPE SEB POLSKA Sp. z o.o. ul. Bukowińska 22b, 02-703 Warszawa
LUXEMBOURG	0032 70 23 31 59	2 ans 2 years	GRUPE SEB BELGIUM SA NV 25 avenue de l'Espérance - ZI 6220 Fleurus

МАКЕДОНИЈА MACEDONIA	(02) 20 50 319	2 години 2 years	Groupe SEB Bulgaria EOOD Office 1, floor 1, 52G Borovo St., 1680 Sofia - Bulgaria ГРУП СЕБ БЪЛГАРИЯ ДООЕЛ Ул. Борово 52 Г, сп. 1, офис 1, 1680 София, България
MALAYSIA	603 7802 3000	1 year	GROUPE SEB MALAYSIA SDN. BHD Unit No. 402-403, Level 4, Uptown 2, No. 2, Jalan SS21/37, Damansara Uptown, 47400, Petaling Jaya, Selangor D.E Malaysia
MEXICO	(01800) 112 8325	1 año 1 year	Groupe.S.E.B. México, S.A. DE C.V. Goldsmith 38 Desp. 401, Col. Polanco Delegación Miguel Hidalgo 11 560 México D.F.
MOLDOVA	22 929249	2 роки 2 years	ТОВ «Груп СЕБ Україна» 02121, Харківське шосе, 201-203, 3 поверх, Київ, Україна
NEDERLAND The Netherlands	0318 58 24 24	2 jaar 2 years	GROUPE SEB NEDERLAND B.V. De Schutterij 27 3905 PK Veenendaal
NEW ZEALAND	0800 700 711	1 year	GROUPE SEB NEW ZEALAND PO Box 17 – 298, Greenlane, 1546 Auckland New Zealand
NORGE NORWAY	815 09 567	2 år 2 years	GROUPE SEB NORDIC AS Tempovej 27 2750 Ballerup
عمان سلطنة OMAN	24703471	1 year	www.tefal-me.com
POLSKA POLAND	801 300 420 koszt jak za połączenie lokalne	2 lata 2 years	GROUPE SEB POLSKA Sp. z o.o. ul. Bukowińska 22b 02-703 Warszawa
PORTUGAL	808 284 735	2 anos 2 years	GROUPE SEB IBÉRICA SA Urb. da Matinha Rua Projectada à Rua 3 Bloco1 - 3º B/D 1950 - 327 Lisboa
قطر QATAR	44485555	1 year	www.tefal-me.com
REPUBLIC OF IRELAND	01 677 4003	1 year	GROUPE SEB IRELAND Unit B3 Aerodrome Business Park, College Road, Rathcoole, Co. Dublin
ROMANIA	0 21 316 87 84	2 ani 2 years	GROUPE SEB ROMÂNIA Str. Daniel Constantin nr. 8 010632 București
РОССИЯ RUSSIA	495 213 32 30	2 года 2 years	ЗАО «Группа СЕБ-Восток», 125171, Москва, Ленинградское шоссе, д. 16А, стр. 3
السعودية العربية المملكة SAUDI ARABIA	920023701	1 year	www.tefal-me.com
SRBIJA SERBIA	060 0 732 000	2 godine 2 years	SEB Developpement Đorđa Stanojevića 11b 11070 Novi Beograd
			

SINGAPORE	6550 8900	1 year	GROUPE SEB SINGAPORE Pty Ltd. 59 Jalan Pemimpin, #04-01/02 L&Y Building Singapore 577218
SLOVENSKO SLOVAKIA	232 199 930	2 roky 2 years	GROUPE SEB Slovensko, spol. s r.o. Cesta na Senec 2/A 821 04 Bratislava
SLOVENIJA SLOVENIA	02 234 94 90	2 leti 2 years	SEB d.o.o. Gregorčičeva ulica 6 2000 MARIBOR
SOUTH AFRICA	0100202222	1 year	GS South Africa Building 17, PO BOX 107 The Woodlands Office Park, 20 Woodlands Drive, Woodmead 2080
ESPAÑA SPAIN	902 31 24 00	2 años 2 years	GROUPE SEB IBÉRICA S.A. C/ Almogàvers, 119-123, Complejo Ecurban 08018 Barcelona
SVERIGE SWEDEN	08 594 213 30	2 år 2 years	TEFAL SVERIGE SUBSIDIARY OF GROUPE SEB NORDIC Truckvägen 14 A, 194 52 Upplands Väsby
SUISSE SCHWEIZ SWITZERLAND	044 837 18 40	2 ans 2 Jahre 2 years	GROUPE SEB SCHWEIZ GmbH Thurgauerstrasse 105 8152 Glattbrugg
ประเทศไทย THAILAND	02 769 7477	2 years	GROUPE SEB THAILAND 2034/66 Italthai Tower, 14th Floor, n° 14-02, New Phetchburi Road, Bangkapi, Huaykwang, Bangkok, 10320
TÜRKIYE TURKEY	444 40 50	2 YIL 2 years	GROUPE SEB ISTANBUL AS Dereboyu Cd. Bilim Sk. Sun Plaza No:5 K:2 Maslak/IST
المملكة العربية الإمارات UAE	8002272	1 year	www.tefal-me.com
Україна UKRAINE	044 300 13 04	2 роки 2 years	ТОВ «Груп СЕБ Україна» 02121, Харківське шосе, 201-203, 3 поверх, Київ, Україна
UNITED KINGDOM	0345 602 1454	1 year	GROUPE SEB UK LTD Riverside House, Riverside Walk Windsor, Berkshire, SL4 1NA
U.S.A.	800-395-8325	1 year	GROUPE SEB USA 2121 Eden Road Millville, NJ 08332
VENEZUELA	0800-7268724	2 años 2 years	GROUPE SEB VENEZUELA Av Eugenio Mendoza, Centro Letonia, Torre ING Bank, Piso 15, Ofc 155 Urb. La Castellana, Caracas

INTERNATIONAL GUARANTEE

Date of purchase: / Date d'achat / Fecha de compra / Data da compra / Data d'acquisto / Kaufdatum / Aankoopdatum / Kopsdato / Inköpsdatum / Kjøpsdato / Ostopirivä / Data zakupu / Data vânzării / [s]igijimo data / Ostukupaev / Datum nákupa / Sorozatszám / Dátum nákupa / Pirkums datums / Datum Kupovine / Datum kupnje / Data cumpărării / Datum nákupa / Tariikh pembelian / Tanggal pembelian / Ngày mua hàng / Satin alma tarihi / Дата продаж / Дата на закупуване / Датум на купување / Сатылган меркиси / Ημερομηνία αγοράς / Կանխորդ օրը / 購買日期 / 購入日 / 구입일자 / تاريخ الشراء / تاريخ الشراء / تاریخ خرید

Product reference: / Référence du produit / Referencia del producto / Nome do produto / Tipo de produto / Typnummer des Gerätes / Artikelnummer van het apparaat / Referencenummer / Produktreferenz / Artikelnummer / Tuotenumero / referencia produktu / Model / Gaminio numeris / Toote viitenumber / Tip aparata / Vásárlás kelte / Typ výrobku / Produkta atsauces numurs / Model proizvoda / Oznaka proizvoda / Cod produs / Produkt rujukan / Referensi produk / Mã sản phẩm / Үтүн коду / Модель / Модель / Модел на уред / Модел / Кодокó; προϊόντος / Унћқ / ھۆكۈم / 產品模型 / 製品番号 / 제품명 / مرجع المنتج الكامل / مرجع المنتج الكامل

Retailer name & address: / Nom et adresse du vendeur / Nombre y dirección del minorista / Nome e endereço do revendedor / Nome e indirizzo del negoziante / Name und Anschrift des Händlers / Naam en adres van de dealer / Forhandler navn & adresse / Återförsäljarens namn och adress / Forhandler navn og adresse / Jälleenmyyjän nimi ja osoite / nazwa i adres sprzedawcy / Numele și adresa vânzătorului / Parduotuvės pavadinimas ir adresas / Māiņa kauplis ja adrese / Naziv in naslov trgovine / Tipuszárm / Názov a adresa predajcu / Veikala nosaukums un adrese / Naziv i adresa maloprodajce / Naziv i adresa prodavca / Naziv i adresa prodajnog mjesta / Nume și adresă vânzător / Název a adresa prodejce / Nama dan alamat peruncit / Nama Toko Penjual dan alamat / Tên và địa chỉ cửa hàng bán/ Satec firmann adı ve adresi / Названия и адрес продавца / Назва i adresa prodavnice / Търговски обект / Назим и адреса на продавницата / Сатылгычы аты жана мекен-жайы / Επωνυμία και διεύθυνση καταστήματος / Կանխորդի անվանումը և հասցեն / ھۆكۈم / 零售商的店名和地址 / 販売店名、住所 / 소매점 이름과 주소 / اسم بائع التجزئة وعنوانه / نام بائع تجزئة و عنوانه / نام بائع التجزئة و عنوانه

Distributor stamp / Cachet distributeur / Sello del distribuidor / Carimbo do revendedor / Timbro del negozio / Händlerstempel / Stempel van de dealer / Forhandler stempel / Återförsäljarens stämpel / Forhandler stempel / Jälleenmyyjän leima / pieczęć sprzedawcy / Štampila vânzătorului / Antspaudas / Tempel / Žig trgovine / Eladó neve, címe / Razikto predajcu / Zimogs / Pečat maloprodajce / Pečat prodavca / Pečat prodajnog mjesta / Štampila vânzătorului / Razikto prodajce / Cap peruncit / Cap dari Toko Penjual / Cửa hàng bán đóng dấu / Satec Firmann Kasesi / Печатка продавца / Печатка продавца / Печат на търговския обект / Печат на продавницата / Сатылгычы мөрү / Σφραγίδα καταστήματος / Կանխորդի կնիքը / ھۆكۈم / 零售商的盖印 / 販売店印 / 販売店印 / 소매점 직인 / مهر تجزئة / مهر تجزئة / مهر تجزئة