

Moulinex
accessimo

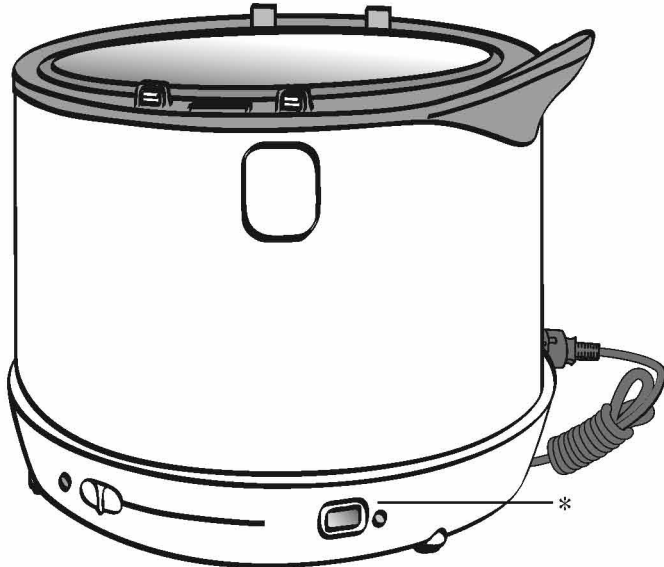

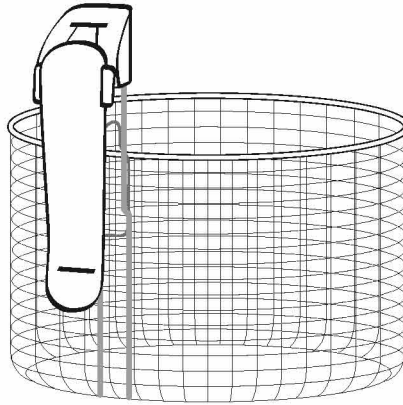

*selon modèle • depending on model • je nach Modell • a seconda del modello • según modelo • consoante os modelos • Ανόλογα με το μοντέλο • В зависимости от модели • Залежно від моделі • zależnie od modelu • az egyes modellek szerint • podle modelů • podľa modelov • В зависимости от модели • În funcție de model • modellere göre • Зависно од модела • zavisno od modela • Ólede na model • بحسب الموديل • بحسب مدل *

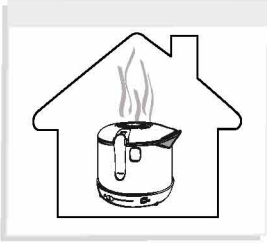

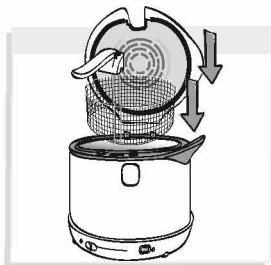
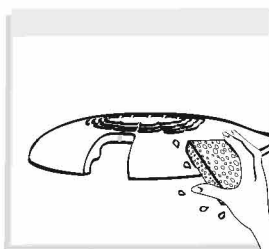
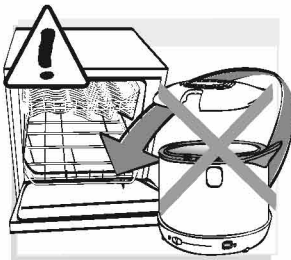
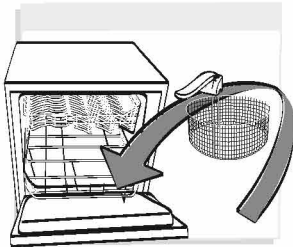
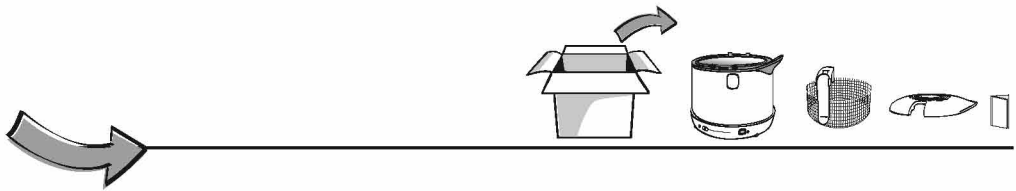



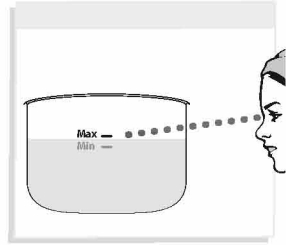

Min 2L
Max 2,2L

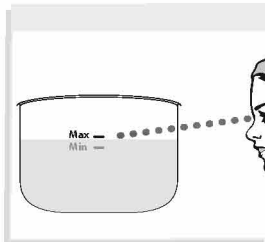
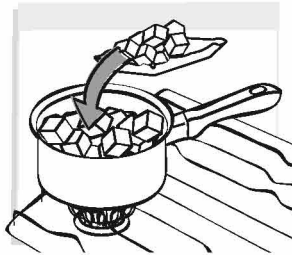

Min 1 750 g
Max 2 000 g

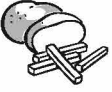



	Max 1000 g
	500 g

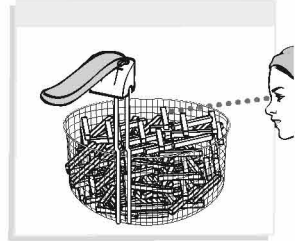
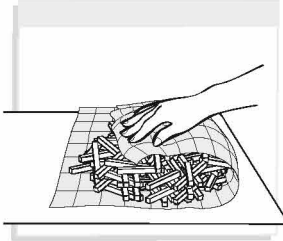



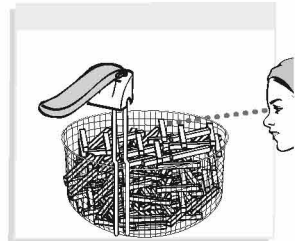
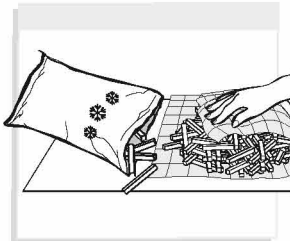

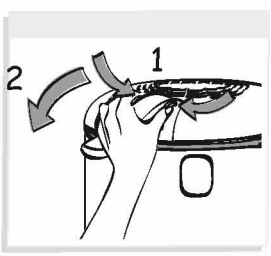
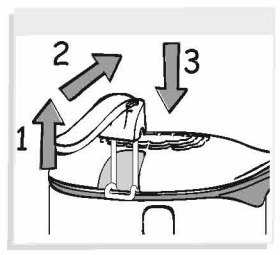
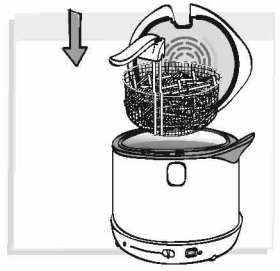
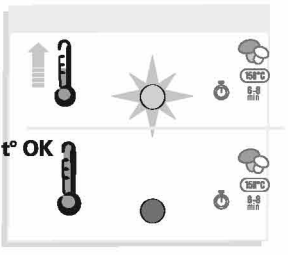
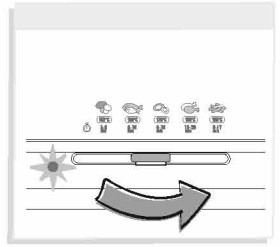





















	Max 750 g
	380 g







	Nb		 °C	
		1000g	1) 190°C	9-10 min.
			2) 190°C	3-4 min.
		1000g	190°C	22-23 min.
		500g	190°C	17-18 min.
		3-4	180°C	16-18 min.
		2	160°C	6-8 min.
		200g	150°C	6-8 min.
		4	180°C	16-18 min.
		8	180°C	10-12 min.
		5	170°C	5-7 min.
* * *	Nb		 °C	
		750g	190°C	12-14 min.
		380g	190°C	8-9 min.
		3-4	190°C	20-22 min.
		2	160°C	5-7 min.
		200g	190°C	4-5 min.
		1 Kg	190°C	5-7 min.
		6	190°C	4-6 min.

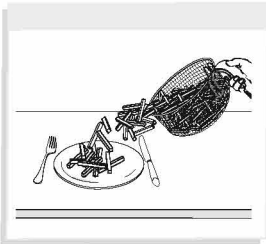
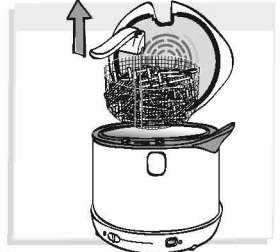
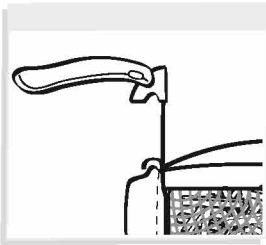
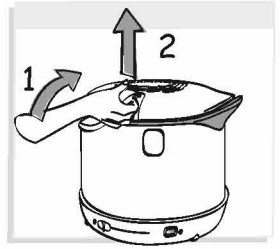
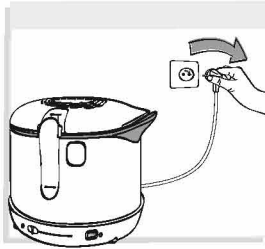
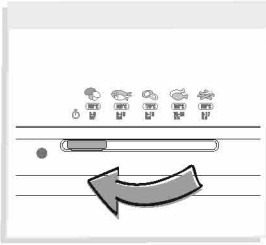

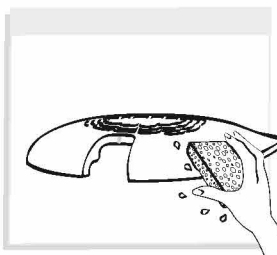
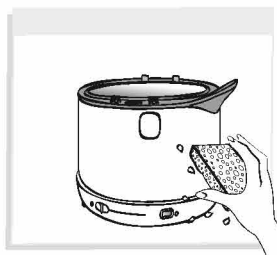
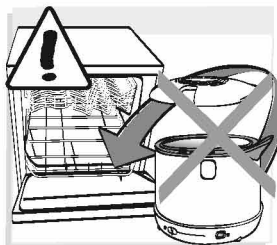
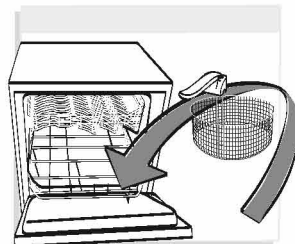

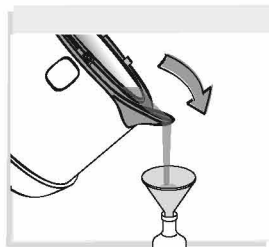
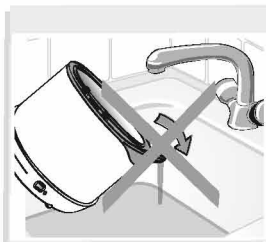

Référence : 5085685
Conception : www.batoteam.fr

