

15PF4121  
20PF4121  
20PF4321  
23PF4321

**FLATTV™**

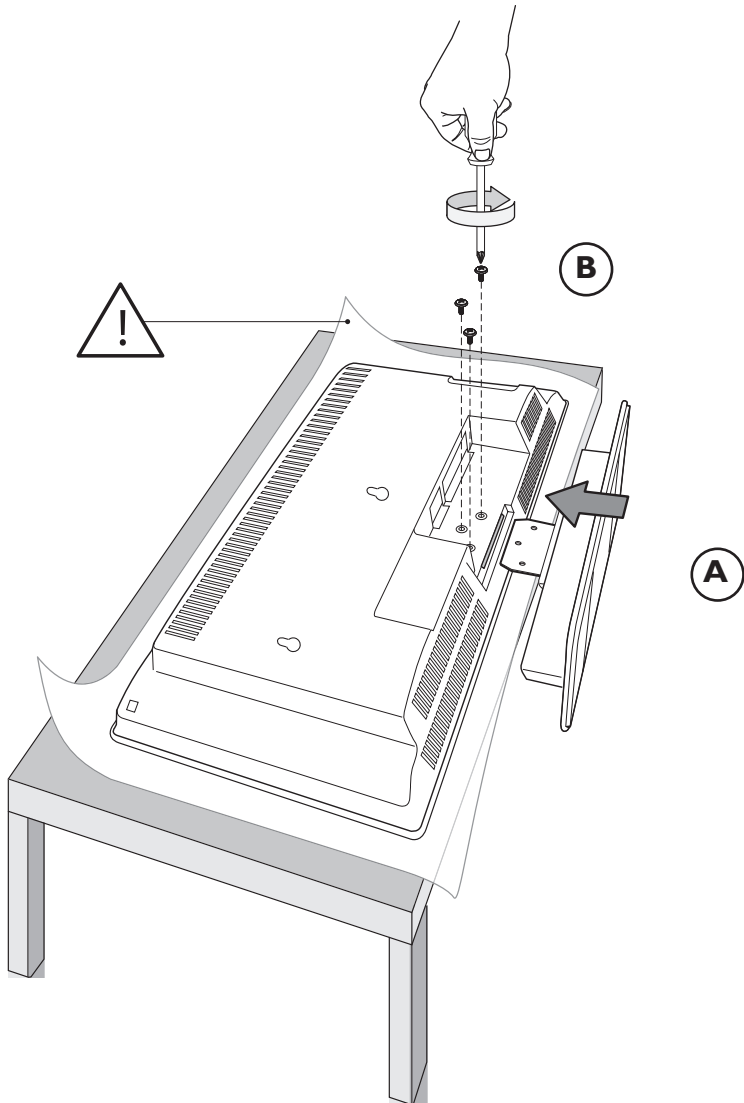

**PHILIPS**

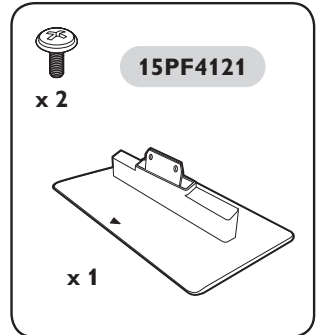
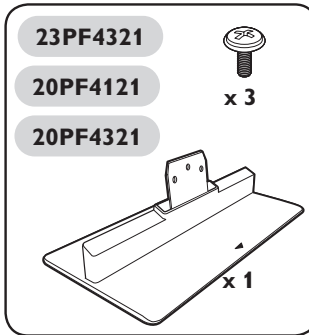
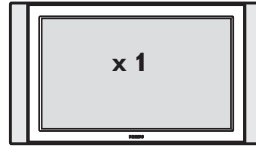
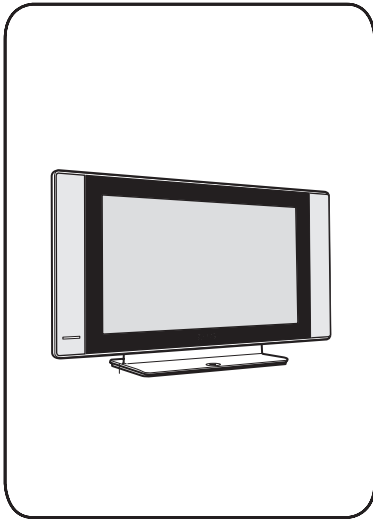

Please be aware that when you wall mount your TV using the key hole system, the side AV connectors are difficult to access and use when connecting standard cables.

Veuillez noter que, lorsque vous fixez votre télévision au mur à l'aide de la plaque de fixation, les connecteurs AV latéraux sont difficiles d'accès et d'utilisation s'ils sont branchés à des câbles standard.

Merk op dat, wanneer u de TV aan de muur bevestigt met het inhaaksysteem, de AV-ingangen aan de zijkant moeilijk te bereiken/gebruiken zijn wanneer u standaardkabels gebruikt.

Bitte nehmen Sie zur Kenntnis, dass wenn Sie Ihren TV an der Wand unter Gebrauch des Schlüssellochsystems befestigen, die seitlichen AV Anschlüsse während des Anschließens der Standard-Kabel schwer zu erreichen und zu verwenden sind.

Si fa presente che quando si esegue il montaggio a parete del televisore utilizzando il sistema di aggancio con fori a forma di buco di serratura, sarà più difficoltoso accedere ed usare i connettori laterali AV per la connessione di cavi standard.

Bemærk venligst, at når du anbringer TV'et på væggen i nøglehullerne, er det svært at nå side-AV-stikkene med standardkabler.

Vennligst vær oppmerksom på at når du monterer din TV ved bruk av nøkkelhullsystemet er AV tilkloplingene på siden vanskelig å aksessere og bruke når du kopler til standardkabler.

Var uppmärksam på när du monterar upp din TV på väggen med nyckelhålssystemet, att AV-anslutningarna på sidan är svåra att komma åt och använda då de ansluts med standardkablar.

Huomaa, että kun kiinnität televisiosi seinään käyttäen lukittavaa reikäsystemiä, sen sivussa olevat AV-liittimet ovat vaikeasti tavoitettavissa ja käytettävissä tavanomaisia kaapeleita käytettäessä.

Знайте, что когда вы крепите ваш телевизор к стене методом отверстия под ключ, тогда к стороне где находятся разъемы AV трудно подобраться и следует использовать соединение при помощи стандартных кабелей.

Sepa que cuando monta su televisor sobre una pared usando el sistema de agujeros, los conectores de AV serán difíciles de acceder y usar cuando conecte cables estándar.

Atenção: se fixar a TV à parede usando o sistema de furos, será difícil acessar aos conectores laterais AV e ligar os cabos padrão.

Να γνωρίζετε ότι, όταν εγκαταστήσετε την τηλεόρασή σας στον τοίχο χρησιμοποιώντας το σύστημα με τις κλειδαρότρυπες, δύσκολα θα έχετε πρόσβαση στους ρευματοδότες της πλευράς AV και **δεν θα μπορούν να χρησιμοποιηθούν** εύκολα όταν συνδέετε με κανονικά καλώδια.

TV'nizi anahtar deliği sistemi kullanarak duvara astığınızda, standart kabloları bağlarken yan AV bağlantılarına ulaşmanın ve onları kullanmanın zor olacağını lütfen aklınızda bulundurunuz.

Figyeljen arra, hogy ha a készüléket a falra akasztja, akkor az oldalsó AV csatlakozókat szabványos kábelrel nehezen fogja elérni is használni.

Prosze zauważycy, że przy montażu telewizora na ścianie przy wykorzystaniu systemu otworów boczne złącza AV są trudno dostępne a ich przydatność dla celów podłączenia standardowych kabli jest ograniczona.

Vezméte prosím na vedomí, že pokud jste při uchycení TV na zed využili systém otvorů ve tvaru klíčové dírky; v tom případě budou AV konektory na boku při připojování standardních kabelů špatně přístupné a jejich používání bude obtížnější.

Nezabudnite prosím, že ak nainštalujete televízor na stenu systémom zapustených prichytiek, bočné AV konektory budú pri pripájaní štandardných káblov ťažšie prístupné.



1

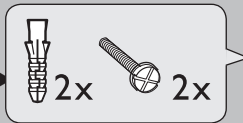
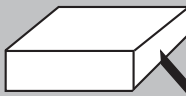

Provided  
Fourni  
Bijgeleverd  
Mitgeliefert  
Incluso  
Medleveret  
Medfølger  
Valfri  
Mukana

Обеспеченный  
Incluida  
Forneca  
Παρέχεται  
bayet  
Feltéve  
Pod warunkiem  
Pokud  
Za predpokladu

2

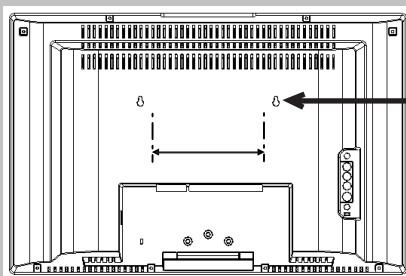
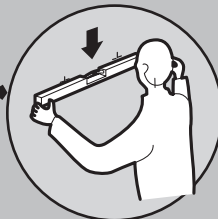
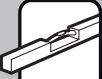
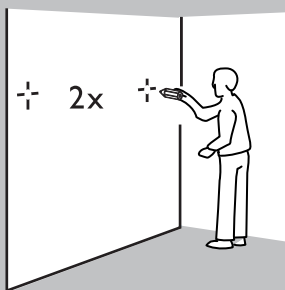

15PF4121 – 200 mm  
20PF4121 – 200 mm  
20PF4321 – 210 mm  
23PF4321 – 210 mm

3

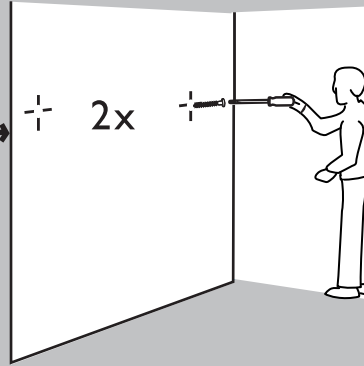
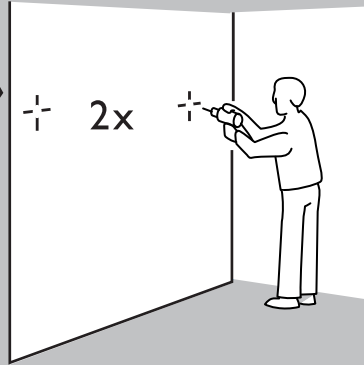
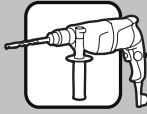

4

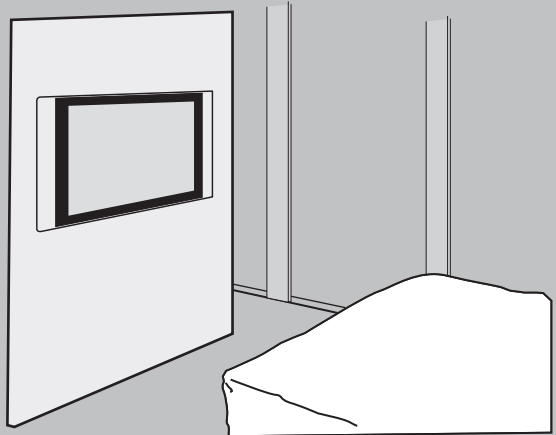
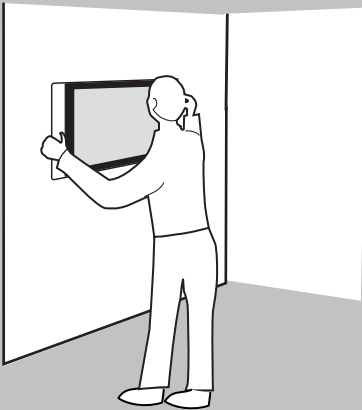

# Introduction

Thank you for purchasing this television set.  
This handbook has been designed to help you install and operate your TV set.  
We would strongly recommend that you read it thoroughly.

# Table of Contents

<b>Installation</b>	
Presentation of the LCD Television .....	2
Remote control .....	2
Remote control keys .....	3-4
Installing your television set .....	5
Quick installation .....	5
Program sort .....	6
Manual store .....	6
Other settings in the Install menu .....	6
<b>Operation</b>	
Picture settings .....	7
Sound adjustments .....	7
Feature settings .....	7
Screen Formats .....	8
Teletext .....	9
Using in PC monitor mode .....	10
Using in HD (High Definition) Mode .....	11
<b>Peripherals</b>	
Video recorder .....	12
Other equipment .....	13
Side connections .....	13
HD equipment .....	13
Computer .....	13
<b>Practical information</b>	
Tips .....	14
Glossary .....	14

# Recycling



The packaging of this product is intended to be recycled. Apply to the local authorities for correct disposal.

## Disposal of your old product.

Your product is designed and manufactured with high quality materials and components, which can be recycled and reused. When this crossed-out wheeled bin symbol is attached to a product it means the product is covered by the European Directive 2002/96/EC. Please inform yourself about the local separate collection system for electrical and electronic products.



Please act according to your local rules and do not dispose of your old products with your normal household waste. The correct disposal of your old product will help prevent potential negative consequences for the environment and human health.

## Presentation of the LCD Television

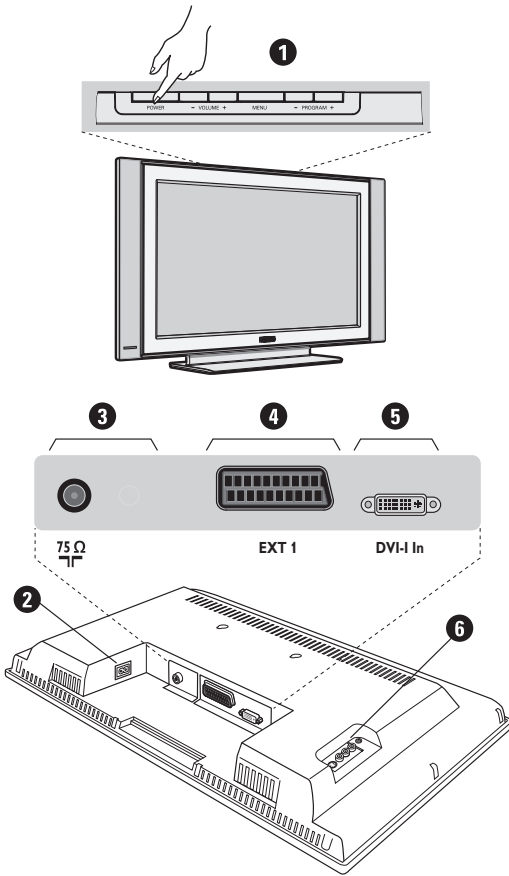

### 1 Television keys:

- **POWER:** to switch the TV on or off.
- **VOLUME +/-:** to adjust sound level.
- **MENU:** to access or close menus.  
The PROGRAM +/- keys can be used to select an adjustment and the VOLUME +/- keys to make that adjustment.
- **PROGRAM +/- (- P +):** to select programmes.

### Rear of set :

The main connections are made at the bottom of the television.

*For more details on connections see page 12.*

- 2 Power socket
- 3 TV aerial socket
- 4 EXT1 socket
- 5 DVI-I input for connecting a HD (high definition)\* equipment or computer with DVI output.
- 6 Side connections

*\* Depending on version.*

## Remote control

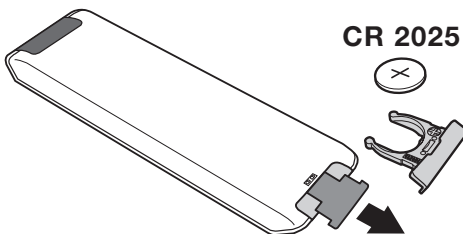

Pull out the plastic insulation sheet from the battery, this will activate the remote control. The battery supplied with the appliance does not contain mercury or nickel cadmium so as to protect the environment. Please do not discard your used batteries, but use the recycling methods available (consult your distributor).

# Remote Control Keys for LCD TV Functions

- 1) **⏻ (STANDBY)**  
To set the TV to standby mode. To switch the TV set on again, press **P -/+**, **0** to **9** or **AV** keys.
- 2) **Sleeptimer**  
To select the length of time before the set automatically switches to standby (from 0 to 240 minutes)
- 3) **AV**  
To display **Source List** to select **TV** or peripheral equipment connected to **EXT1**, **AV/S-VHS**, **PC** or **HD** (p. 12).
- 4) **Ⓜ ? Ⓜ Teletext keys (p. 9)**
- 5) *Unused key.*
- 6) **MENU**  
To call up or exit the TV menus.
- 7) **Ⓜ Screen Format (p. 8)**
- 8) **Cursor (⤴ ⤵ ⤶ ⤷)**  
These 4 keys are used to move around the menus.
- 9) **Volume**  
To adjust the sound level.
- 10) **📺 🎵 Smart picture and sound**  
Used to access a series of predefined picture and sound settings.  
*The personal position relates to settings selected from the menus.*
- 11) **Ⓜ+ Screen information**  
To display / remove the programme number, the time, the sound mode and the time remaining on the timer. Hold down for 5 seconds to permanently display the programme number on the screen.

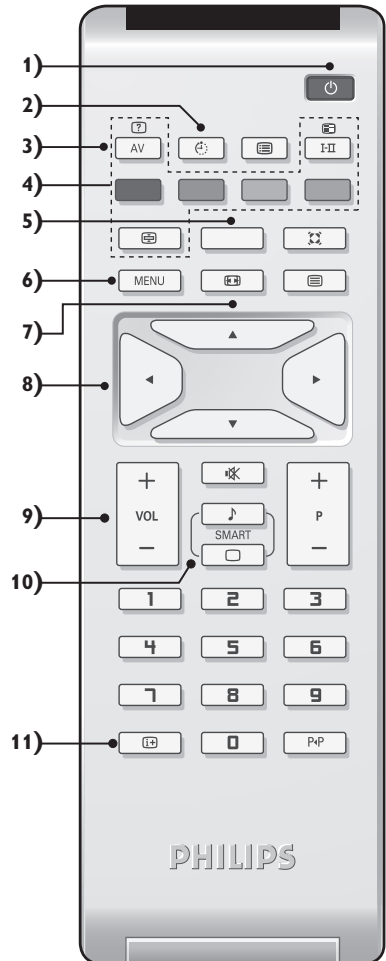

# Remote Control Keys for LCD TV Functions

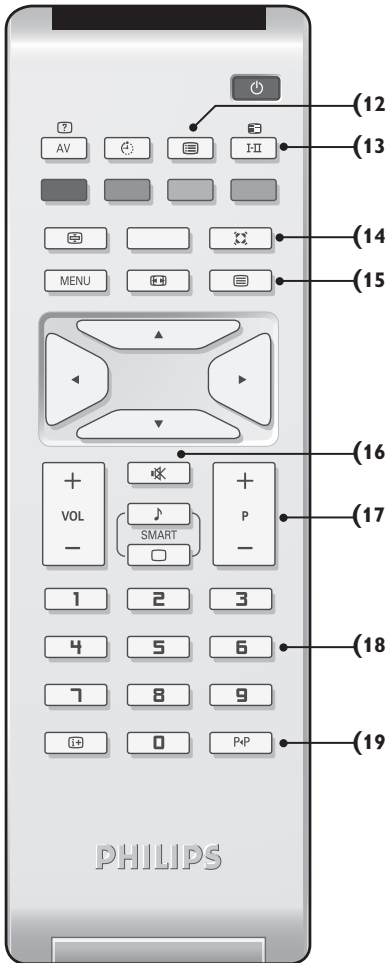

## 12) List of programmes

To display / clear the list of programmes. Use the keys  $\wedge \vee$  to select a programme and the key  $>$  to display it.

## 13) **I-II Sound mode**

Used to force programmes in **Stereo** and **Nicam Stereo** to **Mono** or, for bilingual programmes, to choose between **Dual I** or **Dual II**.

*The **Mono** indication is red when in forced position.*

## 14) Surround Sound

To activate / deactivate the surround sound effect. In stereo, this gives the impression that the speakers are further apart. For models equipped with Virtual Dolby Surround\*, you can experience Dolby Surround Pro Logic sound effects.

## 15) Teletext (p. 9)

## 16) Mute

To mute or restore the sound.

## 17) **P +/-** Selecting TV programmes

To move up or down a programme. The number and the sound mode are displayed for a few seconds.

*For some TV programmes the title of the programme appears at the bottom of the screen.*

## 18) **0/9 Numerical keys**

For direct access to programmes. For a 2 digit programme number, the 2<sup>nd</sup> digit must be entered before the dash disappears.

## 19) **P+P Previous programme**

To access the previously viewed programme.

\* Manufactured under license from Dolby Laboratories. "Dolby" and the double-D symbols are trademarks of Dolby Laboratories.



# Installing your television set

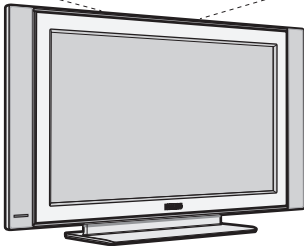
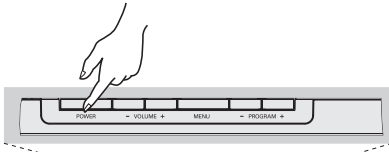
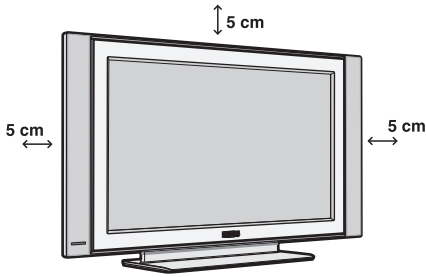

## 1 Positioning the television set

Place your TV on a solid stable surface. To avoid danger do not expose the TV to water, or a heat source (e.g. lamp, candle, radiator). Do not obstruct the ventilation grid at the rear.

## 2 Connecting the aerials

- Insert the aerial plug into the  socket at the rear of the set.
- Connect the power lead to the television and the mains plug into the wall socket (220-240 V/50 Hz).

For connecting other appliances see page p.12.

## 3 Switching on

To switch on the set, press the **POWER** key. A green indicator comes on and the screen lights up. Go straight to the Quick Installation chapter. If the TV remains in standby mode (red indicator), press the **P +/-** key on the remote control.

The indicator will flash when you use the remote control.

## Plug & Play

# Quick installation

When you turn on the TV set for the first time, a menu is displayed on screen. This menu prompts you to select the country and language for the menus:

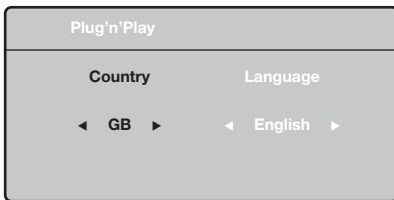

If the menu is not displayed, press the **MENU** key to display the menu.

- 1 Use the **^** **v** keys on the remote control to select your country and confirm with **>**.  
If your country does not appear in the list, select choice "..."
- 2 Next select your language using the **^** **v** keys and confirm with **>**.

- 3 The search starts automatically. All the available TV programmes will be stored. This operation takes a few minutes. The display shows the progress of the search and the number of programs found. At the end of the search, the menu disappears.

To exit or interrupt the search, press **MENU**. If no programme is found, consult the possible solutions p. 14.

- 4 If the transmitter or cable network sends the automatic sort signal, the programs will be numbered correctly. In this case, the installation is complete.
- 5 If this is not the case, you need to use the **Sort** menu to number the programs correctly. Some transmitters or cable networks broadcast their own sort parameters (region, language, etc.). In this case, indicate your choice using the **^** **v** keys and validate with **>**.

## Program sort

- 1 Press the **MENU** key. The **TV Menu** is displayed on the screen.

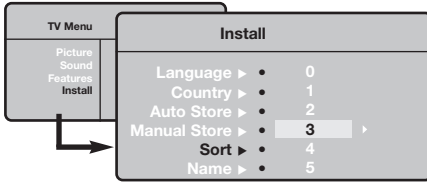

- 2 With the cursor, select the **Install** menu followed by the **Sort** menu.
- 3 Select the programme you want to move using the  $\wedge \vee$  keys and press  $\>$ .
- 4 Then use the  $\wedge \vee$  keys to select the new number and validate with  $\leftarrow$ .
- 5 Repeat steps 3 and 4 for each programme you wish to renumber.
- 6 To quit the menus, press **i+**.

## Manual store

This menu is used to store the programmes one at a time.

- 1 Press the **MENU** key.
- 2 With the cursor, select the **Install** menu then **Manual store**:

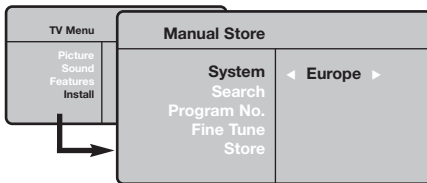

- 3 **System:** select **Europe** (automatic detection\*) or **Western Europe** (BG standard), **Eastern Europe** (DK standard), **United Kingdom** (I standard) or **France** (LL' standard).

\* Except for France (LL' standard), you must select choice **France**.

- 4 **Search:** press  $\>$ . The search starts. Once a programme is found, the scanning stops and its name is displayed (when available). Go to the next step. If you know the frequency of the required programme, this can be entered directly using the **0 to 9** keys.  
*If no picture is found, consult the possible solutions (p. 14).*
- 5 **Program No.:** enter the required number with the  $\langle \rangle$  or **0 to 9** keys.
- 6 **Fine Tune:** if the reception is not satisfactory, adjust using the  $\langle \rangle$  keys.
- 7 **Store:** press  $\>$ . The program is stored.
- 8 Repeat steps 4 to 7 for each programme to store.
- 9 To quit the menus, press **i+**.

## Other settings in the Install menu

- 1 Press the **MENU** key and select the **Install** menu:
- 2 **Language:** to change the display language for the menus.
- 3 **Country:** to select your country (**GB** for Great Britain).

*This setting is used for the search, automatic programme sort and teletext display. If your country does not appear in the list, select "..."*

- 4 **Auto Store:** to start automatic search for all programmes available in your region. If the transmitter or cable network sends the automatic sort signal, the programmes will be numbered correctly. If this is not the case, you need to use the Sort menu to renumber the programmes.

*Some transmitters or cable networks broadcast their own sort parameters (region, language, etc.). In this case, indicate your choice using the  $\wedge \vee$  keys and validate with  $\>$ . To quit or interrupt the search, press **MENU**. If no picture is found, consult the possible solutions (p. 14).*

- 5 **Name:** If required, you can give a name to the programmes and external connectors. Use the  $\langle \rangle$  keys to move around the name display area (5 characters) and the  $\wedge \vee$  keys to select the characters. When the name has been entered, use the  $\leftarrow$  key to exit. The name is stored.  
*Note: on installation, the programs are named automatically when an identification signal is sent.*
- 6 To quit the menus, press **i+**.

## Picture settings

- 1 Press **MENU** then **>**. The **Picture** menu is displayed:

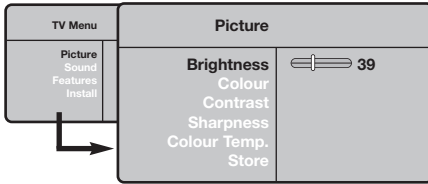

- 2 Use the **^** **v** keys to select a setting and the **<** **>** keys to adjust.
- 3 Once the adjustments have been made, select

**Store** and press **>** to store them. Press **i+** to exit.

### Description of the adjustments:

- **Brightness:** this changes picture brilliance.
- **Colour:** this changes the intensity of the colour.
- **Contrast:** this changes the difference between the light and dark tones.
- **Sharpness:** this changes the picture definition.
- **Colour Temp.:** this changes the colour rendering: **Cold** (bluer), **Normal** (balanced) or **Warm** (redder).
- **Store:** to store the picture adjustments and settings.

## Sound adjustments

- 1 Press **MENU**, select **Sound** (**v**) and press **>**. The **Sound** menu is displayed:

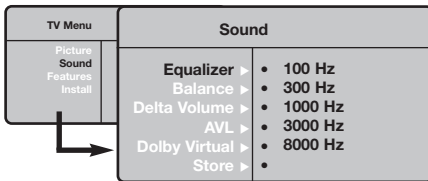

- 2 Use the **^** **v** keys to select a setting and the **<** **>** keys to adjust.
- 3 Once the adjustments have been made, select **Store** and press **>** to store these changes.
- 4 To quit the menus, press **i+**.

### Description of the settings:

- **Equalizer:** to adjust the sound tone (from bass: 100 Hz to treble: 8000 Hz).
- **Balance:** this balances the sound on the left and right speakers.
- **Delta Volume:** this is used to compensate any volume discrepancies between the different programs or EXT sockets. This setting is available for programs 0 to 40 and the EXT sockets.
- **AVL (Automatic Volume Leveller):** this is used to limit increases in sound, especially on program change or advertising slots.
- **Dolby Virtual:** To activate / deactivate the surround sound effect. You can also access these settings with key .
- **Store:** this is used to store the sound settings.

## Feature settings

- 1 Press **MENU**, select **Features** (**v**) and press **>**. You can adjust:
- 2 **Contrast +:** automatic adjustment of the picture contrast which permanently sets the darkest part of the picture to black.

- 3 **Sleep :** to select an automatic standby period.
- 4 To quit the menus, press **i+**.

## Screen Formats

The pictures you receive may be transmitted in 16:9 format (wide screen) or 4:3 format (conventional screen). 4:3 pictures sometimes have a black band at the top and bottom of the screen (letterbox format). This function allows you to optimise the picture display on screen.

### If your television is equipped with a 4:3 screen.

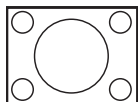

Press the  key (or  $\wedge \vee$ ) to select the different modes:

#### 4:3

The picture is reproduced in 4:3 format.

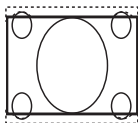

#### Expand 4:3

The picture is enlarged vertically. This mode is used to cancel the black bands when watching a programme in letterbox format.

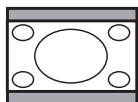

#### Compress 16:9

The picture is compressed vertically into 16:9 format.

### If your television is equipped with a 16:9 screen.

Press the  key (or  $< >$ ) to select the different modes:

*This TV set is also equipped with automatic switching which will select the correct-screen format, provided the specific signals are transmitted with the programmes.*

#### 4:3

The picture is reproduced in 4:3 format and a black band is displayed on either side of the picture.

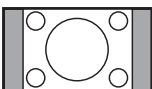

#### Zoom 14:9

The picture is enlarged to 14:9 format, a thin black band remains on both sides of the picture.



#### Zoom 16:9

The picture is enlarged to 16:9 format. This mode is recommended when displaying pictures which have black bands at the top and bottom (letterbox format).

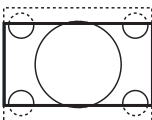

#### Subtitle Zoom

This mode is used to display 4:3 pictures using the full surface of the screen leaving the sub-titles visible.

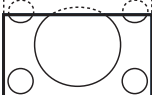

#### Super Wide

This mode is used to display 4:3 pictures using the full surface of the screen by enlarging the sides of the picture.

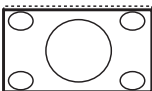

#### Widescreen

This mode restores the correct proportions of images transmitted in 16:9.

*Note: If you display a 4:3 picture in this mode, it will be enlarged horizontally.*

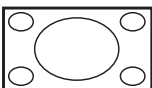

# Teletext

Teletext is an information system broadcast by certain channels which can be consulted like a newspaper. It also offers access to subtitles for viewers with hearing problems or who are not familiar with the transmission language (cable networks, satellite channels, etc.).



**Press :**

**You will obtain :**

**Teletext call** This is used to call or exit teletext mode. The summary appears with a list of items that can be accessed. Each item has a corresponding 3 digit page number.

*If the channel selected does not broadcast teletext, the indication 100 will be displayed and the screen will remain blank (in this case, exit teletext and select another channel).*



**Selecting a page** Enter the number of the page required using the 0 to 9 or P +/- keys. Example: page 120, enter 120.

The number is displayed top left, the counter turns and then the page is displayed. Repeat this operation to view another page.

*If the counter continues to search, this means that the page is not transmitted. Select another number.*



**Direct access to the items** Coloured areas are displayed at the bottom of the screen. The 4 coloured keys are used to access the items or corresponding pages.

*The coloured areas flash when the item or the page is not yet available.*





**Contents** This returns you to the contents page (usually page 100).



**Stop sub-page acquisition** Certain pages contain sub-pages which are automatically displayed successively. This key is used to stop or resume sub-page acquisition. The indication  appears top left.



**Double page teletext** To activate or deactivate the double page teletext display mode. The active page is displayed on the left and the following page is displayed on the right. Press  if you want to hold a page (i.e. the contents page). The active page is then displayed on the right. To return to normal mode, press .

*(depending on version)*



**Hidden information** To display or hide the concealed information (games solutions).



**Enlarge a page** This allows you to display the top or bottom part of the page and then return to normal size.

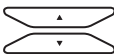



**Favourite pages** Instead of the standard coloured areas displayed at the bottom of the screen, you can store 4 favourite pages on the first 40 channels which can then be accessed using the coloured keys (red, green, yellow, blue). Once set, these favourite pages will become the default every time teletext is selected.



- 1 Press the **MENU** key to change to favourite pages mode.
- 2 Display the teletext page that you want to store.
- 3 Press the coloured key of your choice for 3 seconds. The page is now stored.
- 4 Repeat the operation with the other coloured keys.
- 5 Now when you consult teletext, your favourite pages will appear in colour at the bottom of the screen. To temporarily retrieve the standard items, press **MENU**.

*To clear everything, and return the standard items as the default, press  for 5 seconds.*

*To clear everything, and return the standard items as the default, press  for 5 seconds.*

*To clear everything, and return the standard items as the default, press  for 5 seconds.*

## Using in PC monitor mode

### NOTE

- When using the LCD TV as a PC monitor, slight diagonal interference lines may be observed when it is operated under electromagnetic interference environment but will not affect the performance of this product.
- For better performance, good quality DVI cable with good noise isolation filter is recommended.

### PC Mode

Your TV can be used as a computer monitor.  
You must first of all connect the computer and adjust the resolution (see p.13).

### Choosing PC mode

- 1 Press the **AV** key on the remote control to display the **Source List**.
- 2 Use the cursor  $\wedge/\vee$  key to select **PC** and then press the cursor  $>$  key to switch the TV to PC mode (**DVI-I In**).  
To return to TV mode, press the **AV** key, select **TV** and validate with  $>$  key.

### Using the PC menus

Press the **MENU** key to access the specific settings of the PC monitor mode. Use the cursor to adjust them (the settings are automatically saved):

### • Picture:

- **Brightness / Contrast** : to adjust the brightness and contrast.
  - **Horizontal / Vertical**: to adjust the horizontal and vertical placing of the image.
  - **Colour Temp**: to adjust the colours (cold, normal or warm).
- ### • Audio Selection:
- to choose the sound reproduced on the TV (PC/HD orTV).
- ### • Features (only available on certain versions):
- **Phase/Clock**: eliminates the horizontal (**Phase**) and vertical (**Clock**) interfering lines.
  - **Format** : to choose between full screen or native format of the PC screens.
  - **Auto Adjust**: position is set automatically.
- ### • Reset To Factory Setting:
- to return to the factory settings (default settings).

Here is the list of the different PC display resolutions available on your TV:

	15"/39cm XGA	20"/51cm VGA	20"/51cm WXGA	23"/58cm WXGA
640 x 350	X	X		
640 x 480	X	X	X	X
800 x 600	X		X	X
832 x 624	X			
1024 x 768	X		X	X
1280 x 768			X	X

# Using in HD (High Definition) Mode

(Only available on certain versions)

## HD Mode

The HD (High Definition) mode allows you to enjoy clearer and sharper pictures through the DVI-I inputs if you are using a HD receiver/ equipment that can transmit high definition programming.

You must first of all connect the HD equipment (see p.13).

## Choosing HD mode

- ❶ Press the **AV** key on the remote control to display the **Source List**.
- ❷ Use the cursor  $\wedge/\vee$  key to select **HD** and then press the cursor  $>$  key to switch the TV to HD mode.  
To return to TV mode, press the **AV** key, select **TV** and validate with  $>$  key.

## Using the HD menus

Press the **MENU** key to access the specific settings of the HD mode. Use the cursor to adjust them (the settings are automatically saved):

### Picture:

- **Brightness:** this changes picture brilliance.
- **Colour:** this changes the intensity of the colour.
- **Contrast:** this changes the difference between the light and dark tones.
- **Sharpness** (only available for certain signal only): this changes the picture definition.

- **Colour Temp.:** this changes the colour rendering: **Cold** (bluer), **Normal** (balanced) or **Warm** (redder).
- **Store:** to store the picture adjustments and settings.

### Sound:

- **Equalizer:** to adjust the sound tone (from bass: 100 Hz to treble: 8000 Hz).
- **Balance:** this balances the sound on the left and right speakers.
- **Delta Volume:** this is used to compensate any volume discrepancies between the different programs or EXT sockets. This setting is available for programs 0 to 40 and the EXT sockets.
- **AVL (Automatic Volume Leveller):** this is used to limit increases in sound, especially on program change or advertising slots.
- **Dolby Virtual:** To activate / deactivate the surround sound effect. You can also access these settings with key .
- **Store:** this is used to store the sound settings.

### Features:

- **Sleep :** to select an automatic standby period.
- **Horizontal Shift:** to adjust the horizontal placing of the image.

Here is the list of the different HD display resolutions available on your TV:

	15"/39cm XGA		20"/51cm VGA		20"/51cm WXGA		23"/58cm WXGA	
	Analogue	Digital	Analogue	Digital	Analogue	Digital	Analogue	Digital
SDTV 480 i	X		X		X		X	
SDTV 576 i	X		X		X		X	
EDTV 480 p	X	X	X	X	X	X	X	X
EDTV 576p	X	X	X	X	X	X	X	X
HDTV 720p	X	X	X		X	X	X	X
HDTV 1080 i	X	X			X	X	X	X

# Connecting peripheral equipment

The television has 1 external socket situated at the back of the set (EXT1) and sockets on the side. Press the **AV** key on the remote control to display **Source List** and select **TV** or peripheral equipment connected to **EXT1**, **AV/SVHS**, **PC** or **HD**.

The **EXT1** socket has audio, CVBS/RGB inputs and audio, CVBS outputs.

The side connections has audio inputs, CVBS/S-VHS inputs, headphone out.

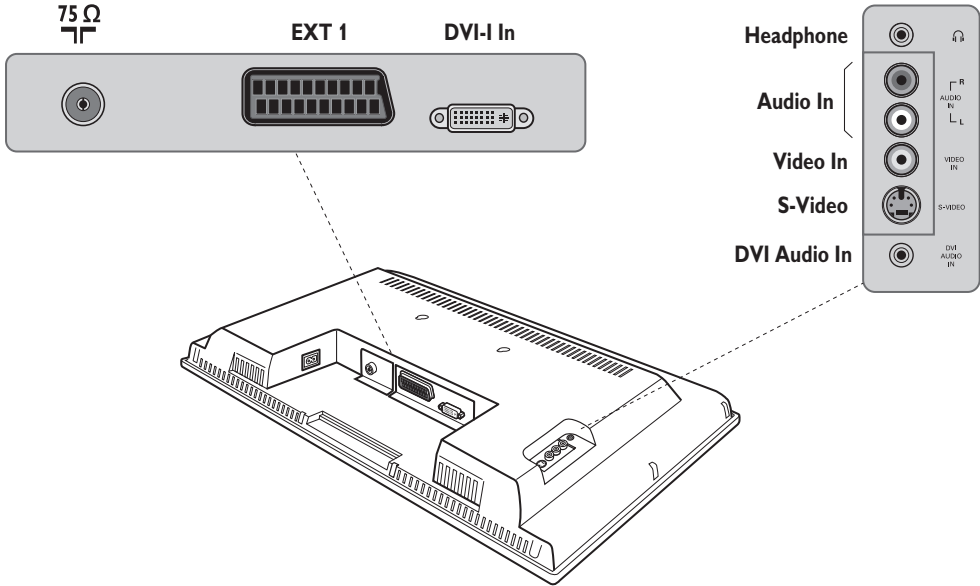

## Video recorder

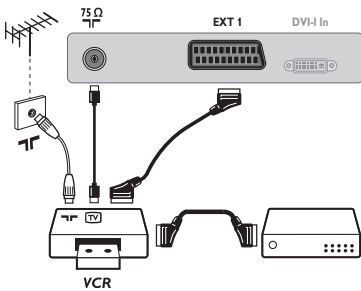

Carry out the connections shown opposite, using a good quality euroconnector cable.

*If your video recorder does not have a euroconnector socket, the only connection possible is via the aerial cable. You will therefore need to tune in your video recorder's test signal and assign it programme number 0 (refer to manual store, p. 6).*

*To reproduce the video recorder picture, press **0** key.*

### Video recorder with decoder

Connect the decoder to the second euroconnector socket of the video recorder. You will then be able to record scrambled transmissions.

## Other equipment

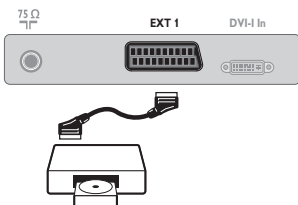

### Satellite receiver, decoder, CDV, games, etc.

Carry out the connections shown opposite.



## Side connections

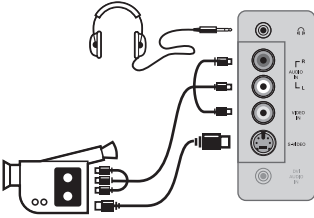

Make the connections as shown opposite.

With the **AV** key, select **AV/S-VHS**.

For a mono set, connect the sound signal to the **AUDIO L** (or **AUDIO R**) input. The sound automatically comes out of the left and right speakers of the set.

### Headphones

When headphones are connected, the sound on the TV set will be cut. The **VOLUME +/-** keys are used to adjust the volume level.

The headphone impedance must be between 32 and 600 Ohms.

## HD equipment

### HD Analogue Connection (DVI-I)

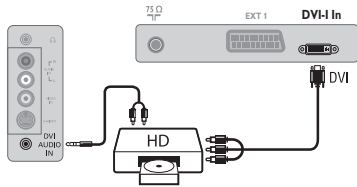

Make the connections as shown opposite.

With the **AV** key, select **HD**.

For more information on using HD mode see page 11.

### HD Digital Connection (DVI-I)

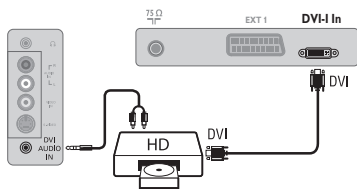

## Computer

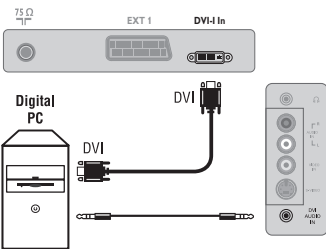

### PC with DVI

Connect the monitor output (DVI) of your computer to the DVI-I In of the LCD TV. Connect the sound output Audio out of the computer to the input DVI Audio in of the LCD TV.

### PC with VGA

Connect the monitor output (VGA) of your computer via a VGA/DVI-I cable\* to the DVI-I In of the TV. Connect the sound output Audio out of the computer to the input DVI Audio in of the LCD TV.

\* Not supplied with the set.

For more information on using PC mode see page 10.

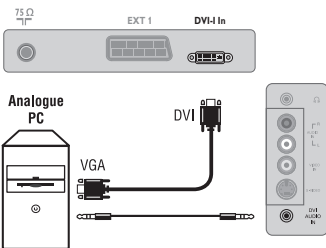

**Configure the computer on 1024 x 768, 60 Hz for optimum resolution.**

## Tips

<b>Poor reception</b>	The proximity of mountains or high buildings may be responsible for ghost pictures, echoing or shadows. In this case, try manually adjusting your picture: see Fine Tune (p. 6) or modify the orientation of the outside aerial. If you are using an indoor aerial, reception may be difficult in certain conditions. You can improve reception by rotating the aerial. If the reception remains poor, you will need to use an external aerial
<b>No picture</b>	Have you connected the aerial socket properly? Have you chosen the right system? (p. 6). Poorly connected euroconnector cables or aerial sockets are often the cause of picture or sound problems (sometimes the connectors can become half disconnected if the TV set is moved or turned). Check all connections.
<b>No sound</b>	If on certain channels you receive a picture but no sound, this means that you do not have the correct TV system. Modify the <b>System</b> setting (p. 6). The amplifier connected to the TV does not deliver any sound? Check that you have not confused the audio output with the audio input.
<b>PC mode doesn't work ?</b>	Check that you have configured the computer on a compatible display resolution (see p. 13).
<b>Snowy picture when switched to HD-D mode</b>	Noise is displayed if the connected digital equipment's (DVD player or set-top box) HDCP authentication failed. Check the user manual for the digital equipment you are connecting.
<b>Remote control</b>	The TV set does not react to the remote control; the indicator on the set no longer flashes when you use the remote control? Replace the battery.
<b>Standby</b>	If the set receives no signal for 15 mins, it automatically goes into standby mode. To save power, your set is fitted with components that give it a very low power consumption when in standby mode (less than 1W).
<b>Cleaning the set</b>	Only use a clean, soft and lint-free cloth to clean the screen and the casing of your set. Do not use alcohol-based or solvent-based products.
<b>Still no results?</b>	Disconnect the mains plug of the TV for 30 seconds then reconnect it. If your TV set breaks down, never attempt to repair it yourself: contact your dealer's after-sales service.

## Glossary

**DVI** (Digital Visual Interface): A digital interface standard created by the Digital Display Working Group (DDWG) to convert analog signals into digital signals to accommodate both analog and digital monitors.

**HDCP** (High-bandwidth Digital-Content Protection): developed by Intel to provide secure copy protection of content transmitted digitally from the source (such as DVD player or set-top box) to the TV display.

**VGA** (Video Graphics Array): a common standard graphics display system for PCs.

**RGB signals** : These are the three video signals, Red Green Blue, which make up the picture. Using these signals improves picture quality.

**S-VHS Signals**: These are 2 separate Y/C video signals from the S-VHS and Hi-8 recording standards. The luminance signals Y (black and white) and chrominance signals C (colour) are recorded separately on the tape. This provides

better picture quality than with standard video (VHS and 8 mm) where the Y/C signals are combined to provide only one video signal.

**NICAM sound**: Process by which digital sound can be transmitted.

**System**: Television pictures are not broadcast in the same way in all countries. There are different standards: BG, DK, I, and L L'. The **System** setting (p. 6) is used to select these different standards. This is not to be confused with PAL or SECAM colour coding. Pal is used in most countries in Europe, Secam in France, Russia and most African countries. The United States and Japan use a different system called NTSC. The inputs EXT1 and EXT2 are used to read NTSC coded recordings.

**16:9**: Refers to the ration between the length and height of the screen. Wide screen televisions have a ration of 16/9, conventional screen TV sets have a ration of 4/3.

Table of TV frequencies.  
 Frequenztafel der Fernsehsender.  
 Liste des fréquences TV.  
 Frequentietabel TV-Zenders.  
 Tabella delle frequenze TV.  
 Lista de frecuencias TV.

Lista das frequências TV  
 Liste over TV senderne.  
 Tabell over TV-frekvenser.  
 Tabell över TV-frekvenser.  
 TV-taajuustaulukko.  
 Κατάλογος συχνοτήτων πομπών.

Список частот передатчиков.  
 A televízió-adóállomások  
 frekvenciáinak a listája.  
 Lista częstotliwości stacji nadawczych.  
 Seznam frekvenčních pásem vysílačů.  
 Zoznam frekvenčných pásem vysílačov.

### EUROPE

CANAL	FREQ (MHz)	CANAL	FREQ (MHz)	CANAL	FREQ (MHz)
E2	48.25	S15	259.25	33	567.25
E3	55.25	S16	266.25	34	575.25
E4	62.25	S17	273.25	35	583.25
E5	175.25	S18	280.25	36	591.25
E6	182.25	S19	287.25	37	599.25
E7	189.25	S20	294.25	38	607.25
E8	196.25	H1	303.25	39	615.25
E9	203.25	H2	311.25	40	623.25
E10	210.25	H3	319.25	41	631.25
E11	217.25	H4	327.25	42	639.25
E12	224.25	H5	335.25	43	647.25
R1	49.75	H6	343.25	44	655.25
R2	59.25	H7	351.25	45	663.25
R3	77.25	H8	359.25	46	671.25
R4	85.25	H9	367.25	47	679.25
R5	93.25	H10	375.25	48	687.25
R6	175.25	H11	383.25	49	695.25
R7	183.25	H12	391.25	50	703.25
R8	191.25	H13	399.25	51	711.25
R9	199.25	H14	407.25	52	719.25
R10	207.25	H15	415.25	53	727.25
R11	215.25	H16	423.25	54	735.25
R12	223.25	H17	431.25	55	743.25
S1	105.25	H18	439.25	56	751.25
S2	112.25	H19	447.25	57	759.25
S3	119.25	21	471.25	58	767.25
S4	126.25	22	479.25	59	775.25
S5	133.25	23	487.25	60	783.25
S6	140.25	24	495.25	61	791.25
S7	147.25	25	503.25	62	799.25
S8	154.25	26	511.25	63	807.25
S9	161.25	27	519.25	64	815.25
S10	168.25	28	527.25	65	823.25
S11	231.25	29	535.25	66	831.25
S12	238.25	30	543.25	67	839.25
S13	245.25	31	551.25	68	839.25
S14	252.25	32	559.25	69	855.25

### FRANCE

CANAL	FREQ (MHz)
2	55.75
3	60.50
4	63.75
5	176.0
6	184.0
7	192.0
8	200.0
9	208.0
10	216.0
B	116.75
C	128.75
D	140.75
E	159.75
F	164.75
G	176.75
H	188.75
I	200.75
J	212.75
K	224.75
L	236.75
M	248.75
N	260.75
O	272.75
P	284.75
Q	296.75

### ITALY

CANALE	FREQ (MHz)
A	53.75
B	62.25
C	82.25
D	175.25
E	183.75
F	192.25
G	201.25
H	210.25
H1	217.25

## Information for users in the UK *(not applicable outside the UK)*

### Positioning the TV

For the best results, choose a position where light does not fall directly on the screen, and at some distance away from radiators or other sources of heat. Leave a space of at least 5 cm all around the TV for ventilation, making sure that curtains, cupboards etc. cannot obstruct the air flow through the ventilation apertures. The TV is intended for use in a domestic environment only and should never be operated or stored in excessively hot or humid atmospheres.

### General Points

Please take note of the section entitled 'Tips' at the end of this booklet.

### Interference

The Department of Trade and Industry operates a Radio Interference Investigation Service to help TV licence holders improve reception of BBC and IBA programmes where they are being spoilt by interference.

If your dealer cannot help, ask at a main Post Office for the booklet "How to Improve Television and Radio Reception".

### Mains connection

Before connecting the TV to the mains, check that the mains supply voltage corresponds to the voltage printed on the type plate on the rear panel of the TV. If the mains voltage is different, consult your dealer.

### Important

This apparatus is fitted with an approved moulded 13AMP plug. Should it become necessary to replace the mains fuse, this must be replaced with a fuse of the same value as indicated on the plug.

1. Remove fuse cover and fuse.
2. The replacement fuse must comply with BS 1362 and have the ASTA approval mark. If the fuse is lost, make contact with your retailer in order to verify the correct type.
3. Refit the fuse cover.

In order to maintain conformity to the EMC directive, the mains plug on this product must not be removed.

### Connecting the aerial

The aerial should be connected to the socket marked  at the back of the set. An inferior aerial is likely to result in a poor, perhaps unstable picture with ghost images and lack of contrast. Make-shift loft or set-top aerials are often inadequate. Your dealer will know from experience the most suitable type for your locality. Should you wish to use the set in conjunction with other equipment, which connects to the aerial socket such as TV games, or a video camera it is recommended that these be connected via a combiner unit to avoid repeated connection and disconnection of the aerial plug.

### Fitting the stand (if provided)

Use only the stand provided with the set, making sure that the fixings are properly tightened. A diagram showing how to assemble the stand is packed with the stand. Never use a make-shift stand, or legs fixed with woodscrews.



Specifications are subject to change without notice.  
Trademarks are the property of Koninklijke Philips Electronics N.V. or their respective owners.  
2005 © Koninklijke Philips Electronics N.V. All rights reserved.

[www.philips.com](http://www.philips.com)



3139 125 35731