



**TYPE-E SUBWOOFER
HAUT-PARLEUR D'EXTREMES GRAVES TYPE-E
APPLICATION GUIDE
GUIDE D'APPLICATION**

SWE-1243E

12 Inch High Performance Subwoofer (4Ω)
Haut-parleur 30 cm d'extrêmes graves haute performance (4Ω)

SWE-1043E

10 Inch High Performance Subwoofer (4Ω)
Haut-parleur 25 cm d'extrêmes graves haute performance (4Ω)

SWE-843E

8 Inch High Performance Subwoofer (4Ω)
Haut-parleur 20 cm d'extrêmes graves haute performance (4Ω)

Subwoofer Features and Specifications	
Features	
Size	
Power Handling (RMS/peak)	
Power Range (RMS)	
Frequency Response	
Diaphragm	Material Design
Surround	Material Design
Spider	Material Design
Voice Coil	Material Design
Motor Structure	Pole Geometry Configuration Magnet
Frame	Material Design
Terminals	Layout Design
Tinsel Leads	Design
Gasket	Design
Enclosure Information	
Mounting Depth	
Mounting Diameter - Front Mount	
Added Volume - Reverse Mount**	
Displacement - Front Mounted**	
Displacement - Rear Mounted**	
Recommended Box Types (S)Sealed/(V)Vented/(BP)Bandpass	
Sealed Box Volume Range	
Optimum Sealed Box Volume	
Vented Box Volume Range	
Optimum Vented Box Volume	
Vent Diameter/Length	
Usable Q-Logic Box Types	
Optimum Q-Logic Box Type	
Electro-Mechanical Parameters #	
Nominal Impedance	
Frequency Response	
Sensitivity (SPL@1W/1m)*	
D.C Coil Resistance (Re)	
Inductance (Le) 1kHz/20kHz	
Free Air Resonance (Fs)	
Equivalent Stiffness (Vas)	
Mechanical Q (Qms)	
Electrical Q (Qes)	
Total Q (Qts)	
Linear Excursion [(Hvc-Hag)/2], One-Way (Xmax)	
Magnetic Linear Excursion, One-Way (Xmag)	
Mechanical Excursion, Peak-to-Peak	
Gap Height (Hag)	
Coil Height (Hvc)	
Cone Area (Sd)	
Voice Coil Diameter	
Magnet Weight	

Type-E		
SWE-843E	SWE-1043E	SWE-1243E
8"	10"	12"
120W/400W	150W/500W	250W/800W
50W-120W	50W-150W	50W-250W
34Hz-1.5kHz	33Hz-1kHz	28Hz-1kHz
Drenched Long-Fibre Pulp, Polypropylene Reinforced		
2 Piece Parabolic		
Butyl Rubber		
High Excursion, Half Roll		
Carbonized Nomex®		
Single High Linear, Back Vented		
High Temp Copper Wire, ASV Former		
Dual Layer		
Optimized Conventional		
Extended Pole with Laminar Flow Vent		
Double Stack Y-30 HQ-Strontium		
Heavy Gauge Steel, Titanium Powder Coated		
Deep Diver® with Wind Tunnels		
One Side		
Gun-Metal Finish 5-Way Binding Posts with Lock-Nuts		
Woven Ultrafine Liz Wire, Black Silicone Insulated		
Injection Moulded Rubber, Hidden Screw Design, Front / Rear Sealing		
111 mm (4.4")	139 mm (5.5")	169 mm (6.7")
183 mm (7.2")	235 mm (9.3")	282 mm (11.1")
0.7 L (0.02 ft³)	1.1 L (0.039 ft³)	1.6 L (0.056 ft³)
1.1 L (0.04")	1.9 L (0.067 ft³)	2.8 L (0.099 ft³)
1.5 L (0.05")	2.4 L (0.085 ft³)	3.5 L (0.124 ft³)
S/V/BP		
10 - 19 L (0.35 - 0.67 ft³)	20 - 27 L (0.71 - 0.95 ft³)	28 - 40 L (0.99 - 1.41 ft³)
15 L (0.53 ft³)	24 L (0.85 ft³)	35 L (1.24 ft³)
15 - 30 L (0.53 - 1.06 ft³)	25 - 35 L (0.88 - 1.24 ft³)	32 - 58 L (1.13 - 2.05 ft³)
22 L (0.78 ft³)	28 L (0.99 ft³)	39 L (1.38 ft³)
7 / 29 cm (3" / 11.4")	7 / 27 cm (2.8 / 10.6")	7 / 23 cm (2.8 / 9.1")
TBA		
TBA		
4 Ω	4 Ω	4 Ω
34 Hz - 1.5 kHz	33 - 1 KHz	28 - 1 KHz
87 dB	88.4 dB	89.8 dB
3.6 Ω	3.6 Ω	3.6 Ω
1.17 / 0.30 mH	1.17 / 0.30 mH	1.02 mH / 0.24 mH
34 Hz	33 Hz	28 Hz
33.4 L	65 L (2.30 ft³)	75 L (2.65 ft³)
5,1	4.06	3.27
0,46	0.37	0.43
0,42	0.34	0.38
8 mm	8 mm	10 mm
19 mm	19 mm	23 mm
38 mm	42 mm	50 mm
8 mm	8 mm	10 mm
22 mm	22 mm	30 mm
216 cm²	346 cm²	502 cm²
38 mm (1.5")	38 mm (1.5")	50 mm (2")
57 oz (1.62 kg)	57 oz (1.62 kg)	104 oz (2.95 Kg)

Note: All specifications are subject to change without notice

All T/S parameters measured/calculated after break-in.

* This commonly misunderstood specification should not be used as a reference for subwoofer output capability.

** Based upon 3/4" (19mm) baffle thickness, with opening cut approximately to gasket inner diameter

Caractéristiques et spécifications Caractéristiques	
Features	
Taille	
Puissance admissible (efficace / crête)	
Plage de puissance (efficace)	
Réponse en fréquence (Hz)	
Membrane	Matériau Conception
Suspension	Matériau Conception
Centreur	Matériau Conception
Bobine	Matériau Conception
Moteur	Géométrie de pièce polaire Configuration Aimant
Bâti	Matériau Conception
Bornes	Répartition Conception
Fils conducteurs	Conception
Joint d'étanchéité	Conception
Enciente	
Profondeur de montage	
Diamètre de montage - montage avant	
Volume ajouté - montage inversé**	
Déplacement - montage avant**	
Déplacement - montage arrière**	
Types d'enceintes recommandés - (C)close / (É)évent / (PB)passer-bande	
Plage de volume - enceinte close	
Volume optimal - enceinte close	
Plage de volume - enceinte à événement	
Volume optimal - enceinte à événement	
Diamètre / longueur de l'évent	
Usable Q-Logic Box Types	
Optimum Q-Logic Box Type	
Paramètres électromécaniques #	
Impédance nominale	
Réponse en fréquence	
Sensibilité (NPA@1W/1m)*	
Résistance CC de la bobine (Re)	
Inductance (Le) 1KHz/20KHz	
Résonance à l'air libre (Fs)	
Radiateur équivalente (Vas)	
Q mécanique (Qms)	
Q électrique (Qes)	
Q total (Qts)	
Déplacement linéaire [(Hvc-Hag)/2], un sens (Xmax)	
Déplacement linéaire magnétique, un sens (Xmag)	
Déplacement mécanique, crête à crête	
Hauteur de l'écartement (Hag)	
Hauteur de la bobine (Hvc)	
Surface du diaphragme (Sd)	
Diamètre de la bobine	
Poids de l'aimant	

Type-E		
SWE-843E	SWE-1043E	SWE-1243E
8"	10"	12"
120W/400W	150W/500W	250W/800W
50W-120W	50W-150W	50W-250W
34Hz-1.5kHz	33Hz-1kHz	28Hz-1kHz
Longues fibres trempées, renforcées de polypropylène		
Parabolique 2 pièces		
Suspension Butyl		
Demi rouleau à haute excursion		
Carbonized Nomex®		
Ventilation arrière simple linéaire		
Fil cuivre haute température, conception ASV		
Double couche		
Conventionnel Optimisé		
Pole étendu avec évent laminaire		
Double construction Y-30 au Strontium		
Châssis acier, revêtu de poudre de titane		
Deep Diver® avec tunnels d'aération		
Simple face		
Connecteurs 5 voies finition brossée à clipage		
Fil ultra fin tressé en toron, isolé au silicone noir		
Joint injecté moulé, conception à vis cachées, étanchéité avant/arrière		
111 mm (4.4")	139 mm (5.5")	169 mm (6.7")
183 mm (7.2")	235 mm (9.3")	282 mm (11.1")
0.7 L (0.02 ft³)	1.1 L (0.039 ft³)	1.6 L (0.056 ft³)
1.1 L (0.04")	1.9 L (0.067 ft³)	2.8 L (0.099 ft³)
1.5 L (0.05")	2.4 L (0.085 ft³)	3.5 L (0.124 ft³)
C/E/PB		
10 - 19 L (0.35 - 0.67 ft³)	20 - 27 L (0.71 - 0.95 ft³)	28 - 40 L (0.99 - 1.41 ft³)
15 L (0.53 ft³)	24 L (0.85 ft³)	35 L (1.24 ft³)
15 - 30 L (0.53 - 1.06 ft³)	25 - 35 L (0.88 - 1.24 ft³)	32 - 58 L (1.13 - 2.05 ft³)
22 L (0.78 ft³)	28 L (0.99 ft³)	39 L (1.38 ft³)
7 / 29 cm (3" / 11.4")	7 / 27 cm (2.8 / 10.6")	7 / 23 cm (2.8 / 9.1")
À communiquer		
À communiquer		
4 Ω	4 Ω	4 Ω
34 Hz - 1.5 kHz	33 - 1 KHz	28 - 1 KHz
87 dB	88.4 dB	89.8 dB
3.6 Ω	3.6 Ω	3.6 Ω
1.17 / 0.30 mH	1.17 / 0.30 mH	1.02 mH / 0.24 mH
34 Hz	33 Hz	28 Hz
33.4 L	65 L (2.30 ft³)	75 L (2.65 ft³)
5,1	4.06	3.27
0,46	0.37	0.43
0,42	0.34	0.38
8 mm	8 mm	10 mm
19 mm	19 mm	23 mm
38 mm	42 mm	50 mm
8 mm	8 mm	10 mm
22 mm	22 mm	30 mm
216 cm²	346 cm²	502 cm²
38 mm (1.5")	38 mm (1.5")	50 mm (2")
57 oz (1.62 kg)	57 oz (1.62 kg)	104 oz (2.95 Kg)

Remarque: Les spécifications peuvent changer sans préavis.

Paramètres T/S mesurés/calculés après rodage.

* Ne pas utiliser cette spécification souvent mal comprise comme référence pour la puissance du haut-parleur d'extrêmes graves.

** Panneau de 0.75 po (19 mm) d'épaisseur, ouverture correspondant environ au diamètre intérieur du joint d'étanchéité.

ALPINE SWE-1243E 30 cm Subwoofer

ENCLOSURE RECOMMENDATIONS

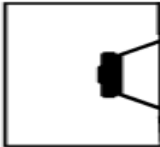
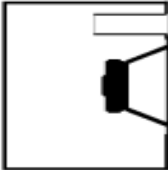
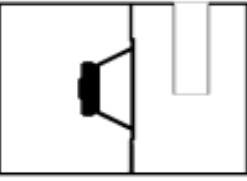
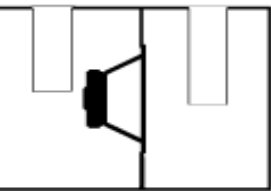
box type	woofer-displacement:	2,8 Liter		
	optimisation for:	loud	normal	low / definition
sealed 	net box volume [Liter] *	-	25	34
	free field SPL at 90 Hz [dB/Wm]	-	89,5	89,2
	mech. power handling [Watt RMS]	-	200	200
	low cut frequency (free field) Flow [Hz]	-	40	36
vented 	net box volume [Liter] *+**	32	32	55
	port diameter x length [cm]	10 x 26	7 x 21	10 x 34
	free field SPL at 90 Hz [dB/Wm]	92	90,3	89,5
	mech. power handling [Watt RMS]	200	200	230
	high cut frequency for subsonic filter[Hz]	28	25	24
	power handling with subsonic filter [W]	300	300	300
	low cut frequency (free field) Flow [Hz]	42	35	27
single vented band pass  V 1 V 2	net box volume [Liter] * V1	-	19	30
	net box volume [Liter] ** V2	-	19	18
	port diameter x length [cm] in V2	-	2 pc. 10 x 34	3 pc. 7 x 39
	free field SPL at 90 Hz [dB/Wm]	-	91	88
	mech. power handling [Watt RMS]	-	250	250
	low cut frequency (free field) Flow [Hz]	-	36	27
double vented band pass  V 1 V 2	net box volume [Liter] * + ** V1	25	37	45
	port diameter x length [cm] in V1	7 x 32	7 x 25	7 x 36
	net box volume [Liter] ** V2	24	23	23
	port diameter x length [cm] in V2	2 pc. 10 x 20	2 pc. 10 x 27	2 pc. 10 x 36
	free field SPL at 90 Hz [dB/Wm]	93,3	91,6	90
	mech. power handling [Watt RMS]	250	250	275
	high cut frequency for subsonic filter[Hz]	22	22	15
	power handling with subsonic filter [W]	300	300	300
	low cut frequency (free field) Flow [Hz]	43	34	26

*) : add additional 2,8 L for woofer!

**) : calculate and add volume displacement of port(s)

formula: outer diameter [dm] square times 3,14 divided by 4, times length [dm]

ports should be rounded (aeroports)! In cases where round tubes don't fit, channels with same cross-section (rounded at both ends) may be built.

damping: sealed encl. Fill loosely with poly-padding, vented encl.: 2 walls covered by acoustic foam.

enclosure wall thickness: MDF/Multilayer: 19 to 22 mm. Woofer screwed by metric thread knock-in nuts.

Subsonic-Filter: high pass filter of 3rd order or higher

mounting size:

mounting hole diameter:	282 mm	
mounting depth:	169 mm	
magnet diameter:	156 mm	
recomm. freeplay behind magnet:	> 20 mm	
if flange gets lowered into baffle:	without -	with rubber gasket
grinding diameter:	306 mm	312 mm
grinding depth:	14 mm	16 mm

ALPINE SWE-1243E 30 cm Subwoofer

CAISSONS RECOMMANDÉS

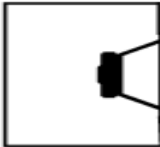
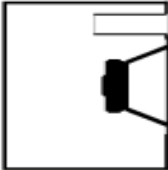
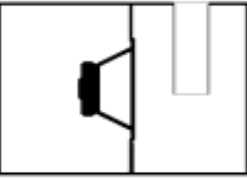
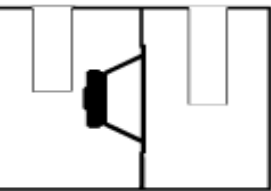
type de caisson	volumé du woofér optimisation pour :	2,8 Litres		
		fort	normal	bas/précis
clos 	Volume net [Litre] *	-	25	34
	Libre champ SPL à 90 Hz [dB/Wm]	-	89,5	89,2
	Tenue en puissance [Watt RMS]	-	200	200
	Fréquence de résonnance [Hz]	-	40	36
bass-reflex 	Volume net [Litre] *+**	32	32	55
	Diamètre et longueur de l'évent [cm]	10 x 26	7 x 21	10 x 34
	free field SPL at 90 Hz [dB/Wm]	92	90,3	89,5
	Tenu en puissance [Watt RMS]	200	200	230
	Fréquence de coupure haute pour filtre subsonic	28	25	24
	Tenue en puissance avec filtre subsonic [W]	300	300	300
	Fréquence de résonnance [Hz]	42	35	27
band-pass simple événement  V 1 V 2	Volume net [Litre] * V1	-	19	30
	Volume net [Litre] ** V2	-	19	18
	Diamètre et longueur de l'évent [cm] en V2	-	2 pc. 10 x 34	3 pc. 7 x 39
	Libre champ SPL à 90 Hz [dB/Wm]	-	91	88
	Tenue en puissance [Watt RMS]	-	250	250
	Fréquence de résonnance [Hz]	-	36	27
band-pass double événement  V 1 V 2	Volume net [Litre] * + ** V1	25	37	45
	Diamètre et longueur de l'évent [cm] en V1	7 x 32	7 x 25	7 x 36
	Volume net [Litre] ** V2	24	23	23
	Diamètre et longueur de l'évent [cm] en V2	2 pc. 10 x 20	2 pc. 10 x 27	2 pc. 10 x 36
	Libre champ SPL à 90 Hz [dB/Wm]	93,3	91,6	90
	Tenue en puissance [Watt RMS]	250	250	275
	Fréquence de coupure haute pour filtre subsonic	22	22	15
	Tenue en puissance avec filtre subsonic [W]	300	300	300
Fréquence de résonnance [Hz]	43	34	26	

*) : ajouter 2,8L pour le boomer!

**) : calculer et ajouter le volume de (des) événement(s)

formule: diamètre extérieur [dm] au carré fois 3,14 divisé par 4, fois la longueur [dm]

les événements doivent être ronds ! si les événements ne vont pas,

des canaux à section similaire (ronds aux extrémités) peuvent être construits.

garnitures : pour caisson clos, remplir partiellement, pour caisson bass-reflex, couvrir 2 pans de mousse acoustique.

épaisseur des cloisons du caisson : MDF/Multicouche de 19 à 22mm. Boomer vissé.

Filtre subsonic: filtre passe-haut du 3^e ordre ou supérieur

Dimensions de montage :

Diamètre de montage	282 mm	
Profondeur de montage	169 mm	
Diamètre de l'aimant	156 mm	
Espace recommandé derrière l'aimant	> 20 mm	
Si le rebord descend dans l'enceinte	Sans -	Avec le joint
Diamètre de rognage	306 mm	312 mm
Profondeur de rognage	14 mm	16 mm

ALPINE SWE-1043E 25 cm Subwoofer

ENCLOSURE RECOMMENDATIONS

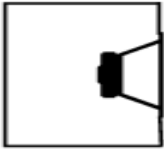
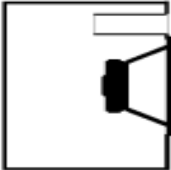
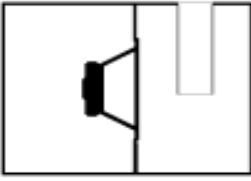
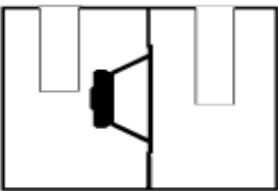
box type	woofer-displacement:	1,9 Liter		
	optimisation for:	loud	normal	low / definition
sealed 	net box volume [Liter] *	-	15	23
	free field SPL at 90 Hz [dB/Wm]	-	88	88
	mech. power handling [Watt RMS]	-	125	100
	low cut frequency (free field) Flow [Hz]	-	43	38
vented 	net box volume [Liter] *+**	20	25	38
	port diameter x length [cm]	7 x 25	7 x 24	7 x 25
	free field SPL at 90 Hz [dB/Wm]	90	89	87,5
	mech. power handling [Watt RMS]	100	100	125
	high cut frequency for subsonic filter[Hz]	28	26	22
	power handling with subsonic filter [W]	150	150	150
	low cut frequency (free field) Flow [Hz]	40	35	27
single vented band pass  V 1 V 2	net box volume [Liter] * V1	-	16	20
	net box volume [Liter] ** V2	-	15	14
	port diameter x length [cm] in V2	-	10 x 27	10 x 35
	free field SPL at 90 Hz [dB/Wm]	-	89	87,5
	mech. power handling [Watt RMS]	-	150	150
	low cut frequency (free field) Flow [Hz]	-	36	30
double vented band pass  V 1 V 2	net box volume [Liter] * + ** V1	25	25	34
	port diameter x length [cm] in V1	5 x 19	5 x 35	5 x 29
	net box volume [Liter] ** V2	20	15	14
	port diameter x length [cm] in V2	10 x 17	10 x 25	10 x 34
	free field SPL at 90 Hz [dB/Wm]	91	88,7	87,2
	mech. power handling [Watt RMS]	125	150	150
	high cut frequency for subsonic filter[Hz]	24	15	15
	power handling with subsonic filter [W]	150	150	150
	low cut frequency (free field) Flow [Hz]	35	30	24

*) : add additional 1,9 L for woofer!

**) : calculate and add volume displacement of port(s)

formula: outer diameter [dm] square times 3,14 divided by 4, times length [dm]

ports should be rounded (aeroports)! In cases where round tubes don't fit, channels with same cross-section (rounded at both ends) may be built.

damping: sealed encl. Fill loosely with poly-padding, vented encl.: 2 walls covered by acoustic foam.

enclosure wall thickness: MDF/Multilayer: 19 to 22 mm. Woofer screwed by metric thread knock-in nuts.

Subsonic-Filter: high pass filter of 3rd order or higher

mounting size:

mounting hole diameter:	235 mm	
mounting depth:	139 mm	
magnet diameter:	134 mm	
recomm. freeplay behind magnet:	> 20 mm	
if flange gets lowered into baffle:	without -	with rubber gasket
grinding diameter:	256 mm	262 mm
grinding depth:	14 mm	16 mm

ALPINE SWE-1043E 25 cm Subwoofer

CAISSONS RECOMMANDÉS

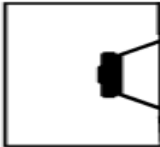
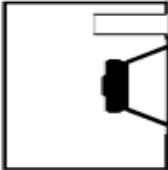
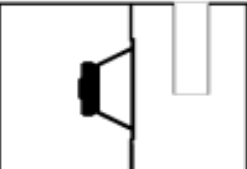
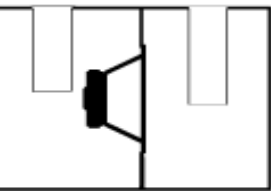
type de caisson	volumé du woofér optimisation pour :	1,9 Litres		
		fort	normal	bas/précis
clos 	Volume net [Litre] *	-	15	23
	Libre champ SPL à 90 Hz [dB/Wm]	-	88	88
	Tenue en puissance [Watt RMS]	-	125	100
	Fréquence de résonnance [Hz]	-	43	38
bass-reflex 	Volume net [Litre] *+**	20	25	38
	Diamètre et longueur de l'évén [cm]	7 x 25	7 x 24	7 x 25
	free field SPL at 90 Hz [dB/Wm]	90	89	87,5
	Tenu en puissance [Watt RMS]	100	100	125
	Fréquence de coupure haute pour filtre subsonic	28	26	22
	Tenue en puissance avec filtre subsonic [W]	150	150	150
	Fréquence de résonnance [Hz]	40	35	27
band-pass simple événement  V 1 V 2	Volume net [Litre] * V1	-	16	20
	Volume net [Litre] ** V2	-	15	14
	Diamètre et longueur de l'évén [cm] en V2	-	10 x 27	10 x 35
	Libre champ SPL à 90 Hz [dB/Wm]	-	89	87,5
	Tenue en puissance [Watt RMS]	-	150	150
	Fréquence de résonnance [Hz]	-	36	30
band-pass double événement  V 1 V 2	Volume net [Litre] * + ** V1	25	25	34
	Diamètre et longueur de l'évén [cm] en V1	5 x 19	5 x 35	5 x 29
	Volume net [Litre] ** V2	20	15	14
	Diamètre et longueur de l'évén [cm] en V2	10 x 17	10 x 25	10 x 34
	Libre champ SPL à 90 Hz [dB/Wm]	91	88,7	87,2
	Tenue en puissance [Watt RMS]	125	150	150
	Fréquence de coupure haute pour filtre subsonic	24	15	15
	Tenue en puissance avec filtre subsonic [W]	150	150	150
Fréquence de résonnance [Hz]	35	30	24	

*) : ajouter 1,9L pour le boomer!

**) : calculer et ajouter le volume de (des) événement(s)

formule: diamètre extérieur [dm] au carré fois 3,14 divisé par 4, fois la longueur [dm]

les événements doivent être ronds ! si les événements ne vont pas,

des canaux à section similaire (ronds aux extrémités) peuvent être construits.

garnitures : pour caisson clos, remplir partiellement, pour caisson bass-reflex, couvrir 2 pans de mousse acoustique.

épaisseur des cloisons du caisson : MDF/Multicouche de 19 à 22mm. Boomer vissé.

Filtre subsonic: filtre passe-haut du 3^e ordre ou supérieur

Dimensions de montage :

Diamètre de montage	235 mm	
Profondeur de montage	139 mm	
Diamètre de l'aimant	134 mm	
Espace recommandé derrière l'aimant	> 20 mm	
Si le rebord descend dans l'enceinte	Sans -	Avec le joint
Diamètre de rognage	256 mm	262 mm
Profondeur de rognage	14 mm	16 mm

ALPINE SWE-843E 20 cm Subwoofer

ENCLOSURE RECOMMENDATIONS

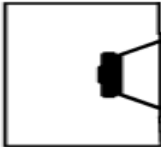
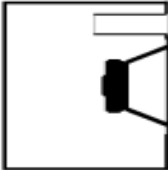
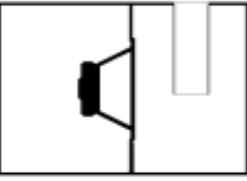
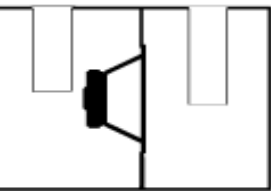
box type	woofer-displacement:	0,9 Liter		
	optimisation for:	loud	normal	low / definition
sealed 	net box volume [Liter] *	-	10	15
	free field SPL at 90 Hz [dB/Wm]	-	87	86,5
	mech. power handling [Watt RMS]	-	100	130
	low cut frequency (free field) Flow [Hz]	-	45	38
vented 	net box volume [Liter] *+**	15	20	25
	port diameter x length [cm]	5 x 17	6 x 23	6 x 22
	free field SPL at 90 Hz [dB/Wm]	89	88	87
	mech. power handling [Watt RMS]	100	100	100
	high cut frequency for subsonic filter[Hz]	30	28	27
	power handling with subsonic filter [W]	130	130	130
	low cut frequency (free field) Flow [Hz]	40	34	30
single vented band pass  V 1 V 2	net box volume [Liter] * V1	-	9	13
	net box volume [Liter] ** V2	-	9	10
	port diameter x length [cm] in V2	-	8,5 x 25	8,5 x 29
	free field SPL at 90 Hz [dB/Wm]	-	88,5	87
	mech. power handling [Watt RMS]	-	130	130
	low cut frequency (free field) Flow [Hz]	-	38	33
double vented band pass  V 1 V 2	net box volume [Liter] * + ** V1	13	15	20
	port diameter x length [cm] in V1	5 x 23	5 x 27	5 x 23
	net box volume [Liter] ** V2	11	11	11
	port diameter x length [cm] in V2	10 x 20	8,5 x 16	10 x 29
	free field SPL at 90 Hz [dB/Wm]	91,5	90	89
	mech. power handling [Watt RMS]	100	100	100
	high cut frequency for subsonic filter[Hz]	29	27	25
	power handling with subsonic filter [W]	130	130	130
	low cut frequency (free field) Flow [Hz]	45	40	34

*) : add additional 1,9 L for woofer!

**) : calculate and add volume displacement of port(s)

formula: outer diameter [dm] square times 3,14 divided by 4, times length [dm]

ports should be rounded (aeroports)! In cases where round tubes don't fit, channels with same cross-section (rounded at both ends) may be built.

damping: sealed encl. Fill loosely with poly-padding, vented encl.: 2 walls covered by acoustic foam.

enclosure wall thickness: MDF/Multilayer: 19 to 22 mm. Woofer screwed by metric thread knock-in nuts.

Subsonic-Filter: high pass filter of 3rd order or higher

mounting size:

mounting hole diameter:	183 mm
mounting depth:	111 mm
magnet diameter:	134 mm
recomm. freeplay behind magnet:	> 20 mm
if flange gets lowered into baffle:	without - with rubber gasket
grinding diameter:	206 mm 212 mm
grinding depth:	14 mm 16 mm

ALPINE SWE-843E 20 cm Subwoofer

CAISSONS RECOMMANDÉS

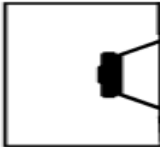
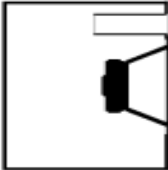
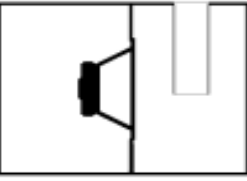
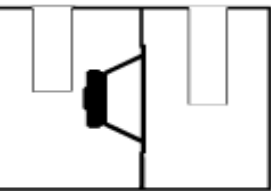
type de caisson	volumé du woofér optimisation pour :	0,9 Litres		
		fort	normal	bas/précis
clos 	Volume net [Litre] *	-	10	15
	Libre champ SPL à 90 Hz [dB/Wm]	-	87	86,5
	Tenue en puissance [Watt RMS]	-	100	130
	Fréquence de résonnance [Hz]	-	45	38
bass-reflex 	Volume net [Litre] *+**	15	20	25
	Diamètre et longueur de l'évent [cm]	5 x 17	6 x 23	6 x 22
	free field SPL at 90 Hz [dB/Wm]	89	88	87
	Tenu en puissance [Watt RMS]	100	100	100
	Fréquence de coupure haute pour filtre subsonic	30	28	27
	Tenue en puissance avec filtre subsonic [W]	130	130	130
	Fréquence de résonnance [Hz]	40	34	30
band-pass simple événement  V 1 V 2	Volume net [Litre] * V1	-	9	13
	Volume net [Litre] ** V2	-	9	10
	Diamètre et longueur de l'évent [cm] en V2	-	8,5 x 25	8,5 x 29
	Libre champ SPL à 90 Hz [dB/Wm]	-	88,5	87
	Tenue en puissance [Watt RMS]	-	130	130
	Fréquence de résonnance [Hz]	-	38	33
band-pass double événement  V 1 V 2	Volume net [Litre] * + ** V1	13	15	20
	Diamètre et longueur de l'évent [cm] en V1	5 x 23	5 x 27	5 x 23
	Volume net [Litre] ** V2	11	11	11
	Diamètre et longueur de l'évent [cm] en V2	10 x 20	8,5 x 16	10 x 29
	Libre champ SPL à 90 Hz [dB/Wm]	91,5	90	89
	Tenue en puissance [Watt RMS]	100	100	100
	Fréquence de coupure haute pour filtre subsonic	29	27	25
	Tenue en puissance avec filtre subsonic [W]	130	130	130
Fréquence de résonnance [Hz]	45	40	34	

*) : ajouter 1,9L pour le boomer!

**) : calculer et ajouter le volume de (des) événement(s)

formule: diamètre extérieur [dm] au carré fois 3,14 divisé par 4, fois la longueur [dm]

les événements doivent être ronds ! si les événements ne vont pas,

des canaux à section similaire (ronds aux extrémités) peuvent être construits.

garnitures : pour caisson clos, remplir partiellement, pour caisson bass-reflex, couvrir 2 pans de mousse acoustique.

épaisseur des cloisons du caisson : MDF/Multicouche de 19 à 22mm. Boomer vissé.

Filtre subsonic: filtre passe-haut du 3^e ordre ou supérieur

Dimensions de montage :

Diamètre de montage	183 mm	
Profondeur de montage	111 mm	
Diamètre de l'aimant	134 mm	
Espace recommandé derrière l'aimant	> 20 mm	
Si le rebord descend dans l'enceinte	Sans -	Avec le joint
Diamètre de rognage	206 mm	212 mm
Profondeur de rognage	14 mm	16 mm

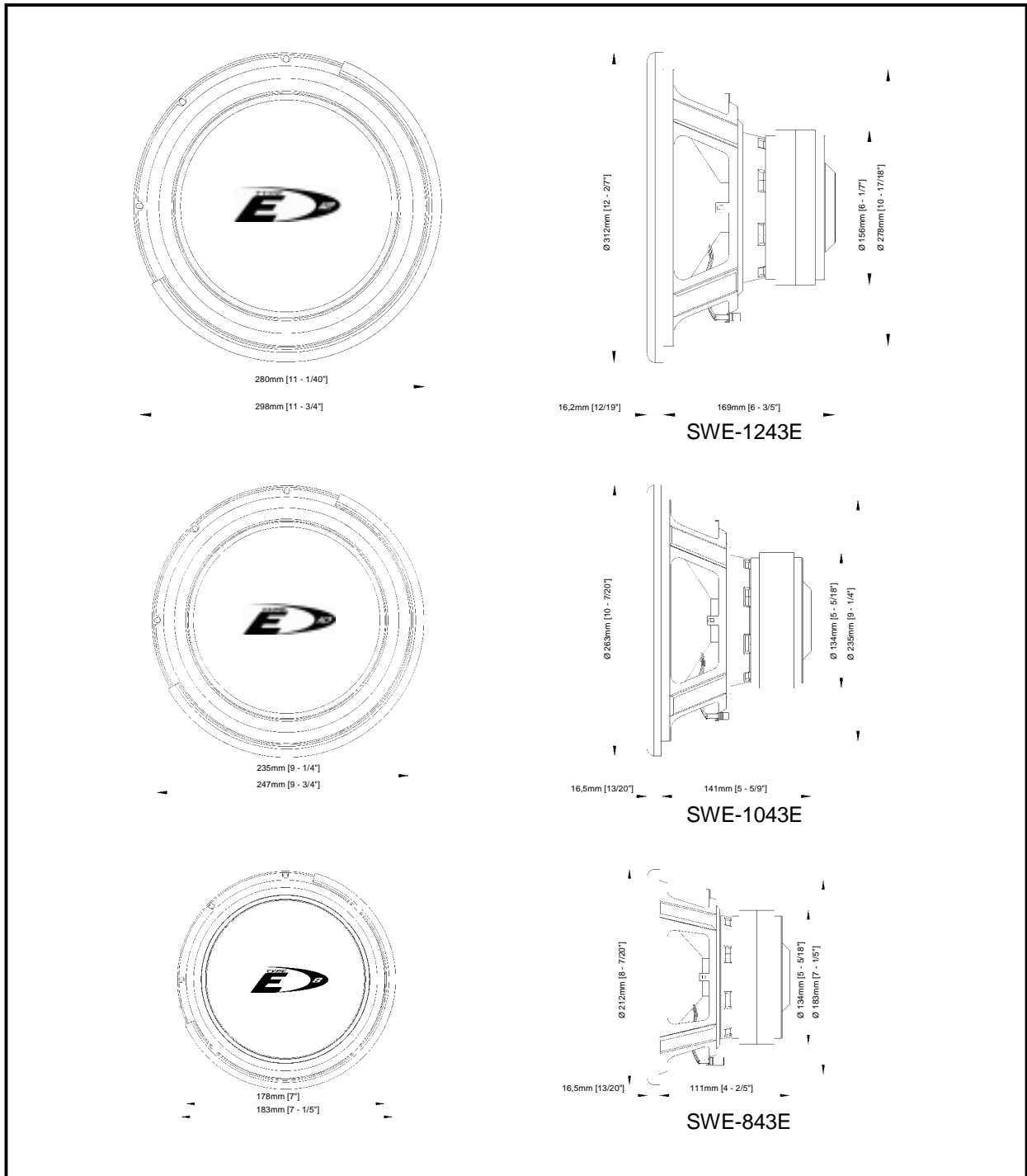

RECOMMENDED AMPLIFIERS / AMPLIFICATEURS RECOMMANDES	SWE-1243E		SWE-1043E		SWE-843E	
	x1	x2	x1	x2	x1	x2
PDX-1.1000 (1000W RMS @ 4Ω / 1000W RMS @ 2Ω)	•	•	•	•	•	•
PDX-1.600 (600W RMS @ 4Ω / 600W RMS @ 2Ω)	•	••••	•	•	•	•
MRP-M850 (500W RMS @ 4Ω / 800W RMS @ 2Ω)	••	••	•	•	•	•
MRP-M650 (400W RMS @ 4Ω / 600W RMS @ 2Ω)	••••	••••	••	••	••	••
MRP-M450 (220W RMS @ 4Ω / 400W RMS @ 2Ω)	•••	••	•••	••••	•••	••••
MRP-M352 (200W RMS @ 4Ω / 350W RMS @ 2Ω)	•••	•	••••	•••	••••	•••

Ideal / Idéal ••••
 Recommended / Reconnané •••
 Suitable / Convenable ••
 Feasible / Peu recommandé •



ALPINE ELECTRONICS, INC.
Tokyo office: 1-1-8 Nishi Gotanda,
Shinagawa-ku, Tokyo 141-0031, Japan
Tel. 03-3494-1101

ALPINE ELECTRONICS MARKETING, INC.
1-1-8 Nishi Gotanda,
Shinagawa-ku,
Tokyo 141-0031, Japan
Tel. 03-5496-8231

ALPINE ELECTRONICS OF AMERICA, INC.
19145 Gramercy Place, Torrance,
California 90501, U.S.A.
Tel. 1-800-ALPINE-1 (1-800-257-4631)

ALPINE ELECTRONICS OF CANADA, INC.
7300 Warden Ave., Suite 203, Markham,
Ontario L3R 9Z6, Canada
Tel. 1-800-ALPINE-1 (1-800-257-4631)

ALPINE ELECTRONICS OF AUSTRALIA PTY. LTD.
6-8 Fiveways Boulevard Keysborough,
Victoria 3173, Australia
Tel. 03-9769-0000

ALPINE ELECTRONICS DE ESPAÑA, S.A.
Portal de Gamarra 36, Pabellón 32
01013 Vitoria (Álava). APDO. 133, Spain
Tel. 945-283588

ALPINE ELECTRONICS GmbH
Frankfurter Ring 117
80807 München, Germany
Tel. 089-3242640

ALPINE ELECTRONICS OF U.K. LTD.
Alpine House
Fletchamstead Highway, Coventry CV4 9TW,
United Kingdom
Tel. 0870-33 33 763

ALPINE ELECTRONICS FRANCE S.A.R.L.
(RCS PONTOISE B 338 101 280)
98, Rue de la Belle Etoile, Z.I. Paris Nord II,
B.P. 50016, 95945 Roissy Charles de Gaulle
Cedex, France
Tel. 01-48638989

ALPINE ITALIA S.p.A.
Viale C. Colombo 8,
20090 Trezzano Sul Naviglio (MI), Italy
Tel. 02-484781

ALPINE ELECTRONICS (Benelux) GmbH
Leuvensesteenweg 510-B6
1930 Zaventem, Belgium
Tel. 02-7251315

Printed in CHINA