

PHILIPS

USER MANUAL

fizz[®]
ANALOGUE



PHILIPS

Turn the phone face down

- 1** **Clip on the battery.**
Make sure it is charged first, see page 13.

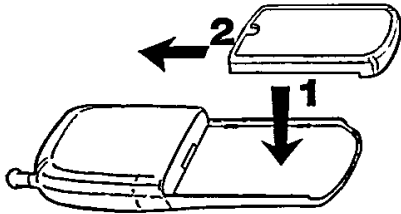

Charge a new battery (or one that has not been used for 3 months or more) for at least 24 hours before using.

Turn the phone face up

- 2** **Switch on.**
Press and hold the **1** key on the side.

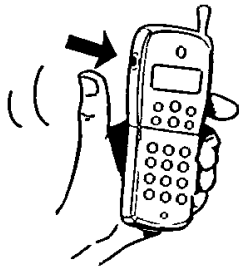

- 3** **Enter your lock code if asked**
(see "Auto lock" on page 36).
Then press **OK**. That is, press the **0** key under the displayed label **OK**.

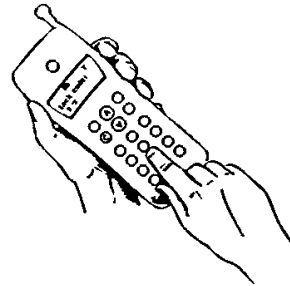

- 4** **Wait for the antenna symbol to appear.**

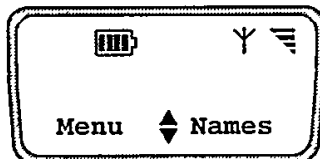

- 5** **Enter the phone number.**
If you make a mistake press **C**.



- 6** **Press Call.**
Wait for the answer and then speak.

- 7** **After the call, press End.**

Your very first call

1



Using the “soft keys”

The phone has two “soft keys” (software defined keys). The soft keys do different things at different times. A “label” on the display (just above each soft key) shows what the soft key will do.

In this book, when we say .

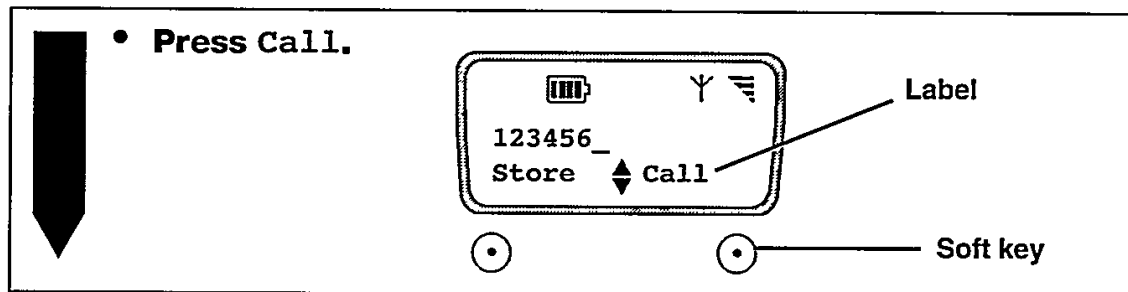

... what we mean is ...

Press the soft key under the label Call.



Glossary

The following terms are explained as they are used in this manual.

Home network

This is the network you chose when you took out your cellular service subscription. Normally this will be the network that serves your home area. When you switch on, your phone automatically tries to register with your home network (unless you are away from your home area or you have specified an alternative network).

NAM

The Number Assignment Module contains your cellular subscription and telephone number. It is set by your dealer at the time of purchase. You can if you wish have two different NAMs (NAM 1 and NAM 2), one for personal use and one for business use for example. The two NAMs can be installed at different times and by different dealers, and they can be linked to the same network or to two different networks.

Roaming

Roaming, when available, allows you to seek service from networks other than your home network. This option is not available in certain areas or countries.

Type A and Type B networks

In certain countries, roaming agreements between cellular companies allow you to alternate between “Type A” and “Type B” networks. This enables you to take advantage of different rates in different areas or to seek service from an alternate type network if your home type networks are busy or not in service.

Table of Contents

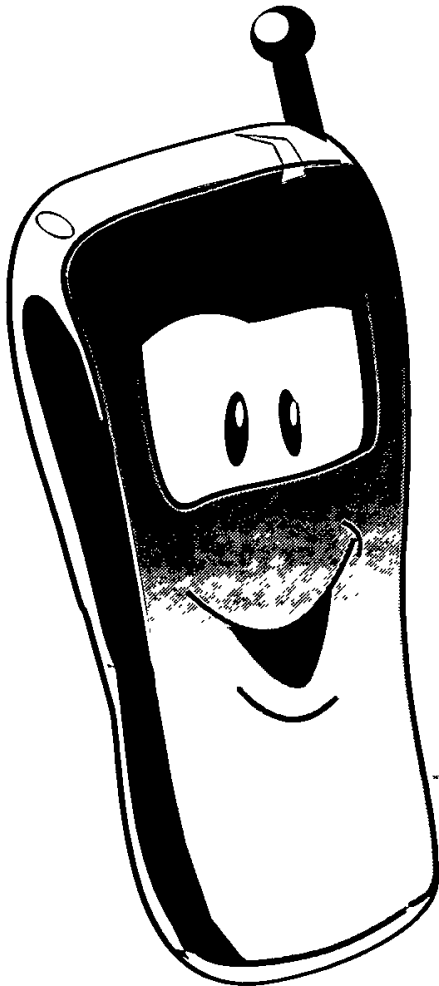

<i>Your very first call</i>	1
Using the "soft keys"	2
Glossary	2
<i>Before you start</i>	5
Radio wave safety	6
Your phone and its environment	6
Vehicles	6
Aircraft	6
Blasting areas	6
Medical equipment and hospitals	7
Explosive atmospheres	7

The efficient and safe use of your phone	7
Security	8
Responsibility	8
Respect of local laws and regulations	8
Use while driving	9
Description of the phone	10
The display	11
The battery	12
Clipping on the battery	12
Removing the battery	12
Using the charger	13
Making an emergency call	14

<i>Using your phone</i>	15
Switching on	16
Standby mode	16
Making a call	17
Answering a call	17
During a call ...	18
Adjusting the earpiece volume	18
Switching the microphone off	18
Switching the microphone on	18
Using the scratchpad	18
Redialling the last number	19
Locking the keypad	19
Unlocking the keypad	19
Switching the silent ringer on and off	20
Sending DTMF tones	20
Supplementary network services	21
Sending key sequences for network services	21
Calling Line Identification service (CLI)	22

<i>The phone book</i>	23	NAM	35
The two lists	24	Roaming	35
Adding an entry		Auto redial	35
to the Names list	24	Call meter menu	36
Directly	24	Last call	36
From the Names menu	25	Call time	36
How to enter a name	25	Show during	36
Table of characters	26	Security menu	36
Key functions for entering		Auto lock	36
a name	26	Lock code	37
How to enter a number	26	Security code	37
Short cuts into the Names list	27	Keypad lock	37
Going to the beginning		Restrictions	37
of the list	27	Accessories menu	37
Finding an entry by its name	27	Auto answer	38
Finding an entry		Complete Menu structure	38
by its position	27		
Calling from the Names list	28	<i>Maintenance</i>	39
Changing an entry		Looking after your phone	40
in the Names list	28	Trouble shooting	40
Deleting from the Names list	28		
Calling from the Redial list	29	<i>Your national guarantee</i>	41
Copying from the Redial list	29		
Deleting from the Redial list	30	<i>List of accessories</i>	43
Exiting from the phone book	30	Spare batteries	44
<i>Using the menus</i>	31	<i>Index</i>	45
Navigating	32		
The Main menu	32		
Menu numbers	32		
Short cuts into menus	32		
Short cut to standby mode	33		
Settings menu	33		
Backlight	33		
Ringer type	33		
Ring volume	33		
Key tones	33		
Any key answer	34		
Welcome text	34		
Own number(s)	34		
Battery warning signal	34		
Network menu	34		
PIN code	34		
DTMF tones	34		
Battery save	35		

The information contained in this document was correct at the time of printing. However, in order to improve its products and services, PHILIPS reserves the right to modify the specifications mentioned in this document at any time and without warning.

Copyright PHILIPS 1996 - All rights reserved.

Your cellular telephone is one of today's most sophisticated electronic products. In order to benefit fully from its wide range of functions, take the time to get to know your phone. Play with it, and look through this user guide.

Read this information before use.



Radio wave safety

Your cellular phone is a radio transmitter/receiver. When it is switched on, it transmits and receives radio waves in the frequency range 872 to 950 MHz. The network controls the power at which the phone transmits. This varies between 0.01 watts and 0.6 watts.

Public concern has been focused for some time on the possible health risks run by users of cellular telephones. The current research on radio wave technology, including cellular technology, has been reviewed and safety standards have been drawn up to ensure the protection from exposure to radio wave energy. Your cellular phone complies with all safety standards that are affixed to it.

In certain countries, the CE mark affixed to your cellular phone means that it is compliant with the European directive on electromagnetic compatibility DE RES 09025 and the low voltage directive 91/263/EEC CTR5 and CTR9.



Your phone and its environment

Inadequately protected electronic equipment may be affected by radio energy. This interference can lead to accidents. The following list gives you the most dangerous situations in which this can occur. Do not hesitate to inquire whether or not your phone can affect surrounding equipment.

Vehicles

Check with the vehicle manufacturer that electronic equipment used in your vehicle will not be affected by radio energy.

Aircraft

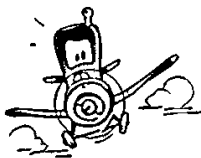

- Switch off your phone when in an aircraft. The use of cellular phones while airborne is illegal in some countries. It may disrupt the operation of the aircraft or of the cellular network. Failure to observe these instructions may lead to suspension or refusal of access to the cellular telephone network or legal action.
- Check with a member of the crew before you use the phone in or around aircraft on the ground.

Blasting areas



Switch off your phone in all areas where you are requested to turn off radio transmitting devices, such as quarries or other areas where blasting operations are in progress.

Medical equipment and hospitals



- Switch off your phone in hospitals, clinics and other health care centres where you are requested to turn off radio transmitting devices. These establishments may use equipment which is sensitive to radio energy.
- If you have any questions about the radio wave shielding of electronic medical devices which you use (pacemakers, hearing aids, etc.) do not hesitate to contact the manufacturer.

Explosive atmospheres

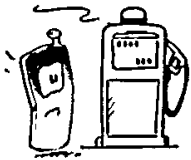

It is dangerous to use your phone in potentially explosive atmospheres!

- Switch off your phone in all areas with a potentially explosive atmosphere. These include areas which handle petrol and other inflammable chemicals (petrol stations, fuel depots, chemical plants, etc.) and also areas where the air contains dust particles, such as metal powders or seeds.
- If you will use your phone in a vehicle transporting flammable products (even if the vehicle is parked) or a vehicle powered by liquefied petroleum gas (LPG), check first that the vehicle complies with the applicable safety rules.



The efficient and safe use of your phone

Using your phone in the most efficient manner will improve the performance of your phone, reduce radio energy emission (see the section concerning radio waves in this chapter) and reduce battery consumption.

For your own safety as well as for the satisfactory operation of the phone:

- For best performance, avoid touching the antenna while a call is in progress.
- Do not use your phone with a damaged antenna. If you touch a damaged antenna, you may suffer a minor skin burn. Have a damaged antenna replaced by a qualified technician. Make sure that it is replaced only with an antenna approved by PHILIPS.
- Avoid low reception areas (in a tunnel or between tall buildings for example). In low reception areas the  symbol on the phone display shows less than the maximum of 4 bars. If possible, move to a different location.
- Do not allow metal objects (such as keys in your pocket) to short circuit the battery contacts.

- Do not use battery chargers other than those specified in the PHILIPS catalog. Use with another charger may be dangerous and will invalidate any approval given to the phone.
- Do not attempt to charge non-rechargeable batteries.
- Battery chargers are for indoor use only (they must not be exposed to moisture).



Warning:

Never use the charger socket and the accessory connector at the same time. The battery charger supplied with your phone will be damaged if connected to your phone at the same time as a fast charger or any other accessory.



Security

Responsibility

Your cellular phone is under your responsibility. Careless handling of the phone can result in harm to others and damage to the phone itself. To avoid such problems, read and follow all the security instructions presented here and make them known to anyone borrowing your phone. To prevent unauthorised use of your phone:

- Keep your phone in a safe place and keep it out of small children's reach.
- Switch off the phone if you are going to leave it unused for a long time.
- Use the Security menu to make call restrictions (see page 37).
- Use the Security menu to change the security code after purchasing the phone (see page 37).

Children



Your cellular phone is not a toy. Keep your phone in a safe place and keep it out of small children's reach. Children could hurt themselves or others and they may damage the phone.

Respect of local laws and regulations

Cellular phones can interfere with their environment. Consequently, safety rules and regulations have been created. You should inquire about local regulations when you acquire a cellular telephone, and if you wish to use your phone while travelling, you should find out what regulations apply in the state or country you are visiting.



Note:

- Regulations concerning vehicles and aircraft are particularly stringent.
- Do not switch on your cellular phone in states or countries where no cellular network is available.

Use while driving

- Avoid using your phone while driving, except in an emergency.

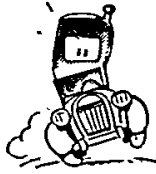

Using your phone and driving at the same time can be dangerous as it lowers your concentration.

- In all cases, you should give your full attention to driving. Pull off the road and park before using the phone whenever possible.
- If you want to use your phone while driving a vehicle, install the hands free car kit which is available for that purpose.
- Respect the local regulations in countries where you drive and use your cellular telephone.
- Check with your car manufacturer that the electronic equipment used in your car will not be affected by the radio energy emitted by your phone.







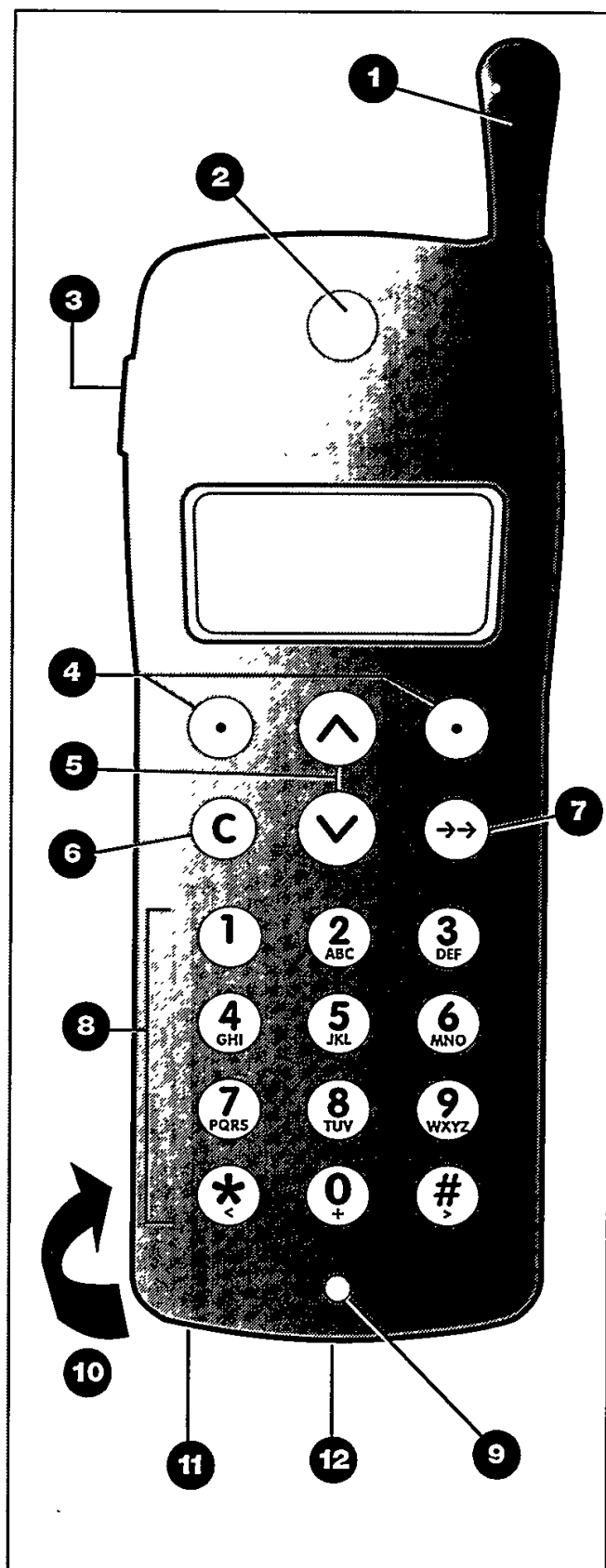

Important Note:

The use of an alarm system to operate a vehicle's lights or horn to indicate incoming phone calls is prohibited on public roads in certain countries. Check the local regulations.

Description of the phone



- 1 Antenna**
- 2 Earpiece**
Listen here.
- 3 On/Off button** 
Press and hold to switch the phone on or off.
- 4 Soft keys** 
The 'soft' keys perform different functions at different times. What the soft keys do at any given time is shown in the 'label', on the display, just above the soft key.
- 5 Scroll key** 
Use this key to adjust the earpiece volume or to scroll through menus and the phone book. When it is possible to scroll up or down, the scroll indicators () are shown on the display.
- 6 Clear key** 
Use this key to get out of trouble!
It clears the display or deletes mistakes you made. 
- 7 Redial key** 
Displays the last 10 numbers you dialled.
- 8 Keypad**
Standard telephone keypad. It can also be used for entering letters.
- 9 Microphone**
Speak here.
- 10 Battery**
Fit the battery at the back of the phone.
- 11 Charger socket**
Use this to connect the phone to the transformer unit when charging your battery.
- 12 Accessory connector**
Use this to connect the phone to the car kit and other accessories.



Note:

The actual shape and position of the keys may differ according to your model.



The display

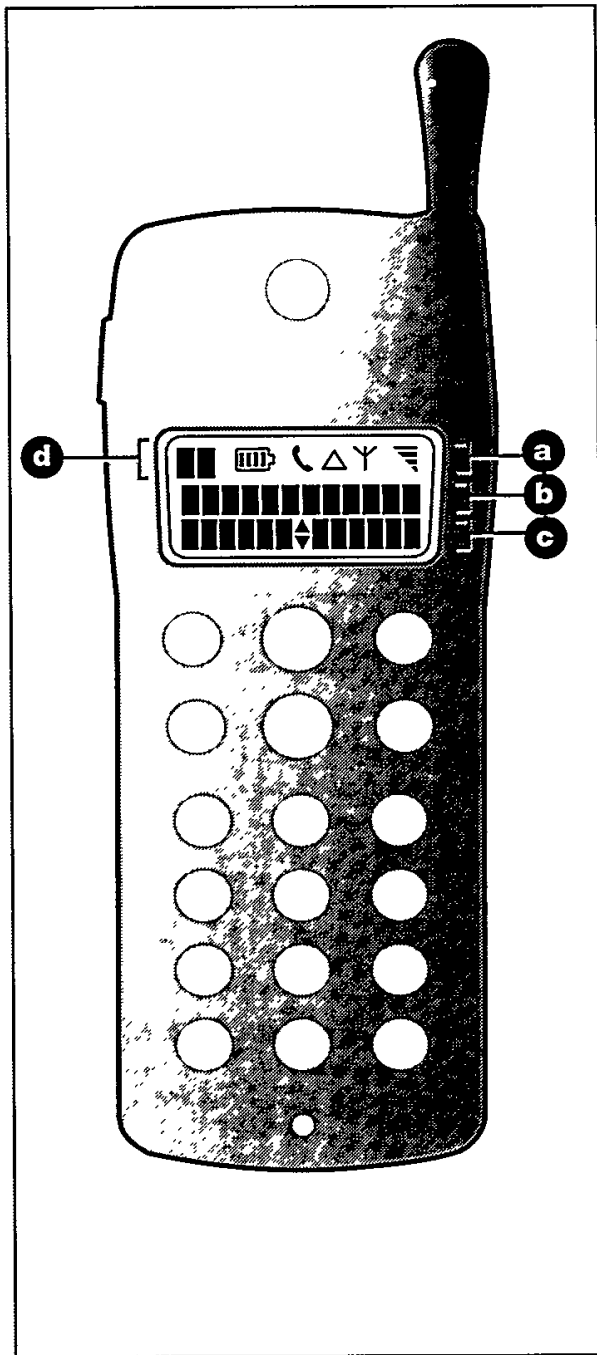

The display shows messages and symbols.

a Symbols:



Battery charge.

Four bars displayed means 100% charge.



Telephone.

Flashing - means a call is received but not yet answered.

Steady - means a call is in progress.



Roaming.

Shows that you are using a network other than your home network. Your phone may not have the roaming option.



Network.

Means that the phone is registered (connected) with a network.



Reception quality.

Four bars displayed means the best reception.

b Messages:

Display area for showing phone numbers, phone book entries and menu prompts.

c Labels and scroll indicators:

Two labels show the function of the soft keys below the labels.

The Scroll indicators (↕) between the labels show when you can scroll with the scroll key.

d Menu or Phone Book index:

When in the menus, this number identifies the menu or submenu currently on display. Use menu numbers as a navigational aid and for quick access to the menus.

When in the Names or Redial list, this number shows the position of the current entry in the list.



The battery

Your phone is powered by a rechargeable battery. Charge the battery after purchase.

Battery charge is shown by the  symbol on the display. Each bar shown represents 25% of charge.

If the battery symbol flashes and the phone emits a warning signal (see page 34), you should charge the battery.



Notes:

1. Charge a new battery (or a battery which has not been used for 3 months or more) for at least 24 hours before using.
2. A new battery reaches its maximum capacity only after being fully discharged and recharged 2 or 3 times.
3. A battery lasts longer if you allow it to fully discharge from time to time.

Clipping on the battery

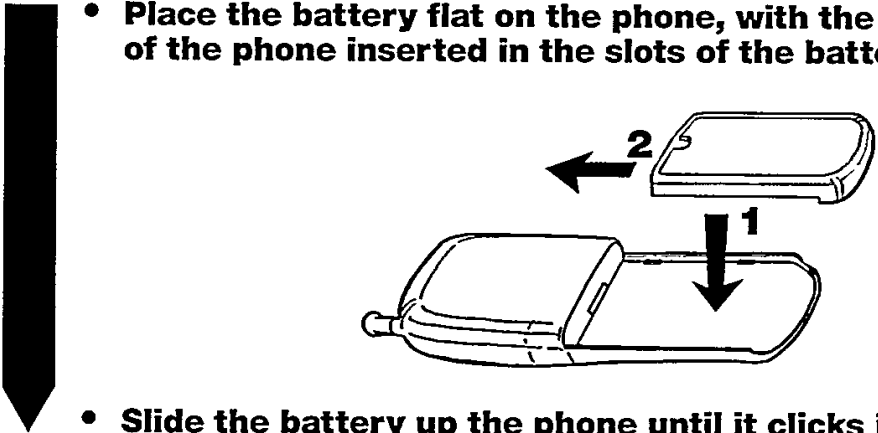

- Place the battery flat on the phone, with the locking tabs of the phone inserted in the slots of the battery.

- Slide the battery up the phone until it clicks into place.

Removing the battery

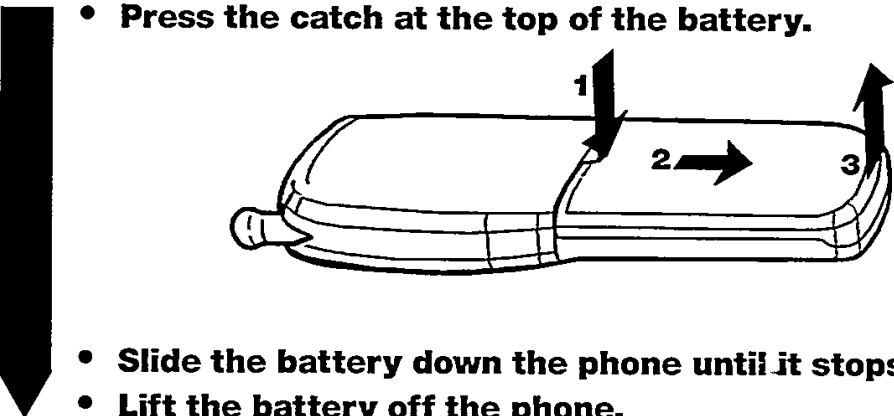

- Press the catch at the top of the battery.

- Slide the battery down the phone until it stops.
- Lift the battery off the phone.



Using the charger

A charger is supplied with the phone, in the box.

- **Clip battery on the phone.**
- **Plug the connector into the round socket at the base of the phone.**

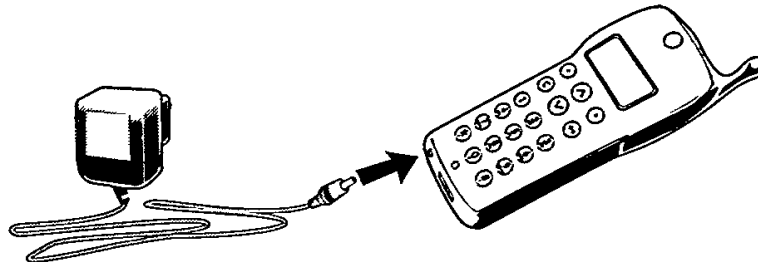

- **Plug the transformer unit into a mains ac power socket. The  symbol indicates the state of charge:**

- The battery is charging if the bars are moving (phone on or off)
- The battery is fully charged when the bars stop moving (phone on) or the battery symbol disappears (phone off).



Notes:

1. You can switch on your phone and use it during charging. In this case, the charging will be suspended during calls.
2. The only way to turn off the charger is to unplug it, so use an a.c. power socket which is easy to access.



Warning:

Never use the charger socket and the accessory connector at the same time. The battery charger supplied with your phone will be damaged if connected to your phone at the same time as a fast charger or any other accessory.



Making an emergency call



- **Switch on the phone**

The display shows a welcome message and the label: **SOS**

- **Press SOS immediately**

The phone displays **Emergency** and the emergency number.

- **Press Call**

The phone dials the number. Wait for the answer and then speak.

- **After the call, press End.**



Note:

You can place an emergency call even if your phone is locked.
You do not have to enter your lock code first.

Alternatively, if your phone is already switched on, you can:

- enter the emergency number using the keypad
- or simply press **(0)** and then press and hold **(0)** again.

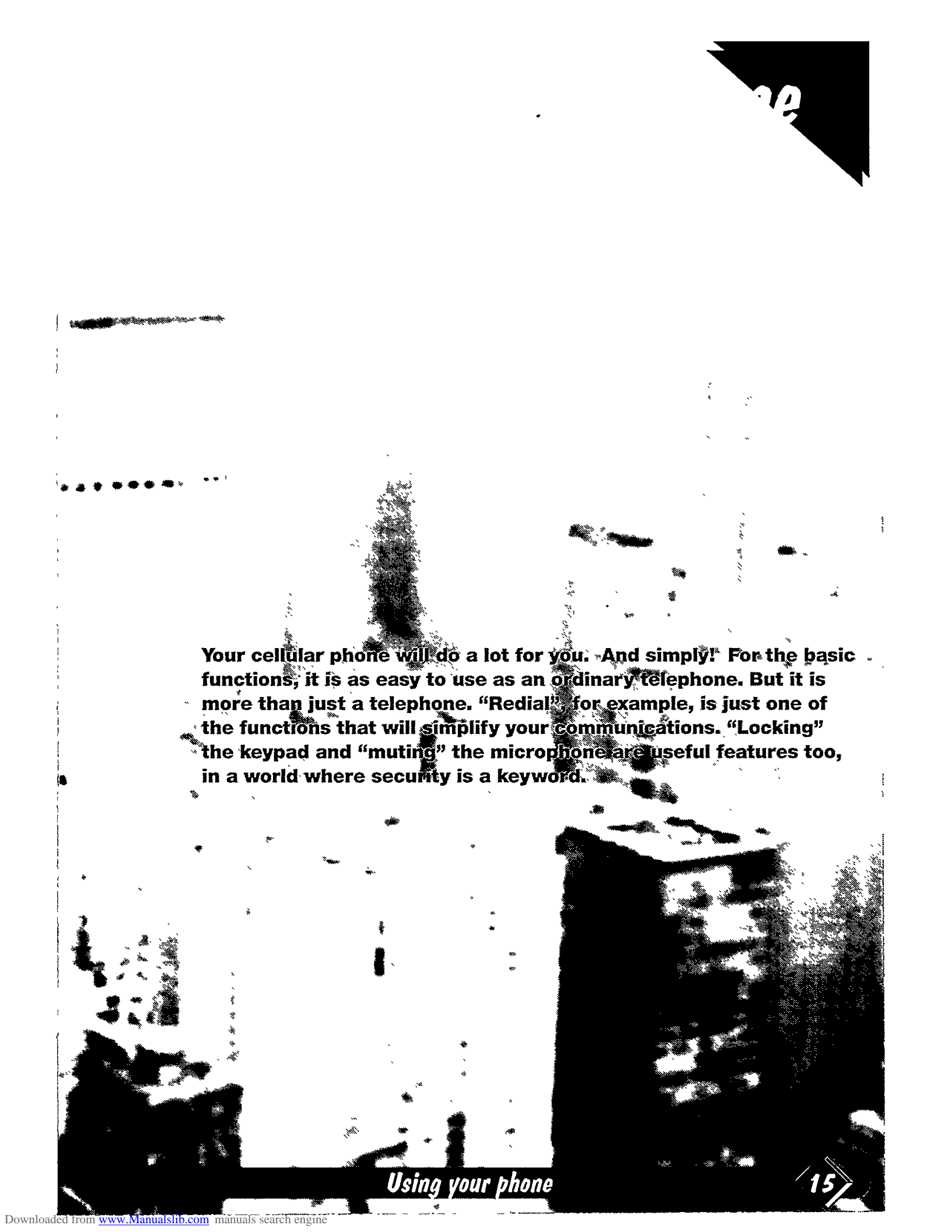

Your cellular phone will do a lot for you. And simply! For the basic functions, it is as easy to use as an ordinary telephone. But it is more than just a telephone. "Redial", for example, is just one of the functions that will simplify your communications. "Locking" the keypad and "muting" the microphone are useful features too, in a world where security is a keyword.



Switching on



- Press and hold the **Ⓜ** key on the side of the phone.
- Enter your lock code if asked and press OK.

The lock code is a security feature that can be switched on and off using the "Auto lock" menu (see page 36).



Note:

Unless it has been changed by your dealer, your lock code is **0000**. You should change it at the earliest opportunity using the "Lock code" menu (see page 37).



Standby mode

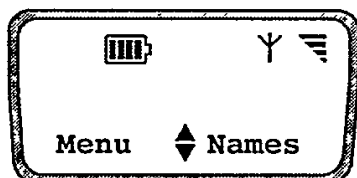

After switching on (and unlocking), your phone goes to standby mode which means that the phone is ready to use. At the same time:

- the **Y** symbol is shown, indicating that the phone is registered with a network,
- the **≡** symbol is shown, indicating the quality of reception.

If the **Y** symbol is not displayed, the network is not currently available. You may be in a bad reception area (perhaps in a tunnel or between tall buildings). If possible, move to a different location.

If you leave standby mode, for example to go into the menus or phone book, the phone automatically returns to standby mode if there is no key press for two minutes.



Making a call

In standby mode:



- **Enter the phone number using the keypad.**
To correct a mistake, press **C**.
To make an international call, you can enter + (instead of the international prefix) by pressing and holding the **0** key.
- **Press Call.**
The phone dials the number. Wait for the answer and then speak.
- **After the call, press End.**



Notes:

1. You can also make a call from the electronic phone book (see "Calling from the Names list" on page 28 and "Calling from the Redial list" on page 29).
2. During a call you can mute the microphone (see "Switching the microphone off" on page 18).
3. During a call and after a call, the call timer may be shown if it has been activated (see "Call meter menu" on page 36).



Answering a call

When a call is received, the phone rings, the  symbol flashes, and the display shows **Ringring**.



- **To answer the call, press Answer and speak.**
- **After the call, press End.**



Notes:

1. The phone does not ring if the silent ringer is switched on (see page 20).
2. If you have selected the Any Key Answer function (see page 34), you can accept the call by pressing any key except the **Silent** key or the On/Off key.
3. CallSelector feature: if you can't answer the call straight away and you want to silence the ringer, press **Silent**. The  symbol continues to flash. You can still answer the call by pressing **Answer**.
4. If the phone stops ringing before you can answer it, the display shows **Unanswered** and the number of unanswered calls (the counter goes up to 16). Press **Exit** (or any key) to clear the screen and reset the counter to zero. If you choose the **Silent** option when you receive a call, the call is not counted as unanswered.



During a call ...

You can:

- adjust the earpiece volume
- switch the microphone off and on (mute function)
- enter a phone number on the scratchpad
- transmit DTMF tones to answering machines and other devices (see page 20)
- send key sequences to activate supplementary network services (see page 21)

Adjusting the earpiece volume

During a call:



- **Press the \wedge key to increase the earpiece volume.**
- **Press the \vee key to decrease the earpiece volume.**

Switching the microphone off

You can mute the microphone so that your correspondent cannot hear you.

During a call:



- **Either press and hold Option .**
The microphone is muted.
- **Or press Option to show Mute and then press OK.**
The microphone is muted.

Switching the microphone on

With the microphone muted:



- **Either press and hold Option .**
The microphone is unmuted.
- **Or press Option to show Unmute and then press OK.**
The microphone is unmuted.

Using the scratchpad

The scratchpad is a temporary memory that allows you to jot down a telephone number during a call. This may be useful when in a hurry or in an emergency situation or when there's no pen and paper to hand. Immediately after your call, you can complete the number, then dial it and/or store it in the phone book.

The scratchpad is automatically cleared shortly after the call ends.



Redialling the last number

The phone logs the last 10 numbers you dialled. You can recall any of these numbers and dial it directly. The most recent is displayed first.

In standby mode:



- **Press** .

The display shows the last number logged in your Redial list. If this was a number you dialled from your Names list (see "Calling from the Names list" on page 28), the name associated with the number is also displayed.

- **Press**  **or**  **to scroll to the number you want to redial.**

- **Press Call.**

The phone dials the number. Wait for the answer and then speak.

- **After the call, press End.**



Locking the keypad

You can lock the keypad to protect the phone from accidental key pushes (when the phone is in your pocket, for example).

In standby mode:



- **Press Menu and then press** .

The keypad is locked.



Unlocking the keypad

With the keypad locked:



- **Press and hold** **Unl**o**ck** .

The keypad is unlocked.



Note:

The keypad is unlocked automatically when the phone receives a call, and remains unlocked if you answer the call. If you don't answer the call, the keypad automatically relocks.



Switching the silent ringer on and off

If you want to receive calls but do not want the ringer to make any sound, switch on the silent ringer.

If you receive a call while the silent ringer is switched on, the phone does not ring. Instead the  symbol flashes, and the display shows **Ringi**ng.

In standby mode:



- **Press Menu and then press .**

If currently off, the silent ringer is switched on.





If currently on, the silent ringer is switched off and the ring volume is set to **Medium**.



Sending DTMF tones

Certain telephone services (such as answering machines and pagers) require your telephone to transmit DTMF tones (Dual Tone MultiFrequency), also known as “touch tones”. These are used to communicate passwords, callback numbers, caller choices, and so on.

Some devices may require long DTMF tones. If so, set the tones to ‘continuous’ using the “DTMF tones” menu (see page 34).

You can transmit a DTMF sequence at any time during a call by pressing keys  to ,  and .

You can also append a DTMF sequence to a telephone number and store the entire sequence in memory for future use. The telephone number and the DTMF part must be separated by one or more pause characters.

Pause characters

To enter a pause character (**p**), press  twice in quick succession.

The digits following a pause character are sent as DTMF tones. Each pause character generates a delay of 2.5 seconds. If 2.5 seconds is too short, you can enter several consecutive pause characters to increase the pause time.

For example, to hear all messages (code 3) on your answering machine (password 8421) at phone number 1234567 you could dial:

1234567ppp8421p3.



Supplementary network services

Your phone is designed to support supplementary network services such as Call Forwarding, Call Barring, Call Waiting, and Multi-Party Calling. Your cellular service provider will tell you what key sequence (or “flash request”) you must send to the network to activate or deactivate a given service.

Sending key sequences for network services

During a call:



- Press **Option**.
- Press **^** or **v** to show **Send: _**
- Enter the key sequence (e.g. ***43#**), then press **Send**.
- After the call, press **End**.

In standby mode:



- Enter the key sequence (e.g. ***43#**), then press **Call**.
- After the call, press **End**.

You can also append a key sequence to a telephone number and store the entire sequence in your phone book for future use. The telephone number and key sequence must be separated by a wait character.

Wait characters

To enter a wait character (w), press **#** three times in quick succession.

If you call a number containing a wait character, e.g. **1234567w*72#**, your phone dials the first part (**1234567**) and then waits. When the call is connected, the phone displays the remaining part (***72#**) and then dials it when you press **Send**.

Only one wait character is allowed per number. The combined length of the telephone number, the wait character, and the key sequence cannot exceed 32 digits.

Calling Line Identification service (CLI)

If you subscribe to CLI, your phone displays the caller's number when you receive a call. It also logs the caller's number in the Redial list.

If the caller's phone number and name are stored in the Names List, then the caller's name is displayed instead of the phone number.

If you do not subscribe to CLI, the phone simply displays the message **Ring** whenever you receive a call.



Note:

CLI is not available in all countries. Please contact your cellular service provider for details.

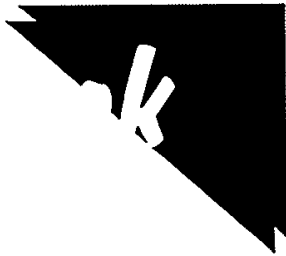

Look up a friend's telephone number! Store a business number for future reference! Call back a client! Nothing is easier. Use your phone book like an electronic notepad.



The two lists

The electronic phone book contains 2 separate lists.

The Names list

When you create a phone book entry, it is written in the Names list. In each entry you write:



- a name (up to 12 letters long),
- and a phone number (up to 32 digits long).

The Names list can contain up to 50 entries. You can modify an entry, delete it, or move it to a new position.

The Redial list

Every time you make a call, the phone number is logged in the Redial list. The Redial list contains the last 10 numbers you dialled, with the most recent at the beginning of the list (position 0). If the number you dial is in your Names list, then both the name and number are logged in the Redial list.

If you subscribe to the Calling Line Identification service (see page 22), your incoming calls are also logged in the Redial list. The Redial list may thus contain a mixture of the last calls dialled and the last calls received (with a combined maximum of 10). When browsing through your Redial list, your received calls are indicated by the symbol **i** (for "incoming") at the top left of the screen. Calls are logged in the Redial list even if you don't answer them.

You can copy numbers from the Redial list to the Names list.



Adding an entry to the Names list

You can add an entry to the Names list either directly, or from the Names menu.

Directly

In standby mode:

- **Enter a phone number and then press Store.**
- **Enter a name (see "How to enter a name" on page 25) and then press OK.**
- **Modify the phone number if you need to and press OK.**
The display shows the first free position.
- **Press OK if the proposed position suits you, or press \wedge or \vee to select an alternative (free) position and then press OK.**

The name and number are stored in the Names list at the position selected.

Note:

You can also enter a number while in the middle of a call, and then store it in the Names list after ending the call.



From the Names menu

In standby mode:



- **Press Names.**
- **Press \checkmark to show Add new name and then press OK.**
- **Enter a name (see below) and then press OK.**
- **Enter a phone number and then press OK.**
The display shows the first free position.
- **Press OK if the proposed position suits you, or press \wedge or \checkmark to select an alternative (free) position and then press OK.**
The name and number are stored in the Names list at the position selected.

How to enter a name

When entering names, you type the letters with the numeric keypad. Each key corresponds to several characters (see "Table of characters" on page 26).

- Press a key several times in quick succession to show the character you want.
For example to enter the letter C: press $\textcircled{2}\textcircled{2}\textcircled{2}$.
- When you want to go on to the next character, press another key. If the next character uses the same key, either wait 1 second or press the $\textcircled{\#}$ key to move the cursor to the right.
For example, to enter Mac: press $\textcircled{6}\textcircled{2}$ (wait) $\textcircled{2}\textcircled{2}\textcircled{2}$.
- To enter a space: press $\textcircled{1}$. To enter 2 spaces: press $\textcircled{1}$ (wait) $\textcircled{1}$.
- To move the cursor left or right, press $\textcircled{*}$ or $\textcircled{\#}$.
- The first letter in a name or after a space is displayed in upper case. All subsequent letters are displayed in lower case. You can switch to upper case by pressing $\textcircled{\wedge}$, or to lower case by pressing $\textcircled{\checkmark}$.
- To correct mistakes:
 - press and release \textcircled{C} to delete one character,
 - or press and hold \textcircled{C} to delete all characters.
- To insert a character, place the cursor under the character on the right of the insertion point. Then enter the new character.

Table of characters

When entering names, press the corresponding key to get the following characters.

Key	Upper case	Lower case
1	space 1	space 1
2	ABCÄ2	abcàâãç2
3	DEFÉ3	defèé3
4	GHI4	ghii4
5	JKL5	jkl5
6	MNOÑÖ6	mnoñòö6
7	PQRS7	pqrs7
8	TUVÜ8	tuvùü8
9	WXYZ9	wxyz9
0	0]@\$[space !"#%&' ()*+,-./:;<=>?£¥\$!¿	(as per upper case)

Key functions for entering a name

Key	Function
⤴	Change character to upper case
⤵	Change character to lower case
Ⓢ	Press and release: delete one character
Ⓢ	Press and hold: delete all characters
0 - 9	Enter characters (see "Table of characters")
*	Move cursor one space to the left
#	Move cursor one space to the right

How to enter a number

Phone book numbers can contain digits 0 to 9 and the characters +, *, #, p (pause), and w (wait). Enter numbers with the numeric keypad.

- To correct mistakes, use Ⓢ
- You cannot use keys * and # for moving the cursor. You must use Ⓢ.
- For international dialling, you can enter + (by pressing and holding 0) instead of the international prefix.



Short cuts into the Names list

If you use the Names list frequently, you will find one or all of these short cuts very useful.

Going to the beginning of the list

In standby mode:



- **Press \uparrow or \downarrow .**

The display shows the first entry in the Names list.

- **Press \uparrow or \downarrow to scroll to the entry you are looking for.**

Finding an entry by its name

In standby mode:



- **Press Names.**

- **Enter the first few letters (up to 12) of the name you are looking for, and then press Search .**

The display shows the first name starting with the letter(s) you enter. If no name starts with these letter(s), then the alphabetically closest name is displayed instead.

- **Press \uparrow or \downarrow to scroll to the name you are looking for.**

Finding an entry by its position

In standby mode:



- **For positions 1 to 9, press and hold the relevant digit key.**

For example, to recall entry 7, press and hold $\overline{7}$.

- **For positions 10 and up, press the first digit and then press and hold the second digit.**

For example, to recall entry 17, first press $\overline{1}$ then press and hold $\overline{7}$.



Calling from the Names list

You can recall an entry from the Names list and dial its telephone number.

In standby mode:



- **Go to the entry you want to dial.**
See "Short cuts into the Names list" on page 27.
- **Press Call.**
The phone dials the number. Wait for the answer and then speak.
- **After the call, press End.**



Changing an entry in the Names list

You can change the name, the telephone number or the position of an entry in the Names list.

In standby mode:



- **Go to the entry you want to change.**
See "Short cuts into the Names list" on page 27.
- **Press Option.**
The display shows **Edit name**.
- **Press OK.**
- **Modify the name and then press OK.**
- **Modify the number and then press OK.**
- **Modify the position with \uparrow or \downarrow and then press OK (if the new position is free) or Swap (if the new position is in use).**



Deleting from the Names list

In standby mode:



- **Go to the entry you want to delete.**
See "Short cuts into the Names list" on page 27.
- **Press Option.**
- **Press \downarrow to show Delete name.**
- **Press OK and then Yes (if you are sure).**





Calling from the Redial list

You can recall a phone number from the Redial list and dial it.

In standby mode:



- **Press** .
- The display shows the last number logged in your Redial list. If this is a number from your Names list, the display shows both the name and number.
- **Press**  or  to scroll to the entry you want to redial.
- **Press Call.**
- The phone dials the number. Wait for the answer and then speak.
- **After the call, press End.**









Copying from the Redial list

You can copy a phone number from the Redial list into the Names list and add a name.

In standby mode:







- **Press** .
- The display shows the last number logged in your Redial list.
- **Press**  or  to scroll to the number you want to copy.
- **Press Option.**
- **Press**  or  to show Store number and then press OK.
- **Enter a name and then press OK.**
- **Modify the number if you need to and press OK.**
- The display shows the first free position in the Names list.
- **Press OK if the proposed position suits you, or press**  or  to select an alternative (free) position and then press OK.



Deleting from the Redial list

In standby mode:



- **Press** .
- The display shows the last number logged in your Redial list.
- **Press**  or  **to scroll to the number you want to delete.**
- **Press Option.**
- **Press**  or  **to show Delete or Delete all.**
- **Press OK and then Yes (if you are sure).**



Exiting from the phone book

In the Names list or Redial list:



- **Press Option.**
- **Press Exit once or twice as necessary.**
 The display returns to standby mode.



Short cut:

To exit from the Redial list, simply press the  key.

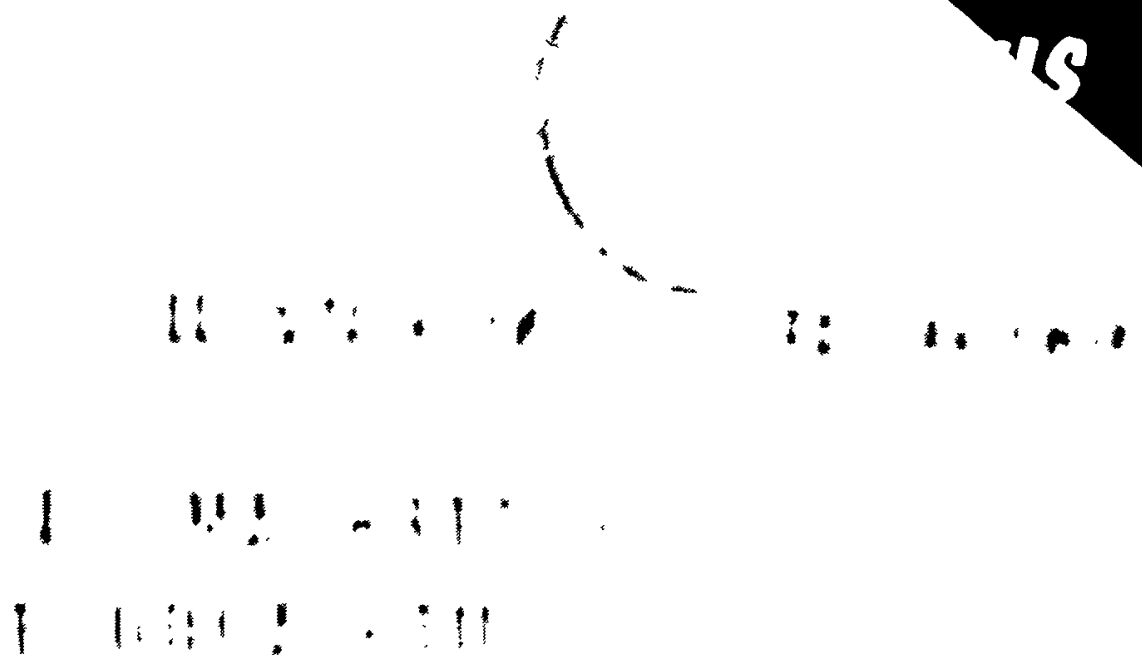
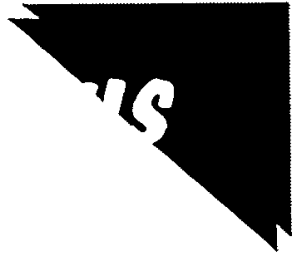

Easy to find and easy to use, the menus contain most of your phone functions. All the menus are used in the same way. Messages on the display explain what you have to do.





Navigating

The Main menu

The Main menu gives you access to all the other menus.

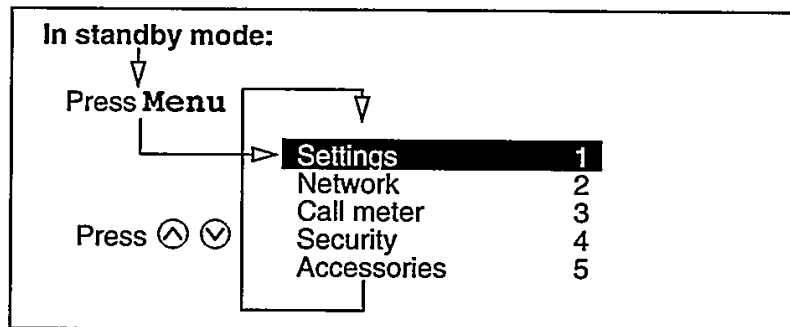

- Press OK to select a menu.
- Press Exit (one or more times) to get out of the menus.

Menu numbers

Menus and their submenus each have a related number. For example, the "Security" menu is menu 4 and the first of its submenus, "Auto lock", is menu 41. When you go into the menus, the current menu number appears at the top left corner of the display.

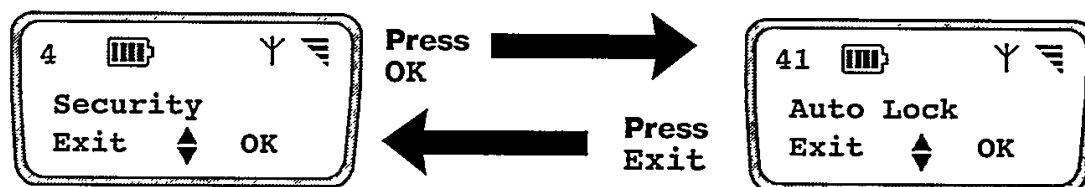

Short cuts into menus

When you know the menu numbers, you can use them to get into a menu quickly. In this book, the menu numbers are shown like this: ①①

In standby mode:



- Press Menu.
- Enter the menu number.
You must enter the second digit within 1 second of the first. The display shows the menu you choose.
- Press OK to select the menu.

Short cut to standby mode



Press and hold **Ⓢ** to go back directly to standby mode. Do this twice if you are in the process of entering a name or other information on the display.



Settings menu

Use the Settings menu to personalise your phone.

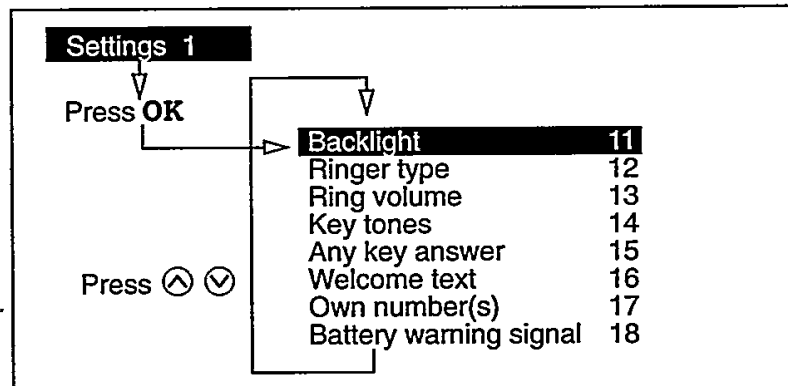

Most of the items in this menu have several possible values.

- Press **OK** to select an item.
- When an item has several possible values, press **⬆** or **⬇** to scroll through the different values.
- Press **OK** (or in some cases **Yes**) to confirm your choice.

1 1 Backlight

Switch on and off the backlight function. When on, the keypad and display will light up for 12 seconds each time you press any key.

1 2 Ringer type

Choose from the different ring tones. If you scroll to a tone and wait 2 seconds, you will hear how it sounds.

1 3 Ring volume

Set the ring volume tone to **High**, **Medium**, **Low** or **Silent**.



Short cut to the silent ringer:

In standby mode, press **Menu** and then **#**.
If the silent ringer is currently off, this switches it on.
If the silent ringer is currently on, this switches it off and sets the ring volume to **Medium**.

1 4 Key tones

Switches on and off your keypad tones.

①⑤ Any key answer

This function allows you to accept a call by pressing any key (except the **Silent** key or the On/Off key).

①⑥ Welcome text

Change the phone welcome message. This is the message which is shown when you switch the phone on. The phone first shows the current message. Enter the new text with the keypad. See "How to enter a name" on page 25.

①⑦ Own number(s)

Read your cellular phone number (if you have one NAM) or both your phone numbers (if you have two NAMs). The phone number for the active NAM is displayed with an asterisk (*).

①⑧ Battery warning signal

Switch on and off the battery warning signal. The battery warning signal sounds once if the battery needs charging.



Network menu

Use the Network menu to set network-related options.

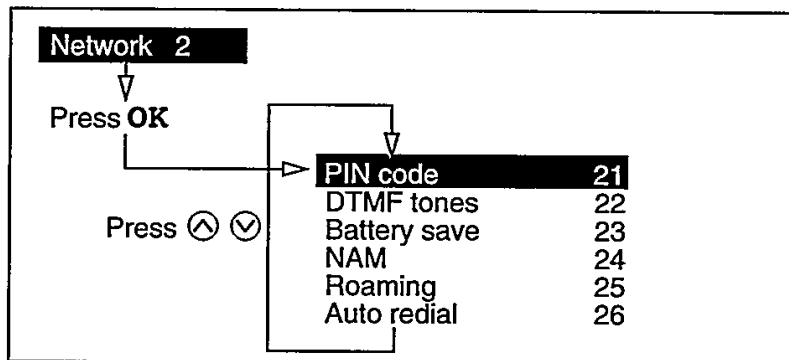

②① PIN code

Your phone may have a Personal Identification Number (PIN code) that enables your network to protect your phone from illegal or unauthorised use. The PIN code is a 16-digit number that is factory-set. Use this function to change the PIN code if asked to do so by your network operator.

②② DTMF tones

The usual setting, **Burst**, generates a short DTMF tone with each key press. **Continuous**, on the other hand, generates a DTMF tone for as long as you press a key.

②③ **Battery save**

This is a network dependent feature known also as VOX (Voice Operated Transmission). If supported by your network, it allows your phone to operate at reduced power when you are not talking. Contact your cellular service provider for information on availability.

②④ **NAM**

This menu option appears only if your phone has two NAMs. Use it to select NAM 1 or NAM 2. The currently active NAM is denoted by an asterisk (*).

When you switch to a different NAM, your phone automatically switches to its other telephone number. This becomes the active number and your phone can receive calls to this number only. Depending on the network, you may be able to forward calls from your inactive number to your active number (check with your cellular service provider).

②⑤ **Roaming**

This menu option is available only if your network supports roaming.

The roaming function is relevant only if it is included in your subscription and you are in an area where roaming agreements offer a choice between Type A and Type B networks. You may have to use this option when travelling outside your home area. You can also use it to take advantage of different rates in different areas or to seek service from an alternate network if your own network is busy or not in service. When you switch on, your phone automatically tries to register with your home network (unless you are away from your home area or you have specified an alternative type).

This function has four possible settings:

- A only** use type A networks only.
- B only** use type B networks only.
- A preferred** use both types but try type A networks first.
- B preferred** use both types but try type B networks first.

②⑥ **Auto redial**

Switches on or off the auto redial. When this function is switched on, if you call a number that cannot be reached (for example, because the line is busy), your phone will automatically continue to redial this number until a successful connection is made or until the maximum number of attempts is reached. Your phone will make a given number of attempts over a set period of time. Both the number of attempts and the period of time are determined by your network.



Call meter menu

Use the Call Meter menu to show the duration of your outgoing calls.

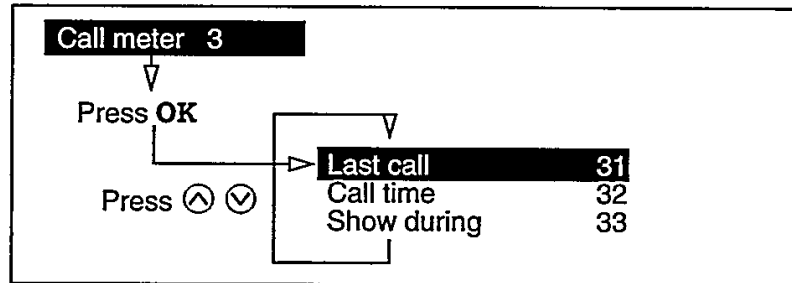

3 1 Last call

Switch on and off the display of call duration after each call.

3 2 Call time

Read the accumulated call duration for all outgoing calls. If you have two NAMs, the call duration is displayed for each NAM separately. The currently active NAM is denoted by an asterisk (*).

The reset function resets the meter to zero.

You are asked to enter your phone security code when accessing this menu.

3 3 Show during

Switch on and off the display of call duration during each call.



Security menu

Use the Security menu to protect your phone from unauthorised use.

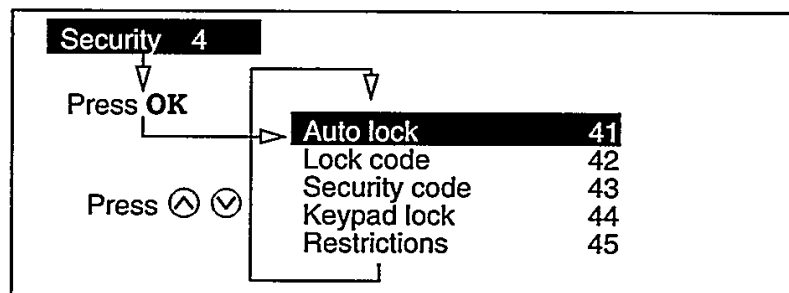

4 1 Auto lock

Switches on and off the requirement to enter your lock code at switch on.

You are asked to enter your phone lock code when accessing this option.

④② Lock code

Unless changed by your dealer, your phone lock code is **0000**. We recommend you change the lock code with this option at the first opportunity. You are asked to enter your old lock code once and the new lock code twice.

④③ Security code

Unless changed by your dealer, your security code is **00000000**. We recommend you change the security code with this option at the first opportunity. You are asked to enter your old security code once and the new security code twice.

④④ Keypad lock

Use this function to protect against accidental activation of the keys (for example, when the phone is in your pocket).

To unlock the keypad, press and hold **UnLock**. The keypad is unlocked automatically when the phone receives a call, and remains unlocked if you answer the call. If you do not answer the call, the keypad automatically relocks.



Short cut to lock the keypad:

Press **Menu** and then *****. To unlock the keypad, press and hold **UnLock**.

④⑤ Restrictions

Use this menu to:

- restrict calls to numbers in the Names list only,
- or restrict the length of permitted phone numbers,
- or restrict all international calls,
- or restrict all outgoing calls,
- cancel call restrictions.

You are asked to enter your phone security code when accessing this menu. If you wish to cancel all call restrictions, choose the setting **None**.



Accessories menu

This menu is available even if the Hands Free Car Kit is not installed.

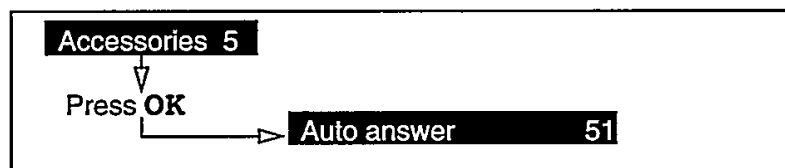

51 Auto answer

If this is switched on while your phone is connected to the Hands Free Car Kit, your phone automatically answers a call without you having to touch the keypad.



Complete Menu structure

When using a short cut into the menus, use the numbers shown in the following table.

1 Settings

- 11 Backlight**
- 12 Ringer type**
- 13 Ring volume**
 - High
 - Medium
 - Low
 - Silent
- 14 Key tones**
- 15 Any key answer**
- 16 Welcome text**
- 17 Own number(s)**
- 18 Battery warning signal**

2 Network

- 21 PIN code**
- 22 DTMF tones**
 - Burst
 - Continuous
 - No DTMF
- 23 Battery save**
- 24 NAM**
 - NAM 1
 - NAM 2
- 25 Roaming**
 - A only
 - B only
 - A preferred
 - B preferred
- 26 Auto redial**

3 Call meter

- 31 Last call**
- 32 Call time**
- 33 Show during**

4 Security

- 41 Auto lock**
- 42 Lock code**
- 43 Security code**
- 44 Keypad lock**
- 45 Restrictions**
 - Names only
 - Limit number length
 - No international calls
 - No outgoing calls
 - None

5 Accessories

- 51 Auto answer**

Maintenance

Your phone will give you years of trouble-free service if you give it a little care and attention.

Look after it carefully, keep it clean and dry, and regularly discharge and recharge the batteries.



Looking after your phone

Your phone is a highly sophisticated electronic device. Treat it with care.

- Store it in a clean, dust free place. Its moving parts can be damaged by dust.
- Keep it out of hot areas. High temperatures can shorten the life of electronic components and batteries, and warp or melt certain plastics.
- Do not try to open the phone. If it is not working properly, call the Philips Help-line.
- Use only the recommended batteries and battery chargers.
- Treat the phone gently and avoid dropping, knocking or shaking it.
- Keep the phone and accessories out of the reach of small children.
- Keep the phone dry and do not use harsh chemicals (such as solvents or detergents) to clean it. To clean the phone, wipe it with a soft cloth slightly dampened with a mild soap-and-water solution.
- Occasionally let your battery discharge completely before recharging it.



Trouble shooting

Problem	Key	Solution
Your phone is on, but the network registration symbol Υ is not showing.	▶	The network connection is lost. Either you are in a radio shadow (in a tunnel or between tall buildings) or you are outside the network coverage area. Try from another place.
Your phone is on, but never rings.	▶	Check your ring volume (see page 33). The silent ringer may be switched on.
The roaming symbol \triangle is constantly on.	▶	Check the "Roaming" option (see page 35). You may have specified an inappropriate network type.
The display doesn't respond (or responds slowly) to key presses.	▶	The display responds more slowly at very low temperatures. This is normal and does not affect the operation of the phone. Take the phone to a warmer place and try again.
Your phone does not go to standby mode.	▶	<ul style="list-style-type: none"> • Either press and hold \odot. • Or switch off the phone, check that the battery is installed correctly, and switch on again.
You cannot remember your security code or lock code	▶	Ask your local dealer to reprogram your phone with new codes.

Your national guarantee



A PROBLEM? - YOUR F1rst CHOICESM 24H EXCHANGE SERVICE

This product is covered by the F1rst ChoiceSM 24 hours National Guarantee Service described below. This national guarantee does not affect consumers statutory rights, accrued by law, if any.

The F1rst ChoiceSM 24 hours National Guarantee Service covers your phone during a period of one year from the date of purchase from your Philips dealer, against all defects due to faulty workmanship, excluding batteries, which are not covered by the same guarantee but are covered by the standard warranty during a period of six months from the date of purchase.

During the guarantee period, Philips offers the following:

- Call the F1rst ChoiceSM Help Line. The telephone numbers and the information to be provided to the help desk are indicated your information card. The help line is available at normal business hours each working day.
- Describe the defect and give detailed and good faith answers to our help desk. All customer information is treated as confidential and no record of personal data will be kept if you so wish.
- The help desk will arrange with you the exchange of your defective phone with the same type of product (*), free of any charge within 24 h (**), on a nation-wide basis (***).
- When you exchange the defective product with the replacement one, you are responsible for removing the battery from the product to be returned to Philips and for saving or backing up any data contained in your phone.

CONDITIONS

The F1rst ChoiceSM 24 hours National Guarantee applies, provided the product is handled properly for its intended use, in accordance with its operating and care instructions and upon presentation of the proof of purchase consisting of the original invoice or cash receipt, indicating the date of purchase, dealer's name and model and product number of the product.

The guarantee may not apply if:

- the documents have been altered or made illegible in any way;
- the model or production number on the product has been altered, deleted, removed or made illegible;
- repairs or product modifications and / or alterations have been executed by unauthorised service organisations or persons or in the case where modifications have been made by unauthorised service organisations or persons in order for the product to comply with local or national technical standards which apply in countries for which the product was not originally designed and / or manufactured, according to Philips' published list of countries where the product has been type approved, as available at the Philips point of sale;

- damage is caused by accidents including but not limited to falling, shock, lightning, liquid, fire, misuse or neglect;
- the product has been used in conjunction with accessories not approved by Philips for use with the product;
- the product has not been bought new or is not branded Philips;
- the battery has not been charged properly;
- fraudulent or negligent information have been provided to the Help Desk.

Repair or exchange costs will be charged for defects not covered by the guarantee.

IMPORTANT INFORMATION

Definitions:

(*) The defective product may be replaced by an identical or at least equivalent product subject to models still being available. The external parts of the replacement product are brand new. The replacement product is covered by the F1rst ChoiceSM 24 hours National Guarantee Service for the remaining validity period of the original guarantee period.

(**) The “24h” means the working day following your call to the help line or any other date agreed upon with the F1rst ChoiceSM.

Please note that F1rst ChoiceSM is not always available on weekends or Public holidays.

(***) “Nation-wide” or “National” means the place in the country(ies) for which your phone is type approved where you desire to have your product exchanged, provided that such place is covered by cellular and energy networks compatible with your phone and its battery and is reasonably accessible to our special delivery service.

Please note that delivery to a private address is not authorised by law in certain countries.

Warranty:

If we do not perform our F1rst ChoiceSM National Guarantee Service in due time, you will receive a carry case specially made for your phone in the colour of your choice.

Extended Guarantee / Customer Support Information

Please call the help line if you need any information about your product or the F1rst ChoiceSM National Guarantee, especially before travelling.

An Extended Guarantee is available if you wish to benefit from the F1rst ChoiceSM service after the end of the one year guarantee period. Price conditions of this Extended Guarantee are available on demand.

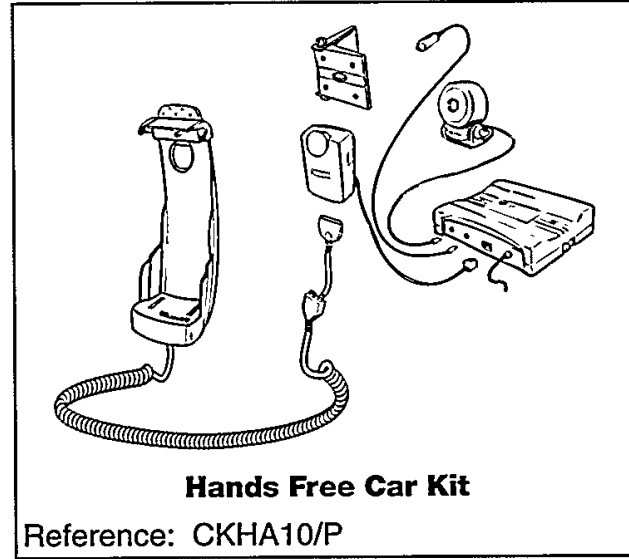
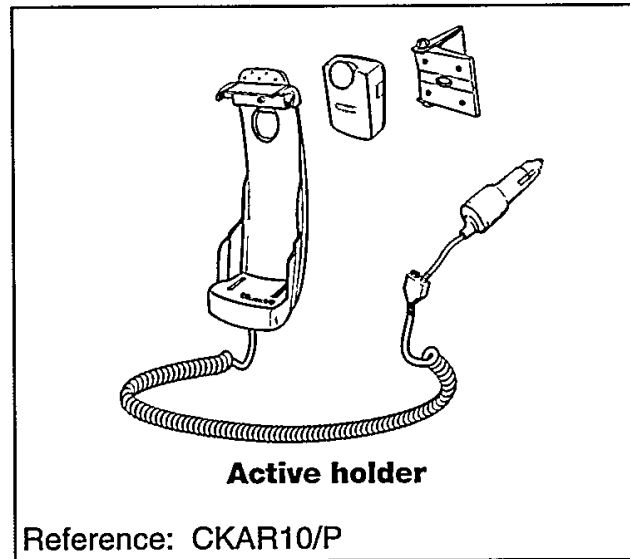
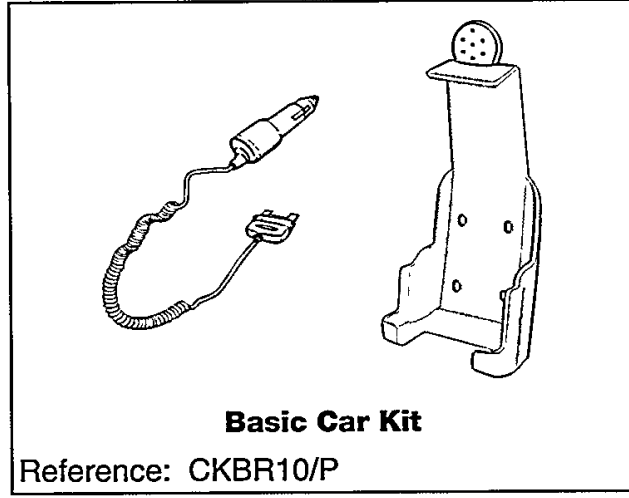
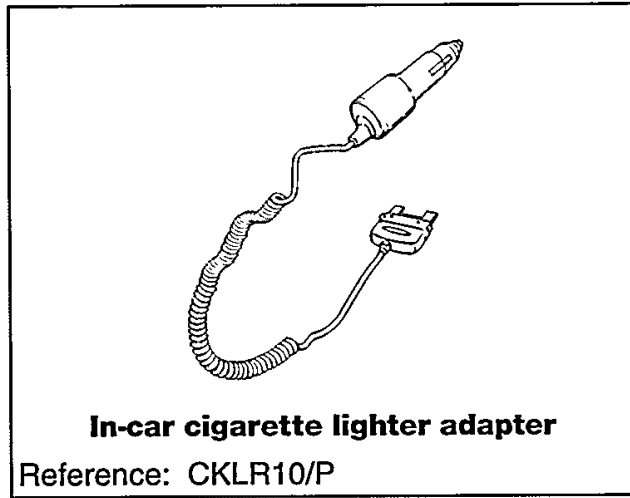
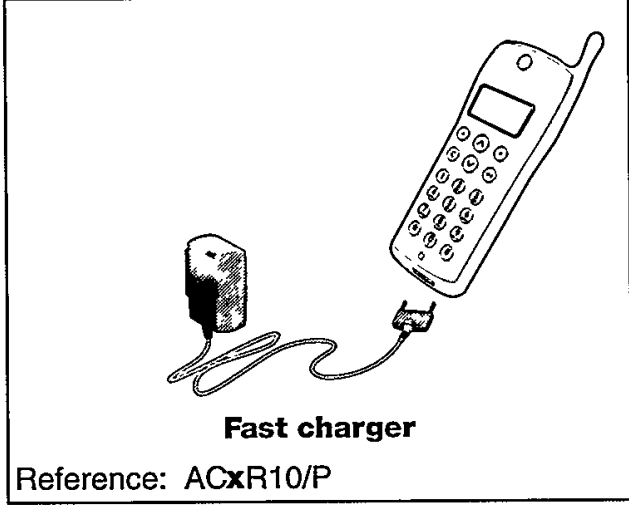
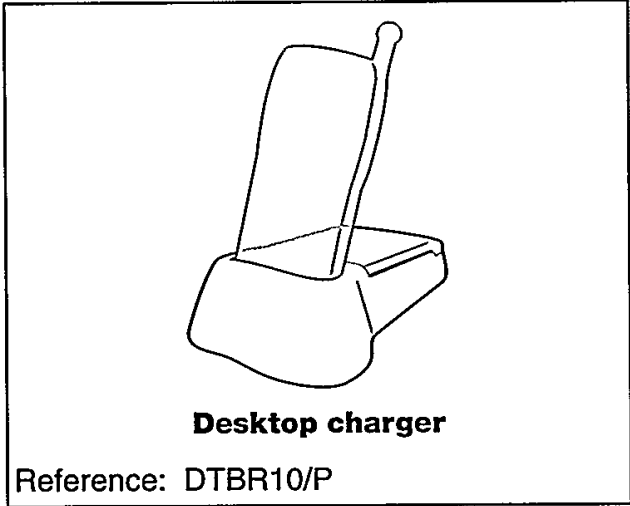

Helplines:

Please refer to your information card.





Spare batteries

Type	Battery	Reference	
1	400 mAh NiCd	BDR104/P	
	600 mAh NiMH	BHR106/P	
2	400 mAh Li-Ion	BIR104/P	
	650 mAh NiCd	BDR106/P	
	900 mAh NiMH	BHR109/P	
3	1600 mAh NiMH	BHR101/P	



Note:

All accessories shown in this manual may not currently be available. Please check with your Philips dealer.

Index

- A**
- A & B networks
 - concept 2
 - menu options 35
 - Accessories menu 37
 - accessory list 43
 - answering a call 17, 34
 - any key answer 34
 - auto answer 38
 - auto lock 36
 - auto redial
 - menu option 35
- B**
- backlight 33
 - battery
 - charging 13
 - fitting 12
 - removing 12
 - types 44
 - battery save 35
 - battery warning signal 34
 - blasting areas 6
- C**
- C key 10, 33
 - call barring, see "network services"
 - call forwarding, see "network services"
 - Call meter menu 36
 - call restrictions 37
 - call waiting, see "network services"
 - calling a phone book number 28, 29
 - Calling Line Identification (CLI) 22, 24
 - car kit 38, 43
 - character table 26
 - clear key 10, 33
 - CLI service 22, 24
- D**
- desktop charger 43
 - display symbols 11
 - DTMF tones
 - menu option 34
 - sending 20
- E**
- ear piece 10
 - earpiece volume 18
 - emergency calls 14
 - entering names 25
- F**
- fast charger 43
 - flash requests 21
- G**
- guarantee 41
- H**
- home network (concept) 2
- I**
- icons 11
- K**
- keypad lock 37
 - keypad tones 33
- L**
- lock code
 - changing 37
 - initial setting 16
 - locking the keypad 19
- M**
- main menu 32
 - maintenance 39
 - making a call
 - from the Names list 28
 - from the Redial list 29
 - menu
 - navigation 32
 - numbers 11, 32
 - summary 38
 - multi-party calling, see "network services"
 - muting 18

N

NAM	
concept	2
menu option	35
Names list	
adding an entry	24
calling from	28
changing an entry	28
concept	24
copying from Redial list	29
deleting an entry	28
exiting from	30
searching by name	27
searching by position	27
short cut access	27
names, entering	25
Network menu	34
network services	21

O

on/off button	10
own phone number	34

P

pause characters	20
phone book	23
phone book numbers	26
PIN code	34

R

receiving a call	17
redial key	10
Redial list	
calling from	29
concept	24
copying to Names list	29
deleting an entry	30
exiting from	30
redialling	19
ring tones	33
ring volume	33
roaming	
concept	2
menu option	35

S

safety information	6
scratchpad	18
scroll key	10
security code	37
Security menu	36
Settings menu	33
short cuts	
to menus	32
to Names list	27
to standby mode	30, 33
silent ringer	20
soft keys	2, 10
SOS calls	14
standby mode	16
switching on	16

T

trouble shooting	40
two-system registration	
see "A & B networks"	

U

unlocking the keypad	19
unmuting	18

V

volume control	18
VOX	
see "battery save"	35

W

wait characters	21
welcome text	34

Remarks Form

Your remarks on this document and on the phone are vital for us to continue improving the quality of our service to you. If you have any comments, please fill in this form and send it to the address indicated below.

Document Title: Fizz Etacs User Manual

Date: November 1996

Reference Number: 3111 276 10232

Your comments on this document:

Your comments on the phone:

Name:

Address:

.....

Date:

Send this form to:

Philips,
Service Department,
Route d'Angers, B.P. 184,
72004 LE MANS Cedex,
France

Cut here:

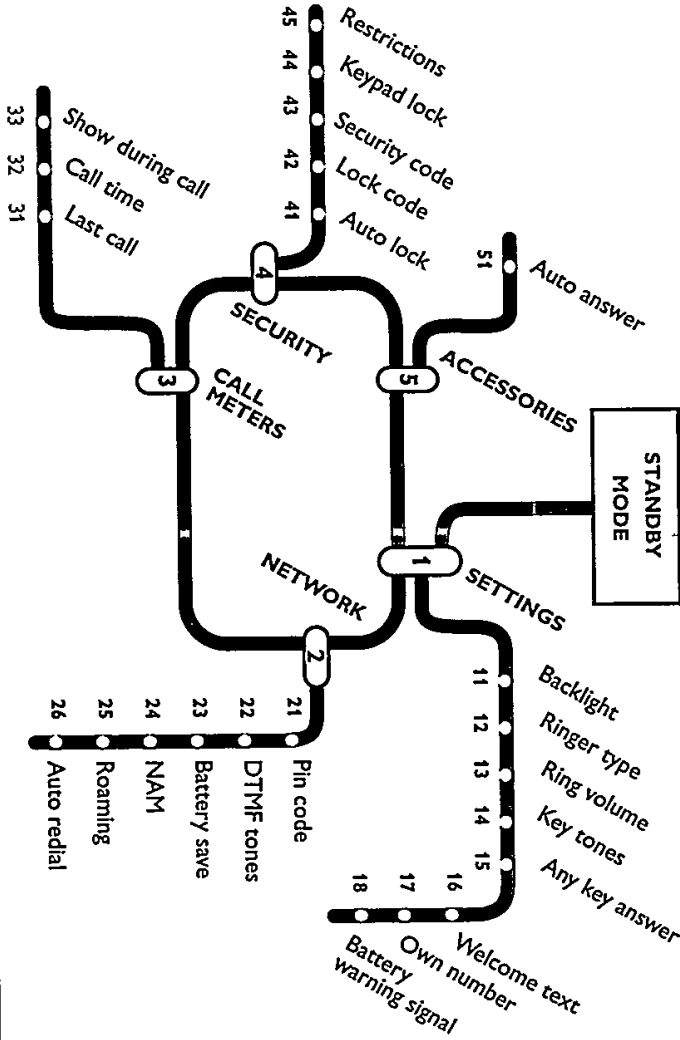

Short Cuts
 Menu Number xy: Menu + (X)(Y)
 Silent Ring: Menu + (#)
 Keypad Lock: Menu + (*)

Copyright PHILIPS 1996 - All rights reserved.

The information contained in this document was correct at the time of printing. However, in order to improve its products and services, PHILIPS reserves the right to modify the specifications mentioned in this document at any time and without warning.

PHILIPS



See reverse side for menu options.



Press and hold **Ⓞ** to quit.

Press **Exit** to get out of a menu or option.

Press **OK** to select a menu.

Press **Menu**. Display other menus with **Ⓢ** or **Ⓣ**.

Using menus:

Scroll with **Ⓢ** or **Ⓣ**. Press **Call**.

Call from Names list:

Memory jogger card

Memory jogger card

Make a call: enter the number; then press **Call**

Answer a call: press **Answer**.

End a call: press **End**.

Write in Names list:

Press **Names**.

Display **Add new name** with **Ⓢ** and press **OK**.

Enter a name and press **OK**.

Enter a number and press **OK**.

Press **OK** to confirm position.



PHILIPS



Please detach and use for your quick reference



3111 276 10232