

Register your product and get support at
www.philips.com/dictation

POCKET MEMO

DPM8900



English	3
Deutsch	33
Nederlands	63

Italiano	93
Français	123
Español	153

PHILIPS

Table of contents

1	Important	5		
	Safety instructions	5	Create a new recording	16
	Rechargeable battery	5	Add to or overwrite a recording	17
	Memory cards	5	Playback	18
	Hearing protection	5	Selecting a file	18
	Legal restrictions on recording	6	Playback a recording	18
	Recycling	6	Adjusting playback speed	18
	About this user manual	6	Quick search	18
	Model-specific features and diagrams	6	Delete	19
	Symbols used	6	Delete a file	19
			Delete part of a file	19
			Delete all files	19
2	Your digital dictation recorder	7		
	Product highlights	7	5	Use more of your recorder
	What's in the box	7	Voice-activated recording	20
	Overview of the recorder	8	Index marks	20
	Start-up screen	9	Assign keywords (author ID and work type)	21
	Overview of the docking station	10	Assign an author name	21
	Overview of the remote control	11	Assign a work type	21
			Instructions	21
3	Get started	12	File lock and priority	22
	Connect the docking station	12	Hands-free recording and transcription	22
	Connect the remote control	12	Hands-free recording	22
	Connect and position the meeting microphones	12	Hands-free transcription	23
	Install the recorder	13	Use Philips SpeechExec software	24
	Insert and eject the memory card	13	Advanced configuration	24
	Charge the battery	14	Download recordings to the computer	24
	Charge using the docking station	14		
	Charge using the USB cable	14	6	Settings
	Power on/off	14	Use the menu	25
	Initial installation process	15	Menu list	25
	Set the language	15	File menu	26
	Set the date and time	15	Delete file	26
	Power-save mode	15	Delete section	26
			Priority high / normal	26
4	Use your recorder	16	Lock /EOL	26
	Recording	16	Index set / clear	26
	Record settings	16	Author, Work type	26

Delete all	26
File information	26
Record menu	26
Profile	26
Line-in	27
Record notification beep	27
Edit mode	27
Encryption	27
Voice activation	27
Display menu	28
Brightness	28
Backlight	28
Appearance	28
Record lamp	28
Language	28
Device menu	28
Beep	28
Acoustic feedback	28
Power save	28
Date & time	28
Slide switch	28
Auto backspace	28
Device information	29
Format card	29
USB charge	29
USB audio	29
Hands-free mode	29
Diagnosis file	29
Reset settings	29
Noise reduction	29
<hr/>	
7 Service	30
Display device information	30
Memory formatting	30
Updating the firmware	30
Troubleshooting	31
<hr/>	
8 Technical data	32

1 Important

Do not make any adjustments and modifications that are not described in this manual. Follow all safety instructions to ensure proper operation of the device. The manufacturer assumes no liability for damages resulting from non-compliance with the safety instructions.

Safety instructions

- Protect the device from rain or water to prevent a short circuit.
- Do not expose the device to excessive heat caused by placing it on a heating device or in direct sunlight.
- Protect the cables from damage by being trapped, particularly at the plugs and where cables exit the housing.
- Back up your data and recordings. The manufacturer's warranty does not cover loss of data resulting from user actions.
- Do not perform any maintenance operations that are not described in this user manual. Do not disassemble the device into its component parts to carry out repairs. The device may only be repaired in authorized service centers.

Rechargeable battery

If the battery is mishandled, it can burst, cause a fire or even chemical burns. Observe the following cautions.

- Do not disassemble.
- Do not crush and do not expose the battery pack to any shock or force such as hammering, dropping or stepping on it.
- Do not short circuit and do not allow metal objects to come into contact with the battery terminals.
- Do not expose to high temperature above 60°C (140°F).
- Do not incinerate or dispose of in fire.
- Do not handle damaged or leaking batteries.
- Charge the battery only in the recorder.
- Keep the battery out of the reach of small children.
- Keep the battery dry.

- Only Philips rechargeable Li-ion batteries ACC8100 (and no others) can be charged in the device. Replace only with the same or equivalent type.
- Remove the battery from the device if it will not be used for an extended period of time. The device can be damaged by leaking batteries.
- Do not remove the battery from the device while it is recording. If you do this, data may be damaged or lost. Device malfunctions may also occur.
- Batteries contain substances that may pollute the environment. Used batteries and rechargeable batteries should be disposed of at an official collection point.

Memory cards

- The device operates with SD/SDHC memory cards and supports cards up to 32 GB in capacity.
- Philips uses approved industry standards for memory cards, but some brands may not be fully compatible with your device. Using an incompatible memory card may damage your device or the memory card and can corrupt data stored on the card.
- Formatting a memory card erases all data on the card. Before formatting the memory card, make backup copies of all important data stored on the card. The manufacturer's warranty does not cover loss of data resulting from user actions.
- Formatting the memory card on a computer may cause incompatibilities with your device. Format the memory card only on the device.

Hearing protection

Observe the following guidelines when using headphones:

- Set the volume to a moderate level and do not use headphones to listen for excessively long periods of time.
- Be particularly careful to avoid adjusting the volume to a level that your hearing cannot deal with.
- Do not turn the volume up so high that you cannot hear what is going on around you.
- In potentially dangerous situations you must be very careful, or

temporarily discontinue use.

- Do not use headphones while operating a motorized vehicle, cycling, or skateboarding, etc. You could be a hazard to yourself and other road users, and possibly be breaking the law.

Legal restrictions on recording

- The use of the device's recording function is subject to the legal restrictions that may apply in your country. You should also respect the privacy and personal rights of the third parties if you record talks or lectures.
- In certain countries you may be legally required to inform the person you are conversing with on the telephone that you are recording the conversation, or that the recording of telephone conversations is illegal. Please check if the use of such data is legal in your country prior to recording telephone calls.

Recycling

When the crossed-out wheeled bin symbol is attached to a product it means that the product is covered by the European Directive 2002/96/EC. Please inform yourself about the local separate collection system for electrical and electronic products. Please act according to your local rules and do not dispose of your old products with your normal household waste. Correct disposal of your old product helps to prevent potential negative consequences for the environment and human health.



About this user manual

You can find a quick overview of your device in the following pages. For detailed description, see the following chapters of this user manual. Read this user manual carefully.

Model-specific features and diagrams

This user manual describes a number of models of the device product range. Please note that some features are only available on certain models.

Symbols used



Tip

- This symbol identifies information that helps you to use your device more efficiently and simply.



Note

- This symbol indicates notices which you must observe when handling or operating the device.



Caution

- This symbol warns of damage to the device and possible data loss. Damage can be caused by improper handling.



Warning

- This symbol warns of danger to persons. Bodily injury or damage could be caused by improper handling.

2 Your digital dictation recorder

We are delighted that you have chosen a Philips device. Visit our website for comprehensive support such as user manuals, software downloads, warranty information and more: www.philips.com/dictaton.

Product highlights

- Easy to use out-of-the-box solution
- Elegant metal carrying case for portability
- Quick set-up with innovative meeting microphones
- 360 degree sound pick-up for optimal recording
- Built-in wire storage and length adaptation
- Expandable through cascading
- Automatic file download via USB for quick transcription
- Exchangeable memory card for unlimited recording
- High recording quality in DSS, MP3 and PCM format
- Built-in motion sensor for automatic microphone selection
- Robust stainless steel casing for extra durability
- Large color display and clear user interface for easy, intuitive operation
- Docking station for fast battery charging and hands-free recording
- Light and motion sensors for extended battery life

What's in the box



Recorder

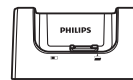

Docking station

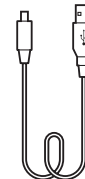

USB cable



Pouch

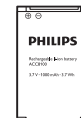
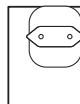

Remote control

Battery
(pre-installed)

Power adapter

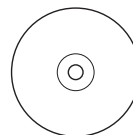

Software DVD

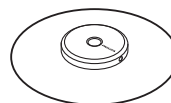
Memory card
(pre-installed)4 meeting
microphones

Splitter cable



User manual

Overview of the recorder

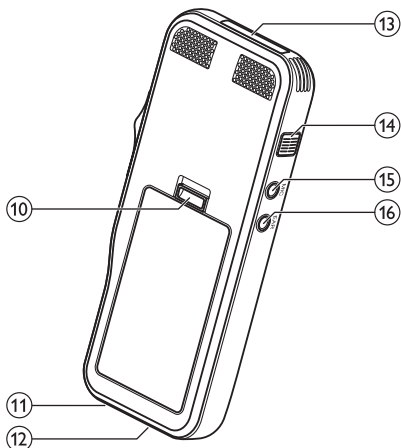
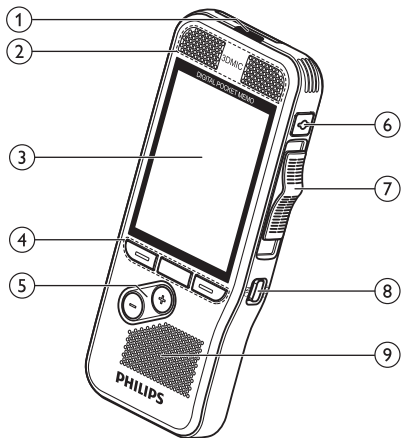

- ① **LED light**
 - Red: device is recording in overwrite or append mode
 - Green: device is recording in insert mode
 - Yellow: data is being transferred to/from the computer
- ② **Microphones**
- ③ **Screen**
- ④ **Function keys F1, F2, F3**
 - Select the function displayed on the screen directly above the key
- ⑤ **+/-**
 - File navigation in stop mode
 - Volume control during playback
 - Menu navigation
- ⑥ **EOL/File lock, Priority**
 - Mark a file as finished and protect it from being deleted
 - Prioritize urgent recordings during transcription
- ⑦ **Slide switch (● REC, ■ STOP, ► PLAY, ◀ REW)**
- ⑧ **ON/OFF**
- ⑨ **Speaker**
- ⑩ **Open the battery cover**
- ⑪ **Docking station connector**
- ⑫ **USB connector**
 - Micro USB connection for the computer
- ⑬ **Memory card slot**
- ⑭ **Fast forward (FWD/▶▶)**
- ⑮ **MIC**
 - External microphone socket (stereo jack plug, 3.5mm)
- ⑯ **EAR**
 - Headphone (stereo jack plug, 3.5mm) socket
 - Remote control socket

Start-up screen

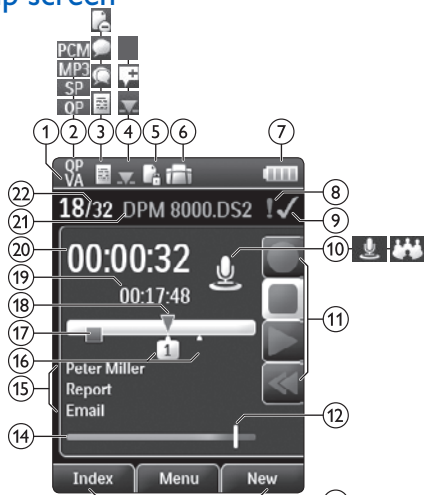

Display in the advanced mode

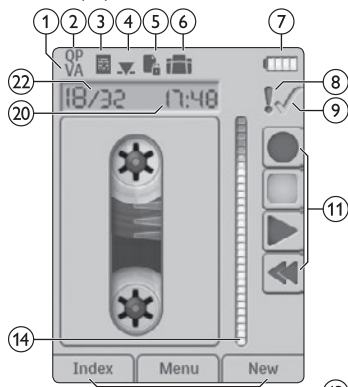



Display in the classic mode



Note



- The position of the symbols may vary, depending on the model, the mode and the selected functions.

- VA Voice activation is on**
 - When voice-activated recording is enabled, recording will start when you begin speaking. When you stop speaking, the recorder will automatically pause recording after three seconds of silence, and resume only when you begin speaking again. → Voice-activated recording, p. 20.
- Recording quality:** OP QP, SP SP, MP3 MP3, PCM PCM
- Recording profile:** Dictate, Meeting, Speech recognition, Personal
 - The recording profile presets recording parameters such as recording quality and file format, microphone sensibility and the microphone mode. → Profile, p. 26.
- Edit mode:** Overwrite recording, Insert recording, Append recording (→ Add to or overwrite a recording, p. 17)
- File is encrypted** (→ Encryption, p. 27)
- A foot switch is connected to the docking station**
 - The recorder can be used for hands-free recording and transcription by connecting the optional Philips foot switch to the docking station. → Hands-free recording and transcription, p. 22.
- Battery charge level**
 - The bars indicate the battery level. When the recorder is charged, the bars keep scrolling until charging completes.
- The priority level of the recording is set to 'high'** (→ File lock and priority, p. 22)
- EOL/File lock**
 - The recording is marked finished and protected from being deleted. → File lock and priority, p. 22.

- ⑩ **Microphone mode:**  Directional mode,  360 degree mode
- The microphone mode is preset by the selected recording profile to suit the recording conditions. → Profile, p. 26.
 - The microphone mode can be controlled by the integrated motion sensor. The motion sensor senses when the device is placed on the desk or held in the hand and sets the microphone mode accordingly.
- ⑪ **Slide switch indicator**
- ⑫ **Sensitivity level indicator for voice-activated recording**
 (→ Voice-activated recording, p. 20)
- ⑬ **Current function of the function key F1, F2, F3**
- ⑭ **Level meter indicator**
- ⑮ **Keyword area**
- One or more keywords, such as the author's name, can be assigned to every recording. Keywords can be used to identify recordings and automatic file routing. → Assign keywords (author ID and work type), p. 21.
- ⑯ **Index mark indicator** (→ Index marks, p. 20)
- ⑰ **Instruction indicator** (→ Instructions, p. 21)
- ⑱ **Position indicator of current playback/recording**
- ⑲ **File length**
- ⑳ **Current recording/playback time**
- ㉑ **File name**
- ㉒ **Current file number/Total number of files**

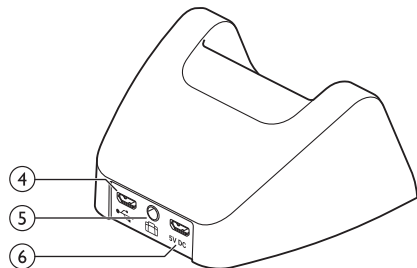
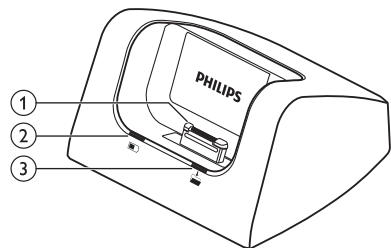
Overview of the docking station



- ① **Docking port**
- ② **Charge indicator light**
- ③ **Download indicator light**
- ④  **USB port**
- Micro USB connection for the computer
- ⑤  **Foot pedal port**
- Connect the Philips foot control LFH2210 (optional) for hands-free dictation and transcription. → Hands-free recording and transcription, p. 22.
- ⑥ **5V DC Power adapter port**
- Connect the power adapter

Overview of the remote control

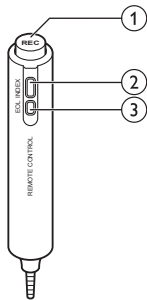

- ① **REC** Start/Stop recording
- ② Insert an index mark
- ③ **EOL/File lock, Priority**
 - Mark a file as finished and protect it from being deleted
 - Prioritize urgent recordings during transcription

3 Get started



Caution

- Ensure you have read the safety instructions before you connect and install your recorder. → Safety instructions, p. 5.

Connect the docking station

- 1 Plug the USB cable supplied with the docking station into the power adapter and connect it to the main power supply.
- 2 Insert the micro USB plug into the power adapter port (**5V DC**) on the rear side of the docking station.
- 3 Plug the USB cable supplied with the recorder into a USB port on your computer.
- 4 Insert the micro USB plug into the USB port (🔌) on the rear side of the docking station.

Connect the remote control

- 1 Connect the plug of the remote control to the remote control (**EAR**) socket of the digital recorder.



Note

- When the remote control is connected, all buttons on the digital recorder are still usable except the recording function of the slide switch.

Connect and position the meeting microphones

- 1 Connect the plug of splitter cable to the microphone (**MIC**) socket of the recorder.
- 2 Connect the plug of each microphone to one socket of the splitter cable
- 3 For optimal recording quality, position the microphones on the table so that all participants are not more that 2 meters or 6.5 feet away from the microphones.

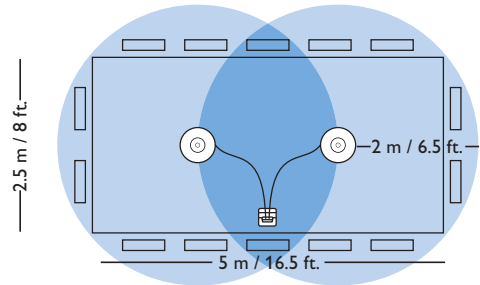

Tip

- For large meetings, the operating range can be extended by joining together and connecting three microphones on each of the two microphone sockets of the splitter cable.

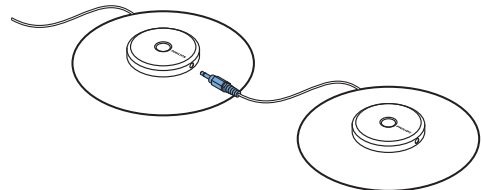

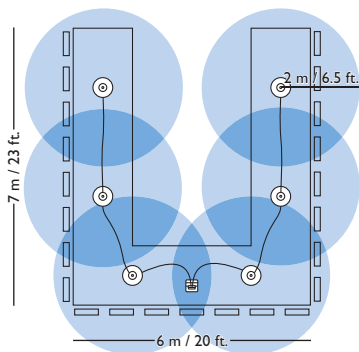
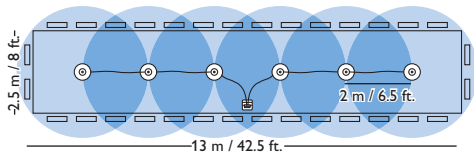

Install the recorder



Note

- Charge the battery for 3 hours before first use.

The battery is pre-installed in the recorder. Pull the battery tape off from the battery door before charging.

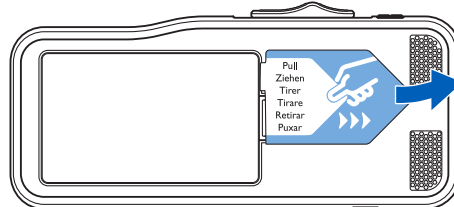

Insert and eject the memory card

The device operates with a SD/SDHC memory card and supports cards with storage capacities of up to 32 GB. The device operates with a SD/SDHC memory card and supports cards with storage capacities of up to 32 GB. Your recorder is packaged with a memory card already inserted and formatted.

To insert and eject a memory card:

- 1 Locate the memory card slot on the top of the recorder.
- 2 Insert a memory card with the gold-colored contacts facing down (toward front of the device).
- 3 Push the memory card in the memory card slot until it locks in place.
- 4 To remove the card press the memory card slightly until the snapping mechanism unlocks and the card is ejected.

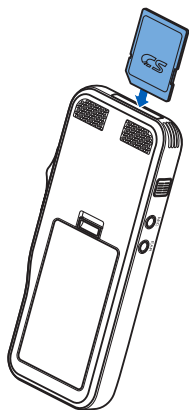

Note

- Do not remove the memory card while recording is in progress. Data may be damaged or lost.
- Philips uses approved industry standards for memory cards, but some brands may not be fully compatible with your device. Using an incompatible memory card may damage your device or the memory card and can corrupt data stored on the card.
- When a new, unformatted memory card or a memory card that was formatted by another device is inserted, the recorder will display a prompt to format the memory card.
- Formatting a memory card erases all data on the card. Before formatting the memory card, make backup copies of all important data stored on the card. The manufacturer's warranty does not cover loss of data resulting from user actions.
- Formatting the memory card on a computer may cause incompatibilities with your device. Format the memory card only on the device.
- Recording and formatting is not possible if the memory card is in read-only mode (locked).

Charge the battery

Charge using the docking station

- 1 Place the recorder in the docking station.
 - ↳ The recorder starts charging.
 - ↳ The charge indicator light flashes green while the battery is being charged.
 - ↳ The charge indicator light changes to solid green when the battery is fully charged.

Note

- Charge the battery for 3 hours before first use.
- The device may become warm when the battery is being charged.
- The maximum battery capacity will only be reached after several charging/discharging cycles.

- 2 Your recorder is now ready to use.

Charge using the USB cable

- 1 Plug the USB connector into a USB port on your computer.
- 2 Insert the micro USB plug into the USB port on the recorder.

Power on/off

The recorder is turned on and off by sliding the **ON/OFF** switch. When using it for the first time, you will be prompted to set the language, date and time.

Note

- The recorder switches itself off automatically if no key is pressed within a pre-set period of time (→ Power-save mode, p. 15).

Initial installation process

The initial installation process starts when first using the device or possibly if there has been a long interruption to the power supply. The date and time entered are saved with each recording as the recording time.

Set the language

When using the recorder for the first time, you will be prompted to set the language.

- 1 Press **+/-** to select your language.
- 2 Press **F2 (OK)** to confirm.

Set the date and time

After selecting the language, the recorder will prompt you to set the current date and time.

- 1 Press **+/-** to change the value for the year, month or day.
- 2 Press **F3 (Next)** to advance to the next entry.
- 3 After setting the day, press **F3 (Next)** to advance the settings to the correct time.
- 4 Press **+/-** to select a 12-hour or 24-hour clock, and to change the value of the hour and minute settings and AM or PM (if a 12-hour clock is selected).
- 5 Press **F2 (OK)** to confirm the date and time.
↳ The recorder is now ready to function.



Tip

- You can change the language, date and time at any time using the settings menu (→ Settings, p. 25).

Power-save mode

By default, the recorder will enter power-save mode after 5 minutes of inactivity. Lift up the recorder or press any button to reactivate it.



Tip

- You can change the length of time before the recorder will enter into power-save mode. → Power save, p. 28.

4 Use your recorder



Note

- You can customize the settings and behavior of your device (→ Settings, p. 25.)
- The descriptions in this chapter are based on the default settings.

Recording

Record settings

Set the required recording profile before you start a recording session. The recording profile presets recording parameters such as recording quality and file format, microphone sensitivity and the microphone mode to suit the recording conditions. → Profile, p. 26.

When voice-activated recording is enabled, recording will start when you begin speaking. When you stop speaking, the recorder will automatically pause recording after three seconds of silence, and resume only when you begin speaking again. → Voice-activated recording, p. 20.

The recorder can be used for hands-free recording by connecting the optional Philips foot switch to the docking station. → Hands-free recording, p. 22.



Caution

- Do not remove the battery from the device while it is recording. Data may be damaged or lost or malfunctions may occur.

Create a new recording

- 1 Press **F3 (New)** to create a new recording.
- 2 To start recording, point the microphone toward the sound source and move the slide switch to the **●REC** position.
↳ The LED lights in red in overwrite or append mode or green in insert mode while recording.
- 3 To stop recording, move the slide switch to the **■STOP** position.



Note

- When the remote control is connected, the recording function of the slide switch on the recorder is deactivated.
- Press **F1 (Index)** during recording or playback to insert an index mark (→ Index marks, p. 20).
- Press and hold **F3 (Instr)** during recording to record an instruction (→ Instructions, p. 21).
- If the recording time exceeds the available capacity, recording stops and a message is displayed. You can not make any more recordings. Delete the recordings which you no longer require, replace the memory card, or connect the device to a computer and transfer the files to your computer.





Tip

- For best recording results, speak clearly and keep the microphone about 5 to 15 centimeters (2 to 6 inches) away from your mouth.

Add to or overwrite a recording

You can edit an existing recording by overwriting a part of it or inserting additional recording.

- 1 While the recorder is in stop mode, press **F2 (Menu)** and select **Record > Edit mode**.
- 2 Set the required editing mode (→ Edit mode, p. 27).
 - **Append mode:** add additional recording after existing recording in a file.
 - ↳ The  symbol is displayed in the information bar at the top of the screen when in append mode and the LED lights in red while recording.
 - **Insert mode:** insert additional recording without overwriting existing recording in a file.
 - ↳ The  symbol is displayed in the information bar at the top of the screen when in insert mode and the LED lights in green while recording.
 - **Overwrite mode:** overwrite a previous recording starting from any point within the file.
 - ↳ No symbol is displayed in the information bar at the top of the screen when in overwrite mode and the LED lights in red while recording.
- 3 Press **+/-** to select the file into which the insertion should be made.
- 4 When using the insert or overwrite mode, play, forward or rewind to the position where the insertion should be made.
- 5 To start recording, point the microphone toward the sound source and move the slide switch to the **● REC** position.
 - ↳ The LED lights in red in overwrite or append mode or green in insert mode while recording.
- 6 To stop recording, move the slide switch to the **■ STOP** position.



Note

- When the remote control is connected, the recording function of the slide switch on the recorder is deactivated.
- When you edit, the recording quality of the original recording is used.
- The Insert recording mode is not available when the recording format is MP3 or PCM.

Playback

Selecting a file

- 1 Press **+** while the device is in stop mode.
 - ↳ The position indicator jumps to the end of a file.
 - ↳ The position indicator jumps to the start of the next file.
- 2 Press **-** while the device is in stop mode.
 - ↳ The position indicator jumps to the start of a file.
 - ↳ The position indicator jumps to the end of the previous file.



Note

- If the file contains index marks or recorded instructions, press **+/-** to jump to the previous or the next index mark or instruction.
 - ↳ The index number is displayed for one second.

Playback a recording

- 1 While the device is in stop mode, press **+/-** to select the file to play and locate the beginning of the recording.
- 2 Move the slide switch to the **▶ PLAY** position to start playback.
- 3 Press **+/-** to adjust the volume.
- 4 Move the slide switch to the **■ STOP** position to stop playback.
 - ↳ Playback is paused at the current position. The device returns to stop mode.



Tip

- Turn on the noise reduction function for better playback quality. Noise reduction reduces the background noise and improves the intelligibility of quieter voices. (→ Noise reduction, p. 27).

Adjusting playback speed

- 1 Press **F3 (Speed)** repeatedly during playback to toggle between faster, slower and normal playback speed.
 - ↳ Playback speed becomes faster (+30 %) and the **▶** icon will be displayed.
 - ↳ Playback speed becomes slower (-25 %) and the **▶▶** icon will be displayed.
 - ↳ Playback returns to normal speed and the **▶** icon will be displayed.

Quick search

You can scan backward or forward in the current file at a fast speed. This allows to find a specific part of the recording.

- 1 Move the slide switch to the **◀ REW** position during playback or when the device is stopped.
 - ↳ to scan backward in the current file at a fast speed.
- 2 Press and hold **FWD** during playback or when the device is stopped.
 - ↳ to scan forward in the current file at a fast speed.



Note

- If the file contains index marks or recorded instructions, scanning backward or forward stops for 1 second at the index mark or instruction.



Tip

- Playback sound during quick search can be activated or deactivated. This allows you to listen to the recording while forwarding or rewinding. (→ Acoustic feedback, p. 28).

Delete

You can delete individual files from the device, part of a file or delete all files simultaneously.



Note

- Deleted files can not be recovered.
- Files that are marked finished and locked (EOL) cannot be deleted. Unlock it by pressing the **EOL** button.
- Make sure that the memory card is not set to read-only (locked).

Delete a file

- 1 While the recorder is in stop mode, press **+/-** to select the file to be deleted.
- 2 Press **F2 (Menu)** and select **File > Delete file**.
- 3 Press **F2 (OK)** to confirm the deletion.
 - ↳ The file is deleted. Sequential file numbers are reassigned automatically.

Delete part of a file

- 1 While the recorder is in stop mode, press **F2 (Menu)** and select **File > Delete section**.
- 2 Using the play, forward or rewind functions, navigate to the beginning of the section to be deleted.
- 3 While the recorder is in stop mode, press **F3 (Mark)**.
- 4 Using the play, forward or rewind functions, navigate to the end of the section to be deleted.
 - ↳ The section to be deleted is marked in red.
- 5 While the recorder is in stop mode, press **F2 (Delete)** to confirm the deletion of the marked section.

Delete all files

- 1 While the recorder is in stop mode, press **F2 (Menu)** and select **File > Delete all**.
- 2 Press **F2 (OK)** to confirm the deletion.
 - ↳ All files are deleted.

5 Use more of your recorder

Voice-activated recording

When voice-activated recording is enabled, recording will start when you begin speaking. When you stop speaking, the device will automatically pause recording after three seconds of silence, and resume only when you begin speaking again. Use the voice-activation threshold to set the volume at which the device should begin recording.

- 1 Activate the voice-activated recording feature in the settings menu (→ Settings, p. 25).
 - ↳ When activated, the **VA** symbol is displayed in the information bar at the top of the screen.
- 2 To start recording, point the microphone toward the sound source and move the slide switch to the **● REC** position.
 - ↳ The device switches to standby mode. Recording will start when you begin speaking (or the sound level is above the voice-activation threshold).
 - ↳ When you stop speaking (or the sound level drops below the voice-activation threshold), the device will automatically pause recording after three seconds and the LED flashes.
- 3 Press **+/-** during recording to adjust the voice-activation threshold.
- 4 To stop recording, move the slide switch to the **■ STOP** position.

Index marks

Index marks can be used to mark certain points in a recording as points of reference.

- 1 To add an index mark, press **F1 (Index)** during recording or playback.
 - ↳ The index number is displayed for one second.
 - ↳ Up to 32 index marks can be set per file.
- 2 To locate an index mark, press **+/-** while the recorder is in stop mode (→ Selecting a file, p. 18).
- 3 To delete an index mark, play, fast forward or fast rewind to the index mark to be deleted. While the recorder is in stop mode, press **F2 (Menu)** and select **File > Index clear**.

Assign keywords (author ID and work type)

One or more keywords, such as the author's name or a work type, can be assigned to every recording. Keywords can be used to identify recordings and automatic file routing in Philips SpeechExec software.



Note

- Keywords must first be set up with Philips SpeechExec software. → Advanced configuration, p. 24.
- By default, the keyword category **Author** with the keywords 'DPM18900' and '- - -' (empty) and the category **Work type** with the keywords 'Memo', 'Letter', 'Fax' and 'Report' are available.

Assign an author name

- 1 While the recorder is in stop mode, press **F2 (Menu)** and select **File > Author**.
↳ a list of author names is displayed.
- 2 Press **+/-** to select an author name.
- 3 Press **F2 (OK)** to assign the selected author name to the recording.

Assign a work type

- 1 While the recorder is in stop mode, press **F1 (Work type)**.
↳ a list of work types is displayed.
- 2 Press **+/-** to select a work type.
- 3 Press **F2 (OK)** to assign the selected work type to the recording.

Instructions

Spoken instructions are recorded comments by the author that are directed to the person transcribing the recording. They usually contain information which is relevant to the recording but does not have to be typed out.

- 1 To record an instruction, press and hold **F3 (Instr)** during recording.
↳ The instruction is displayed as a blue line on the file position bar.
- 2 To locate an instructions, press **+/-** while the recorder is in stop mode (→ Selecting a file, p. 18).
- 3 To delete an instruction, follow the steps for deleting a part of a recording (→ Delete part of a file, p. 19).





Note

- Instructions can only be recorded when the recording format is DSS/DSS Pro.

File lock and priority

Use the file lock function to prevent important files from being accidentally deleted and mark them as finished. With the priority-setting option, urgent recordings can be prioritized during transcription.

- 1 While the recorder is in stop mode, press the **EOL** button to lock the file and mark it as finished.
 - ↳ The  symbol is displayed.
 - ↳ A new, empty recording is created.
- 2 To assign priority status to the recording, press the **EOL** button again within half a second.
 - ↳ The  symbol is displayed.
- 3 To make changes to the file, unlock it by pressing the **EOL** button.



Note

- Philips SpeechExec software can be configured to download only those files from the device to the computer that are marked finished.
- Locked files are deleted when the memory card is formatted or the delete-all-files function is used.

Hands-free recording and transcription

The recorder can be used for hands-free recording and transcription by connecting the optional Philips foot pedal LFH2210 to the docking station. In this operating mode, you can control the recording and playback functions with the foot pedal.





Tip

- Use the auto-backspace feature to jump back the configured number of seconds in the recording when restarting playback.
- To activate the auto-backspace feature, press **F2 (Menu)** on the recorder while the recorder is in stop mode and select **Device > Auto backspace**.

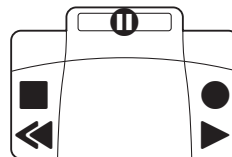
Hands-free recording



- 1 Make sure that the docking station is NOT connected to a computer via USB.
- 2 To activate the hands-free recording feature, press **F2 (Menu)** on the recorder while the recorder is in stop mode and select **Device > Hands-free mode > Dictate**.
- 3 Connect the foot pedal to the foot pedal port  on the rear side of the docking station and place the recorder in the docking station.
 - ↳ The  symbol is displayed in the information bar at the top of the screen.
- 4 Press the middle pedal of the foot pedal to enter record-standby mode. To start recording, press the right pedal

of the foot pedal. The behavior for starting and stopping recording depends on the setting of the switch on the underside of the foot control:

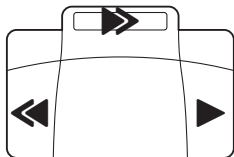

- N (Neutral) position: Press and hold the right pedal for recording. For short pauses, release the right pedal.
 - T (Toggle) position: Press and release the right pedal to start recording. For short pauses, press the right pedal of the foot pedal again. To continue recording, press the right pedal of the foot pedal again.
- 5 To stop recording, press the left pedal of the foot pedal. To continue recording, repeat step 4.
 - 6 Press and hold the left pedal of the foot pedal for fast rewind. When rewinding reaches the desired position, release the pedal.
 - 7 When recording is stopped, press the right pedal of the foot pedal to start playback. The behavior for starting and stopping playback depends on the setting of the switch on the underside of the foot control:
 - N (Neutral) position: Press and hold the right pedal for playback. When the pedal is released, playback is stopped.
 - T (Toggle) position: Press and release the right pedal to start continuous playback. Press the right pedal again to stop playback.
 - 8 Double click the left pedal of the foot pedal during recording to finish/lock (EOL) the current recording and create a new file.

Hands-free transcription



- 1 Make sure that the docking station is NOT connected to a

computer via USB.

- 2 To activate the hands-free transcription feature, press **F2 (Menu)** on the recorder while the recorder is in stop mode and select **Device > Hands-free mode > Transcribe**.
- 3 Connect the optional Philips foot pedal to the foot pedal port  on the rear side of the docking station and place the recorder in the docking station.
 - ↳ The  symbol is displayed in the information bar at the top of the screen.
- 4 Press and hold the left pedal for fast rewind. When rewinding reaches the desired position, release the pedal.
- 5 Press and hold the middle pedal to fast forward. When forwarding reaches the desired position, release the pedal.
- 6 Press the right pedal to start playback. The behavior for starting and stopping playback depends on the setting of the switch on the underside of the foot control:
 - N (Neutral) position: Press and hold the right pedal for playback. When the pedal is released, playback is stopped.
 - T (Toggle) position: Press and release the right pedal to start continuous playback. Press the right pedal again to stop playback.



Note

- If the docking station is connected to a computer, you can switch between USB mode and hands-free mode. In USB mode the recorder is displayed as an external drive on the connected computer.
- The function is only available when the switch on the underside of the foot pedal is in the N position and the recorder is in the stop mode and at the end of the current recording.
- To switch between USB mode and hands-free mode, double click the right pedal of the foot pedal and then hold the pedal for about 1 second.

Use Philips SpeechExec software

Philips SpeechExec software (Windows version only) can be used for advanced configuration of the recorder, automatic download, conversion and routing of files.



Note

- For detailed information about SpeechExec software, refer to the SpeechExec help.

Advanced configuration

Philips SpeechExec software provides a wizard that guides users through the configurations and settings of the device. The wizard assists in configuring time format, sound feedback, voice-activated recording, display appearance, recording profiles, keywords, and file download to the computer.

- 1 Connect the recorder to the computer using the USB cable or the docking station.
- 2 Start Philips SpeechExec Pro software and click **Settings** > **General settings** on the menu bar and select **DPM Configuration** > **DPM Wizard** from the list on the left panel.
- 3 Click the **Start Wizard...** button to open the wizard and follow the on-screen instructions to customize the recorder.
- 4 Click the **Finish** button to close the wizard and confirm the transfer of the new settings to the recorder.



Note

- When the recorder is connected to the computer for the first time, Windows detects the new hardware and automatically installs the required drivers. When the installation is complete, Windows may prompt you to restart the computer.

Download recordings to the computer

With USB mass storage support, the recorder is automatically displayed as an external drive when it is connected to the computer. It can then be accessed easily with any program as a regular drive.

Use Philips SpeechExec software for automatic download, conversion, and routing of files.

- 1 Make a recording with the recorder.
- 2 Start Philips SpeechExec Pro software.
- 3 Connect the recorder to the computer using the USB cable or the docking station.
- 4 By default, the recordings on the recorder will be downloaded automatically to the computer and moved to the **Finished dictations** folder of the work list.



Note

- How and which files are downloaded after the recorder is connected to a computer can be configured in the settings menu of Philips SpeechExec software or with the configuration wizard.

6 Settings

Use the menu

- 1 Press **F2 (Menu)** while the recorder is in stop mode to open the menu.
- 2 Press **+/-** to select the next/previous menu item.
- 3 Press **F3 (Enter)** to enter a sub menu. Press **F1 (Back)** to exit the menu.
- 4 Press **+/-** to select a function.
- 5 Press **F2 (OK)** to confirm a selection or **F1 (Back)** to exit a sub menu without changing a setting.



Note

- Some settings, such as defining keywords, file encryption or device lock, are available only through Philips SpeechExec software. → Advanced configuration, p. 24.

Menu list

File

Delete file
 Delete section
 Priority high / normal
 Lock / EOL
 Index set / clear
 Author
 Work type
 Delete all
 File information

Record

Profile
 Line-in

Record notification beep
 Edit mode
 (Encryption)
 Voice activation

Display

Brightness
 Backlight
 Appearance
 Record lamp
 Language

Device

Beep
 Acoustic feedback
 Power save
 Date & time
 Slide switch
 Auto backspace
 Device information
 Format card
 USB charge
 USB audio
 Hands-free mode
 Diagnosis file
 Reset settings
 Noise reduction

File menu

Delete file

Delete individual files from the device. → Delete a file, p. 19.

Delete section

Delete part of a file. → Delete part of a file, p. 19.

Priority high / normal

With the priority-setting option, urgent recordings can be prioritized during transcription. You can select **High** (the  symbol is displayed) or **Normal**. The default value is **Normal**. → File lock and priority, p. 22.

Lock /EOL

Use the file lock function to prevent important files from being accidentally deleted and mark them as finished. → File lock and priority, p. 22.

Index set / clear

Index marks can be used to mark certain points in a recording as points of reference. → Index marks, p. 20.

Author, Work type

One or more keywords, such as the author's name or a work type, can be assigned to every recording. Keywords can be used to identify recordings and automatic file routing in Philips SpeechExec software. → Assign keywords (author ID and work type), p. 21.

Delete all

Delete all files simultaneously from the device. → Delete all files, p. 19.



File information

Display information about the current file, such as file number, file name, assigned keywords, barcode information, recording date and time.



Record menu

Profile

The recording profile presets recording parameters such as recording quality and file format, microphone sensibility and the microphone mode to suit the recording conditions. The profile's symbol is displayed in the information bar at the top of the screen.

-  **Personal**: customize all settings.
 - » **Recording quality**: set the file format and the quality of the recording (bit rate). The higher the recording quality the bigger the file and the less recordings you can create.
 - > **DSS SP**: .dss, mono, 13.7 kbit/s
 - > **DSS QP**: .ds2, mono, 28 kbit/s
 - > **MP3 Stereo**: .mp3, stereo, 192 kbit/s
 - > **PCM Voice**: .wav, mono, 353 kbit/s
 - > **PCM Stereo**: .wav, stereo, 705 kbit/s
 - » **Microphone sensitivity**: adjust the recording sensitivity to avoid recording background noises and to adapt to the recording environment.
 - > **Meeting**: high sensitivity
 - > **Dictate**: medium sensitivity
 - > **Private**: low sensitivity
 - » **Microphone mode**: the microphone mode can be controlled by the integrated motion sensor. The motion sensor senses when the device is placed on the desk or held in the hand and sets the microphone mode accordingly.
 - > **Directional**: focus on the right microphone and filter sounds from the side.
 - > **360 degrees**: records sounds in all directions.
-  **Meeting**: optimized for the recording of multiple sound sources, such as meetings and conferences with a small num-

ber of people (Recording quality: MP3 Stereo, Microphone sensitivity: Meeting (high), Microphone mode in hand: 360 degrees, Microphone mode on desk: 360 degrees).

-  **Dictate**: optimized setting for the recording of a sound source close to the device (Recording quality: DSS QP, Microphone sensitivity: Dictate (medium), Microphone mode in hand: 360 degrees, Microphone mode on desk: 360 degrees).
-  **Speech recognition**: optimized for subsequent editing using speech recognition software (Recording quality: DSS QP, Microphone sensitivity: Private (low), Microphone mode in hand: Directional, Microphone mode on desk: 360 degrees).

Note

- All recording profiles can be customized with Philips SpeechExec software. → Advanced configuration, p. 24.

Line-in

If you connect an external microphone to the device, the recording source will switch automatically and the device's microphones will be turned off. Set the line-in option depending on the external source:

- **Off**: connect an external mono or stereo microphone
- **On**: connect an amplified recording source (e.g. a stereo system)

Record notification beep

Enable/disable a beep tone indicating recording is about to begin.

Edit mode

You can edit an existing recording by overwriting a part of it or inserting additional recording. → Add to or overwrite a recording, p. 17.

Encryption

Recordings can be encrypted in real time using the Advanced Encryption Standard (AES or Rijndael Algorithm) with a key length of 256 bits. AES provides a very high degree of security and has been approved in the USA for the most highly classified government information.

Note

- Encryption must be set up with Philips SpeechExec software. → Advanced configuration, p. 24.
- Encryption is only supported for files in DSS Pro format.
- When encryption is activated, the  symbol is displayed in the information bar at the top of the screen.
- Encrypted files can only be played with Philips SpeechExec software.

The device itself can be assigned a PIN code to protect against unauthorized use or file playback.

Voice activation

When voice-activated recording is enabled, recording will start when you begin speaking. When you stop speaking, the device will automatically pause recording after three seconds of silence, and resume only when you begin speaking again. → Voice-activated recording, p. 20.

Display menu

Brightness

Adjust the brightness of the display. The brightness level of the display will affect how quickly the device consumes battery power.

Backlight

Set the length of time the device waits before turning off the display's backlight:

- **Auto**: adjusts the brightness of the display automatically and turns off the display's backlight after 8 seconds.
- **8 sec** (default)
- **20 sec**
- **On**

Appearance

Select a display mode: **Advanced** (default), **Classic**. → Start-up screen, p. 9.

Record lamp

Enable/disable the LED light.

Language

Set the language for the device's user interface: **English**, **Deutsch**, **Français**, **Español**, **Italiano**. → Set the language, p. 15

Device menu

Beep

Enable/disable key and signal tones.

Acoustic feedback

Allows you to listen to the recording while forwarding or rewinding. → Quick search, p. 18.

Power save

Set the length of time before the recorder will enter into power-save mode: **1 min**, **5 min** (default), **10 min**, **15 min**, **Off**. → Power-save mode, p. 15.

Date & time

The date and time entered are saved with each recording as the recording time. → Set the date and time, p. 15

Slide switch

You can customize the functionality of the slide switch. By default, the slide switch is set to **International**.

Position	International	Philips	Philips classic*	German
1	●	◀◀	◀◀	◀◀
2	■	▶/●	▶/●	■/⏏
3	▶	■/⏏	■/⏏	▶/●
4	◀◀	▶▶	▶▶	▶▶

* EOL and REC STANDBY buttons switch functionality.

Auto backspace

Move the slide switch briefly to the **◀◀ REW** position to jump back the configured number of seconds in the recording: **Off** (default), **1 sec**, **2 sec**, **3 sec**, **4 sec**.

Device information

Display information about the device, such serial number, model number and firmware version. → Display device information, p. 30.

Format card

Deletes all recordings and files saved on the device. → Memory formatting, p. 30.

USB charge

Change the charging behavior of the device. If the USB port of your computer does not supply enough power capacity (500 mA), charging may not be successful. Set the USB charge option to **Slow [100 mA]** or **Off** and use an (optional) power supply.

- **Fast [500 mA]** (default)
- **Slow [100 mA]**
- **Off**

USB audio

When set to **On**, the device can be used as audio output device for the computer when it is connected via the USB cable.

Hands-free mode

The recorder can be used for hands-free recording and transcription by connecting the optional Philips foot switch LFH2210 to the docking station. In this operating mode, you can control the recording and playback functions with the foot switch.

→ Hands-free recording and transcription, p. 22.

Diagnosis file

Save a diagnosis file for error analysis and a file with all device configuration settings on the memory card.

Reset settings

Reset your settings to the factory default values.

Noise reduction

Turn on the noise reduction function for better playback quality. Noise reduction reduce the background noise and improves the intelligibility of quieter voices.

7 Service

Do not perform any maintenance operations that are not described in this user manual. Do not disassemble the device into its component parts to carry out repairs. The device may only be repaired in authorised service centers.

Display device information

- 1 In stop mode (start-up screen), press **F2 (Menu)** and select **Device > Device information**.
↳ General device information is displayed: serial number, model number, firmware version of the device.
- 2 Press **F1 (Back)** to return to the stop mode.

Memory formatting

- 

Caution

 - Formatting the memory deletes all recordings and files saved on the device.
- 1 In stop mode (start-up screen), press **F2 (Menu)** and select **Device > Format card**.
 - 2 Press **F3 (Enter)**, then press **F2 (OK)** to confirm the formatting.

- 

Tip

 - Press **F1 (Back)** to cancel the operation.

Updating the firmware

Your device is controlled by an internal program called firmware. As a part of ongoing product maintenance, the firmware is upgraded and errors are corrected.

It is possible that a newer version (an “update”) of the firmware has been released since you purchased the device. In this case you can easily update your device to the latest version.

- 

Caution

 - The battery should be fully charged to prevent the power supply being interrupted during the update.
- 1 Connect the device to the computer using the USB cable or the docking station.
 - 2 Download the firmware update for your model from the website www.philips.com/dictation onto your computer.
 - 3 Copy the new firmware file to the root directory of the device.
 - 4 Disconnect the device from the computer.
↳ The firmware is automatically updated. This may take a few minutes.

- 

Caution

 - Wait until the firmware update is complete before calling up other device functions. Failure to properly update the firmware may result in the device malfunctioning.

- 

Tip

 - Firmware updates can be performed automatically via Philips SpeechExec software. → Use Philips SpeechExec software, p. 24.

Troubleshooting

Problem	Possible cause/solution
The device does not turn on	<ul style="list-style-type: none"> • Battery is empty. ↳ Recharge the battery. • The device is turned off. ↳ Turn the power on. → Power on/off, p. 14. • The device is in power-save mode. ↳ Lift up the recorder or press any button to reactivate it.
The device does not playback recordings	<ul style="list-style-type: none"> • No recordings are saved in the device.
The device does not respond	<ul style="list-style-type: none"> • Turn the power off and on again. → Power on/off, p. 14.
I cannot hear anything from the speaker	<ul style="list-style-type: none"> • Headphones are connected to the device. ↳ Unplug the headphones. • The volume is at the lowest setting. ↳ Adjust the volume level.
Recording does not start	<ul style="list-style-type: none"> • There is no memory card in the device. ↳ Insert a memory card into the device. → Insert and eject the memory card, p. 13 • Memory card is not formatted correctly. ↳ Format the memory card in the device. → Memory formatting, p. 30 • The the available memory space for recording is full. ↳ Delete some files or move them to an external device. • The file is locked. ↳ Unlock the file. → File lock and priority, p. 22 • The memory card is locked. ↳ Unlock the memory card.
I cannot hear anything from the headphones	<ul style="list-style-type: none"> • The headphones are incorrectly connected. ↳ Check the headphone connection. • The volume is at the lowest setting.

8 Technical data

Connectivity

- Headphones: 3.5 mm
- Microphone: 3.5 mm
- USB: high-speed USB 2.0
- Docking connector
- Memory card slot

Display

- Type: color TFT
- Diagonal screen size: 2.4 inches / 6.1 cm
- Resolution: 320 × 240 pixels

Storage media

- Exchangeable memory card
- Memory card types: SD/SDHC, up to 32 GB
- Mass storage class compliant

Audio recording

- Recording format: DSS/DSS Pro (Digital Speech Standard), MP3, PCM
- Built-in microphone: 1 directional microphone, 1 microphone for 360 degree recording
- Recording modes: DSS QP (.ds2/mono), DSS SP (.dss/mono), MP3 (.mp3/stereo), PCM Voice (.wav/mono), PCM Stereo (.wav/stereo)
- Bit rate: 13.7 kbit/s (DSS SP), 28 kbit/s (DSS QP), 192 kbit/s (MP3), 353 kbit/s (PCM Voice), 705 kbit/s (PCM Stereo)
- Recording time (4 GB memory card): 700 hours (SP), 350 hours (QP), 50 hours (MP3), 27 hours (PCM Voice), 13 hours (PCM Stereo)
- Sample rate: 44.1 kHz (MP3), 22.05 kHz (PCM), 16 kHz (DSS QP), 12 kHz (DSS SP)

Sound

- Speaker type: built-in round dynamic speaker
- Speaker diameter: 28 mm
- Speaker output power: 200 mW

Power

- Battery type: Philips rechargeable Li-ion battery ACC8100
- Battery lifetime: up to 27 hours of recording (QP mode), up to 200 hours standby
- Charging time (full charge): 3 hours

Security

- Real time file encryption
- Encryption standard: Advanced Encryption Standard (AES or Rijndael Algorithm) with 256 bits
- Device lock with pin code

Green Specifications

- Compliant to 2011/65/EU (RoHS)
- Lead-free soldered product

Operation conditions

- Temperature: 5° – 45° C / 41° – 113° F
- Humidity: 10 % – 90 %, non-condensing

Specifications

- Product dimensions (W × D × H):
53 × 123 × 15 mm / 2.1 × 4.8 × 0.6 inches
- Weight: 117 g / 4.1 oz

Federal Communications Commission notice

This equipment has been tested and found to comply with the limits for a Class B digital device, pursuant to part 15 of the FCC rules. These limits are designed to provide reasonable protection against harmful interference in a residential installation.

Modifications

The FCC requires the user to be notified that any changes or modifications made to this device that are not expressly approved by the manufacturer may void the user's authority to operate the equipment.

Cables

Connections to this device must be made with shielded cables with metallic RF/EMI connector hoods to maintain compliance with FCC rules and regulations.

Canadian notice

This Class B digital apparatus meets all requirements of the Canadian interference-causing equipment regulations.

Avis Canadien

Cet appareil numérique de la classe B respecte toutes les exigences du règlement sur le matériel brouilleur du Canada.

Declaration of conformity

Model number: DPM8900
Trade name: Philips Pocket Memo meeting recorder
Responsible party: Speech Processing Solutions USA Inc
Address: Two Ravinia Drive, Suite 965,
Atlanta, GA 30346, USA
Telephone number: 888-260-6261
Website: www.philips.com/dictation



DPM8900

Tested to comply with FCC standards
FOR HOME OR OFFICE USE

This device complies with Part 15 of the FCC rules. Operation is subject to the following two conditions: 1) This device may not cause harmful interference. 2) This device must accept any interference received, including interference that may cause undesired operation.

CE Declaration of Conformity



The conformity with the relevant EU directives is confirmed by the CE mark.

Declaration of conformity

Speech Processing Solutions GmbH hereby declares that the device DPM8900 fully comply with the basic requirements and other relevant provisions of directives 2006/95/EC, 2004/108/EC and 2009/125/EC. A complete declaration of conformity for this product is available at www.philips.com/dictation.

Neither Speech Processing Solutions GmbH nor its affiliates shall be liable to the purchaser of this product or third parties with respect to claims for damages, losses, costs or expenses incurred by purchaser or third parties as a result of an accident, misuse or abuse of this product or unauthorized modifications, repair, modification of the product or failure to meet the operating and maintenance instructions provided by the manufacturer.

MPEG Layer-3 audio coding technology licensed from Fraunhofer IIS and Thomson Licensing.

This user manual is a document with no contractual nature. We accept no liability for changes, mistakes or printing errors.



Specifications are subject to change without notice.

© 2016 Speech Processing Solutions GmbH. All rights reserved. Philips and the Philips shield emblem are registered trademarks of Koninklijke Philips N.V. and are used by Speech Processing Solutions GmbH under license from Koninklijke Philips N.V. All trademarks are the property of their respective owners. Document version 1.2, 2016/01/15. Document number 5103 109 9776.4