

Brandt

dishwasher

**OPERATING
INSTRUCTIONS**

Contents list

	Page
Safety precautions	3
Installation - Technical characteristics	4
Electrical connections	5
Softening the water	6
Adding the rinse aid	7
Loading the dishwasher	7 - 8
Adding the detergent	9
Programming	9
Choice of programmes	10
Operation	11
Option : building the free-standing machine in	12
Cleaning and maintenance instructions	13
Information for test laboratories	13
Troubleshooting	14
After-Sales Service	

**BEFORE READING THE INSTRUCTIONS, UNFOLD THE LAST
PAGES OF THIS LEAFLET, CONTAINING THE ILLUSTRATIONS**

Presenting your dishwasher Fig. 1

Safety precautions

Please read the information in this instruction leaflet carefully. It gives all the information you need for safety, installation, use and guarantees for the appliance. We advise you to keep this leaflet and to pass it on to the new owner if you sell the machine.

Please be sure to comply with the information below, so that we can fulfil our responsibilities :

- Dispose of the packaging in a suitable manner and comply with legal standards regarding protection of the environment.

- If there is any visible damage to the machine, do not connect it to the mains power supply, but contact your supplier.

- The machine must be located in a frost-free environment. In the event of frost, the hydraulic components may be damaged.

- The inlet and outlet pipes must be connected in accordance with the leaflet. Incorrect connections can lead to damage.

- In order to ensure good stability, flush-fitting machines must be installed under a continuous work top fixed to the adjoining cabinets.

- Do not climb or lean on the door of the dishwasher when it is open. The machine can overbalance or be damaged.

- The machine is designed as a dishwasher and must not be used for any other purpose.

- We advise you to only use dishwasher products and not solvents.

- You should store dishwasher products as well as other cleaning products out of the reach of children. These products have a corrosive effect on the mouth and pharynx if they are swallowed.

- Keep dishwasher products as well as other cleaning products out of reach of children. These products, if they are swallowed, have a corrosive effect in the mouth and pharynx.

- If the machine does not operate correctly for reasons other than those mentioned in this leaflet, disconnect the machine from the mains power supply (pull out the plug) or disconnect the fuse in the circuit concerned and contact our after-sales service.

- Broken machines should be taken to the closest recycling centre. Destroy the door closing system so it no longer works (children may close themselves in whilst playing and suffocate). Cut the electric cable after having removed the plug from the socket.

- You are strongly advised to disconnect the machine after use and turn off the water supply.

- Do not allow children to play with the machine or handle it.

- The water inside the machine is not drinkable.

- When the machine is running, do not open the door. This may provoke important steam leakage or splattering of water.

Installation

Levelling : Adjusting the feet (Fig. 4)

Make sure that the machine is properly upright and stable. The four feet may be altered, adjust them if necessary using a wrench or a screwdriver. Badly adjusted feet may move the door off centre and make the machine unstable.

IMPORTANT: Do not connect the dishwasher to the power or water supply before completing installation.

If you are installing your dishwasher on carpet, adjust the feet so that you leave space for air to circulate underneath the machine.

Free-standing model

You can use the top of the machine as a worktop. You are advised not to place the dishwasher too close to a source of heat, or the edging of the worktop may be damaged.

The machine can be built in. In that case, see **page 12**.

Soundproofing apron (Fig 15)

(on some free-standing models)

For optimum soundproofing, make sure the apron delivered with the machine is correctly installed.

Having adjusted the feet for height :

- ① - Tilt the dish-washer backwards slightly so as to clip the apron onto the bottom of the plinth. Make sure it is correctly clipped at both ends and the centre.
- ② - Adjust the height of the apron; snip the end with a pair of scissors and cut one or more strips off it by hand.
The apron should touch the floor.

Connection to the water supply (Fig. 2)

Unless otherwise indicated on the original pipe, never connect your dishwasher to a hot water supply.

Use the water supply pipe supplied with the machine. Do not forget to place the joint in the tap end of the pipe. The water pressure may vary from 1 to 10 bar. In the event of high pressure, it is advisable to fit a pressure regulator. Your Water Company will give you the necessary information.

Protection against water damage

• The **anti-overflow** safety device. The system automatically activates the drain pump if the water level in the tub rises too high.

• **Anti-leakage device.** This system interrupts the water supply if a leak is detected underneath the machine.

If one of these mechanisms is started, contact the after-sales service to put it back into working order.

Evacuating waste water (Fig.3)

Connect the drain pipe

A With a ventilated siphon. The drain pipe should be free in the siphon and should be no deeper than 20 cm.

B The sink U-bend. Attention : do not forget to remove the siphon cover.

C Directly into the sink.

Be careful to fix the drain pipe down to avoid flooding.

In any case, the end of the pipe must be between 60 cm and 1 m high.

Avoid folding the pipe when installing.

Supply pipe length : 1,50 m In all cases, the connection must comply with the standards in force in the country concerned, together with the supplementary regulations of the Electricity Authority. The protection system and the model of the machine are marked on the plate on the inside of the door on the left. The machine must be switched off when the connection is made to the electrical circuit.

Electrical connections

IMPORTANT : ENSURE THAT THE ELECTRICITY SUPPLY IS SWITCHED OFF BEFORE CONNECTING.

Your appliance must be connected to fixed wiring via the use of a double pole switched fused spur outlet with at least 3mm contact separation, with a pilot lamp. (See technical data for fuse rating).

We strongly recommend the appliance is connected by a qualified electrician who is a member of the N.I.C.E.I.C who will comply with the I.E.E and any local regulations.

NOTE: The terminology "DOUBLE POLE" means that both the live and neutral supplies are switched and disconnected at the same time.

The terminations labelled SUPPLY are for the connection for the internal house wiring and the terminations labelled LOAD are for connection for the appliance.

I M P O R T A N T

The wires in this mains lead are coloured in accordance with the following code:-

Green & Yellow	Earth
Blue	Neutral
Brown	Live

As the colours of the wires in the mains lead of this appliance may not correspond with the terminal in your plug, proceed as follows; The wire which is coloured Green and Yellow must be connected to the terminal which is marked with the letter «E» or by the earth symbol \perp or coloured Green or green and Yellow.

The wire which is coloured Blue must be connected to the terminal which is marked with the letter «N» or coloured Black.

The wire which is coloured Brown must be connected to the terminal which is marked with the letter «L» or coloured Red.

Technical characteristics

Voltage : 230-240 V - Fusibles : 13 A

Power : 2150-2300 W

Capacity 14 place settings

Water pressure 1-10 bar

Water evacuation pipe height : 60-100 cm

Your dishwasher complies with the following European Directives 73/23/CEE (low voltage directive), 89/336/CEE (electromagnetic compatibility) modified by the directive 93/68/CEE.

Replacing the electric lead

WARNING: In the interests of safety, the electrical supply lead should ONLY be replaced by the manufacturer's after-sales staff or a similarly qualified person.

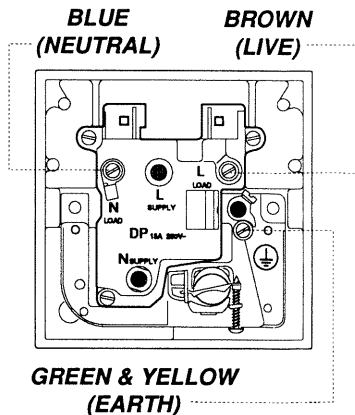
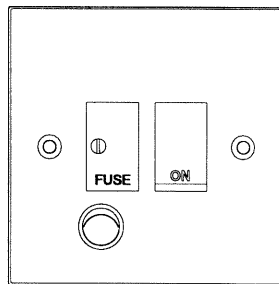











Softening the water

To adjust the softener on the control panel

The water softener should be properly adjusted to optimise salt consumption and for best washing results :

- Check the hardness of the water using the water-testing strip provided.
- Adjust the water softener following the instructions with the strip and using the table opposite.

Hold down the “Condenser drier”  button and press “Start”  . You can then tell which hardness is selected, by the “Wash  ”, “Rinse  ” and “Dry  ” lights :

Light on or flashing	Hardness of your water supply (in British clarke degrees)	salt requirements	Number of washes between two fills (about)
 light on	0 to 7°	NO	—
 light on	7 to 10.5°	YES	120
 light on	10.5 to 14°	YES	50
 light flashing	14 to 21°	YES	30
 light flashing	22 to 28°	YES	20
 light flashing	≥ 28**	YES	15

Your machine is **pre-set** for medium-hard water between 7° and 10.5 ° (the “Rinse” light is on).

If you want to change this, hold down the “Condenser drier”  button and press “Start”. This adjustment helps you to save water during regeneration.

*** For water at more than 28° (“Drier” light flashing), consult your retailer.**

If you move or your water supply changes, adjust the water hardness settings. Check with your local water company.

Filling the container with regenerating salt (fig. 5)

Filling with salt is essential for the regeneration of the resins that soften the water so removing the hardness from it, except if the water supply is already sufficiently soft. (see “Adjusting the water softener).

You should fill just before starting the programme.

- 1 - Unscrew and remove the salt container cap.
- 2 - Use a funnel to pour: fill the container with **regenerating salt** specially designed for dishwashers.
- 3 - **The first time, fill up with water**
Screw down the salt container cap again properly.

Important: If adjusting the water softener does not require the addition of regenerating salt (Wash light on), **you should nevertheless fill the salt container with water before using. Never pour detergent into the container, you will destroy the water softener**

Only use “special dishwasher” regeneration salt. Do not use table salt, cooking salt, etc. These salts can contain insoluble elements and will cancel out the effect of the softener.

Identifying the regenerating salt level

A light on the control band tells you to add regenerating salt.

Adding the rinse aid

Rinsing product is necessary as it avoids stains on the dishes and makes drying easier.

IMPORTANT! Only use products intended for dishes and NOT detergents intended for hand washing !

Filling and adjusting the rinsing product container (Fig. 6 - 7)

Put the door in a horizontal position when filling the container and unscrew the cap in the door clockwise.

Fill to just below the to the adjusting lever.

If the product overflows during filling, remove the excess with a sponge to avoid foam forming.

If you experience stains or bad drying after several cycles, you may if necessary adjust the dosage using the selector:

Soft water : level 1 to reduce the dose

Hard water : level 3 to increase it.

Finding the level of the rinsing product.

A light on the control band shows you requirements in rinsing product when the door is ajar.

Loading the dishwasher

In order to obtain good cleaning results, be sure to remove any large food residues before switching on the machine. Any burnt or stuck-on residues must be removed beforehand.

The model dish-washer has two racks for 14 place-settings, or 162 items (figures 10-11-13), to standard DIN 44990. Always point the inside of the crockery downwards. Ensure that no item conceals another and that nothing obstructs the spraying facility. After switching on, check that the spraying arms can move freely. No item should overlap the baskets.

Lower basket (Fig. 8 - 9 - 10)

Place the dishes so that water may circulate freely and spray all the utensils. (Avoid attaching and piling dishes up).

This basket is especially intended to hold: plates, cutlery, dishes, frying pans, saucepans.

Put large-sized plates and frying pans on the side.

Avoid mixing plates and soup dishes. **You should preferably place same-sized plates together. Place soup dishes at the back, in the high pin area.**

Make sure nothing obstructs the rotation of the lifting arm (saucepan handles, cutlery or large dishes).

The baskets in the **bottom rack fold away (fig. 9B)** to take large dishes.

The cutlery trays slide and can be put anywhere on the lower basket. You can adjust them according to the dishes you wash.

Removable grids are available if you wish to load cutlery in an orderly fashion.

For optimum washing, you can use these separation grids.

Cutlery : (Fig. 13)

- Place handles downwards.
- Separate silverware from other metals using the separating grill.
- It is preferable to place small spoons in the separating grids.

IMPORTANT NOTE : For reasons of safety, we recommend you place sharp-ended table knives blade down in the cutlery basket.

Long-bladed cutlery and other sharp utensils should be placed flat in the upper basket.

Loading the dishwasher

Upper basket (Fig. 11 - 12)

This basket is particularly intended to hold glasses, cups, ramekins, small salad bowls, bowls, saucers etc...

Place glasses so that they do not touch and tip them sufficiently so that they do not retain any water. **Place the hollow end of glasses, cups and bowls facing downwards.** Arrange the dishes methodologically to gain space (rows of glass, cups, and bowls)

Use the height adjustable holding bar for large glasses or large-stemmed glasses.

Cups, ladles, etc... can be arranged too on the rack.

The upper basket should be adjusted to the HIGH position when loading large plates in the lower basket. The setting can be executed basket in charge.

① **Setting the HIGH POSITION**
Slowly lift the basket until you hear a **click** on each side.

② **Setting the LOW POSITION**
Lift the basket completely on both sides (**click**) and then follow it downwards.

Make sure that the two runners are adjusted to the same level.

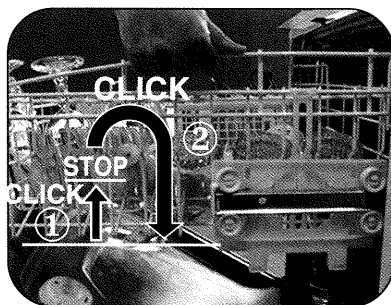

Economical and ecological washing

Do not pre-wash your dishes by hand.

Use all the capacities of your dishwasher. It will wash economically and ecologically.

Always choose the programme best adapted to the stains and the type of dishes.

Avoid using too much detergent, regenerating salt and rinsing liquid. Observe the recommendations contained in this manual (pages 6 and 7) as well as the product manufacturer's instructions.

Make sure that the water softener is properly adjusted. (see page 6)

Objects not suitable for your dishwasher

- Wooden chopping boards
- Pewter or copper objects
- Non-stainless steel objects
- Cutlery with wooden, horn or mother-of-pearl handles
- Antique or hand-painted crockery

When buying dishes or cutlery, check they are suitable for dishwashers.

Adding the detergent

The washing product container has been placed in front of the upper basket to make the machine easier to fill. This means that you can load the washing powder without bending down or completely opening the door.

The distributor offers you a choice between using tablets or powder or liquid detergent.

Before starting the programme :
put the **tablet** in the upper compartment.

Put the tablet in the outside compartment. Using tablets is particularly recommended for the Eco 55°C programme and for full loads of dishes.

Or,

Pull the container to fill with washing **powder** or **liquid** and fill up to:

Minimum setting for slightly dirty dishes

Maximum setting for dirty dishes

Close the container

VERY IMPORTANT: keep all products out of the reach of children and away from humidity.

Use washing products specifically designed for dishwashers. See the manufacturers' recommendations on the packet as well as the advice for use below.

tablet

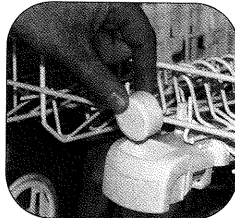

powder or liquid

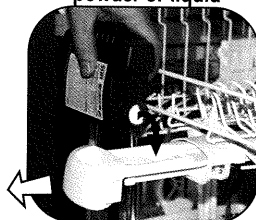



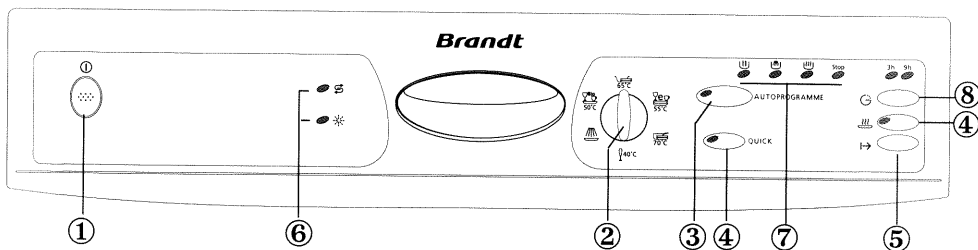

Programming

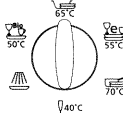

- ① "ON/OFF" BUTTON : press this button to switch the machine on.
- ② PROGRAMME KNOB : turn this knob to select your programme.
- ③ "AUTOPROGRAMME" : press this button to run an automatic programme.
- ④ DRY OPTION BUTTON : Press this button if you want the Condenser-drying option.
- ⑤ "START" BUTTON : press this button to start the programme.
- ⑥ INDICATOR LIGHTS : more regenerating salt or rinse-aid required.
- ⑦ LIGHTS : show you how the programme is progressing, and also used to adjust for water hardness.
- ⑧ DELAYED START BUTTON : press this button to delay the start of the programme.

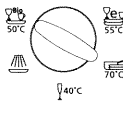
Choice of programmes

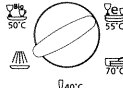
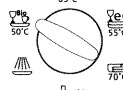
List of programmes	Position of programme selector
WASH 65 °C Recommended for dirty crocks with a normal amount of dry or sticky food. Everyday crockery. This programme is particularly suitable for powder or liquid detergent.	
ECO WASH 55 °C Recommended for dirty crocks with a normal amount of dry or sticky food. Everyday crockery. This programme is particularly suitable for tablet detergent.	
INTENSIVE WASH 70 °C Recommended for very dirty crocks with a large amount of dry or sticky food. Grease, sauces, burnt-on food, frying pans, gratin dishes. Everyday crockery and cooking utensils.	
FRAGILE WASH 40 °C Recommended for fragile and not very dirty crockery with a very small amount of dry or sticky food. Glasses, fine china not suited to high temperatures.	
SOAK This is a very short cycle that does not use detergent. It is used for rinsing crockery that is not to be actually washed for another day or so.	
BIO WASH 50 °C Recommended for not very dirty, non-greasy crockery with a small amount of dry or sticky food. Tea things or everyday crockery.	

AUTOPROGRAMME

This standard programme is suitable for all types of washing-up. When selected it cancels all other programmes or options.

The autoprogramme triggers a system for detecting dirty water. This gives optimum wash performance with ease of programming.

OPTIONS :

You can choose any programme and then press in either of these buttons

“Quick wash” option

Recommended for slightly dirty, non-greasy or fragile crockery. This option reduces the wash temperature (except on the “Fragile - 40°C” programme), and the length of the cycle.

“Condenser dry” option

To dry the contents completely, your dish-washer has a condenser drier system.

After the final hot rinse, the steam condenses on the walls of the machine where a cold area has been created by a curtain of cold water. As soon as the machine stops, you can open the door and your crockery will be perfectly dry.

(Energy information page 11)



Operation

- Open the door and load the dishwasher. Make sure the crockery does not obstruct the rotating arms.
- Pour washing powder into the distributor.
- Close the door.

To select “Autoprogramme”

When you switch on, this programme is selected automatically. The “Autoprogramme” or “Sensor clean” light comes on and stays on until the end of the cycle.

Selecting this option cancels all other programmes or options.

When the wash is complete, the automatic programme remains in memory.

To select a programme (other than “Autoprogramme”)

Switch on the machine, and set the selector knob to the chosen programme.

If the “Autoprogramme” or “Sensor clean” light is on, press the button to switch it off.

To select an option





Press the button for the chosen option. The appropriate light will come on, and will go off at the end of the programme. The “Condenser dry” option will remain in memory at the end of the wash.

To cancel any option, press the button a second time and the light will go off. You can then select another option if you wish.

To select “Delayed start”

After choosing your programme, press “Delayed start”. This will delay the start of the wash for three hours. If you press it a second time, the delay will be nine hours. The light will come on to indicate your choice. Confirm it by pressing the “Start” button. The programme will begin automatically at the chosen time.

To start the wash

Press the “Start”  button. The wash programme will begin. The “wash ”, “rinse ” and “dry ” lights will come on in turn to indicate what stage the programme has reached.

At the end of the programme

The “Stop” light will come on and the other programme lights will go out.

To cancel a programme while it is running

Hold the “Start” button down for three seconds. The “Stop” light will come on and the other lights will go out.

The missing product indicator lights goes on when the machine is turned on.

salt :  Lights up when salt is low. After you have added regenerating salt it may stay on until the salt has dissolved sufficiently. This happens generally after a cycle (or if you have not properly filled the machine – see page 6) for example when starting off with the sample.

Note : Where water is particularly soft regenerating salt is not needed but the light will remain on.

rinsing product :  Goes on, door ajar, when you should add rinsing product (see filling page 7).

	<u>Water*</u>	<u>Electricity</u>
AUTOPROGRAMME	13L./21 L.	1,05-1,50 kWh
65 °C	13L./15 L.	1,30 kWh
55 °C Eco	14L./16 L.	1,15 kWh
70 °C INTENSIVE	18L./20 L.	1,50 kWh
Bio 50°C + Quick	13L./15 L.	0,85 kWh
Eco 55°C + Quick	14L./16 L.	1,08 kWh

* according to drying

The values correspond to normal conditions of use. They may vary with the load, the temperature, the hardness of water or the supply voltage.

Option : building the free-standing machine in

Built-in option

If you want to build the machine in under an existing work-top, **you will have to fix the front frame to a solid work-top.** To do this:

- Remove the top panel by unscrewing the two screws located under the edge of the top panel.
- Slide the machine into place.
- Adjust the heights of the feet if necessary (Fig. 4).
- Fix your dishwasher to the kitchen worktop by two screws under the front frame.

If your dishwasher is underneath a work surface with a hob, you must add thermal insulation to the top of the machine. You can obtain this thermal insulation kit from your dealer.

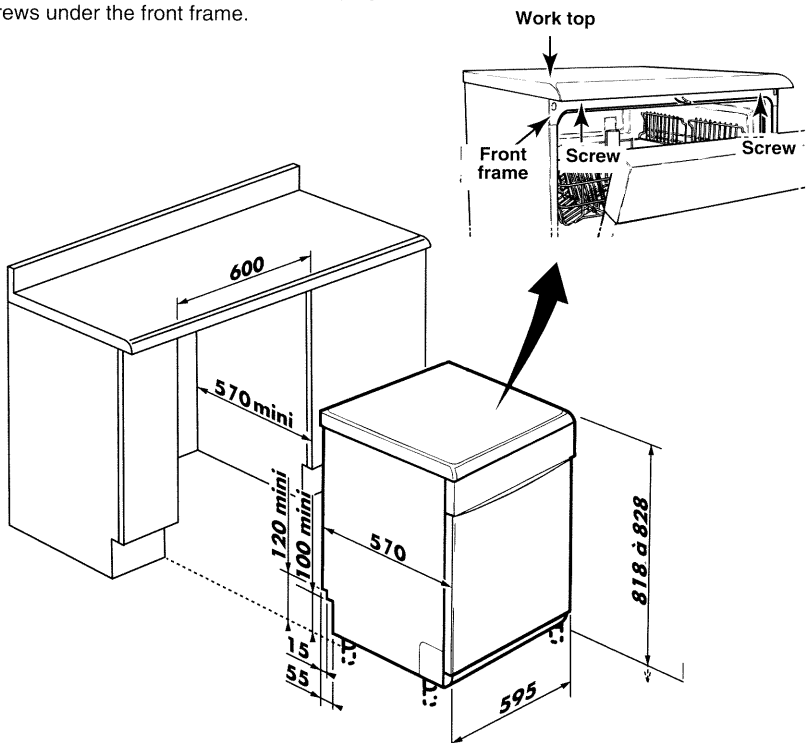

Cleaning and maintenance instructions

- Your dishwasher comes with a self-cleaning pulse filter that constantly filters small particles of dirt trapped in the washing bath.

The filter and the main filter cannot be dismantled as the cleaning arm constantly cleans them.

Regularly clean the waste trap (Fig. 14). Pull the handle, remove the residue with a brush and clean with tap water. Put back in to its housing making sure you clip it down properly.

Clean as necessary

- Underneath the filters, around the door and the door joint with a damp sponge to remove any deposit.
- **Use only soap and water for the bodywork and control board.**

Do not clean with abrasive powders, scouring pads, spirit-based products or solvent.

Use preferably a cloth or a sponge.

- If you have stainless steel door you may use products adapted for stainless steel. See the manufacturer's instructions for advice on their use.

Every year

To maintain your machine in perfect working order you should clean it once or twice a year. Run an intensive programme with the machine empty and a special dishwasher cleaning product available from any reputable dealer.

Prolonged period of non-use

Clean your machine completely then unplug the electricity supply and close the water tap. Keep the machine away from frost.

Information for test laboratories

COMPARATIVE TESTS

- Capacity 14 place settings according to **FIG. 10 - 11-13**
- Rinsing product set at 2
- Quality of washing product : 35 g product B
- Upper basket : Setting the High Position.
- With the drying button condenser

It is essential that the softener be adjusted to a setting immediately above the recommended one, according to the hardness of your water, to take into account the lack of phosphate in the standardised detergent.

IEC 436, DIN 44990 : Programme "Wash 65°C"

EN 50242: Programme "Eco 55°C + Quick"

Troubleshooting

Problems	Causes
The dishwasher will not start	<ul style="list-style-type: none">- Is it plugged in ?- Is the door properly closed ?- Is the water connected ?- Check that the "delayed start" is on "0" (according to the model)
The dishes are not properly washed (or their are stains in it)	<ul style="list-style-type: none">- Programme choice. Choose the programme best adapted to the type of wash- Make sure nothing is blocking the circulation of the water- Check the dishes are properly arranged.- Only use specially designed washing products- Check the waste well, filters, arms, joints and door rim are clean- Clean the filter- Check that the washing arm can freely rotate
Greasy stains	<ul style="list-style-type: none">- Increase the dose of washing product- Use a new packet of washing product- Choose a better adapted programme
Limescale deposits on the dishes	Check it is limescale (clean with vinegar). If yes : <ul style="list-style-type: none">- Check the hardness of the water
The dishes are dull	Too soft water is aggressive for glasses. <ul style="list-style-type: none">- Check the hardness of the water- Reduce the softener and if necessary remove the regenerating salt.
Traces of salt (salty taste on the dishes)	<ul style="list-style-type: none">- Add water to the salt pot and reload if necessary.- Cap badly closed.
Blackened or marked silverware	<ul style="list-style-type: none">- Remove food residue immediately after use- Separate silverware from other metals- Choose detergent recommended for silverware
Traces of rust on knife blades	<ul style="list-style-type: none">- Use knives suitable for dishwashers
The dishwasher does not empty	<ul style="list-style-type: none">- Remove the siphon stop valve- Check the drain pipe is not bent or crushed- You have moved your dishwasher and have tipped it backwards. To restart the pump, unhook the draining rod, lay it on the floor at the end of a basin, draining should restart. Then turn off the "Start/Stop" button, put the draining rod back and restart your programme.
	<p>This machine complies with all applicable safety standards. Any repairs should be carried out by a qualified technician. Repairs carried out by unqualified technicians may be dangerous for the user.</p>

If you have problems not covered by these remarks, consult your dealer or After-Sales Service. Have the machine type, series number or that mentioned on the rating plate (inside the door) ready. You will so avoid unnecessary delays and cost.

The photograph above, with the lower basket removed, shows the main points described in this Instruction Book.

- 1 - Work top
- 2 - Upper basket
- 3 - Cleaning liquid container
- 4 - Regenerating salt container
- 5 - Self-cleaning micro filter
- 6 - Rating plate (After sales service references)
- 7 - Lower sprinkling arm
- 8 - Main filter
- 9 - Waste trap
- 10 - Rinsing product container

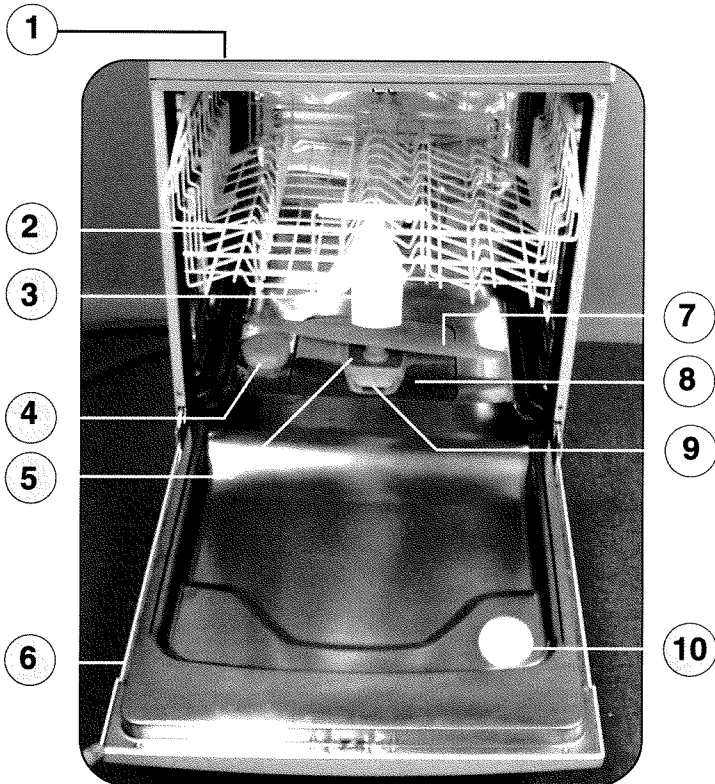

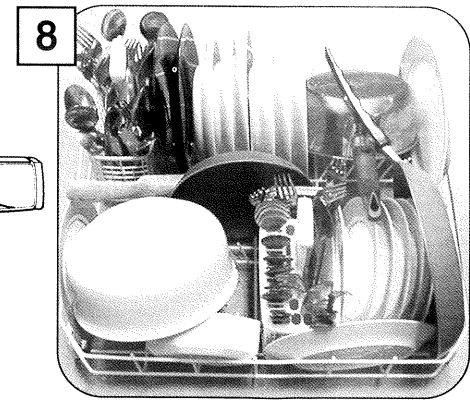
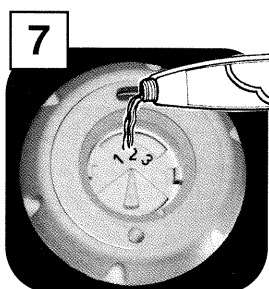
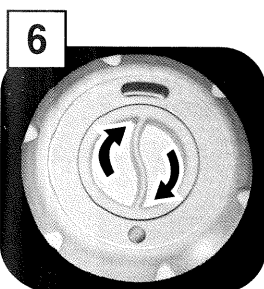
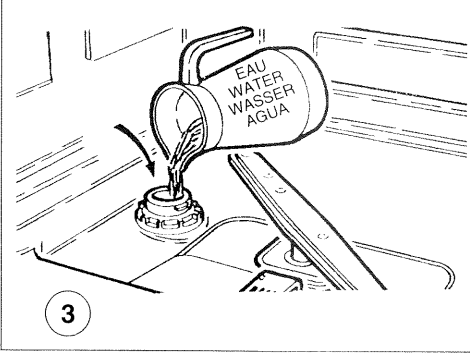
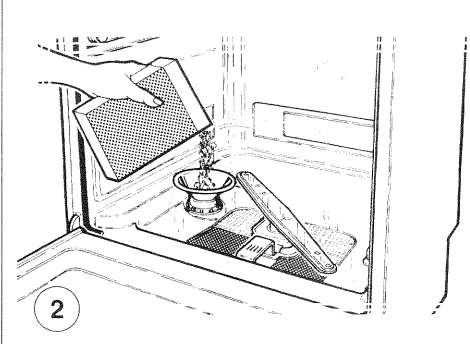
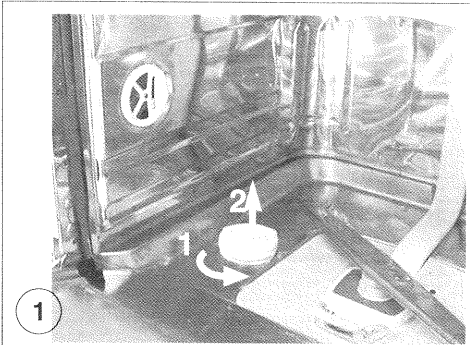
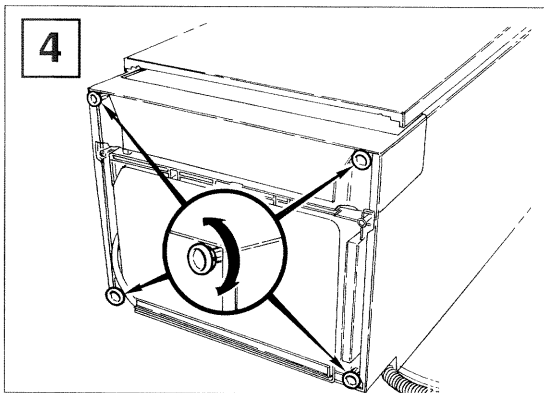
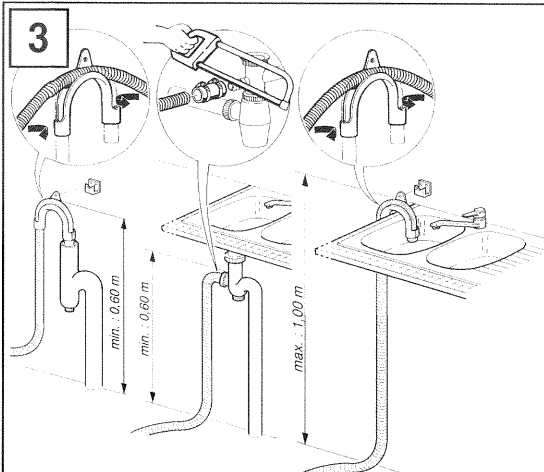
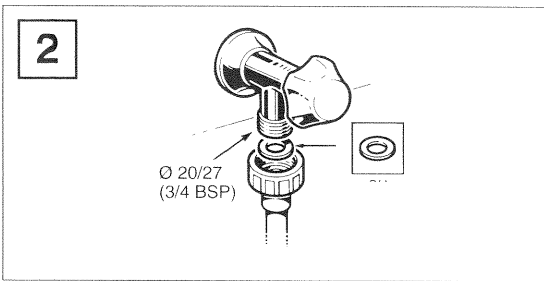



9

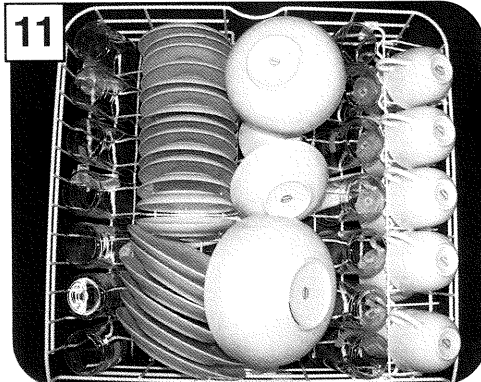

11

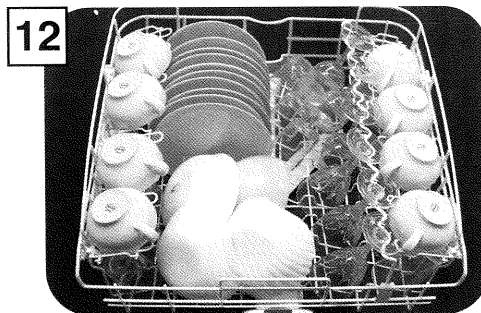
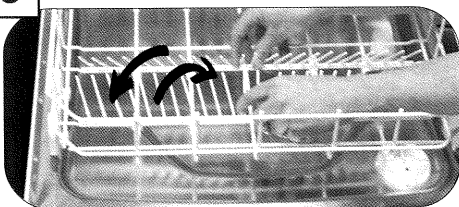

12

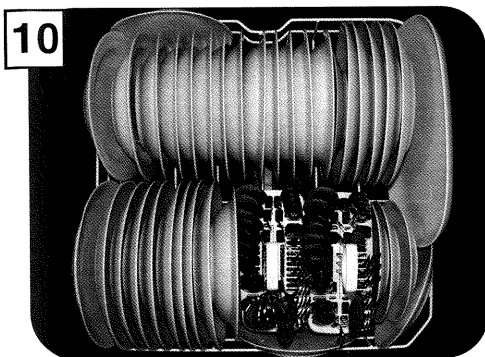

10

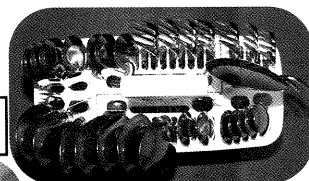

13

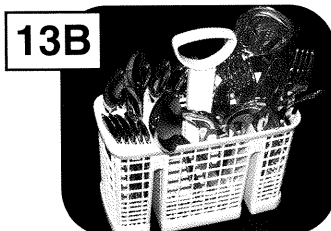
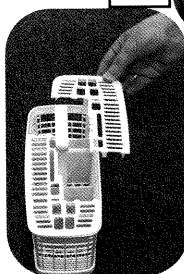

13B

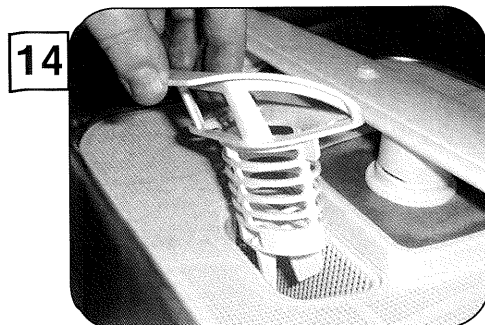

14

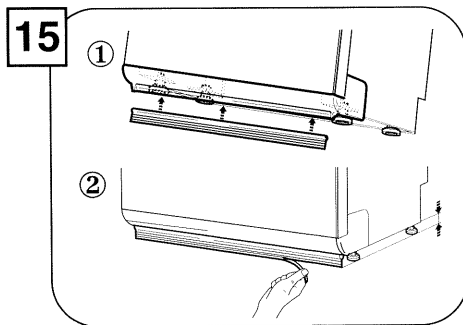

15

①

②

After-Sales Service

- Congratulations on the purchase of your appliance, which has been manufactured to the highest specification and should give you many years of use.
- Your appliance is guaranteed for all electrical and mechanical failures for a period of twelve months from the date of purchase: providing the appliance has been installed and used in accordance with the instructions. Please retain your receipt as proof of purchase.
- This warranty is only valid for domestic users and not where the appliance is used for commercial purposes.
- This warranty does not affect your statutory rights.
- In the unlikely event of there being a problem, please call 0870 600 1301 where trained staff are available to advise or book a service call to one of our authorised service agents. It will help to be prepared when calling by having the model number of the appliance ready - this can be found on the rating plate.

BRANDT UK LIMITED
INTEC FOUR
WADE ROAD
BASINGSTOKE
HANTS RG24 SNE

TEL.: 0870 600 1301
FAX: 01256 34 6877