

KLEENMAID

**"SUPER SILENT SYSTEM"
DISHWASHER
Model DW 6**

OWNERS MANUAL

Contents

1 . Getting Started

Basic Steps	Pages 1
How to Arrange the Dishes	2, 3
Adding the Detergent	4
Filling the Rinse Aid Dispenser	5
The Wash Programmes	6
Selecting a Wash Programme	7

2 . Washing Dishes by Machine

Glassware	8
Plastic	8
Pots and Saucepans	8
Silverware	8
Cutlery	9
Decorated China and Tableware	9
Woodware	9

3. Machine Information

Care and Cleaning	10
Problem Solver	11, 12

4. Warranty and Service Centres

Basic Steps

Here is a basic guide to using your dishwasher.
More detailed advice can be found in the pages that follow.

1. Arrange your dishes in the dishwasher baskets.
(see pages 2, 3).
2. Put 2 Tablespoon of detergent into the detergent dispenser. (see page 4).
3. Fill the rinse aid dispenser. This will last for about 60 washes (see page 5).
4. Select a normal wash by rotating the programme selector to position 3 (see page 7).
5. Close the door. Press the ON/OFF button to turn the dishwasher on. The indicator light will show (see page 7).

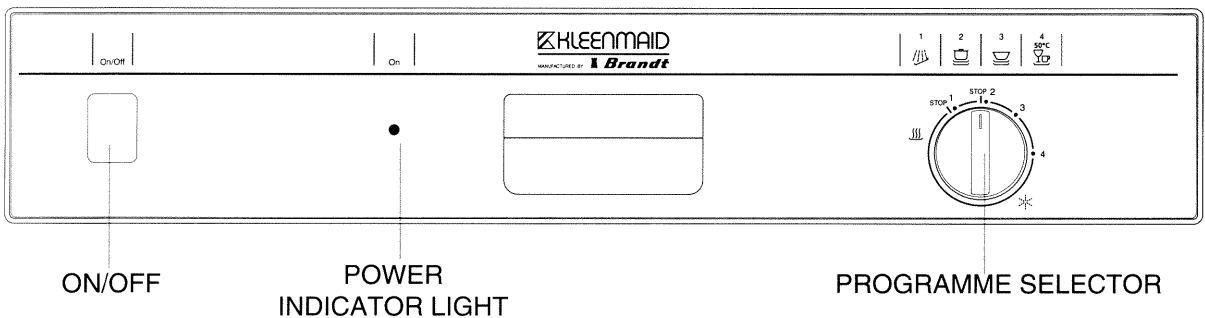

How to arrange the dishes

Correct loading of the Dishwasher will ensure good washing results.

Upper Basket

The height of the upper basket can be adjusted. This allows you to arrange tall items easily in either basket.

- Unlock the small plastic end stops on the runners then remove the basket.
- Replace the basket in the new position then relock the end stops.

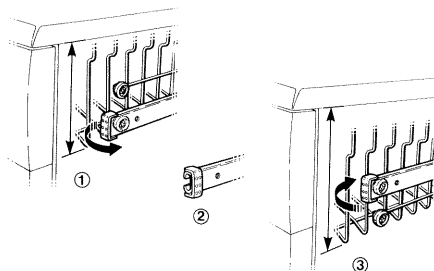

The upper basket is for cups, glasses and plates, small and delicate items. The glass rack ensures that wine glasses or light dishes are held safely.

Scrape off food scraps and place cups, glasses and bowls upside-down in the racks.

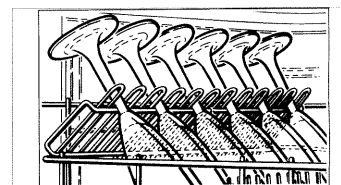
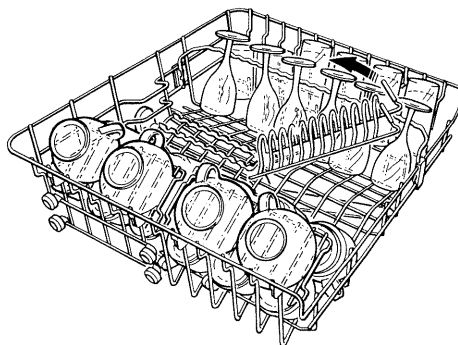

Long cutlery items such as ladels and long knives can be laid flat in the upper basket.

Take care not to overload the basket.

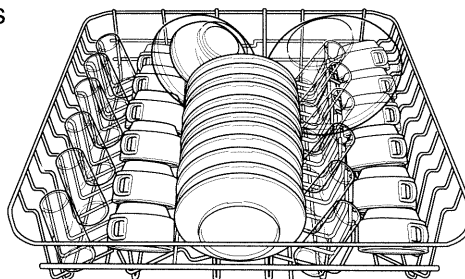

How to arrange the dishes

Lower Basket

The lower basket takes large dirty items, dinner plates, bowls, pots, lids, cutlery etc.

The racks in the lower basket are removable and can be arranged to suit your dishes.

Scrape off food scraps and arrange dinner plates in racks so they face the centre. Place mixing bowls and saucepans upside-down and tilted toward the centre of the dishwasher.

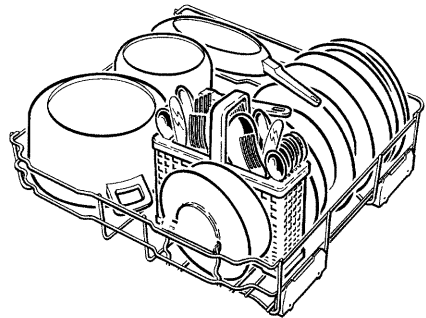
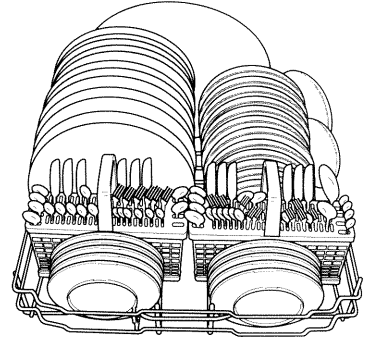

Cutlery Basket

Two removable cutlery baskets sit in the lower basket. Place cutlery in these baskets so that handles point down.

Mix spoons, knives and forks within each section of the basket.

Keep stainless steel and silver cutlery separate.

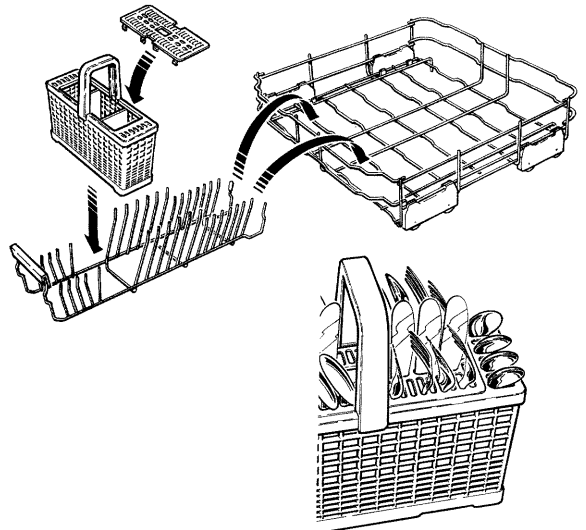

Adding the detergent

Put detergent in the dispenser before each wash (except for Rinse & Hold). The detergent will be released automatically during the wash.

The dispenser is located on the inside of the dishwasher door. To open the detergent compartment, press the latch.

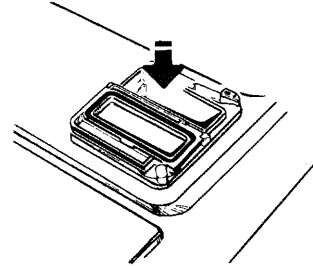

- Put 2 Tablespoon of detergent (40 g) into the dispenser.
- Close the compartment lid firmly.

Note ! Lid will not close if timer knob is past cycle 3.

- For a cycle where a pre-wash is provided (programme 2 only) a better wash result will be obtained by placing 10 g (2 teaspoons) of detergent on the inside of the door as indicated. This will ensure the prewash will be assisted by detergent. Upon filling with water for the regular wash portion the normal detergent charge from the dispenser will be released.

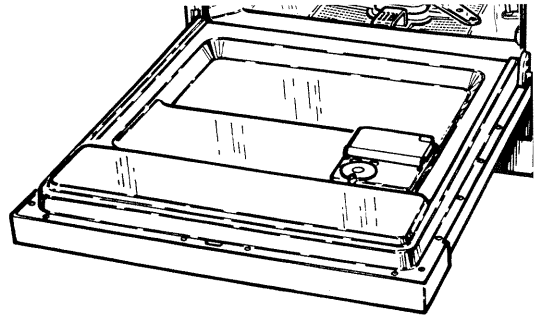

IMPORTANT

- Only use a detergent suitable for domestic automatic dishwashers.
- Never use hand washing-up liquids, soap powder, laundry powder or disinfectant. These will damage the dishwasher.
- Never sprinkle or pour detergent directly onto any item in the dishwasher.

For Child Safety

Warning - Dishwasher detergents are strongly alkaline. They can be extremely dangerous if swallowed. Avoid contact with skin and eyes and keep children away from the dishwasher when the door is open.

Check that the detergent receptacle is empty after completion of the wash cycle. !

Filling the Rinse Aid Dispenser

Rinse aid is an important part of the wash system. Rinse aid helps you get spot free dishes and improves drying. A small volume of rinse aid will be automatically released into the final rinse.

The rinse aid dispenser is on the inside of the dishwasher door. When filled the dispenser holds enough for about 60 washes.

- Open the dispenser by unscrewing the filler cap.
- Pour the rinse aid into the dispenser, taking care not to overfill it.
- Close the dispenser by re-screwing the cap.

As rinse aid is used, the level indicator will become clear indicating the need for refilling.

- container full
- ◐ container nearly empty
- container empty, refill dispenser.

How much Rinse Aid ?

The quantity of rinse aid dispensed can be adjusted as necessary.

- If there are white streaks on dishes and glassware after the final rinse or you live in a soft water area, turn the dispenser regulator to a lower rinse aid setting.
- If there are water marks on the dishes and glassware after the final rinse or you live in a hard water area, turn the dispenser regulator to a higher rinse aid setting.

To modify the dispenser adjustment, unscrew the filler cap, turn the adjustment ring with a coin.

If you are unsure about the condition of your water supply contact your local water supply authority or plumber. They will know.

For Child Safety

Dishwashing detergent and rinse aid should be treated as poisons and stored where they are not accessible to children.

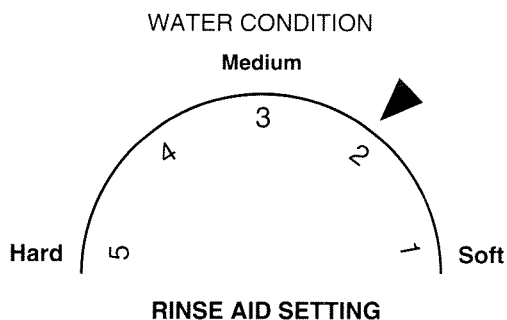
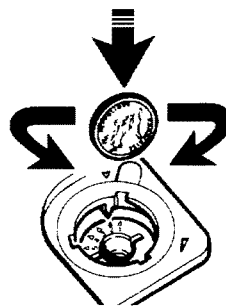
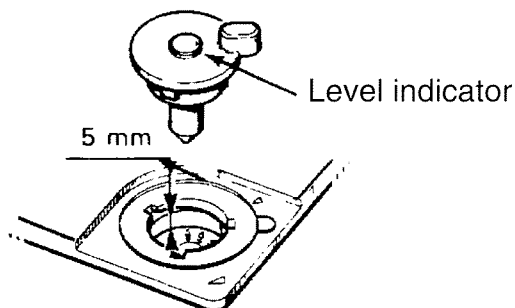



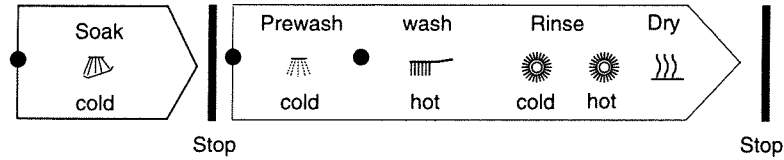

The Wash Programmes

PROGRAMME SEQUENCE



PROGRAMME SELECTION

PROGRAMME	Symbol	Consumption data		
		Water	Energy (K Wh)	Time (min.)
SOAK : Cold rinse to ensure that food residues do not dry onto the tableware before washing. When soak cycle is selected timer knob will stop at cycle 2.	1 	6	/	4
WASH AT 65°C + COLD PREWASH : For use with heavily soiled tableware (pans, dishes, etc.).	2 	27	1,8	96
WASH AT 65°C WITHOUT PREWASH For use with normally soiled tableware.	3 	20	1,7	86
ECONOMY PROGRAMME - 50°C Use with lightly soiled and slightly greasy tableware.	4 	18	1,3	67

Selecting a Wash Programme

Selecting a wash programme

1. Open the door and load the dishwasher. Check that the tableware is not obstructing the sprayarms.
2. Fill the detergent dispenser and close the lid. If using a cycle with a prewash, add detergent to the door as described on pg 4.
3. Close the door securely.
4. Make sure the water tap is turned on.
5. Turn the programme selector knob to the desired cycle.
6. Press the ON/OFF button. The indicator light will show.

The programme will now commence.

Do not attempt to open the door during the cycle or to change the programme selection until the cycle has finished. When the programme has ended the indicator will be in the STOP position.

8. Press the ON/OFF button.
9. Turn off the water tap.
10. Wait at least 30 minutes before opening the door to allow the full drying effect to occur.

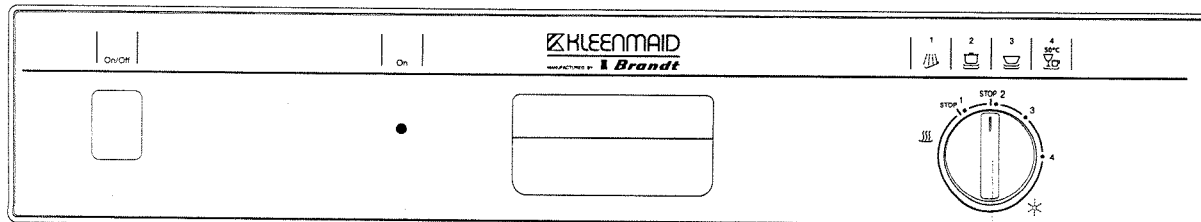

Glassware, Plastics, Pots and Silverware

Glassware

Most glassware is dishwasher safe. We do not recommend washing crystal items in the dishwasher, as crystal is not dishwasher safe.

Plastic

- Soft plastic can change shape when heated. We recommend that you don't put soft plastic items in the dishwasher.
- Place small plastic items under the cup rack so they don't flip over.

Pots and Saucepans

- Pots and saucepans can be washed in the dishwasher. Scrape off food scraps and put items in the baskets upside-down.
- Stainless steel can be washed in the dishwasher.
- As when hand washed, aluminium is dulled by being washed in the dishwasher.

Silverware

- All silverware should be rinsed immediately after use to prevent discolouration caused by some foods. The RINSE & HOLD programme is useful for this situation.
- Old silverware and hollow handle knives with adhesives securing the handles should be washed by hand.

Cutlery, China and Woodware

Cutlery

- Stainless steel and silver should not be allowed to come into contact with each other, as this can stain the silver.
- Remove sterling and silver plated cutlery from the dishwasher and hand dry it immediately after the programme has finished.
- Wooden, bone and plastic handles can be sensitive to higher water temperatures. The appearance of these items may change over time if washed in the dishwasher.

Decorated China and Tableware

- Most current china patterns are dishwasher safe.
- Older items with the design over the glaze, gold rims and hand-painted China may be more sensitive to machine washing. If in doubt, wash these items by hand.

Woodware

Generally wooden items are sensitive to heat and water.

Regular use in the dishwasher may alter their appearance. We suggest you wash wooden items by hand.

Remember, if in doubt about any aspect concerning materials washed in the dishwasher, follow manufacturer's instructions or wash the item by hand.

Care and Cleaning

Do not use abrasive or solvent cleaners which may damage the surface finishes.

Checking the Spray Arms

Check the spray arms regularly to ensure the holes are not blocked.

To remove the spray arms :

- Unload both dishwasher baskets and slide them out.
- Unscrew the spray arms. Shake out all foreign particles, rinse in water and replace.
- Ensure plastic top spray arm and steel bottom spray arm have side with most holes facing upwards.

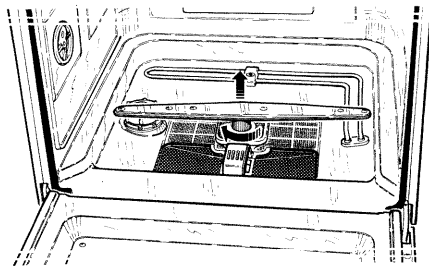

Care and cleaning

Your dishwasher is fitted with the most advanced self-cleaning micro-filter system. In ordinary use it will not require cleaning.

The secondary or main coarse filter may require cleaning depending upon the types of soil that are present on the dirty tableware. Remove it by lifting upward. Dismantle and clean as per diagram. Use running water and a small brush if necessary.

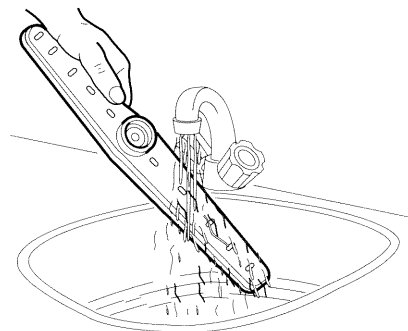

Cleaning the spray arms.

Remove the spray arms by un-screwing and flush under running water to remove any food scraps. Re-fit and ensure they turn freely.

Regular cleaning.

It is important to regularly wipe over with a damp cloth the door seals and mating surfaces. Food deposits will be routinely removed ensuring hygiene and enhanced performance.

Maintenance or periods without use.

Twice per year run programme N° 2 without tableware but including detergent. If the machine is to remain unused for an extended period ensure the inside and door seal are clean. Leave the door open and make sure both power and water are turned off.

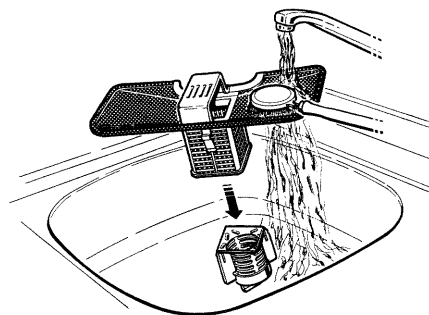

Problem Solver

If the dishwasher does not appear to be operating properly, check this chart before you call your Dealer or Authorised Service Centre for service.

PROBLEM	POSSIBLE CAUSE	WHAT TO DO
Dishwasher won't start	Electrical supply	Check power cord plugged in and switched on
	Door is not closed Tap is not open	Close door firmly Check tap is turned on
Greasy spots	Not enough detergent	Increase quantity of detergent used
	Detergent too old Baskets are overloaded	Use new pack of detergent Take care that dishes are correctly arranged in the baskets
Detergent deposited on the dishes	Too much detergent Water is saturated	Reduce detergent quantity
Food particles deposited on dishes	Filter or microfilter are blocked	Carefully remove and clean filters
Tea, coffee, juice stains etc...	Not enough detergent	Increase quantity of detergent used
Poor wash result	Baskets are overloaded	Ensure spray arms can rotate freely.
	Water does not circulate correctly	Take care that dishes are correctly arranged in the baskets
	Blocked spray-arms	Check that spray-arms rotate freely. Remove and clean spray-arms
	Insufficient care / cleaning	Check that filters, spray-arms, hinges and door surround are clean
	Poor filtering	Carefully remove and clean filters
Programme selection		Select the wash programme

Problem Solver

A lot of foam in bottom of dishwasher	Rinse aid setting too high Incorrect detergent used	Lower rinse aid setting Only use detergent suitable for domestic automatic dishwasher
Poor drying	Rinse aid dispenser is empty Rinse aid setting too low	Check that there is rinse-aid in the dispenser Increase rinse-aid setting slightly
Tarnished silver	Food particles like egg, milk cheese remain in contact with silver Electrolysis following contact with other metals	Silver should be rinsed clean of any scraps immediately after use Keep stainless steel and silver items separate
The dishwasher does not drain out	You have moved your appliance and on this occasion you have tipped it backwards. Drain hose is blocked where it connects onto the "S" bend of the sink.	Unhook the drain hose, spread on the floor, with its end above a bowl ; the emptying should start again. Put the drain hose back in place. Remove hose and clean hose and sink spigot

NOTE :

The descriptions and specifications detailed in this manual are given as information only and are not to be considered as binding commitments. In reason of our concern about the quality of your products, we reserve the right to incorporate, without notice, any modifications or improvement we deem appropriate.

For your records

Date Purchased _____

Dealer _____

Serial N° _____

Model N° _____

Full, five year warranty

In addition to all statutory rights which you, the Consumer, have under all the relevant laws in respect of this appliance, during the first five years of ownership as the original purchaser of the Kleenmaid "Super Silent System" DISHWASHER, we guarantee that any fault caused by faulty material or workmanship becoming apparent, will be rectified free of charge for parts or labour, provided that all service is performed during normal working hours by Kleenmaid or their designated Agent. Where the appliance is installed outside the normal servicing area of the above, the Purchaser must pay the cost of transporting the appliance to and from the cost of transporting the appliance to and from the Agent or the Agent's travelling cost to and from the Purchaser's home.

In addition the Stainless Steel Tub is guaranteed for twenty years.

For Service

Contact

Kleenmaid National Customer Service Phone : 1 800 072 144 (Freecall)

