



■ Read the operating instructions for the unit and all other components of your car audio system carefully before using the system. They contain instructions about how to use the system in a safe and effective manner. Panasonic assumes no responsibility for any problems resulting from failure to observe the instructions given in this manual.

■ This manual uses pictographs to show you how to use the product safely and to alert you to potential dangers resulting from improper connections and operations. The meanings of the pictographs are explained below. It is important that you fully understand the meanings of the pictographs in order to use this manual and the system properly.

 **Warning**
This pictograph intends to alert you to the presence of important operating instructions and installation instructions. Failure to heed the instructions may result in severe injury or death.

 **Caution**
This pictograph intends to alert you to the presence of important operating instructions and installation instructions. Failure to heed the instructions may result in injury or material damage.

 **Warning**
Observe the following warnings when using this unit.

- ❑ **The driver should neither watch the display nor operate the system while driving.**
Watching the display or operating the system will distract the driver from looking ahead of the vehicle and can cause accidents. Always stop the vehicle in a safe location and use the parking brake before watching the display or operating the system.
- ❑ **Use the proper power supply.**
This product is designed for operation with a negative grounded 12 V DC battery system. Never operate this product with other battery systems, especially a 24 V DC battery system.
- ❑ **Keep batteries and insulation film out of reach of infants.**
Batteries and insulation film can be ingested, so keep them out of the reach of infants. If an infant ingests a battery or insulation film, please seek immediate medical attention.
- ❑ **Protect the Deck Mechanism.**
Do not insert any foreign objects into the slot of this unit.
- ❑ **Do not disassemble or modify the unit.**
Do not disassemble, modify the unit or attempt to repair the product yourself. If the product needs to be repaired, consult your dealer or an authorized Panasonic Servicenter.
- ❑ **Do not use the unit when it is out of order.**
If the unit is out of order (no power, no sound) or in an abnormal state (has foreign objects in it, is exposed to water, is smoking, or smells), turn it off immediately and consult your dealer.
- ❑ **The remote control unit should not lie about in the car.**
If the remote control unit lies about, it could fall on the floor while driving, get wedged under the brake pedal, and lead to a traffic accident.
- ❑ **Refer fuse replacement to qualified service personnel.**
When the fuse blows out, eliminate the cause and have it replaced with the fuse prescribed for this unit by a qualified service engineer. Incorrect replacement of the fuse may lead to smoke, fire, and damage to the product.

Observe the following warnings when installing.

- ❑ **Disconnect the lead from the negative (–) battery terminal before installation.**
Wiring and installation with the negative (–) battery terminal connected may cause electrical shock and injury due to a short circuit.
Some cars equipped with the electrical safety system have specific procedures of battery terminal disconnection.
FAILURE TO FOLLOW THE PROCEDURE MAY LEAD TO THE UNINTENDED ACTIVATION OF THE ELECTRICAL SAFETY SYSTEM RESULTING IN DAMAGE TO THE VEHICLE AND PERSONAL INJURY OR DEATH.
- ❑ **Never use safety-related components for installation, grounding, and other such functions.**
Do not use safety-related vehicle components (fuel tank, brake, suspension, steering wheel, pedals, airbag, etc.) for wiring or fixing the product or its accessories.
- ❑ **Installing the product on the air bag cover or in a location where it interferes with airbag operation is prohibited.**
- ❑ **Check for piping, gasoline tank, electric wiring, and other items before installing the product.**
If you need to open a hole in the vehicle chassis to attach or wire the product, first check where the wire harness, gasoline tank, and electric wiring are located. Then open the hole from outside if possible.
- ❑ **Never install the product in a location where it interferes with your field of vision.**
- ❑ **Never have the power cord branched to supply other equipment with power.**
- ❑ **After installation and wiring, you should check the normal operation of other electrical equipment.**
The continuation of their using in abnormal conditions may cause fire, electrical shock or a traffic accident.
- ❑ **In the case of installation to an airbag-equipping car, confirm warnings and cautions of the vehicle manufacturer before installation.**
- ❑ **Make sure the leads do not interfere with driving or getting in and out of the vehicle.**
- ❑ **Insulate all exposed wires to prevent short circuiting.**

 **Caution**
Observe the following cautions when using this unit.

- ❑ **Keep the sound volume at an appropriate level.**
Keep the volume level low enough to be aware of road and traffic conditions while driving.
- ❑ **Do not insert or allow your hand or fingers to be caught in the unit.**
To prevent injury, do not get your hand or fingers caught in moving parts or in the disc slot. Especially watch out for infants.
- ❑ **This unit is designed for use exclusively in automobiles.**
- ❑ **Do not operate the unit for a prolonged period with the engine turned off.**
Operating the audio system for a long period of time with the engine turned off will drain the battery.
- ❑ **Do not expose the unit to direct sunlight or excessive heat.**
Otherwise these will raise the interior temperature of the unit, and it may lead to smoke, fire, or other damage to the unit.
- ❑ **Do not use the product where it is exposed to water, moisture, or dust.**
Exposure of the unit to water, moisture, or dust may lead to smoke, fire, or other damage to the unit. Make especially sure that the unit does not get wet in car washes or on rainy days.

Observe the following cautions when installing.

- ❑ **Refer wiring and installation to qualified service personnel.**
Installation of this unit requires special skills and experience. For maximum safety, have it installed by your dealer. Panasonic is not liable for any problems resulting from your own installation of the unit.
- ❑ **Follow the instructions to install and wire the product.**
Not following the instructions to properly install and wire the product could cause an accident or fire.
- ❑ **Take care not to damage the leads.**
When wiring, take care not to damage the leads. Prevent them from getting caught in the vehicle chassis, screws, and moving parts such as seat rails. Do not scratch, pull, bend or twist the leads. Do not run them near heat sources or place heavy objects on them. If leads must be run over sharp metal edges, protect the leads by winding them with vinyl tape or similar protection.
- ❑ **Use the designated parts and tools for installation.**
Use the supplied or designated parts and appropriate tools to install the product. The use of parts other than those supplied or designated may result in internal damage to the unit. Faulty installation may lead to an accident, a malfunction or fire.
- ❑ **Do not block the air vent or the cooling plate of the unit.**
Blocking these parts will cause the interior of the unit to overheat and will result in fire or other damage.

- ❑ **Do not install the product where it is exposed to strong vibrations or is unstable.**
Avoid slanted or strongly curved surfaces for installation. If the installation is not stable, the unit may fall down while driving and this can lead to an accident or injury.
- ❑ **Installation Angle**
The product should be installed in a horizontal position with the front end up at a convenient angle, but not more than 30°. The user should bear in mind that in some areas there may be restrictions on how and where this unit must be installed. Consult your dealer for further details.
- ❑ **Wear gloves for safety. Make sure that wiring is completed before installation.**
- ❑ **To prevent damage to the unit, do not connect the power connector until the whole wiring is completed.**
- ❑ **Do not connect more than one speaker to one set of speaker leads. (except for connecting to a tweeter)**

Observe the following cautions when handling the battery for the remote control unit.

- Use only specified battery (CR2025).
- Match the polarity of the battery with the (+) and (–) marks in the battery case.
- Replace dead battery as soon as possible.
- Remove the battery from the remote control unit when not using it for an extended period of time.
- Insulate the battery (by placing them in a plastic bag or covering them with vinyl tape) before disposal or storage.
- Dispose of the battery according to the local regulations.
- Do not disassemble, recharge, heat or short the battery. Do not throw a battery into a fire or water.

In case of battery leakage

- Thoroughly wipe the battery liquid off the battery case and insert new battery.
- If any part of your body or clothing comes into contact with battery liquid, wash it with plenty of water.
- If battery liquid comes into contact with your eyes, wash them with plenty of water and get immediate medical attention.



Caution

THIS PRODUCT IS A CLASS 1 LASER PRODUCT. USE OF CONTROLS OR ADJUSTMENTS OR PERFORMANCE OF PROCEDURES OTHER THAN THOSE SPECIFIED HEREIN MAY RESULT IN HAZARDOUS RADIATION EXPOSURE. DO NOT OPEN COVERS AND DO NOT REPAIR BY YOURSELF. REFER SERVICING TO QUALIFIED PERSONNEL.

The following applies only in the U.S.A.

Part 15 of the FCC Rules

FCC Warning:

Any unauthorized changes or modifications to this equipment would void the user's authority to operate this device.

Service and Warranty

U.S.A.

Obtain Product Information and Operating Assistance; locate your nearest Dealer or Servicenter; purchase Parts and Accessories; or make Customer Service and Literature requests by visiting our Web Site at:

<http://www.panasonic.com/support>

or, contact us via the web at:

<http://www.panasonic.com/contactinfo>

You may also contact us directly at:

1-800-211-PANA (7262),

Monday-Friday 9 am-9 pm; Saturday-Sunday 10 am-7 pm, EST.

For hearing or speech impaired TTY users, TTY : 1-877-833-8855

Accessory Purchases:

Purchase Parts, Accessories and Instruction Books online for all Panasonic Products by visiting our Web Site at:

<http://www.pasc.panasonic.com>

or, send your request by E-mail to:

npcparts@panasonic.com

You may also contact us directly at:

1-800-332-5368 (Phone) 1-800-237-9080 (Fax Only)

(Monday-Friday 9 am to 8 pm, EST.)

Panasonic Services Company

20421 84th Avenue South, Kent, WA 98032

(We accept Visa, MasterCard, Discover Card, American Express, and Personal Checks)

For hearing or speech impaired TTY users, TTY : 1-866-605-1277

Service in Puerto Rico

Matsushita Electric of Puerto Rico, Inc.

Panasonic Sales Company

Factory Servicenter:

Ave. 65 de Infantería, Km. 9.5, San Gabriel Industrial Park,

Carolina, Puerto Rico 00985

Phone (787) 750-4300, Fax (787) 768-2910

U.S.A.

PANASONIC CONSUMER ELECTRONICS COMPANY,
DIVISION OF MATSUSHITA ELECTRIC CORPORATION OF AMERICA
One Panasonic Way, Secaucus, New Jersey 07094

PANASONIC SALES COMPANY,
DIVISION OF MATSUSHITA ELECTRIC OF PUERTO RICO, INC.
Ave. 65 de infantería, Km. 9.5, San Gabriel Industrial Park
Carolina, Puerto Rico 00985

PANASONIC AUTO PRODUCTS LIMITED WARRANTY

LIMITED WARRANTY COVERAGE

If your product does not work properly because of defects in materials and workmanship.

Panasonic Consumer Electronics Company or Panasonic Sales Company (collectively referred to as "the warrantor") will, for the length of the period indicated in the chart below, which starts with the date of original purchase ("warranty period"), at its option either (a) repair your product with new or refurbished parts, or (b) replace it with a new or refurbished product. The decision to repair or replace will be made by the warrantor.

During the "Labor" warranty period, there will be no charge for labor. During the "Parts" warranty period, there will be no charge for

Categories	Parts	Labor
Audio Components (except items listed below)	One (1) Year	One (1) Year
MXE Series Audio Components (except items listed below)	Two (2) Years	Two (2) Years
Speakers	One (1) Year	Not Applicable
Accessories (in exchange for defective items)	Ninety (90) Days	Not Applicable

parts. You must carry in or mail in your product during the warranty period. If non-rechargeable batteries are included, they are not warranted. This warranty only applies to products purchased and serviced in the United States or Puerto Rico. This warranty is extended only to the original purchaser of a new product which was not sold "as is". A purchase receipt or other proof of the original purchase date is required for warranty service.

CARRY-IN OR MAIL-IN SERVICE

For Carry-In or Mail-In Service in the United States, call 1-800-211-PANA (7262) or visit

Panasonic Web Site: <http://www.panasonic.com>

For assistance in Puerto Rico, call Panasonic Sales Company (787)-750-4300 or fax (787)-768-2910.

LIMITED WARRANTY LIMITS AND EXCLUSIONS

This warranty ONLY COVERS failures due to defects in materials and workmanship, and DOES NOT COVER normal wear and tear or cosmetic damage. The warranty ALSO DOES NOT COVER damages which occurred during shipment, failures which are caused by products not supplied by the warrantor, failures which result from accident, misuse, abuse, neglect, mishandling, misapplication, alteration, faulty installation, set-up adjustment, maladjustment of consumer control, improper maintenance, improper antenna, inadequate signal reception or pickup, power line surge, improper voltage supply, lightning, modification, commercial use (such as use in hotels, offices, restaurants, or other business uses) or rental use of the product, or service by anyone other than the technician from Factory Servicenter or other authorized service centers, or damage that is attributable to acts of God.

THERE ARE NO EXPRESS WARRANTIES EXCEPT AS LISTED UNDER "LIMITED WARRANTY COVERAGE". THE WARRANTOR IS NOT LIABLE FOR INCIDENTAL OR CONSEQUENTIAL DAMAGES RESULTING FROM THE USE OF THIS PRODUCT, OR ARISING OUT OF ANY BREACH OF THIS WARRANTY. (As examples, this excludes damages for lost time, cost of having someone remove or re-install an installed unit if applicable, travel to and from the servicer, and loss of media, data or other memory contents. The items listed are not exclusive, but are for illustration only.) **ALL EXPRESS AND**

IMPLIED WARRANTIES, INCLUDING THE WARRANTY OF MERCHANTABILITY, ARE LIMITED TO THE PERIOD OF THE LIMITED WARRANTY.

Some states do not allow the exclusion or limitation of incidental or consequential damages, or limitations on how long an implied warranty lasts, so the exclusions may not apply to you.









This warranty gives you specific legal rights and you may also have other rights which vary from state to state. If a problem with this product develops during or after the warranty period, you may contact your dealer or Servicenter. If the problem is not handled to your satisfaction, then write to warrantor's Consumer Affairs Department at the addresses of the warrantor.

PARTS AND SERVICE WHICH ARE NOT COVERED BY THIS LIMITED WARRANTY ARE YOUR RESPONSIBILITY.

Customer's Record

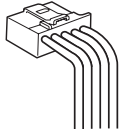
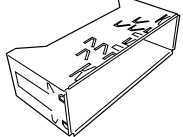
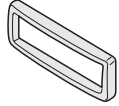
Model _____
No. _____
Serial _____
No. _____
Dealer's _____
No. _____
Code _____
No. _____
Dealer's _____
Address _____
Date of _____
Purchase _____

Before Reading These Instructions

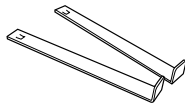
 Operating Instructions (YEFM285625)	 Owners Information Card	 Removable Face Plate Case (YEFA131646)	 Remote Control Unit (including a battery) (CR2025) (EUR7641010)
Instruction kit Qty: 1 set		Qty: 1	Qty: 1
 Power Connector (YEAJ02871)	 Mounting Collar (YEFX0217222)	 Trim Plate (YEF05654)	 Rear Support Strap (YFEG04019)
Qty: 1	Qty: 1	Qty: 1	Qty: 1
 Hex. Nut (5 mmø)	 Tapping Screw (5 mmø X 16 mm)	 Mounting Bolt	 Lock Cancel Plate (YEP0FZ5701)
Qty: 1 set			

Notes:

- The number in parenthesis underneath each accessory part name is the part number for maintenance and service.
- Accessories and their parts numbers are subject to modification without prior notice due to improvements.
- Mounting Collar and Trim Plate are mounted on the main unit at shipment.

Features

Panasonic welcomes you to our constantly growing family of electronic products owners. We endeavor to give you the advantages of precise electronic and mechanical engineering, manufactured with carefully selected components, and assembled by people who are proud of the reputation their work has built for our company. We know this product will bring you many hours of enjoyment, and after you discover the quality, value and reliability we have built into it, you too will be proud to be a member of our family.

HD Radio tuner for the AM/FM built in

You can hear the digital broadcasting easily due to the incorporation of the IBOC system. "IBOC" stands for **In Band On Channel**. This system adds to the existing analog radio signals by using broadcast carrier.

As a result, Sound quality of AM/FM broadcasting is greatly improved (An AM is to an FM quality, an FM is to a CD quality). The station names, call sign, artists and song titles can be received and displayed on your unit.

*A special antenna is not necessary to tune into a HD Radio broadcast station.

Full lineup of optional parts

An optional XM tuner allows you to receive the XM radio service. A DVD changer instead of an XM tuner is also connectable.

- Toll free number
 XM Tuner P/N: XMD1000
 Call 1-800-XM-RADIO(96-72346)
 Extension cord P/N: XMDPAN100
 Call 1-800-942-TERK(8375)

Delightful sound space thanks to system buildup

XM Receiver
 XMD1000: manufactured by XM Satellite Radio (Option)

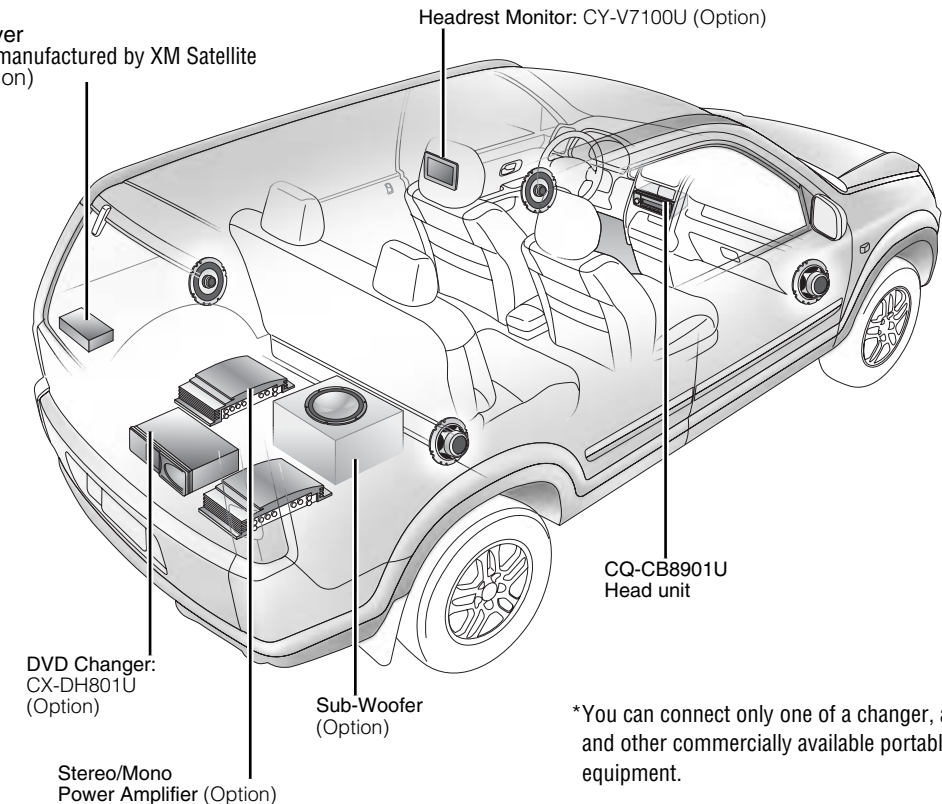

*You can connect only one of a changer, an XM receiver and other commercially available portable audio equipment.



The XM name and related logos are trademarks of XM Satellite Radio Inc.

Notes:

- A changer and an XM receiver are not connectable at the same time.
- To connect the XM receiver (XMD1000), it is required to use an optional extension cord (XMDPAN100) that is produced by XM exclusively for Panasonic products.

Other function

- Electric-controlled retractable face plate equipped (Tilt → page 15)
- Adjustable 7-band preset equalizer (SQ → page 18)
- Initially stored moving images and still images are editable to taste. IMAGE STUDIO* allows you to process images from a digital camera or other devices without difficulty. (→ page 37)

* This software is downloadable from Panasonic Web site (<http://panasonic.co.jp/pas/en/software/customize/index.html>).

What is HD Radio™?

Today's AM and FM radio is broadcast in analog, which has lower audio quality and is filled with static, hiss, pops and fades. Radio stations have begun a transformation to the world of digital using a new technology called HD Radio™. Today's analog signals and new HD Radio™ digital signals will be transmitted at the same time from AM and FM stations. The radios you use today will continue to function for years, however, new receivers are needed to hear the HD Radio digital signals broadcast from the stations.

While HD Radio™ will bring you pristine audio quality, it will also provide data services*. Both AM and FM HD Radio™ stations will transmit song and artist title, traffic updates, weather alerts, news reports and much more. For more information, visit www.hd-radio.com. Stay tuned!

*This unit supports text displays for the following items; station name, call sign, artist, song title.

Using these new receivers, you can pick up the new HD Radio™ digital signals at the same place on the dial (106.7 KROQ will be digital 106.7 KROQ broadcasting in HD Radio™, 710 WOR will be digital 710 WOR broadcasting in HD Radio™). Your favorite HD Radio™ digital station will be right where you left it. Additionally, new HD Radio™ receivers will still pick up stations broadcasting in analog, so you don't need two radios. The benefits of digital far outweigh old analog technology. HD Radio™ makes radio "fun" again. FM digital will sound like a CD throughout the coverage area, and AM digital will sound like today's FM throughout the coverage area, both without the static, hiss pops or fades that you've had to put up with for almost a century.

HD Radio is a trademark of iBiquity Digital Corporation.

HD Radio broadcasts can be enjoyed only in those areas in the United States where the broadcasts can be received. This means that the HD Radio feature cannot be used outside the U.S. or in areas inside the U.S. where these broadcasts cannot be receive. (as of December 2003)

Common	● Safety Information	2
	● Service and Warranty	4
	● Before Reading These Instructions	6
	● Features	7
	● Controls Layout	10
	● Preparation	12
	● General	14
Each Source	● Radio	20
	● CD Player	22
	● MP3/WMA Player	24
	● XM Tuner	28
	● Disc Changer	30
As Needed	● Audio Setting	34
	● Function Setting	35
	● Display Setting	36
	● Customize the Display	37
	● Troubleshooting	39
	● Error Display Messages	42
	● Notes on Discs	44
	● Maintenance	44
	● Installation	45
	● Specifications	55

Controls Layout

Note: This instruction manual explains operations for use with the buttons on the main unit. (Different operations excluded)

Main Unit

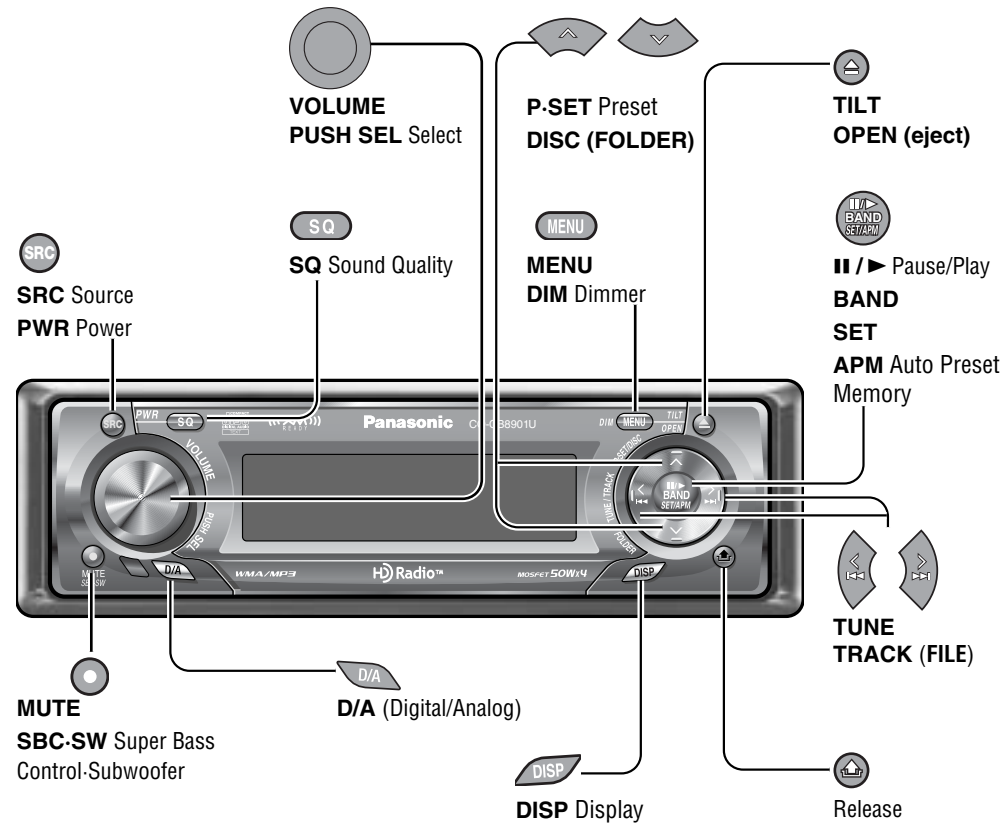

When Face Plate Opens

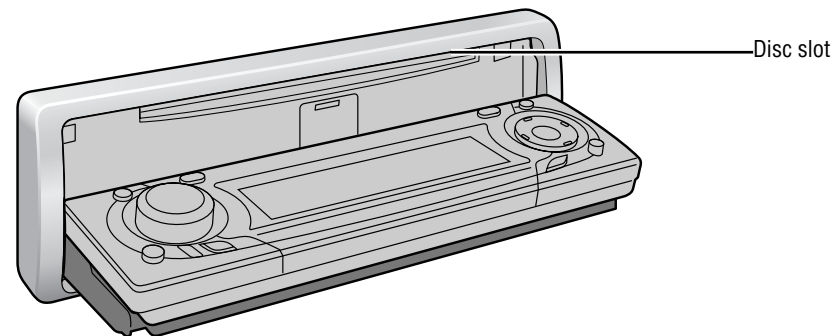

Remote Control Unit

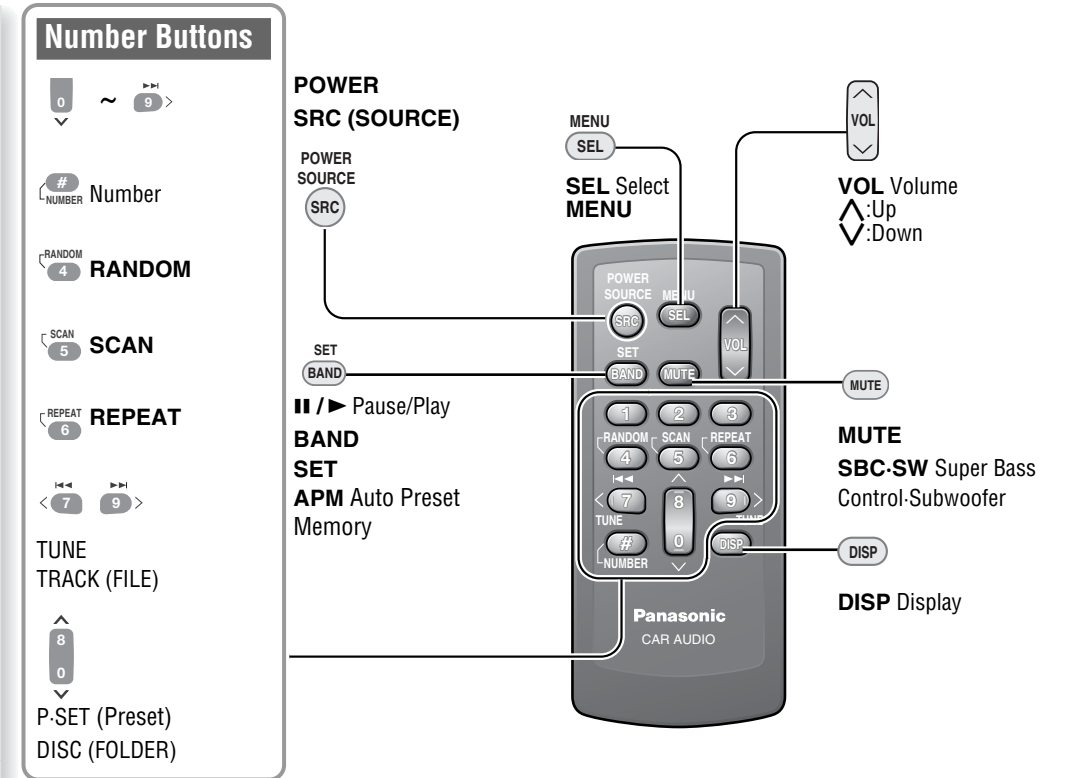

Controls Layout

One-touch operation is available for selecting a track playing style by use of [4] (RANDOM), [5] (SCAN), or [6] (REPEAT). (For a Folder/Disc playing style, hold down the same button for 2 sec. or more.)

Direct Access

A channel (XM mode), a track (CD mode), a disc (Disc changer), a file and a folder (MP3/WMA mode) can be directly selected.

Example: Track number 5

- 1 Press [#] (NUMBER).
- 2 Press [5].
- 3 Press [BAND] (SET).

Functions Only by Remote Control Unit



The demonstration message appears for first use.

- 1 Set your car's ignition switch to the ACC or On position.
The demonstration screen appears.



- 2 Press [DISP] (Display).
The demonstration screen is cancelled, and no more appears.

- 3 Press [SRC] (PWR: Power).



Note: If you would like to turn on the power and make the demonstration message appear, hold down [SRC] (PWR: Power) for 4 sec. or more after turning off the power in other than the XM mode.

Preparation Before Initial Use

Pull the insulation film out from the backside of remote control gently.

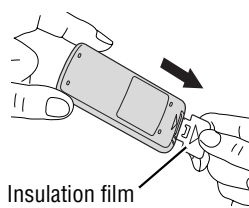

Insulation film

Warning

- Keep batteries and insulation film out of reach of infants. If an infant ingests a battery, please seek immediate medical attention.

Cautions

- Remove and dispose of an old battery immediately.
- Do not disassemble, heat or short a battery. Do not throw a battery into a fire or water.
- Follow local regulations when disposing of a battery.
- Improper use of a battery may cause overheating, an explosion or ignition, resulting in injury or a fire.

Note: Battery Information:

Battery Type: Panasonic lithium battery (CR2025)
(Included in the remote control)

Battery Life : Approximately 6 months under normal use
(at room temperature)

Battery Replacement

- 1 Remove the battery holder with the remote control unit placed on a flat surface.

- 1 Stick your thumbnail into the groove, and push the holder in the direction of the arrow, and at the same time.

- 2 Pull it out in the direction of the arrow using a tough pointed object.

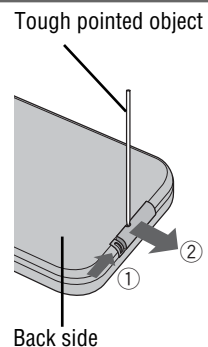

Back side

- 2 Put a battery in the case with (+) side facing up.
- 3 Put the case back.

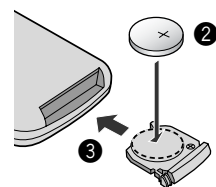

The following functions are activated when the Security Function is ON. (→ page 35)

- The security indicator lights up when removing the face plate.

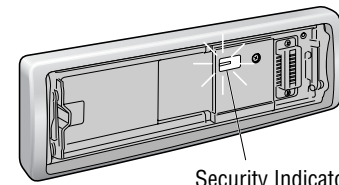

Security Indicator

- The alarm sounds and the message appears on the screen to warn you to remove the face plate at ACC off.

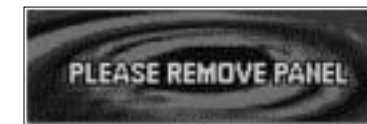

You may need to set the following depending on the devices to be connected.

Using Subwoofer

- Subwoofer level adjustment (→ page 34)
- Subwoofer low pass filter (→ page 34)
- High Pass Filter (→ page 34)

Connecting XM tuner

- Connect the optional XM receiver (XMD1000).
- To connect the XM receiver (XMD1000), it is required to use an optional extension cord (XMDPAN100) that is produced by XM exclusively for Panasonic products.

Getting Started

It is required to sign up to become an XM Satellite Radio subscriber. After checking your XM Satellite Radio ID, sign up on the XM's website or by calling them.

Note:

- Adjust the clock when "ADJUST" appears on the display.

- 1 Press [MENU] to display the menu display.

For using the remote control, hold down [SEL] (MENU) for 2 sec. or more.

- 2 Press [<] or [>] to display the DISPLAY menu.

- 3 Press [V] to select "CLOCK ADJ".

- 4 Press [BAND] (SET) to confirm the display.

- 5 Adjust the setting value.



[>]: Adjusting minutes

[<]: Adjusting hours

[^]: Forward

[v]: Backward



- 6 Press [BAND] (SET) to confirm the adjustment.

- 7 Press [MENU].

For using the remote control, hold down [SEL] (MENU) for 2 sec. or more.

This chapter explains how to turn on or off the power, how to adjust the volume, etc.

Power on

Press [SRC] (PWR: Power).



Note: The opening screen appears. You can overwrite opening screen (moving image) with new one. (→ page 37)

Power off

Hold down [SRC] (PWR) until you hear a beep, then release it.

Note: The ending screen appears. You can change the ending screen (moving image). (→ page 37)

You can remove the face plate to prevent it from being stolen.



2 Put the face plate in the case.

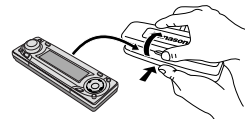

Removing

1 Press [] (Release).

(The face plate disengages with a click when it is removed.)



The face plate automatically closes after a lapse of 5 seconds while it is open.

The power is automatically turned off while the unit is active.

⚠ Cautions:

- It is recommended to remove or mount the face plate when the plate is at the closed position. Do not remove or mount the face plate when the plate is in motion.
- This face plate is not waterproof. Do not expose it to water or excessive moisture.
- Do not remove the face plate while driving your car.

Mounting

1 Slide the left side of the face plate in place.

2 Press the right end of the face plate until "click" is heard.

- Do not place the face plate on the dashboard or nearby areas where the temperature rises to high levels.
- Do not touch the contacts on the face plate or on the main unit, since this may result in poor electrical contacts.
- If dirt or other foreign substances get on the contacts, wipe them off with clean and dry cloth.
- To avoid damaging the face plate, do not push it down or place objects on it while it is open.

Open/Eject

Press [] (OPEN).

When a disc is already loaded, the disc will automatically be ejected.

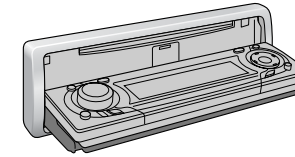

⚠ Cautions:

- To avoid damaging the face plate, do not push it down or place objects on it while it is open.
- Do not pinch your finger or hand in the face plate.
- Do not insert foreign objects into the disc slots.
- For the following cases, the face plate automatically closes. Use caution not to catch your finger.
 - After a lapse of 20 seconds
 - When a disc is inserted
 - When the face plate is removed (→ page 14)

Close

Press [] (OPEN).

Tilt

The display angle changes among 4 levels as follows every time you hold down [] (TILT) for 1 sec. or more and release.



Note: The last selected angle is memorized even after turning off the power.

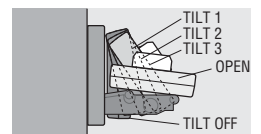

- Up
- Down

Setting Range: 0 to 40
Default: 18

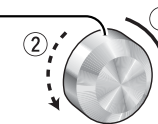

Notes:

- The volume level can be set independently for each source. (For radio, one volume setting for AM, one volume setting for all FMs)
- The volume is not adjustable (except XM mode) while an error display is on the monitor. (→ page 42)

Volume off (down)

Press [] (MUTE).



Cancel

Press [] (MUTE) again.

Note: Volume-down range can be specified. (→ page 35)



The source changes as follows every time [SRC] (Source) is pressed.



Radio

FM1, FM2, FM3, AM (→ page 20)

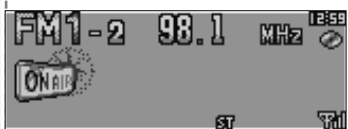

Player

When loading CD (→ page 22)

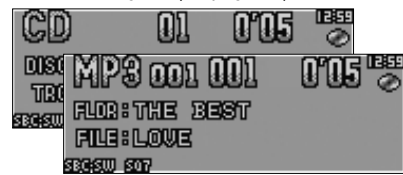

When loading MP3/WMA disc (→ page 24)

Auxiliary (AUX 1)

When connecting a device that is not controlled by this unit

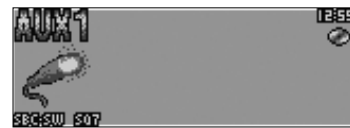

Auxiliary (AUX 2)

When connecting CD Changer, DVD Changer (→ page 30, 32)

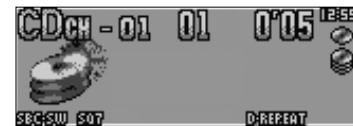

When connecting XM Tuner (→ page 28)



When connecting a device that is not controlled by with this unit.

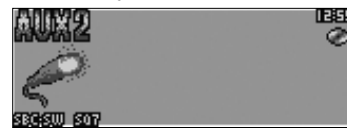

Note: Please connect a CD changer or a DVD changer to CH/AUX 2. (→ Page 50)

The rear speaker can be used as a substitutional subwoofer when a subwoofer is not connected.

Holding down [SBC-SW] for 2 sec. or more toggles SBC-SW on and off.

Off (default)



Note: If ON is selected, the settings of subwoofer level adjustment and subwoofer low pass filter are activated. (→ page 34)



lights when activated.

The display changes as follows every time [DISP] is pressed.

Note: The graphic pattern and still image are selectable. (→ page 36)

At power-on:

Mode



Folder hierarchy (MP3/WMA only)

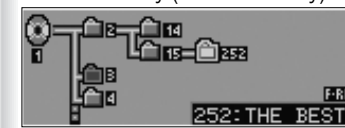

Ordinary display + graphic pattern



Only graphic pattern

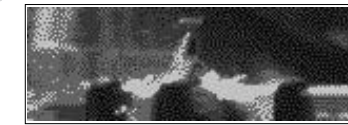

Note: The graphic equalizer of 19 bands is selectable when selecting a graphic pattern.

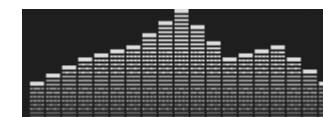

Display OFF

All displays disappear in 5 seconds.



Ordinary display + clock

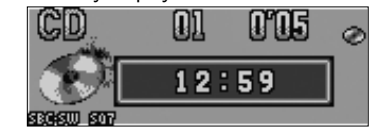

Only still image



Ordinary display + still image



At power-off:

Clock display (default)

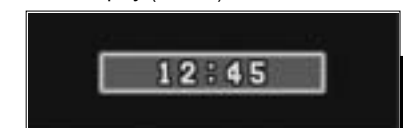

Off

The dimmer level changes as follows every time you hold down [MENU] (DIM) for 2 sec. or more.

Brighter (Default)



Medium



Darker



Note: This setting is not adjustable with the remote control.

The sound type each of which is adjusted with 7 bands changes every time you press [SQ].



Notes:

- Setting of SQ, bass/treble and volume are influenced one another. If the influence mentioned above causes distortion to the audio signal, readjust bass/treble or volume.
- Each SQ (except FLAT) level is changeable. (→ page 19)



Lights when activated.

You can make fine adjustments to the currently selected SQ presetting in ROCK, POP, VOCAL, JAZZ, or CLUB in accordance with your car type or taste.

1 Hold down [SQ] (Sound Quality) for 2 sec. or more.



The targeted SQ preset appears.

2 Adjust each frequency.

Note: If you press [DISP], the presetting is canceled. The presetting is active until another SQ preset is called up.

[>]: Higher frequency

[<]: Lower frequency

① : Level Up

② : Level Down

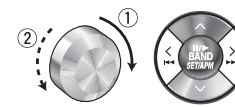

3 Hold down [^] or [v] for 2 sec. or more to confirm your adjustment.

Note: You can select a SQ preset to be targeted with [^] and [v] (and [2]-[6] on the remote control).



4 Hold down [^] or [v] for 2 sec. or more to confirm your adjustment.



The existing adjustment is overwritten with new adjustment.

Notes:

- FLAT is not changeable.
- If no operation takes place for more than 10 seconds, the display returns to the regular mode.
- This adjustment is executable in the AUDIO menu as well. (→ page 34)
- If you hold down [BAND] for 2 sec. or more on the SQ call-up screen, the presetting that is called up can be turned into the default.

This chapter explains how to listen to the radio.

1 Press **[SRC]** (Source) to select the radio mode.

2 Press **[BAND]** to select a band.

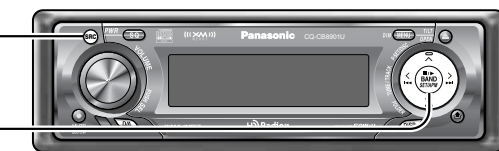

3 Select a station.

Frequency adjustment

[<] (TUNE): Lower

[>] (TUNE): Higher

Note: Hold down for 0.5 sec. or more and release for station search. Seeking will start.

Preset station selection

[V] (P-SET: Preset): Lower preset number

[^] (P-SET: Preset): Higher preset number

Note: Direct selection can be executed with **[1]** to **[6]** buttons on remote control.

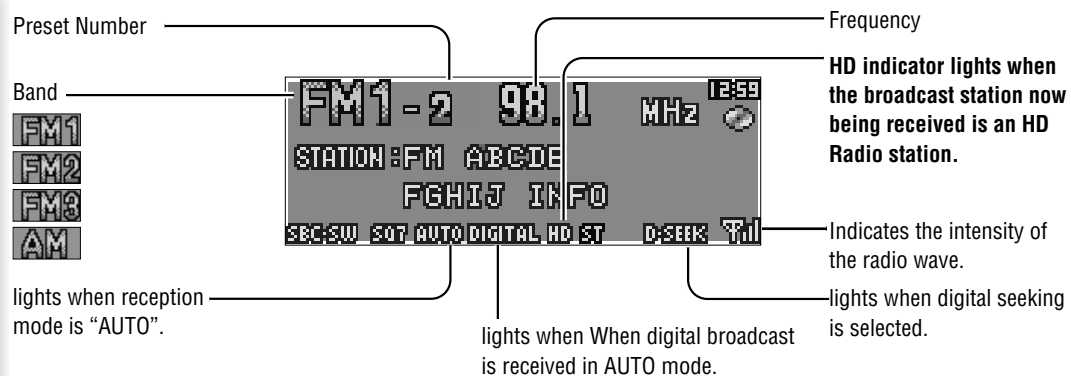

Reception Mode

Press **[D/A]** to select the AUTO mode or ANALOG mode.

AUTO: Analog or Digital reception (Default)
ANALOG: Analog reception only



Notes:

- The sound may not switch over to digital if the program concerned is being broadcast in real time.
- Analog sound will be output if the reception is poor.
- In the AUTO mode, analog sound is output immediately after the frequency has been turned in. When listening to analog sound to analog, the sound quality will be better in the ANALOG mode.
- To display text information, select the AUTO mode.

Seeking Mode

When the reception mode is "AUTO":
Hold down **[D/A]** for 2 sec. or more to select the Auto seeking or Digital seeking.

AUTO Seeking: Seeks analog or digital broadcast stations. (Default)
Digital Seeking: Seeks digital broadcast stations.

(APM: Auto Preset Memory, P-SET: Preset)

Up to 6 stations can be preset in AM, FM1, FM2, and FM3 respectively.

Preset stations can be simply called up by pressing **[^]** (P-SET) or **[V]** (P-SET).

Notes:

- Direct selection can be executed with **[1]** to **[6]** buttons on remote control.
- Preset stations are changeable.

Auto Preset Memory (APM)

Stations with good receiving conditions automatically preset.

1 Select a band.

2 Hold down **[BAND]** (APM) for 2 sec. or more.



[AUTO mode (Auto seeking)]

The stations that broadcast digital signals are stored in the memory in sequence with the station featuring the best reception first and starting with the highest preset number whereas the stations that broadcast only analog signals are stored in the memory in sequence starting with the lower preset number.

[AUTO mode (Digital seeking)]

The stations that broadcast digital signals are saved in sequence with the one featuring the best reception first. (this may take some time.)

[ANALOG mode]

The 6 stations with good reception will be automatically saved in the memory under preset number **[1]** to **[6]**.

The preset stations under best receiving conditions are received for 5 sec. each after presetting the stations (SCAN). To stop scanning, press **[^]** or **[V]**.

Note: New stations overwrite existing saved stations.

Manual station preset

1 Tune in to a station.

2 Hold down **[^]** or **[V]** for 2 sec. or more.

3 Select a preset number by pressing **[^]** or **[V]**.

4 Preset the station by holding down **[^]** or **[V]** for 2 sec. or more.

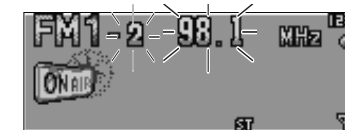

Frequency/preset number blinks once.

Notes:

- New stations overwrite existing saved stations.
- In step 2, a station can be stored by holding down the one of the preset buttons **[1]** to **[6]** for 2 sec. or more.
- To stop presetting stations, press **[DISP]** (Display).

(TEXT Display Setting)

While receiving a digital broadcast station, you can set up its text contents to be displayed.

1 Press **[MENU]** to display the menu display.

For using the remote control, hold down **[MENU]** for 2 sec. or more.



2 Press **[^]** or **[V]** to select a mode to be adjusted.

3 Press **[BAND]** (SET) to adjust.

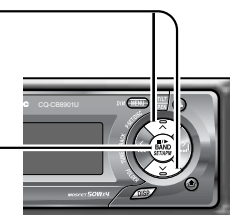

4 Press **[MENU]** to confirm the adjustment.

For using the remote control, hold down **[SEL]** (MENU) for 2 sec. or more.



TEXT DISPLAY

- **STATION**: Station name (Default)
- **ARTIST/TITLE**: Artist name/Song title
- **OFF**: off

Notes:

- To have an another circle scroll when the text is display, Hold down **[DISP]** (Display) for 2 sec. or more.
- If any of the following screens are displayed, the display will not be switched even when the above operations is performed.
 - Mode and Moving picture display/SA display
 - Moving picture display/SA display
 - Mode and clock display
 - Display and light off
- There is a case that text is not always displayed while a digital station is received.

1 Press [⊖] (OPEN) to open the face plate.

When a disc is already loaded, the disc will automatically be ejected.

2 Load a disc with the printed-side facing up.

The face plate closes automatically, and the unit recognizes the disc and starts playing automatically, too.

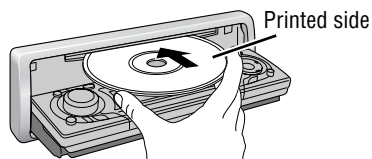

When a disc is already loaded, press [SRC] (Source) to select the CD mode.



3 Select a desired portion.

Track selection

- [▶▶] (TRACK): Next track
- [◀◀] (TRACK): Preceding track (press twice)

Note: Hold down for fast forward/reverse.

Pause

Press [BAND] (||/▶).
Press again to cancel.

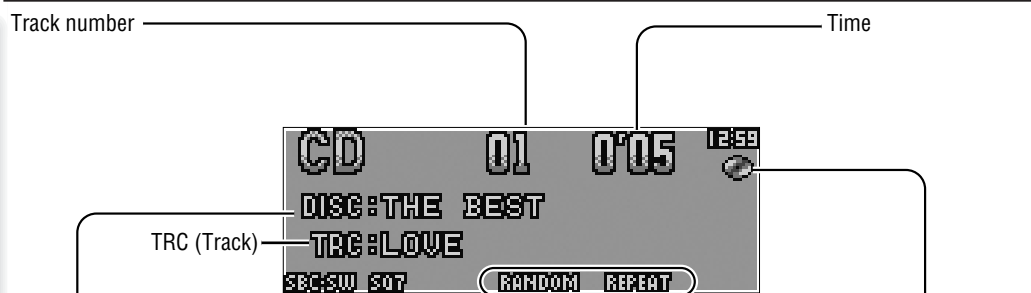

CD-TEXT display

Notes:

- For scrolling text, hold down [DISP] for 2 sec. or more.
- "NO TEXT" is displayed when there is no information on the disc.

Play Mode indicators
lights when each mode is activated.



lights when the disc is loaded.

(RANDOM, REPEAT)

⚠ Cautions:

- This unit does not support 8 cm (3") discs.**
- Do not use irregularly shaped discs. (→ page 44)
- Do not use discs that have a seal or label attached.
- To avoid damaging the face plate, do not push it down or place objects on it while it is open.
- Do not pinch your finger or hand in the face plate when the face plate is in motion.
- Do not insert foreign matter into the disc slots.

- Refer to the section on "Notes on CD, CD Media (CD-ROM, CD-R, CD-RW)" (→ page 44).
- A disc which has both CD-DA data and MP3/WMA data on it may not be reproduced normally.

Random and Repeat play can be set.

1 Press [MENU] to display the menu display.

For using the remote control, hold down [SEL] (MENU) for 2 sec. or more.



2 Press [∧] or [∨] to select a mode to be adjusted.

3 Press [BAND] (SET) to adjust.

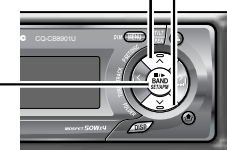

4 Press [MENU] to confirm the adjustment.

For using the remote control, hold down [SEL] (MENU) for 2 sec. or more.

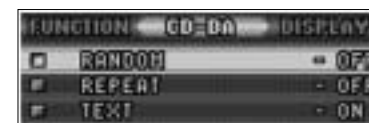

RANDOM

- OFF: Off
- ON: Random playback

REPEAT

- OFF: Off
- ON: Playing the current track repeatedly

TEXT (CD TEXT)

- ON: Enabled (Default)
- OFF: Disabled

Play Mode Selection

One-touch operation is available for selecting a track playing style by use of [RANDOM] or [REPEAT].

RANDOM

Press [RANDOM].
Press again to cancel.

REPEAT

Press [REPEAT].
Press again to cancel.

SCAN play

You can find your favorite track by playing first 10-sec. of each track.

Press [SCAN].
Press again to cancel.

Direct Access

A track can be directly selected.

Example: track number 5

- Press [#] (NUMBER).
- Press [5].
- Press [SET].

Note: To suspend direct selection, press [DISP] (Display).



1 Press [OPEN] to open the face plate.

When a disc is already loaded, the disc will automatically be ejected.

2 Load a disc with the Printed-side facing up

The face plate closes automatically, and the unit recognizes the disc and starts playing automatically, too. (It may take several minutes to start for a disc that has a lot of files.)

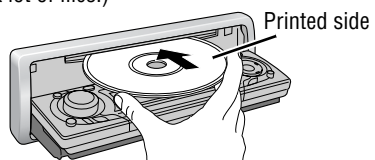

When a disc is already loaded, press [SRC] (Source) to select the MP3/WMA mode.



3 Select a desired portion.

Folder selection

[^] (FOLDER): Next folder

[v] (FOLDER): Preceding folder

File selection

[>>>] (TRACK): Next file

[<<<] (TRACK): Preceding file (press twice)

Note: Hold down for fast forward/reverse.

Pause

Press [BAND] (II / ▶).

Press again to cancel.

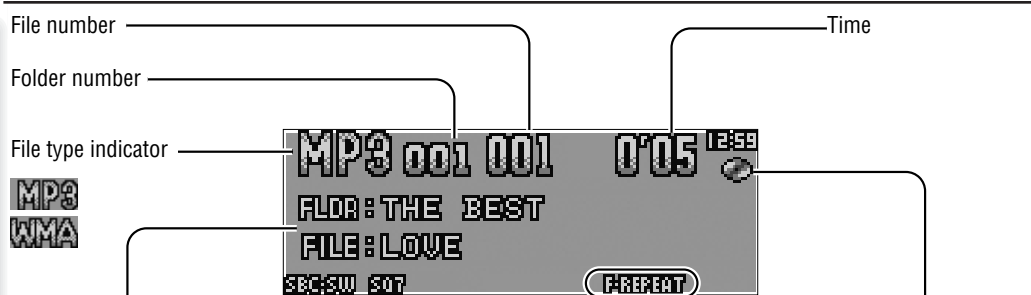

Information Display

Notes:

- For scrolling text, hold down [DISP] for 2 sec. or more.
- "NO TEXT" is displayed when there is no information on the disc.
- ID3/WMA tag information is displayed for the album name and title/artist name.

Play Mode indicators lights when each mode is activated.

RANDOM

REPEAT

SCAN

FRANDOM (Folder Random)

FREPEAT (Folder Repeat)

FSCAN (Folder Scan)

lights when the disc is loaded.

Notes:

- Refer to the section on "Notes on MP3/WMA" (→ page 26)
- A disc which has both CD-DA data and MP3/WMA data on it may not be reproduced normally. (For example, it may be reproduced without sound.)

Random and Repeat play can be set.

1 Press [MENU] to display the menu display.

For using the remote control, hold down [SEL] (MENU) for 2 sec. or more.



2 Press [^] or [v] to select a mode to be adjusted.

3 Press [BAND] (SET) to adjust.

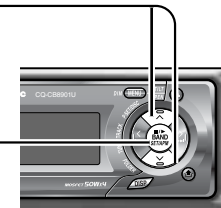

4 Press [MENU] to confirm the adjustment.

For using the remote control, hold down [SEL] (MENU) for 2 sec. or more.

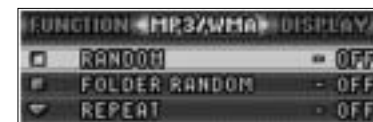

RANDOM

OFF: Off

ON: Random playback (disc)

FOLDER RANDOM

OFF: Off

ON: Random playback (folder)

REPEAT

OFF: Off

ON: Playing the current file repeatedly

FOLDER REPEAT

OFF: Off

ON: Playing the current folder repeatedly.

TEXT

FOLDER/FILE: Folder name/File name

ALBUM/TITLE: Album/Title (tag information)

OFF: No display

Play Mode Selection

One-touch operation is available for selecting a track playing style by use of [RANDOM] or [REPEAT].

RANDOM, REPEAT

Press the button. Press again to cancel.

FOLDER RANDOM, FOLDER REPEAT

Hold down the button for 2 sec. or more. Hold down again to cancel.

SCAN play

You can find your favorite file by playing first 10-sec. of each file.

SCAN (All files)

Press [SCAN]. Press again to cancel.

FOLDER SCAN (1st file in each folder)

Hold down [SCAN] for 2 sec. or more. Hold down again to cancel.

Direct Access

A file in the current folder can be directly selected.

Example: file number 5

1 Press [#] (NUMBER).

2 Press [5].

3 Press [SET].

Notes:

- For folder selection, enter a number after pressing [#] (NUMBER) twice.
- To suspend direct selection, press [DISP] (Display).



What is MP3/WMA?

MP3 (MPEG Audio Layer-3) and WMA (Windows Media™ Audio) are the compression formats of digital audio. The former is developed by MPEG (Motion Picture Experts Group), and the latter is developed by Microsoft Corporation. Using these compression formats, you can record the contents of about 10 music CDs on a single CD media (This figures refer to data recorded on a 650 MB CD-R or CD-RW at a fixed bit rate of 128 kbps and a sampling frequency of 44.1 kHz).

Notes:

- MP3/WMA encoding and CD writing software is not supplied with this unit.

Points to remember when making MP3/WMA files

Common

- High bit rate and high sampling frequency are recommended for high quality sounds.
- Selecting VBR (Variable Bit Rate) is not recommended because playing time is not displayed properly and sound may be skipped.
- The playback sound quality differs depending on the encoding circumstances. For details, refer to the user manual of your own encoding software and writing software.

MP3

- It is recommended to set the bit rate to “128 kbps or more” and “fixed”.

WMA

- It is recommended to set the bit rate to “64 kbps or more” and “fixed”.
- Do not set the copy protect attribute on the WMA file to enable this unit to play back.

Caution: Never assign the “.mp3”, or “.wma” file name extension to a file that is not in the MP3/WMA format. This may not only produce noise from the speaker damage, but also damage your hearing.

Display Information

Displayed items

- | | |
|---|---|
| • CD-TEXT
Disc title
Track title | • MP3 (ID3 tag)
Album name
Title and artist name |
| • MP3/WMA
Folder name
File name | • WMA (WMA tag)
Album name
Title and artist name |

Displayable characters

- Displayable length of file name/folder name: within 64 characters
- Name files and folders in accordance with the standard of each file system. Refer to the instructions of writing software for details.
- ASCII character set and special characters in each language can be displayed.

ASCII character set

A to Z, a to z, digits 0 to 9, and the following symbols:
(space) ! " # \$ % & ' () * + , - . / : ; < = > ? @ [\] ^ _ ` { | } ~

Notes:

- With some software in which MP3/WMA format files have been encoded, the character information may not be displayed properly.
- Undisplayable characters and symbols will be converted into an asterisk (*).

Windows Media, and the Windows logo are trademarks, or registered trademarks of Microsoft Corporation in the United States and/or other countries.



Recording MP3/WMA files on a CD-media

- You are recommended to minimize the chances of making a disc that contains both CD-DA files and MP3/WMA files.
 - If CD-DA files are on the same disc as MP3 or WMA files, the songs may not play in the intended order, or some songs may not play at all.
 - When storing MP3 data and WMA data on the same disc, use different folders for each data.
 - Do not record files other than MP3/WMA files and unnecessary folder on a disc.
 - The name of an MP3/WMA file should be added by rules as shown in the following descriptions and also comply with the rules of each file system.
 - The file extension “.mp3” or “.wma” should be assigned to each file depending on the file format.
- You may encounter trouble in playing MP3/WMA files or displaying the information of MP3/WMA files recorded with certain writing software or CD recorders.
- This unit does not have a play list function.
 - Although Multi-session recording is supported, the use of Disc-at-Once is recommended.

Supported file systems

ISO 9660 Level 1/Level 2, Apple Extension to ISO 9660, Joliet, Romeo

Note:

- Apple HFS, UDF 1.50, Mix CD and CD Extra are not supported.

Compression formats

(Recommendation: “Points to remember when making MP3/WMA files” on the previous page)

Compression method	Bit rate	VBR	Sampling frequency
MPEG 1 audio layer 3 (MP3)	32k-320 kbps	Yes	32, 44.1, 48 kHz
MPEG 2 audio layer 3 (MP3)	8k-160 kbps	Yes	16, 22.05, 24 kHz
Windows Media Audio Ver. 2, 8	64k-192 kbps	No	32, 44.1, 48 kHz

Folder selection order/file playback order

Maximum number of files/folders

- Maximum number of files: 999
- Maximum number of files in one folder: 255
- Maximum depth of trees: 8
- Maximum number of folders: 255 (Root folder is included.)

Notes:

- This unit counts the number of folders irrespective of the presence or absence of an MP3/WMA file.
- If the selected folder does not contain any MP3/WMA files, the nearest MP3/WMA files in the order of playback will be played.
- Playback order may be different from other MP3/WMA players even if the same disc is used.
- “ROOT” appears when displaying the root folder name.

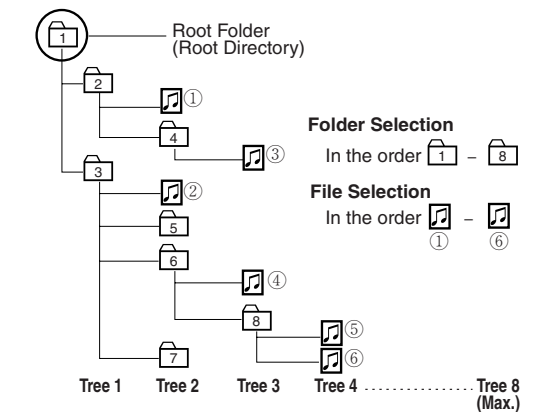

Copyright

It is prohibited by copyright laws to copy, distribute and deliver copyrighted materials such as music without the approval of copyright holder except enjoying yourself personally.

No warranty

Above description complies with our investigations as of December 2004. It has no warranty for reproducibility and displayability of MP3/WMA.

The optional XM receiver allows you to receive the XM radio service.

1 Press **[SRC]** (Source) to select the XM Satellite Radio mode.

Note: "LOADING" is displayed when it takes for 2 sec. or more to receive the XM satellite radio.



2 Press **[BAND]** to select a band.

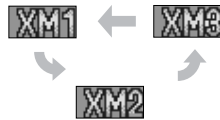

3 Select a channel.

- Connect the optional XM receiver (XMD1000).
- To connect the XM receiver (XMD1000), it is required to use an optional extension cord (XMDPAN100) that is produced by XM exclusively for Panasonic products.

Notes:

- "RADIO ID" is displayed with channel 0.
- "UPDATING" is displayed during the update of the identification code.
- "LOADING" is displayed during the acquisition of audio data or information.

Channel selection

- [<]**: Preceding channel
- [>]**: Next channel

Preset channel selection

- [V]** (P-SET: Preset): Lower preset channel
- [^]** (P-SET: Preset): Higher preset channel

Note: Direct selection can be executed with **[1]** to **[6]** buttons on remote control.

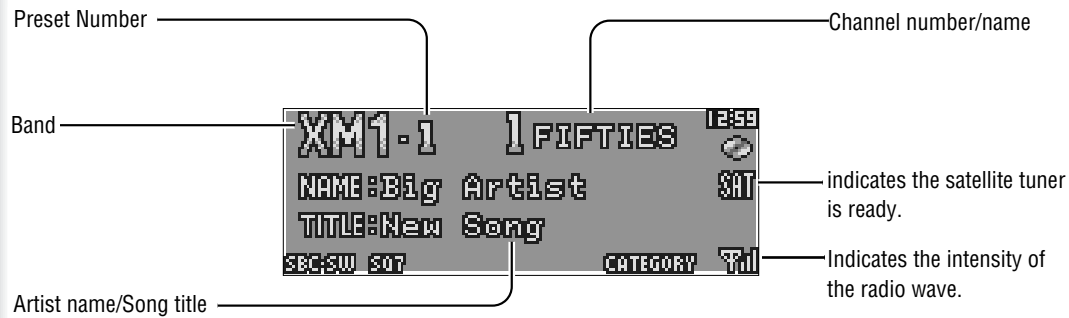

Up to 6 channels can be preset in XM1 to XM3 respectively.

Preset channels can be simply called up by pressing **[^]** (P-SET) or **[V]** (P-SET).

Note: Direct selection can be executed with **[1]** to **[6]** buttons on remote control.

- 1** Tune into a channel.
- 2** Hold down **[^]** or **[V]** for 2 sec. or more.
- 3** Select a preset number by pressing **[^]** or **[V]**.

4 Preset the channel by holding down **[^]** or **[V]** for 2 sec. or more.



Preset number/channel number blinks once.

Notes:

- New channels overwrite existing saved channels.
- In step 2, a channel can be stored by holding down one of the preset buttons **[1]** to **[6]** for 2 sec. or more.
- To stop presetting channels, press **[DISP]** (Display).

You can toggle the category on and off every time you hold down **[BAND]** for 2 sec. or more. If the category is set to on, the unit operates as follows for each button:

Channel selection

- [<]** (TUNE): Preceding channel in current category
- [>]** (TUNE): Next channel in current category

Category selection

- [V]** (P-SET: Preset): Preceding category
- [^]** (P-SET: Preset): Next category

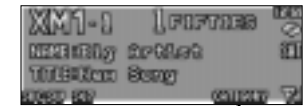

lights when activated.

1 Press **[MENU]** to display the menu display.

For using the remote control, hold down **[SEL]** (MENU) for 2 sec. or more.



2 Press **[BAND]** (SET) to adjust.



3 Press **[MENU]** to confirm the adjustment.

For using the remote control, hold down **[SEL]** (MENU) for 2 sec. or more.

TEXT

- [ON]**: Enabled (Default)
- [OFF]**: Disabled



Direct Access

A channel can be directly selected.

Example: channel number 5

- 1** Press **[#]** (NUMBER).
- 2** Press **[5]**.
- 3** Press **[SET]**.

Note: To suspend direct selection, press **[DISP]** (Display).



Disc Changer (When CDs or MP3 discs are loaded)

Connected an optional CD changer or an optional DVD changer can be controlled by this unit.

1 Load a magazine (discs).

When a magazine is already loaded, press **[SRC]** (Source) to select the CD mode.

The unit recognizes the magazine and starts playing automatically.

Note: The changer is automatically turn on when the magazine is inserted.



2 Select a desired portion.

Disc selection

- [^]: Next disc
- [v]: Preceding disc

Track selection

- [>>]: Next track/file
- [<<]: Preceding track/file (press twice)

Note: Hold down for fast forward/reverse.

Pause

- Press **[BAND]** (|| / >).
- Press again to cancel.

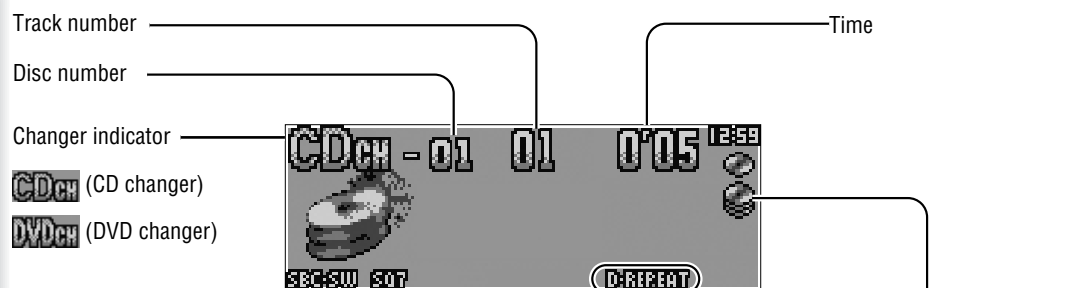

Play Mode indicators lights when each mode is activated. lights when the changer is connected.

- RANDOM** (Only for CD changer)
- REPEAT**
- SCAN**
- D:RANDOM** (Disc Random)
- D:REPEAT** (Disc Repeat)
- D:SCAN** (Disc Scan)

Notes:

- Please connect a CD changer or a DVD changer to AUX 2.
- "AUX 2" is display when connecting a changer that is not compatible with this unit.
- When CX-DP880 or CX-DH801U is connected, a CD-RW disc is playable.

- Trouble may occur while playing CD-Rs. Refer to the section on "Notes on CD/CD Media (CD-ROM, CD-R, CD-RW)". (→ page 44)
- This unit does not support the following through the CD changer.
 - **MP3 playback.**

Random and Repeat play can be set.

1 Press [MENU] to display the menu display.

For using the remote control, hold down **[SEL] (MENU)** for 2 sec. or more.



2 Press [^] or [v] to select a mode to be adjusted.

3 Press [BAND] (SET) to adjust.

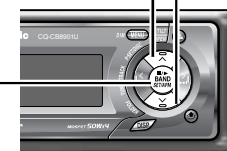

4 Press [MENU] to confirm the adjustment.

For using the remote control, hold down **[SEL] (MENU)** for 2 sec. or more.



RANDOM (Only for CD-DA)

- OFF**: Off
- ON**: Random playback (from whole magazine: CD-CH) (from selected disc: DVD-CH)

RANDOM (Only for MP3 disc)

- OFF**: Off
- ON**: Random playback (from selected folder)

DISC RANDOM (Only for CD changer)

- OFF**: Off
- ON**: Random playback (from selected disc)

REPEAT

- OFF**: Off
- ON**: Playing the current track/file repeatedly

DISC REPEAT

- OFF**: Off
- ON**: Playing the current disc repeatedly

FOLDER REPEAT (Only for MP3 disc)

- OFF**: Off
- ON**: Playing the current folder repeatedly

Play Mode Selection

One-touch operation is available for selecting a track playing style by use of **[RANDOM]** or **[REPEAT]**.

RANDOM, REPEAT

Press the button. Press again to cancel.

DISC RANDOM, DISC REPEAT

Hold down the button for 2 sec. or more. Hold down again to cancel.

SCAN play (Only for CD-DA)

You can find your favorite track by playing first 10-sec. of each track.

SCAN (CD changer: All tracks, DVD changer: from selected disc)

Press **[SCAN]**. Press again to cancel.

DISC SCAN (1st track in each disc, only for CD changer)

Hold down **[SCAN]** for 2 sec. or more. Hold down again to cancel.

Direct Access

A disc can be directly selected.

Example: disc number 5

- 1 Press **[#] (NUMBER)**.
- 2 Press **[5]**.
- 3 Press **[SET]**.



Note: To suspend direct selection, press **[DISP]** (Display).

Disc Changer (when DVDs or VCDs are loaded)

Connected an optional DVD changer (CX-DH801U) can be controlled by this unit.

1 Load a magazine (discs).

When a magazine is already loaded, press **[SRC]** (Source) to select the DVD changer mode.

The unit recognizes the magazine and starts playing automatically.

Note: The power is turned on automatically when inserting a magazine.



2 Select a desired portion.

Disc selection

- [^]: Next disc
- [v]: Preceding disc

Chapter/Track selection

- [>>]: Next chapter/Next track
- [<<]: Preceding chapter/Preceding track (press twice)

Note: Hold down for fast forward/reverse.

Pause

- Press **[BAND]** (||/▶).
- Press again to cancel.

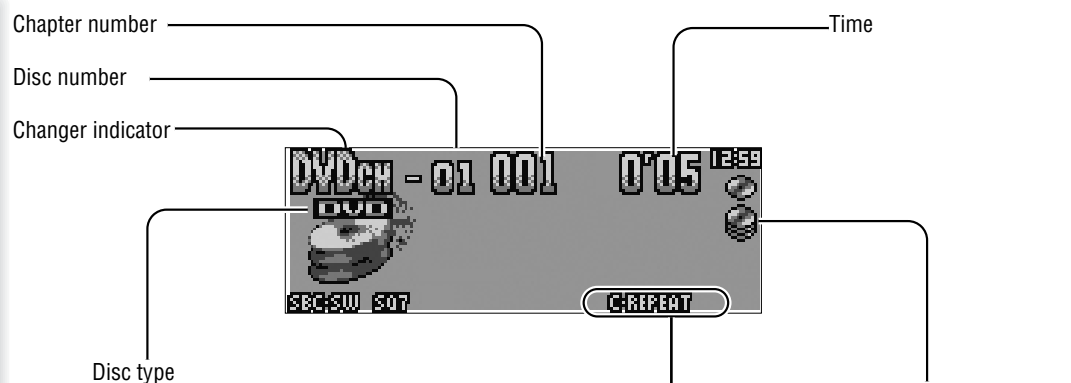

Play Mode indicators
Lights when each mode is activated.

- REPEAT**
- D:REPEAT** (Disc Repeat)
- C:REPEAT** (Chapter Repeat)
- T:REPEAT** (Title Repeat)

Lights when the changer is connected.

Notes:

- Please connect a CD changer or a DVD changer to AUX 2.
- "AUX 2" is display when connecting a changer that is not compatible with this unit.

Random and Repeat play can be set.

1 Press [MENU] to display the menu display.

For using the remote control, hold down **[SEL] (MENU)** for 2 sec. or more.

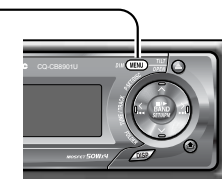

2 Press [^] or [v] to select a mode to be adjusted.

3 Press [BAND] (SET) to adjust.

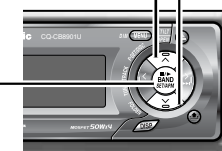

4 Press [MENU] to confirm the adjustment.

For using the remote control, hold down **[SEL] (MENU)** for 2 sec. or more.



• For a DVD insertion

CHAPTER REPEAT

- OFF**: Off
- ON**: Playing the current chapter repeatedly.

TITLE REPEAT

- OFF**: Off
 - ON**: Playing the current title repeatedly.
- Note:** The unit may not operate for some DVDs.

• For a VCD insertion

REPEAT

- OFF**: Off
- ON**: Playing the current track repeatedly

DISC REPEAT

- OFF**: Off
- ON**: Playing the current disc repeatedly

Notes:

- The unit may not operate for some VCDs.
- The unit may not operate for a disc with the play back function activated.

Play Mode Selection

One-touch operation is available for selecting a chapter playing style by use of **[REPEAT]**.

CHAPTER REPEAT(DVD), **REPEAT** (VCD)
Press the button. Press again to cancel.

TITLE REPEAT(DVD), **DISC REPEAT** (VCD)
Hold down the button for 2 sec. or more. Hold down again to cancel.

Direct Access

A disc can be directly selected.

Example: disc number 5

- 1 Press **[#]** (NUMBER).
- 2 Press **[5]**.
- 3 Press **[SET]**.



Note: To suspend direct selection, press **[DISP]** (Display).

Audio Setting

Adjustment to each speaker and an optional subwoofer

- 1 Press **[VOLUME]** (**SEL**: Select) to display the AUDIO menu display.



- 2 Press **[VOLUME]** (**SEL**: Select) to select a mode to be adjusted.

- 3 Turn **[VOLUME]** clockwise or counterclockwise to adjust.

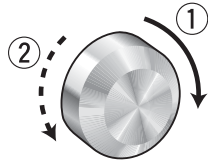

Note: If no operation takes place for more than 10 seconds in the audio menu (2 sec. in Main volume adjustment), the display returns to the regular mode.

Main volume adjustment

(Setting range: 0 to 40, Default: 18)

- ① : Up
- ② : Down

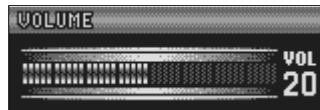

Bass adjustment

(Setting range: -12 dB to +12 dB, 2 dB Step, Default: Bass 0 dB)

- ① : Up
- ② : Down



Treble adjustment

(Setting range: -12 dB to +12 dB, 2 dB Step, Default: Treble 0 dB)

- ① : Up
- ② : Down



Note: Do not activate SQ and Bass/Treble at same time to avoid causing sound distortion.

SQ preset change

(Adjustable frequency: 60, 160, 400, 1 k, 3 k, 6 k, 16 k (Hz), Setting range: -12 dB to +12 dB, 2 dB Step) (⇒ page 19)

- ① : Up
 - ② : Down
- [>]: Higher frequency
[<]: Lower frequency



Balance adjustment

(Setting range: L15 to R15 and Center, Default: Center)

- ① : Right enhanced
- ② : Left enhanced



Fader adjustment

(Setting range: R15 to F15 and Center, Default: Center)

- ① : Front enhanced
- ② : Rear enhanced



Subwoofer level adjustment

(Setting range : mute (-∞), -6 dB to +6 dB, 2 dB Step, Default: 0 dB)

- ① : Up
- ② : Down



Subwoofer Low Pass Filter

(Setting range: 80 Hz, 120 Hz, 160 Hz, Default: 80 Hz)

- ① : Up
- ② : Down



Subwoofer output range
Other speakers output ranges

High Pass Filter

(Setting range: Filter OFF, 90 Hz, 135 Hz, 180 Hz, 225 Hz, Default: Filter OFF)

- ① : Up
- ② : Down



Function Setting

Adjustment to display on the FUNCTION menu

- 1 Press **[MENU]** to display the menu display.

For using the remote control, hold down **[SEL] (MENU)** for 2 sec. or more.

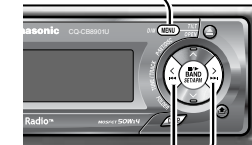

- 2 Press **[<]** or **[>]** to display the FUNCTION menu.



- 3 Press **[^]** or **[v]** to select a function to be adjusted.

- 4 Press **[BAND]** (**SET**) to adjust.

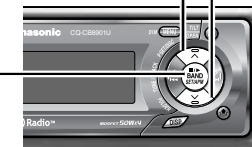

- 5 Press **[MENU]** to confirm the adjustment.

For using the remote control, hold down **[SEL] (MENU)** for 2 sec. or more.



MUTE KEY

Setting **[MUTE]** buttons' functions

- [MUTE]** : Volume off (Default)
- [ATT LW 1]** : Volume down by 10 steps
- [ATT LW 2]** : Volume down by 5 steps

SECURITY

Setting the security function (⇒ page 13)

- [ON]** : ON (Default)
- [OFF]** : OFF

Display Setting

Adjustment to display on the DISPLAY menu

1 Press [MENU] to display the menu display.

For using the remote control, hold down [SEL] (MENU) for 2 sec. or more.

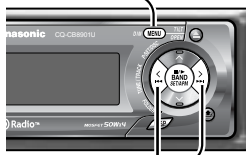

2 Press [◀] or [▶] to display the DISPLAY menu.

3 Press [▲] or [▼] to select a function to be adjusted.

4 Press [BAND] (SET) to confirm the display.

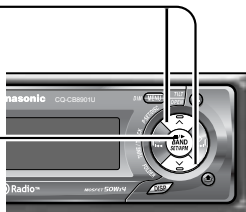

5 Adjust the setting value.

6 Press [BAND] (SET).

7 Press [MENU] to confirm the adjustment.

For using the remote control, hold down [SEL] (MENU) for 2 sec. or more.



Graphic pattern setting

(Setting range: 6 types, Default: All)

Switching by [◀] or [▶]

ALL: Sequential display from pattern A to D.

Pattern A-D

S.A.: 19-band display (Spectrum analyzer)



Still image setting

(Setting range: 11types, Default: All)

Switching by [◀] or [▶]

ALL: Sequential display from pattern 1 to 10

No.1-10



Contrast adjustment

(Setting range: 1 to 5, Default: Contrast 3)

[▶]: Tilting up view angle

[◀]: Tilting down view angle



Clock adjustment

Note: Adjust the clock when "ADJUST" appears on the display.

[▶]: Adjusting minutes

[◀]: Adjusting hours

[▲]: Forward

[▼]: Backward



Notes:

- The graphic pattern and still image are changeable. (⇒ page 37)
- If corrupted data is selected, "DISPLAY FILE INCOMPLETE" appears. (⇒ page 38)

Customize the Display (Customize Function)

You can edit the moving images and still images that are initially stored in the unit. You also can use the data that is downloaded from the Panasonic Web site and the data that is stored with a digital camera or other devices and processed with exclusive software, IMAGE STUDIO. See "Notes on Customize function" (⇒ page 38) as well.

Note: Visit Panasonic Web site (<http://panasonic.co.jp/pas/en/software/customize/index.html>) for details.

Preparation:

Put the CD-R/RW that contains data to be customized in hand.

1 If there is a disc inside, take out the disc.

2 Press [SRC] to select the CD mode.



3 Hold down [SEL] for 4 sec. or more to display the menu screen.

CUSTOMIZE MENU

4 Load a CD-R/RW that contains data.

Note:

- It may take time for the unit to identify the CD-R/RW.
- Discs recorded by the packet writing software are not supported.

5 Select an item to be customized.



[▲][▼]: Select

[BAND] (SET): Confirm

Note: To exit the customize menu, hold down [SEL] 4 sec. or more.

GRAPHIC PATTERN

Moving image (graphic pattern) data (⇒ page 36)

STILL IMAGE

Still image data (⇒ page 36)

OPENING MESSAGE

Moving image at power on (⇒ page 14)

CLOSING MESSAGE

Moving image at power off (⇒ page 14)

6 Select a file.



[▲][▼][◀][▶]: Select

[BAND] (SET): Confirm

Notes:

- Files are automatically identified by their extensions, and target files are displayed.
- If "BACK" is selected, the screen of step 5 appears.

7 For a moving image file or still image file, select where to save the file.



[◀][▶]: Select

[BAND] (SET): Confirm

Notes:

- New data overwrites existing data.
- If "BACK" is selected, the screen of step 6 appears.

8 Confirm the changed item.

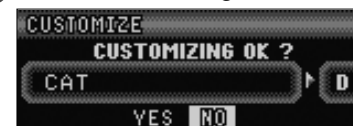

[◀][▶]: Select

[BAND] (SET): Confirm

CUSTOMIZING COMPLETE

Customization is performed. Do not turn off the power in mid-operation. (It takes approx. 8 minutes to complete this operation for a 751 kB moving image.) After completion of this operation, the screen of step 5 appears.

Note: If "NO" is selected, the screen of step 5 appears.

9 Hold down [SEL] 4 sec. or more.

The CD mode comes back. Press the [OPEN] button to eject the disc.

Note on Download Service

The download service may be suspended or stopped without advance notice. The download service is not available in some areas. Please visit the site below for further information.

Panasonic Web site:
(<http://www.panasonic.co.jp/global/>)

Notes on IMAGE STUDIO

- This download service is not available in some areas. For details, please access the Panasonic website.
- IMAGE STUDIO is available only by downloading from the address below. It is not bundled with this unit.
- Refer to the downloaded operating manual for how to use IMAGE STUDIO.

Notes on File

- The customize-specific file is downloadable from the URL below. You can create exclusive files stored with a digital camera or other devices by using exclusive software, IMAGE STUDIO that can be accessed from the same URL.
- Do not change the extension. Otherwise, the data cannot be recognized.

At Disc Making

- Save only customize-specific data.
- Save all data in the root directory. Files contained in a folder cannot be recognized.
- Follow the table below with regard to the number of files that are saved to a disc. Files beyond the specified capacity are not readable.
- Discs recorded by the packet writing software are not supported.

Type	Extension	Max. number
GRAPHIC PATTERN	.pfm	10
STILL IMAGE	.pfs	15
OPENING MESSAGE	.pfo	5
CLOSING MESSAGE	.pfe	5

At Customizing

- If customizing is interrupted on account of turning off the power, stopping the engine, removing the face plate or other reasons, you may lose the data. In such a case, try customizing again.
- The default image exists on the Panasonic Web site. If you would like to restore it, download the image from the site.

Download site:
<http://panasonic.co.jp/pas/en/software/customize/index.html>

Error Display Messages

NO FILES DETECTED

No customize-specific data on the disc

- ➔ Load a disc that contains customize-specific data.

CUSTOMIZING FAILED

Customize failed

- ➔ Check to see whether or not the extension is correct and file contents are appropriate.

DISPLAY FILE INCOMPLETE

Intended moving image or still image is damaged.

- ➔ Customize it again and overwrite the file with new one.

If You Suspect Something Wrong

Check and take steps as described below.

If the described suggestions do not solve the problem, it is recommended to take the unit to your nearest authorized Panasonic Servicenter. The product should be serviced only by qualified personnel. Please refer the checking and the repair to professionals. Panasonic shall not be liable for any accidents arising out of neglect of checking the unit or your own repair after your checking.

⚠ Cautions:

- Do not use the unit in an irregular condition, for example, without sound, or with smoke or a foul smell, which can cause ignition or electric shock. Immediately stop using the unit and consult your dealer.
- Never try to repair the unit by yourself because it is dangerous to do so.

Common

Problem	Possible cause ➔ Possible solution
No power to the unit	The power cord (battery, power and ground) is connected in the wrong way. ➔ Check the wiring.
	Fuse blows out. ➔ Eliminate the cause of fuse blowout and replace the fuse with new one. Consult your dealer.
Sound is not generated.	MUTE is set to ON. ➔ Set MUTE to OFF.
	The wiring of speaker lines are not correct, or a break or poor contact arises. ➔ Check the wiring in accordance with the wiring diagram. (➔ page 50)
The demonstration screen displayed and no operable	You cannot operate the unit while the demonstration screen appears. ➔ Press [DISP] to end the demonstration screen.
	If the demonstration screen appears frequently, there is a possibility that poor contact or wrong wiring arises between the battery lead of the unit and the battery cable of the car. (The battery lead should be always powered.) ➔ Check the battery wiring in accordance with the wiring diagram.
Noise	There is an electromagnetic-wave generator such as a cellular phone near the unit or its electrical lines. ➔ Keep an electromagnetic-wave generator such as a cellular phone away from the unit and the wiring of the unit. In case that noise cannot be eliminated due to the wiring harness of the car, consult your dealer.
	The contact of the ground lead is poor. ➔ Make sure that the ground lead is connected to an unpainted part of the chassis securely.
Noise is made in step with engine revolutions.	Alternator noise comes from the car. ➔ Change the wiring position of the ground lead. ➔ Mount a noise filter on the power supply.

Common (continued)

Problem	Possible cause → Possible solution
Some operations are not executable.	Some operations are not executable in particular modes such as menu mode. → Read the operating instructions carefully and cancel the mode. In case the unit is still out of order, consult the dealer.
No sound from speaker (s)	BALANCE/FADER setting is not appropriate. → Readjust BALANCE/FADER. There is a break, a short circuit, poor contact or wrong wiring regarding the speaker wiring. → Check the speaker wiring.
The speaker channels are reversed between right and left.	The speaker wiring is confused between right and left. → Perform the speaker wiring in accordance with the wiring diagram.
The sound field is not clear in the stereo mode. Central sound does not settled.	The plus and minus terminals at right and left channels of speakers are connected reversely. → Perform the speaker wiring in accordance with the wiring diagram.
The power fails unintentionally.	The safety device works. → Call the store where you purchased the unit, or your nearest Panasonic Servicenter.

Radio

Poor reception or noise	Antenna installation or wiring of antenna cable is faulty. → Check whether the antenna mounting position and its wiring are correct. In addition, check to see whether the antenna ground is securely connected to the chassis.
	No power is supplied to the antenna amplifier (when using a film antenna, etc.). → Check the wiring of the antenna battery lead.
No digital sound is output.	Unsatisfactory broadcast conditions. → Receive and listen to signals from the station concerned in the analog mode.
	There are no HD radio broadcast stations. → Move to an area where HD radio can be received. Analog mode is selected. → Select AUTO mode.
Seeking takes too long.	Digital seeking may take some time. → Change to auto seeking, and proceed with seeking again.

Radio (continued)

Problem	Possible cause → Possible solution
The number of auto preset stations is less than 6.	The number of receivable stations is less than 6. → Move to an area where receivable stations number is maximum, and try pre-setting.
Preset stations cannot be stored.	The contact of the battery lead is poor, or the battery lead is not always powered. → Make sure that the battery lead is connected securely, and preset stations again.

XM Tuner

Channel unselectable	No contract with XM Satellite Radio Inc. → Refer to page 13 of this book and the XM's website to sign up for XM Radio service.
----------------------	--

CD

No playback or disc ejected	The disc is inserted upside down. → Insert a disc correctly.
	There is a flaw or foreign material on the disc. → Remove the foreign material, or use a flawless disc.
Sound skipping or noise	There is a flaw or foreign material on the disc. → Remove the foreign material, or use a flawless disc.
Sound skipping due to vibration	The unit is not sufficiently secured. → Secure the unit to the console box with the rear support strap, etc.
	The unit is tilted at over 30° in the front-to-end direction. → Make the angle 30° or less.
Disc unejectable	Something such as a peeled label obstructs the disc coming out. → Hold down the [OPEN] button for 2 sec. or more when the face plate is open (disc forced ejection). In case that the disc forced ejection does not work, consult the dealer
	The microcontroller in the unit operates abnormally due to noise or other factors. → Unplug the power cord and plug it again. In case the unit is still out of order, consult the dealer.

	Problem	Possible cause → Possible solution
MP3/WMA	No playback or disc ejected	The disc has unplayable formatted data. → Refer to the description about MP3/WMA for playable sound data except CD-DA (i.e. music CD). The unit plays back the ROM track of a MIX mode CD. → Skip the ROM track.
	The CD-R/RWs that are playable on other devices are not playable on this unit.	The playability of some CD-R/RWs may depend on the combination of media, recording software and recorder to be used even if these CD-R/RWs are playable on other devices such as a PC. → Make CD-R/RWs in different combination of media, recording software and recorder after referring to the description about MP3/WMA.
	Sound skipping or noise	There is a flaw or foreign material on the disc. → Remove the foreign material, or use a flawless disc. For MP3/WMA, refer to the description about MP3/WMA.

Error Display Messages

	Problem	Possible cause → Possible solution
Radio	RADIO E 1	Digital broadcasts cannot be received because something is wrong. (However, analog broadcasts can still be received.) → Call the store where you purchased the unit or the nearest Panasonic Servicenter to ask for repairs.
XM Tuner	NO XM	Cannot receive XM satellite radio. → Verify the wiring.
	ANTENNA	XM antenna unconnected. → Connect the XM antenna.
	NO SIGNAL	XM broadcasts unreceivable because of poor receiving conditions. → Move to an area where XM broadcasts can be received well.
	OFF AIR	Channel not in service → This channel is not currently in service. Tune to another channel.

	Problem	Possible cause → Possible solution
CD/MP3/WMA	CD E 1	Disc is dirty, or is upside down.
	CD E 2	Disc has scratches.
	CD E 3	No operation by some cause. → When normal operation is not performed even after ejection, forced ejection or turning on/off, Call the store where you purchased the unit, or your nearest Panasonic Servicenter.
	CD E 4	The file is not readable. → Insert a different disc.
	PROTECTED (After 5 seconds) To next file automatically	A WMA file can be copyrighted. → The file protected by copyright is not playable.
	NO DISC	No disc.
DISC Changer	CHANGER E 1	Disc is dirty, or is upside down.
	CHANGER E 2 (After 5 seconds) To next disc automatically	Disc has scratches. → Eject the magazine. • Check the disc. • Load the disc again.
	CHANGER E 3	No operation by some cause. → Eject the magazine. If failure persists, press the reset switch on the DISC changer. If normal operation is not restored, call the store where you purchased the unit or the nearest Panasonic Servicenter to ask for repairs.
	CHANGER E 6	An error arises in the DVD changer. → Check the DVD changer. ("REGION ERROR" etc.)
	NO DISC	No disc is in the CD Changer (magazine). → Insert discs into the changer (magazine).
	NOT CONNECTED	The changer has become disconnected from the unit in the changer mode. → Verify the wiring.

Note: Messages in the action and display sections of the error chart vary with changers. Refer to the operating instructions for the Disc changer for details.

If you use commercial CDs, they must have either of these labels shown at right. Some copy-protected music CDs are not playable.



How to hold the disc

- Do not touch the underside of the disc.
- Do not scratch on the disc.
- Do not bend the disc.
- When not in use, keep disc in the case.

Do not use irregularly shaped discs.

Do not leave discs in the following places:

- In direct sunlight
- Near car heaters
- Dirty, dusty and damp areas
- On seats and dashboards

Disc cleaning

Use a dry, soft cloth to wipe from the center outward.

Do not attach any seals or labels to your discs.

Do not write on the disc label with a ballpoint pen or other hard-point pens.

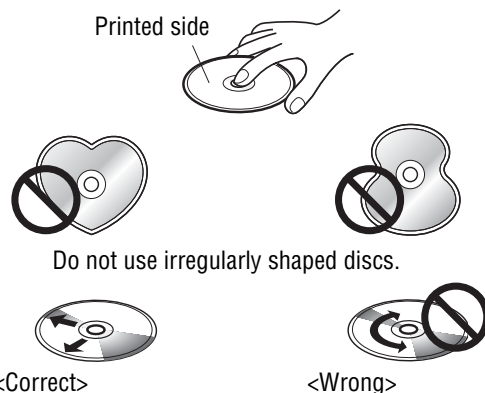

- You may have trouble playing back some CD-R/RW discs recorded on CD recorders (CD-R/RW drives), either due to their recording characteristics or dirt, fingerprints, scratches, etc. on the disc surface.
- CD-R/RW discs are less resistant to high temperatures and high humidity than ordinary music CDs. Leaving them inside a car for extended periods may damage and make playback impossible.
- Some CD-R/RWs can not be played back successfully thanks to incompatibility among writing software, a CD recorder (CD-R/RW drive) and the discs.
- This player cannot play the CD-R/RW discs if the session is not closed.
- This player cannot play the CD-R/RW discs which contains other than CD-DA or MP3/WMA data (Video CD, etc.).
- Be sure to observe the instructions of CD-R/RW disc for handling it.

Maintenance

Your product is designed and manufactured to ensure the minimum of maintenance. Use a soft cloth for routine exterior cleaning. Never use benzine, thinner, or other solvents.

If the fuse blows out, consult your dealer, or your nearest authorized Panasonic Servicenter.

Warning

- Use fuses of the same specified rating (15 A). Using substitutes or fuses with higher ratings, or connecting the unit directly without a fuse could cause fire or damage to the unit. **If the replaced fuse fails, contact your nearest authorized Panasonic Servicenter.**



WARNING

This installation information is designed for professional installers with knowledge of automobile electrical safety systems and is not intended for non-technical, do-it-yourself individuals. It does not contain instructions on the electrical installation and avoidance of potential harm to air bag, anti-theft and ABS braking or other systems necessary to install this product.

Any attempt to install this product in a motor vehicle by anyone other than a professional installer could cause damage to the electrical safety system and could result in serious personal injury or death.

If your car is equipped with air bag and/or anti-theft systems, specific procedures may be required for connection and disconnection of the battery to install this product.

Before attempting installation of this electronic component against the manufacturer's recommendation, you must contact your car dealer or manufacturer to determine the required procedure and strictly follow their instructions.

FAILURE TO FOLLOW THE PROCEDURE MAY RESULT IN THE UNINTENDED DEPLOYMENT OF AIR BAGS OR ACTIVATION OF THE ANTI-THEFT SYSTEM RESULTING IN DAMAGE TO THE VEHICLE AND PERSONAL INJURY OR DEATH.

This product should be installed by a professional. However, should you decide to install the product against the manufacturer's recommendation, this operating Instructions does not contain electrical installation instructions. You must contact your car dealer or manufacturer for electrical connection instructions to avoid possible damage to your electrical safety systems and resulting injury or death.

(Please refer to the "WARNING" statement above). Your next step is to decide where to install the unit. The instructions in these pages will guide you through the remaining steps:

- Identify and label the car wires.
- Connect the car wires to the wires of the power connector.
- Install the unit.
- Check the operation of the unit.

If you encounter problems, please consult your nearest professional installer.

Caution: This unit operates with a 12 V DC negative ground auto battery system only. Do not attempt to use it in any other system. Doing so could cause serious damage.

Before you begin installation, look for the following items which are packed with your unit.

- **Installation Hardware** ... Needed for installation.

⚠ Warning

• **DO NOT INSTALL THE MONITOR IN A LOCATION WHICH OBSTRUCTS DRIVING, VISIBILITY OR WHICH IS PROHIBITED BY APPLICABLE LAWS AND REGULATIONS. If the monitor is installed in a location which obstructs forward visibility or operation of the air bag or other safety equipment or which interferes with operation of the car, it may cause an accident.**

- Never use bolts or nuts from the car's safety devices for installation. If bolts or nuts from the steering wheel, brakes or other safety devices are used for installation of the monitor, it may cause an accident.
- Attach the wires correctly. If the wiring is not correctly performed, it may cause a fire, failure of electrical equipment and-or an accident. In particular, be sure to run and secure the lead wire so that it does not get tangled with a screw or the moving portion of a seat rail.
- Use with 12 V DC negative ground car. This unit is only for use with a 12 V DC negative ground car. It cannot be used in large trucks or diesel cars which are 24 V DC cars. If it is used in the wrong type of car, it may cause a fire or an accident.

⚠ Cautions:

- Use the specified fuse. Be sure to always use the specified fuse. If a fuse other than the specified fuse is used, it may cause a fire or an accident.
- Do not damage the cord by pinching or pulling it. Do not pull or damage the cord. If the cord is not treated properly, it will short out or be severed and may cause a fire or an accident.

□ Required Tools

You'll need a screwdriver and the following:

12 V DC
Test Bulb

Electrical
Tape

Side-Cut
Pliers

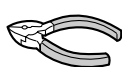

□ Dashboard Specifications

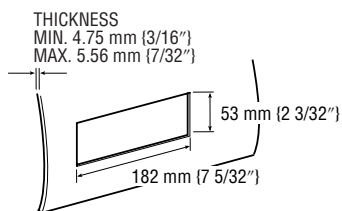

□ Identify All Leads

The first step in installation is to identify all the car wires you'll use when hooking up your LCD monitor. As you identify each wire, we suggest that you label it using masking tape and a permanent marker. This will help avoid confusion when making connections later.

Note: Do not connect the power connector to the display unit until you have made all connections. If there are no plastic caps on the hooking wires, insulate all exposed leads with electrical tape until you are ready to use them. Identify the leads in the following order.

Power Lead

If your car has a radio or is pre-wired for one: Cut the connector wires one at a time from the plug (leaving the leads as long as possible) so that you can work with individual leads. Turn the ignition on to the accessory position, and ground one lead of the test bulb to the chassis.

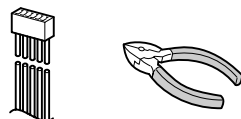

Touch the other lead of the test bulb to each of the exposed wires from the cut radio connector plug. Touch one wire at a time until you find the outlet that causes the test bulb to light.

Now turn the ignition off and then on. If the bulb also turns off and on, that outlet is the car power lead.

If your car is not wired for an audio unit: Go to the fuse block and find the fuse port for radio (RADIO) accessory (ACC) or ignition (IGN).

Battery Lead

If your stereo unit has a yellow lead, you will need to locate the car's battery lead. Otherwise you may ignore this procedure. (The yellow battery lead provides continuous power to maintain a clock or other functions.)

If your car has a radio or is pre-wired for one: With the ignition and headlights off, identify the car battery lead by grounding one lead of the test bulb to the chassis and checking the remaining exposed wires from the cut radio connector plug.

If your car is not wired for an audio unit: Go to the fuse block and find the fuse port for the battery, usually marked BAT.

Speakers (not supplied speaker)

Identify the car speaker leads. There are two leads for each speaker, usually color coded. A handy way to identify the speaker leads and the speaker they are connected with is to test the leads using a 1.5 V AA battery as follows. Hold one lead against one pole of the battery and stroke the other lead across the other pole. You will hear a scraping sound in a speaker if you are holding a speaker lead. If not, keep testing different lead combinations until you have located all the speaker leads. When you label them, include the speaker location for each.

□ Connect All Leads

Now that you have identified all the wires in the car, you're ready to begin connecting them to the LCD monitor wires. The Electrical Connections (→ page 50-51) shows the proper connections and color coding of the leads. We strongly recommend that you test the unit before making a final installation. You can set the unit on the floor and make temporary connections to test the unit. Use electrical tape to cover all exposed wires.

Important: Connect the red power lead last, after you have made and insulated all other connections.

Ground

Connect the black ground lead of the power connector to the metal car chassis.

Speakers

Connect the speaker wires. See the wiring diagram for the proper hookups. Follow the diagram carefully to avoid damaging the speakers and the stereo unit. The speakers used must be able to handle more than 50 W of audio power. If using an optional audio power, the speakers should be able to handle the maximum amplifier output power. Speakers with low input ratings can be damaged.

Speaker impedance should measure 4–8 Ω, which is typically marked on most speakers. Lower or higher impedance speakers will affect output and can cause both speaker and stereo unit damage.

⚠ Caution: Never ground the speaker cords. For example, do not use a chassis ground system or a three-wire speaker common system. Each speaker must be connected separately using parallel insulated wires. If in doubt about how your car's speakers are wired, please consult with your nearest professional installer.

Battery

Connect the yellow battery lead to the correct radio wire or to the battery fuse port on the fuse block.

Equipment

Connect any optional equipment according to the instructions furnished with the equipment. Read the operating and installation instructions of any equipment you will connect to this unit.

Power

Connect the red power lead to the correct car radio wire or to the appropriate fuse port on the fuse block. If the LCD monitor functions properly with all these connections made, disconnect the wires and proceed to the final installation.

□ Final Installation

Lead Connections

Connect all wires, making sure that each connection is insulated and secure. Bundle all loose wires and fasten them with tape so they will not fall down later. Now insert the LCD monitor into the mounting collar.

Congratulations! After making a few final checks, you're ready to enjoy your new LCD monitor.

□ Final Checks

1. Make sure that all wires are properly connected and insulated.
2. Make sure that the LCD monitor is securely held in the mounting collar.
3. Turn on the ignition to check the unit for proper operation.

If you have difficulties, consult your nearest authorized professional installer for assistance.

- Before installation, check the radio operation with antenna and speakers.
- Disconnect the cable from the negative (-) battery terminal (see caution below).
- Unit should be installed in a horizontal position with the front end up at a convenient angle, but not more than 30°.
- Remove Mounting Collar ① and Trim Plate ④ from the main unit temporarily, which are already mounted at shipment.

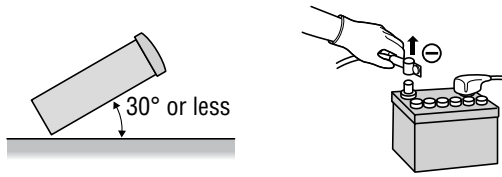

Caution: Do not disconnect the battery terminals of a car with trip or navigational computer since all user settings stored in memory will be lost. Instead take extra care with installing the unit to prevent shorts.

Supplied Hardware

No.	Item	Diagram	Q'ty
①	Mounting Collar		1
②	Mounting Bolt (5 mmø)		1
③	Power Connector		1
④	Trim Plate		1
⑤	Lock Cancel Plate		2
⑥	Rear Support Strap		1
⑦	Tapping Screw (5 mmø x 16 mm)		1
⑧	Hex. Nut (5 mmø)		1

Methods for Fixing the Rear of the Unit.

Installation Opening

The unit can be installed in any dashboard having an opening as shown at right. The dashboard should be 4.5 mm - 6 mm thick in order to be able to support the unit.

Installation Precautions

This product should be installed by a professional installer, if possible.

In case of difficulty, please consult the shop where you purchased the product.

1. This system is to be used only in a 12-volt, DC battery system (car) with negative ground.
2. Follow the electrical connections carefully (→ Page 50-51). Failure to do so may result in damage to the unit.
3. Connect the power lead (red) after all other connections are made.
4. Be sure to connect the battery lead (yellow) to the positive terminal (+) of the battery or fuse block (BAT) terminal.
5. Insulate all exposed wires to prevent short circuiting.
6. Secure all loose wires after installing the unit.
7. Please carefully read the operating and installation instructions of the respective equipment before connecting it to this unit.

(a) Using the Rear Support Strap

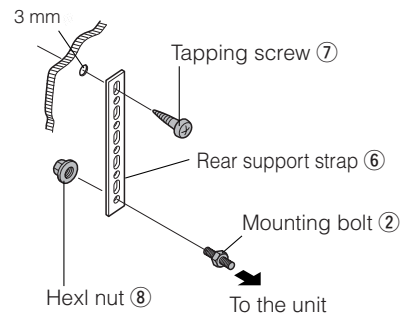

(b) Using the Rubber Bushing (option)

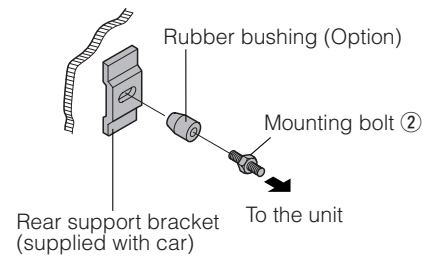

⚠ Cautions:

- We strongly recommend that you wear gloves for installation work to protect yourself from injuries.
- When bending the mounting tab of the mounting collar with a screwdriver, be careful not to injure your hands and fingers.

First complete the electrical connections, and then check them for correctness. (→ Page 50-51)

The included Mounting Collar ① is designed specially for this unit. Do not use it to attach any other model.

⚠ Caution:

When this unit is installed in dashboard, ensure that there is sufficient air flow around the unit to prevent damage from overheating, do not block any ventilation holes on the unit.

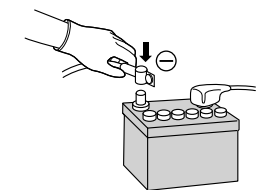
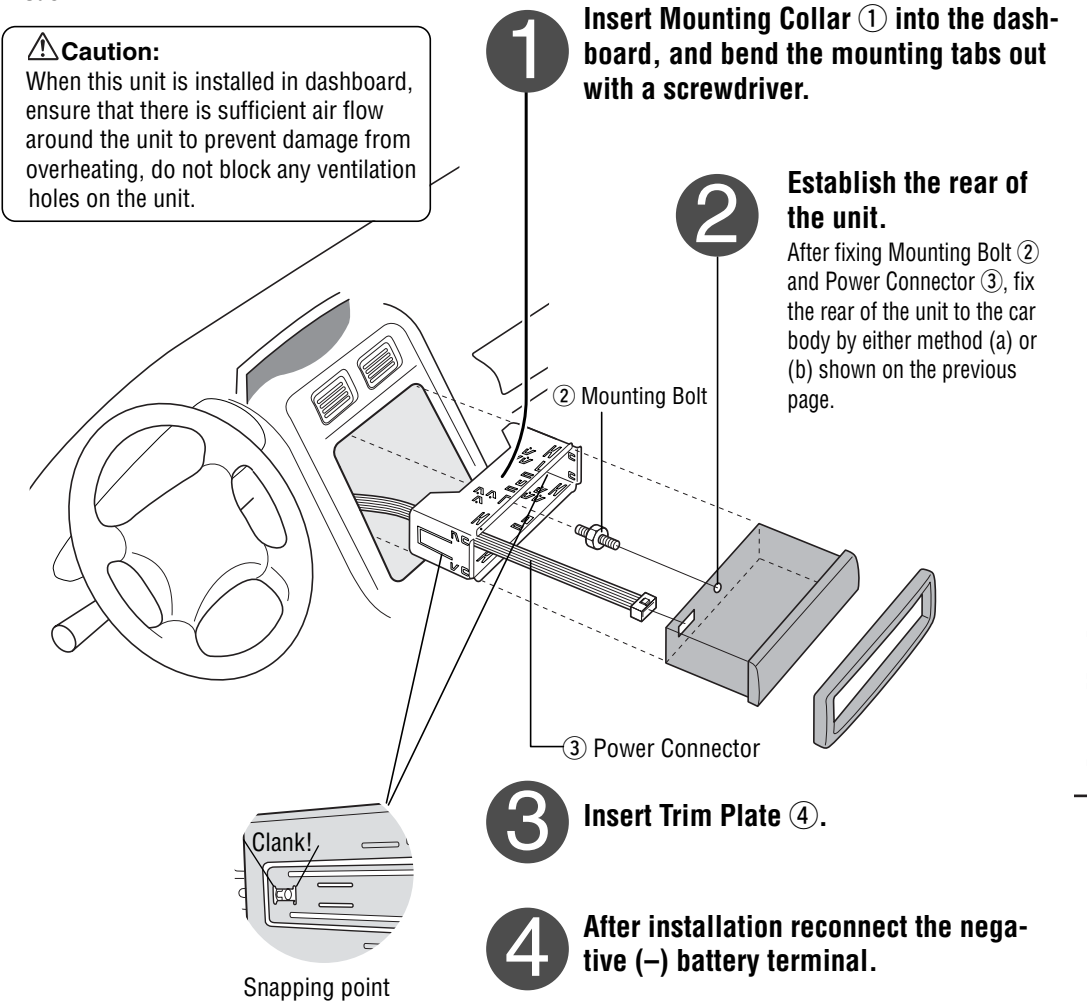

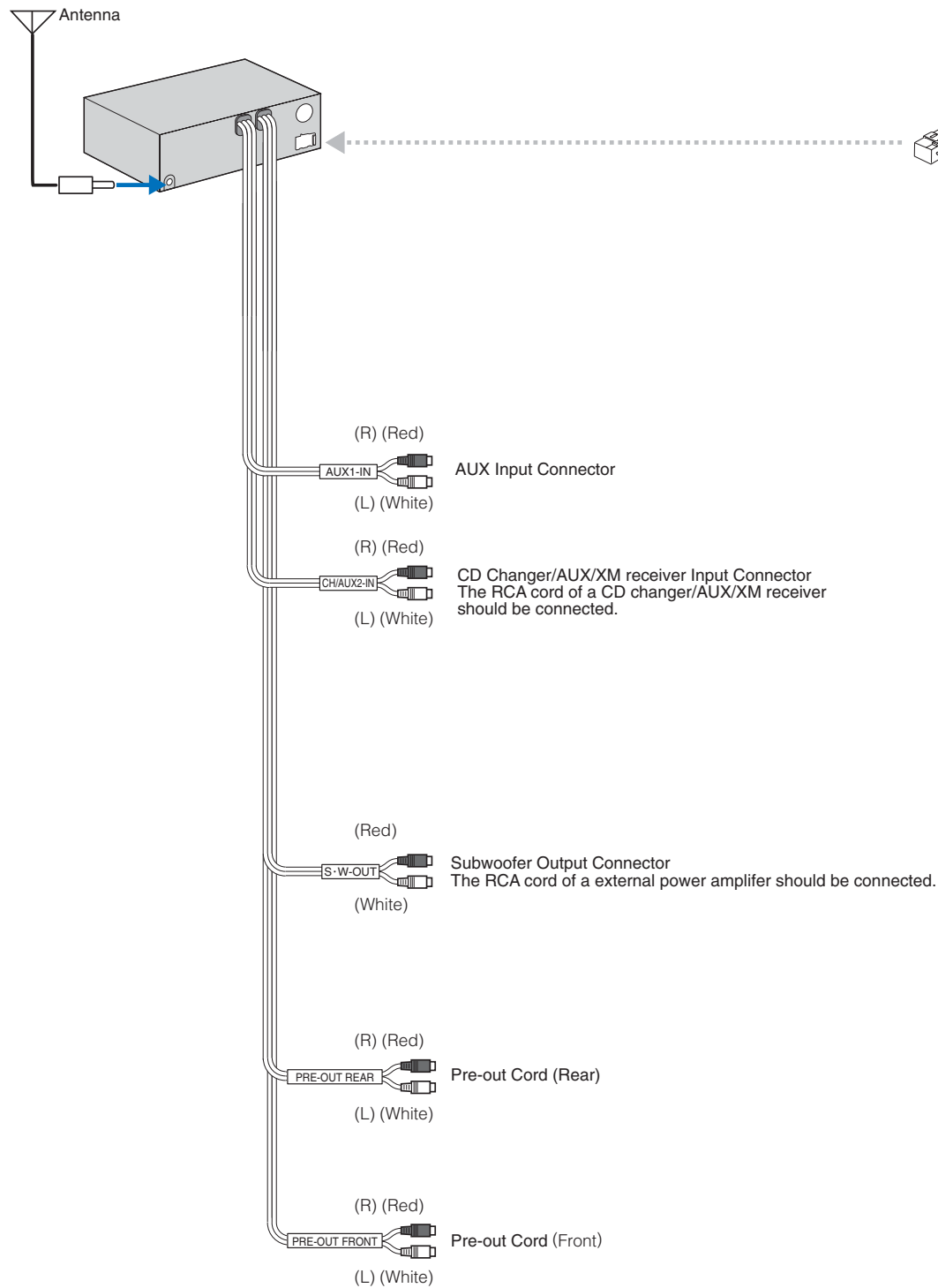

⚠ Cautions

- This unit is designed for use in a car having a 12 V negative ground battery system.
- To prevent damage to the unit, be sure to follow the connection diagram below.
- Strip about 5 mm of the lead ends for connection.
- Do not insert the power connector into the unit until the wiring is completed.
- Be sure to insulate any exposed wires to prevent short circuiting with the car chassis. Bundle all cables, and prevent cable terminals from touching any metal parts.
- Remember, if your car has drive computer or a navigation computer, the data of its memory may be erased when the battery terminals are disconnected.

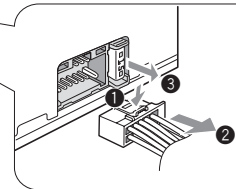

Fuse (15 A) Refer fuse replacement to your nearest authorized Panasonic Servicenter. Do not try fuse replacement by yourself.

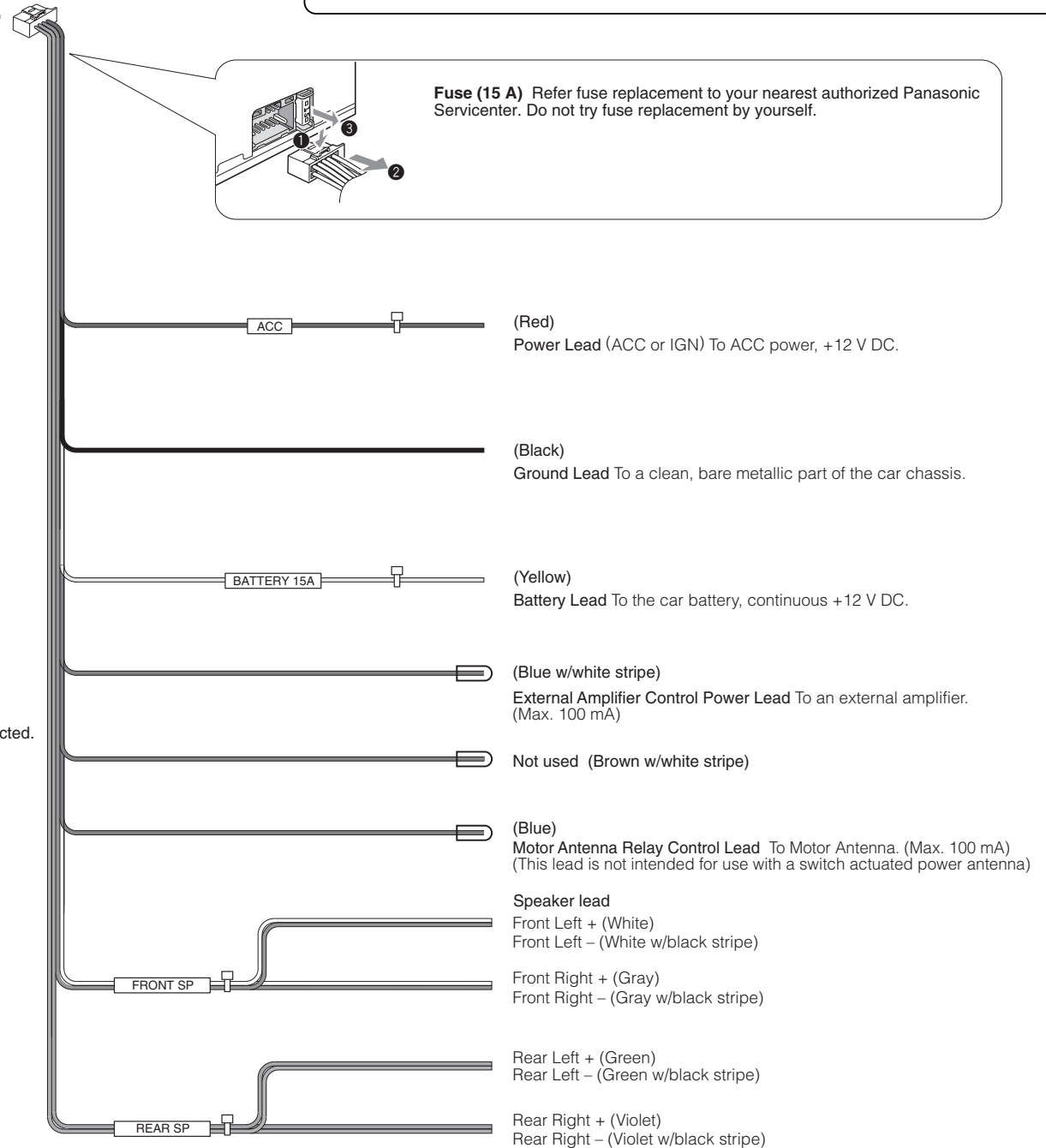

- For connection to a CD changer (CX-DP880) or DVD changer (CX-DH801U), refer to the operating instructions of corresponding device.
- For details, consult the shop where you purchased this product.

• A CD changer, an XM receiver cannot be connected at the same time.

System Upgrade Example: Connecting with a CD changer

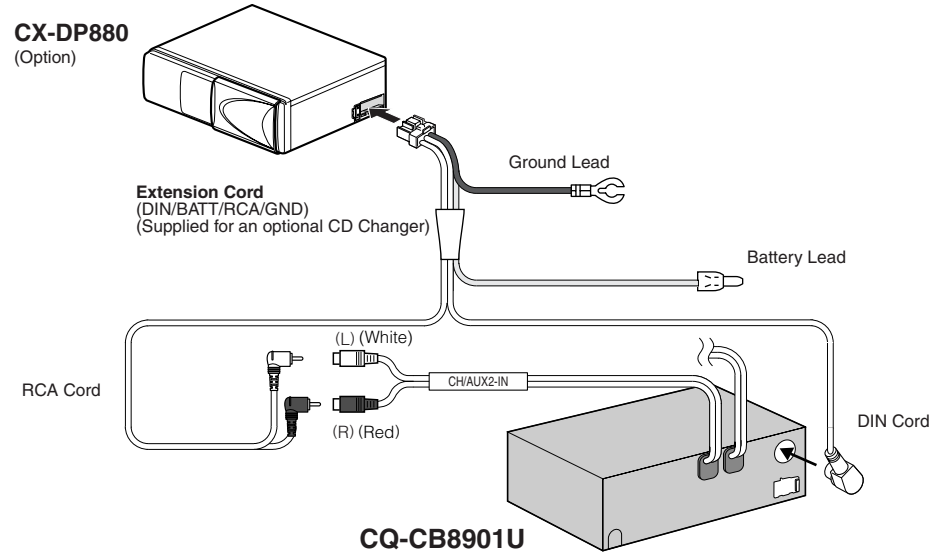

System Upgrade Example: Connecting with an XM Receiver

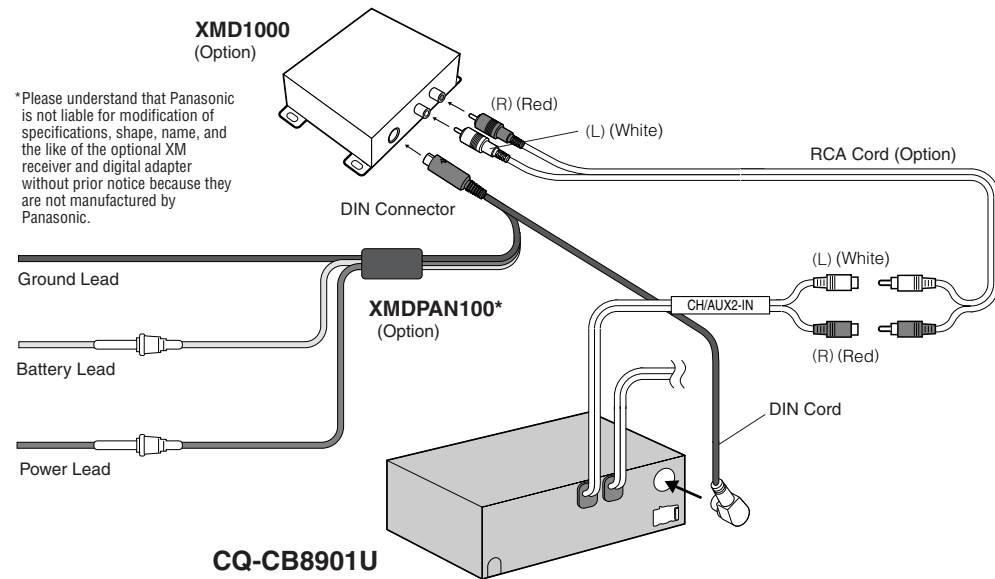

Caution: Please follow the instructions given below. Failure to do so will cause damage to the unit and speakers.

- Use ungrounded speaker only.
- The maximum speaker input should be 50 W or more. (If used with the optional power amplifier, the speaker input should be higher than the maximum amplifier output.)
- The speaker impedance should be 4 - 8 Ω.
- This unit uses the BTCL circuit, so each speaker should be connected separately using parallel vinyl insulated cords.
- The speaker cords and the power amplifier unit should be kept away (about 30 cm apart) from the antenna and antenna extension cord.

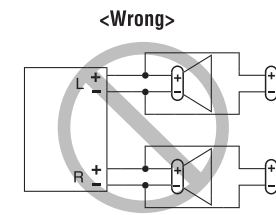
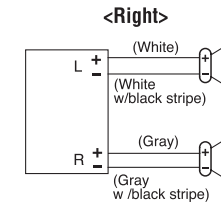

- Do not connect more than one speaker to one set of speaker leads. (except for connecting to a tweeter)

1 Remove the face plate.

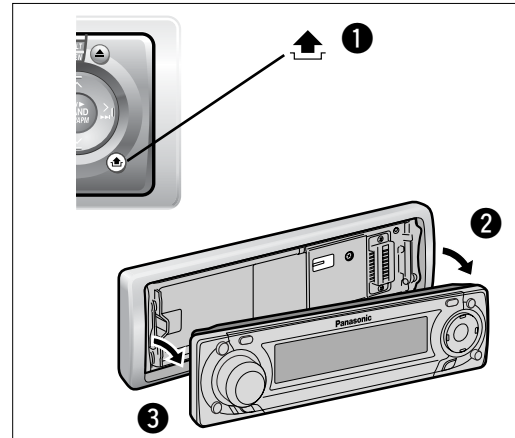

2 Remove the trim plate.

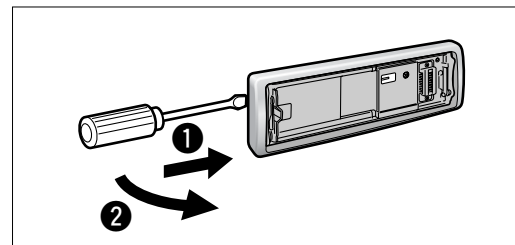

3 Lock release
 1 Insert the lock cancel plate until you hear a click.
 2 Pull the main unit.

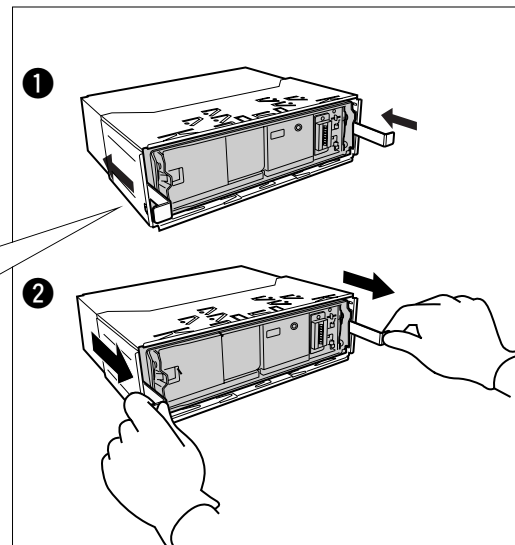
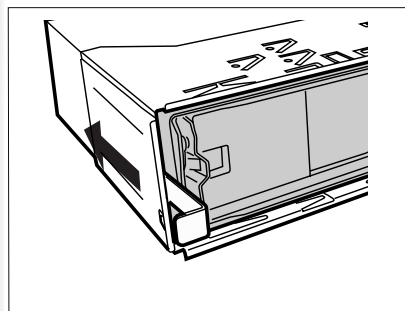

4 Pull out the unit with both hands.

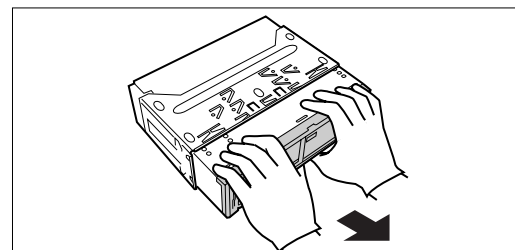

⚠ Cautions:

- Do not touch the contacts on the face plate or on the main unit, since this may result in poor electrical contacts.
- If dirt or other foreign substances get on the contacts, wipe them off with clean and dry cloth.

General

Power Supply	DC 12 V (11 V - 16 V), Test Voltage 14.4 V, Negative Ground
Tone Controls (Bass/Treble)	Bass; ±12 dB at 62 Hz, Treble; ±12 dB at 16 kHz
Equalizer Center Frequency	60, 160, 400, 1 k, 3 k, 6 k, 16 k (Hz)
Variable Range of Equalizer	-12 dB to 12 dB (2 dB step)
Current Consumption	Less than 2.2 A (CD mode, 0.5 W 4-Speaker)
Maximum Power Output	50 W x 4 (at 1 kHz)
Speaker Impedance	4 - 8 Ω
Pre-amp output voltage	5 V
Subwoofer-output voltage	5 V
Pre-amp output impedance	60 Ω
Subwoofer-output impedance	60 Ω
Dimensions (Main Unit)	178(W) x 50(H) x 155(D) mm {7" x 1 15/16" x 6 1/8"}
Weight (Main Unit)	1.7 kg {3 lbs. 12 oz}

CD Player

Sampling Frequency	8 times oversampling
DA Converter	4 DAC System
Pick-Up Type	Astigma 3-beam
Light Source	Semiconductor laser
Wavelength	790 nm
Frequency Response	20 Hz - 20 kHz (±1 dB)
Signal to Noise Ratio	96 dB
Total Harmonic Distortion	0.01 % (1 kHz)
Wow and Flutter	Below measurable limits
Channel Separation	86 dB

Radio

FM		FM (HD Radio)	
Frequency Range	87.9 MHz - 107.9 MHz	Frequency Range	87.9 MHz - 107.9 MHz
Usable Sensitivity	12.2 dBf. (1.12 μV, 75Ω)	Usable Sensitivity	-88 dBm (BER<1.0X10 ⁻⁵)
50 dB quieting Sensitivity	15.2 dBf. (1.59 μV, 75Ω)	Signal to noise ratio	79 dB
Frequency Response	30 Hz - 15 kHz (±3 dB)	Stereo Separation	76 dB
Alternate channel selectivity	75 dB	Total harmonic distortion	0.08 % (1 kHz)
Stereo Separation	40 dB (at 1 kHz)		
Image response ratio	75 dB		
IF response ratio	100 dB		
Signal to noise ratio	62 dB		
AM		AM (HD Radio)	
Frequency Range	530 kHz - 1 710 kHz	Frequency Range	530 kHz - 1 710 kHz
Usable Sensitivity	25 dB/μV (S/N 20 dB)	Usable Sensitivity	21 dB/μV (BER<1.0X10 ⁻⁵)
		Signal to noise ratio	77 dB
		Stereo Separation	74 dB
		Total harmonic distortion	0.08 % (1 kHz)

Above Specifications comply with EIA standards.

Power Output:
 18 W RMS x 4 Channels at 4 Ω and ≤ 1%
 THD+N
 Signal to Noise Ratio:
 78 dBA (reference: 1 W into 4 Ω)



Notes:

- Specifications and design are subject to modification without notice due to improvements.
- Some figures and illustrations in this manual may be different from your product.