

Panasonic

Operating Instructions

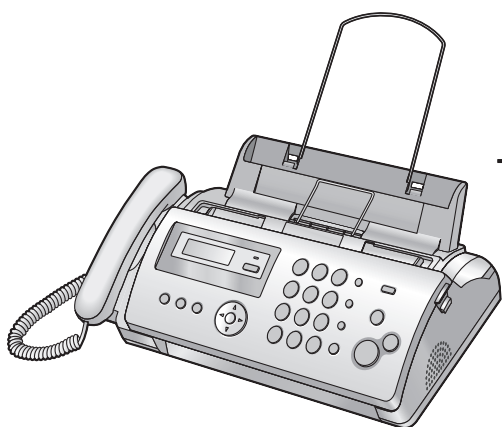

This pictured model is KX-FP205.

Compact Plain Paper Fax

Model No. **KX-FP205E**

Compact Plain Paper Fax
with Digital Answering System

Model No. **KX-FP215E**

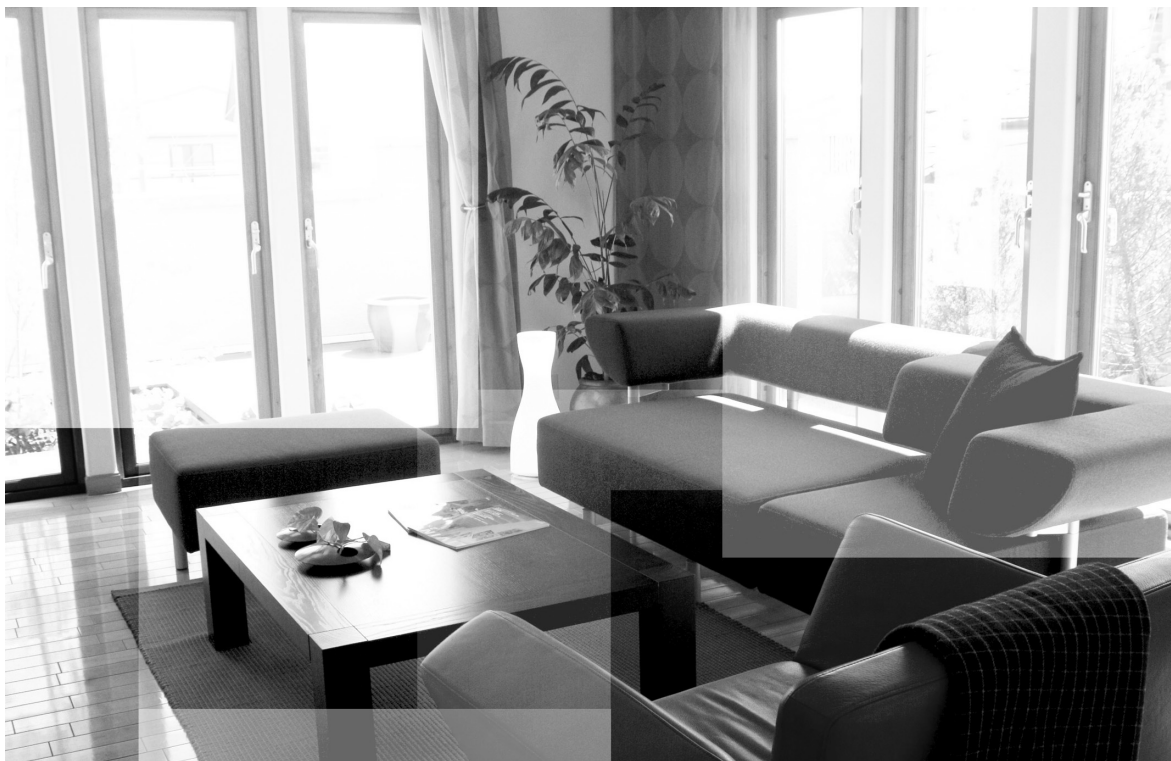

Please read these operating instructions before using the unit and save for future reference.

This unit is compatible with Caller ID. To use this feature, you must subscribe to the appropriate service of your service provider.

Be sure to use the telephone line cord included in this unit.

This model is designed to be used only in the United Kingdom and Ireland.

Thank you for purchasing a Panasonic fax machine.

Things you should keep a record of

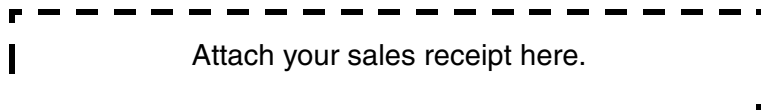

For your future reference

| |
|---|
| Date of purchase |
| Serial number (found on the rear of the unit) |
| Dealer's name and address |
| Dealer's telephone number |

Caution:

- Note that the images of copied or received documents will remain on the used ink film. Use discretion when disposing of the used ink film.
- Do not rub or use an eraser on the printed side of recording paper, as the print may smear.
- In the event of problems, you should contact your equipment supplier in the first instance.
- This equipment is designed for use on the UK and Republic of Ireland analogue telephone network.

Declaration of Conformity:

- Panasonic Communications Co., Ltd. declares that this equipment is in compliance with the essential requirements and other relevant provisions of Radio & Telecommunications Terminal Equipment (R&TTE) Directive 1999/5/EC.
Declarations of Conformity for the relevant Panasonic products described in this manual are available for download by visiting:
<http://www.doc.panasonic.de>

Contact:
Panasonic Services Europe
a Division of Panasonic Marketing Europe GmbH
Panasonic Testing Centre
Winsbergring 15, 22525 Hamburg, Germany

Note:

- The suffix in the model number will be omitted in these instructions.
- Most figures shown in these operating instructions are based on a KX-FP205.

Copyright:

- This material is copyrighted by Panasonic Communications Co., Ltd., and may be reproduced for internal use only. All other reproduction, in whole or in part, is prohibited without the written consent of Panasonic Communications Co., Ltd.

© 2006 Panasonic Communications Co., Ltd. All Rights Reserved.

Important safety instructions

When using this unit, basic safety precautions should always be followed to reduce the risk of fire, electric shock, or personal injury.

1. Read and understand all instructions.
2. Follow all warnings and instructions marked on this unit.
3. Unplug this unit from power outlets before cleaning. Do not use liquid or aerosol cleaners.
4. Do not use this unit near water, for example near a bathtub, wash bowl, kitchen sink, etc.
5. Place the unit securely on a stable surface. Serious damage and/or injury may result if the unit falls.
6. Do not cover slots and openings on the unit. They are provided for ventilation and protection against overheating. Never place the unit near radiators, or in a place where proper ventilation is not provided.
7. Use only the power source marked on the unit. If you are not sure of the type of power supplied to your home, consult your dealer or local power company.
8. For safety purposes this unit is equipped with a grounded plug. If you do not have this type of outlet, please have one installed. Do not defeat this safety feature by tampering with the plug.
9. Do not place objects on the mains lead. Install the unit where no one can step or trip on the cord.
10. Do not overload power outlets and extension cords. This can result in the risk of fire or electric shock.
11. Never push any objects through slots in this unit. This may result in the risk of fire or electric shock. Never spill any liquid on the unit.
12. To reduce the risk of electric shock, do not disassemble this unit. Take the unit to an authorised service centre when service is required. Opening or removing covers may expose you to dangerous voltages or other risks. Incorrect reassembly can cause electric shock when the unit is subsequently used.
13. Unplug this unit from power outlets and refer servicing to an authorised service centre when the following conditions occur:
 - A. When the mains lead is damaged or frayed.
 - B. If liquid has been spilled into the unit.
 - C. If the unit has been exposed to rain or water.
 - D. If the unit does not work normally by following the operating instructions. Adjust only controls covered by the operating instructions. Improper adjustment may require extensive work by an authorised service centre.
 - E. If the unit has been dropped or physically damaged.
 - F. If the unit exhibits a distinct change in performance.
14. During thunderstorms, avoid using telephones except cordless types. There may be a remote risk of an electric shock from lightning.

15. Do not use this unit to report a gas leak, when in the vicinity of the leak.

SAVE THESE INSTRUCTIONS

CAUTION:

Installation

- Never install telephone wiring during a lightning storm.
- Never install telephone sockets in wet locations unless the socket is specifically designed for wet locations.
- Never touch uninsulated telephone wires or terminals unless the telephone line has been disconnected at the network interface.
- Use caution when installing or modifying telephone lines.
- Do not touch the plug with wet hands.

WARNING:

- To prevent the risk of fire or electrical shock, do not expose this product to rain or any type of moisture.
- Unplug this unit from power outlets if it emits smoke, an abnormal smell or makes unusual noise. These conditions can cause fire or electric shock. Confirm that smoke has stopped and contact an authorised service centre.

Information on Disposal for Users of Waste Electrical & Electronic Equipment (private households)

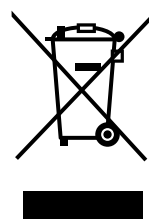

This symbol on the products and/or accompanying documents means that used electrical and electronic products should not be mixed with general household waste.

For proper treatment, recovery and recycling, please take these products to designated collection points, where they will be accepted on a free of charge basis. Alternatively, in some countries you may be able to return your products to your local retailer upon the purchase of an equivalent new product. Disposing of this product correctly will help to save valuable resources and prevent any potential negative effects on human health and the environment which could otherwise arise from inappropriate waste

handling. Please contact your local authority for further details of your nearest designated collection point. Penalties may be applicable for incorrect disposal of this waste, in accordance with national legislation.

For business users in the European Union

If you wish to discard electrical and electronic equipment, please contact your dealer or supplier for further information.

Information on Disposal in other Countries outside the European Union

This symbol is only valid in the European Union. If you wish to discard this product, please contact your local authorities or dealer and ask for the correct method of disposal.

For best performance

Environment

- Keep the unit away from electrical noise generating devices, such as fluorescent lamps and motors.
- The unit should be kept free from dust, high temperature and vibration.
- The unit should not be exposed to direct sunlight.
- Do not place heavy objects on top of the unit.
- When you leave the unit unused for a long period of time, unplug this unit from power outlet.
- The unit should be kept away from heat sources such as heaters, kitchen stoves, etc. Damp basements should also be avoided.

Routine care

- Wipe the outer surface of the unit with a soft cloth. Do not use benzine, thinner, or any abrasive powder.

Important Information

The connection to the telecommunication systems must not be hard wired and must be unplugged before the earth is disconnected.

Method of connection

This apparatus is connected to the exchange line or PABX/PMBX extension by the new standard British Telecom plug and socket. Arrangements for provision of this type of termination can be made through the nearest British Telecom Sales Office.

This apparatus may be connected to the following types of installation.

- a) For connection to the public switched telephone network (PSTN) and compatible PBX (Private Branch Exchange), which use DTMF signalling. (Please consult your supplier for an up to date list of compatible PBX's.)
- b) The apparatus can be used on extension sockets connected to a direct exchange line (D.E.L.).
- c) This apparatus is suitable for connection to the telecommunication system directly or via compatible private branch exchange as an extension. The supplier of the apparatus should be consulted for an up to date list of PBX's with which the apparatus is compatible.

It cannot be guaranteed that the apparatus will operate under all possible conditions of connection to compatible PBX's.

- This apparatus is suitable for connection to a PBX with or without initial proceed indication.
- This apparatus is suitable for connection to a PBX with or without secondary proceed indication.

Any cases of difficulty should be referred in the first instance to the supplier of the apparatus.

- d) The apparatus must not be connected in the following manner:
 - As an extension to a pay phone
 - As a party line with shared service

NOTES:

- If you experience any problems with the normal use of your apparatus, you should unplug it from the telephone outlet and connect a known working telephone in its place. If the known working telephone still gives problems, then please contact the customer service department of your PSTN operator (e.g. BT etc.). If it operates properly, then the problems are likely to be a fault in your apparatus. In this case, consult your supplier for advice.
- Your PSTN operator may charge you if they attend a service call that is not due to apparatus supplied by them.

For your safety

This appliance is supplied with a moulded three pin mains plug for your safety and convenience.

A 13 amp fuse is fitted in this plug. Should the fuse need to be replaced please ensure that the replacement fuse has a rating of 13 amps and that it is approved by ASTA or BSI to BS1362.

Check for ASTA mark  or the BSI

mark  on the body of the fuse.

If the plug contains a removable fuse cover you must ensure that it is refitted when the fuse is replaced.

If you lose the fuse cover the plug must not be used until a replacement cover is obtained.

A replacement fuse cover can be purchased from your local Panasonic dealer.

IF THE FITTED MOULDED PLUG IS UNSUITABLE FOR THE SOCKET OUTLET IN YOUR HOME THEN THE FUSE SHOULD BE REMOVED AND THE PLUG CUT OFF AND DISPOSED OF SAFELY. THERE IS A DANGER OF SEVERE ELECTRICAL SHOCK IF THE CUT OFF PLUG IS INSERTED INTO ANY 13 AMP SOCKET.

If a new plug is to be fitted please observe the wiring code as shown below.

If in any doubt please consult a qualified electrician.

WARNING: THIS APPLIANCE MUST BE EARTHED.

IMPORTANT:

The wires in this mains lead are coloured in accordance with the following code:

| | |
|-------------------|---------|
| Green-and-Yellow: | Earth |
| Blue: | Neutral |
| Brown: | Live |

As the colours of the wire in the mains lead of this appliance may not correspond with the coloured markings identifying the terminals in your plug, proceed as follows.

The wire which is coloured GREEN-AND-YELLOW must be connected to the terminal in the plug which is marked with the letter E or by the Earth symbol  or coloured GREEN or GREEN-AND-YELLOW.

The wire which is coloured BLUE must be connected to the terminal in the plug which is marked with the letter N or coloured BLACK.

The wire which is coloured BROWN must be connected to the terminal in the plug which is marked with letter L or coloured RED.

How to replace the fuse: Open the fuse compartment with a screwdriver and replace the fuse (and fuse cover).

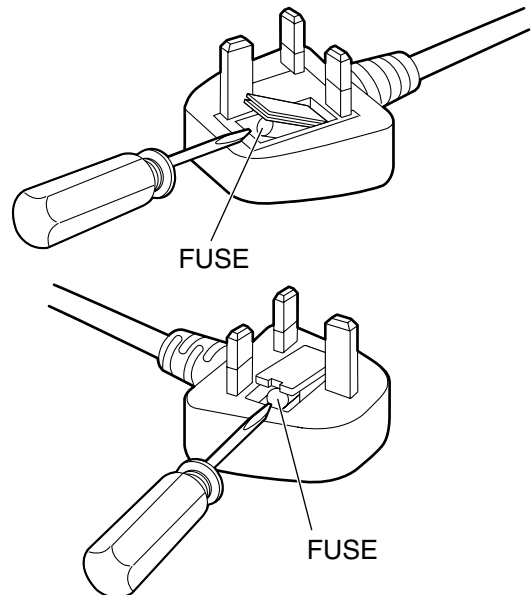

1. Introduction and Installation

Accessories

- 1.1 Included accessories 9
- 1.2 Accessory information 9
- 1.3 Extension telephone adaptor for UK (KX-FP205 only) 9

Finding the Controls

- 1.4 Button descriptions 10
- 1.5 Overview 11

Installation

- 1.6 Ink film 12
- 1.7 Handset cord 13
- 1.8 Paper tray 13
- 1.9 Paper support 14
- 1.10 Recording paper 14

2. Preparation

Connections and Setup

- 2.1 Connections 15

Volume

- 2.2 Adjusting volume 16

Initial Programming

- 2.3 Date and time 16
- 2.4 Your logo 17
- 2.5 Your fax number 18

3. Telephone

Automatic Dialling

- 3.1 Storing names and telephone numbers into the phonebook 19
- 3.2 Making a phone call using the phonebook .. 19
- 3.3 Editing a stored item 19
- 3.4 Erasing a stored item 19
- 3.5 One touch dial 19

Caller ID

- 3.6 Caller ID service 20
- 3.7 Viewing and calling back 21
- 3.8 Editing a telephone number before calling back/storing 21
- 3.9 Erasing caller information 21
- 3.10 Storing caller information into the phonebook 21

4. Fax

Sending Faxes

- 4.1 Sending a fax manually 22
- 4.2 Document requirements 23
- 4.3 Sending a fax using the phonebook and one touch dial 23
- 4.4 Broadcast transmission 24

Receiving Faxes

- 4.5 Selecting the way to use your fax machine . 25
- 4.6 Receiving a fax manually – Auto answer OFF 26
- 4.7 Receiving a fax automatically – Auto answer

- ON 27
- 4.8 Using the unit with an answering machine (KX-FP205 only) 28
- 4.9 Receive polling (retrieving a fax placed on another fax machine) 29
- 4.10 Junk fax prohibitor (preventing fax reception from undesired callers) 29

5. Copy

Copying

- 5.1 Making a copy 31

6. Answering Machine (KX-FP215 only)

Greeting

- 6.1 Recording your greeting message 33

Incoming Messages

- 6.2 Listening to recorded messages 34

Memo Message

- 6.3 Leaving a message for others or yourself 34

Remote Operation

- 6.4 Operating from a remote location 35

7. Programmable Features

Features Summary

- 7.1 Programming 36
- 7.2 Basic features 37
- 7.3 Advanced features 39

8. Help

Error Messages

- 8.1 Error messages – Reports 44
- 8.2 Error messages – Display 45

Troubleshooting

- 8.3 When a function does not work, check here 46

9. Maintenance

Jams

- 9.1 Recording paper jams 52
- 9.2 Document jams 53

Cleaning

- 9.3 Document feeder/recording paper feeder/ scanner glass cleaning 54
- 9.4 Thermal head cleaning 55

10. General Information

Printed Reports

- 10.1 Reference lists and reports 56

Specifications

- 10.2 Specifications 56

Condition of guarantee

- 10.3 Condition of guarantee 58

11.Index

11.1 Index..... 59

1.1 Included accessories

- ① Telephone line cord
(PFJA04B012Y)*¹



- ② Handset
(PFJXN0430Y)*¹



- ③ Handset cord
(PFJA04C003Z)*¹

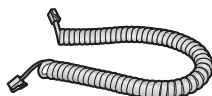

- ④ Paper tray
(PFKS1145Z1)*¹

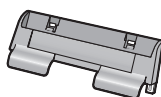

- ⑤ Paper support
(PFUS1704Z)*¹



- ⑥ Starter ink film
(10 metres long)

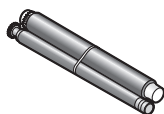

- ⑦ Operating instructions
(PFQX2485Z)*¹



- ⑧ Quick installation guide
(PFQW2473Z)*¹

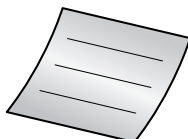

*1 Part numbers are subject to change without notice.

Note:

- If any items are missing or damaged, contact the place of purchase.
- Save the original carton and packing materials for future shipping and transportation of the unit.

1.2 Accessory information

1.2.1 Sales and Support Information

Customer Care Centre

- For customers within the UK: 08701 580560
- For customers within the Republic of Ireland: 01 289 8333
- Visit our website for product information
- E-mail: customer.care@panasonic.co.uk

Direct Sales at Panasonic UK

- Order accessory and consumable items for your product with ease and confidence by phoning our Customer Care Centre Monday - Thursday 9:00am - 5:30pm, Friday 9:30am - 5:30pm (Excluding public holidays).
- Or go on line through our Internet Accessory ordering application at www.panasonic.co.uk.
- Most major credit and debit cards accepted.
- All enquires transactions and distribution facilities are provided directly by Panasonic UK Ltd.
- It couldn't be simpler!
- Also available through our Internet is direct shopping for a wide range of finished products, take a browse on our website for further details.

- **Replacement film*¹ (Model No./Part No. KX-FA52X):** 30 m × 2 rolls (Each roll will print about 90 A4-sized pages.)

*1 To ensure the unit operates properly, we recommend using the Panasonic replacement film. **The ink film is not reusable. Do not rewind and use the ink film again.**

To place an order for KX-FA52X online

Visit our web site :

<http://shop.panasonic.co.uk/icat/acommunications>

1.3 Extension telephone adaptor for UK (KX-FP205 only)

When using the unit with an external answering machine (page 28), please purchase an extension telephone adaptor (e.g., PQJA10058Z) by contacting one of the following:

- www.panasonic.co.uk
- Panasonic Customer Care Centre on Telephone number 08701 580560

1. Introduction and Installation

– local Panasonic authorised dealer

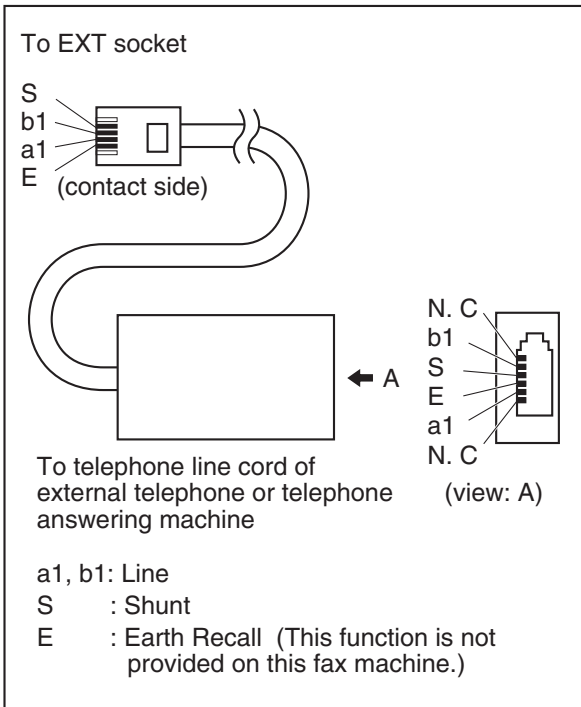

1.4 Button descriptions

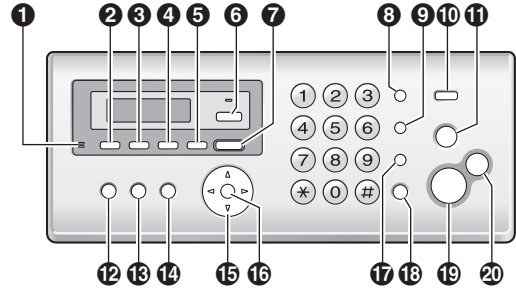

* The pictured model is KX-FP215.

- 1 [MIC] (Microphone) (KX-FP215 only)**
 - The built-in microphone.
- 2 [GREETING REC] (KX-FP215 only)**
 - To record a greeting message (page 33).
- 3 [GREETING CHECK] (KX-FP215 only)**
 - To check a greeting message (page 33).
- 4 [MEMO] (KX-FP215 only)**
 - To record a memo message (page 34).
- 5 [ERASE] (KX-FP215 only)**
 - To erase messages (page 33, 34).
- 6 [AUTO ANSWER]**
 - To turn the auto answer setting ON/OFF (page 26, 27).
- 7 [PLAYBACK] (KX-FP215 only)**
 - To play messages (page 34).
- 8 [REDIAL][PAUSE]**
 - To redial the last number dialled. If the line is busy when you make a call using the **[MONITOR]** (KX-FP205)/**[SP-PHONE]** (KX-FP215) button, the unit will automatically redial the number up to 11 times for phone calls and 5 times for faxes.
 - To insert a pause during dialling.
- 9 [RECALL]**
 - To access special telephone services or for transferring extension calls.
 - The recall time can be changed (feature #72 on page 42).
- 10 [CALLER ID]**
 - To use Caller ID features (page 20).
- 11 [STOP]**
 - To stop an operation or programming session.
 - To erase a character/number (page 17). Press and hold to erase all characters/numbers.
- 12 [BROADCAST]**
 - To send a document to multiple parties (page 24).
- 13 [PRINT REPORT]**
 - To print reference lists and reports (page 56).
- 14 [MENU]**
 - To start or exit programming.

- 15 **[PHONEBOOK][VOLUME]**
 - To adjust volume (page 16).
 - To search for a stored item (page 19, 23).
- 16 **[SET]**
 - To store a setting during programming.
- 17 **[MUTE]**
 - To mute your voice during a conversation. Press again to resume the conversation.
- 18 **[SP-PHONE] (KX-FP215)**
 - For speakerphone operation.
- [MONITOR] (KX-FP205)**
 - To initiate dialling without lifting the handset.
- 19 **[FAX START]**
 - To send or receive a fax.
- 20 **[COPY]**
 - To copy a document (page 31).

1.5 Overview

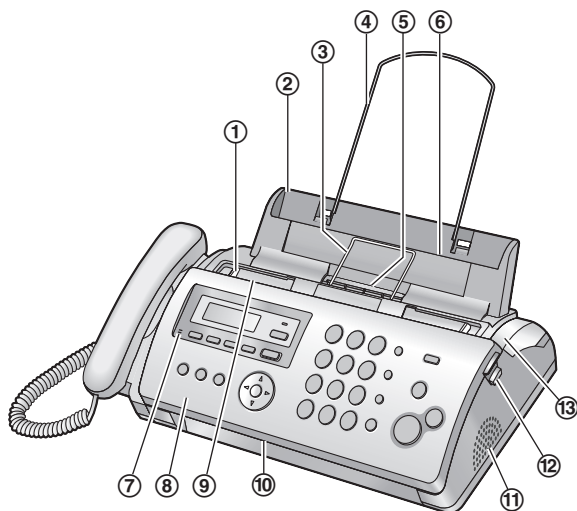

* The pictured model is KX-FP215.

- ① Document guides
- ② Paper tray
- ③ Metal recording paper guide
- ④ Paper support
- ⑤ Recording paper exit
- ⑥ Recording paper entrance
- ⑦ Microphone (KX-FP215 only)
- ⑧ Front cover
- ⑨ Document entrance
- ⑩ Document exit
- ⑪ Speaker
- ⑫ Green button (Back cover release button)
- ⑬ Back cover

Removing the shipping tape

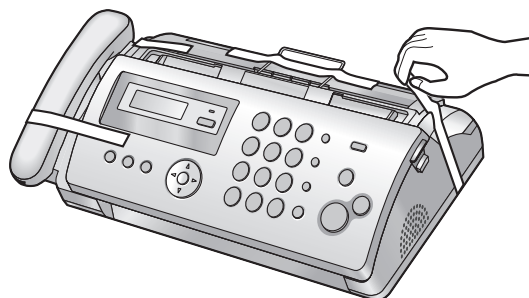

1.6 Ink film

The included film roll is a starter ink film.

- 1 Open the front cover.

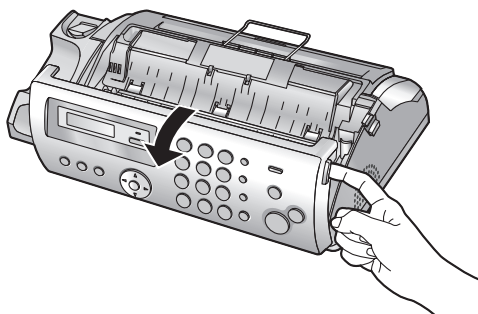

- 2 Release the back cover by pushing the green button (1).

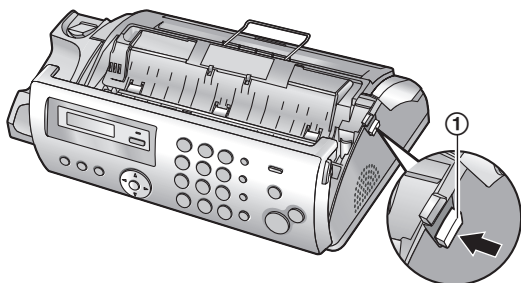

- 3 Open the back cover.

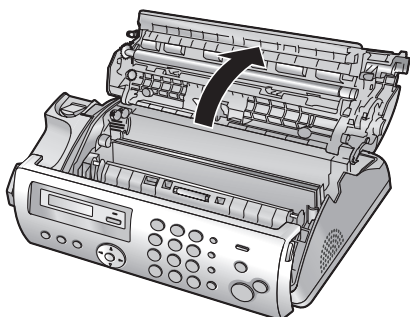

- 4 Insert the blue gear of the ink film roll into the front left slot of the unit (2) and the white gear of the ink film roll into the rear left slot of the unit (3).
 - The ink film is safe to touch and will not rub off on your hands like carbon paper.

- Make sure the blue gear (2) and white gear (3) are installed as shown.

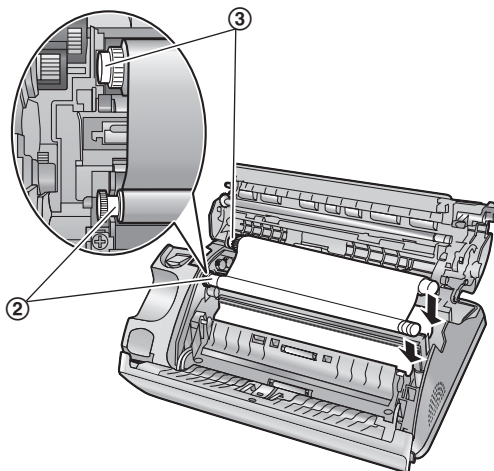

- 5 Turn the blue gear (4) in the direction of the arrow until the ink film is tight (5) and at least one layer of ink film is wrapped around the blue core (6).

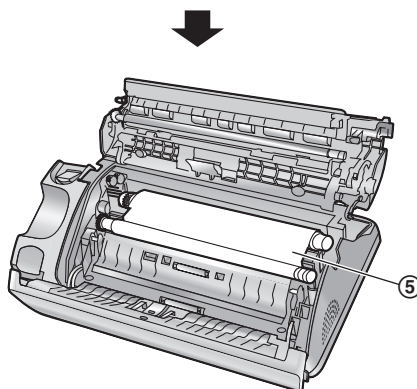
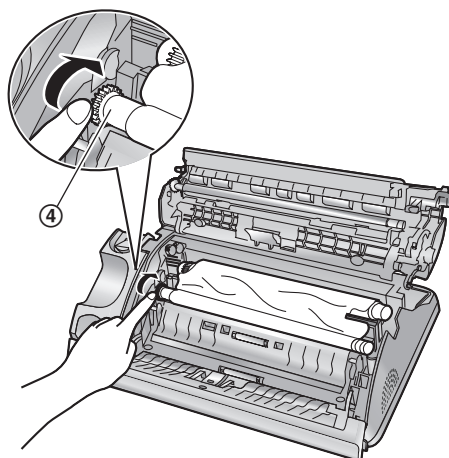

Correct

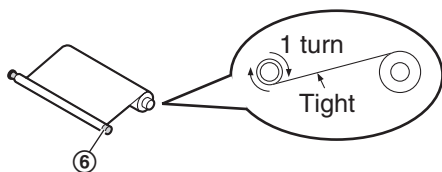

Incorrect

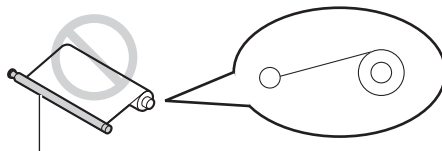

No ink film is wrapped around the blue core.



6 Close the back cover securely by pushing down on the dotted area at both ends (7).

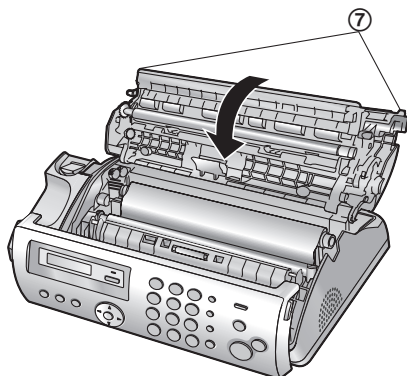

7 Close the front cover securely.

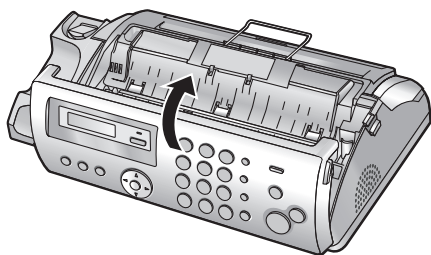

1.7 Handset cord

Connect the handset cord (1).

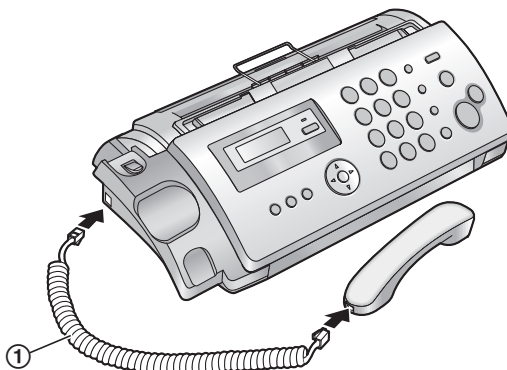

1.8 Paper tray

Pull up the metal recording paper guide (1), then install the paper tray (2).

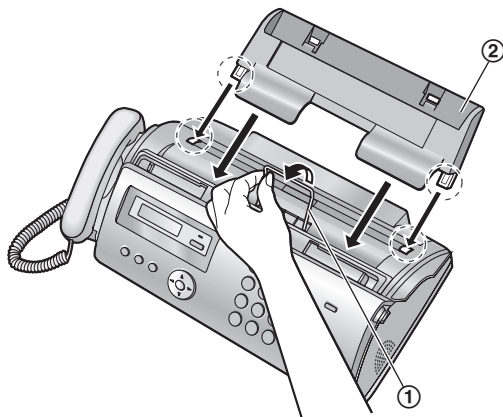

• Make sure the arrows on the paper tray and the unit match.

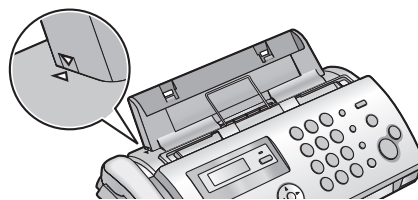

1.9 Paper support

Hold open the paper support (①), then insert the ends into the holes on the paper tray (②).

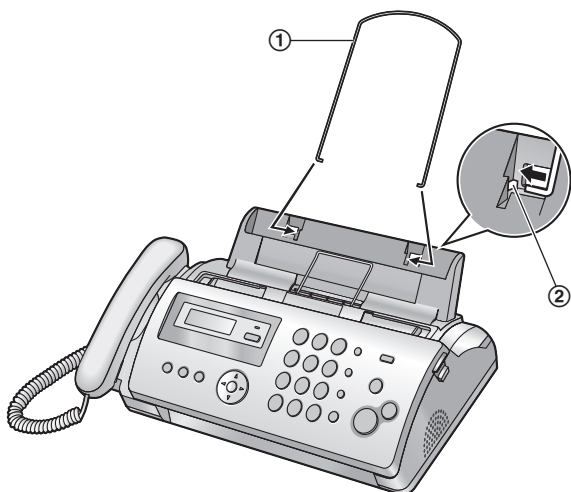

1.10 Recording paper

The unit can hold up to 20 sheets of 60 g/m² to 90 g/m² paper.

Please refer to page 57 for more information on recording paper.

- 1 Fan the paper to prevent paper jams.

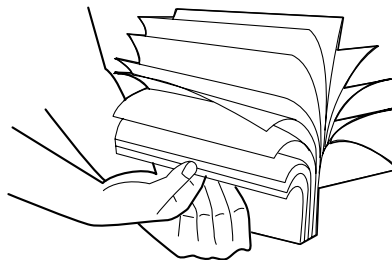

- 2 Insert the paper gently, print-side down (①).
 - Do not force the paper into the paper tray.



- If the paper is not inserted correctly, remove all of the installed paper, and re-install it gently. Otherwise the paper may jam.

Correct

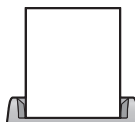

Slant



Note:

- Remove all of the installed paper before adding paper.

2.1 Connections

Caution:

- The mains lead must remain connected at all times.
 - Never install telephone wiring during a lightning storm.
 - When you operate this product, the power outlet should be near the product and easily accessible.
 - Be sure to use the telephone line cord included in this unit.
 - Do not extend the telephone line cord.
- ① Telephone line cord
 - Connect to telephone network.
 - ② Mains lead
 - Connect to Household Mains Supply (220 – 240 V, 50 Hz).
 - ③ [EXT] socket (KX-FP205 only)
 - You can connect an answering machine or a telephone. Remove the stopper if attached.
 - ④ Answering machine (not included)

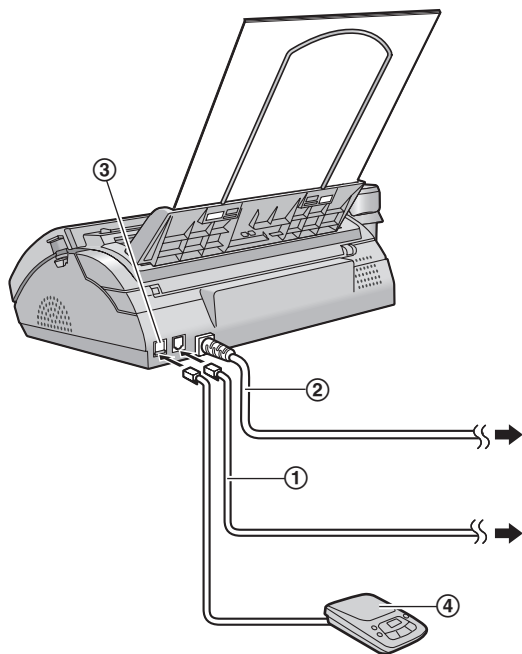

Note:

- To avoid malfunction, do not position the fax machine near appliances such as TVs or speakers which generate an intense magnetic field.
- If any other device is connected to the same telephone line, this unit may disturb the network condition of the device.

- If you use the unit with a computer and your internet provider instructs you to install a filter (5), please connect it as follows.

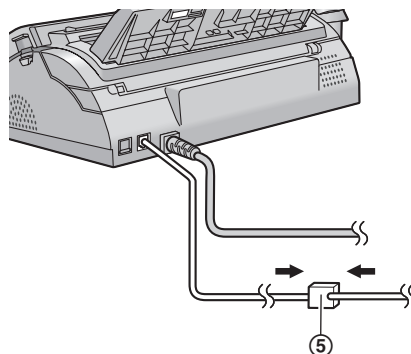

2.2 Adjusting volume

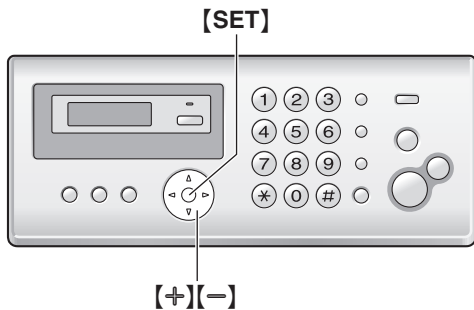

Ringer volume

While the unit is idle, press **[+]** or **[−]**.

- If there are any documents in the document entrance, you cannot adjust the volume. Confirm that there are no documents in the entrance.

To turn the ringer OFF

Press **[−]** repeatedly to display “**RINGER OFF= OK?**”.
→ **[SET]**

- The unit will not ring.
- To turn the ringer back ON, press **[+]**.

Ringer tone

- You can select the ringer tone from one of 3 patterns (feature #17 on page 38).

Handset receiver volume

While using the handset, press **[+]** or **[−]**.

Speaker volume

While using the monitor/speakerphone, press **[+]** or **[−]**.

2.3 Date and time

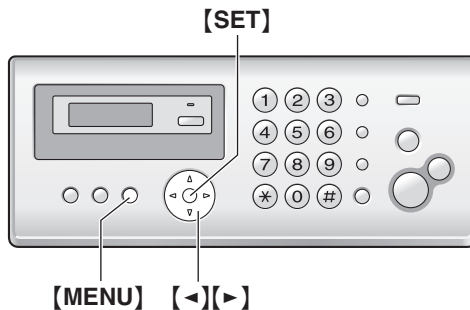

1 **[MENU]** → **[#][0][1]** → **[SET]**

| |
|----------------|
| D:01/M:01/Y:06 |
| TIME: 00:00 |

2 Enter the current date/month/year/hour/minute by selecting 2 digits for each. Press **[*]** repeatedly to select “AM”, “PM”, or 24 hour clock format.

Example: 10 August, 2006 10:15 PM (12 hour clock format)

1. Press **[1][0] [0][8] [0][6] [1][0] [1][5]**.

| |
|----------------|
| D:10/M:08/Y:06 |
| TIME: 10:15 |

2. Press **[*]** repeatedly to select “PM”.

3 **[SET]**

4 Press **[MENU]** to exit.

Note:

- The other party's fax machine will print the date and time on the top of each page you send according to your unit's date and time setting.

To correct a mistake

Press **[←]** or **[→]** to move the cursor to the incorrect number, and make the correction.

2.4 Your logo

You can program your logo (name, company name, etc.) so that it appears on the top of each page sent.

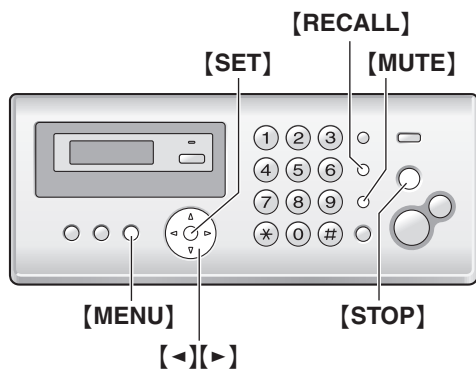

1 [MENU] → [#][0][2] → [SET]

LOGO=■

2 Enter your logo, up to 30 characters. See the following character table for details. → [SET]

3 Press [MENU] to exit.

To select characters with the dial keypad

| Keypad | Characters |
|--------|--------------------------------|
| [1] | Space # & ' () * , - . / 1 |
| [2] | A B C 2 |
| | a b c 2 |
| [3] | D E F 3 |
| | d e f 3 |
| [4] | G H I 4 |
| | g h i 4 |
| [5] | J K L 5 |
| | j k l 5 |
| [6] | M N O 6 |
| | m n o 6 |
| [7] | P Q R S 7 |
| | p q r s 7 |
| [8] | T U V 8 |
| | t u v 8 |
| [9] | W X Y Z 9 |
| | w x y z 9 |

| Keypad | Characters |
|----------|---|
| [0] | Space 0 |
| [*] | To switch between uppercase or lowercase letters. |
| [RECALL] | Hyphen. |
| [MUTE] | To insert a space. |
| [STOP] | To delete a character. |

Note:

- To enter a character that is located on the same dial key as the previously entered character, you must first press [▶] to move the cursor to the next space.

To enter your logo

Example: "BILL"

1. Press [2] 2 times.

LOGO=B

2. Press [4] 3 times.

LOGO=BI

3. Press [5] 3 times.

LOGO=BIL

4. Press [▶] to move the cursor to the next space and press [5] 3 times.

LOGO=BILL

To switch between uppercase or lowercase letters

Pressing the [*] button will change the letter input to uppercase or lowercase alternately.

1. Press [2] 2 times.

LOGO=B

2. Press [4] 3 times.

LOGO=BI

3. Press [*].

LOGO=Bi

4. Press [5] 3 times.

LOGO=BiL

To correct a mistake

Press [->] or [<-] to move the cursor to the incorrect character, and make the correction.

- To erase all of the characters, press and hold [STOP].

2.5 Your fax number

You can program your fax number so that it appears on the top of each page sent.

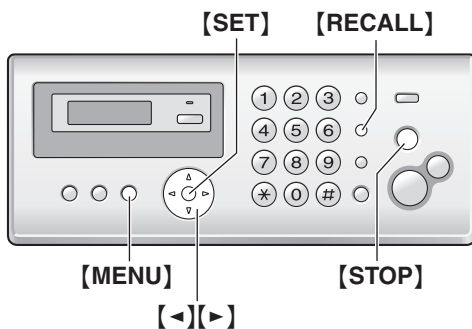

1 [MENU] → [#][0][3] → [SET]

NO. = ■

2 Enter your fax number, up to 20 digits.

- To enter a "+", press [*].
- To enter a space, press [#].
- To enter a hyphen, press [RECALL].
- To erase a number, press [STOP].

3 [SET]

4 Press [MENU] to exit.

To correct a mistake

Press [◀] or [▶] to move the cursor to the incorrect number, and make the correction.

- To erase all of the numbers, press and hold [STOP].

3.1 Storing names and telephone numbers into the phonebook

The unit provides a phonebook (50 items).

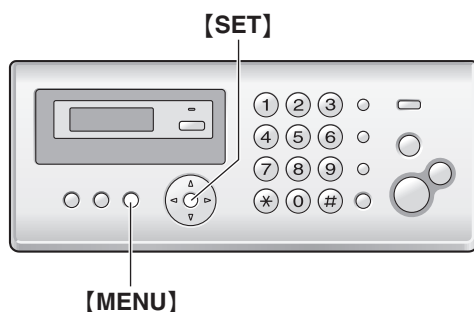

- 1 Press **[MENU]** repeatedly to display “PHONEBOOK SET”. → **[*]**
- 2 Enter the name, up to 16 characters (see page 17 for instructions). → **[SET]**
- 3 Enter the telephone number, up to 32 digits. → **[SET]**
 - To program other items, repeat steps 2 to 3.
- 4 **[MENU]**

3.2 Making a phone call using the phonebook

- 1 **[PHONEBOOK]**
- 2 Press **[+]** or **[-]** repeatedly to display the desired item.
- 3 Press **[MONITOR]** (KX-FP205)/**[SP-PHONE]** (KX-FP215) or lift the handset.

To search for a name by initial

Example: “LISA”

1. **[PHONEBOOK]**
2. Press **[+]** or **[-]** to initiate the phonebook.
3. Press **[5]** repeatedly to display any name with the initial “L” (see the character table, page 17).
 - To search for symbols, press **[1]**.
4. Press **[-]** repeatedly to display “LISA”.
 - To stop the search, press **[STOP]**.
 - To dial the displayed number, press **[MONITOR]** (KX-FP205)/**[SP-PHONE]** (KX-FP215) or lift the handset.

3.3 Editing a stored item

- 1 **[PHONEBOOK]**
- 2 Press **[+]** or **[-]** repeatedly to display the desired item. → **[MENU]**

- 3 **[*]**
 - If you do not need to edit the name, skip to step 5.
- 4 Edit the name. For further details, see the storing procedure on page 19.
- 5 **[SET]**
 - If you do not need to edit the telephone number, skip to step 7.
- 6 Edit the telephone number. For further details, see the storing procedure on page 19.
- 7 **[SET]**

3.4 Erasing a stored item

3.4.1 Erasing a specific item

1. **[PHONEBOOK]**
2. Press **[+]** or **[-]** repeatedly to display the desired item. → **[MENU]** → **[†]**
 - To cancel erasing, press **[STOP]**.
3. **[SET]**

3.4.2 Erasing all items

1. **[PHONEBOOK]** → **[MENU]**
2. Press **[+]** or **[-]** repeatedly to select “YES”. → **[SET]**
 - To cancel erasing, press **[STOP]**.
3. **[SET]**

3.5 One touch dial

Dial keys **[1]** to **[9]** can each be used as a one touch dial key, allowing you to dial a number from the phonebook by simply pressing a dial key.

3.5.1 Assigning an item to a one touch dial key

- 1 **[PHONEBOOK]**
- 2 Press **[+]** or **[-]** repeatedly to display the desired item. → **[MENU]** → **[0]**
- 3 Press **[+]** or **[-]** repeatedly to select a desired dial key.
 - When the dial key is already used as a one touch dial key, ✓ is displayed next to the dial key number. If you select this dial key, you can overwrite the previous assignment.
- 4 **[SET]** → **[SET]**
 - To program other items, repeat steps 2 to 4.
- 5 **[STOP]**

3.5.2 Making a call using a one touch dial key

- 1 Press and hold the desired one touch dial key ([1] to [9]).
 - You can view other one touch dial assignments by pressing [+] or [-].
- 2 Press [MONITOR] (KX-FP205)/[SP-PHONE] (KX-FP215) or lift the handset.

3.5.3 Erasing a one touch dial assignment

- 1 Press and hold the desired one touch dial key ([1] to [9]). → [MENU]
 - To cancel erasing, press [STOP].
- 2 [SET]

Note:

- The number erased from a one touch dial key will not be deleted from the phonebook. To erase from the phonebook, see page 19.

3.6 Caller ID service

This unit is compatible with the Caller ID service offered by your local telephone company. To use this unit's Caller ID features, you must subscribe to a Caller ID service.

Important:

- This unit is designed in accordance with the ETS (European Telecommunication Standard) and only supports the basic CLIP (Calling Line Identification Presentation) features.
- This unit will only display the caller's telephone number and name.
- This unit will not support future additional telephone services.
- Depending on the service of the local telephone company, the date/time of the call or the caller's name may not be displayed.

Make sure the following ring count is set to 2 or more rings beforehand.

- For KX-FP205: FAX ring count (feature #06 on page 37) and TEL/FAX ring count (feature #78 on page 42)
- For KX-FP215: TAM ring count (feature #06 on page 37), FAX ring count (feature #06 on page 37) and TEL/FAX ring count (feature #78 on page 42)

3.6.1 How Caller ID is displayed

The calling party's name or telephone number will be displayed after the 1st ring. You have the option of whether or not to answer the call.

The unit will automatically store caller information (name, telephone number, date and time of the call, the number of times called) from the 30 most recent callers. It is possible to view caller information one at a time on the display (page 21) or print the entire Caller ID list (page 56).

- When caller information is received and it matches a telephone number stored in the unit's phonebook, the stored name will be displayed.
- If the unit is connected to a PBX (Private Branch Exchange) system, caller information may not be received properly. Consult your PBX supplier.
- If the unit cannot receive caller information, the following will be displayed:
 - “OUT OF AREA”: The caller dialed from an area which does not provide Caller ID service.
 - “PRIVATE CALLER”: The caller requested not to send caller information.
 - “LONG DISTANCE”: The caller made a long distance call.

To confirm caller information using the Caller ID list

- To print manually, see page 56.
- To print automatically after every 30 new calls, activate feature #26 (page 39).

3.7 Viewing and calling back

The display will show the number of new calls in standby mode.

Example:

| |
|-------------------|
| 10 CALLS 10:59 |
|-------------------|

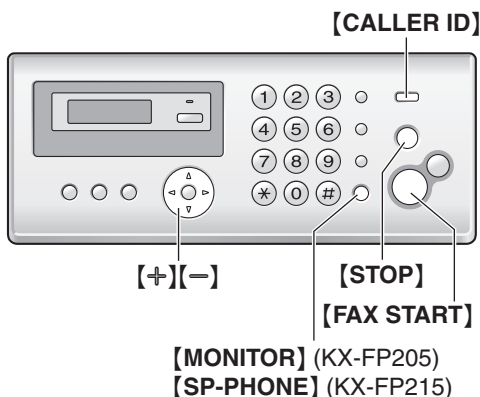

- 1 **[CALLER ID]**
- 2 Press **[−]** to search from the recently received caller information.
 - If you press **[+]**, the display order will be reversed.
- 3 Press **[MONITOR]** (KX-FP205)/**[SP-PHONE]** (KX-FP215) or lift the handset to return the call.
 - To send a fax, insert the document FACE DOWN and press **[FAX START]**.

To change the way caller information is displayed

Press **[CALLER ID]** repeatedly after step 2.

Example:

| |
|----------------------------|
| SAM LEE 11:20 20 Jul. ✓ |
|----------------------------|

 ↓

| |
|-------------------------------|
| 1345678901 11:20 20 Jul. ✓ |
|-------------------------------|

3.7.1 Symbols and operations for caller information

What “✓” means

“✓” on the display means the call has already been viewed or answered.

If the same person calls more than once

The number of times the same caller called (“×2” to “×9”) will be displayed. Only the date and time of the most recent call will be stored.

Example: The same person called 3 times.

| |
|-----------------------------|
| SAM LEE 10:30 20 Jul. ×3 |
|-----------------------------|

To stop viewing

Press **[STOP]**.

3.8 Editing a telephone number before calling back/storing

- 1 **[CALLER ID]**
- 2 Press **[+]** or **[−]** repeatedly to display the desired item.
- 3 Press **[CALLER ID]** to display the telephone number.
- 4 Press dial key (0 to 9) or **[*]** to enter the editing mode and edit the telephone number.
- 5 Press **[MONITOR]** (KX-FP205)/**[SP-PHONE]** (KX-FP215) or lift the handset to call back the edited number.
 - The unit will start dialling automatically.
 - To send a fax, insert the document FACE DOWN and press **[FAX START]**.
 - To store the number in the phonebook, follow from step 3 of the storing procedure below.

3.9 Erasing caller information

3.9.1 Erasing all caller information

- 1 Press **[MENU]** repeatedly to display “CALLER SETUP”. → **[SET]**
 - “CALL LIST ERASE” will be displayed.
- 2 **[SET]**
 - To cancel erasing, press **[STOP]**, then **[MENU]**.
- 3 **[SET]** → **[STOP]**

3.9.2 Erasing specific caller information

- 1 **[CALLER ID]**
- 2 Press **[+]** or **[−]** repeatedly to display the desired item. → **[←]** → **[SET]** → **[STOP]**

3.10 Storing caller information into the phonebook

- 1 **[CALLER ID]**
- 2 Press **[+]** or **[−]** repeatedly to display the desired item.
 - If the number requires editing, see page 21.
- 3 **[MENU]** → **[SET]** → **[SET]**

4.1 Sending a fax manually

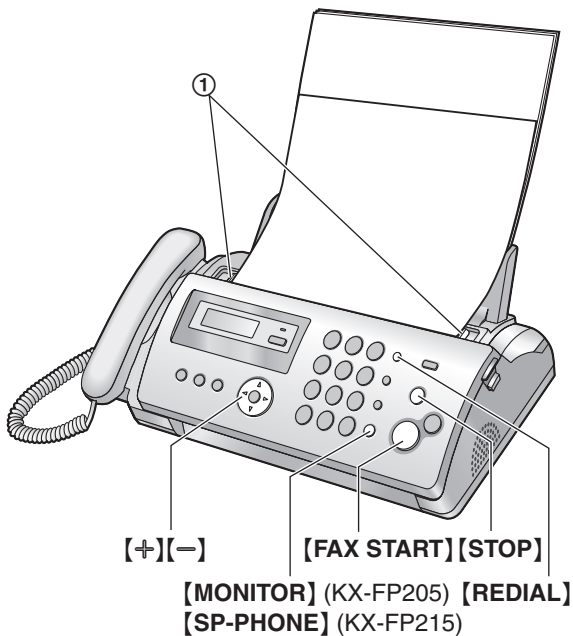

- 1 Adjust the width of the document guides (①) to fit the actual size of the document.
- 2 Insert the document (up to 10 pages) FACE DOWN until a single beep is heard and the unit grasps the document.
- 3 If necessary, press **[+]** or **[-]** repeatedly to select the desired resolution.
- 4 Press **[MONITOR]** (KX-FP205)/**[SP-PHONE]** (KX-FP215) or lift the handset.
- 5 Dial the fax number.
- 6 **When a fax tone is heard:**
Press **[FAX START]**.

When the other party answers your call:

Ask them to press their start button. When the fax tone is heard, press **[FAX START]**.

- If you pressed **[MONITOR]** (KX-FP205)/**[SP-PHONE]** (KX-FP215) in step 4, lift the handset before speaking.

To select the resolution

Select the desired resolution according to the character size.

- "STANDARD": For normal-sized characters.
- "FINE": For small-sized characters.
- "SUPER FINE": For very small-sized characters.
- "PHOTO": For photographs, shaded drawings, etc.
- Using the "FINE", "SUPER FINE" and "PHOTO" settings will increase transmission time.

To redial the last number

[REDIAL] → **[FAX START]**

- If the line is busy, the unit will automatically redial the number up to 5 times.
- To cancel redialling, press **[STOP]**.

To send more than 10 pages at a time

Insert the first 10 pages of the document. Add the other pages (up to 10 at a time) on top of the previously inserted pages while the last page is being fed into the unit.

Pre-dialling a fax number

1. Enter the fax number.
2. Insert the document.
3. **[FAX START]**

Sending from memory (Quick scan feature)

To use this feature, activate feature #34 (page 40) beforehand.

1. Insert the document.
2. Enter the fax number. → **[FAX START]**
 - If the document exceeds the memory capacity, transmission will be cancelled and this feature will be turned OFF automatically. You must send the entire document manually.
 - This feature cannot be used if the handset is in use or **[MONITOR]** (KX-FP205)/**[SP-PHONE]** (KX-FP215) is pressed.

To stop sending

Press **[STOP]**.

Printing a sending report

A sending report provides you with a printed record of transmission results (errors, etc.). To print sending reports, make sure feature #04 is activated (page 37). The default setting is "ERROR". For an explanation of error messages, see page 44.

Printing a journal report

A journal report provides you with a printed record of the 30 most recent fax transmissions and receptions. To print it manually, see page 56. To print it automatically after every 30 new fax transmissions and receptions, make sure feature #22 is activated (page 39). For an explanation of error messages, see page 44.

4.2 Document requirements

Minimum document size

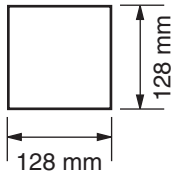

Maximum document size

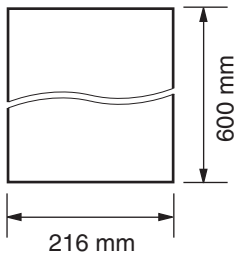

Effective scanning area

- Shaded area will be scanned.

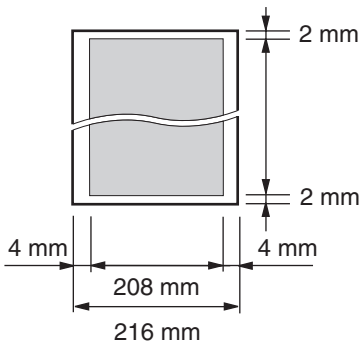

Document weight

- Single sheet:
45 g/m² to 90 g/m²
- Multiple sheets:
60 g/m² to 80 g/m²

Note:

- Remove clips, staples or other fasteners.
- Do not send the following types of documents: (Make a copy of the document using another copier and send the copy.)
 - Chemically treated paper such as carbon or carbonless duplicating paper
 - Electrostatically charged paper
 - Badly curled, creased or torn paper
 - Paper with a coated surface
 - Paper with a faint image
 - Paper with printing on the opposite side that can be seen through the other side, such as newsprint
- Check that ink, paste or correction fluid has dried completely.

- To send a document with a width of less than 210 mm, we recommend using a copy machine to copy the original document onto A4 or letter-sized paper, then sending the copied document.

4.3 Sending a fax using the phonebook and one touch dial

Before using this feature, store the desired names and telephone numbers into the phonebook (page 19) and one touch dial (page 19).

- 1 Adjust the width of the document guides to fit the actual size of the document.
- 2 Insert the document (up to 10 pages) FACE DOWN until a single beep is heard and the unit grasps the document.
- 3 If necessary, press **[+]** or **[-]** repeatedly to select the desired resolution (page 22).

4 Using the phonebook:

1. **[PHONEBOOK]**
2. Press **[+]** or **[-]** repeatedly to display the desired item. → **[FAX START]**

Using one touch dial:

1. Press and hold the desired one touch dial key (**[1]** to **[9]**).
 - You can view other one touch dial assignments by pressing **[+]** or **[-]**.
2. **[FAX START]**

Fax auto redial

If the line is busy or if there is no answer, the unit will automatically redial the number up to 5 times.

- To cancel redialling, press **[STOP]**.

4.4 Broadcast transmission

By storing the phonebook items (page 19) into the broadcast memory, you can send the same document to multiple parties (up to 20). Your programmed items will remain in the broadcast memory, allowing frequent re-use.

4.4.1 Programming items into the broadcast memory

- 1 Press **[MENU]** repeatedly to display “**BROADCAST SET**”. → **[#]**
- 2 Press **[+]** or **[-]** repeatedly to display the desired item. → **[SET]**
 - The number in brackets indicates the number of registered items.
 - If you have programmed the wrong item, press **[STOP]** to erase the item.
 - To program other items, repeat step 2 (up to 20 items).
- 3 **[SET]**

4.4.2 Adding a new item into the broadcast memory

- 1 **[PHONEBOOK]**
- 2 Press **[+]** or **[-]** repeatedly to display “**<BROADCAST>**”. → **[MENU]** → **[*]**
- 3 Press **[+]** or **[-]** repeatedly to display the desired item. → **[SET]**
 - To add other items, repeat step 3 (up to 20 items).
- 4 **[STOP]**

4.4.3 Erasing a stored item from the broadcast memory

- 1 **[PHONEBOOK]**
- 2 Press **[+]** or **[-]** repeatedly to display “**<BROADCAST>**”. → **[MENU]** → **[#]**
- 3 Press **[+]** or **[-]** repeatedly to display the desired item you want to erase.
 - To cancel erasing, press **[STOP]**.
- 4 **[SET]** → **[SET]** → **[STOP]**

4.4.4 Sending the same document to pre-programmed parties

- 1 Insert the document **FACE DOWN**.
- 2 If necessary, press **[+]** or **[-]** repeatedly to select the desired resolution (page 22).
- 3 **[BROADCAST]**
 - After transmission, the unit will automatically print a report (**Broadcast sending report**).

Note:

- If you select “**FINE**”, “**SUPER FINE**” or “**PHOTO**” resolution, the number of pages that the unit can send will decrease.
- If the document exceeds the memory capacity, transmission will be cancelled.
- If a party is busy or does not answer, it will be skipped and redialled later up to 5 times.

To send the same document to a one-time group of items

1. Insert the document. → **[PHONEBOOK]**
2. Press **[+]** or **[-]** repeatedly to display “**<ONE TIME BROAD>**”. → **[SET]**
3. Press **[+]** or **[-]** repeatedly to display the desired party. → **[SET]**
 - If you have programmed the wrong item, press **[STOP]** to erase the item.
 - To program other parties, repeat step 3 (up to 20 items).
4. Press **[FAX START]** to start transmission to the programmed parties.

To cancel broadcast transmission

Press **[STOP]** repeatedly to display “**SEND CANCELLED?**”. → **[SET]**

4.5 Selecting the way to use your fax machine

Depending on your situation, select the way you prefer to use your fax machine.

- Use as a telephone answering machine and/or fax (TAM/FAX mode) (KX-FP215 only)
- Use only as a fax (FAX ONLY mode)
- Use mostly as a telephone (TEL mode)
- Use as a telephone and/or fax (TEL/FAX mode)
- Use with answering machine (KX-FP205 only)

4.5.1 Use as a telephone answering machine and/or fax (TAM/FAX mode) (KX-FP215 only)

Your situation

You want to answer phone calls using the telephone answering machine and receive faxes automatically.

Setup

Set the fax machine to TAM/FAX mode (page 28) by pressing **[AUTO ANSWER]** repeatedly.

- The **[AUTO ANSWER]** indicator turns ON.

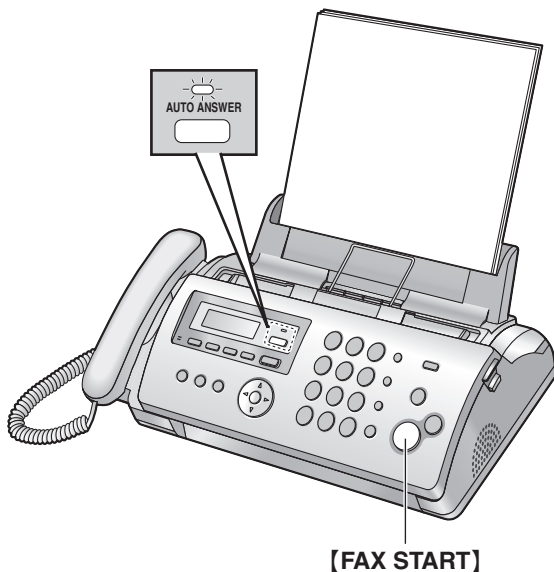

Note:

- Make sure feature #77 is set to “**TAM/FAX**” (page 42) beforehand.
- Do not connect an answering machine to the same telephone line. If connected, set the automatic answer feature to OFF by pressing **[AUTO ANSWER]** repeatedly.

How phone calls and faxes are received

If the call is a phone call, the fax machine will record the caller's message automatically.

If a fax calling tone is detected, the fax machine will receive the fax automatically.

4.5.2 Use only as a fax (FAX ONLY mode)

Your situation

You have a separate telephone line just for faxes.

Setup

Set the fax machine to FAX ONLY mode (page 27) by pressing **[AUTO ANSWER]** repeatedly.

- The **[AUTO ANSWER]** indicator turns ON.



Note:

- Make sure feature #77 is set to “**FAX ONLY**” (page 42) beforehand (KX-FP215 only).

How faxes are received

All incoming calls will be answered as faxes.

4.5.3 Use mostly as a telephone (TEL mode)

Your situation

You want to answer calls by yourself. If a fax call is received, you must receive the fax manually.

Setup

Set the fax machine to TEL mode (page 26) by pressing **[AUTO ANSWER]** repeatedly.

- The **[AUTO ANSWER]** indicator turns OFF.



Note:

- Make sure feature #73 is set to “**TEL**” (page 42) beforehand.

How to receive phone calls and faxes

You have to answer all calls manually.

To receive a fax, press **[FAX START]**.

4.5.4 Use as a telephone and/or fax (TEL/FAX mode)

Your situation

You want to answer phone calls yourself and receive faxes automatically without rings.

Setup

Set the fax machine to TEL/FAX mode (page 27) by pressing **[AUTO ANSWER]** repeatedly.

- The **[AUTO ANSWER]** indicator turns OFF.

Note:

- Make sure feature #73 is set to “**TEL/FAX**” (page 42) beforehand.

How phone calls and faxes are received

If the call is a phone call, the fax machine will ring.

If a fax calling tone is detected, the fax machine will receive the fax automatically without ringing.

4.5.5 Use with answering machine (KX-FP205 only)

Your situation

You want to use the fax machine with an answering machine.

Setup

Connect an external telephone answering machine (page 28) and set the ring count of the answering machine to less than 4.

- Set the ring count in FAX ONLY mode of the fax machine to more than 4, if you use with auto answer ON.

How to receive calls

If the call is a phone call, the answering machine will record voice messages.

If a fax calling tone is detected, the fax machine will receive a fax automatically.

4.6 Receiving a fax manually – Auto answer OFF

Note:

- By default, the unit reduces the size of the received document to 92 % when printing (See feature #36 on page 40 for details).

4.6.1 Activating TEL mode

- 1 Make sure feature #73 is set to “TEL” (page 42) beforehand.
- 2 Press **[AUTO ANSWER]** repeatedly to display “TEL MODE”.
 - The **[AUTO ANSWER]** indicator turns OFF.



Note:

- If you do not answer the call within 10 rings, the unit will temporarily answer the call. Then you need to enter the remote operation ID to turn the auto answer setting ON. See page 35 for details (KX-FP215 only).

How to receive phone calls and faxes

1. Lift the handset to answer the call.
2. When:
 - document reception is required,
 - a fax calling tone (slow beep) is heard, or
 - no sound is heard,press **[FAX START]**.
3. Replace the handset.

To stop receiving

Press **[STOP]**.

How to receive faxes with an extension telephone

1. When the extension telephone rings, lift the handset of the extension telephone.
2. When:
 - document reception is required,
 - a fax calling tone (slow beep) is heard, or
 - no sound is heard,
 press **[*][#][9]** (default fax activation code) **firmly**.
3. Replace the handset.

Note:

- To receive fax documents using the extension telephone, make sure remote fax activation is turned ON (feature #41 on page 40) beforehand. The default setting is ON.

4.6.2 Activating TEL/FAX mode

1. Make sure feature #73 is set to “**TEL/FAX**” (page 42) beforehand.
2. Press **[AUTO ANSWER]** repeatedly to display “**TEL/FAX MODE**”.
 - The **[AUTO ANSWER]** indicator turns OFF.
3. The ringer volume setting should be ON (page 16).

How phone calls and faxes are received

1. “**INCOMING CALL**” will be displayed but the unit will not ring.
2. The unit will wait for the duration of **2 rings** before answering the call.
 - The number of rings is determined by the “**TEL/FAX delayed ring setting**” (feature #78 on page 42).
 - During this time, an extension telephone will ring.
3. The unit will answer the call and try to detect a fax calling tone.

When a fax calling tone is detected

The unit receives the fax automatically without ringing.

When a fax calling tone is not detected

1. The unit will ring. You may answer the call.
 - Callers will hear a ring back tone different from the one generated by the telephone company.
 - An extension telephone will not ring at this time. To answer the call with the extension telephone, lift the handset and press **[*][0]** (default auto disconnection code) while the fax machine is ringing.
2. If you do not answer the call, the unit will activate the fax function.
 - Some fax machines do not generate fax calling tones when sending faxes, therefore the unit will try to receive a fax even if no fax calling tone is detected.

Note:

- The auto disconnection code can be changed in feature #49 on page 41.
- If you have an extension telephone (a telephone connected to the **[EXT]** socket of this unit), TEL/FAX mode cannot be used (KX-FP205 only).

4.7 Receiving a fax automatically – Auto answer ON

Note:

- By default, the unit reduces the size of the received document to 92% when printing (See feature #36 on page 40 for details).

4.7.1 Activating FAX ONLY mode

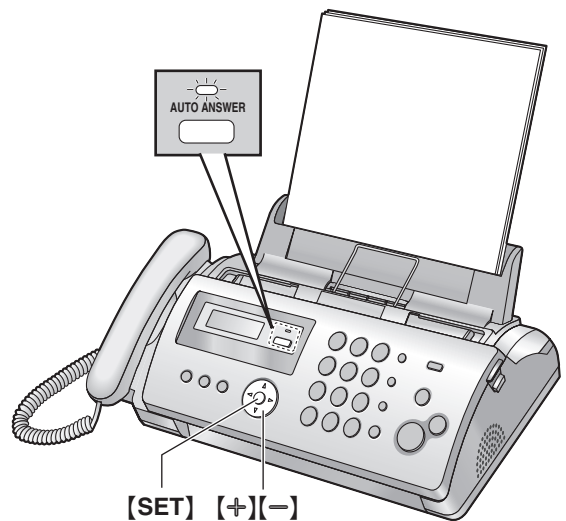

For KX-FP205:

Press **[AUTO ANSWER]** repeatedly to display “**FAX ONLY MODE**”.

- The **[AUTO ANSWER]** indicator turns ON.

For KX-FP215:

1. Make sure feature #77 is set to “**FAX ONLY**” (page 42) beforehand.

2. Press **[AUTO ANSWER]** repeatedly to display “**FAX ONLY MODE**”.

- The **[AUTO ANSWER]** indicator turns ON.

How faxes are received

When receiving calls, the unit will automatically answer all calls and only receive fax documents.

Note:

- If you set the ring setting to more than “5”, receiving faxes may not be possible (feature #06 on page 37).

4.7.2 Activating TAM/FAX mode (Telephone Answering Machine/Fax mode) (KX-FP215 only)

- 1 Make sure feature #77 is set to “**TAM/FAX**” (page 42) beforehand.
- 2 Press [**AUTO ANSWER**] repeatedly to display “**TAM/FAX MODE**”.
 - You can adjust the speaker volume by pressing [**+**] or [**-**] while listening to the greeting message.
 - The [**AUTO ANSWER**] indicator turns ON.

Note:

- The maximum incoming message recording time can be changed (feature #10 on page 37).

How phone calls and faxes are received

When receiving calls, the unit works as an answering machine and/or fax.

Receiving a voice message and fax document in one call

The caller can leave a voice message and send a fax document during the same call. Inform the caller of the following procedure beforehand.

1. The caller calls your unit.
 - The answering machine will answer the call.
2. The caller can leave a message after the greeting message.
3. The caller presses [*****][**9**].
 - The unit will activate the fax function.
4. The caller presses the start button to send a fax.

Changing the ring count in TAM/FAX mode

You can select from “2” (default), “3”, “4”, “5”, “6”, “7” or “**TOLL SAVER**”. This setting can be changed by feature #06 on page 37.

- “**TOLL SAVER**”: The unit answers after 2 rings when new messages have been recorded, and after 4 rings when there are no new messages. If you call your unit from a remote location to listen to new messages (page 35), you will know that there are no messages when the unit rings for the 3rd time. You can then hang up without being charged for the call.

Note:

- If you set to more than “3”, receiving faxes may not be possible.

Answering calls with an extension telephone

When answering a call after the greeting message has started or while the call is being recorded, press [*****][**0**] (default auto disconnection code) to stop the greeting message or recording and talk to the caller.

- The code can be changed in feature #49 on page 41.

4.8 Using the unit with an answering machine (KX-FP205 only)

4.8.1 Setting up the unit and an answering machine

- 1 Connect the answering machine (①).
 - Answering machine is not included.
 - Remove the stopper (②) if attached.

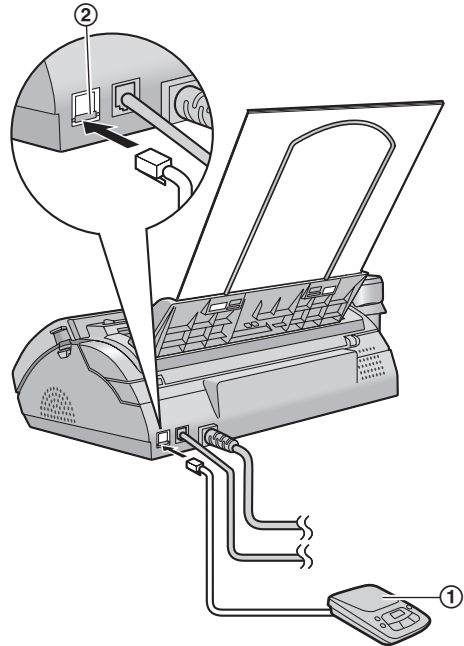

- 2 Set the number of rings on the answering machine to less than 4.
 - This will allow the answering machine to answer the call first.
- 3 Record a greeting message on the answering machine.
 - We recommend you record a message up to 10 seconds long, and not to pause for more than 4 seconds during the message. Otherwise, both machines will not function correctly.
- 4 Activate the answering machine.
- 5 Set the unit to the desired receiving mode (page 26).
 - If you set to FAX ONLY mode, **change the ring setting in FAX ONLY mode to more than 4 (feature #06 on page 37).**
- 6 Check all or part of the following are not the same:
 - the remote access code of the answering machine
 - the fax activation code (feature #41 on page 40)

Note:

- If the call is a phone call, the answering machine will record voice messages.
If a fax calling tone is detected, the fax machine will receive a fax automatically.

Receiving a voice message and fax document in one call

The caller can leave a voice message and send a fax document during the same call. Inform the caller of the following procedure beforehand.

1. The caller calls your unit.
 - The answering device will answer the call.
2. The caller can leave a message after the greeting message.
3. The caller presses **[*][#][9]** (pre-selected fax activation code).
 - The unit will activate the fax function.
4. The caller presses the start button to send a document.

Note:

- To use this feature, make sure remote fax activation is turned ON (Feature #41 on page 40). The fax activation code can also be changed.
- If there is no room left in memory of your answering machine, the unit may not be able to receive documents. See the operating instructions of the answering machine and erase unnecessary messages.

4.9 Receive polling (retrieving a fax placed on another fax machine)

This feature allows you to retrieve a document from another compatible machine. Therefore you pay for the call.

Make sure that no documents are fed into your unit and that the other party's machine is ready for your call.

- 1 Press **[MENU]** repeatedly to display "POLLING".
- 2 **[SET]**
- 3 Dial the fax number.
- 4 **[FAX START]**
 - The unit will start reception.

4.10 Junk fax prohibitor (preventing fax reception from undesired callers)

If you subscribe to Caller ID service (page 20), this feature prevents fax reception from calls that do not show caller information.

Additionally, the fax machine will not accept faxes originated from numbers that match the one on a programmable junk fax prohibitor list.

Important:

- **This feature does not work when manual reception is performed.**

4.10.1 Activating the junk fax prohibitor

- 1 Press **[MENU]** repeatedly to display "JUNK FAX PROH." → **[▶]**
- 2 Press **[+]** or **[-]** repeatedly to select "ON". → **[SET]**
- 3 Press **[MENU]** to exit the program.

4.10.2 Storing undesired callers

You can register up to 10 undesired numbers from the Caller ID list (page 20) if you do not wish to receive faxes from them.

- 1 Press **[MENU]** repeatedly to display "JUNK FAX PROH.".
- 2 Press **[▶]** repeatedly to display "JUNK LIST SET". → **[SET]**
- 3 Press **[+]** or **[-]** repeatedly to display the item you wish to prevent the fax reception from. → **[SET]**
- 4 Press **[STOP]** to exit the program.

To display the junk fax prohibitor list

1. Press **[MENU]** repeatedly to display "JUNK FAX PROH.".
2. Press **[▶]** repeatedly to display "JUNK LIST DISP.". → **[SET]**
3. Press **[+]** or **[-]** to display the item.
4. Press **[MENU]** to exit the program.

To print the junk fax prohibitor list

1. Press **[MENU]** repeatedly to display "JUNK FAX PROH.".
2. Press **[▶]** repeatedly to display "JUNK LIST PRINT". → **[SET]**
3. Press **[MENU]** to exit the list.

To erase an item from the junk fax prohibitor list

1. Press **[MENU]** repeatedly to display "JUNK FAX PROH.".

4. Fax

2. Press **[▶]** repeatedly to display “**JUNK LIST DISP.**”. → **[SET]**
3. Press **[+]** or **[-]** repeatedly to display the desired item. → **[◀]**
 - To cancel erasing, press **[STOP]**, then press **[MENU]**.
4. **[SET]** → **[MENU]**

5.1 Making a copy

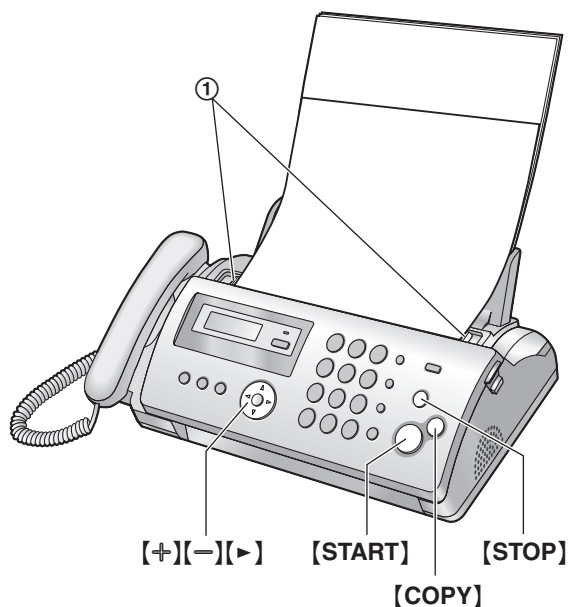

- Adjust the width of the document guides (①) to fit the actual size of the document.
- Insert the document (up to 10 pages) FACE DOWN until a single beep is heard and the unit grasps the document.
- If necessary, press **[+]** or **[-]** repeatedly to select the desired resolution.
 - If you select “STANDARD”, copying will be performed using “FINE” mode.
- [COPY]**
 - If necessary, enter the number of copies (up to 20).
- Press **[START]**, or the unit will start copying within 20 seconds.
 - The unit will start copying.

Note:

- Any document which can be sent as a fax can also be copied (page 23).

To select the resolution

Select the desired resolution according to the character size.

- “FINE”: For small-sized characters.
- “SUPER FINE”: For very small-sized characters.
- “PHOTO”: For photographs, shaded drawings, etc.

Copying from memory (Quick scan feature)

This feature is helpful when you want to copy the document, then remove it for other uses. To use this feature, activate feature #34 (page 40) beforehand. The default setting is OFF.

- If the document exceeds the memory capacity, copying of the exceeded document will be cancelled and this feature will be turned OFF automatically.

To stop copying

Press **[STOP]**.

5.1.1 More copying features

To enlarge a document

- Insert the document.
- [COPY]** → **[>]**
- Press **[+]** repeatedly to select “150%” or “200%”. → **[START]**
 - The unit will enlarge the centre of the upper part of the document. To make an enlarged copy of the bottom of the document, turn the document around, and then make a copy.

Example: 150 % enlarged copy

Original document

Enlarged copy



To reduce a document

- Insert the document.
- [COPY]** → **[>]**
- Press **[-]** repeatedly to select “92%”, “86%” or “72%”, then press **[START]**.

| Setting | Recording paper size | Original document size |
|------------------|----------------------|------------------------|
| “100%” (default) | A4 | A4, Letter |
| “92%” | A4 | A4 |
| “86%” | A4 | A4 |
| “72%” | A4 | Legal |

Note:

- If the image at the bottom of the document is not copied when you copy a document that is the same length as the recording paper, try 92 % or 86 %.

To collate multiple copies

The unit can temporarily collate multiple copies in the same order as the original document pages.

- Insert the document.
- [COPY]**
- Enter the number of copies (up to 20).
- Press **[>]** 2 times to display “COLLATE OFF”.

5. Copy

5. Press **[+]** or **[-]** repeatedly to display “**COLLATE ON**”. → **[START]**

Example: Making 2 copies of a 4-page original document

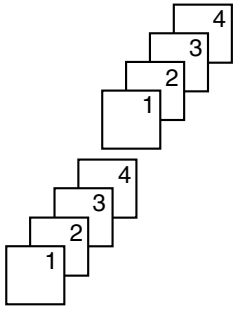

Collated pages

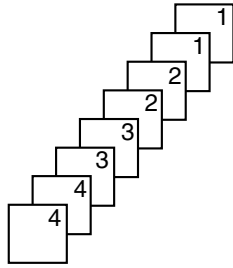

Uncollated pages

Note:

- The unit will store the documents into memory while collating the copies. If memory becomes full while storing, the unit will only print out the stored pages.

6.1 Recording your greeting message

The unit has a pre-recorded greeting message for TAM/FAX mode. If you record your own greeting message, it will be played instead of the pre-recorded greeting message when a call is received. The maximum recording time of your greeting message is either 16 seconds (default) or 60 seconds. We recommend you record a message of less than 12 seconds to make it easier to receive faxes. Make sure feature #77 is set to "TAM/FAX" (page 42) beforehand.

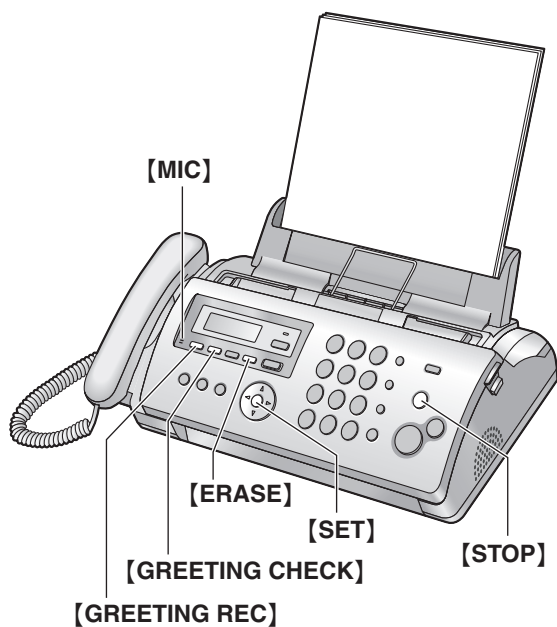

- 1 **[GREETING REC] → [SET]**
 - A long beep will sound.
- 2 Speak clearly about 20 cm away from **[MIC]**.
- 3 When finished recording, press **[STOP]**.

Note:

- You can change the maximum TAM/FAX greeting message recording time to 60 seconds (feature #54 on page 41).
 - If you change the setting to 60 seconds, we recommend that you tell the caller in your TAM/FAX greeting message to press *9 before starting the fax transmission.
 - If you change the setting from 60 seconds to 16 seconds, your current greeting message will be deleted. The pre-recorded greeting message will be played when a call is received.
- If you change the maximum recording time of incoming messages to "GREETING ONLY" (feature #10 on page 37), the unit will answer a call with your current greeting message, and then hang up. Re-

record your greeting message to inform the caller that the unit will not record any incoming messages.

To check the greeting message

Press **[GREETING CHECK]**.

- The unit will play the greeting message.

6.1.1 Erasing your recorded greeting message

1 **[GREETING CHECK]**

- To cancel erasing, press **[STOP]**.

2 **[ERASE]**

Note:

- If you erase your TAM/FAX greeting message, the pre-recorded greeting message will be played when a call is received.

6.2 Listening to recorded messages

When the unit has recorded new voice messages:

- The **[AUTO ANSWER]** indicator will flash when auto answer is turned ON.
- The total number of recorded messages will flash on the display.

6.2.1 To play back messages

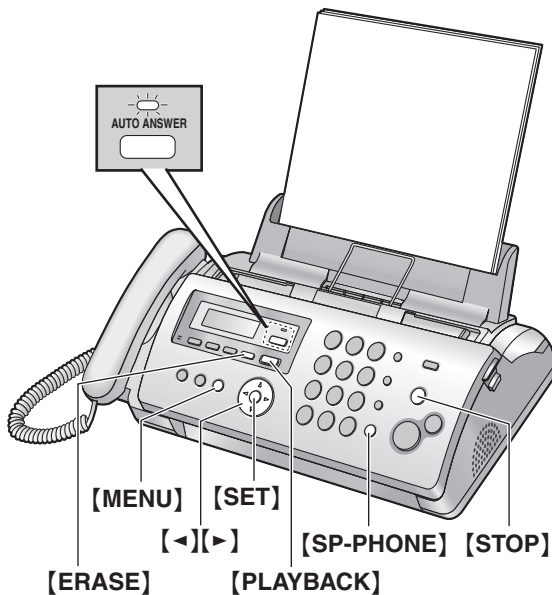

Press **[PLAYBACK]**.

- Only new messages will be played.
- After playing back all of the new messages, the **[AUTO ANSWER]** indicator will stop flashing but will remain lit up when auto answer is turned ON. If you press **[PLAYBACK]** at this time, all the recorded messages will be played.

6.2.2 Useful features during playback

To repeat a message

Press **[<]** while listening to the message.

- If you press **[<]** within 5 seconds of the beginning of the message, the previous message will be played.
- To play back a specific message, press **[<]** or **[>]** and search for the message you want to listen to.

To skip a message

Press **[>]** to play the next message.

To stop playback temporarily

Press **[STOP]**.

- If you press **[PLAYBACK]** within 1 minute, the unit will resume playing the rest of the messages.

Voice time/day stamp

During playback, the unit will announce the day of the week and time that each message was recorded.

If you subscribe to Caller ID service

During playback, you can call back the displayed name or number using the unit.

1. Press **[MENU]** during playback.
 - The unit stops playback.
 - If you do not need to edit the telephone number, skip to step 3.
2. Edit the telephone number (page 21).
3. Press **[SP-PHONE]** or lift the handset.

6.2.3 Erasing recorded messages

To erase a specific message

Press **[ERASE]** while listening to the message you want to erase.

To erase all messages

Press **[ERASE]**. → **[SET]**

6.3 Leaving a message for others or yourself

You can record a voice memo to leave a private message for yourself or someone else. Recorded messages are treated as new messages.

1 **[MEMO]**

- A long beep will sound.

2 Speak clearly about 20 cm away from **[MIC]**.

3 To stop recording, press **[STOP]**.

Note:

- If you record for over 3 minutes, the unit will stop recording.

6.4 Operating from a remote location

Important:

- Program the remote operation ID beforehand (feature #11 on page 38).
- Set the unit to TAM/FAX mode before going out (page 28).
- Use a touch tone telephone for remote operations.

6.4.1 Summary of remote operation

- 1 Call your unit.
- 2 Enter the remote operation ID during or after the TAM/FAX greeting message.
- 3 When there are new recorded messages
 1. A long beep will sound.
 2. Short beep(s) will sound up to 8 times.
 - This indicates the number of new messages.
 3. New messages will be played back.

When there are no new messages

A short beep will not sound.

1. Wait for 4 seconds or press **[5]**.
 2. All the recorded messages will be played back.
- 4 To end remote operation press **[9]**, then hang up.

Note:

- When the voice memory is full, 6 beeps will sound after playing back the recorded messages. Erase any unnecessary messages.

6.4.2 Remote operation using remote commands

- 1 Call your unit.
- 2 Enter the remote operation ID during or after the TAM/FAX greeting message.
- 3 Enter a remote command within 10 seconds.

Note:

- When you press a key, press firmly.

| Key | Remote command |
|---------------|---|
| [1] | Repeats a message (during playback) ^{*1} |
| [2] | Skips a message (during playback) |
| [4] | Plays new messages |
| [5] | Plays all messages |
| [7] | Records greeting message |
| [9] | Stops current operation ^{*2} |
| [0] | Turns OFF auto answer setting |
| [*][4] | Erases a specific message (during playback) |
| [*][5] | Erases all messages |
| [#] | Skips the greeting message |

*1 If pressed within the first 5 seconds of a message, the previous message will be played.

*2 To resume operation, press a command key within 10 seconds, otherwise the marker message recording will start.

Recording a marker message

After playing back the messages, you can leave an additional message.

1. Wait for 3 beeps indicating the end of the remote operation.
2. Hear 1 beep.
3. Wait about 10 seconds.
4. Hear the voice guide or hear 1 beep.
5. Leave a message.

To turn ON the auto answer setting

1. Call your unit and wait for 10 rings.
 - A beep will sound.
2. Enter the remote operation ID (feature #11 on page 38) within 8 seconds.
 - The auto answer setting will be turned ON. The receiving mode will be set to TAM/FAX.
3. Hang up the handset.

Note:

- You cannot turn ON the auto answer setting when the unit is set to TEL/FAX mode.

7.1 Programming

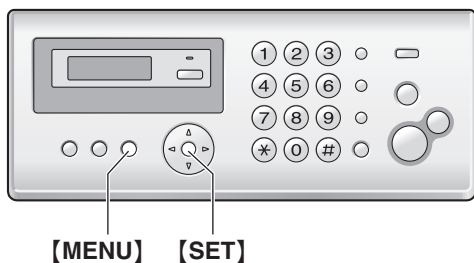

- 1 **[MENU]**
- 2 Press **[#]** and the 2-digit code.
- 3 Press the desired command to display the desired setting.
 - This step may be slightly different depending on the feature.
- 4 **[SET]**
- 5 To exit programming, press **[MENU]**.

7.2 Basic features

| Feature | Feature code | Selection |
|---|--------------|--|
| Setting the date and time | [*][0][1] | Enter the date and time using the dial keypad. See page 16 for details. |
| Setting your logo | [*][0][2] | Enter your logo using the dial keypad. See page 17 for details. |
| Setting your fax number | [*][0][3] | Enter your fax number using the dial keypad. See page 18 for details. |
| Printing a sending report | [*][0][4] | <p>[0] "OFF": Sending reports will not be printed.</p> <p>[1] "ON": A sending report will be printed after every fax transmission.</p> <p>[2] "ERROR" (default): A sending report will be printed only when a fax transmission fails.</p> |
| Changing the ring count in FAX ONLY mode (KX-FP205 only) | [*][0][6] | <p>[1] "1"</p> <p>[2] "2" (default)</p> <p>[3] "3"</p> <p>[4] "4"</p> <p>[5] "5"</p> <p>[6] "6"</p> <p>[7] "7"</p> <p>[8] "8"</p> <p>[9] "9"</p> |
| Changing the ring count in FAX ONLY mode (KX-FP215 only) | [*][0][6] | <p>[1] "1"</p> <p>[2] "2" (default)</p> <p>[3] "3"</p> <p>[4] "4"</p> <p>[5] "5"</p> <p>[6] "6"</p> <p>[7] "7"</p> <p>[8] "8"</p> <p>[9] "9"</p> <p>Note:</p> <ul style="list-style-type: none"> Set feature #77 to "FAX ONLY" (page 42) beforehand. |
| Changing the ring count in TAM/FAX mode (KX-FP215 only) | [*][0][6] | <p>[0] "TOLL SAVER"</p> <p>[2] "2" (default)</p> <p>[3] "3"</p> <p>[4] "4"</p> <p>[5] "5"</p> <p>[6] "6"</p> <p>[7] "7"</p> <p>See page 28 for details.</p> <p>Note:</p> <ul style="list-style-type: none"> Set feature #77 to "TAM/FAX" (page 42) beforehand. |
| Changing the maximum recording time for incoming messages (KX-FP215 only) | [*][1][0] | <p>[0] "GREETING ONLY": The unit plays the greeting message but does not record any incoming messages.</p> <p>[1] "1 MINUTE": 1 minute</p> <p>[2] "2 MINUTES": 2 minutes</p> <p>[3] "3 MINUTES" (default): 3 minutes</p> |

7. Programmable Features

| Feature | Feature code | Selection |
|---|--------------|--|
| Setting the remote operation ID (KX-FP215 only) | 【#】[1][1] | <ol style="list-style-type: none">1. [MENU] → 【#】[1][1]2. To activate the remote operation feature, enter a 3-digit remote operation ID.<ul style="list-style-type: none">• To deactivate the remote operation feature, press 【*】.3. [SET] → [MENU] |
| Setting the ringer tone | 【#】[1][7] | <ol style="list-style-type: none">1. [1] “TONE 1” (default)2. [2] “TONE 2”3. [3] “TONE 3” |

7.3 Advanced features

| Feature | Feature code | Selection |
|---|--------------|---|
| Setting the journal report to print automatically | [*][2][2] | <p>[0] "OFF": The unit will not print a journal report, but will keep a record of the last 30 fax transmissions and receptions.</p> <p>[1] "ON" (default): The unit will print a journal report automatically after every 30 new fax transmissions and receptions (page 22).</p> |
| Sending documents overseas | [*][2][3] | <p>If you cannot send a fax overseas even if the number is correct and the line is connected, activate this feature before sending the fax.</p> <p>This feature improves the reliability by reducing the transmission speed.</p> <p>[0] "OFF": Deactivates this feature.</p> <p>[1] "NEXT FAX": This setting is effective only for the next attempted fax transmission. After transmission, the unit will return to the previous setting.</p> <p>[2] "ERROR" (default): When the previous fax transmission fails and you wish to re-send the document.</p> <p>Note:</p> <ul style="list-style-type: none"> • Calling charges may be higher than usual. |
| Sending a fax at a specified time | [*][2][5] | <p>This feature allows you to take advantage of low-cost calling hours offered by your telephone company. This feature can be set up to 24 hours in advance of the desired time.</p> <p>[0] "OFF" (default)</p> <p>[1] "ON"</p> <p>To send a document:</p> <ol style="list-style-type: none"> 1. Insert the document. 2. If necessary, press [+] or [-] repeatedly to select the desired resolution (page 22). 3. [MENU] → [*][2][5] 4. Press [1] to select "ON". → [SET] 5. Enter the fax number. → [SET] 6. Enter the transmission start time. <ul style="list-style-type: none"> • If you selected 12 hour clock format (page 16), press [*] repeatedly to select AM or PM. • If you selected 24 hour clock format (page 16), the time is set using 24 hour clock format. 7. [SET] → [MENU] <p>Note:</p> <ul style="list-style-type: none"> • To cancel after programming, press [STOP] then [SET]. |
| Setting the Caller ID list to print automatically | [*][2][6] | <p>[0] "OFF" (default): The Caller ID list will not be printed automatically, but the unit will keep a record of the information for the last 30 different callers.</p> <p>[1] "ON": The Caller ID list will be printed automatically each time the unit logs 30 different callers (page 20).</p> |

7. Programmable Features

| Feature | Feature code | Selection | | | | | | | | | | | | | | | |
|-----------------------------------|----------------------|--|---------|----------------------|------------------------|--------|----|------------|-----------------|----|----|-------|----|----|-------|----|-------|
| Setting the quick scan | 【#】[3][4] | <p>This feature is helpful when you want to remove the document for other uses, because the unit will release the document before sending or copying.</p> <p>[0] “OFF” (default): Deactivates this feature.</p> <p>[1] “ON”: The unit will scan the document and store it into memory first, then the unit will start sending or copying the documents.</p> <p>Note:</p> <ul style="list-style-type: none"> If the document exceeds the memory capacity, sending of the whole document or copying of the exceeded document will be cancelled and this feature will be turned OFF automatically. | | | | | | | | | | | | | | | |
| Receiving oversized documents | 【#】[3][6] | <p>If the size of the document sent by the other party is as large as or larger than the recording paper, the unit can reduce the document and print it. Select the desired reduction rate.</p> <p>[1] “72%”</p> <p>[2] “86%”</p> <p>[3] “92%” (default)</p> <p>[4] “100%”</p> <table border="1" data-bbox="636 765 1275 1020"> <thead> <tr> <th>Setting</th> <th>Recording paper size</th> <th>Original document size</th> </tr> </thead> <tbody> <tr> <td>“100%”</td> <td>A4</td> <td>A4, Letter</td> </tr> <tr> <td>“92%” (default)</td> <td>A4</td> <td>A4</td> </tr> <tr> <td>“86%”</td> <td>A4</td> <td>A4</td> </tr> <tr> <td>“72%”</td> <td>A4</td> <td>Legal</td> </tr> </tbody> </table> <p>Note:</p> <ul style="list-style-type: none"> The information of the sending party is printed on the top of each page. Therefore, even if the original document is the same size as the recording paper, the document will be divided into 2 sheets when printed at “100%”. Select “92%” to print on 1 sheet. | Setting | Recording paper size | Original document size | “100%” | A4 | A4, Letter | “92%” (default) | A4 | A4 | “86%” | A4 | A4 | “72%” | A4 | Legal |
| Setting | Recording paper size | Original document size | | | | | | | | | | | | | | | |
| “100%” | A4 | A4, Letter | | | | | | | | | | | | | | | |
| “92%” (default) | A4 | A4 | | | | | | | | | | | | | | | |
| “86%” | A4 | A4 | | | | | | | | | | | | | | | |
| “72%” | A4 | Legal | | | | | | | | | | | | | | | |
| Changing the LCD display contrast | 【#】[3][9] | <p>[1] “NORMAL” (default)</p> <p>[2] “DARKER”</p> | | | | | | | | | | | | | | | |
| Changing the fax activation code | 【#】[4][1] | <p>If you wish to use an extension telephone (page 27) to receive faxes, activate this feature and program the activation code.</p> <p>[0] “OFF”</p> <p>[1] “ON” (default)</p> <ol style="list-style-type: none"> [MENU] → 【#】[4][1] Press [1] to select “ON”. → [SET] Enter your code from 2 to 4 digits, using 0-9, [*] and 【#】. <ul style="list-style-type: none"> The default code is “*#9”. [SET] → [MENU] | | | | | | | | | | | | | | | |

| Feature | Feature code | Selection |
|---|--------------|---|
| Setting the memory reception alert | [*][4][4] | To alert you with a beeping sound when a received fax document is stored into memory due to some existing problem. [0] "OFF": Deactivates this feature. [1] "ON" (default): You will hear a beeping sound. Note: <ul style="list-style-type: none"> The slow beeps will continue until you clear the printing problem and make sure the unit is supplied with enough paper to print the stored document. |
| Setting friendly reception | [*][4][6] | To receive a fax automatically when you answer a call and hear a fax calling tone (slow beep). [0] "OFF": You have to press [FAX START] for fax reception. [1] "ON" (default): You do not have to press [FAX START] for fax reception. |
| Setting the voice guidance (KX-FP215 only) | [*][4][7] | If you wish to hear voice guidance, activate this feature. [0] "OFF": Deactivates this feature. [1] "ON" (default): You will hear the friendly reception voice guide, pre-recorded messages and voice time/day stamp. |
| Setting the auto disconnection | [*][4][9] | To answer a call with an extension telephone in TEL/FAX mode (page 27) or TAM/FAX mode (page 28), activate this feature and program the code. [0] "OFF" [1] "ON" (default) 1. [MENU] → [*][4][9] 2. Press [1] to select "ON". → [SET] 3. Enter your code from 2 to 4 digits, using 0–9 and [*] . <ul style="list-style-type: none"> The default code is *0. 4. [SET] → [MENU] |
| Changing the recording time for your TAM/FAX greeting message (KX-FP215 only) | [*][5][4] | [1] "16s" (default): Maximum recording time is 16 seconds. [2] "60s": Maximum recording time is 60 seconds. See page 33 for details. |
| Setting the scan contrast | [*][5][8] | To send or copy a document with faint or dark writing, set this feature before transmission or copying. [1] "NORMAL" (default): Used for normal writing. [2] "LIGHT": Used for dark writing. [3] "DARKER": Used for faint writing. |
| Setting the incoming message monitor (KX-FP215 only) | [*][6][7] | To hear an incoming message (ICM) from the speaker when the answering machine is recording the message. [0] "OFF" [1] "ON" (default) |
| Setting the Error Correction Mode (ECM) | [*][6][8] | This feature is available when the transmitting/receiving fax machines are ECM compatible. [0] "OFF": Deactivates this feature. [1] "ON" (default): If there is an error during fax transmission/reception, the fax machine will support the communication. Note: <ul style="list-style-type: none"> You cannot change the setting when received documents are in memory. |

7. Programmable Features

| Feature | Feature code | Selection |
|--|--------------|---|
| Setting recall time | 【#】[7][2] | <p>The recall time depends on your telephone exchange or host PBX.</p> <p>【1】“900ms” 【2】“700ms” 【3】“600ms” 【4】“400ms” 【5】“300ms” 【6】“250ms” 【7】“200ms” 【8】“160ms” 【9】“110ms” 【*】“100ms” (default) 【0】“90ms” 【#】“80ms”</p> <p>Note:</p> <ul style="list-style-type: none"> • If the unit is connected via a PBX, this setting may need to be changed in order for PBX functions (transferring a call, etc.) to work correctly. Consult your PBX supplier for the correct setting. |
| Changing the receiving mode in the manual answer setting | 【#】[7][3] | <p>【1】“TEL” (default): Telephone mode (page 26) 【2】“TEL/FAX”: Telephone/Fax mode (page 27)</p> |
| Setting the connecting tone | 【#】[7][6] | <p>If you often have trouble when sending faxes, this feature allows you to hear connecting tones: fax tone, ring back tone and busy tone. You can use those tones to confirm the status of the other party's machine.</p> <p>【0】“OFF”: Deactivates this feature. 【1】“ON” (default): You will hear connecting tones.</p> <p>Note:</p> <ul style="list-style-type: none"> • If the ring back tone continues, the other party's machine may not be a fax machine or may have run out of paper. Check with the other party. • The connecting tone volume cannot be adjusted. |
| Changing the receiving mode in the AUTO ANSWER setting (KX-FP215 only) | 【#】[7][7] | <p>【1】“TAM/FAX” (default): Telephone Answering Machine/Fax mode (page 28) 【2】“FAX ONLY”: Fax only mode (page 27)</p> |
| Changing the TEL/FAX delayed ring count | 【#】[7][8] | <p>If you use an extension telephone in TEL/FAX mode, select the desired number of times the extension telephone rings before the unit answers the call.</p> <p>【1】“1” 【2】“2” (default) 【3】“3” 【4】“4” 【5】“5” 【6】“6” 【7】“7” 【8】“8” 【9】“9”</p> |

| Feature | Feature code | Selection |
|--|------------------|---|
| Resetting advanced features to their default settings | [#][8][0] | [0] “NO” (default) [1] “YES” To reset the advanced features: 1. [MENU] → [#][8][0] 2. Press [1] to select “YES”. → [SET] → [SET] → [MENU] <ul style="list-style-type: none">• The ECM setting (feature #68 on page 41) will not be reset. |

8.1 Error messages – Reports

If a problem occurs during fax transmission or reception, one of the following messages will be printed on the sending and journal reports (page 22).

| Message | Code | Cause & Solution |
|---------------------------------|----------------------|--|
| COMMUNICATION ERROR | 40-42 46-72 FF | <ul style="list-style-type: none"> ● A transmission or reception error occurred. Try again or check with the other party. |
| | 43 44 | <ul style="list-style-type: none"> ● A line problem occurred. Connect the telephone line cord to a different socket and try again. ● An overseas transmission error occurred. Try using the overseas mode (feature #23 on page 39). |
| DOCUMENT JAMMED | ----- | <ul style="list-style-type: none"> ● Remove the jammed document (page 53). |
| ERROR-NOT YOUR UNIT | 53 54 59 70 | <ul style="list-style-type: none"> ● A transmission or reception error occurred because of a problem with the other party's fax machine. Check with the other party. |
| JUNK FAX PROH. REJECT | ----- | <ul style="list-style-type: none"> ● The junk fax prohibitor feature of this unit rejected fax reception. |
| MEMORY FULL | ----- | <ul style="list-style-type: none"> ● The memory is full of received documents due to a lack of recording paper, a lack of ink film or a recording paper jam. Install paper (page 14), install ink film (page 12) or remove the jammed paper (page 52). |
| NO DOCUMENT | ----- | <ul style="list-style-type: none"> ● The document was not fed into the unit properly. Re-insert the document and try again. |
| OTHER FAX NOT RESPONDING | ----- | <ul style="list-style-type: none"> ● The other party's fax machine is busy or has run out of recording paper. Try again. ● The other party's fax machine rang too many times. Send the fax manually (page 22). ● The other party's machine is not a fax machine. Check with the other party. ● The number you dialled is not in service. |
| PRESSED THE STOP KEY | ----- | <ul style="list-style-type: none"> ● [STOP] was pressed, and fax transmission or reception was cancelled. |
| OK | ----- | <ul style="list-style-type: none"> ● Fax transmission or reception was successful. |

8.2 Error messages – Display

If the unit detects a problem, one or more of the following messages will appear on the display.

| Display | Cause & Solution |
|-------------------|---|
| “BACK COVER OPEN” | <ul style="list-style-type: none"> • The back cover is open. Close the back cover firmly. |
| “CALL SERVICE” | <ul style="list-style-type: none"> • There is something wrong with the unit. Contact our service personnel. |
| “CHECK DOCUMENT” | <ul style="list-style-type: none"> • The document was not fed into the unit properly. Re-insert the document. If misfeeding occurs frequently, clean the document feeder rollers (page 54) and try again. • The document is longer than 600 mm. Press [STOP] to remove the document. Divide the document into two or more sheets, and try again. |
| “CHECK FILM” | <ul style="list-style-type: none"> • The ink film is empty. Replace the ink film with a new one (page 12). • The ink film is not installed. Install it (page 12). • The ink film is slack or creased. Tighten it (see step 5 on page 12). |
| “CHECK MEMORY” | <ul style="list-style-type: none"> • The memory (telephone numbers, parameters, etc.) has been erased. Re-program. |
| “CHECK PAPER” | <ul style="list-style-type: none"> • The recording paper is not installed or the unit has run out of paper. Install paper and press [SET] to clear the message. • The recording paper was not fed into the unit properly (page 53). Re-install paper (page 14) and press [SET] to clear the message. • The recording paper has jammed near the recording paper entrance. Remove the jammed paper (page 52) and press [SET] to clear the message. |
| “FAX IN MEMORY” | <ul style="list-style-type: none"> • See the other displayed message instructions to print out the document. Received documents are stored in memory due to a lack of recording paper, a lack of ink film or a recording paper jam. Install paper (page 14), install ink film (page 12) or remove the jammed paper (page 52). You will lose all faxes in memory if the power is removed. Check with power connected. |
| “FAX MEMORY FULL” | <ul style="list-style-type: none"> • The memory is full of received documents due to a lack of recording paper, a lack of ink film or a recording paper jam. Install paper (page 14), install ink film (page 12) or remove the jammed paper (page 52). You will lose all faxes in memory if the power is removed. Check with power connected. • When performing memory transmission, the document being stored exceeded the memory capacity of the unit. Send the entire document manually. |
| “FILM EMPTY” | <ul style="list-style-type: none"> • The ink film is empty. Replace the ink film with a new one (page 12). • The ink film is slack. Tighten it (see step 5 on page 12) and install again. • The fax machine is positioned near appliances such as TVs or speakers which generate an intense magnetic field. |
| “FILM NEAR EMPTY” | <ul style="list-style-type: none"> • The remaining ink film is low. Prepare a new ink film (page 9). |
| “MEMORY FULL” | <ul style="list-style-type: none"> • When making a copy, the document being stored exceeded the memory capacity of the unit. Press [STOP] to clear the message. Divide the document into sections. |
| “MESSAGE FULL” | <ul style="list-style-type: none"> • There is no room left in memory to record voice messages. Erase unnecessary messages (page 34). |
| “MODEM ERROR” | <ul style="list-style-type: none"> • There is something wrong with the unit’s modem. Contact our service personnel. |

| Display | Cause & Solution |
|---|--|
| “NO TAM GREETING” | <ul style="list-style-type: none"> Your TAM/FAX greeting message is not recorded. Record a message (page 33). The voice guidance feature is set to off. Activate feature #47 on page 41. Prerecorded greeting message will be adopted. |
| “NO FAX REPLY” | <ul style="list-style-type: none"> The other party’s fax machine is busy or has run out of recording paper. Try again. |
| “OPEN CABINET CHECK FILM SLACK” “OPEN CABINET CHECK FILM TYPE” | <ul style="list-style-type: none"> Please use genuine Panasonic replacement film (page 9). The ink film is slack. Tighten it (see step 5 on page 12). The fax machine is positioned near appliances such as TVs or speakers which generate an intense magnetic field. |
| “PAPER JAMMED” | <ul style="list-style-type: none"> A recording paper jam occurred. Remove the jammed paper (page 52). You forced the recording paper into the paper tray too strongly. Remove all of the installed paper, and re-install it gently. |
| “PHONEBOOK FULL” | <ul style="list-style-type: none"> There is no space to store new items in the phonebook. Erase unnecessary items (page 19). |
| “PLEASE WAIT” | <ul style="list-style-type: none"> The unit is checking that there is no slack or crease in the ink film. Wait for a moment while the check is completed. |
| “POLLING ERROR” | <ul style="list-style-type: none"> The other party’s fax machine does not offer the polling function. Check with the other party. |
| “REDIAL TIME OUT” | <ul style="list-style-type: none"> The other party’s fax machine is busy or has run out of recording paper. Try again. |
| “REMOVE DOCUMENT” | <ul style="list-style-type: none"> The document is jammed. Remove the jammed document (page 53). Press [STOP] to eject the jammed paper. |
| “TRANSMIT ERROR” | <ul style="list-style-type: none"> A transmission error occurred. Try again. If you send a fax overseas, try the following: <ul style="list-style-type: none"> Use the overseas transmission mode (feature #23 on page 39). Add 2 pauses at the end of the telephone number or dial manually. |
| “UNIT OVERHEATED” | <ul style="list-style-type: none"> The unit is too hot. Stop using the unit for a while and let the unit cool down. |

8.3 When a function does not work, check here

8.3.1 Initial settings

| Problem | Cause & Solution |
|----------------------------|--|
| I cannot hear a dial tone. | <ul style="list-style-type: none"> The telephone line cord is connected to the [EXT] socket on the unit. Connect to the [LINE] socket (page 15) (KX-FP205 only). If you used a splitter/coupler to connect the unit, remove the splitter/coupler and connect the unit to the wall socket directly. If the unit operates properly, check the splitter/coupler. Disconnect the unit from the telephone line and connect a known working telephone. If the working telephone operates properly, contact our service personnel to have the unit repaired. If the working telephone does not operate properly, contact your telephone company. The mains lead or telephone line cord is not connected. Check the connections. If you have connected the fax machine through a computer modem, connect the fax machine directly to a telephone line socket. |
| The unit does not work. | <ul style="list-style-type: none"> Check the connections (page 15). |

| Problem | Cause & Solution |
|-------------------------|---|
| The unit does not ring. | <ul style="list-style-type: none"> The ringer volume is turned OFF. Adjust it (page 16). |

8.3.2 General

| Problem | Cause & Solution |
|--|---|
| The unit displays “PAPER JAMMED” even though paper is installed. | <ul style="list-style-type: none"> You forced the recording paper into the paper tray too strongly. Remove all of the installed paper, and re-install it gently. |
| The unit displays “CHECK PAPER” even though paper is inserted. | <ul style="list-style-type: none"> The paper is inserted halfway. Insert it correctly (page 53) and press [SET] to clear the message. |
| The other party complains they only hear a fax tone and cannot talk. | <ul style="list-style-type: none"> FAX ONLY mode is set. Tell the other party the number is only used for faxes. Change the receiving mode: <ul style="list-style-type: none"> KX-FP205: TEL mode (page 26) or TEL/FAX mode (page 27) KX-FP215: TAM/FAX mode (page 28), TEL mode (page 26) or TEL/FAX mode (page 27) |
| [REDIAL] or [PAUSE] does not function properly. | <ul style="list-style-type: none"> If this button is pressed during dialling, a pause will be inserted. If pressed immediately after a dial tone is obtained, the last number dialled will be redialled. |
| The ink film runs out quickly. | <ul style="list-style-type: none"> Even if there are only a few sentences, every page that comes out of the machine is considered a full page. Turn OFF the following features: <ul style="list-style-type: none"> sending report: feature #04 on page 37. journal report: feature #22 on page 39. Caller ID list: feature #26 on page 39. |
| During programming, I cannot enter the code or ID number. | <ul style="list-style-type: none"> All or part of the numbers are the same as another code or ID. Change the number: <ul style="list-style-type: none"> remote operation ID: feature #11 on page 38. fax activation code: feature #41 on page 40. auto disconnection: feature #49 on page 41. |
| The unit beeps. | <ul style="list-style-type: none"> The memory reception alert of feature #44 is ON (page 41), and the unit has a document in memory. Press [STOP] to stop the beeps, then see the displayed message instructions to solve the problem. |
| The speakerphone is not working. | <ul style="list-style-type: none"> Use the speakerphone in a quiet room. If you have difficulty hearing the other party, adjust the volume. |
| The unit does not display the caller's name and/or telephone number. | <ul style="list-style-type: none"> You need to subscribe to a Caller ID service. Other telephone equipment may be interfering with your phone. Disconnect it and try again. Other electrical appliances connected to the same outlet may be interfering with the Caller ID information. Telephone line noise may be affecting the Caller ID information. The caller requested not to send his/her information (page 20). |
| The display exits the Caller ID list while viewing caller information. | <ul style="list-style-type: none"> Do not pause for over 3 minutes while viewing. |

8.3.3 Fax – sending



| Problem | Cause & Solution |
|---|---|
| I cannot send documents. | <ul style="list-style-type: none"> • The telephone line cord is connected to the [EXT] socket on the unit. Connect to the [LINE] socket (page 15) (KX-FP205 only). • The other party's fax machine is busy or has run out of recording paper. Try again. • The other party's machine is not a fax machine. Check with the other party. • The other party's fax machine failed to answer the fax automatically. Send the fax manually (page 22). • The memory is full of received documents and the quick scan (feature #34 on page 40) is ON. Turn this feature OFF, and send the fax again. |
| I cannot send a fax overseas. | <ul style="list-style-type: none"> • Use the overseas transmission mode (feature #23 on page 39). • Add two pauses at the end of the telephone number or dial manually. |
| The other party complains that letters on their received document are distorted or not clear. | <ul style="list-style-type: none"> • If your line has special telephone services such as call waiting, the service may have been activated during fax transmission. Connect the unit to a line that does not have these services. • An extension telephone on the same line is occupying the line. Hang up the extension telephone and try again. • Try copying the document with this unit. If the copied image is clear, there may be something wrong with the other party's machine. • Adjust the scan contrast using feature #58 (page 41). |
| The other party complains that black lines, white lines or smudges appear on their received document. | <ul style="list-style-type: none"> • The scanner glass or rollers are dirty with correction fluid, etc. Clean them (page 54). Please do not insert a document before correction fluid has dried completely. |
| Documents frequently misfeed. | <ul style="list-style-type: none"> • Clean the document feeder rollers, recording paper feeder and rubber flap (page 54). |

8.3.4 Fax – receiving

| Problem | Cause & Solution |
|---|---|
| I cannot receive documents. | <ul style="list-style-type: none"> • The telephone line cord is connected to the [EXT] socket on the unit. Connect to the [LINE] socket (page 15) (KX-FP205 only). • The ink film is empty. Replace the ink film with a new one (page 12). |
| I cannot receive documents automatically. | <ul style="list-style-type: none"> • The receiving mode is set to TEL mode. Change the receiving mode: <ul style="list-style-type: none"> – KX-FP205: FAX ONLY mode (page 27) or TEL/FAX mode (page 27) – KX-FP215: TAM/FAX mode (page 28), FAX ONLY mode (page 27) or TEL/FAX mode (page 27) • The time taken to answer the call is too long. Decrease the number of rings in feature #06 (page 37) and feature #78 (page 42). • The greeting message is too long. Record a shorter message (page 33). |
| The display shows "CONNECTING", but faxes are not received. | <ul style="list-style-type: none"> • The receiving mode is set to FAX ONLY mode and the incoming call is not a fax. Change the receiving mode: <ul style="list-style-type: none"> – KX-FP205: TEL mode (page 26) or TEL/FAX mode (page 27) – KX-FP215: TEL mode (page 26), TAM/FAX mode (page 28) or TEL/FAX mode (page 27) |

| Problem | Cause & Solution |
|--|---|
| A blank sheet is ejected. | <ul style="list-style-type: none"> ● If a blank sheet is ejected after the received document is printed out, the size of the document sent by the other party is as large as, or larger than, the recording paper, and the receiving reduction rate is not programmed correctly. Program the proper rate in feature #36 (page 40). ● The other party placed the document in their fax machine facing the wrong way. Check with the other party. |
| The printing quality is poor. | <p>Please do not reuse the ink film! Please use genuine Panasonic replacement film. Refer to page 9 for further details.</p> <ul style="list-style-type: none"> ● The thermal head is dirty. Clean it (page 55). ● If documents can be copied properly, the unit is working normally. The other party may have sent a faint document or there may be something wrong with the other party's machine. Ask them to send a clearer copy of the document or to check their fax machine. ● Some paper has instructions recommending which side to print on. Try turning the recording paper over. ● You may have used paper with a cotton and/or fibre content that is over 20%, such as letterhead or resume paper. |
| Recording paper frequently misfeeds. | <ul style="list-style-type: none"> ● Clean the document feeder rollers, recording paper feeder and rubber flap (page 54). |
| Letters on the received document are distorted. | <ul style="list-style-type: none"> ● If your line has special telephone services such as call waiting, the service may have been activated during fax reception. Connect the unit to a line that does not have these services. |
| I cannot receive documents by pressing [*][#][9] on an extension telephone. | <ul style="list-style-type: none"> ● You must set remote fax activation to ON (feature #41 on page 40) beforehand. ● You may have changed the remote fax activation code from [*][#][9] (default setting). Verify the remote fax activation code (feature #41 on page 40). ● The memory is full of received documents due to a lack of recording paper, a lack of ink film or a recording paper jam. Install paper (page 14), install ink film (page 12) or remove the jammed paper (page 52). |
| The other party complains that they cannot send a document. | <ul style="list-style-type: none"> ● The receiving mode is set to TEL mode. Receive the document manually (page 26) or change the receiving mode: <ul style="list-style-type: none"> – KX-FP205: FAX ONLY mode (page 27) or TEL/FAX mode (page 27) – KX-FP215: TAM/FAX mode (page 28), FAX ONLY mode (page 27) or TEL/FAX mode (page 27) ● The memory is full of received documents due to a lack of recording paper, a lack of ink film or a recording paper jam. Install paper (page 14), install ink film (page 12) or remove the jammed paper (page 52). |
| I cannot select the desired receiving mode. | <ul style="list-style-type: none"> ● If you want to set TAM/FAX (KX-FP215 only) or FAX ONLY mode: <ul style="list-style-type: none"> – KX-FP205: Press [AUTO ANSWER] repeatedly until “FAX ONLY MODE” is displayed. – KX-FP215: Select the desired mode using feature #77 (page 42), and press [AUTO ANSWER] repeatedly until the desired mode is displayed. ● If you want to set TEL or TEL/FAX mode, set the desired mode using feature #73 (page 42), and press [AUTO ANSWER] repeatedly to select the desired mode. |

8.3.5 Copying

| Problem | Cause & Solution |
|---|---|
| The unit will not make a copy. | <ul style="list-style-type: none"> • The ink film is empty. Replace the ink film with a new one (page 12). • You cannot make a copy during programming. • You cannot make a copy during a telephone conversation. |
| A black line, white line or smudge appears on the copied document. | <ul style="list-style-type: none"> • The scanner glass or rollers are dirty with correction fluid, etc. Clean them (page 54). Please do not insert a document before correction fluid has dried completely. |
| The copied image is distorted. | <ul style="list-style-type: none"> • Adjust the width of the document guides to fit the actual size of the document. |
| The printing quality is poor. Original  Copy  | Please do not reuse the ink film! Please use genuine Panasonic replacement film. Refer to page 9 for further details. <ul style="list-style-type: none"> • The thermal head is dirty. Clean it (page 55). • Some paper has instructions recommending which side to print on. Try turning the recording paper over. • You may have used paper with a cotton and/or fibre content that is over 20%, such as letterhead or resume paper. |
| Documents or recording paper frequently misfeed. | <ul style="list-style-type: none"> • Clean the document feeder rollers, recording paper feeder and rubber flap (page 54). |

8.3.6 Using an answering machine (KX-FP205 only)

| Problem | Cause & Solution |
|---|---|
| I cannot receive documents automatically. | <ul style="list-style-type: none"> • Your greeting message on the answering machine is too long. Shorten the message. Record a message up to 10 seconds long. • The answering machine rings too many times. Set to 1 or 2 rings. |
| I cannot receive voice messages. | <ul style="list-style-type: none"> • Check if the answering machine is turned ON and connected to the unit properly (page 28). • Set the number of rings on the answering machine to 1 or 2. |
| I pressed the remote access code to access the answering machine remotely, but the line was disconnected. | <ul style="list-style-type: none"> • The code may include “#” which is used for certain features provided by telephone companies. Change the code on the answering machine to another number which does not include “#”. |
| Callers complain that they cannot send a document. | <ul style="list-style-type: none"> • There is no room left in memory of your answering machine to record voice messages. See the operating instructions of the answering machine and erase unnecessary messages. • You set the answering machine to only give a greeting message. |

8.3.7 Answering machine (KX-FP215 only)

| Problem | Cause & Solution |
|---|---|
| I cannot listen to messages from a remote location. | <ul style="list-style-type: none"> • Press the remote operation ID (code) correctly and firmly (feature #11 on page 38). • The unit is not in TAM/FAX mode. Change to TAM/FAX mode (page 35). |

| Problem | Cause & Solution |
|--|---|
| The other party complains that they cannot leave a voice message. | <ul style="list-style-type: none"> ● The recording time is set to “GREETING ONLY”. Select “1 MINUTE”, “2 MINUTES” or “3 MINUTES” (feature #10 on page 37). ● The memory is full. Erase unnecessary messages (page 34). ● Make sure there is no other answering machine connected on the same line. |
| Caller ID information does not display during message playback. | <ul style="list-style-type: none"> ● The caller information will not be displayed if a message is recorded by using [MEMO] (page 34). |

8.3.8 If a power failure occurs

- The unit will not function.
- The unit is not designed for making emergency telephone calls when the power fails. Alternative arrangements should be made for access to emergency services.
- Fax transmission and reception will be interrupted.
- If delayed transmission (feature #25 on page 39) is programmed and a power failure prevents the document from being sent at the set time, the document will be sent after power is restored.
- If any fax documents are stored in the memory, they will be lost. When power is restored, a power down report will be printed stating which documents in memory have been erased.

9.1 Recording paper jams

9.1.1 When the recording paper has jammed in the unit

The display will show the following.

PAPER JAMMED

Important:

- Remove the recording paper, then remove the paper tray beforehand, otherwise the paper may misfeed or jam.

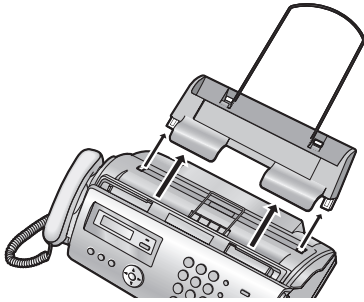

- Open the front cover (①), push the green button (②), then open the back cover (③).

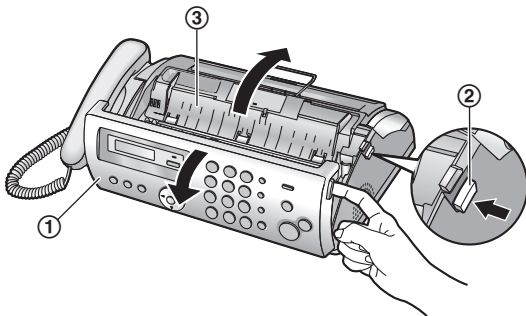

- Remove the jammed recording paper (④).

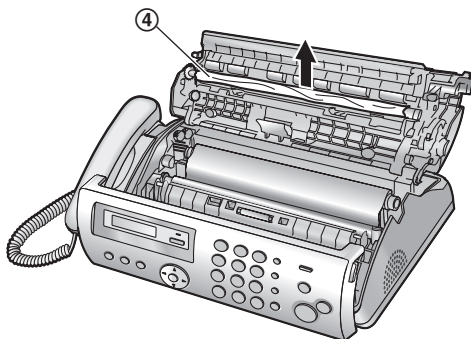

- Turn the blue gear (⑤) in the direction of the arrow until the ink film is tight (⑥) and at least one layer of ink film is wrapped around the blue core (⑦).

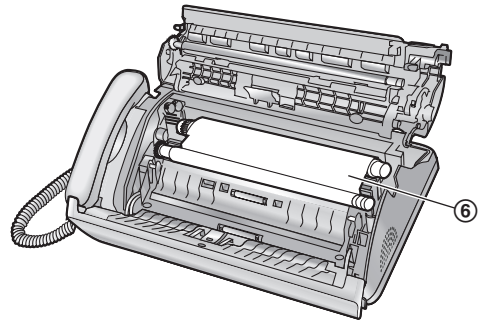
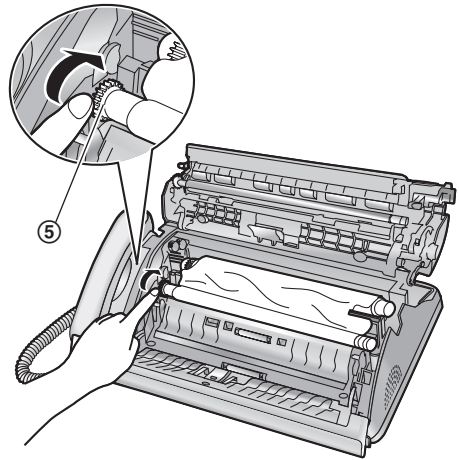

Correct

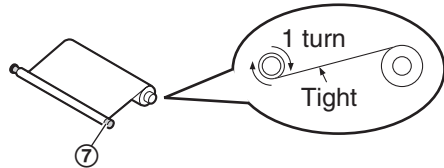

Incorrect

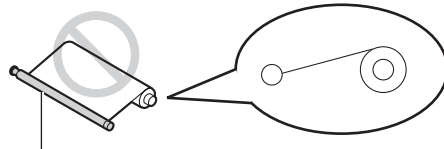

No ink film is wrapped around the blue core.



- 4 Close the back cover securely by pushing down on the dotted area at both ends (⑧), then close the front cover securely (⑨).

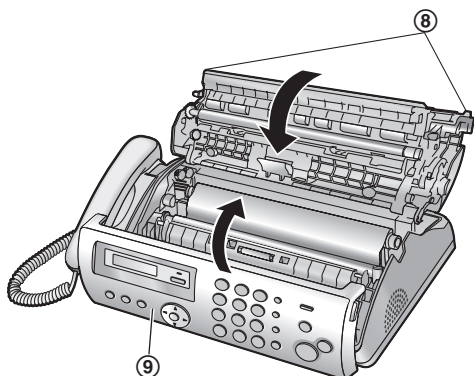

- 5 Install the paper tray (page 13), then insert the recording paper gently (page 14).

9.1.2 When the recording paper was not fed into the unit properly

The display will show the following.

CHECK PAPER

Remove the recording paper and straighten. Insert the paper, then press **[SET]** to clear the message.



9.2 Document jams

- 1 Open the front cover. Remove the jammed document carefully (①).

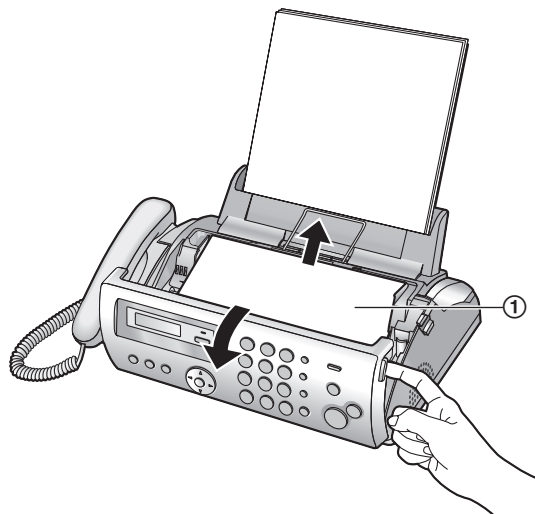

- 2 Close the front cover securely.

Note:

- Do not pull out the jammed paper forcibly before opening the front cover.

9.3 Document feeder/recording paper feeder/scanner glass cleaning

Clean the document feeder/recording paper feeder/scanner glass when:

- Documents or recording paper frequently misfeed.
- Smudges or black/white lines appear on the original document when sending or copying.

Important:

- Remove the recording paper, then remove the paper tray beforehand, otherwise the paper may misfeed or jam.

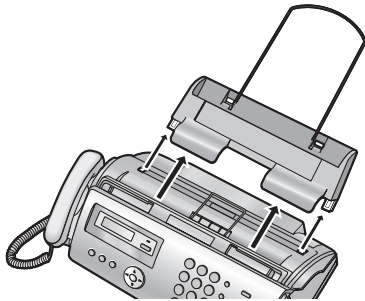

- 1 Disconnect the mains lead and the telephone line cord.
- 2 Open the front cover (1), push the green button (2), then open the back cover (3).

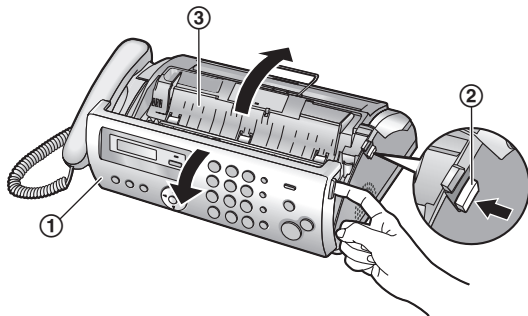

- 3 Clean the document feeder rollers (4) and rubber flap (5) with a cloth moistened with isopropyl rubbing alcohol, and let all parts dry thoroughly. Clean the scanner glass (6) with a soft, dry cloth.

Caution:

- Do not use paper products, such as paper towels or tissues.

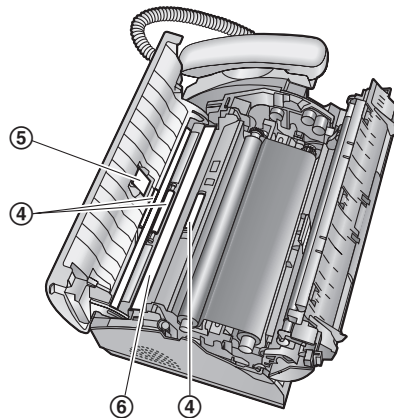

- 4 Clean the recording paper feeder roller (7) with a cloth moistened with isopropyl rubbing alcohol, and let all parts dry thoroughly.

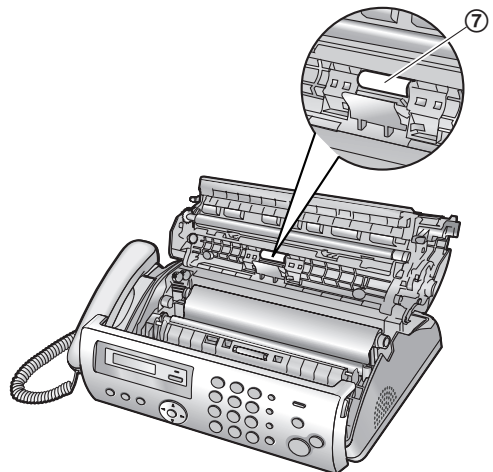

- 5 Close the back cover securely by pushing down on the dotted area at both ends (8), then close the front cover securely (9).

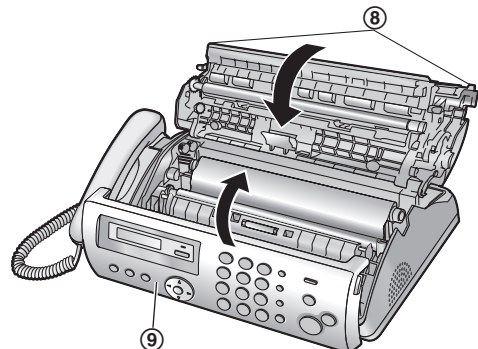

- 6 Install the paper tray (page 13), then insert the recording paper gently (page 14).
- 7 Connect the mains lead and the telephone line cord.

9.4 Thermal head cleaning

If smudges or black/white lines appear on a copied/received document, check whether there is dust on the thermal head. Clean the thermal head to remove the dust.

Important:

- Remove the recording paper, then remove the paper tray beforehand, otherwise the paper may misfeed or jam.

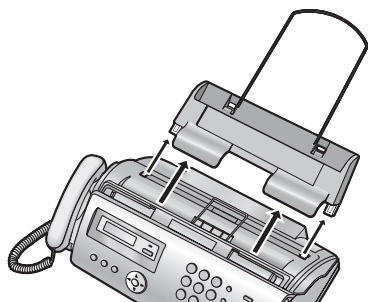

- 1 Disconnect the mains lead and the telephone line cord.
- 2 Open the front cover (①), push the green button (②), then open the back cover (③).

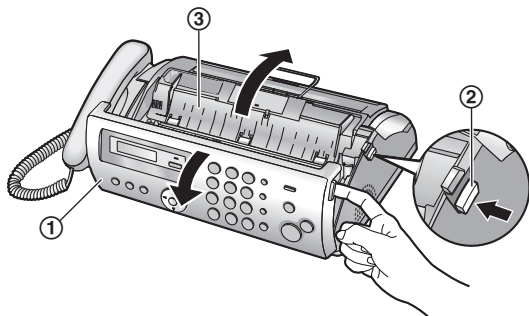

- 3 Remove the ink film (④).

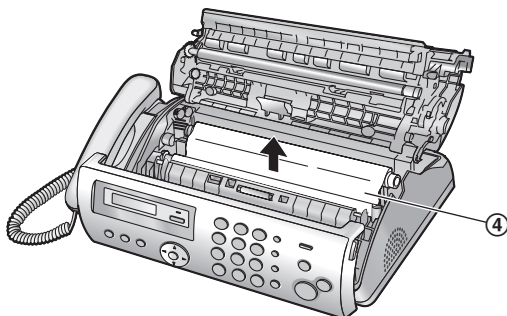

- 4 Clean the thermal head (⑤) with a cloth moistened with isopropyl rubbing alcohol, and let it dry thoroughly.

Caution:

- To prevent a malfunction due to static electricity, do not use a dry cloth and do not touch the thermal head directly.

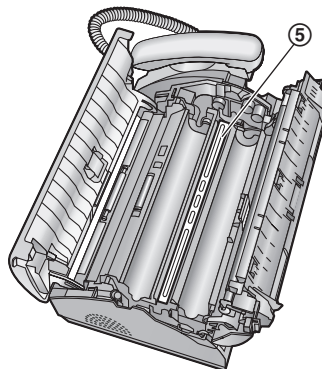

- 5 Re-install the ink film and close the covers (see step 4 to 7 on page 12).
- 6 Install the paper tray (page 13), then insert the recording paper gently (page 14).
- 7 Connect the mains lead and the telephone line cord.

10.1 Reference lists and reports

You can print out the following lists and reports for your reference:

- "SETUP LIST"
- "PHONEBOOK LIST"
- "JOURNAL REPORT"
- "BROADCAST LIST"
- "PRINTER TEST"
 - If the test print has a smudges, blurred points or lines, clean the thermal head (page 55).
- "CALLER ID LIST"
- "AUTO JOURNAL"
- "AUTO CALL. LIST"

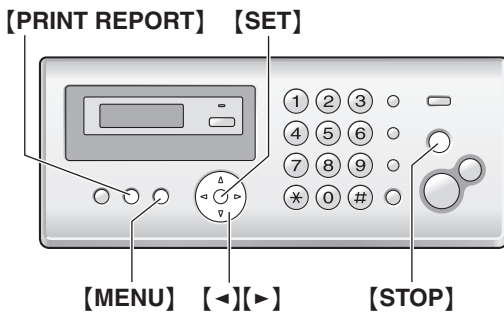

- 1 **[PRINT REPORT]**
- 2 Press **[->]** or **[>]** repeatedly to display the desired item. → **[SET]**
 - To stop printing, press **[STOP]**.
- 3 **[MENU]**

10.2 Specifications

- **Applicable lines:**
Public Switched Telephone Network
- **Document size:**
Max. 216 mm in width, Max. 600 mm in length
- **Effective scanning width:**
208 mm
- **Effective printing width:**
A4: 202 mm
- **Transmission speed*1:**
KX-FP205: Approx. 12 s/page (ECM-MMR)^{*2}
KX-FP215: Approx. 8 s/page (ECM-MMR)^{*2}
- **Scanning density:**
Horizontal: 8 pels/mm
Vertical: 3.85 lines/mm (standard resolution)
7.7 lines/mm (fine/photo resolution)
15.4 lines/mm (super fine resolution)
- **Photo resolution:**
64 levels
- **Scanner type:**
Contact Image Sensor
- **Printer type:**
Thermal Transfer on plain paper
- **Data compression system:**
Modified Huffman (MH), Modified READ (MR), Modified Modified READ (MMR)
- **Modem speed:**
KX-FP205: 9,600 / 7,200 / 4,800 / 2,400 bps; Automatic Fallback
KX-FP215: 14,400 / 12,000 / 9,600 / 7,200 / 4,800 / 2,400 bps; Automatic Fallback
- **Operating environment:**
5 °C – 35 °C, 20 % – 80 % RH (Relative Humidity)
- **Dimensions:**
Approx. height 106 mm × width 356 mm × depth 200 mm
- **Mass (Weight):**
Approx. 2.7 kg
- **Power consumption:**
Standby: Approx. 1.5 W
Transmission: Approx. 15 W
Reception: Approx. 40 W (When receiving a 20 % black document)
Copy: Approx. 40 W (When copying a 20 % black document)
Maximum: Approx. 135 W (When copying a 100 % black document)
- **Power supply:**
220 – 240 V AC, 50 Hz
- **Fax memory capacity*3:**
Transmission: Approx. 25 pages
Reception: Approx. 28 pages
(Based on the ITU-T No. 1 Test Chart in standard resolution.)

■ Voice memory capacity*4 (KX-FP215 only):

Approx. 18 minutes of recording time including greeting messages

- *1 Transmission speed depends on the contents of the pages, resolution, telephone line conditions and capability of the other party's machine.
- *2 Transmission speed is based on the ITU-T No. 1 Test Chart with original mode. If the capability of the other party's machine is inferior to your unit, the transmission time may be longer.
- *3 If an error occurs during fax reception, such as a paper jam or if the recording paper runs out, the fax and subsequent faxes will be retained in memory.
- *4 Recording time may be reduced by the calling party's background noise.

Note:

- The accuracy of the clock is approximately ± 60 seconds a month.

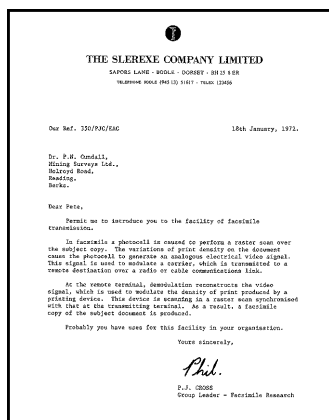
ITU-T No. 1 Test Chart**Note:**

- Design and specifications are subject to change without notice.
- The pictures and illustrations in these instructions may vary slightly from the actual product.

Recording paper specifications**Recording paper size:**

A4: 210 mm × 297 mm

Recording paper weight:

60 g/m² to 90 g/m²

Note for recording paper:

- Do not use the following types of paper:
 - Paper with cotton and/or fibre content that is over 20 %, such as letterhead paper or paper used for resumes
 - Extremely smooth or shiny paper, or paper that is highly textured
 - Coated, damaged or wrinkled paper
 - Paper with foreign objects attached, such as tabs or staples

- Paper which has dust, lint or oil stains
- Paper that will melt, vaporize, discolour, scorch or emit dangerous fumes near 200 °C, such as vellum paper. These materials may transfer onto the fusing roller and cause damage.
- Moist paper
- Some paper only accepts print on one side. Try using the other side of the paper if you are not happy with the print quality or if misfeeding occurs.
- For proper paper feeding and best print quality, we recommend using long-grained paper.
- Do not use paper of different types or thickness at the same time. This may cause paper jams.
- Avoid double-sided printing.
- Do not use paper printed from this unit for double-sided printing with other copiers or printers. This may cause paper jams.
- To avoid curling, do not open paper packs until you are ready to use the paper. Store unused paper in the original packaging, in a cool and dry location.

10.3 Condition of guarantee

1. This machine is supplied with a one year swap out warranty. Please retain your Proof of Purchase and Packaging in the unlikely event that your machine should require attention. For further information please contact us on 08701 580560 for UK or 01 6130082 for the Republic of Ireland, in addition you can visit our web site at www.panasonic.co.uk
2. This warranty is in addition to and does not in any way affect any statutory or other right of consumer purchasers. This warranty relates only to product used within Mainland Great Britain, please refer to your dealer warranty information relating to use elsewhere within the United Kingdom and Ireland.
3. This product is designed for use only on the United Kingdom and Ireland's Public Switched Telephone Network and should be used only for normal purposes and in accordance with standard operating instructions.
4. You should complete the registration form overleaf and fax it to us with 7 days of purchase; failure to do so may result in delays in providing warranty service.
5. This warranty covers breakdowns due to design or manufacturing faults; it does not apply to damage, however caused, wear or tear, neglect, incorrect adjustment or repair, or to any items of limited natural life.
6. This warranty does not cover consumables, i.e. ink films, film refills, ink cartridges, toner cartridges, drum units, paper and paper loads or any optional accessories which may have been purchased either at the same time as, or subsequent to, the main unit. Such accessories should be returned to the point of purchase if found to be faulty.
7. In the event of a failure, please take the following action;
 - a) Refer to the "Help" section of your instruction manual in order to identify and possibly correct the problem:
 - b) If the problem is not resolved after referring to the user guide, please contact our customer helpline on 08701 580560 for UK or 01 6130082 for the Republic of Ireland
8. In the event the helpline cannot resolve the problem, a like for like exchange fax will be despatched. The helpline operator will give you specific instructions on how the exchange will be executed. Failure to comply with these instructions may result in delay and cost to you.
9. The exchange fax will be delivered in a customised case by courier. It is the customer's responsibility to promptly remove the exchange fax and insert the faulty fax in the case provided for collection, to enable the courier to return it to Panasonic.
10. The exchange fax is to be regarded as a like for like exchange under warranty and the balance of the warranty period will transfer to the exchange unit. The purchaser's sole and exclusive remedy under this guarantee against Panasonic is for the repair or replacement of the appliance or any defective parts and no other remedy, including, but not limited to; incidental or consequential damage or loss of whatsoever nature shall be available to the purchaser.
11. Where the original fax is found to be faulty as a result of unauthorised repairs or modifications or damage either by accident, misuse or improper installation then Panasonic reserves the right to charge the customer a contribution towards repair costs.
12. If at any time during the guarantee period any parts of the appliance are replaced with parts not supplied or approved by us or of an objective quality, safe and suitable for the appliance, or has been dismantled or repaired by any person not authorised by us, we shall have the right to terminate this guarantee in whole or in part immediately without further notice.
13. This warranty applies to the original purchaser only and is not transferable.
14. The warranty period applicable to this product shall be 12 months from the date of purchase.

Please keep these Operating Instructions with your receipt.

Panasonic Business Systems U.K.

| | |
|--------------------------------------|------------------------|
| Receipt No. _____ | Date of Purchase _____ |
| Model No. KX-FP205E/KX-FP215E | Serial No. _____ |

11.1 Index

- # #01 Date and time: 16
- #02 Your logo: 17
- #03 Your fax number: 18
- #04 Sending report: 22
- #06 FAX ring count: 37
- #06 TAM ring count: 37
- #10 Caller's recording time: 37
- #11 Remote operation ID: 38
- #17 Ringer tone: 38
- #22 Automatic journal report: 22
- #23 Overseas mode: 39
- #25 Delayed send: 39
- #26 Automatic Caller ID list: 39
- #34 Quick scan: 22, 31
- #36 Receiving reduction: 40
- #39 LCD display contrast: 40
- #41 Fax activation code: 40
- #44 Memory reception alert: 41
- #46 Friendly reception: 41
- #47 Voice guidance: 41
- #49 Auto disconnection: 41
- #54 Greeting time: 41
- #58 Scan contrast: 41
- #67 Incoming message monitor: 41
- #68 ECM selection: 41
- #72 Recall time: 42
- #73 Manual answer mode: 42
- #76 Connecting tone: 42
- #77 Auto answer: 42
- #78 TEL/FAX ring count: 42
- #80 Set default: 43
- A** Accessories: 9
 - Paper support: 14
 - Paper tray: 13
 Advanced features: 39
 Auto answer setting (Feature #77): 42
 AUTO CALL. LIST: 56
 Auto disconnection (Feature #49): 41
 AUTO JOURNAL: 56
- B** Basic features: 37
 BROADCAST LIST: 56
 Broadcast transmission: 24
 Button description: 10
- C** Caller ID
 - Calling back: 21
 - Storing: 21
 CALLER ID LIST (Feature #26): 20, 56
 Caller's recording time (Feature #10): 37
 Character table: 17
 Cleaning: 54
 Connecting tone (Feature #76): 42
 Connections: 15
 Copy: 31
 - Collation: 31
 - Enlarge/Reduce: 31
- D** Date and time (Feature #01): 16
 Delayed transmission (Feature #25): 39
 Display
 - Contrast (Feature #39): 40
 - Error messages: 45
 Document size: 23
- E** ECM selection (Feature #68): 41
 Error messages: 44
 Extension telephone: 27
- F** Fax activation code (Feature #41): 40
 Fax number (Feature #03): 18
 FAX ONLY mode: 25, 27
 Friendly reception (Feature #46): 41
- G** Greeting message
 - TAM/FAX: 33
- I** Incoming message monitor (Feature #67): 41
 Ink film: 12
- J** Jams
 - Document: 53
 - Recording paper: 52
 JOURNAL REPORT (Feature #22): 22, 56
 Junk fax prohibitor: 29
- L** Listening to recorded messages: 34, 35
 Logo (Feature #02): 17
- M** Manual answer mode (Feature #73): 42
 Memo message: 34
- O** One touch: 19
 Overseas mode (Feature #23): 39
- P** Phonebook
 - Making a phone call: 19
 - Sending faxes: 23
 - Storing: 19
 PHONEBOOK LIST: 56
 Polling: 29
 Power failure: 51
 PRINTER TEST: 56
 Programming: 36
- Q** Quick scan (Feature #34): 22, 31
- R** Recall time (Feature #72): 42
 Receiving alert (Feature #44): 41
 Receiving faxes
 - Automatically: 27
 - Manually: 26
 Receiving reduction (Feature #36): 40
 Recording
 - Greeting message: 33
 - Memo message: 34
 Recording paper: 14, 57
 Recording time
 - Incoming message (Feature #10): 37
 - TAM/FAX greeting (Feature #54): 41
 Redialling: 22, 23
 Remote operation: 35
 Remote operation ID (Feature #11): 38
 Reports

11. Index

- Auto call.: 56
- Auto journal: 56
- Broadcast programming: 56
- Broadcast sending: 24
- Caller ID: 56
- Journal: 22, 56
- Phonebook: 56
- Power down: 51
- Printer test: 56
- Sending: 22
- Setup: 56
- Reset (Feature #80): 43
- Resolution: 22, 31
- Ring count
 - FAX ONLY (Feature #06): 37
 - TAM/FAX (Feature #06): 37
 - TEL/FAX (Feature #78): 42
- Ringer tone (Feature #17): 38
- S** Scan contrast (Feature #58): 41
- Sending faxes
 - Broadcast: 24
 - From memory: 22
 - Manually: 22
 - One touch: 23
 - Phonebook: 23
- Sending report (Feature #04): 22
- SETUP LIST: 56
- Storing
 - Broadcast: 24
 - One touch: 19
 - Phonebook: 19
- T** TAM/FAX mode: 25, 28
- TEL/FAX ring setting (Feature #78): 42
- TEL mode: 25, 26
- Toll saver: 28
- V** Voice guidance (Feature #47): 41
- Voice time/day stamp: 34
- Volume: 16

Notes

Notes

Notes

CE 0682

Sales Department:

Panasonic Business Systems U.K.

Panasonic House, Willoughby Road, Bracknell, Berkshire, RG12 8FP

Manufacturer:

Panasonic Communications (Malaysia) Sdn. Bhd.

PLO No.1, Kawasan Perindustrian Senai, KB No. 104, 81400 Senai, Negeri Johor Darul Ta'zim, Malaysia

Global web site:

<http://panasonic.net>



FP205E

PFQX2485ZA CM0406CK0