

KX-TG7100

SMS

Panasonic

Operating Instructions

Digital Cordless Phone

Model No. **KX-TG7100FX**

KX-TG7102FX

Digital Cordless Answering System

Model No. **KX-TG7120FX**



This unit is compatible with Caller ID and SMS. To use these features, you must subscribe to the appropriate service of your service provider/telephone company.

Charge the batteries for about 7 hours before initial use.

Please read these operating instructions before using the unit and save them for future reference.

To use this product in Czech or Slovakia, change the unit's region setting (page 20) to match your country. Change the unit's display language as needed (page 10).

(For Czech and Slovakia)

This cordless telephone is possible to use according to General licence No.: VO-R/8/08.2005-23 (for Czech), VPR-7/2001 (for Slovakia).

Introduction

Introduction

Thank you for purchasing a new Panasonic digital cordless phone.

For your future reference

Attach or keep original receipt to assist with any repair under warranty.

Serial No. (found on the bottom of the base unit)

Date of purchase

Name and address of dealer

Note:

- In the event of problems, you should contact your equipment supplier in the first instance.

Declaration of Conformity:

- Panasonic Communications Co., Ltd. declares that this equipment is in compliance with the essential requirements and other relevant provisions of Radio & Telecommunications Terminal Equipment (R&TTE) Directive 1999/5/EC.

Declarations of Conformity for the relevant Panasonic products described in this manual are available for download by visiting:

<http://www.doc.panasonic.de>

Contact:

Panasonic Services Europe
a Division of Panasonic Marketing Europe GmbH
Panasonic Testing Centre
Winsbergring 15, 22525 Hamburg, Germany

Your phone

KX-TG7100/KX-TG7120



*The pictured model is KX-TG7100.

KX-TG7102

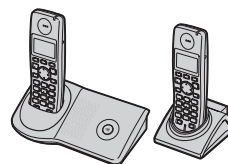

- References in these operating instructions to the charger and multiple handsets are for KX-TG7102 users only.

Note:

- The handsets have been pre-registered for use with their base unit. If not registered, see page 32.

Table of Contents

Preparation

Accessory information 4
 Important information 5
 Controls 6
 Displays 7
 Connections 8
 Battery installation/replacement 8
 Battery charge 9
 Turning the power on/off. 10
 Symbols used in these operating instructions 10
 Region settings. 10
 Display language 10
 Dialling mode (tone/pulse) 11
 Date and time 11

Making/Answering Calls

Making calls 12
 Answering calls 13

Phonebook

Handset phonebook 14
 Chain dial 15

Handset Settings

Handset settings. 16
 Time settings 18

Base Unit Settings

Base unit settings 19
 Call options. 20

Caller ID Service

Using Caller ID service 21
 Caller list. 21
 Voice mail service. 22

SMS (Short Message Service)

Using SMS (Short Message Service). . . 23
 Turning SMS on/off 23
 Storing/changing SMS message centre numbers 23
 Sending a message 23
 Receiving a message. 24
 SMS settings 25

Answering System Features (KX-TG7120 only)

Answering system 27
 Turning the answering system on/off . . 27
 Greeting message 27
 Listening to messages 28
 Direct command operation using the handset 29
 Remote operation. 29
 Answering system settings. 30

Multi-unit Operation

Operating additional units 32
 Registering a handset to the base unit. . 32
 Intercom between handsets. 33
 Transferring calls between handsets . . 33
 Conference calls 34
 Copying phonebook entries 34

Useful Information

Character entry 35
 Error messages 38
 Troubleshooting 38
 Specifications 43
 Conditions for usage (For Czech) 44
 Declaration of conformity form (For Czech and Slovakia). 45

Index

Index 47

Preparation

Accessory information

Included accessories

No.	Accessory items	Quantity	
		KX-TG7100 KX-TG7120	KX-TG7102
①	AC adaptor for base unit (Part No. PQLV207CE)	1	1
②	Telephone line cord	1	1
③	Rechargeable batteries AAA (R03) size (Part No. HHR-55AAAB or HHR-4EPT)	2	4
④	Handset cover ^{*1}	1	2
⑤	Charger (Part No. PQLV30045)	—	1
⑥	AC adaptor for charger (Part No. PQLV209CE)	—	1

*1 The handset cover comes attached to the handset.

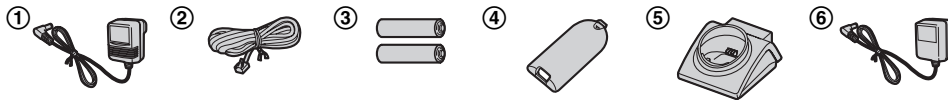

Additional/replacement accessories

Please contact your nearest Panasonic dealer for sales information.

No.	Model No.	Description
①	KX-TGA711FX	Additional Digital Cordless Handset
②	KX-TCA717EX	Wall-Mounting Adaptor
③	KX-TCA718EX	Belt Clip
④	KX-A272	DECT repeater



Note:

- When replacing the batteries, use only 2 rechargeable AAA (R03) size nickel metal hydride (Ni-MH) batteries of capacity up to 750 mAh. We recommend using Panasonic rechargeable batteries (Model No. P03P).
- We cannot be responsible for any damage to the unit or degradation of performance which may occur from using non-Panasonic rechargeable batteries.

Preparation

Important information

General

- Use only the AC adaptor included with this product, noted on page 4.
- Do not connect the AC adaptor to any AC outlet other than a standard 220–240 V AC outlet.
- This product is unable to make calls when:
 - the portable handset battery(ies) need recharging or have failed.
 - there is a power failure.
- Do not open the base unit, charger, or handset other than to replace the battery(ies).
- This product should not be used near emergency/intensive care medical equipment and should not be used by people with pacemakers.
- Care should be taken that objects do not fall onto, and liquids are not spilled into, the unit. Do not subject this product to excessive smoke, dust, mechanical vibration or shock.

Environment

- Do not use this product near water.
- This product should be kept away from heat sources such as radiators, cookers, etc. It should also not be placed in rooms where the temperature is less than 5 °C or greater than 40 °C.
- The AC adaptor is used as the main disconnect device. Ensure that the AC outlet is installed near the unit and is easily accessible.

Warning:

- To prevent the risk of electrical shock, do not expose this product to rain or any other type of moisture.
- Unplug this unit from power outlets if it emits smoke, an abnormal smell or makes

unusual noise. These conditions can cause fire or electric shock. Confirm that smoke has stopped and contact an authorised service centre.

Battery caution

- We recommend using the battery(ies) noted on page 4. **Use only rechargeable battery(ies).**
- Do not mix old and new batteries.
- Do not dispose of the battery(ies) in a fire, as they may explode. Check local waste management codes for special disposal instructions.
- Do not open or mutilate the battery(ies). Released electrolyte from the battery(ies) is corrosive and may cause burns or injury to the eyes or skin. The electrolyte may be toxic if swallowed.
- Exercise care when handling the battery(ies). Do not allow conductive materials such as rings, bracelets or keys to touch the battery(ies), otherwise a short circuit may cause the battery(ies) and/or the conductive material to overheat and cause burns.
- Charge the battery(ies) in accordance with the information provided in these operating instructions.
- Only use the included base unit (or charger) to charge the battery(ies). Do not tamper with the base unit (or charger). Failure to follow these instructions may cause the battery(ies) to swell or explode.

Information on Disposal for Users of Waste Electrical & Electronic Equipment (private households)



Preparation

This symbol on the products and/or accompanying documents means that used electrical and electronic products should not be mixed with general household waste. For proper treatment, recovery and recycling, please take these products to designated collection points, where they will be accepted on a free of charge basis. Alternatively, in some countries you may be able to return your products to your local retailer upon the purchase of an equivalent new product.

Disposing of this product correctly will help to save valuable resources and prevent any potential negative effects on human health and the environment which could otherwise arise from inappropriate waste handling. Please contact your local authority for further details of your nearest designated collection point.

Penalties may be applicable for incorrect disposal of this waste, in accordance with national legislation.

For business users in the European Union

If you wish to discard electrical and electronic equipment, please contact your dealer or supplier for further information.

Information on Disposal in other Countries outside the European Union

This symbol is only valid in the European Union.

If you wish to discard this product, please contact your local authorities or dealer and ask for the correct method of disposal.

Controls

Handset

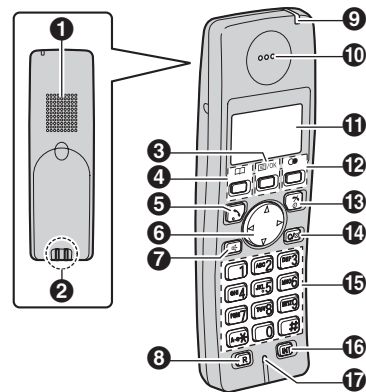

- 1 Speaker
- 2 Charge contact
- 3 [≡/OK] (Menu/OK)
- 4 [☎] (Phonebook)
- 5 [↵] (Talk)
- 6 Navigator key ([↑]/[↓]/[←]/[→])
- 7 [☎] (Speakerphone)
- 8 [R] (Recall)
- 9 Charge indicator/Ringer indicator/
Message indicator
- 10 Receiver
- 11 Display
- 12 [⏮] (Redial/Pause)
- 13 [⏻] (Off/Power)
- 14 [C/⊗] (Clear/Mute)
- 15 Dial keypad
- 16 [INT] (Intercom)
- 17 Microphone

Preparation

Base unit (KX-TG7100/KX-TG7102)

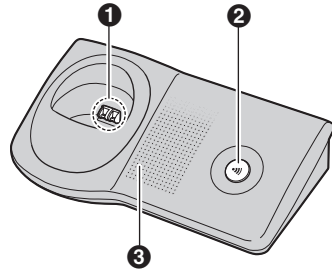

- 1 Charge contact
- 2 [ⓘ] (Page)
- 3 Ringer

Base unit (KX-TG7120)

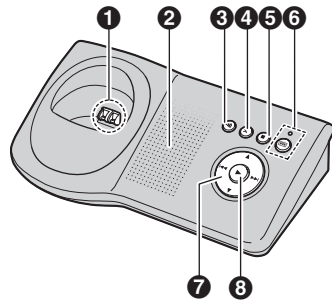

- 1 Charge contact
- 2 Speaker
- 3 [ⓘ] (Page)
- 4 [X] (Erase)
- 5 [■] (Stop)
- 6 Answer on indicator/[Ⓜ] (Answer on)
- 7 Navigator key: [▲]/[▼]/[◀]/[▶]
- 8 [▶] (Play)/Message indicator

Displays

Display icons

Display icon	Meaning
Ⓜ	Within range of a base unit <ul style="list-style-type: none"> ● When flashing: Handset is searching for base unit. (out of range of base unit, handset is not registered to base unit, no power on base unit)
Ⓜ	Handset is accessing base unit. (intercom, paging, changing base unit settings, etc.)
☎	Handset is on an outside call.
Ⓜ	Answering system is on.* ¹ (page 27)
Ⓜ	Battery strength
[2]	Handset number (Standby display setting, page 16)
✉	New SMS message received* ² (page 24)
[IN USE]	<ul style="list-style-type: none"> ● Line is being used by another handset. ● Answering system is being used by another handset or the base unit.*¹

*1 KX-TG7120 only

*2 SMS users only

Preparation

Connections

Base unit

When connecting the AC adaptor to the base unit, a short beep will be heard. If it is not heard, check the connections.

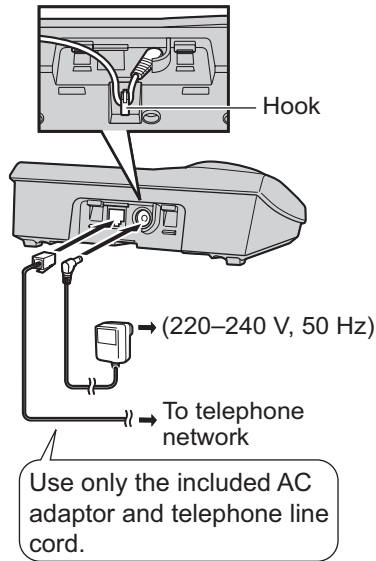

Charger (KX-TG7102 only)

Connect the AC adaptor to the charger and route the cable as shown. The charger can be mounted on the wall, if required.

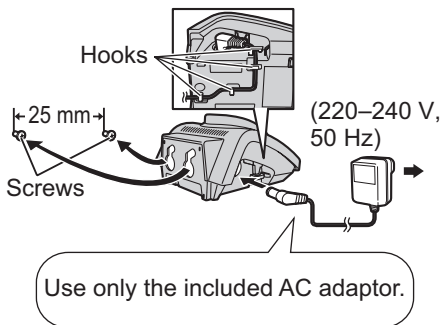

Note:

- Never install telephone wiring during a lightning storm.
- The AC adaptor must remain connected at all times. (It is normal for the adaptor to feel warm during use.)
- The AC adaptor should be connected to a vertically oriented or floor-mounted AC outlet. Do not connect the AC adaptor to a ceiling-mounted AC outlet, as the weight of the adaptor may cause it to become disconnected.

Location

- For maximum distance and noise-free operation, place your base unit:
 - away from electrical appliances such as TVs, radios, personal computers or other phones.
 - in a convenient, high and central location.

Battery installation/replacement

Important:

- Use only the included rechargeable batteries noted on page 4, 5.
 - When replacing batteries, we recommend using the Panasonic rechargeable batteries noted on page 4, 5.
- 1 Press the notch on the handset cover firmly and slide it in the direction of the arrow.

Preparation

- When replacing batteries, remove the old batteries positive (+) terminal first.

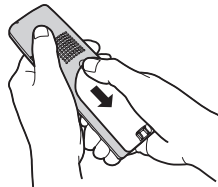

- 2 Insert the batteries negative (-) terminal first. Close the handset cover.

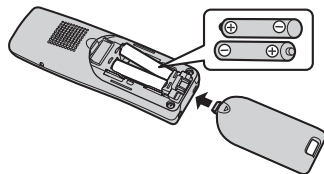

Battery charge

Place the handset on the base unit or charger for about 7 hours before initial use.

When charging, the battery icon is shown as follows.



When the batteries are fully charged,  remains on the display.

- The charge indicator lights up when the handset is placed on the base unit or charger.

Base unit*1

Charger*2

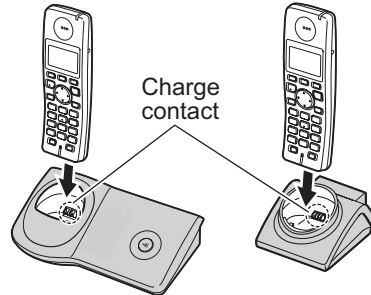



*1 The pictured model is KX-TG7100.

*2 KX-TG7102 only

Note:

- It is normal for the handset to feel warm during charging.
- If you want to use the unit immediately, charge the batteries for at least 15 minutes.
- Clean the charge contacts of the handset, base unit, and charger with a soft, dry cloth once a month, otherwise the batteries may not charge properly. Clean more often if the unit is exposed to grease, dust or high humidity.

Battery strength

Battery icon	Battery strength
	High
	Medium
	Low When flashing: Needs to be charged.

Panasonic Ni-MH battery performance (included batteries)

Operation	Operating time
In continuous use	17 hours max.
In continuous standby mode	180 hours max.

Preparation

Note:

- It is normal for batteries not to reach full capacity at the initial charge. Maximum battery performance is reached after a few complete cycles of charge/discharge (use).
- Actual battery performance depends on a combination of how often the handset is in use and how often it is not in use (standby).
- Battery operating time may be shortened over time depending on usage conditions and ambient temperature.
- Even after the handset is fully charged, the handset can be left on the base unit or charger without any ill effect on the batteries.
- The battery strength may not be displayed correctly after you replace the batteries. In this case, place the handset on the base unit or charger and charge for at least 7 hours.

Turning the power on/off

Power on

Press **[*][0]** for about 1 second.

Power off

Press **[*][0]** for about 2 seconds.

Symbols used in these operating instructions

Symbol	Meaning
[OK]	Press [OK] .
→	Proceed to the next operation.

Symbol	Meaning
" "	Select the words in quotations shown on the display (e.g., "Handset Setup") by pressing [▲] or [▼] .

Region settings

You can set the unit to use settings that match your country (page 20). The display language and other settings will change accordingly.

Note:

- The display language only changes (to the selected country's default setting) for the handset used to select the region setting. You must change the display language for all other handsets separately.

Display language

16 display languages are available.

You can select "Deutsch", "English", "Magyar", "Polski", "slovensky", "Čeština", "Hrvatski", "Slovenscina", "Eesti", "LIETUVIŠKAI", "Latviešu", "Română", "БЪЛГАРСКИ", "Srpski", "МАКЕДОНСКИ", or "Shqiptar".

- 1 **[OK]**
- 2 Press **[▲]** or **[▼]** to select **"Handset Setup"**. → **[▶]**
- 3 Press **[▲]** or **[▼]** to select **"Display Setup"**. → **[▶]**
- 4 Press **[▲]** or **[▼]** to select **"Select Language"**. → **[▶]**
- 5 Press **[▲]** or **[▼]** to select the desired language. → **[▶]** → **[*][0]**

Preparation

Note:

- If you select a language you cannot read, press **[*][0]**, press **[≡/OK]**, press **[▲]** 3 times, press **[▶]**, press **[▼]** 2 times, press **[▶]**, press **[▼]**, press **[▶]**, select the desired language, press **[▶]**, then press **[*][0]**.

Dialling mode (tone/pulse)

Changing the dialling mode depending on your telephone line service.

“**Tone**”: Select when you have a touch tone service.

“**Pulse**”: Select when you have rotary or pulse service.

- 1 **[≡/OK]**
- 2 Press **[▲]** or **[▼]** to select “**Base Unit Setup**”. → **[▶]**
- 3 Press **[▲]** or **[▼]** to select “**Call Options**”. → **[▶]**
- 4 Press **[▲]** or **[▼]** to select “**Dial Mode**”. → **[▶]**
- 5 Press **[▲]** or **[▼]** to select the desired setting. → **[▶]** → **[*][0]**

Date and time

- 1 **[≡/OK]**
- 2 Press **[▲]** or **[▼]** to select “**Handset Setup**”. → **[▶]**
- 3 Press **[▲]** or **[▼]** to select “**Time Settings**”. → **[▶]** → Press **[▲]** or **[▼]** to select “**Set Date & Time**”. → **[▶]**
- 4 Enter the current day, month, and year.
Example: 17 May, 2006
[1][7] [0][5] [0][6]
- 5 Enter the current hour and minute.

Example: 3:30 PM

[0][3] [3][0] → Press **[*]** until “03:30 PM” is displayed.

6 **[≡/OK]** → **[*][0]**

Note:

- To correct a digit, press **[◀]** or **[▶]** to move the cursor, then make the correction.
- The date and time may be incorrect after a power failure. In this case, set the date and time again.

Making/Answering Calls

Making calls

- 1 Lift the handset and dial the phone number.
 - To correct a digit, press **[C/⊗]**, then enter the correct number.
- 2 **[↶]**
- 3 When finished talking, press **[⊗]** or place the handset on the base unit or charger.

Speakerphone

- 1 During a conversation, press **[⊗]** to turn on the speakerphone.
 - Speak alternately with the caller.
- 2 When finished talking, press **[⊗]**.

Note:

- For best performance, use the speakerphone in a quiet environment.
- To switch back to the receiver, press **[↶]**.

To adjust the receiver or speaker volume

Press **[▲]** or **[▼]** while on a call.

Redial feature

Previously dialled phone numbers (each 24 digits max.) can be redialled.

To make a call using the redial list

The last 10 phone numbers dialled are stored in the redial list.

- 1 **[⊗]**
- 2 Press **[▲]** or **[▼]** to select the desired number.
- 3 **[↶]** / **[⊗]**

To erase numbers in the redial list

- 1 **[⊗]**
- 2 Press **[▲]** or **[▼]** to select the desired number. → **[▶]**

- 3 “Erase” → **[▶]**

- 4 “Yes” → **[▶]** → **[⊗]**

Other features

Mute

While mute is turned on, you will be able to hear the other party, but the other party will not be able to hear you.

To mute your voice, press **[C/⊗]**.

- To return to the conversation, press **[C/⊗]** again.

R button (to use the recall feature)

[R] is used to access optional telephone services. Contact your service provider/telephone company for details.

Note:

- If your unit is connected to a PBX (private branch exchange), pressing **[R]** can allow you to access certain features of your host PBX such as transferring an extension call. Consult your PBX dealer for details.
- You can change the recall time (page 19).

Pause button (for PBX/long distance service users)

A pause is sometimes required when making calls using a PBX or long distance service.

Example: If you have to dial **[0]** before dialling outside numbers manually, you will probably need to pause after dialling **[0]** until you hear a dial tone.

- 1 **[0]** → **[⊗]**

- 2 Dial the phone number. → **[↶]** / **[⊗]**

Note:

- A 3 second pause is inserted each time **[⊗]** is pressed. Press repeatedly to insert longer pauses.

Making/Answering Calls

Temporary tone dialling (for rotary or pulse service users)

You can temporarily switch the dialling mode to tone when you need to access touch tone services (e.g., telephone banking services).

- 1 Make a call.
- 2 Press **[*]** when prompted to enter your code or PIN, then press the appropriate dial keys.

Note:

- The dialling mode will return to pulse when you hang up.

Answering calls

- 1 Lift the handset and press **[📞]** or **[📞]** when the unit rings.
 - You can also answer a call by pressing any dial key from **[0]** to **[9]**, **[*]**, **[#]**, or **[INT]**. (**Any key answer feature**)
- 2 When finished talking, press **[📞]** or place the handset on the base unit or charger.

Auto talk feature

You can answer calls simply by lifting the handset off the base unit or charger. You do not need to press **[📞]**. To turn this feature on, see page 16.

To adjust the handset ringer volume when receiving a call

Press **[▲]** or **[▼]**.

Handset locator

Using this feature, you can locate the handset if it has been misplaced.

- 1 Press **[📞]** on the base unit.
- 2 To stop paging, press **[📞]** on the base unit or press **[📞]** on the handset.

Phonebook

Handset phonebook

The handset phonebook allows you to make calls without having to dial manually. You can add 50 names and phone numbers to the handset phonebook.

Adding entries to the handset phonebook

- 1 [] → []/OK
- 2 "New Entry" → [▶]
- 3 Enter the party's name (16 characters max.; page 35). → []/OK
- 4 Enter the party's phone number (24 digits max.). → []/OK
- 5 "Save" → [▶] → [✕⓪]

Note:

- Step 1 variation:
[]/OK → Press [▲] or [▼] to select "Ph. Book Setup". → [▶]

Finding and calling a handset phonebook entry

Handset phonebook entries can be searched for by first character or by scrolling through all handset phonebook entries. When you have found the desired entry, press [↶].

Scrolling through all entries

- 1 []
- 2 Press [▲] or [▼] to display the desired entry.

Searching by first character (index search)

- 1 []
- 2 Press the dial key ([0] to [9]) which contains the character you are searching for (page 35).

- Press the same dial key repeatedly to display the first entry corresponding to each letter located on that dial key.
- If there is no entry corresponding to the letter you selected, the next entry will be displayed.
- To change the character entry mode:
[●] → Select the character entry mode. → [▶]

- 3 Press [▲] or [▼] to scroll through the phonebook if necessary.

Editing entries in the handset phonebook

Changing a name, phone number

- 1 Find the desired entry (page 14). → []/OK
- 2 "Edit" → [▶]
- 3 Edit the name if necessary (16 characters max.; page 35). → []/OK
- 4 Edit the phone number if necessary (24 digits max.). → []/OK
- 5 "Save" → [▶] → [✕⓪]

Erasing entries from the handset phonebook

Erasing an entry

- 1 Find the desired entry (page 14). → []/OK
- 2 "Erase" → [▶]
- 3 "Yes" → [▶] → [✕⓪]

Erasing all entries

- 1 [] → []/OK
- 2 "Erase All" → [▶]
- 3 "Yes" → [▶]
- 4 "Yes" → [▶] → [✕⓪]

Chain dial

This feature allows you to dial phone numbers in the handset phonebook while you are on a call. This feature can be used, for example, to dial a calling card access number or bank account PIN that you have stored in the handset phonebook, without having to dial manually.

- 1** While on a call, press [□].
- 2** Press [▲] or [▼] to select the desired entry.
 - To search by first character (index search), see page 14.
- 3** Press [▶] to dial the number.

Handset Settings

Handset settings

- When customising the handset, the current item or setting is indicated by ►.

To customise the handset:

- 1 [☰/OK]
- 2 Press [▲] or [▼] to select "Handset Setup". → [►]
- 3 Press [▲] or [▼] to select the desired item in the handset settings menu. → [►]
- 4 Press [▲] or [▼] to select the desired item in the sub-menu. → [►]
- 5 Press [▲] or [▼] to select the desired setting then press [►] or follow the instruction in the "Feature" column of the chart.

- To exit the operation, press [✕⊙].

Handset settings menu	Sub-menu	Feature (default setting)
Time Settings	Set Date & Time	Date and time: page 11
	Alarm	Set the alarm: page 18
Ringer Setup	Ringer Volume	Handset ringer volume (<i>Maximum</i>) ^{*1}
	Ext. Ringtone	Ringtones for outside calls ("Ringtone 1") ^{*2}
	Int. Ringtone	Ringtones for intercom calls ("Ringtone 3") ^{*3}
Display Setup	Standby Display	Standby mode display ("Off") ^{*4}
	Select Language	Display language ("English") ^{*5} : page 10
	Contrast	Display contrast (<i>Level 3</i>)
Registration	Register H.set	page 32
Other Options	New Msg. Alert	New message alert ("Off") ^{*6}
	Keytones	Keytones on/off ("On")
	Auto Talk	Auto talk on/off ("Off") ^{*7}

Handset Settings

- *1 When the ringer is turned off, the handset will ring:
 - at the minimum level for alarm
 - at the minimum level for intercom calls
 - at the maximum level for paging
- *2 If you select one of the melody ringtones, the ringtone will continue to sound for several seconds if the caller hangs up before you answer. You may hear a dial tone or no one on the line when you answer a call.
The preset melodies in this product are used with permission of © 2004 M-ZoNE Co., Ltd.
- *3 The preset melodies in this product are used with permission of © 2004 M-ZoNE Co., Ltd.
- *4 If “**off**” is selected, only current date and time are displayed.
If “**Handset Number**” is selected and the current handset number is 2, “[2]” is displayed.
- *5 The default display language will be as follows if you select the following regional codes when changing the unit’s region setting (page 20):
 - “CZ”=“Čeština”
 - “SK”=“slovensky”
- *6 This feature alerts you when new messages have been received or recorded:
 - SMS (page 23)
 - Answering system (KX-TG7120 only; page 27)The message indicator on the handset flashes until you have read or listened to all new messages.
While message alert is on, battery operating time is shortened (page 9).
- *7 Auto talk feature allows you to answer calls simply by lifting the handset off the base unit or charger. You do not need to press [↶].

Handset Settings

Time settings

Alarm

An alarm will sound for 3 minutes at the set time once or daily. Set the date and time beforehand (page 11).

- 1 **[☰/OK]** → “Handset Setup” → **[▶]**
- 2 “Time Settings” → **[▶]**
- 3 “Alarm” → Press **[▶]** 2 times.
- 4 Select an alarm mode. → **[▶]**

Off	Turns alarm off. Press [▶] again, then press [✕⊙] to finish.
Once	The alarm sounds once at the set time. Enter the desired day and month.
Daily	An alarm sounds daily at the set time.

- 5 Enter the desired hour and minute. → **[☰/OK]**
- 6 Select the desired ringtone. → **[▶]**
- 7 “Save” → **[▶]** → **[✕⊙]**

Note:

- To stop the alarm, press any dial key.
- When in talk or intercom mode, the alarm will not sound until the call has ended.
- If you select “Once”, the setting will change to “off” after the alarm sounds.

Base Unit Settings

Base unit settings

- Use the handset to customise the base unit.
- When customising the base unit, the current item or setting is indicated by ▶.

To customise the base unit:

- 1 [≡/OK]
- 2 Press [▲] or [▼] to select “**Base Unit Setup**”. → [▶]
- 3 Press [▲] or [▼] to select the desired item in the base unit settings menu. → [▶]
- 4 Press [▲] or [▼] to select the desired item in the sub-menu. → [▶]
- 5 Press [▲] or [▼] to select the desired setting then press [▶] or follow the instruction in the “**Feature**” column of the chart.
 - To exit the operation, press [✕⊙].

Base unit settings menu	Sub-menu	Feature (default setting)
Ringer Volume	—	Base unit ringer volume (<i>Medium</i>)
Call Options	Dial Mode	(“ Tone ”): page 11
	Recall/Flash	Change the recall time*1 (“600 msec.”*2).
	Call Restrict	page 20
Other Options	Base Unit PIN	Change base unit PIN (“0000”).*3 – Enter the current 4-digit base unit PIN. → Enter the new 4-digit base unit PIN. → [≡/OK]
	Repeater Mode	(“ off ”): page 33
	Country	Change the unit’s region setting (“ EG ”): page 20

*1 Change the recall time, if necessary, depending on the requirements of your service provider/telephone company or PBX.

*2 The default setting will be as follows if you select the following regional codes when changing the unit’s region setting (page 20):

CZ=100 msec.

SK=100 msec.

*3 If you change the PIN, please make note of your new PIN. The unit will not reveal the PIN to you. If you forget your PIN, consult your nearest Panasonic service centre.

Base Unit Settings

Call options

Setting call restriction

You can restrict selected handsets from dialling certain numbers. You can assign up to 6 phone numbers to be restricted, and select which handsets will be restricted. Storing area codes here will prevent the restricted handsets from dialling any phone number in that area code.

- 1 **[M/OK]** → “Base Unit Setup” → **[▶]**
- 2 “Call Options” → **[▶]**
- 3 “Call Restrict” → **[▶]**
- 4 Enter the base unit PIN (default: “0000”).
- 5 Set which handsets will be restricted by pressing the desired handset number.
 - All the registered handset numbers will be displayed.
 - Flashing numbers indicate call restriction is turned on for the corresponding handset.
 - To turn call restriction off for a handset, press the number again. The number will stop flashing.
- 6 **[M/OK]**
- 7 Select a memory location. → **[▶]**
- 8 Enter the phone number or area code to be restricted (8 digits max.). → **[M/OK]** → **[*0]**
 - To erase a restricted number, press **[C/⊗]**.

Changing the unit's region setting/Resetting the base unit

- 1 **[M/OK]** → “Base Unit Setup” → **[▶]**
- 2 “Other Options” → **[▶]**

- 3 “Country” → **[▶]**

- 4 Select the desired country. → **[▶]**
 - “EG”=countries except Czech and Slovakia
 - “CZ”=Czech
 - “SK”=Slovakia

- 5 “yes” → **[M/OK]** → **[*0]**

Note:

- The following items will be deleted or reset to their default settings:
 - Settings listed on page 19, 25, 30
 - All SMS messages
 - Caller list
- The following items will be retained:
 - Date and time
 - Repeater mode
 - Recordings, including your greeting message and caller messages (KX-TG7120 only)
- If you select the desired country in step 4, the following default settings will be changed for the selected country's default settings:
 - Message centre 1 and 2 (page 25)
 - Recall time (page 19)
 - Language (page 16)
 - SMS on/off (page 25)
 - Language used for answering system announcements (KX-TG7120 only)
- After changing the unit's region setting/resetting the base unit, **Y** will flash on the handset momentarily. This is normal. The handset can be used once **Y** stops flashing.

Using Caller ID service

Important:

- This unit is Caller ID compatible. To use Caller ID features (such as displaying caller phone numbers), you must subscribe to Caller ID service. Consult your service provider/telephone company for details.

Caller ID features

When an outside call is received, the caller's phone number will be displayed.

- Phone numbers of the last 50 callers will be logged in the caller list.
- While listening to a message recorded by the answering system using the handset, you can call back the caller without having to dial the phone number (KX-TG7120 only; page 29).
- When caller information is received and it matches a phone number stored in the unit's phonebook, the stored name will be displayed and logged in the caller list.
- If the unit is connected to a PBX system, you may not receive the caller information.
- When the caller dialed from an area which does not provide Caller ID service, "Out of Area" will be displayed.
- When the caller requested not to send caller information, either no information or "Private Caller" will be displayed.

Missed calls

If a call is not answered, the unit treats the call as a missed call. The number of missed calls is shown on the display. This lets you know if you should view the caller list to see who called while you were out.

Caller list

Viewing the caller list and calling back

- 1 **[RECALL/OK]** → "Caller List" → **[▶]**
- 2 Press **[▼]** to search from the most recent call, or press **[▲]** to search from the oldest call.
 - If the item has already been viewed or answered, "✓" is displayed, even if it was viewed or answered using another handset.
- 3 **[↶] / [↷]**

Editing a caller's phone number before calling back

- 1 **[RECALL/OK]** → "Caller List" → **[▶]**
- 2 Press **[▲]** or **[▼]** to display the desired entry.
- 3 **[RECALL/OK]** → "Edit and Call" → **[▶]**
- 4 Edit the number.
 - Press dial key (**[0]** to **[9]**) to add, **[C/✕]** to delete.
- 5 **[↶] / [↷]**

Erasing caller information

- 1 **[RECALL/OK]** → "Caller List" → **[▶]**
- 2 Press **[▲]** or **[▼]** to display the desired entry. → **[RECALL/OK]**
- 3 "Erase" → **[▶]**
 - To erase all entries, select "Erase All". → **[▶]**
- 4 "Yes" → **[▶]** → **[↶⊙]**

Caller ID Service

Storing caller information into the handset phonebook

- 1 **[☰/OK]** → “Caller List” → **[▶]**
- 2 Press **[▲]** or **[▼]** to display the desired entry. → **[☰/OK]**
- 3 “Add Phonebook” → **[▶]**
- 4 Continue from step 3, “Adding entries to the handset phonebook”, page 14.

Voice mail service

Voice mail is an automatic answering service offered by your service provider/telephone company. If you subscribe to this service, your service provider/telephone company's voice mail system will answer calls for you when you are unavailable to answer the phone or when your line is busy. Messages are recorded by your service provider/telephone company, not your telephone. Please consult your service provider/telephone company for details of this service.

Note:

- For more information on using the unit's answering system and your service provider/telephone company's voice mail service, see page 31. (KX-TG7120 only)

SMS (Short Message Service)

Using SMS (Short Message Service)

SMS allows you to send and receive text messages between other fixed-line and mobile phones that support compatible SMS networks and features.

Important:

- To use SMS features, you must:
 - subscribe to the Caller ID and/or appropriate service
 - confirm SMS is turned on
 - confirm the correct message centre numbers are stored

Consult your service provider/telephone company for details and availability.

Note:

- A total of 47 messages (at 160 characters/message) can be saved. Total number may be more than 47 if length of messages is less than 160 characters/message.
- If the unit is connected to a PBX system, you may not be able to use SMS features.

Turning SMS on/off

- 1 [≡/OK] → "SMS" → [▶]
- 2 "Settings" → [▶]
- 3 "SMS On/Off" → [▶]
- 4 "On" or "Off" → [▶] → [↻⊙]

Storing/changing SMS message centre numbers

SMS message centre telephone numbers must be stored in order to send and receive SMS messages.

For Czech:

The message centre numbers (used for SMS services provided by Czech Telecom) are preprogrammed in this unit. You can change them if necessary.

For Slovakia:

The message centre numbers (used for SMS service provided by Slovak Telecom) are preprogrammed in this unit. You can change them if necessary.

- Consult your service provider/telephone company for more information.
- 1 [≡/OK] → "SMS" → [▶]
 - 2 "Settings" → [▶]
 - 3 "Message Centre1" or "Message Centre2" → [▶]
 - 4 Enter/edit the number as necessary. → [≡/OK]
 - 5 "Save" → [▶] → [↻⊙]

Note:

- If your phone is connected to a PBX, you need to add the PBX line access number and a dialling pause to the beginning of the Message Centre 1 phone number.

(For Czech and Slovakia only)

For Message Centre 2, store the Message Centre 1 phone number as is, without adding a line access number or dialling pause.

Sending a message

Writing and sending a new message

- 1 [≡/OK] → "SMS" → [▶]
- 2 "Create" → [▶]
- 3 Enter the message (page 35). → [≡/OK]
- 4 Enter the destination phone number (20 digits max.). → [≡/OK]

SMS (Short Message Service)

- Using the handset phonebook:
 [☐] → Select the handset phonebook entry. → [☐/OK] 2 times
 - Using the caller list:
 Press [▲] or [▼] to select the party.
 → [☐/OK] 2 times
 - Using the redial list:
 Press [●] repeatedly to select the phone number. → [☐/OK] 2 times
- 5 To save the message, select "Yes". → [▶]
 - 6 To send the message, press [▶].
 - To cancel sending, press [✕].

Note:

- This unit supports SMS messages of up to 612 characters, however, the maximum number of characters you can send or receive may be limited by your SMS service provider/telephone company. Consult your SMS service provider/telephone company for details.
- If your message contains over 160 characters, the message is a long message and "**Long Message**" is displayed. Your service provider/telephone company may treat long messages differently from other messages. Consult your service provider/telephone company for details.
- If your phone is connected to a PBX, store the PBX line access number (page 25).

Sending a saved message

- 1 [☐/OK] → "SMS" → [▶]
- 2 "Send List" → [▶]
- 3 To read a saved message, press [▲] or [▼] to select the message. → [☐/OK]
- 4 To send the message, press [☐/OK]. → "Send" → [▶]
- 5 Press and hold [C/✕] to erase all numbers, then continue from step 4,

"Writing and sending a new message", page 23.

Editing and sending a saved message

- 1 [☐/OK] → "SMS" → [▶]
- 2 "Send List" → [▶]
- 3 Press [▲] or [▼] to select the message. → [☐/OK]
- 4 [☐/OK] → "Edit Message" → [▶] → Continue from step 3, "Writing and sending a new message", page 23.

Erasing saved messages

- 1 [☐/OK] → "SMS" → [▶]
- 2 "Send List" → [▶]
- 3 Press [▲] or [▼] to select the message. → [☐/OK]
- 4 [☐/OK] → "Erase" → [▶]
 - To erase all messages, select "Erase All". → [▶]
- 5 "Yes" → [▶] → [✕]

Receiving a message

When an SMS message is received:

- a tone is heard (if the handset ringer is turned on)
- "Receiving SMS Message" is displayed
- ☒ is displayed
- the message indicator on the handset flashes if the message alert feature (page 16) has been turned on

Reading a received message

- 1 [☐/OK] → "SMS" → [▶]
- 2 "Receive List" → [▶]

SMS (Short Message Service)

- 3 Press **[▲]** or **[▼]** to select a message.
 - Messages which have already been read are indicated by a “✓”, even if they were read using another handset.
- 4 Press **[☰/OK]** to read the message content.

Note:

- To call the message sender, press **[↶]** or **[☎]**.

Replying to a message

- 1 While reading a received message, press **[☰/OK]**.
- 2 **“Reply”** → **[▶]**
- 3 Enter a message (page 35). → **[☰/OK]**
- 4 Edit the destination phone number and/or press **[☰/OK]**.
- 5 Continue from step 5, “Writing and sending a new message”, page 23.

Editing/forwarding a message

- 1 While reading a received message, press **[☰/OK]**.
- 2 **“Edit Message”** → **[▶]**
- 3 Continue from step 3, “Writing and sending a new message”, page 23.

Erasing received messages

- 1 While reading a received message, press **[☰/OK]**.
- 2 **“Erase”** → **[▶]**
 - To erase all messages, select **“Erase All”**. → **[▶]**
- 3 **“Yes”** → **[▶]** → **[✕⓪]**

Storing the sender’s number in the handset phonebook

- 1 While reading a received message, press **[☰/OK]**.
- 2 **“Add Phonebook”** → **[▶]**
- 3 Continue from step 3, “Adding entries to the handset phonebook”, page 14.

Editing the sender’s number before calling back

- 1 While reading a received message, press **[☰/OK]**.
- 2 **“Edit and Call”** → **[▶]**
- 3 Edit the number. → **[↶]** / **[☎]**

SMS settings

If the base unit is reset to its default settings (page 20), the following SMS-related settings will be reset. The contents of the receive and send lists will be erased.

SMS settings	Page
SMS on/off (default: “off”)*1	page 23
Message Centre 1	page 23
Message Centre 2	page 23
PBX line access number (default: “off”)	page 25

*1 If you set the unit’s region setting (page 20) to “CZ” or “SK”, the default setting is “On”.

Storing the PBX line access number (for PBX users only)

Store your PBX line access number (4 digits max.) so that SMS messages are sent properly. When sending SMS messages to entries in the handset phonebook or redial

SMS (Short Message Service)

list, the PBX line access number will be deleted.

- 1** [≡/OK] → "SMS" → [▶]
- 2** "Settings" → [▶]
- 3** "PBX Access No." → [▶]
- 4** "On" → [▶]
- 5** Enter your PBX line access code and a dialling pause, if necessary. → [≡/OK]
- 6** "Save" → [▶] → [↶⊙]

Answering System Features (KX-TG7120 only)

Answering system

The KX-TG7120 contains an answering system which can answer and record calls for you when you are unavailable to answer the phone.

Important:

- Only 1 person can access the answering system (listen to messages, record a greeting message, etc.) at a time.
- When callers leave messages, the unit records the day and time of each message. Make sure the date and time have been set (page 11).

Memory capacity

The total recording capacity (including your greeting message and caller messages) is about 17 minutes. A maximum of 64 messages can be recorded.

Note:

- If message memory becomes full:
 - “Answer Sys. Full” is shown on the handset display
 - the answer on indicator on the base unit flashes rapidly

Turning the answering system on/off

Using the base unit

Press **[☐]** to turn on/off the answering system.

- When the answering system is turned on, the answer on indicator lights up.

Using the handset

- 1 **[☐/OK]** → “Answer System” → **[▶]**

- 2 “Answer On” or “Answer Off” → **[▶]** → **[✕⊙]**

Note:

- When the answering system is turned on, **[☐]** is displayed.

Greeting message

When the unit answers a call, callers are greeted by a greeting message. You can record your own greeting message or use a prerecorded greeting message.

Recording a greeting message

You can record your own greeting message (50 seconds max.).

- 1 **[☐/OK]** → “Answer System” → **[▶]**
- 2 “Record Greeting” → **[▶]**
 - Hold the handset about 20 cm away and speak clearly into the microphone.
- 3 Press **[☐/OK]** to stop recording. → **[✕⊙]**

Using a prerecorded greeting message

If you erase or do not record your own greeting message, the unit will play a prerecorded greeting message for callers and ask them to leave messages. If the message recording time (page 31) is set to “Greeting Only”, caller messages will not be recorded and the unit will play a different prerecorded greeting message asking callers to call again.

Playing back the greeting message

- 1 **[☐/OK]** → “Answer System” → **[▶]**
- 2 “Play Greeting” → **[▶]** → **[✕⊙]**

Answering System Features (KX-TG7120 only)

Erasing the greeting message

If you erase your own greeting message, the unit will play a prerecorded greeting message for callers.

- 1 **[M]/OK** → “Answer System” → **[▶]**
- 2 “Erase Message” → **[▶]**
- 3 “Erase Greeting” → **[▶]**
- 4 “Yes” → **[▶]** → **[*]0**

Listening to messages

Messages are stored and played back chronologically, from oldest message to newest.

Listening to new/all messages

When you have new messages:

- **[▶]** on the base unit flashes
- the message indicator on the handset flashes if the message alert feature (page 16) has been turned on

Note:

- To adjust the speaker volume during playback, press **[▲]** or **[▼]**.

Using the base unit

Press **[▶]**.

- If new messages have been recorded, the base unit plays back new messages.
- If there are no new messages, the base unit plays back all messages.

Note:

- After playing back all of the new messages, **[▶]** will stop flashing but the answer on indicator will remain lit up when the answering system is turned on.

Using the handset

- 1 **[M]/OK** → “Answer System” → **[▶]**
- 2 “Play New Msg.” or “Play All Msg.” → **[▶]**

Repeating, skipping, stopping, erasing a message during playback

- To repeat a message during playback:
 - for the base unit, press **[◀◀]**
 - for the handset, press **[◀]**
 If pressed within the first 5 seconds of a message, the previous message will be played.
- To skip a message during playback:
 - for the base unit, press **[▶▶]**
 - for the handset, press **[▶]**
- To stop a message during playback:
 - for the base unit, press **[■]**
 - for the handset, press **[9]**
- To erase a message during playback:
 - for the base unit, press **[X]**
 - for the handset, press **[*]4**

Erasing all messages

Using the base unit

Press **[X]** 2 times.

Using the handset

- 1 **[M]/OK** → “Answer System” → **[▶]**
- 2 “Erase Message” → **[▶]**
- 3 “Erase All” → **[▶]**
- 4 “Yes” → **[▶]** → **[*]0**

Answering System Features (KX-TG7120 only)

Calling back (Caller ID subscribers only)

If caller information was received for the call, you can call the caller back while listening to a message.

- 1 Press **[M/OK]** during playback.
- 2 "Call Back" → **[▶]**

Editing the number before calling back

- 1 Press **[M/OK]** during playback.
- 2 "Edit and Call" → **[▶]**
- 3 Edit the number. → **[↶] / [↷]**

Direct command operation using the handset

You can operate the answering system by pressing dial keys, rather than navigating through the menus. To use the following commands, press **[M/OK]**. → "Answer System" → **[▶]**

Key	Direct commands
[1]	Repeat message (during playback) ^{*1}
[2]	Skip message (during playback)
[3]	Enter the "Settings" menu
[4]	Play new messages
[5]	Play all messages
[6]	Play greeting message
[7][6]	Record greeting message
[8]	Turn answering system on
[9]	Stop (recording, playback)
[0]	Turn answering system off
[*][4]	Erase this message (during playback)

Key	Direct commands
[*][5]	Erase all messages
[*][6]	Erase greeting message

*1 If pressed within the first 5 seconds of a message, the previous message will be played.

Remote operation

Using a touch tone phone, you can call your phone number from outside and access the unit to listen to messages or change answering system settings.

Important:

- In order to operate the answering system remotely, you must first turn on remote operation by setting a remote access code. This code must be entered each time you operate the answering system remotely.

Turning remote operation on

A 3-digit remote access code must be entered when operating the answering system remotely. This code prevents unauthorised parties from listening to your messages remotely. After you store your remote access code, remote operation is possible.

- 1 **[M/OK]** → "Answer System" → **[▶]**
- 2 "Settings" → **[▶]**
- 3 "Remote Code" → **[▶]**
- 4 To turn on remote operation, enter a 3-digit remote access code.
 - To turn off remote operation, press **[*]**.
- 5 **[M/OK]** → **[*][0]**

Answering System Features (KX-TG7120 only)

Note:

- If you have stored the remote access code, you can turn on answering system by calling the unit even when it is turned off.

Using the answering system remotely

- 1 Dial your phone number from a touch tone phone.
- 2 After the greeting message starts, enter your remote access code.
 - The unit will announce the number of new messages.
- 3 Enter remote commands.

Note:

- You can hang up at any time.
- If less than 5 minutes of recording time is available, the unit will announce the remaining recording time after the last message is played back.

Remote commands

Key	Remote command
[1]	Repeat message (during playback) ^{*1}
[2]	Skip message (during playback)
[4]	Play new messages
[5]	Play all messages
[6]	Play greeting message
[7]	Record greeting message
[9]	Stop (recording, playback)
[0]	Turn answering system off
[*][4]	Erase this message (during playback)
[*][5]	Erase all messages
[*][6]	Erase greeting message (during greeting message playback)

Key	Remote command
[*][#]	End remote operation (or hang up)

*1 If pressed within the first 5 seconds of a message, the previous message will be played.

Turning on the answering system remotely

If the answering system is off, you can turn it on remotely.

- 1 Dial your phone number from a touch tone phone.
- 2 Let the phone ring 9 times.
 - A long beep will be heard.
- 3 Enter your remote access code within 10 seconds after the long beep.
 - The greeting message is played back.
 - You can hang up, or enter your remote access code again and begin remote operation.

Answering system settings

If the base unit is reset to its default settings (page 20), the following answering system-related settings will be reset.

Answering system setting	Default setting	Page
Answering system on/off	Answer On	page 27
Remote access code	—	page 29
Number of rings	4 Rings	page 31
Caller's recording time	3 Minutes	page 31

Answering System Features (KX-TG7120 only)

Answering system setting	Default setting	Page
Call screening	On	page 31

Changing the number of rings

You can change the number of times the phone rings before the unit answers calls. You can select 2 to 6 rings, or "Auto". "Auto": The unit answers after 2 rings when new messages have been recorded, and after 5 rings when there are no new messages. If you call your phone from outside to listen to new messages (page 30), you will know that there are no new messages when the phone rings for the 3rd time. You can then hang up without being charged for the call.

- 1 [M]/OK → "Answer System" → [▶]
- 2 "Settings" → [▶]
- 3 "Number of Rings" → [▶]
- 4 Select the desired setting. → [▶] → [X⓪]

For voice mail service subscribers

Please note the following:

- To receive messages correctly with your voice mail service, we recommend that you do not use the unit's answering system. Make sure that the answering system is turned off (page 27).
- If you would rather use the unit's answering system than the voice mail service provided by your service provider/telephone company, ask your service provider/telephone company to deactivate your voice mail service. If your service provider/telephone company cannot do this, set this unit's "Number of Rings" setting so that this unit's answering system answers calls before your service provider/telephone

company's voice mail service tries to answer your calls. It is necessary to check the number of rings required to activate the voice mail service provided by your service provider/telephone company before changing this setting.

Selecting the caller's recording time

You can change the maximum message recording time allotted to each caller, or set the unit to greet callers but not record messages.

- 1 [M]/OK → "Answer System" → [▶]
- 2 "Settings" → [▶]
- 3 "Recording Time" → [▶]
- 4 Select the desired setting. → [▶] → [X⓪]

Turning call screening on/off

While a caller is leaving a message, you can screen the call through the handset speaker.

- 1 [M]/OK → "Answer System" → [▶]
- 2 "Settings" → [▶]
- 3 "Call Screening" → [▶]
- 4 "On" or "Off" → [▶] → [X⓪]

Multi-unit Operation

Operating additional units

Additional handsets

Up to 6 handsets can be registered to the base unit. Additional handsets will give you the freedom to, for example, have an intercom call with another handset while a third handset is on an outside call. See page 4 for information on ordering additional handsets.

Important:

- The additional handset model recommended for use with this unit is noted on page 4. If other model handset is used, certain operations (handset settings, base unit settings, etc.) may not be available.

Registering a handset to the base unit

The included handset and base unit are preregistered. If for some reason the handset is not registered to the base unit (for example, Ψ flashes even when the handset is near the base unit), register the handset manually (page 32).

To register an additional handset to the base unit (easy registration)

After purchasing an additional handset, register it to the base unit. Ensure that the additional handset is switched on. If it is not on, press and hold Ψ for few seconds to turn the handset on.

- 1 Lift the additional handset and press Ψ to put the handset in standby mode.
- 2 Press and hold Ψ on the base unit for about 3 seconds, until the registration tone sounds.

- 3 Place the additional handset on the base unit. The registration tone continues to sound. With the handset still on the base unit, wait until a confirmation tone sounds and Ψ stops flashing.

Note:

- If an error tone sounds, or if Ψ is still flashing, register the handset manually (manual registration; page 32).
- If all registered handsets start ringing in step 2, press Ψ to stop. Start again from step 1.
- Charge the batteries of your additional handset for about 7 hours before initial use.
- This registration method cannot be used for handsets that have already been registered to the base unit. Register the handset manually (manual registration; page 32).

To register a handset to the base unit (manual registration)

You can register a handset to the base unit manually using the following method.



- 1 Ψ → “Handset Setup” → Ψ
- 2 “Registration” → Ψ
- 3 “Register H.set” → Ψ
- 4 Press and hold Ψ on the base unit for about 3 seconds, until the registration tone sounds.
 - If all registered handsets start ringing, press Ψ to stop, then repeat this step.
 - After pressing Ψ , the rest of this procedure must be completed within 1 minute.
- 5 Wait until “Enter Base PIN” is displayed, then enter the base unit PIN (default: “0000”), then press Ψ .
 - When the handset has been registered successfully, Ψ will stop

Multi-unit Operation

flashing. If keytones are turned on (page 16), a confirmation tone will be heard.

Cancelling a handset

A maximum of 6 handsets can be registered to the base unit. A handset can cancel its own registration (or the registration of another handset) that is stored in the base unit. This will allow the base unit to "forget" the handset.

- 1 **[/OK]** → "Base Unit Setup" → **[▶]**
- 2 Enter "335".
- 3 "Cancel Handset" → **[▶]**
 - The numbers of all handsets registered to the base unit are displayed.
- 4 Select the handset(s) you want to cancel, by pressing the desired handset number. → **[/OK]**
 - The selected handset number(s) will flash.
 - To cancel a selected handset number, press the number again. The number will stop flashing.
- 5 "Yes" → **[▶]** → **[⓪]**



Increasing the range of the base unit

You can increase the signal range of the base unit by using a DECT repeater. Please use only the Panasonic DECT repeater noted on page 4. Consult your Panasonic dealer for details.



Important:

- Before registering the repeater to this base unit, you must turn the repeater mode on.
- Do not use more than one repeater at a time.

Setting the repeater mode

- 1 **[/OK]** → "Base Unit Setup" → **[▶]**
- 2 "Other Options" → **[▶]**
- 3 "Repeater Mode" → **[▶]**
- 4 "On" or "Off" → **[▶]** → **[⓪]**



Note:

- After turning repeater mode on or off,  will flash on the handset momentarily. This is normal. The handset can be used once  stops flashing.

Intercom between handsets

Intercom calls can be made between handsets.

Example: When handset 1 calls handset 2

- 1 **Handset 1:**
[INT] → Press **[2]** (desired handset number).
- 2 **Handset 2:**
Press **[]** / **[]** to answer.
- 3 When finished talking, press **[⓪]**.

Transferring calls between handsets

Outside calls can be transferred between 2 people.

Example: When handset 1 transfers a call to handset 2

- 1 **Handset 1:**
During an outside call, press **[INT]**. → Press **[2]** (desired handset number).
 - The outside call will be put on hold.
 - If there is no answer, press **[INT]** to return to the outside call.

Multi-unit Operation

2 Handset 2:

Press [↶] / [↷] to answer the page.

- Handset 2 can talk with handset 1.

3 Handset 1:

To complete the call transfer, press [↶].

Transferring a call without speaking to the other handset user

1 During an outside call, press [INT]. → Press the desired handset number.

- [INT] flashes to indicate the outside call is on hold.

2 [↶]

- The outside call rings at the other handset.

Note:

- If the other handset user does not answer the call within 1 minute, the call will ring at your handset again.

Conference calls

2 people can have a conference call with an outside party.

Example: When handset 1 transfers a call to handset 2

1 Handset 1:

During an outside call, press [INT]. → Press [2] (desired handset number).

- The outside call will be put on hold.
- If there is no answer, press [INT] to return to the outside call.

2 Handset 2:

Press [↶] / [↷] to answer the page.

- Handset 2 can talk with handset 1.

3 Handset 1:

To establish a conference call, press [3].

Copying phonebook entries

You can copy handset phonebook entries to the handset phonebook of another compatible Panasonic handset.

Copying one entry

1 Find the desired handset phonebook entry (page 14). → [≡/OK]

2 "Copy" → [▶]

3 Enter the handset number you wish to send the handset phonebook entry to.

- When an entry has been copied, "Completed" is displayed.
- To continue copying another entry: "Yes" → [▶] → Find the desired handset phonebook entry. → [▶]

4 [↶]

Copying all entries

1 [≡] → [≡/OK]

2 "Copy All" → [▶]

3 Enter the handset number you wish to send the handset phonebook entry to.

- When all entries have been copied, "Completed" is displayed.

4 [↶]

Useful Information

Character entry

The dial keys are used to enter characters and numbers. Each dial key has multiple characters assigned to it. The available character entry modes are Alphabet (ABC), Numeric (0-9), Greek (ABΓ), Extended 1 (AÄÅ), Extended 2 (ŠŠŠ), and Cyrillic (АБВ). For SMS messages, Alphabet (ABC), Numeric (0-9), Greek (ABΓ), and Extended (AÄÅ) modes are available. When in these entry modes except Numeric, you can select which character is entered by pressing a dial key repeatedly.

- Press [◀] or [▶] to move the cursor.
- Press dial keys to enter characters and numbers.
- Press [C/ⓧ] to erase the character or number highlighted by the cursor. Press and hold [C/ⓧ] to erase all characters or numbers.
- Press [↵] to switch between uppercase and lowercase.
- To enter another character located on the same dial key, press [▶] to move the cursor to the next space, then press the appropriate dial key.

Character entry modes

Several character entry modes can be used when entering text. The characters that can be entered depend on the entry mode.

Characters available in each character entry mode

When the unit displays the character entry screen:

[□] → Select a character entry mode. → [▶]

Note:

- For character entry when writing SMS messages, see page 37.

Alphabet character table (ABC)

0	1	ABC 2	DEF 3	GHI 4	JKL 5	MNO 6	PQRS 7	TUV 8	WXYZ 9
Space	Space #	A B C	D E F	G H I	J K L	M N O	P Q R S	T U V	W X Y Z
0	& ' () *	2	3	4	5	6	7	8	9
	, - . / 1	a b c	d e f	g h i	j k l	m n o	p q r s	t u v	w x y z
		2	3	4	5	6	7	8	9

Numeric entry table (0-9)

0	1	ABC 2	DEF 3	GHI 4	JKL 5	MNO 6	PQRS 7	TUV 8	WXYZ 9
0	1	2	3	4	5	6	7	8	9

Useful Information

Greek character table (ΑΒΓ)

0	1	ABC2	DEF3	GHI4	JKL5	MNO6	PQRS7	TUV8	WXYZ9
Space 0	Space # & ' () * , - . / 1	Α Β Γ 2	Δ Ε Ζ 3	Η Θ Ι 4	Κ Λ Μ 5	Ν Ξ Ο 6	Π Ρ Σ 7	Τ Υ Φ 8	Χ Ψ Ω Ξ 9

Extended 1 character table (ΑĂĂ)

0	1	ABC2	DEF3	GHI4	JKL5	MNO6	PQRS7	TUV8	WXYZ9
Space 0	Space # & ' () * , - . / 1	A Ă Ą Ă Ă Ą Ă Æ B C Ç 2	D Ę Ę É Ê Ë Ě F 3	G Ğ H İ İ İ İ Ĳ 4	J K L 5	M N Ń O Ö Ó ø 6	P Q R Ŕ Ş B 7	T Ŧ Ũ Ú Ū Ŭ Ů V 8	W Ŷ X Y ŷ Z 9
		a ă ą ą ă ą ą æ b c ç 2	d ę ę é ê ë ě f 3	g ǵ h ı ı ı ı ı ı ı 4	j k l 5	m n ń o ö ó ø 6	p q r ŕ ş b 7	t ŧ ũ ú ū ŭ ů v 8	w ŵ x y ŷ z 9

- The following are used for both uppercase and lowercase: ø Ş Ŧ Ũ Ū Ŭ Ů Ŷ ŷ

Extended 2 character table (ŠŚŠ)

0	1	ABC2	DEF3	GHI4	JKL5	MNO6	PQRS7	TUV8	WXYZ9
Space 0	Space # & ' () * , - . / 1	A Ā Ā Ą Ą Ą Ć Ć 2	D Ď Ď É Ě Ě F 3	G Ħ I Í 4	J K L Ł Ł Ł 5	M N Ń Ń Ń Ń Ŕ Ŕ 6	P Q R Ŕ Ŗ Š Š Š 7	T Ŧ U Ú Ū Ŭ Ů V 8	W X Y ŷ Ź Ž Ž 9
		a ā ą ą ą ą ą ą ą Ć Ć 2	d ě ě é ě ě f 3	g ħ i í 4	j k l ł ł ł ł 5	m n ń ń ń ń ŕ ŕ 6	p q r ŕ ř š š š 7	t ŧ u ú ū ŭ ů v 8	w x y ŷ ź ż ź 9

- The following are used for both uppercase and lowercase:

Ą Ć Ć Ě Ł Ł Ł Ń Ń Ń Ŗ Š Š Š ů ŷ Ž Ž Ž

Cyrillic character table (АБВ)

0	1	ABC2	DEF3	GHI4	JKL5	MNO6	PQRS7	TUV8	WXYZ9
Space 0	Space # & ' () * , - . / 1	А Б В Г 2	Д Е Ж З 3	И Й К Л 4	М Н О П 5	Р С Т У 6	Ф Х Ц Ч 7	Ш Щ Ъ Ъ 8	Ь Э Ю Я 9

Useful Information

When writing SMS messages

Alphabet character table (ABC)

0	1	ABC 2	DEF 3	GHI 4	JKL 5	MNO 6	PQRS 7	TUV 8	WXYZ 9
Space 0	Space . @ / : ; * # + - 1 " ' , ! ; ? ¿ - € £ \$ ¥ () [] { } & % \ ^ ~ < > = □ §	A B C 2	D E F 3	G H I 4	J K L 5	M N O 6	P Q R S 7	T U V 8	W X Y Z 9
		a b c 2	d e f 3	g h i 4	j k l 5	m n o 6	p q r s 7	t u v 8	w x y z 9

Numeric entry table (0-9)

0	1	ABC 2	DEF 3	GHI 4	JKL 5	MNO 6	PQRS 7	TUV 8	WXYZ 9
0	1	2	3	4	5	6	7	8	9

Greek character table (ΑΒΓ)

0	1	ABC 2	DEF 3	GHI 4	JKL 5	MNO 6	PQRS 7	TUV 8	WXYZ 9
Space 0	Space . @ / : ; * # + - 1 " ' , ! ; ? ¿ - € £ \$ ¥ () [] { } & % \ ^ ~ < > = □ §	A B Γ 2	Δ E Z 3	H Θ I 4	K Λ M 5	N Ξ O 6	Π Ρ Σ 7	T Υ Φ 8	X Ψ Ω 9

Extended character table (AÄÅ)

0	1	ABC 2	DEF 3	GHI 4	JKL 5	MNO 6	PQRS 7	TUV 8	WXYZ 9
Space 0	Space . @ / : ; * # + - 1 " ' , ! ; ? ¿ - € £ \$ ¥ () [] { } & % \ ^ ~ < > = □ §	A Ä Á 2	D E È 3	G Ğ 4	J K L 5	M N Ñ 6	P Q R S 7	T U Û 8	W X Y Z 9
		À Á Â 2	É Ê Ë 3	Ħ Ĩ Ī 4		Ō Ő Œ 6	Š Ÿ 7	Ú Û Ü 8	Ý Þ 9
		a à á 2	d e è 3	g ğ h 4	j k l 5	m n ñ 6	p q r s 7	t u ù 8	w x y z 9
		â ã ä 2	é ê ë 3	ï ï ï ï 4		ó ô ö 6	ß 7	ú û ü 8	ý þ 9
		å æ b 2	ë f 3	ĥ ĩ 4		ø ö ø 6		ü v 8	
		c ç 2							

- The following are used for both uppercase and lowercase: ø Š

Useful Information

Error messages

Error message	Cause & solution
Answer Sys. Full ^{*1}	<ul style="list-style-type: none"> • Erase unnecessary messages (page 28).
Error ^{*1}	<ul style="list-style-type: none"> • Recording was too short. Try again.
Failed	<ul style="list-style-type: none"> • Phonebook copy failed. Confirm the other handset (the receiver) is in standby mode and try again.
Incomplete	<ul style="list-style-type: none"> • The receiver's phonebook memory is full. Erase the unnecessary phonebook entries from the other handset (the receiver) and try again.
Invalid Number	<ul style="list-style-type: none"> • You tried to send an SMS message to a phone number saved in the handset phonebook, caller list, or redial list that is over 20 digits long.
Memory Full	<ul style="list-style-type: none"> • The handset's phonebook memory is full. Erase unnecessary entries (page 14). • Message memory becomes full. Erase unnecessary messages (page 28).^{*1}
SMS Full	<ul style="list-style-type: none"> • Erase unnecessary messages (page 24, 25).
You must first subscribe to Caller ID.	<ul style="list-style-type: none"> • You must subscribe to Caller ID service. Once you receive caller information after subscribing to Caller ID service, this message will not be displayed.

*1 KX-TG7120 only

Troubleshooting

If you still have difficulties after following the instructions in this section, disconnect the AC adaptor and turn off the handset, then reconnect the AC adaptor and turn on the handset.



Telephone

Problem	Cause & solution
Y is flashing.	<ul style="list-style-type: none"> • The handset is not registered to the base unit. Register it (page 32). • The handset is too far from the base unit. Move closer. • The AC adaptor is not connected. Check the connections. • You are using the handset or base unit in an area with high electrical interference. Place the handset and base unit away from interference sources, such as antennas and mobile phones.

Useful Information

Problem	Cause & solution
The handset display is blank.	<ul style="list-style-type: none"> • The handset is not turned on. Turn the power on (page 10).
The handset will not turn on.	<ul style="list-style-type: none"> • Make sure that the batteries are installed correctly (page 8). • Fully charge the batteries (page 9). • Clean the charge contacts and charge again (page 9).
I have changed the display language to a language I cannot read.	<ul style="list-style-type: none"> • Change the display language (page 10).
I cannot make or receive calls.	<ul style="list-style-type: none"> • The AC adaptor or telephone line cord is not connected. Check the connections. • If you are using a splitter to connect the unit, remove the splitter and connect the unit to the wall socket directly. If the unit operates properly, check the splitter. • Disconnect the base unit from the telephone line and connect the line to a known working telephone. If the working telephone operates properly, contact our service personnel to have the unit repaired. If the working telephone does not operate properly, contact your service provider/telephone company. • The dialling mode setting is incorrect. Set to "Tone" or "Pulse" as needed (page 11). • You dialled a call restricted number (page 20).
The unit does not ring.	<ul style="list-style-type: none"> • The ringer volume is turned off. Adjust the ringer volume (page 16, 19).
The batteries should be charging but the battery icon does not change.	<ul style="list-style-type: none"> • Clean the charge contacts and charge again (page 9).
A busy tone is heard when  is pressed.	<ul style="list-style-type: none"> • The handset is too far from the base unit. Move closer and try again. • Another handset is in use or the answering system is being used. Wait and try again later.
Static is heard, sound cuts in and out. Interference from other electrical units.	<ul style="list-style-type: none"> • Place the handset and the base unit away from other electrical appliances. • Move closer to the base unit. • If your unit is connected to a telephone line with DSL service, the DSL service may be interfering with your telephone service. We recommend connecting a filter to the telephone line between the base unit and the telephone line jack. Contact your DSL service provider for more information.

Useful Information

Problem	Cause & solution
Noise is heard during a call.	<ul style="list-style-type: none"> You are using the handset or base unit in an area with high electrical interference. Place the handset and base unit away from interference sources, such as antennas and mobile phones.
The handset/base unit stops working while being used.	<ul style="list-style-type: none"> Disconnect the AC adaptor and turn off the handset. Connect the AC adaptor, turn on the handset and try again.
Pressing [●] does not display/dial the last number dialled.	<ul style="list-style-type: none"> The redialled number was more than 24 digits long. Redial the number manually.
The handset beeps intermittently and/or  flashes.	<ul style="list-style-type: none"> Fully charge the batteries (page 9).
I fully charged the batteries, but  still flashes.	<ul style="list-style-type: none"> Clean the charge contacts and charge again (page 9). It is time to replace the batteries (page 8).
Caller information is not displayed.	<ul style="list-style-type: none"> You must subscribe to Caller ID service. Consult your service provider/telephone company. If your unit is connected to a telephone line with DSL service, the DSL service may be interfering with your telephone service. We recommend connecting a filter to the telephone line between the base unit and the telephone line jack. Contact your DSL service provider for more information.
While viewing caller information, the display returns to standby mode.	<ul style="list-style-type: none"> Do not pause for over 1 minute while searching.
I cannot register a handset to the base unit.	<ul style="list-style-type: none"> The maximum number of handsets (6) are already registered to the base unit. Cancel unused handset registrations from the base unit (page 33). You entered the wrong PIN number. If you forget your PIN, consult your nearest Panasonic service centre. Place the handset and the base unit away from other electrical appliances.

Useful Information

SMS (Short Message Service)

Problem	Cause & solution
I cannot send or receive SMS messages.	<ul style="list-style-type: none"> ● You have not subscribed to the appropriate service. Consult your service provider/telephone company. ● The SMS message centre number(s) are not stored or are incorrect. Store the correct numbers (page 23). ● Message transmission was interrupted. Wait until the message has been sent before using other telephone functions. ● If your unit is connected to a telephone line with DSL service, the DSL service may be interfering with your telephone service. We recommend connecting a filter to the telephone line between the base unit and the telephone line jack. Contact your DSL service provider for more information.
The SMS message centre number is logged in the caller list and the message is not received.	<ul style="list-style-type: none"> ● Someone tried to send you a message while SMS is turned off.
“FD” is displayed.	<ul style="list-style-type: none"> ● The unit could not connect to the SMS message centre. Confirm that the correct SMS message centre numbers are stored (page 23). Confirm that SMS is turned on (page 23).
“FE” is displayed.	<ul style="list-style-type: none"> ● An error occurred while sending the message. Try again.
“E0” is displayed.	<ul style="list-style-type: none"> ● Your phone number is permanently withheld or you have not subscribed to the appropriate service. Consult your service provider/telephone company.
“✓” is not displayed after I read a message.	<ul style="list-style-type: none"> ● When an error code (“FD”, “FE”, or “E0”) is displayed, “✓” will not be displayed even if you have read the message.

Useful Information

Answering system (KX-TG7120 only)

Problem	Cause & solution
The unit does not record new messages.	<ul style="list-style-type: none"> • The answering system is turned off. Turn it on (page 27). • The recording time is set to "Greeting Only". Select "1 Minute" or "3 Minutes" (page 31). • If you subscribe to the voice mail service, messages are recorded by your service provider/telephone company not your telephone. Change the unit's "Number of Rings" setting so that the unit's answering system can answer the call before the voice mail service or consult your service provider/telephone company (page 31).
The other party complains that they cannot leave a message.	<ul style="list-style-type: none"> • The recording time is set to "Greeting Only". Select "1 Minute" or "3 Minutes" (page 31).
I cannot operate the answering system with the handset.	<ul style="list-style-type: none"> • The base unit or another handset is being used. Wait for the other user to finish. • A caller is leaving a message. Wait for the caller to finish. • The handset is too far from the base unit. Move closer.
When I try to operate the answering system with the base unit, the answer on indicator flashes for a few seconds and I cannot operate the answering system.	<ul style="list-style-type: none"> • Another handset is being used. Wait for the other user to finish. • A caller is leaving a message. Wait for the caller to finish.
I cannot operate the answering system remotely.	<ul style="list-style-type: none"> • You are entering the wrong remote access code. If you forget the remote access code, store a new remote access code again (page 29). • You are pressing the dial keys too quickly. Press each key firmly. • The answering system is turned off. Turn it on (page 30). • You are using a pulse telephone. Try again using a touch tone phone.
While recording a greeting message or listening to messages, the unit rings and recording stops.	<ul style="list-style-type: none"> • A call is being received. Answer the call and try again later.

Useful Information

Specifications

■ **Standard:**

DECT (Digital Enhanced Cordless Telecommunications),
GAP (Generic Access Profile)

■ **Number of channels:**

120 Duplex Channels

■ **Frequency range:**

1.88 GHz to 1.9 GHz

■ **Duplex procedure:**

TDMA (Time Division Multiple Access)

■ **Channel spacing:**

1,728 kHz

■ **Bit rate:**

1,152 kbit/s

■ **Modulation:**

GFSK (Gaussian Frequency Shift Keying)

■ **RF transmission power:**

Approx. 250 mW

■ **Voice coding^{*1}:**

ADPCM 32 kbit/s

■ **Power source:**

220–240 V, 50 Hz

■ **Power consumption**

Base unit:

Standby: Approx. 1.9 W

Maximum: Approx. 6.8 W

Charger^{*2}:

Standby: Approx. 1.5 W

Maximum: Approx. 3 W

■ **Operating conditions:**

5 °C–40 °C, 20 %–80 % relative air humidity
(dry)

■ **Dimensions:**

Base unit: Approx. 60 mm × 173 mm × 105 mm

Handset: Approx. 155 mm × 48 mm × 34 mm

Charger^{*2}: Approx. 61 mm × 87 mm × 95 mm

■ **Mass (weight):**

Base unit^{*3}: Approx. 220 g

Base unit^{*1}: Approx. 260 g

Handset: Approx. 140 g

Charger^{*2}: Approx. 90 g

*1 KX-TG7120 only

*2 KX-TG7102 only

*3 KX-TG7100 and KX-TG7102 only

Note:

- Specifications are subject to change.
- The illustrations used in these operating instructions may differ slightly from the actual product.

Connections:

- The unit will not work during a power failure. We recommend you connect a standard telephone on the same line for power protection.



Useful Information

Conditions for usage (For Czech)

- *1 Připojení tohoto bezdrátového telefonního přístroje k analogovému bodu veřejné telekomunikační sítě a uvedení do provozu může provést účastník sám podle Návodu k použití.
- *2 Zařízení je schopno samostatného provozu a je řešeno jako ukončovací. Na účastnické vedení jej lze připojit samostatně, ale i společně s jiným schváleným koncovým zařízením.
- *3 Zařízení je dodáváno s odpojitelným telefonním kabelem s konektory typu RJ11 a musí být tímto kabelem k účastnické zásuvce připojeno. Pro připojení zařízení do čtyřkolíkové účastnické zásuvky musí být použita schválená redukce. (není součástí dodávky)
- *4 Zařízení je napájeno ze sítě pomocí síťového adaptéru, který je součástí dodávky. Funkčnost zařízení je závislá na tomto druhu napájení. Pro připojení napájení nepoužívejte v žádném případě adaptér jiného typu.
- *5 Před použitím zařízení je nutné nabit baterie a to po dobu nejméně 7 hodin. Telefonní kabel připojte až po prvním nabití baterií.
- *6 Tento bezdrátový telefonní přístroj lze provozovat v rámci Generální licence: VO-R/8/08.2005-23.

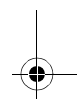
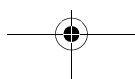
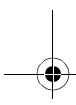
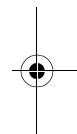
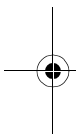

Useful Information

Declaration of conformity form (For Czech and Slovakia)

Panasonic

Panasonic Communications Co., Ltd.
1-62, 4-chome, Minoshima, Hakata-ku, Fukuoka 812-8531 Japan

Declaration of Conformity 012209

Document No. PCTP-060023

(Issuer's name & address)

Panasonic Communications Co., Ltd.
Hakata-ku, Fukuoka, Japan

(Object of the declaration)

(Product) : Digital Enhanced Cordless Telephone
(Trade Name) : Panasonic
(Model Nr.) :
Base Unit : KX-TG7100E, KX-TG7100BL, KX-TG7100FR, KX-TG7100G,
KX-TG7100GR, KX-TG7100JT, KX-TG7100NE, KX-TG7100NL, KX-TG7100SL,
KX-TG7100SP, KX-TG7100FX, KX-TG7100HG, KX-TG7100PD, KX-TG7100TR,
KX-TG7100HGE
Portable Unit : KX-TGA710E, KX-TGA710EX, KX-TGA711EX, KX-TGA711FX
AC Adaptor : PQLV207E, PQLV207CE, PQLV209E, PQLV209CE
Additional Handset: KX-TGA711E, KX-TGA711EX, KX-TGA711FX
Charger Unit : PQLV30045ZA
(Country of Origin): China

The object of the declaration described above is in conformity with the requirements of the following EU legislations and harmonized standards:

(Council Directive) : 1999/5/EC
(Harmonized Standards) : EN301 489-01 V1.4.1 (08-2002),
EN301 489-06 V.1.8.1 (08-2002), EN60950-1: 2001;
EN301 406 V1.5.1 (07-2003), EN50385: 2002, EN 50360: 2001

Signed for and on behalf of :

Printed Name : Nobuharu Akamine
Title : Director
Date of issue : 22nd February, 2006

Contact:

Panasonic Services Europe
a Division of Panasonic Marketing Europe GmbH
Panasonic Testing Centre
Winsbergring 15, 22525 Hamburg, Germany

(Signature) :
(Printed Name) : Hans-Joachim Habeck
(Date) : 22.02.06

The object of the declaration described above <Object of the declaration> is in conformity with the requirements of the following EU legislations <1999/5/EC> and harmonized standards <Harmonized standards>.

Useful Information

Panasonic

Panasonic Communications Co., Ltd.
1-62, 4-chome, Minoshima, Hakata-ku, Fukuoka 812-8531 Japan

Declaration of Conformity 012210

Document No. PCTP-060024

(Issuer's name & address)

Panasonic Communications Co., Ltd.
Hakata-ku, Fukuoka, Japan

(Object of the declaration)

(Product) : Digital Enhanced Cordless Telephone
(Trade Name) : Panasonic
(Model Nr.) : _____
Base Unit : KX-TG7120E, KX-TG7120AR, KX-TG7120FR, KX-TG7120G,
KX-TG7120GR, KX-TG7120JT, KX-TG7120NL, KX-TG7120SL, KX-TG7120SP,
KX-TG7120FX, KX-TG7120HG, KX-TG7120PD, KX-TG7120TR, KX-TG7121G,
KX-TG7120SLD, KX-TG7120SLE
Portable Unit : KX-TGA711E, KX-TGA711EX, KX-TGA711FX
AC Adaptor : PQLV207E, PQLV207CE, PQLV209E, PQLV209CE
Additional Handset: KX-TGA711E, KX-TGA711EX, KX-TGA711FX
Charger Unit : PQLV30045ZA
(Country of Origin): China

The object of the declaration described above is in conformity with the requirements of the following EU legislations and harmonized standards:

(Council Directive) : 1999/5/EC
(Harmonized Standards) : EN301 489-01 V1.4.1 (08-2002),
EN301 489-06 V.1.8.1 (08-2002), EN60950-1: 2001;
EN301 406 V1.5.1 (07-2003), EN50385: 2002, EN 50360: 2001

Signed for and on behalf of :

Printed Name : Nobuharu Akamine
Title : Director
Date of issue : 22nd February, 2006

Contact:

Panasonic Services Europe
a Division of Panasonic Marketing Europe GmbH
Panasonic Testing Centre
Winsbergring 15, 22525 Hamburg, Germany

(Signature) : 
(Printed Name) : Hans-Joachim Habeck
(Date) : 22.02.06

The object of the declaration described above <Object of the declaration> is in conformity with the requirements of the following EU legislations <1999/5/EC> and harmonized standards <Harmonized standards>.

Index

- A**
 - Additional handsets: 32
 - Alarm: 18
 - Answering calls: 13
 - Answering system: 27
 - Listening to messages: 28
 - Remote operation: 29
 - Turning on/off: 27
 - Auto talk: 13, 16
- B**
 - Base unit
 - Resetting: 20
 - Settings: 19
 - Battery
 - Charge: 9
 - Installation: 8
 - Performance: 9
 - Replacement: 8
 - Strength: 9
- C**
 - Caller ID service: 21
 - Call restriction: 20
 - Chain dial: 15
 - Character entry: 35
 - Conference calls: 34
 - Connections: 8
 - Copy
 - Phonebook: 34
- D**
 - Date and time: 11
 - Dialling mode: 11
 - Display
 - Contrast: 16
 - Icons: 7
 - Language: 10
 - Standby mode: 16
- H**
 - Handset
 - Cancelling: 33
 - Locator: 13
 - Power on/off: 10
 - Registration: 32
 - Settings: 16
- I**
 - Intercom: 33
- K**
 - Keytones: 16
- M**
 - Making calls: 12
 - Message alert: 16
 - Missed calls: 21
- Mute:** 12
- P**
 - Pause: 12
 - Phonebook
 - Handset phonebook: 14
 - Phonebook copy: 34
 - PIN
 - Base unit: 19
 - Power on/off: 10
- R**
 - Recall: 12, 19
 - Recording
 - Greeting message: 27
 - Redialling: 12
 - Redial list: 12
 - Region setting: 20
 - Registration: 32
 - Repeater: 33
 - Ringtones: 16
- S**
 - SMS feature: 23
 - Speakerphone: 12
- T**
 - Temporary tone dialling: 13
 - Transfer calls: 33
- V**
 - Voice mail: 22
 - Volume
 - Receiver: 12
 - Ringer (Base unit): 19
 - Ringer (Handset): 16
 - Speakerphone: 12



CE0436

1999/5/EC

Sales Department:

VO-R/8/08.2005-23 (for Czech)
Panasonic Czech Republic, s.r.o.
Křižíkova 237/36A (Palác Karlín)
186 00 Praha 8
telefon: +420-236 032 511
centrální fax: +420-236 032 411
e-mail: info@panasonic.cz
e-mail: pcsserv@panasonic.cz
aktuální info na www.panasonic.cz

VPR-7/2001 (for Slovakia)
Panasonic Slovakia, s.r.o.
Štúrova 11, 811 02 BRATISLAVA,
Slovenská republika
Tel. číslo: +421-2-5292-1423
Fax: +421-2-5292-1411
e-mail: sales@panasonic.sk
web: www.panasonic.sk

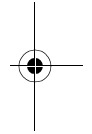
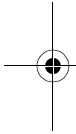

Panasonic Communications Zhuhai Co., Ltd.

3 Ping Xi 8 Lu, Nanping Keji Gongye Yuan, Zhuhai, Guangdong, China 519060

Copyright:

This material is copyrighted by Panasonic Communications Co., Ltd., and may be reproduced for internal use only. All other reproduction, in whole or in part, is prohibited without the written consent of Panasonic Communications Co., Ltd.

© 2006 Panasonic Communications Co., Ltd. All Rights Reserved.



TG7100FX

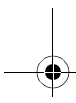

PQQX15319ZA CC0406DH1086

FX-2/3

