

## Schnellanleitung

Blu-ray Disc™ Heimkino-Soundsystem

## Guida Di Impostazione Rapida

Sistema Home Theater Blu-ray Disc™

## Guide de paramétrage facile

Système Cinéma Maison Blu-ray Disc™

## Guía de configuración sencilla

Blu-ray Disc™ Sistema de sonido "Home Theater" (Teatro en casa)

## Gids Voor Eenvoudig Instellen

Blu-ray Disc™ Home Theater Geluidssysteem

## Guide enkel inställning

Blu-ray Disc™ Hemmabio ljudsystem

## Nem Indstillingsoversigt

Blu-ray Disc™ Lydsystem til hjemmebiograf

## Helppo asetusopas

Blu-ray Disc™ -kotiteatterijärjestelmä

Modell Nr./Model No./Modèle n°/Modelo N./Model Nr./Modell nr./Model nr./Malli nro

# SC-BTT490



# Schnellanleitung

## SCHRITT 1: Aufbau der Frontlautsprecher

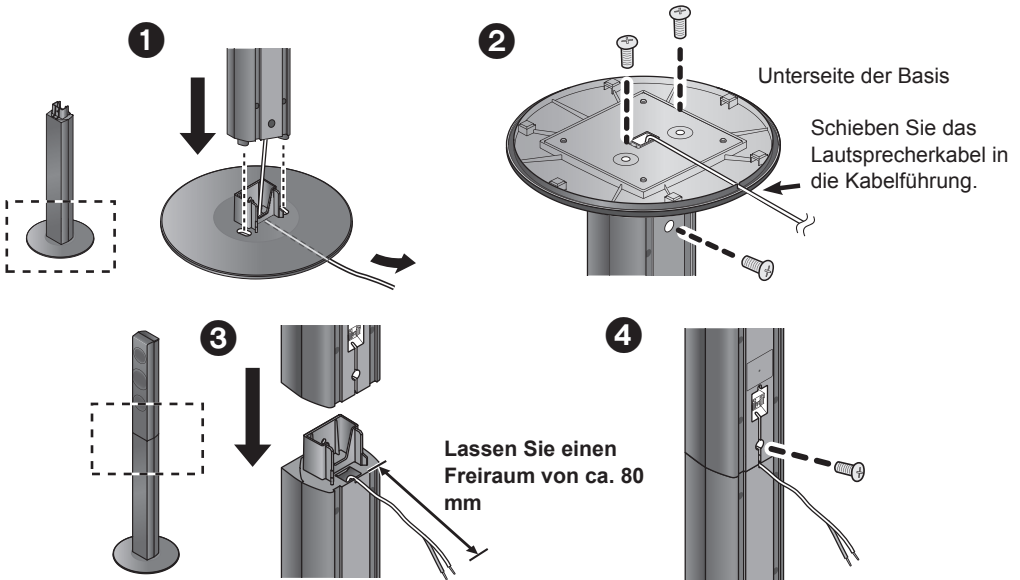

## SCHRITT 2: Anbringen des Stickers an den Kabeln

z.B. Frontlautsprecher Lch

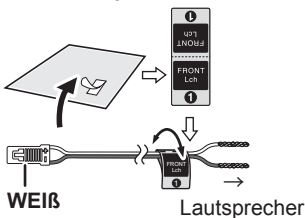

Lautsprecherkabelaufkleber	Anschluss
FRONT Lch ①	WEIß
FRONT Rch ②	ROT
SURROUND Lch ③	BLAU
SURROUND Rch ④	GRAU
CENTER ⑤	GRÜN
SUBWOOFER ⑥	VIOLETT

## SCHRITT 3: Anschließen der Lautsprecherkabel

Bei Surround-Lautsprechern besteht kein Unterschied zwischen rechts und links.

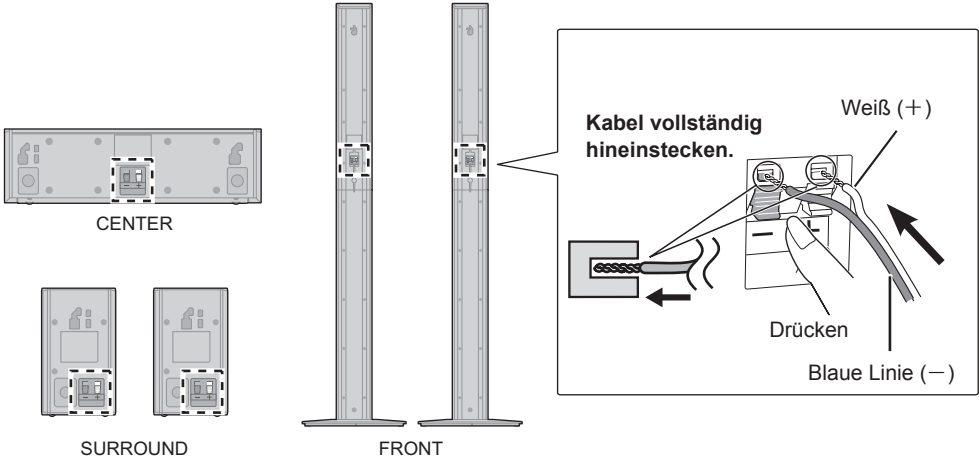

## SCHRITT 4: Die Lautsprecher aufstellen

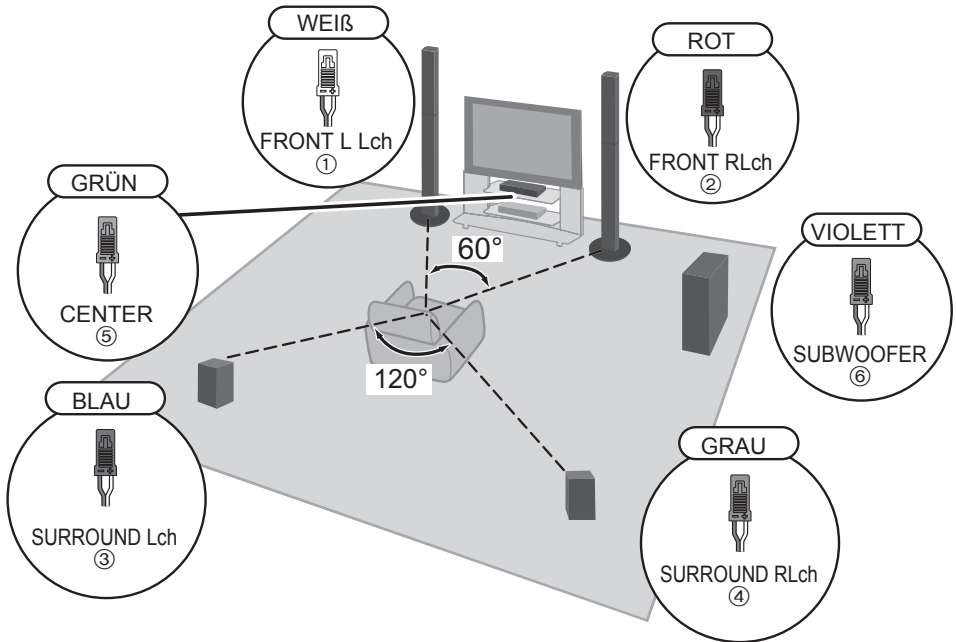

# SCHRITT 5: Die Kabel verbinden

Informationen zu anderen Verbindungsmethoden und Internet-Funktionen finden Sie in der Bedienungsanleitung.

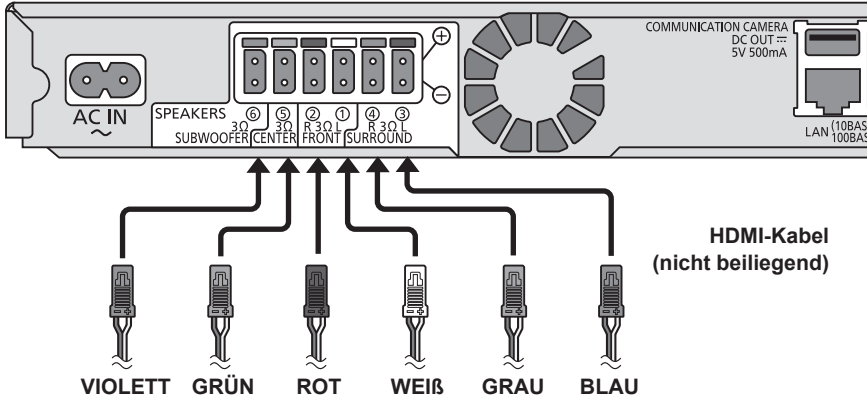

Verbinden Sie die Lautsprecherkabel mit den Anschlüssen der gleichen Farbe.

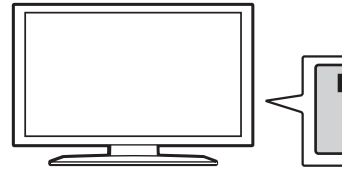

# SCHRITT 6: Anschalten des Systems

1 Schließen Sie das Netzkabel an.

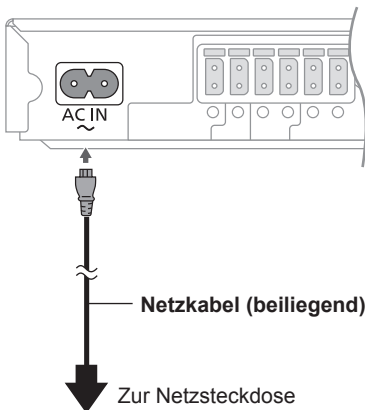

2 Schalten Sie den Fernseher ein.

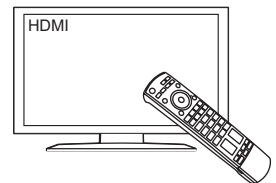

Stellen Sie den Video-Eingangsmodus auf HDMI, etc.

Ein Videokabel (nicht mitgeliefert) wird benötigt, um Fotos/Videos auf dem iPod/iPhone anzusehen.

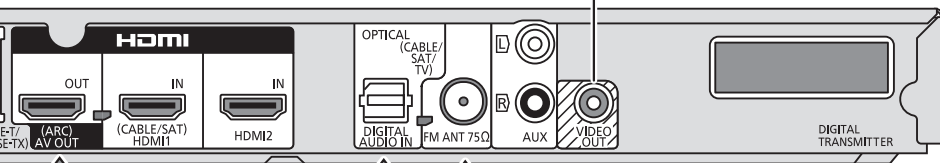

Optisches Digital-Audiokabel (nicht beiliegend)



UKW-Zimmerantenne (beiliegend)

Nicht erforderlich, wenn der HDMI-Anschluss des Fernsehgeräts mit "HDMI (ARC)" gekennzeichnet ist.

Befestigen Sie das Ende der Antenne an einer Wand oder Säule, wo der Empfang am besten ist.

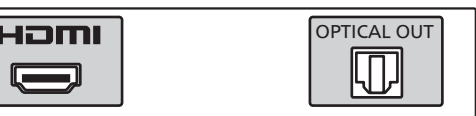

### 3 Anschalten des Systems.

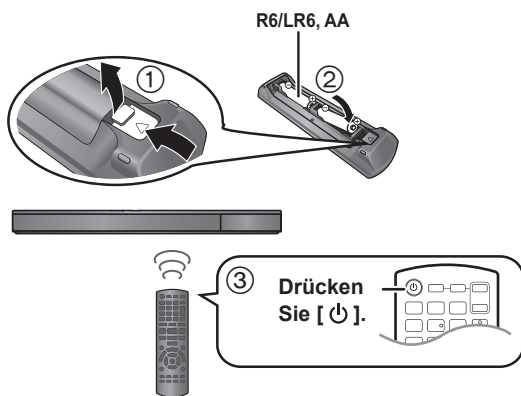

### 4 Die Grundeinstellung beginnt.

Befolgen Sie die Anweisungen auf dem Bildschirm.

# Guida Di Impostazione Rapida

## FASE 1: Montare i diffusori anteriori

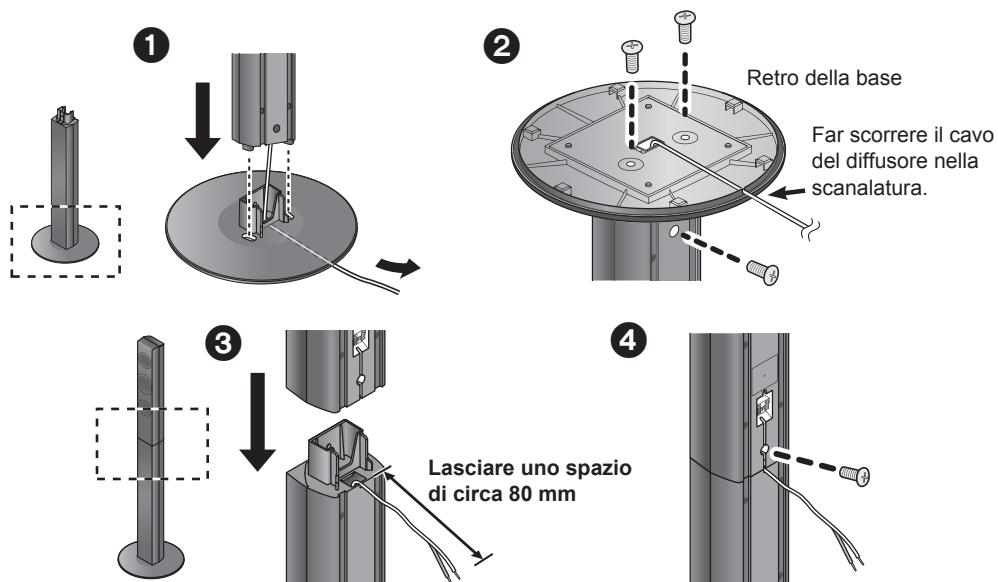

## FASE 2: Attaccare gli adesivi sui cavi

es., Diffusore anteriore Lch

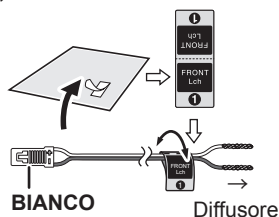

Autoadesivo del cavo altoparlante	Connettore
FRONT Lch ①	BIANCO
FRONT Rch ②	ROSSO
SURROUND Lch ③	BLU
SURROUND Rch ④	GRIGIO
CENTER ⑤	VERDE
SUBWOOFER ⑥	VIOLA

## FASE 3: Collegamento dei cavi degli altoparlanti

Non c'è alcuna differenza tra i diffusori surround destro e sinistro.

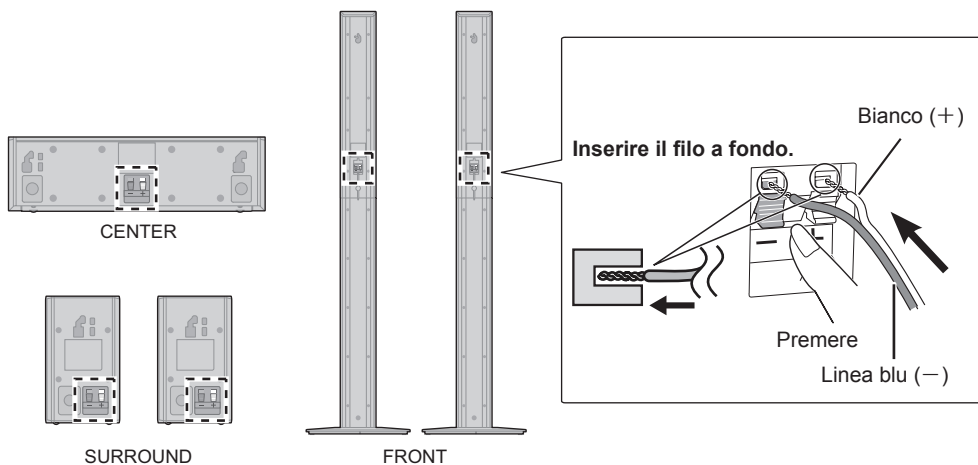

## FASE 4: Posizionare gli altoparlanti

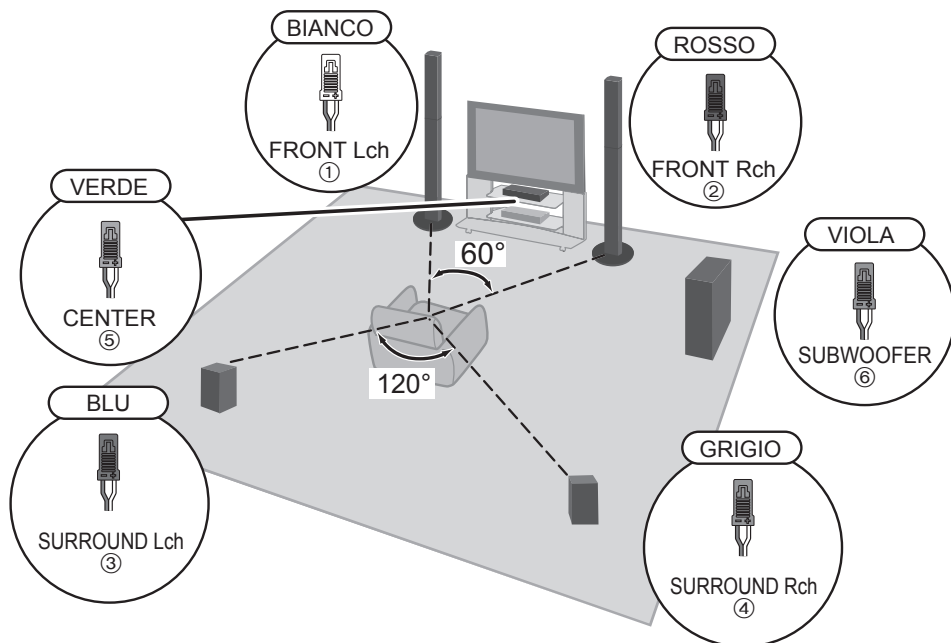

## FASE 5: Collegare i cavi

Per informazioni su altri metodi di collegamento e impostazioni internet, consultare le istruzioni d'uso.

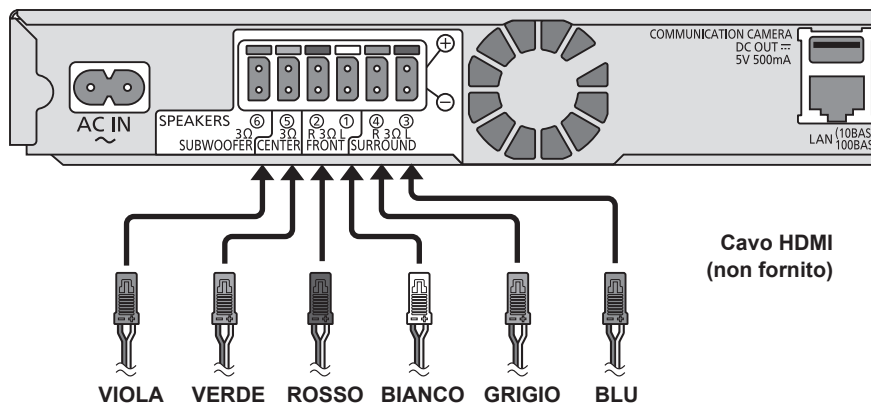

**Cavo HDMI  
(non fornito)**

**Collegare i cavi dei diffusori ai terminali dello stesso colore.**

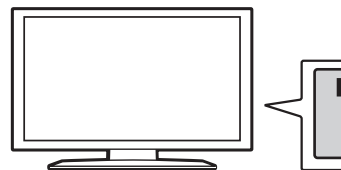

## FASE 6: Accendere l'impianto

**1** Collegare il cavo di alimentazione CA.

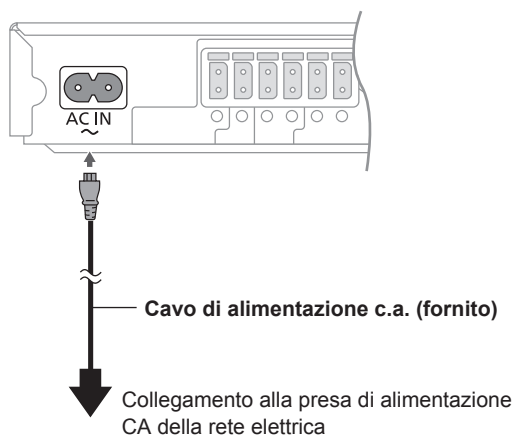

**2** Accendere l'apparecchio TV.

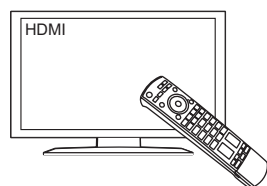

**Impostare la modalità video  
su HDMI, ecc.**



È necessario un cavo video (non in dotazione) per vedere immagini o video da iPod/iPhone.

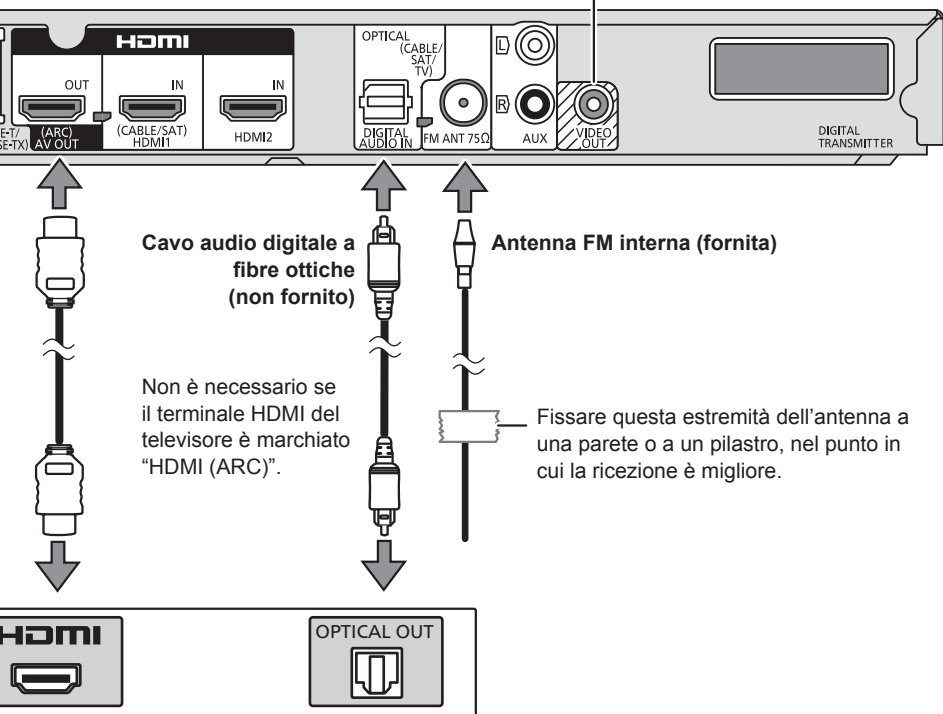

### 3 Accendere l'impianto.

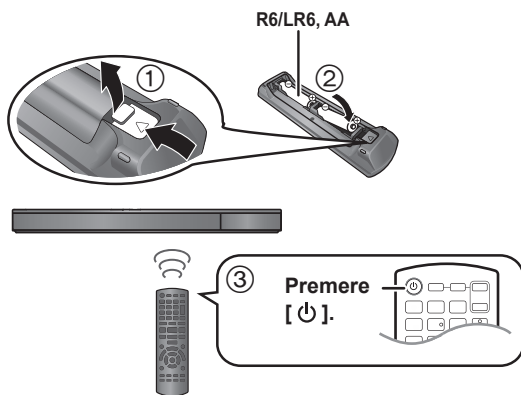

### 4 Ha inizio la procedura di impostazione rapida.

Seguire le istruzioni sullo schermo.

# Guide de paramétrage facile

## ÉTAPE 1: Assemblage des enceintes avant

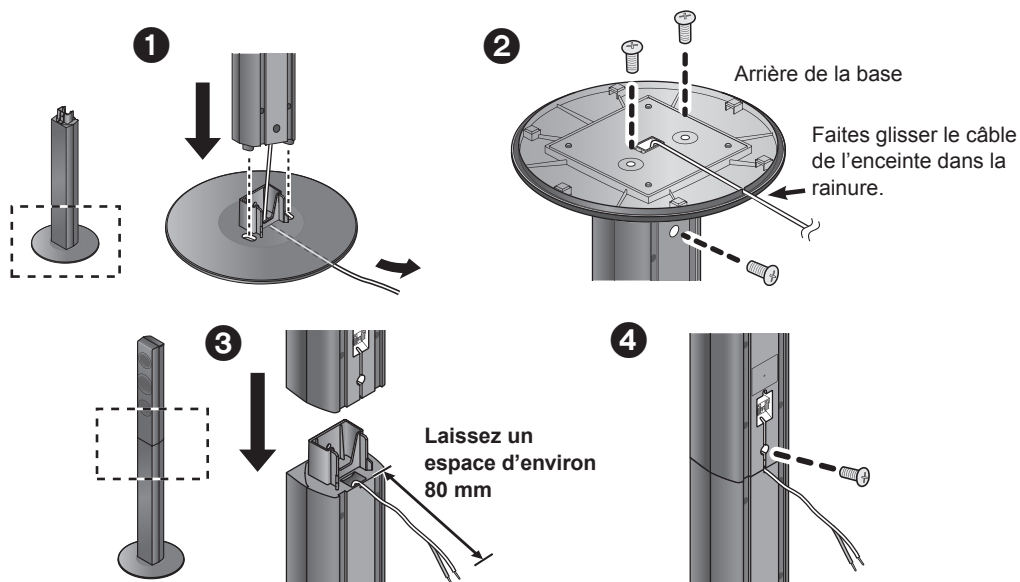

## ÉTAPE 2: Mise en place de l'autocollant sur les câbles

ex. Lch enceinte avant

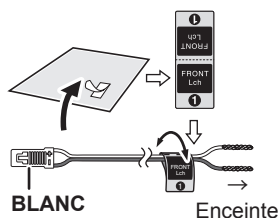

Autocollant câble enceinte	Connecteur
FRONT Lch ①	BLANC
FRONT Rch ②	ROUGE
SURROUND Lch ③	BLEU
SURROUND Rch ④	GRIS
CENTER ⑤	VERT
SUBWOOFER ⑥	VIOLET

## ÉTAPE 3: Pour connecter les câbles de l'enceinte

Le coté droit et gauche des enceintes Surround n'ont pas de différence.

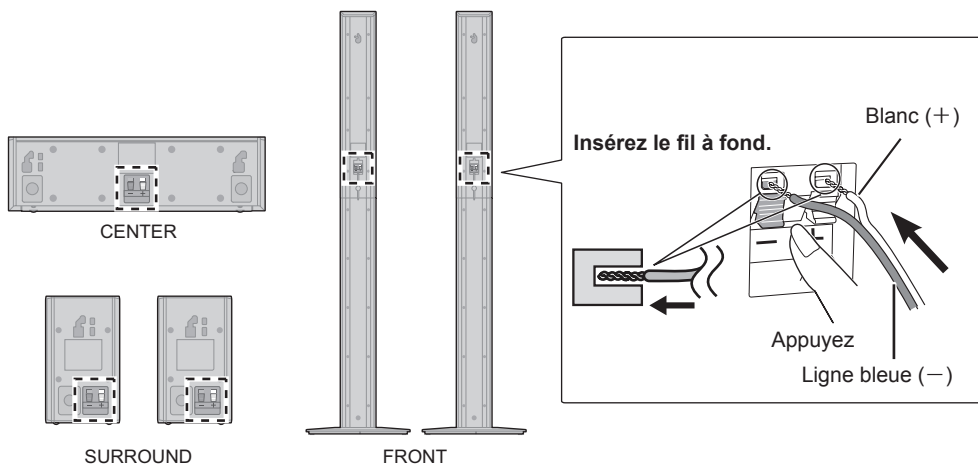

## ÉTAPE 4: Mettre les hauts-parleurs en place

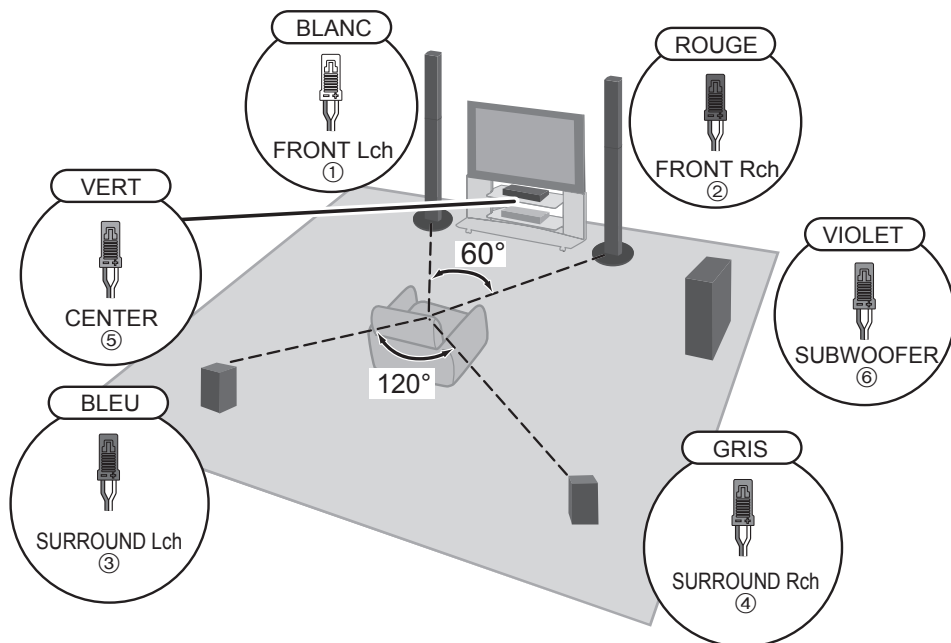

## ÉTAPE 5: Connectez les câbles

Pour avoir des informations sur d'autres méthodes de connexion et sur les fonctionnalités Internet, consultez le mode d'emploi.

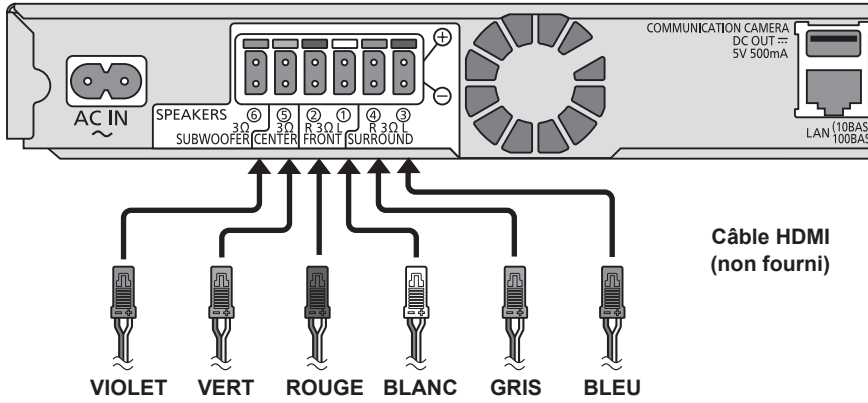

Connectez les câbles de l'enceinte aux prises de la même couleur.

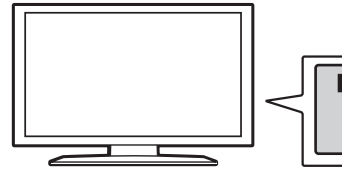

## ÉTAPE 6: Allumez le système

1 Connectez le fil secteur CA.

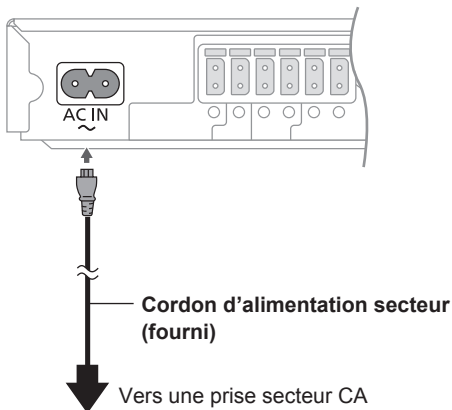

2 Allumez le téléviseur.

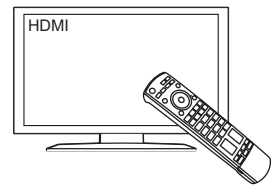

Mettez le mode entrée vidéo sur HDMI, etc.

Un câble vidéo (non fourni) est nécessaire pour visionner des photos/vidéos sur l'iPod/iPhone.

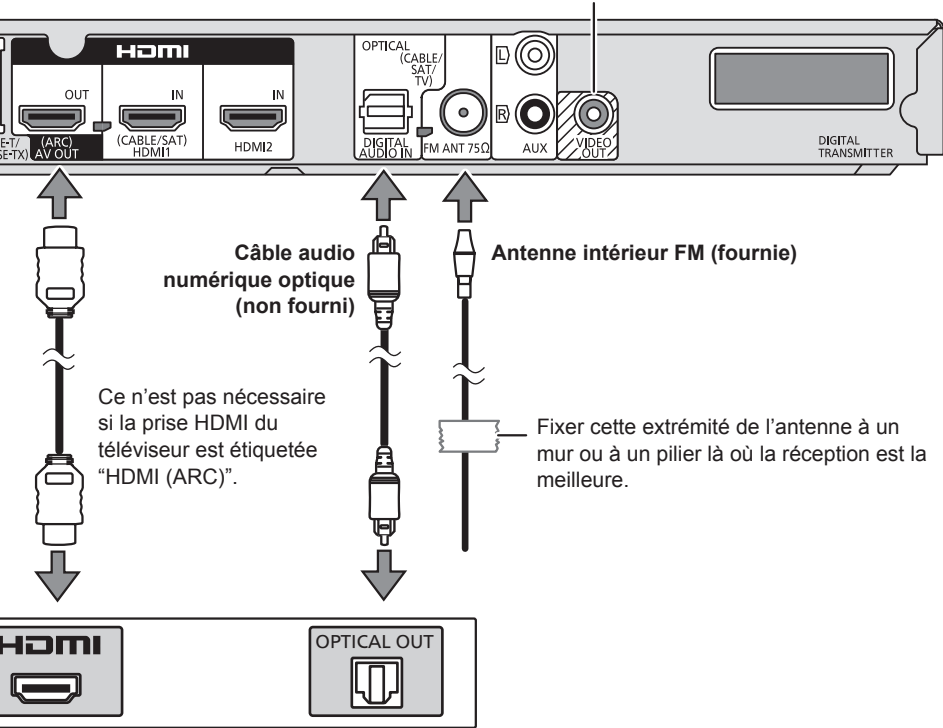

### 3 Allumez le système.

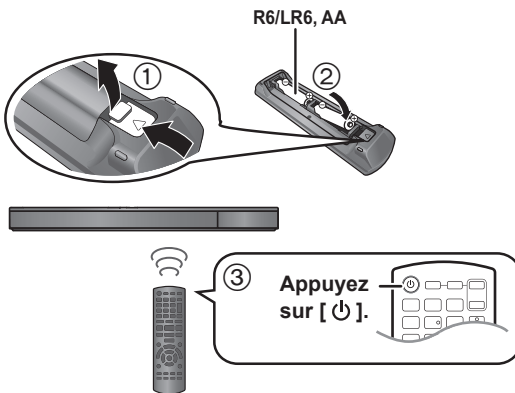

### 4 Le Réglage facile démarre.

Suivez les instructions à l'écran.

# Guía de configuración sencilla

## PASO 1: Colocar los altavoces frontales

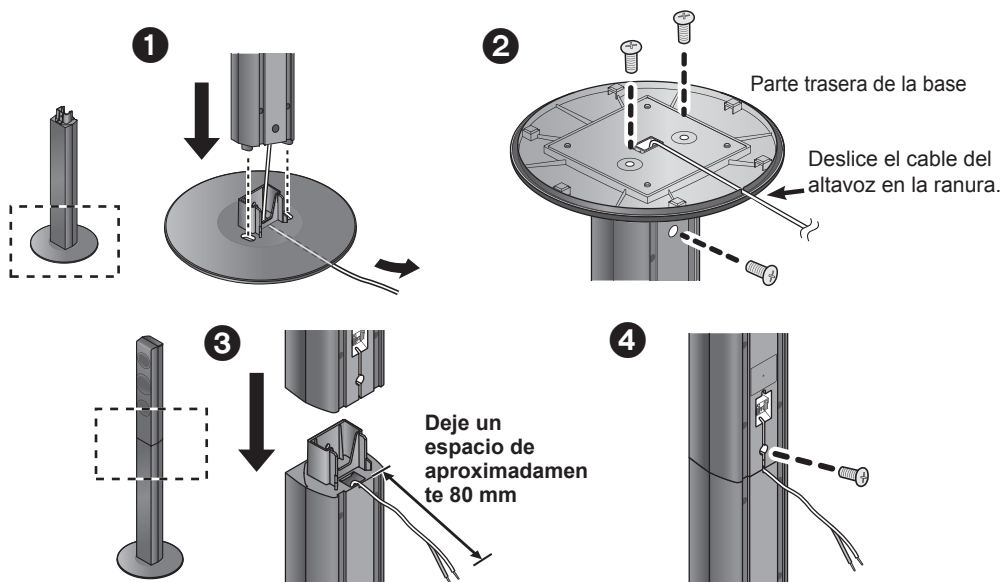

## PASO 2: Colocar la pegatina en los cables

p.ej. Altavoz delanteros Lch

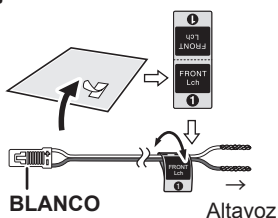

Pegatina del cable del altavoz	Conector
FRONT Lch ①	BLANCO
FRONT Rch ②	ROJO
SURROUND Lch ③	AZUL
SURROUND Rch ④	GRIS
CENTER ⑤	VERDE
SUBWOOFER ⑥	MORADO

# PASO 3: Conexión de los cables del altavoz

Los altavoces envolventes no tienen diferencia entre izquierda y derecha.

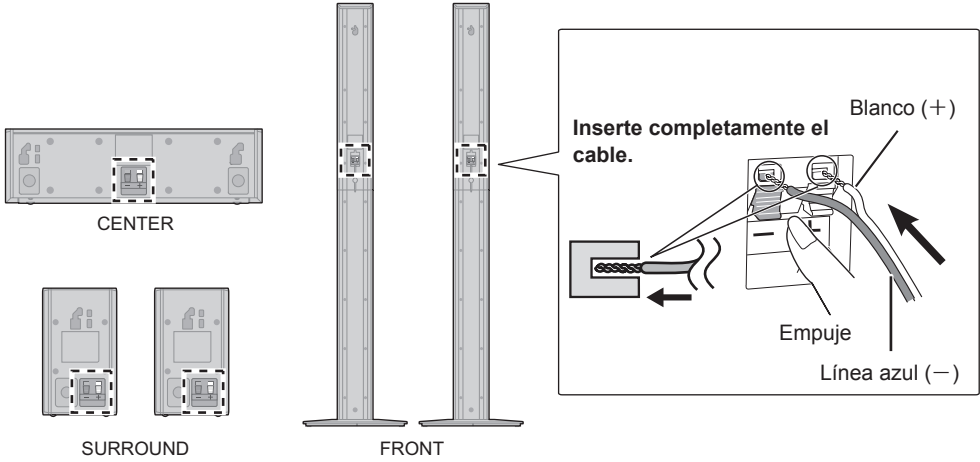

ESPAÑOL

# PASO 4: Coloque los altavoces

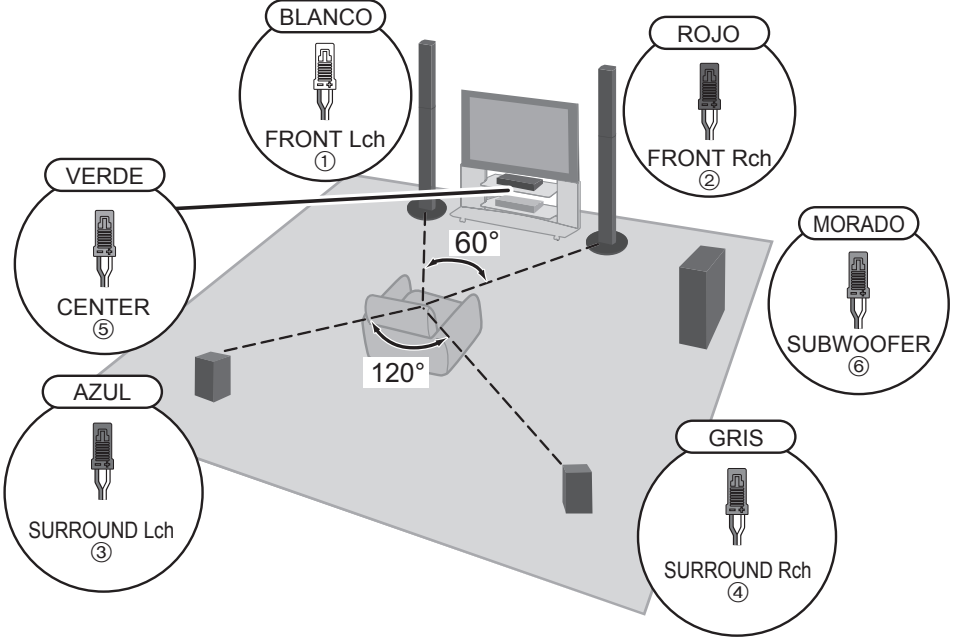

## PASO 5: Conectar los cables

Para obtener información sobre los métodos de conexión y las funciones de Internet, consulte las instrucciones de funcionamiento.

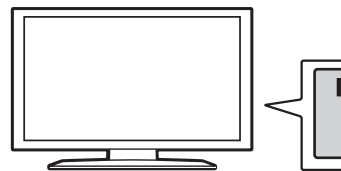
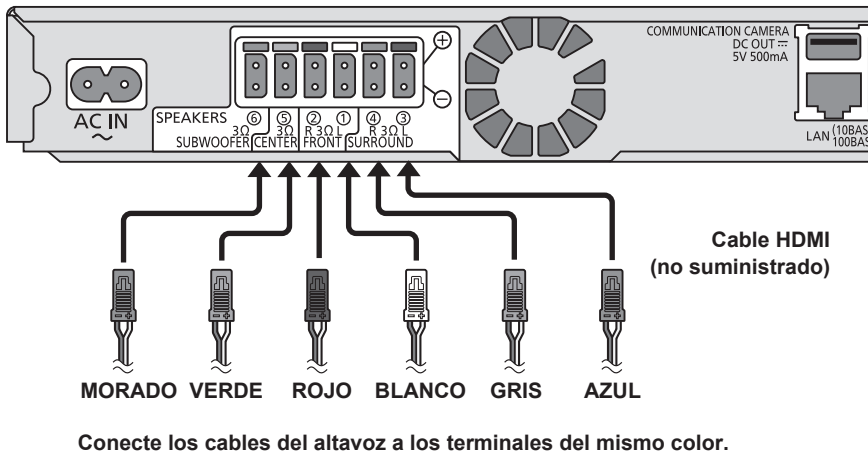

## PASO 6: Encender el sistema

1 Conecte el cable de corriente de CA.

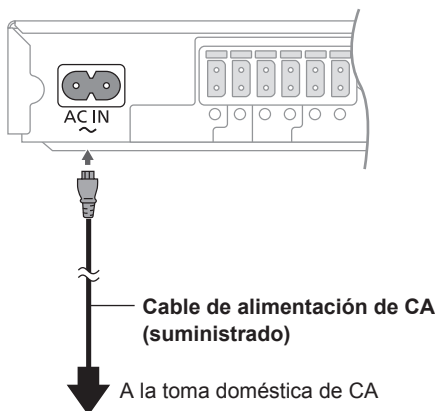

2 Encienda el televisor.

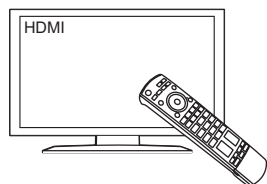

Fije el modo de entrada de video en HDMI, etc.



Se requiere un cable de video (no suministrado) para ver las fotos/videos en el iPod/iPhone.

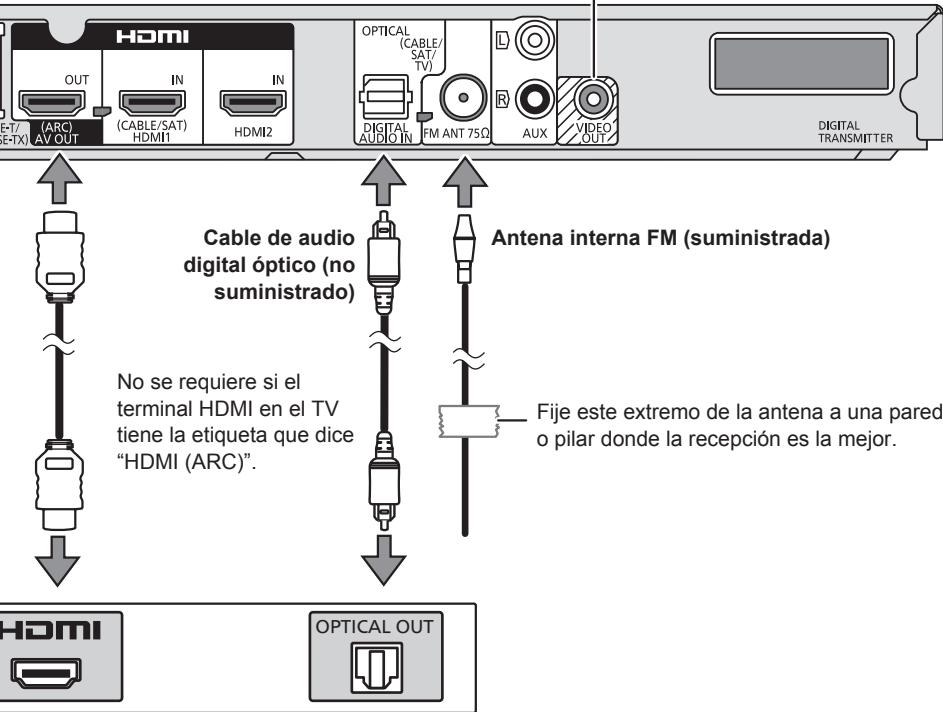

### 3 Encender el sistema.

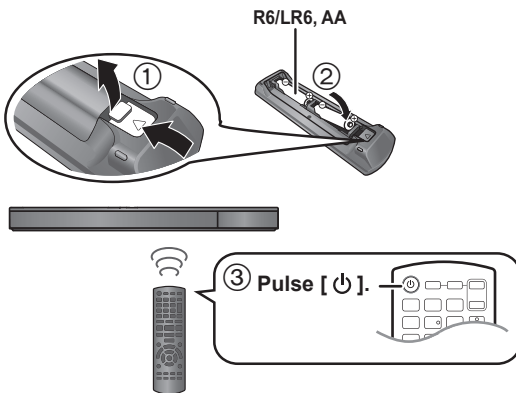

### 4 El Ajuste rápido comienza.

Siga las instrucciones en la pantalla.

# Gids Voor Eenvoudig Instellen

## STAP 1: Assemblage van de voorluidsprekers

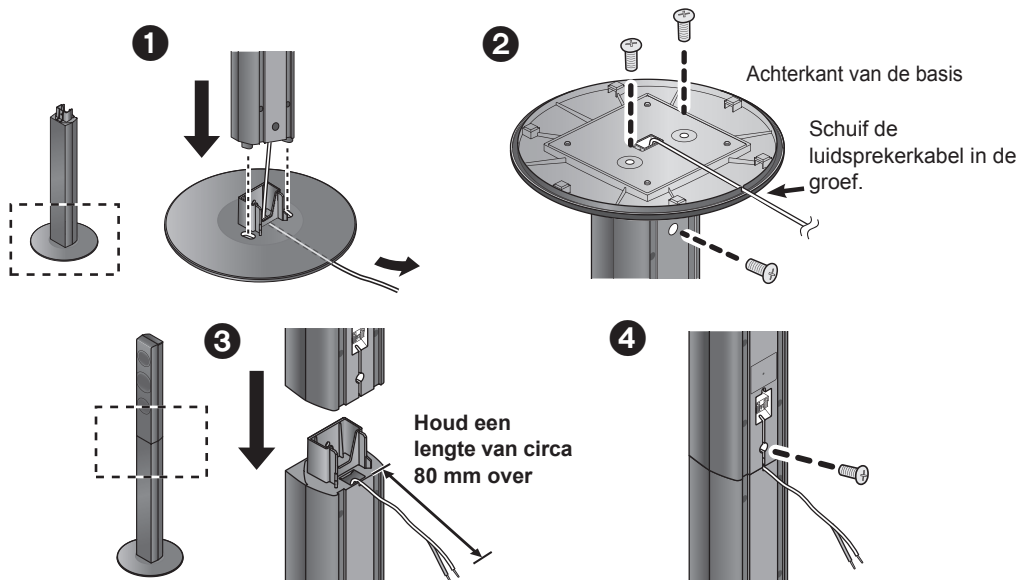

## STAP 2: Aanbrengen van de sticker op de kabels

bijv. Voorluidspreker Lch

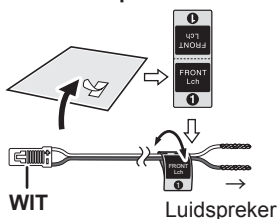

Sticker luidsprekerkabel	Connector
FRONT Lch ①	WIT
FRONT Rch ②	ROOD
SURROUND Lch ③	BLAUW
SURROUND Rch ④	GRIJS
CENTER ⑤	GROEN
SUBWOOFER ⑥	PAARS

## STAP 3: De luidsprekerkabels verbinden

Voor de surroundluidsprekers wordt geen onderscheid tussen rechts en links gemaakt.

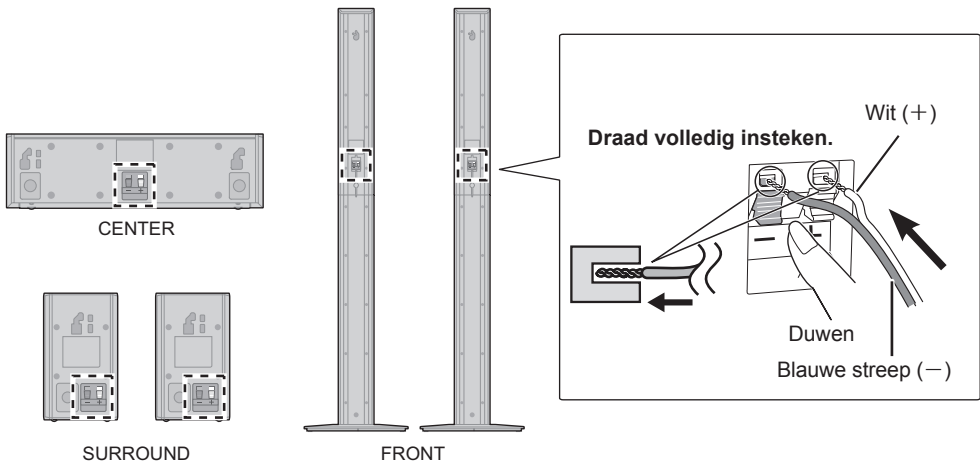

## STAP 4: Plaats de luidsprekers

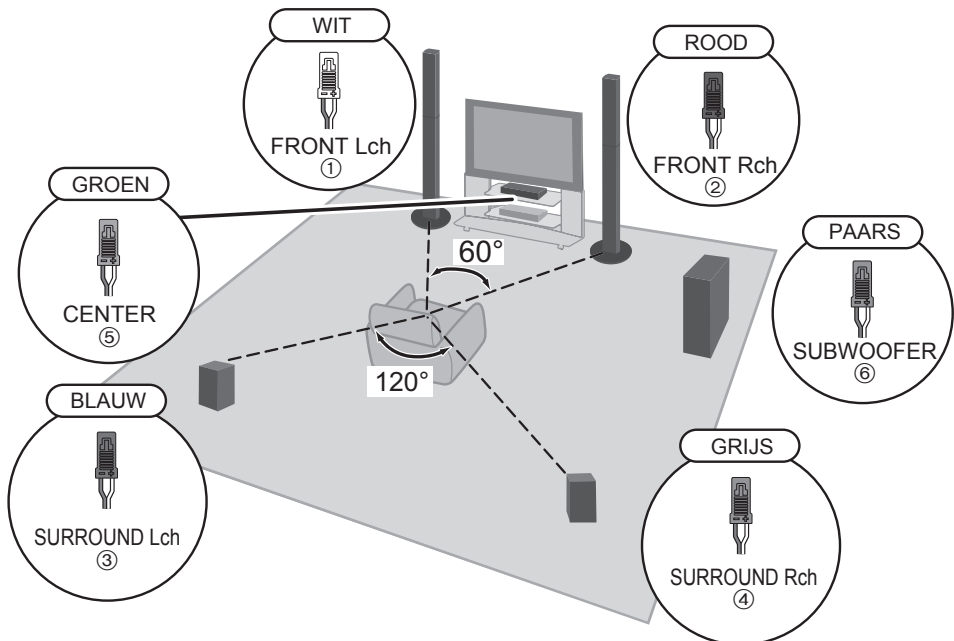

## STAP 5: De kabels aansluiten

Raadpleeg de igebruiksaanwijzing voor informatie over andere aansluitmethoden en internetkenmerken.

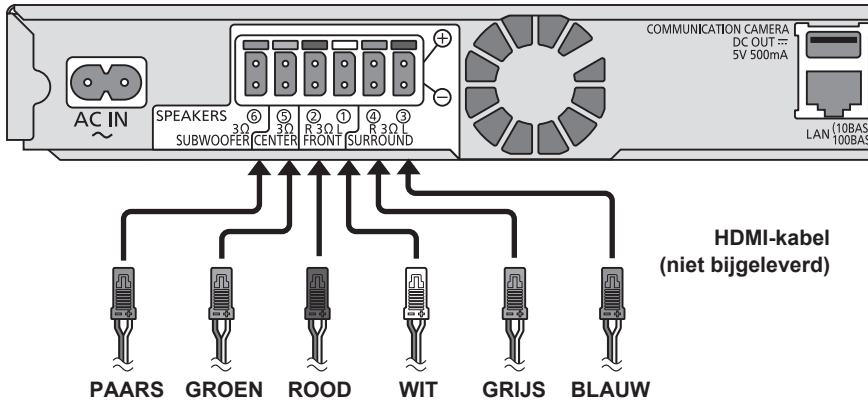

Sluit de luidsprekerkabels aan op de aansluitpunten van dezelfde kleur.

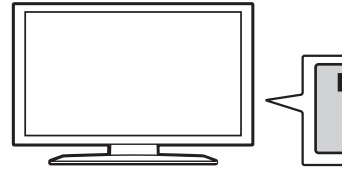

## STAP 6: Schakel het systeem in

**1** Sluit het netsnoer aan.

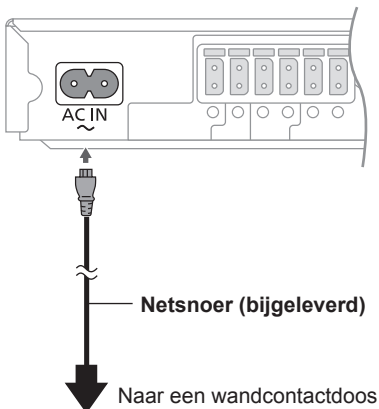

**2** Zet de TV aan.

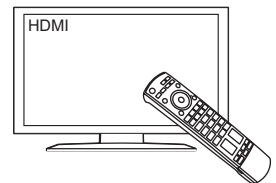

Zet de video-ingangsmodus op HDMI, enz.

Er wordt een (niet bijgeleverde) videokabel vereist om foto's/ video's op de iPod/iPhone te bekijken.

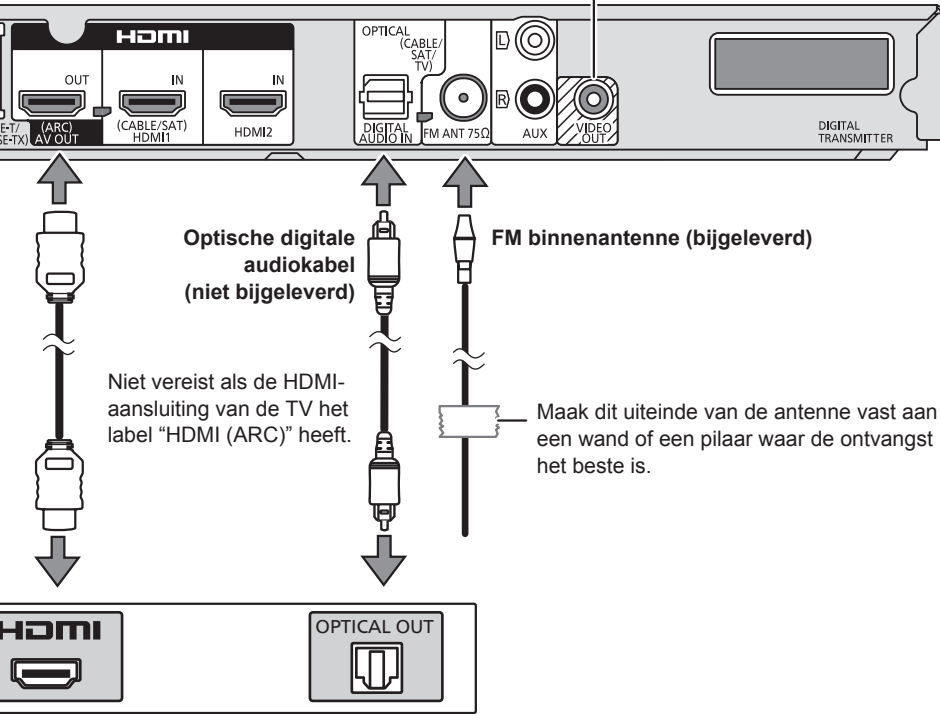

### 3 Schakel het systeem in.

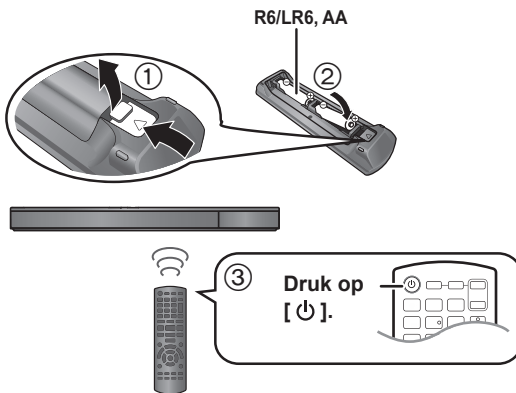

### 4 De Eenvoudige Instelling start.

Volg de instructies die op het scherm verschijnen.

# Guide enkel inställning

## STEG 1: Montering av de främre högtalarna

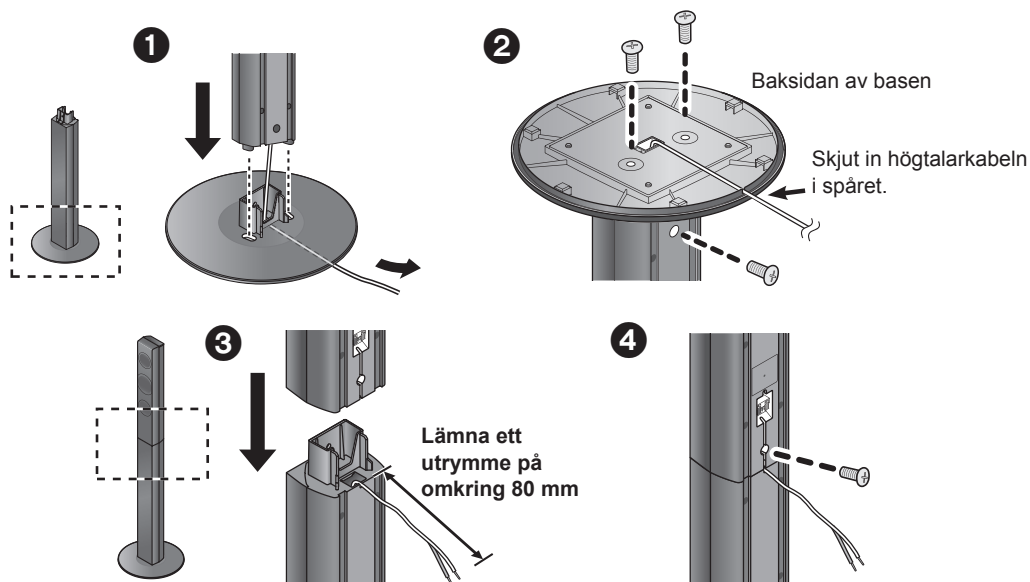

## STEG 2: Sätt fast etiketten på kablarna

t. ex. Främre högtalare Lch

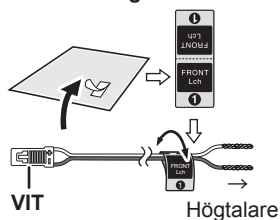

Etikett på högtalarkabel	Kontakt
FRONT Lch ①	VIT
FRONT Rch ②	RÖD
SURROUND Lch ③	BLÅ
SURROUND Rch ④	GRÅ
CENTER ⑤	GRÖN
SUBWOOFER ⑥	LILA

## STEG 3: Hur du ansluter högtalarkablarna

För surroundhögtalare är det ingen skillnad mellan höger och vänster.

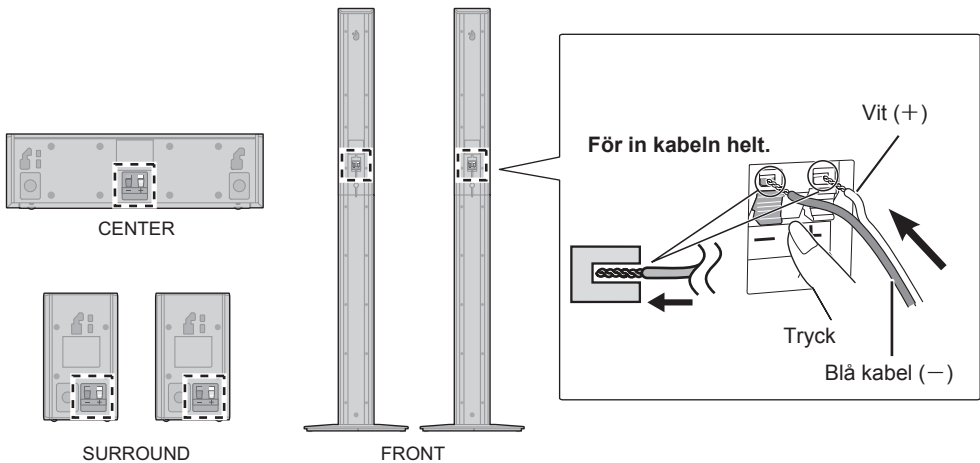

## STEG 4: Sätt högtalarna på plats

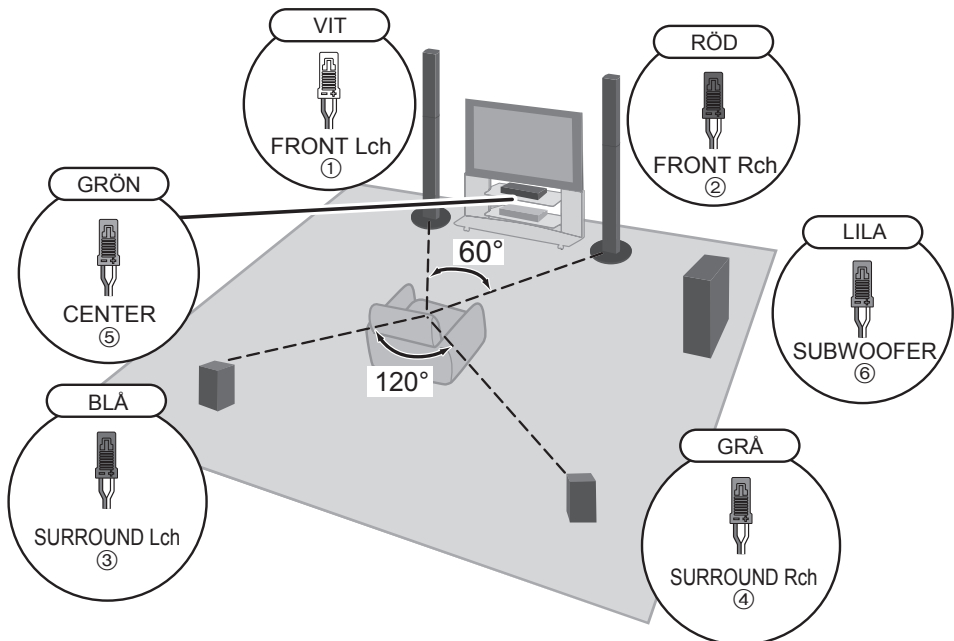

# STEG 5: Anslut kablarna

För information om andra anslutningsmetoder och internetfunktioner, se bruksanvisningarna.

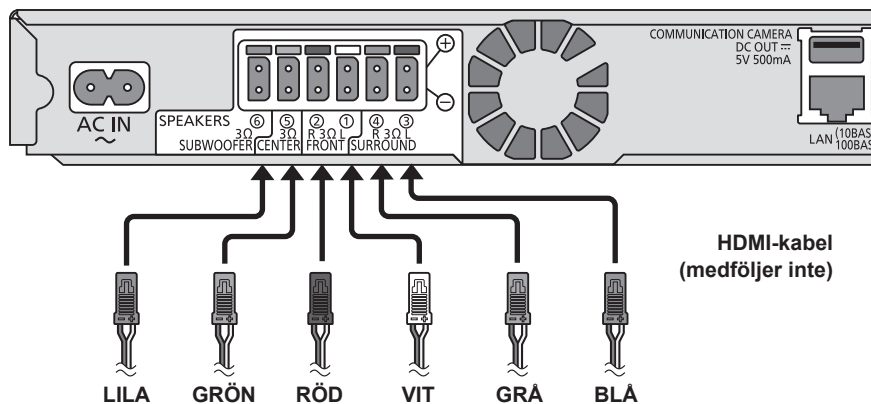

Anslut högtalarkablarna till kontakter med samma färg.

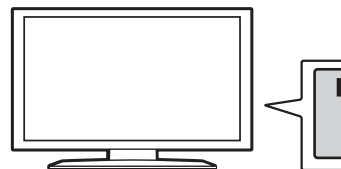

## STEG 6: Sätt på systemet

### 1 Anslut nätkabeln.

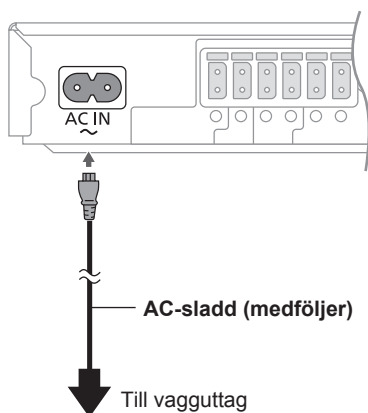

### 2 Sätt på TV:n.

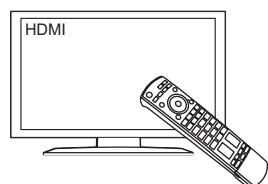

Ställ in videoingångsläget på HDMI etc.



En videokabel (medföljer inte) krävs för att titta på foton/videor på en iPod/iPhone.

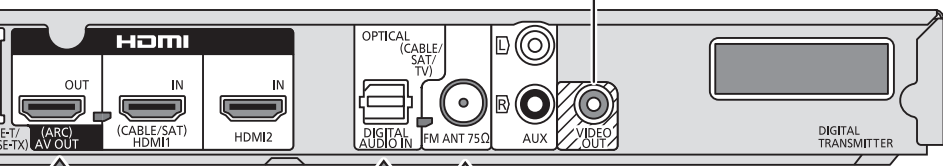

Optisk digital ljudkabel (medföljer inte)

Den behövs inte om HDMI-utgången på tv:n är märkt "HDMI (ARC)".

FM-inomhusantenn (medföljer)

Fäst den här änden av antennen på en vägg eller pelare där mottagningen är som bäst.



### 3 Sätt på systemet.

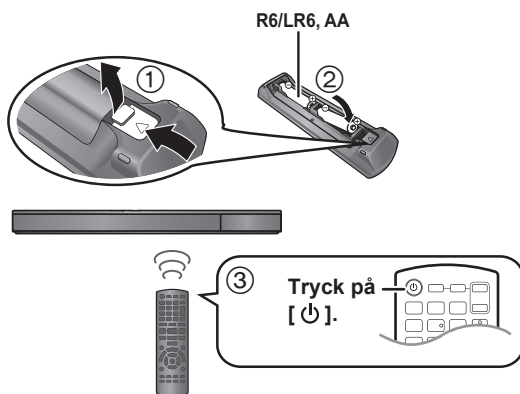

### 4 Den enkla inställningen startar.

Följ anvisningarna på skärmen.

# Nem Indstillingsoversigt

## TRIN 1: Montering af fronthøjttalere

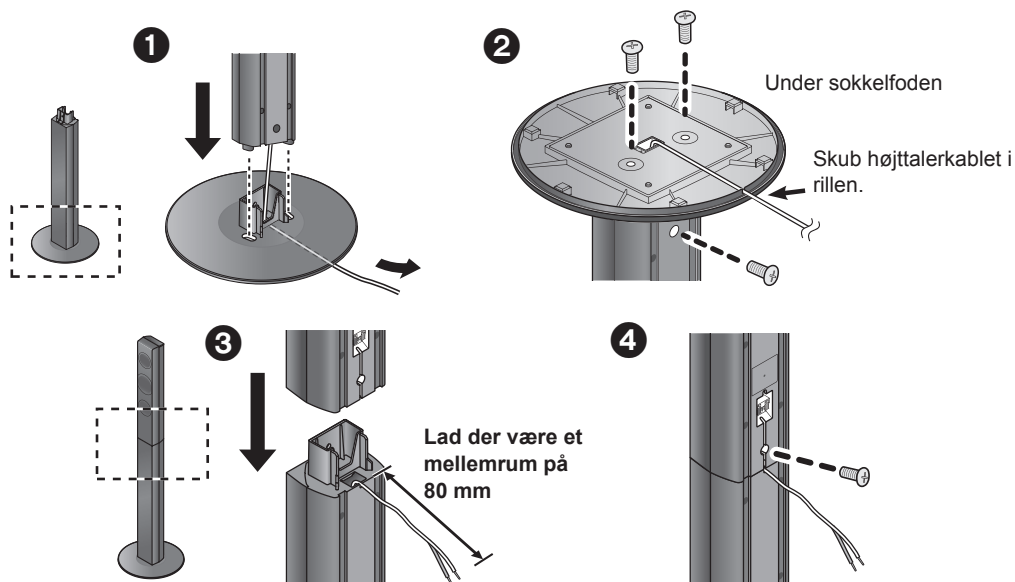

## TRIN 2: Fastgøring af klistermærke på kablerne

f.eks. Front-højttalere Lch

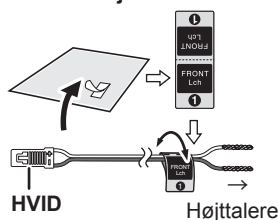

Mærkat til højttalerkabel	Stik
FRONT Lch ①	HVID
FRONT Rch ②	RØD
SURROUND Lch ③	BLÅ
SURROUND Rch ④	GRÅ
CENTER ⑤	GRØN
SUBWOOFER ⑥	LILLA

## TRIN 3: Tilslutning af højttalerkabler

Der er ingen forskel på venstre og højre surround sound-højttaler.

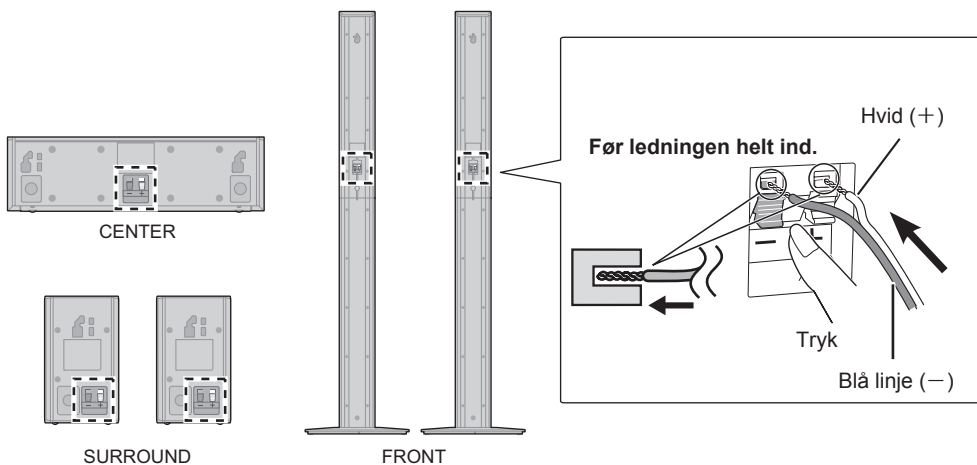

## TRIN 4: Placér højttalerne

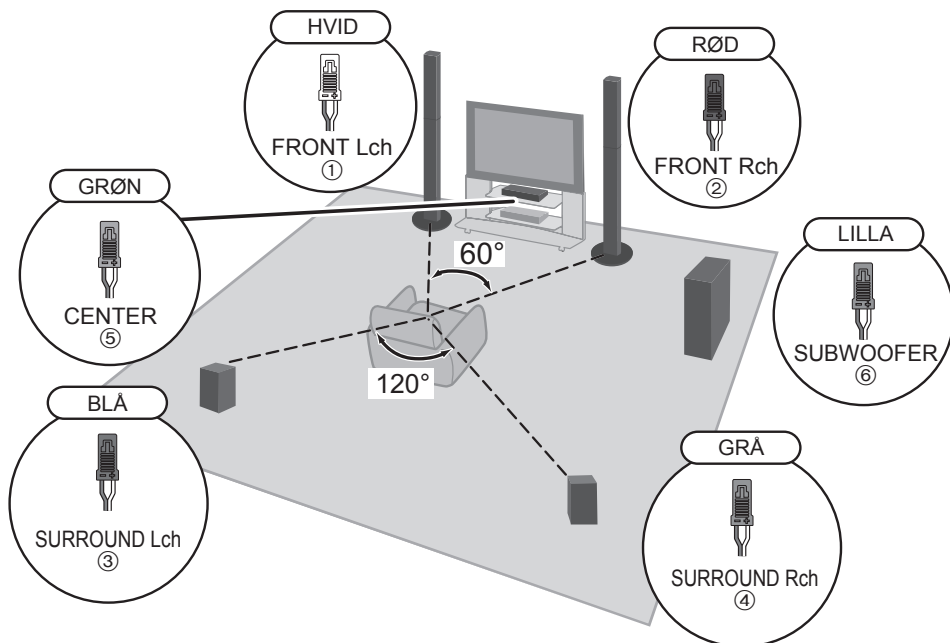

## TRIN 5: Tilslut kablerne

Se betjeningsvejledningen for at få oplysninger om andre forbindelsesmetoder og internetfunktionen.

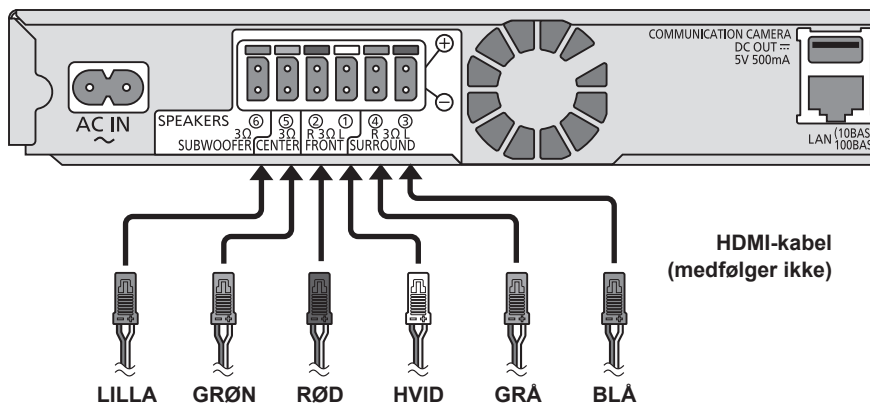

Tilslut til højttalerkablerne til terminalerne af samme farve.

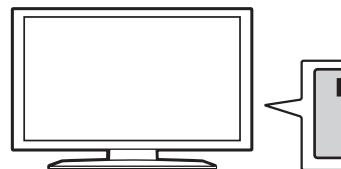

## TRIN 6: Tænd systemet

**1** Forbind lysnetledningen.

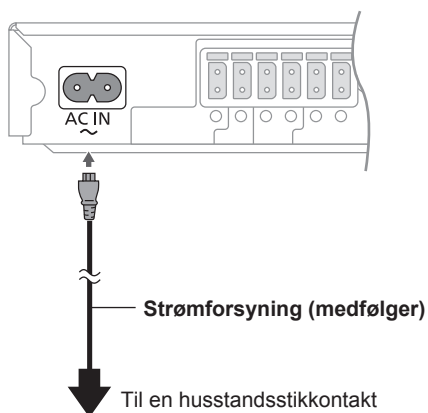

**2** Tænd for fjernsynet.

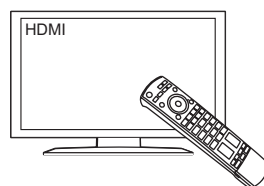

Sæt videofunktionen til HDMI osv.

Et videokabel (medfølger ikke) kræves for at få vist fotos/videoer på din iPod/iPhone.

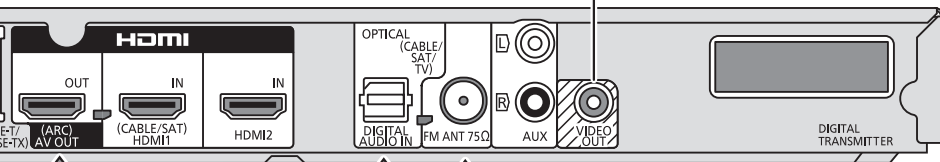

Optisk, digitalt lyd-kabel (medfølger ikke)

FM-indendørs antenne (medfølger)

Kræves ikke, hvis HDMI-terminalen på TV'et er mærket "HDMI (ARC)".

Fastgør denne ende af antennen til en væg eller søjle, hvor du finder den bedste modtagelse.



### 3 Tænd systemet.

### 4 Start af Nem indstilling.

Følg anvisningerne på skærmen.

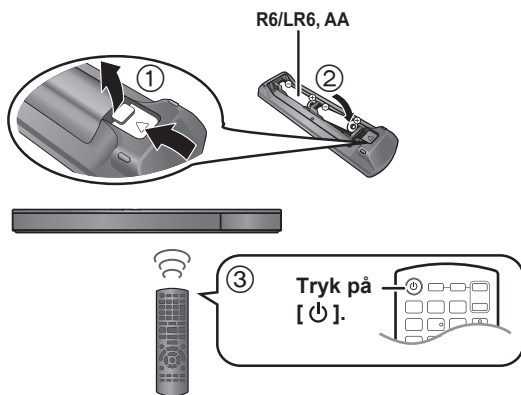

# Helppo asetusopas

## VAIHE 1: Etukaiuttimien kokoaminen

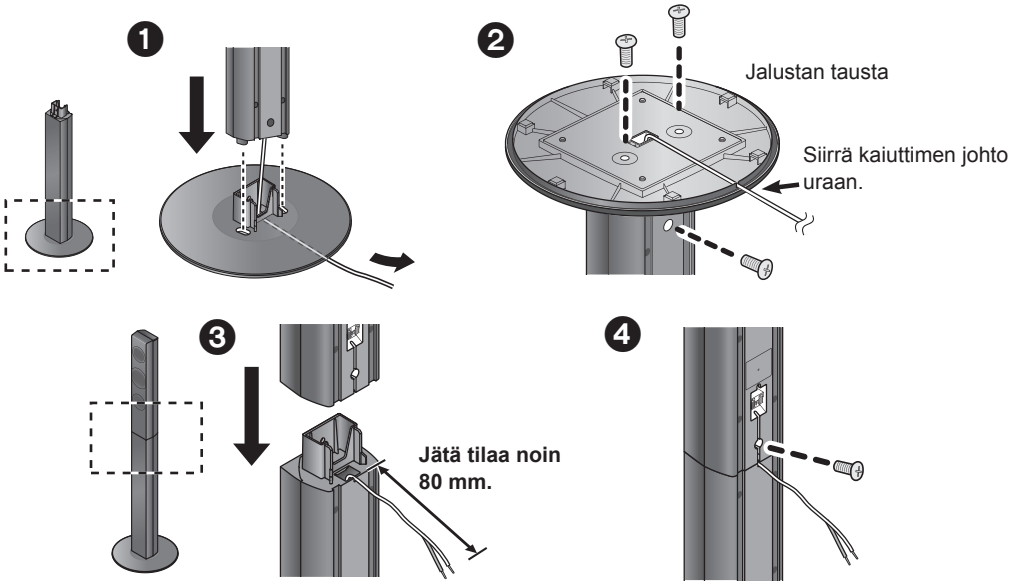

## VAIHE 2: Tarrojen kiinnittäminen johtoihin

esim. Etukaiutin V-kanav.

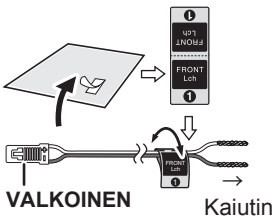

Kaiuttimen johdon tarra	Liitin
FRONT Lch ①	VALKOINEN
FRONT Rch ②	PUNAINEN
SURROUND Lch ③	SININEN
SURROUND Rch ④	HARMAA
CENTER ⑤	VIHREÄ
SUBWOOFER ⑥	PURPPURANPUNAINEN

## VAIHE 3: Kaiuttimen johtojen liittäminen

Tilääniikaiuttimilla ei ole eroa oikean ja vasemman välillä.

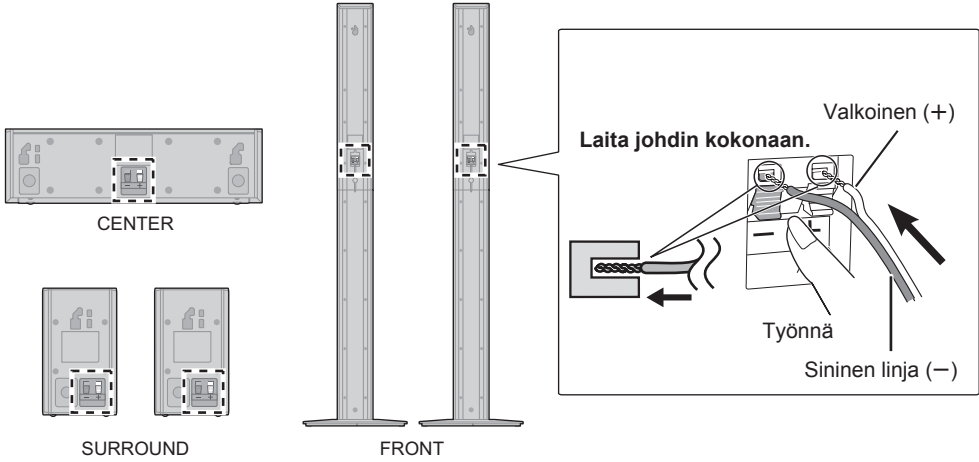

## VAIHE 4: Sijoita kaiuttimet

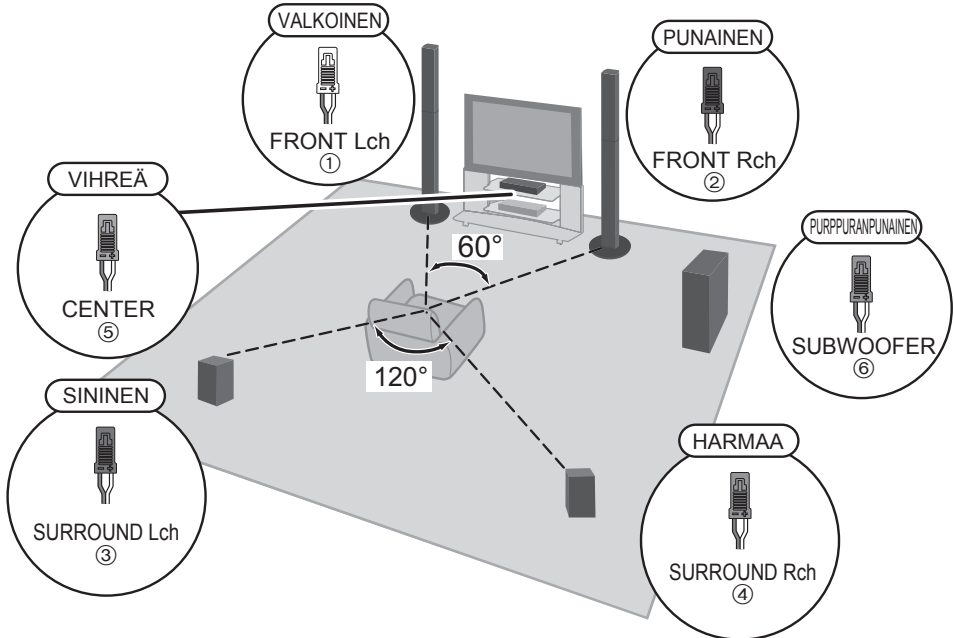

# VAIHE 5: Liitä johdot

Jos haluat lisätietoja liittämenetelmistä ja internet-ominaisuuksista, katso käyttöohjeita.

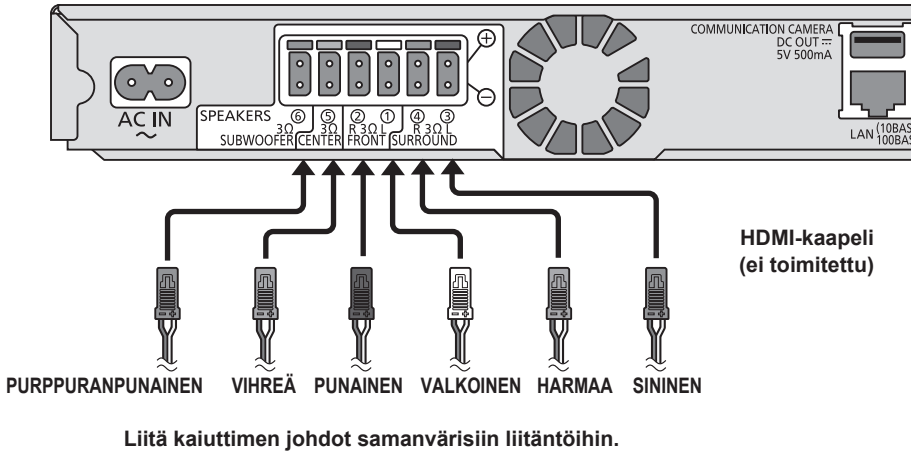

# VAIHE 6: Kytke järjestelmä päälle

1 Liitä verkkokaapeli.

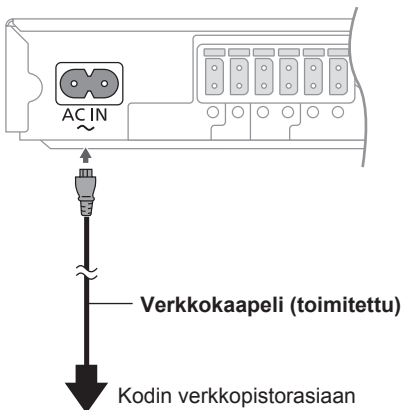

2 Kytke televisio päälle.

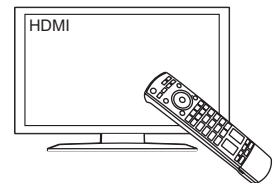

Aseta videon tulotila asentoon HDMI, jne.



Tarvitaan videojohto (ei toimitettu), jos haluat katsella iPod/iPhone olevia valokuvia/videoita.

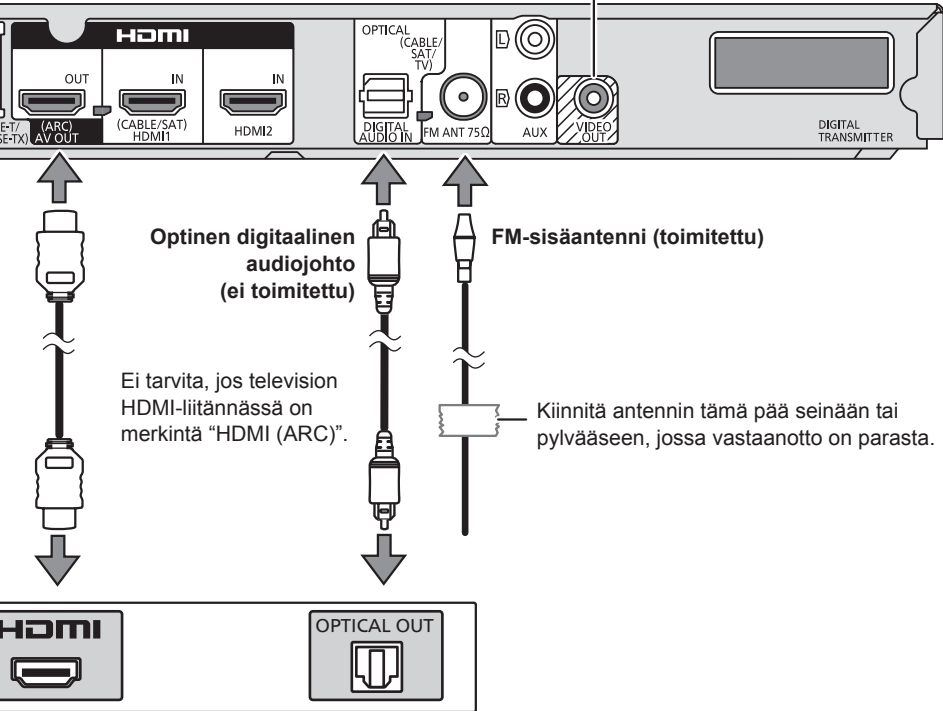

### 3 Kytke järjestelmä päälle.

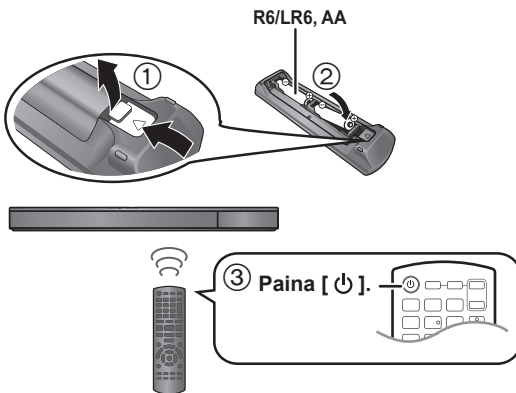

### 4 Helppo asetus käynnistyy.

Noudata näytön ohjeita.





---

Panasonic Corporation

**Web Site:** <http://panasonic.net>

Ge It Fr Sp Du Sw Da Fi