

Panasonic

Portable DVD/CD Player Operating Instructions

Model No. **DVD-LV50**



This manual was printed with soy based ink.

PalmTheater



As an ENERGY STAR® Partner, Panasonic has determined that this product meets the ENERGY STAR® guidelines for energy efficiency.

The region number of this unit is "1".
You can play DVD-Video marked "1",
"ALL", or with a region number including
"1".

Example:



Dear customer

Thank you for purchasing this product.

For optimum performance and safety, please read these instructions carefully.

Before connecting, operating or adjusting this product, please read these instructions completely. Please keep this manual for future reference.

For U.S.A. Only

The warranty can be found on pages 38 and 39.

WARNING:

TO REDUCE THE RISK OF FIRE, ELECTRIC SHOCK OR PRODUCT DAMAGE, DO NOT EXPOSE THIS APPARATUS TO RAIN, MOISTURE, DRIPPING OR SPLASHING AND THAT NO OBJECTS FILLED WITH LIQUIDS, SUCH AS VASES, SHALL BE PLACED ON THE APPARATUS.

CAUTION!

THIS PRODUCT UTILIZES A LASER. USE OF CONTROLS OR ADJUSTMENTS OR PERFORMANCE OF PROCEDURES OTHER THAN THOSE SPECIFIED HEREIN MAY RESULT IN HAZARDOUS RADIATION EXPOSURE. DO NOT OPEN COVERS AND DO NOT REPAIR YOURSELF. REFER SERVICING TO QUALIFIED PERSONNEL.

CAUTION!

DO NOT INSTALL, OR PLACE THIS UNIT, IN A BOOKCASE, BUILT-IN CABINET OR IN ANOTHER CONFINED SPACE. ENSURE THE UNIT IS WELL VENTILATED. TO PREVENT RISK OF ELECTRIC SHOCK OR FIRE HAZARD DUE TO OVERHEATING, ENSURE THAT CURTAINS AND ANY OTHER MATERIALS DO NOT OBSTRUCT THE VENTILATION VENTS.

CAUTION – VISIBLE AND INVISIBLE LASER RADIATION WHEN OPEN.
DO NOT STARE INTO BEAM.

ATTENTION – RAYONNEMENT LASER VISIBLE ET INVISIBLE EN CAS D'OUVERTURE.
NE PAS REGARDER DANS LE FAISCEAU.

(Bottom of product)

THE FOLLOWING APPLIES ONLY IN THE U.S.A.
CAUTION:

This equipment has been tested and found to comply with the limits for a Class B digital device, pursuant to Part 15 of the FCC Rules. These limits are designed to provide reasonable protection against harmful interference in a residential installation. This equipment generates, uses and can radiate radio frequency energy and, if not installed and used in accordance with the instructions, may cause harmful interference to radio communications. However, there is no guarantee that interference will not occur in a particular installation. If this equipment does cause harmful interference to radio or television reception, which can be determined by turning the equipment off and on, the user is encouraged to try to correct the interference by one or more of the following measures:

- Reorient or relocate the receiving antenna.
- Increase the separation between the equipment and receiver.
- Connect the equipment into an outlet on a circuit different from that to which the receiver is connected.
- Consult the dealer or an experienced radio/TV technician for help.

Any unauthorized changes or modifications to this equipment would void the user's authority to operate this device.

This device complies with Part 15 of the FCC Rules. Operation is subject to the following two conditions: (1) This device may not cause harmful interference, and (2) this device must accept any interference received, including interference that may cause undesired operation.

The following mark and symbols are located on bottom of the unit.



CAUTION: TO REDUCE THE RISK OF ELECTRIC SHOCK, DO NOT REMOVE SCREWS. NO USER-SERVICEABLE PARTS INSIDE. REFER SERVICING TO QUALIFIED SERVICE PERSONNEL.



The lightning flash with arrowhead symbol, within an equilateral triangle, is intended to alert the user to the presence of uninsulated "dangerous voltage" within the product's enclosure that may be of sufficient magnitude to constitute a risk of electric shock to persons.



The exclamation point within an equilateral triangle is intended to alert the user to the presence of important operating and maintenance (servicing) instructions in the literature accompanying the appliance.

Marking sign is located on bottom of the unit.

Batteries

1. Battery pack (Lithium ion battery pack)

- Use this unit to recharge the battery pack.
- Do not use the battery pack with equipment other than the specified player.
- Do not use the player outside if it is snowing or raining. (The battery pack is not waterproof.)
- Do not get dirt, sand, liquids, or other foreign matter on the terminals.
- Do not touch the plug terminals (+ and -) with metal objects.
- Do not disassemble, remodel, heat or throw into fire.

2. Button-type battery (Lithium battery)

- Insert with poles aligned.
- Do not touch the terminals (+ and -) with metal objects.
- Do not disassemble, remodel, heat or throw into fire.
- Keep out of reach of children.

If any electrolyte should come into contact with your hands or clothes, wash it off thoroughly with water.

If any electrolyte should come into contact with your eyes, never rub the eyes.

Rinse eyes thoroughly with water, and then consult a doctor.

3. Disposing of the batteries

Check and follow your local regulations before disposal.

CAUTION:

The batteries used in this device may present a risk of fire or chemical burn if mistreated. Do not disassemble or incinerate the batteries. Do not heat the batteries above the following temperatures.

Button-type battery 100 °C (212 °F)

Battery pack 60 °C (140 °F)

Do not recharge the button-type battery. Replace only with Panasonic part number indicated below:

Button-type battery (Lithium battery)
(for remote control) **CR2025**

Battery pack
(Lithium ion battery pack) **CGR-H603**

Optional battery pack
(Lithium ion battery pack) **CGR-H601**

Use of other batteries may present a risk of fire or explosion.

AC adaptor

This AC adaptor operates on AC between 100 V and 240 V.

But

- In the U.S.A. and Canada, the AC power supply cord must be connected to a 120 V AC power supply only.
- When connecting to an AC supply outside of the U.S.A. or Canada, use a plug adaptor to suit the AC outlet configuration.
- When connecting to a supply of greater than AC 125 V, ensure the cord you use is suited to the voltage of the AC supply and the rated current of the AC adaptor.
- Contact an electrical parts distributor for assistance in selecting a suitable AC plug adaptor or AC cord set.

CAUTION:

Use only Panasonic car adaptor DY-DC95.

A lithium ion/polymer battery that is recyclable powers the product you have purchased. Please call 1-800-8-BATTERY for information on how to recycle this battery.



THE FOLLOWING APPLIES ONLY IN THE U.S.A.

Notice:

This product has parts that contains a small amount of mercury. It also contains lead in some components. Disposal of these materials may be regulated in your community due to environmental considerations. For disposal or recycling information please contact your local authorities, or the Electronics Industries Alliance: <<http://www.eiae.org>>

Accessories

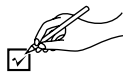

Please check and identify the supplied accessories. Use numbers indicated in parentheses when asking for replacement parts.

(For U.S.A.)

To order accessories contact

1-800-332-5368 or web site

(<http://www.panasonic.com>).

(For Canada)

To order accessories, call the dealer from whom you have made your purchase.

- Remote control 1
(N2QAHC000012)
- Button-type battery 1
for remote control
(for replacement, see below)
- Audio/video cable 1
(RJL3X001X15)
- AC adaptor 1
(DE-891AA)
- AC power supply cord 1
(RJA0065-A)
- Rechargeable battery pack 1
(for replacement, see below)

Optional accessories:

- Button-type battery (CR2025)
- Replacement rechargeable battery pack (CGR-H603:
Available from Panasonic dealers.)
- Optional rechargeable battery pack (CGR-H601)
- Car stereo cassette adaptor (RP-CC20)
- Car adaptor (DY-DC95)
- Mini optical digital audio cable (RP-CA2120)
- S video cable (RFX4139:
Available from Panasonic dealers.)

Available only in U.S.A.

- Carrying case (RP-SB220)
- Headphones (RP-HC100 or RP-HC70)

Note

The included AC power supply cord and AC adaptor are for use with this unit only. Do not use them with other equipment.

Table of contents

Getting Started

Accessories	4	Power supply	10
IMPORTANT SAFETY INSTRUCTIONS	6	AC adaptor	10
Control reference guide	7	Battery pack	10
Disc information	8	Car adaptor	11
The remote control	9		

Basic Operations

Adjusting the angle of the LCD	12	Starting play from a selected program, title, or track	16
Basic play	12	Repeat play	17
When a menu screen appears	13	Virtual surround with speakers and headphones (ADVANCED SURROUND)	17
Resume function	14	Using menus to play MP3 discs and CD text	18
Selecting programs to play— DIRECT NAVIGATOR	14	Menu play	18
Using the play list menu	15	Finding a track to play	19
Playing a play list	15	Changing the play sequence	20
Playing specific scenes	15	Program play	20
Convenient features	16	Random play	21
Skipping items	16	Changing soundtracks, subtitle languages and angles	21
Fast forward and rewind—SEARCH	16		
Slow-motion	16		
Frame-by-frame viewing	16		

Advanced Operations

Changing the monitor settings	22	Changing settings	26
Adjusting color intensity	22	Common procedures	27
Changing the size of the picture	22	Entering a password	28
Adjusting the brightness	22	Digital output	28
Using On-Screen Menu Icons	23	Using this unit with other equipment	29
Common procedures	23	Enjoying more powerful sound	29
Progress indicator	23	Using this unit with a television	30
Disc information	24	Recording to digital recording equipment or cassette tapes	32
Unit information	25	Using headphones	32

Reference

Glossary	33	Customer Services Directory (ONLY FOR U.S.A.)	39
Troubleshooting Guide	34	Product Service	40
Maintenance	37	Language code list	40
Limited Warranty (ONLY FOR U.S.A.)	38	Specifications	41

Operations in these instructions are described mainly with the main unit, but you can do the operations on the remote control if the controls are the same (➡ page 7).

Listening caution



Do not play your headphones or earphones at a high volume. Hearing experts advise against continuous extended play.

If you experience a ringing in your ears, reduce volume or discontinue use.

Do not use while operating a motorized vehicle. It may create a traffic hazard and is illegal in many areas.

You should use extreme caution or temporarily discontinue use in potentially hazardous situations.

Even if your headphones or earphones are the open-air type designed to let you hear outside sounds, don't turn up the volume so high that you can't hear what's around you. Sound can be deceiving. Over time your hearing "comfort level" adapts to higher volumes of sound. So what sounds "normal" can actually be loud and harmful to your hearing.

Guard against this by setting your equipment at a safe level BEFORE your hearing adapts. To establish a safe level:

- Start your volume control at a low setting.
- Slowly increase the sound until you can hear it comfortably and clearly, and without distortion.

Once you have established a comfortable sound level:

- Set the dial and leave it there.

IMPORTANT SAFETY INSTRUCTIONS

Read these operating instructions carefully before using the unit. Follow the safety instructions on the unit and the applicable safety instructions listed below. Keep these operating instructions handy for future reference.

- 1) Read these instructions.
- 2) Keep these instructions.
- 3) Heed all warnings.
- 4) Follow all instructions.
- 5) Do not use this apparatus near water.
- 6) Clean only with dry cloth.
- 7) Do not block any ventilation openings. Install in accordance with the manufacturer's instructions.
- 8) Do not install near any heat sources such as radiators, heat registers, stoves, or other apparatus (including amplifiers) that produce heat.
- 9) Do not defeat the safety purpose of the polarized or grounding-type plug. A polarized plug has two blades with one wider than the other. A grounding-type plug has two blades and a third grounding prong. The wide blade or the third prong are provided for your safety. If the provided plug does not fit into your outlet, consult an electrician for replacement of the obsolete outlet.
- 10) Protect the power cord from being walked on or pinched particularly at plugs, convenience receptacles, and the point where they exit from the apparatus.
- 11) Only use attachments/accessories specified by the manufacturer.
- 12) Use only with the cart, stand, tripod, bracket, or table specified by the manufacturer, or sold with the apparatus. When a cart is used, use caution when moving the cart/apparatus combination to avoid injury from tip-over.
- 13) Unplug this apparatus during lightning storms or when unused for long periods of time.
- 14) Refer all servicing to qualified service personnel. Servicing is required when the apparatus has been damaged in any way, such as power-supply cord or plug is damaged, liquid has been spilled or objects have fallen into the apparatus, the apparatus has been exposed to rain or moisture, does not operate normally, or has been dropped.



Do not rest the unit on your lap for a long time while using it. The unit can become hot and cause burns.

To prevent damage

Avoid the following:

- Spraying flammable insecticides near the unit.
- Pressing the LCD.
- Touching the lens and other parts of the laser pickup.

Do not use the unit in the following places:

- Where the temperature is below 5 °C (41 °F) or above 35 °C (95 °F). (Operating the unit beyond this range can cause the protection circuitry to function and render the unit inoperable.)
- Sandy places such as beaches.
- On top of cushions, sofas, or hot equipment such as amplifiers.

Control reference guide

Page

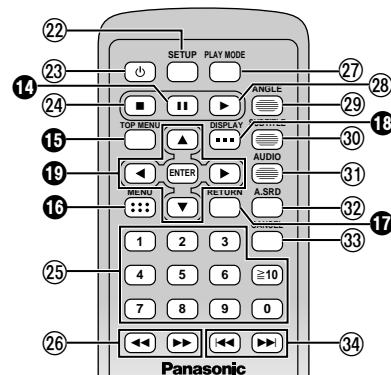
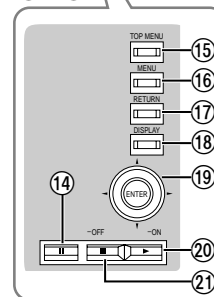
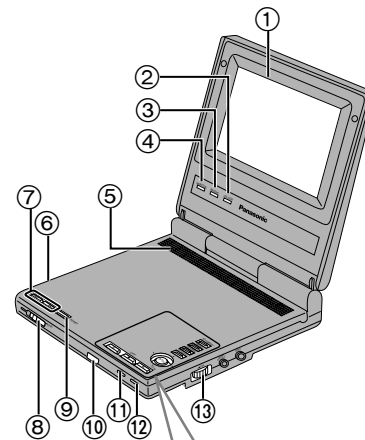

①	5-inch wide screen LCD	
②	Colour button (COLOUR)	22
③	Bright button (BRIGHT)	22
④	Monitor button (MONITOR)	22
⑤	Monaural speaker	
⑥	Headphone jack (🎧)	32
⑦	Skip/Slow/Search buttons (⏮, ⏭)	16
⑧	Disc lid switch (◀ OPEN)	13
⑨	Repeat button (REPEAT)	17
⑩	Remote control signal sensor	
⑪	Charge indicator (CHG)	10
⑫	Standby indicator (⏻)	10
⑬	Volume dial (◀ VOL)	13
⑭	Pause button (⏸)	13
⑮	Top menu button (TOP MENU)	13, 14, 18
⑯	Menu button (MENU)	13, 15, 27
⑰	Return button (RETURN)	14
⑱	Display button (DISPLAY)	11, 23
⑲	Cursor jockey (▲, ▼, ◀, ▶)	
	Enter button (ENTER)	13
	Slide the cursor jockey in the direction you want to move the cursor.	
⑳	Play/On button (▶, - ON)	13
㉑	Stop/Off button (■, - OFF)	13
㉒	Setup button (SETUP)	27, 31
㉓	Standby/on switch (⏻)	13
㉔	Stop button (■)	13
㉕	Numbered buttons (1-9, 0, ≧10)	13
㉖	Slow/Search buttons (◀▶)	16
㉗	Play mode button (PLAY MODE)	20
㉘	Play button (▶)	13
㉙	Angle button (ANGLE)	21
㉚	Subtitle button (SUBTITLE)	21
㉛	Audio button (AUDIO)	21
㉜	Advanced surround button (A.SRD)	17
㉝	Cancel button (CANCEL)	20
㉞	Skip buttons (⏮, ⏭)	16

Buttons such as ⑭ function the same as the controls on the unit.

Discs that can be played

DVD-RAM	DVD-Video	DVD-R	Audio CD	Video CD
RAM RAM 4.7	VIDEO	R R 4.7	COMPACT disc DIGITAL AUDIO	COMPACT disc DIGITAL VIDEO
Indication used in instructions				
RAM	DVD-V	CD*	VCD	

*Including CD-R/RW and discs recorded with MP3.

Do not use irregularly shaped discs (e.g. heart-shaped), as these can damage the unit.

Discs that cannot be played

DVD-Audio, PAL discs, DVD-RAM (2.6 GB, TYPE 1), DVD-ROM, CD-ROM, CDV, CD-G, +RW, DVD-RW, CVD, SVCD, SACD, Divx Video Discs and Photo CD.

DVDs that can be played

You can play discs with these symbols.

Playing DVDs and Video CDs

The producer of the material can control how these discs are played. This means that you may not be able to control play of a disc with some operations described in these operating instructions. Read the disc's instructions carefully.

CD-R and CD-RW discs

This unit can play CD-R and CD-RW if they are formatted as CD-DA (digital audio) or video CD and finalized*.

DVD-R discs

Panasonic DVD-R recorded and finalized* on a Panasonic DVD video recorder are played as DVD-Video on this unit.

*A process that allows play on compatible equipment.

DVD-RAM discs

DVD-RAM discs must meet the following conditions for this unit to be able to play them.

Type	<ul style="list-style-type: none"> • Non-cartridge discs • Discs that can be removed from their cartridges (TYPE 2 and 4)
Capacity	<ul style="list-style-type: none"> • 12 cm (5") 9.4 GB (double-sided) and 4.7 GB (single-sided) • 8 cm (3") 2.8 GB (double-sided)
Recording format	Discs recorded with DVD video recorders, DVD video cameras, personal computers, etc., using Version 1.1 of the Video Recording (VR) Format (a unified video recording standard).

- Remove TYPE 2 and 4 discs from their cartridges before use, then return them when you are finished. Read the instructions for the disc carefully.

- Some parts of the disc, for example where one program ends and another begins, may not play smoothly.

Note

It may not be possible to play CD-R, CD-RW, DVD-R and DVD-RAM in all cases due to the type of disc or condition of the recording.

To clean discs

DVD-Video, CD, Video CD

Wipe with a damp cloth and then wipe dry.

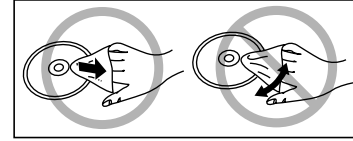

DVD-RAM, DVD-R

- Clean only with DVD-RAM/PD disc cleaner available as an optional accessory, part number LF-K200DCA1.
- Never use cloths or cleaners for CDs, etc.

Handling precautions

- Do not write on the label side with a ball-point pen or other writing instrument.
- Do not use record cleaning sprays, benzine, thinner, static electricity prevention liquids or any other solvent.
- Do not attach labels or stickers to discs.
- Do not use discs with exposed adhesive from tape or left over peeled off stickers.
- Do not use scratch-proof protectors or covers.
- Do not use discs printed with label printers available on the market.

Battery (Lithium battery)

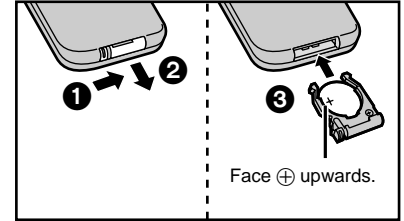

Use

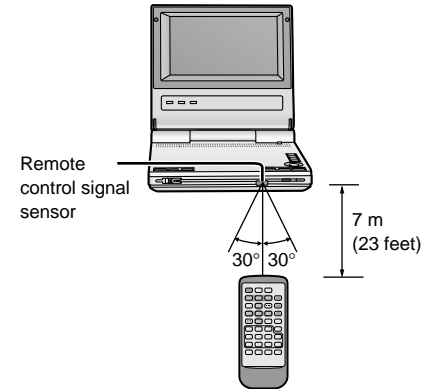

Aim at the sensor, avoiding obstacles, at a maximum range of 7 m (23 feet) directly in front of the unit.

AC adaptor

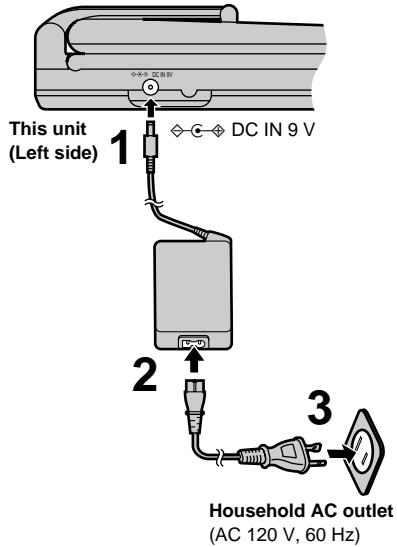

The unit is in the standby condition (the [⏻] indicator lights) when the AC power supply cord is connected. The primary circuit is always "live" as long as the AC adaptor is connected to an electrical outlet.

■ When the unit is not going to be used for a long time

The unit consumes 0.9 W when in standby mode. To conserve power, disconnect the AC power supply cord from the AC outlet.

Battery pack (included and optional) (Lithium ion battery pack)

- The illustrations show connection for the included rechargeable battery pack (CGR-H603). Connect the optional rechargeable battery pack (CGR-H601) in the same way.
- Charge the battery packs before using them for the first time.

■ To attach

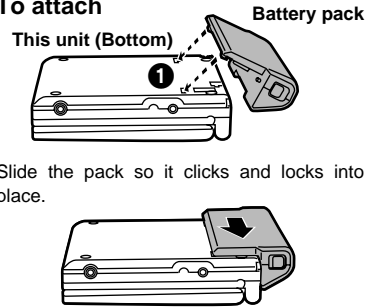

■ To recharge (When the unit is off)

Connect to the household AC outlet while the battery pack is attached (see left).

Recharging

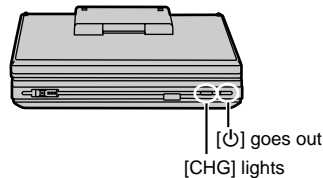

Recharging is complete when [CHG] goes out. ([⏻] lights.) Disconnect the AC power supply cord and AC adaptor.

■ To detach

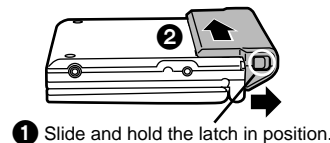

■ Approximate recharging and play times in hours

(Actual times depend on operating conditions. Times for the optional rechargeable battery pack are shown in parentheses.)

Recharging [at 20 °C (68 °F)]	LCD brightness level	Play time	
		LCD on	LCD off
4 (6)	-5	2.5 (4)	3 (6)
	0 (factory preset)	2 (3.5)	
	5	1.5 (3)	

- To change the LCD brightness (→ page 22).

■ If play time dramatically reduces after recharging

The battery pack has reached the end of its service life (it can be recharged about 300 times).

■ To confirm the battery charge

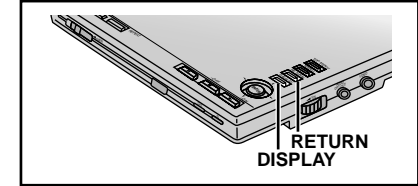

When the unit is on, press [DISPLAY]. The battery display appears on the LCD for a few seconds to show the approximate remaining charge.

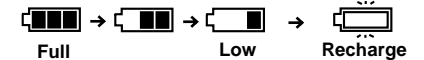

(Appears automatically when there is a few minutes of charge remaining.)

- Press [RETURN] to clear the on-screen menu icons.

■ If the unit is not to be used for a long time

- Detach the battery pack. (Even if the unit is off, it still uses some power. This can lead to over discharging of the battery and malfunction.)
- Recharge the battery pack when you are ready to use it again.

Car adaptor (optional)

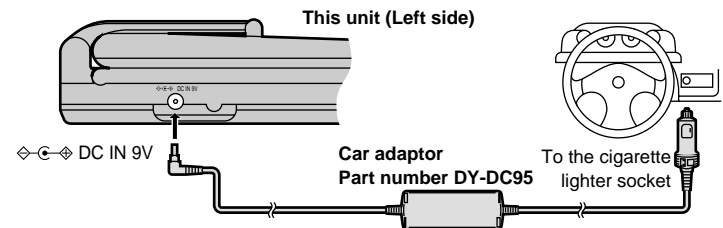

Note

- Read the car adaptor's operating instructions carefully.
- In the interests of the traffic safety, do not perform operations on the unit or view video software while driving a vehicle.
- You can enjoy sound through your car audio system by connecting a car stereo cassette adaptor (→ page 4) to this unit's headphone jack.

Adjusting the angle of the LCD

The LCD can be set to different angles to suit your viewing style.

Open the LCD

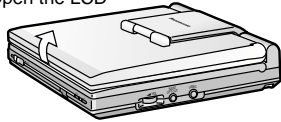

Traditional Viewing

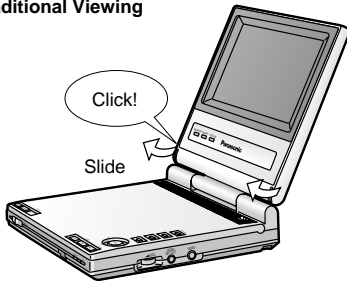

Enhanced Angle Viewing



Compact viewing

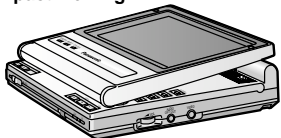

Note

Close the LCD when carrying it.

Basic play

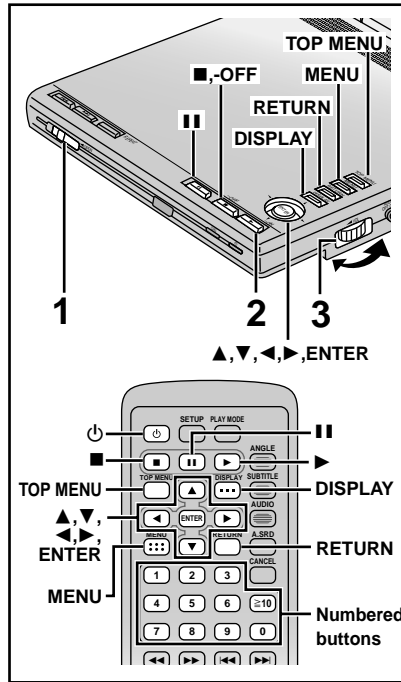

Note

- If "⊘" appears on the LCD
The operation is prohibited by the unit or disc.
- Discs continue to rotate while menus are displayed even after playing an item. Press [■] when you finish to preserve the unit's motor and LCD.
- The surface of the unit may become warm if it is used for a long time, but this is normal and not an indication of malfunction.
- It takes about 30 seconds for the unit to read DVD-RAM before play.

The LCD
Some of the LCD's pixels (less than 0.01 %) may light constantly or fail to light. This is normal and does not indicate a malfunction.

RAM DVD-V CD VCD

Preparations

Open the LCD (⇒ page 12).

The menu language is set to English, but you can change it to French or Spanish (⇒ page 27, Display—Menu Language). English is used in the examples.

1 Slide [◀ OPEN] to open the disc lid and insert a disc.

RAM

Remove TYPE 2 and 4 discs from their cartridges before use.

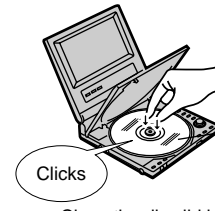

Close the disc lid by hand.

Label up.
(With double-sided discs, load so the label for the side you want to play is facing up.)

When a menu screen appears

DVD-V VCD

Press the numbered buttons to select an item.

To select a 2-digit number

e.g. 25: [≥10]→[2]→[5]

- When playing DVDs, you can also use [▲, ▼, ◀, ▶] to select items. Press [ENTER] to confirm your selection.
- Read the disc's instructions for further details about operation.

To return to the menu screen

DVD-V

Press [TOP MENU] or [MENU].

- DVD can have several menus. [TOP MENU] and [MENU] may call up different menus.

VCD

Press [RETURN].

2 Press and hold [▶, - ON] to start play.

The unit comes on automatically.

CD

On-screen menu icons (⇒ page 23) and disc information (MP3 and CD text) appear on the LCD.

3 Adjust the volume. Using headphones (⇒ page 32)

To stop play

Press [■] (⇒ page 14, Resume function).

To pause play

Press [||] during play.

Press [▶] (Play) to restart play.

To turn the unit off

Press and hold [■, - OFF] until "OFF" appears on the LCD.

Turning the unit on and off with the remote control

Press [⏻].

- You cannot use the remote control to turn the unit on when powered by the battery pack.

To see the elapsed play time

Press [DISPLAY] to show the on-screen menu icons (⇒ page 23).

Auto power-off function

The unit automatically turns off after being stopped for 15 minutes (5 minutes when the battery pack is being used).

Resume function

RAM DVD-V CD VCD

The position you stopped play at is recorded by the unit when "▶" flashes on the LCD. While "▶" is flashing, press [▶] (Play) to start play from where you stopped it.

(DVD-V → Chapter Preview, see right)

• This only works if the disc's elapsed play time is shown in the on-screen menu icons (→ page 23).

- It is cleared if you open the disc lid.
- The unit saves the position even when you switch the unit to standby except when playing a play list (→ page 15).
- Press [■] to clear the position.

Chapter Preview DVD-V

The following message appears immediately after you press [▶] (Play).

Press PLAY to Preview Chapters

Press [▶] (Play) while the message is displayed and the beginning portions of each chapter up to the current one are played. Full play resumes from the point where you stopped play. (This feature works only within a title.) If you do not press [▶] (Play), the message disappears and play starts from where you stopped it.

Selecting programs to play—
DIRECT NAVIGATOR

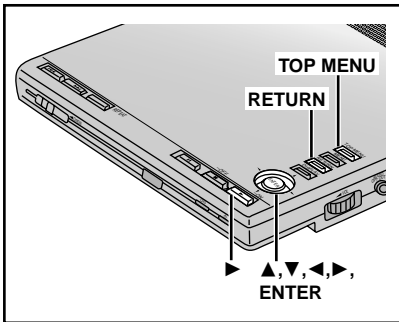

RAM

Use the program list to find programs to play.

1 Press [TOP MENU].

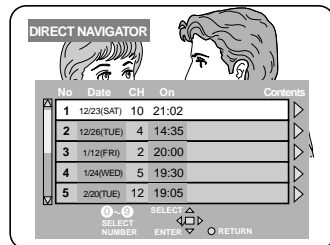

2 Use [▲, ▼] to select the program.

The selected program plays in the background.

- Move the cursor jockey [▼] to show other programs if there are more than five.
- You can select programs with the numbered buttons (remote control).

To enter a 2-digit number
e.g. 25: [≧10]→[2]→[5].

3 Press [ENTER].

Play of the program that was playing in the background continues.

To clear the program list

Press [TOP MENU].
(The unit returns to the condition it was in before you called up the program list.)

To display information about a selected program

Select the program and move the cursor jockey [▶]. (The background picture pauses.) Use [◀, ▶] to show the other programs.

To return to the previous screen
Press [RETURN].

For your reference

- Titles appear only if you have entered them.
- You cannot change program and disc titles.

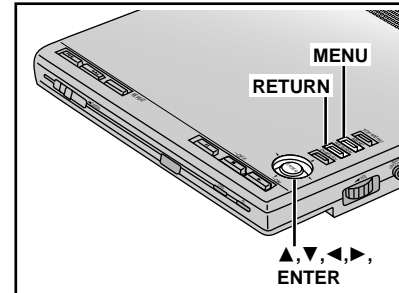

RAM

You can play a group of scenes, a play list, created on other equipment such as a DVD video recorder.

You can also specify scenes to play.

Playing a play list

1 Press [MENU].

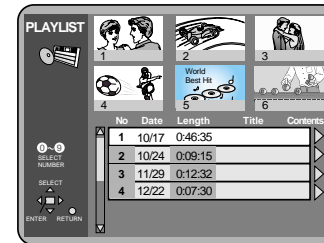

2 Use [▲, ▼] to select the play list.

- Move the cursor jockey [▼] to show other play lists if there are more than six.
- You can select with the numbered buttons (remote control).

To enter a 2-digit number
e.g. 25: [≧10]→[2]→[5].

3 Press [ENTER] to start play.

To display information about a play list

1. Select the play list and move the cursor jockey [▶].
2. Use [▲, ▼] to select "Contents" and press [ENTER].
Use [◀, ▶] to show other play lists.

To clear the play list screen

Press [MENU].
(The unit returns to the condition it was in before you called up the play list.)

Playing specific scenes

- 1 Press [MENU].
- 2 Use [▲, ▼] to select the play list.
• You can select with the numbered buttons (remote control).
To enter a 2-digit number
e.g. 25: [≧10]→[2]→[5].
- 3 Move the cursor jockey [▶].
- 4 Use [▲, ▼] to select "Scene List" and press [ENTER].



5 Use [▲, ▼, ◀, ▶] to select a scene and press [ENTER].

The scene starts playing.
• If there are more than 9 scenes, use [▲, ▼, ◀, ▶] to select "Next" and press [ENTER]. Select "Prev" to move back.

- You can also select a page with the numbered buttons (remote control).

To enter a page number
e.g. 25: [2]→[5]→[ENTER].
e.g. 111: [1]→[1]→[1]→[ENTER].

To return to the previous screen
Press [RETURN].

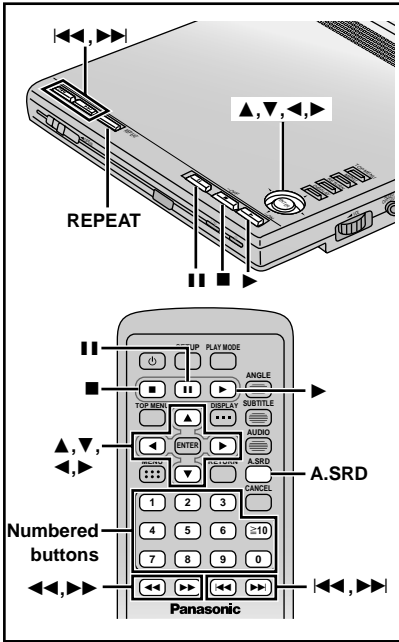

Skipping items

RAM DVD-V CD VCD

You can skip chapters on DVD-Video, tracks on CDs and Video CDs, and on DVD-RAM you can skip to the start of a program, scene in a play list, or to a marker.

During play or while paused

Press [**◀◀**] or [**▶▶**].

Each press increases the number of skips.

Fast forward and rewind—SEARCH

RAM DVD-V CD VCD

During play

<On the main unit>

Press and hold [**◀◀**] or [**▶▶**].

<On the remote control>

Press [**◀◀**] or [**▶▶**].

- Audio will be heard during search. You can turn this audio off if you want to (⇒ page 26, Audio—Audio during Search).

Slow-motion

RAM DVD-V VCD

While paused

<On the main unit>

Press and hold [**◀◀**] or [**▶▶**].

<On the remote control>

Press [**◀◀**] or [**▶▶**].

Frame-by-frame viewing

RAM DVD-V VCD

While paused

Use [**◀**] or [**▶**].

- Hold in position to move the frames in succession.
- Pressing [**||**] also activates forward frame-by-frame.

Notes

- The speed of search and slow-motion increases up to 5 steps.
- Press [**▶**] (Play) to restart play.
- You cannot move backwards with Video CD during frame-by-frame and slow-motion.

When playing Video CDs with playback control

Pressing buttons to perform skip, search or slow-motion may take you to a menu screen.

Starting play from a selected program, title, or track

RAM DVD-V CD VCD

Remote control only

Press the numbered buttons to select the item.

Play starts from the selected item.

To select a 2-digit number

e.g. 25: [**≥10**]→[2]→[5]

[CD] (MP3 discs) [2]→[5]→[ENTER]

If the on-screen menu icons are on the LCD (⇒ page 23)

- This works only when stopped with some discs.

Repeat play

Main unit only

RAM DVD-V CD VCD

During play

Press [**REPEAT**].

e.g. DVD-Video

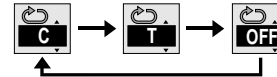

Each time you press the button:

RAM

Program (PG)→Entire disc (A)→OFF

During play list play

Scene (S)→Play list (PL)^{#1}→OFF

DVD-V

Chapter (C)→Title (T)^{#2}→OFF

CD VCD

Track (T)→Entire disc (A)→OFF

CD (MP3 discs)

Track (T)→Group (G)^{#2}→OFF

^{#1} "PL" is not displayed while playing a specific play list scene.

^{#2} "All (A)" during program and random play.

If the Video CD has playback control

1. Press [**■**].
2. Press the numbered buttons to select a track to start play (⇒ page 16).
3. Press [**REPEAT**] (⇒ above).

Note

- This only works if the disc's elapsed play time is shown in the on-screen menu icons (⇒ page 23).
- You cannot use repeat play to repeat an entire DVD-Video, an entire MP3 disc or all the play lists on a DVD-RAM.

To repeat only your favorite tracks/chapters

Start program play (⇒ page 20) and press [**REPEAT**] to display "A".

Virtual surround with speakers and headphones (ADVANCED SURROUND)

RAM DVD-V VCD

Remote control only

Enjoy a surround-like effect with speakers (SP) (on other equipment) or headphones (HP). If the disc has surround effects, the effect is broadened and sound seems to come from virtual speakers on either side.

SP: Dolby Digital, DTS, MPEG, LPCM, 2-channel or over only

HP: Dolby Digital, MPEG, LPCM, 2-channel or over only

Preparation

Turn off the surround effects on the other equipment and reduce the volume on this unit to minimum (⇒ page 13).

Press [A.SRD] to select the level.

Each time you press the button:

e.g. SP

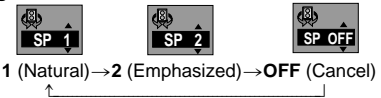

1 (Natural)→2 (Emphasized)→OFF (Cancel)

To change the mode

1. Press [**◀**] to select "SP" or "HP".
2. Press [**▲**, **▼**] to change the mode.

Optimum seating position

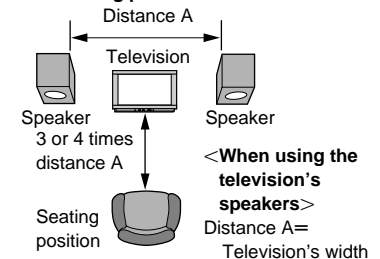

Note

- ADVANCED SURROUND will not work, or will have less effect, with some discs.
- Turn ADVANCED SURROUND off if it causes distortion.
- The speaker on this unit will not produce any discernable effect.

Using menus to play MP3 discs and CD text

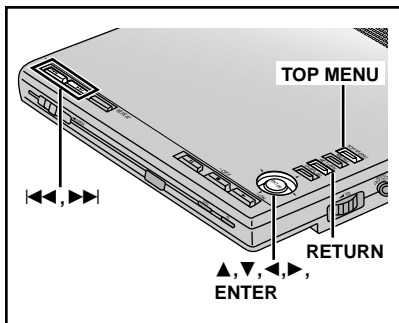

CD (MP3 discs, CD text)

Menu play

MP3 discs

This unit can play MP3 files recorded on CD-R/RW with a computer.

Files are treated as tracks and folders are treated as groups.

CD text discs

This unit reads and displays the information on CD text discs. You can display disc titles, artist names and track titles.

1 Press [TOP MENU].

e.g. MP3 Group name (MP3 discs only)

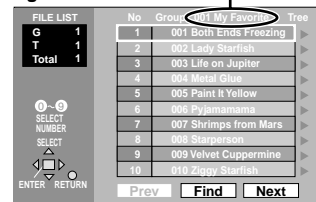

2 Use [▲, ▼] to select the track and press [ENTER].

Play starts and continues to the end of the disc.

"□" indicates the track currently playing.

Note

MP3 discs

- Discs must conform to ISO9660 level 1 or 2 (except for extended formats). MP3 files must have the extension ".MP3" or ".mp3".
- This unit is compatible with multi-session but if there are a lot of sessions it takes more time for play to start. Keep the number of sessions to a minimum to avoid this.
- This unit is not compatible with ID3 tags.
- This unit is not compatible with files with a sampling rate of 32 kHz.
- If you play an MP3 track that includes still picture data, it will take some time before the music itself starts playing and the elapsed time will not be displayed during this time. Even after the track starts, the correct play time will not be displayed.

Naming folders and files

At the time of recording, prefix folder and file names with 3-digit numbers in the order you want to play them (this may not work at times).

Example: root

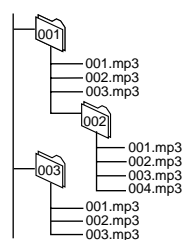

CD text discs

When making your own CD text discs

Do not put tracks into folders.

The unit plays the tracks in the order you record them so you do not have to prefix the titles with numbers.

Using the tree screen to find a group (MP3 discs)

1 Use [▶] (Cursor jockey) while a track is highlighted to display the tree screen.



You cannot select groups that contain no compatible files.

2 Use [▲, ▼] to select a group and press [ENTER].

The file list for the group appears.

For your reference

Use [◀, ▶] to jump layers in the tree screen.

To return to the file list screen

Press [RETURN].

Show the text information for a track (CD text discs)

1 Use [▲, ▼] to select a track.



2 Move the cursor jockey [▶].

Use [◀, ▶] to select other tracks. Press [ENTER] to play tracks selected here.

To return to the list screen

Press [RETURN].

Finding a track to play

Enter part of a track title to make a search. Although the characters are upper case, the unit also searches for lower case.

Preparation

Press [TOP MENU] to show the list screen.

Example: search for tracks including the word "LOVE".

1 Use [▲, ▼] to select "Find" and press [ENTER].

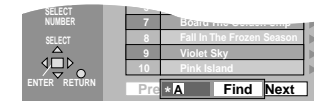

2 Use [▲, ▼] to select "L" and press [ENTER].

Characters change in alphanumeric order each time you move the cursor jockey [▲].

Press [◀, ▶] to skip between A, E, I, O, and U.

Use [◀] to erase a character.

Repeat this step to enter "O", "V", and "E".

3 Use [▶] (Cursor jockey) to select "Find" and press [ENTER].

The search results screen appears.

4 Use [▲, ▼] to select the track and press [ENTER].

Move the cursor jockey [▼] to show other tracks if there are more than fourteen.

To search for the first word in a title, erase the asterisk (*) first.

You can also enter numbers with the numbered buttons (remote control).

Use [▲, ▼, ◀, ▶] to select "Prev" or "Next" and press [ENTER].

Press [TOP MENU].

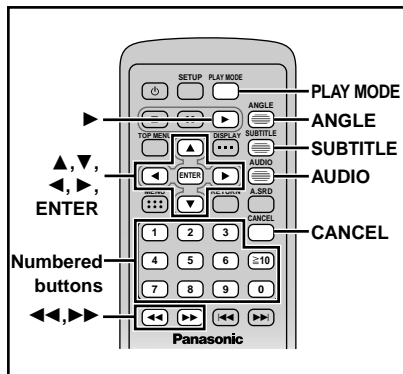

3 Press the numbered buttons to select a track (CD or VCD) or chapter (DVD-Video) (MP3 discs only) and press [ENTER].

- Repeat steps 2 and 3 to program other items.
- Times are not displayed when programming DVD-Video and MP3.

4 Press [▶] (Play). Play now begins in the programmed sequence.

To add, change, or clear items

- 1 Press [▲, ▼] to select the program number (No).
- 2 Do steps 2 and 3 above to add or change items. Press [CANCEL] to clear an item (or press [▲, ▼, ◀, ▶] to select "Clear" and press [ENTER]).

To move to the page before or after the one shown

Press [◀◀] or [▶▶].

To clear the whole program

Move to "Clear all" with [▲, ▼, ◀, ▶] and press [ENTER].

To exit the program mode

Press [PLAY MODE] while stopped until the program play screen disappears.

- The program is retained in memory.

To select an item using the cursor buttons

Press [ENTER] and [▲, ▼] to select an item, then press [ENTER] again to register the number. All the items on a disc, a title or a group are selected when you select "ALL".

Note

- The whole program is cleared when the unit is turned off, or the disc lid is opened.

DVD-V

- Different titles have different soundtracks and subtitles.
- Some items cannot be played even if you programmed them.

Random play

While stopped

1 Press [PLAY MODE] until the random play screen appears.

e.g. CD

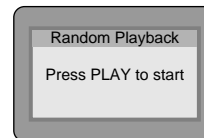

2 DVD-Video only

Press the numbered buttons to select a title.

3 Press [▶] (Play).

Play now begins in random order.

- Some titles cannot be selected. DVD-V

To exit the random mode

Press [PLAY MODE] while stopped until the random play screen disappears.

Changing soundtracks, subtitle languages and angles

Remote control only

Some DVDs have multiple soundtracks, subtitle languages and camera angles, and you can change these during play.

- "—" or "—" is displayed instead of the language number in circumstances such as when no language is recorded on the disc.

Soundtracks

RAM DVD-V

During play

Press [AUDIO].

The number changes each time you press the button.



- You can also use this button to turn the vocals on and off on karaoke discs. Read the disc's instructions for details.
- Refer to B on page 24 for audio signal type details.

Subtitles

DVD-V: You can change the subtitle number and turn the subtitles on and off.

RAM: You can turn the subtitles on and off.

During play

Press [SUBTITLE].

The number changes each time you press the button.

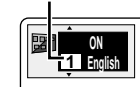

- In some cases, the subtitle language is not changed to the selected one immediately.
- If the subtitles overlap closed captions recorded on discs, turn the subtitles off.

To clear/display the subtitles

1. Press [SUBTITLE].
2. Press [▶]. (DVD-V)
3. Press [▲, ▼] to select "ON" or "OFF".

Angles

DVD-V

During play

Press [ANGLE].

The number changes each time you press the button.

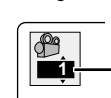

DVD-V CD VCD

Remote control only

Program play

You can select up to 32 tracks/chapters to play in the order you choose.

While stopped

1 Press [PLAY MODE] until the program play screen appears.

e.g. CD

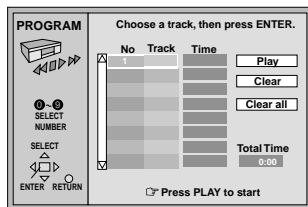

2 DVD-Video, MP3 discs only

Press the numbered buttons to select a title (DVD-Video) or group (MP3 discs).

- Some items cannot be selected.

Changing the monitor settings

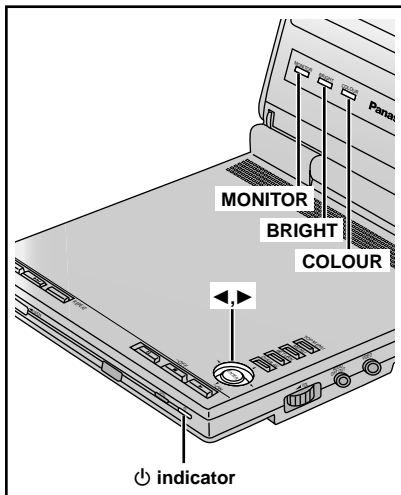

RAM DVD-V VCD

Adjusting color intensity

- 1 Press [COLOUR].
- 2 Use [◀, ▶] to adjust the color shade.
-5: light ↔ 5: dark
- 3 Press [COLOUR] to clear the display.

Changing the size of the picture

Press [MONITOR].

Each time you press the button:

NORMAL → FULL
↑ OFF (no picture) ← ZOOM ←

The picture mode and size

The picture shown on the LCD depends on the mode and the size recorded on the disc (→ below).

- If you are not using the LCD on this unit, select "OFF" (no picture) to conserve power. (The [⏻] indicator flashes.)
- The LCD turns off if you close it.
- Horizontal lines may appear in the picture when the mode is switched to "ZOOM", but this is not an indication of malfunction.

Adjusting the brightness

- 1 Press [BRIGHT].
- 2 Use [◀, ▶] to adjust the brightness.
-5: dark ↔ 5: light
Power consumption increases with the level of brightness.
- 3 Press [BRIGHT] to clear the display.

Note

These changes are effective only for this unit's LCD. Make changes to the television's settings if you have connected one.

Mode Software	NORMAL	FULL	ZOOM
Widescreen	Full screen 	Full screen 	Top and bottom cut off.
4:3	Black bands on the right and left. 	Stretched horizontally. 	Top and bottom cut off.
4:3, (Letterbox)	Black frame. 	Stretched horizontally. 	Full screen

Using On-Screen Menu Icons

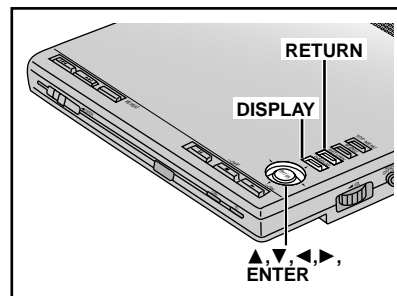

On-Screen menu icons contain information about the disc or unit. These menus allow you to perform operations by changing this information.

Common procedures

RAM DVD-V CD VCD

1 Press [DISPLAY].

Each time you press the button:

Disc information → Progress indicator

Original display ← Unit information
(→ step 2)

2 Unit information only

While the leftmost icon is highlighted

Use [▲, ▼] to select the menu.

Each time you use the cursor jockey:

Play menu ↔ Video menu
↕
Display menu ↔ Audio menu

3 Use [◀, ▶] to select the item.

4 Use [▲, ▼] to select the setting.

- Items with "▲" or "▼" above and below can be changed by [▲, ▼].
- Press [ENTER] if the setting does not change after using [▲, ▼].
- Some items require different operations. Read the explanations on the following pages.

For your reference

- Depending on the condition of the unit (playing, stopped, etc.) and the type of software, there are some items you cannot select or change.
- When numbers are displayed (e.g. title No.), the numbered buttons (remote control) are also effective for setting. After entering numbers, press [ENTER] to register the setting.

To clear the icons

Press [RETURN] until they clear.

■ To change the position of the icons

1. Use [◀, ▶] to select the rightmost icon.
2. Use [▲, ▼] to move the icons.
(There are 5 positions.)

Progress indicator

Indicates how far you have played through an item.

e.g. DVD-Video

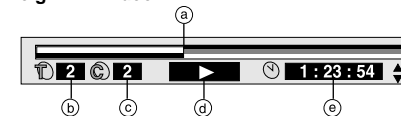

- Current position RAM DVD-V CD VCD
- PG: Program number RAM
PL: Play list number RAM
T: Title number DVD-V
T: Track number CD VCD
G: Group number CD (MP3 discs)
- C: Chapter number DVD-V
T: Track number in group CD (MP3 discs)
- Condition-play, pause, or slow/search RAM DVD-V CD VCD
- Changing the time display RAM DVD-V CD VCD

- Use [▲, ▼] to show the elapsed play time or remaining time for the program, track or title (or chapter during program and random play).

Elapsed play time CD (MP3 discs)
(display only, cannot be changed)

Disc information

e.g. DVD-Video

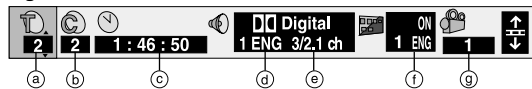

e.g. MP3 disc

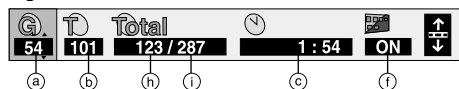

e.g. Video CD

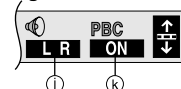

- a **PG: Program number** **RAM**
PL: Play list number **RAM**
T: Title number **DVD-V**
T: Track number **CD** **VCD**
G: Group number **CD** (MP3 discs)
C: Chapter number **DVD-V**
T: Track number in group **CD** (MP3 discs)
- c **Time** **RAM** **DVD-V**
 - Use [▲, ▼] to show the elapsed play time or remaining time for the program or title (or chapter during program and random play).
 - Select a position to start play by specifying a time with the numbered buttons and press [ENTER].**Changing the time display** **CD** **VCD**
 Use [▲, ▼] to show the elapsed play time, remaining time for the track, or remaining time for the disc.
Elapsed play time **CD** (MP3 discs) (display only, cannot be changed)
- d **Soundtrack language** **RAM** **DVD-V** (⇒ page 21) (See **A** below for language abbreviations.)
- e **Audio signal type** **RAM** **DVD-V** (⇒ page 21) (See **B** below for details.)
Karaoke vocal on/off (Karaoke DVD only) **DVD-V**
 Solo: OFF or ON
 Duet: OFF, 1+2, V1 or V2
- f **Subtitle language** **DVD-V** (⇒ page 21) (See **A** below for language abbreviations.)
Subtitles on/off **RAM** **DVD-V**
 ON↔OFF
Track information display on/off **CD** (MP3 discs, CD title discs) ON↔OFF
- g **Angle number** **DVD-V** (⇒ page 21)
- h **Track number in disc** **CD** (MP3 discs)
- i **Total number of tracks on disc** **CD** (MP3 discs)
- j **Audio mode** **RAM** **VCD**
 LR↔L↔R↔R↔L
- k **Menu play** **VCD** (with playback control only) Indicates whether menu play (playback control) is on or off.

A Audio/Subtitle language

ENG: English ESP: Spanish DAN: Danish CHI: Chinese VIE: Vietnamese
 FRA: French NLD: Dutch POR: Portuguese KOR: Korean THA: Thai
 DEU: German SVE: Swedish RUS: Russian MAL: Malay *: Others
 ITA: Italian NOR: Norwegian JPN: Japanese

B Signal type/data

LPCM/Digital/DTS/MPEG: Signal type b (bit): Number of bits
 k (kHz): Sampling frequency ch (channel): Number of channels

Example: 3/2_1ch

- L: Subwoofer signal (not displayed if there is no subwoofer signal)
- 0: No surround
- 1: Mono surround
- 2: Stereo surround (left/right)
- 1: Center
- 2: Front left+Front right
- 3: Front left+Front right+Center

Unit information

Play menu

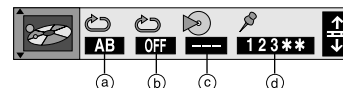

- a **A-B repeat** **RAM** **DVD-V** **CD** **VCD**
 [ENTER] (start point) ⇒ [ENTER] (finish point)
 To cancel: [ENTER]
 • This feature works only within a program/track/title.
 • The unit automatically determines the end of a program/track/title as point B when the end of the program/track/title is reached.
 • Subtitles around point A or B may fail to appear.
- b **Repeat play** (⇒ page 17)
- c **Play mode display** **DVD-V** **CD** **VCD**
 ---: Normal play
 PGM: Program play
 RND: Random play
- d **Marker** **DVD-V** **CD** **VCD**: 5 positions
RAM: 999 positions
 If places have been marked (e.g., with a DVD video recorder), they are displayed.
 [ENTER] ⇒ [▶] to select “*” (The unit is now ready to accept markers.)
 To mark a position:
 [ENTER] (at the desired point)
 To mark another position:
 [◀, ▶] ⇒ [ENTER]
 To recall a marker: [◀, ▶] ⇒ [ENTER]
 To erase a marker: [◀, ▶] ⇒ [CANCEL]
RAM
 • To mark the eleventh point and beyond
 1. [◀, ▶] to select the marker pin icon

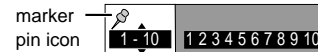

- 2. [▲, ▼] to select “11-20”
 You can select the next group when the current group is full.
- This feature doesn't work while using a play list.
- The markers are ordered by time. This means that the marker numbers can change when you add and erase markers.
- You can clear existing markers, but they are restored when you open the disc lid or switch the unit to standby.

Video menu



Digital picture mode **RAM** **DVD-V** **VCD**

Nor.: Normal mode
Cin.: Mellows images and enhances detail in dark scenes.

Audio menu

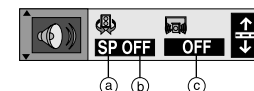

- a **ADVANCED SURROUND mode** **RAM** **DVD-V** **VCD** (⇒ page 17)
 SP↔HP
- b **SP/HP level** **RAM** **DVD-V** **VCD** (⇒ page 17)
 1↔2↔OFF
 ↑↔↓
- c **Dialogue Enhancer** **DVD-V**
 (Dolby Digital/DTS, 3-channel or over only)
 ON↔OFF
 The volume of the dialogue from the center channel is raised when you select “ON”.

Display menu





Bit-rate display **RAM** **DVD-V** **VCD**



ON↔OFF
 Displays the bit rate (approximate values) and type of picture (I/P/B ⇒ page 33, Glossary)
During play: Shows the average bit rate of the video being played
While paused: Shows the data volume of the frame

Changing settings

This chart shows the settings for this unit. Change the settings to suit your preference and to suit the unit to the environment in which it is being used. These settings are retained in memory until they are changed, even the unit is turned off.

• Underlined items are the factory presets.

Menus	Items	Options
	Audio DVD-V Choose the preferred audio language.	<u>English</u> French Spanish Original ^{#1} Other **** ^{#2}
	Subtitle DVD-V Choose the preferred subtitle language.	<u>Automatic</u> ^{#3} English French Spanish Other **** ^{#2}
	Menu DVD-V Choose the preferred language for disc menus.	<u>English</u> French Spanish Other **** ^{#2}
	Ratings DVD-V Set a ratings level to limit DVD-Video play. • The password screen is shown if you choose levels 0 to 7 or if you choose "Ratings" when levels 0 to 7 have been selected (⇒ page 28). • Select "Level 0" to prevent play of discs that do not have ratings levels recorded on them.	Setting ratings (When level 8 is selected) <u>8 No Limit</u> 1 to 7 ^{#4} 0 Lock All
		Changing ratings (When level 0-7 is selected) Unlock Player Change Level Change Password Temporary Unlock
	TV Aspect (⇒ page 31) Choose the setting to suit your television and preference.	4:3 Pan&Scan 4:3 Letterbox <u>16:9</u>
	Still Mode (⇒ page 33, Glossary) Specify the type of picture shown when paused.	<u>Automatic</u> Field Frame
	PCM Down Conversion DVD-V (⇒ page 28)	<u>No</u> Yes
	Dolby Digital DVD-V (⇒ page 28)	<u>Bitstream</u> PCM
	DTS Digital Surround DVD-V (⇒ page 28)	<u>PCM</u> Bitstream
	D. Range Compression RAM DVD-V (Dolby Digital Only) (⇒ page 33, Glossary) Change the dynamic range for late night viewing.	<u>Off</u> On
	Audio during Search Choose whether to have sound during search.	<u>On</u> Off

Menus	Items	Options
	Menu Language Choose the preferred language for these menus and the on-screen messages.	<u>English</u> Français Español
	On-Screen Messages Choose whether to show on-screen messages or not.	<u>On</u> Off
	Demo A demonstration of the unit's on-screen displays starts when you select "On". The demonstration stops and the setting reverts to "Off" when you press a button (except [MONITOR], [BRIGHT], and [COLOUR]).	<u>Off</u> On

#1 The original language of each disc will be selected.

#2 Input a code number with the numbered buttons (⇒ page 40).

#3 If the language selected for "Audio" is not available, subtitles of that language will automatically appear if available on that disc.

#4 Prohibits play of DVD-Video with corresponding ratings recorded on them.

Common procedures

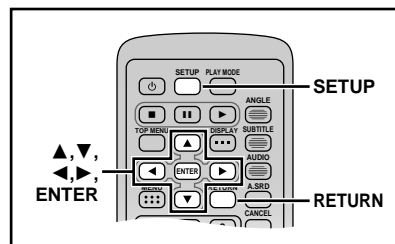

1 Press [SETUP] to show the menus.

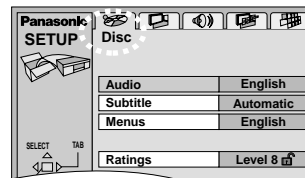

2 Press [◀, ▶] to select the menu's tab.

The screen changes to display the menu.

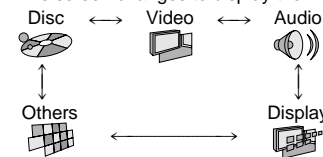

3 Press [▲, ▼] to select the item and press [ENTER].

4 Press [▲, ▼] to select the option and press [ENTER].

The screen now shows the menu again.

To return to the previous screen

Press [RETURN].

When you are finished

Press [SETUP].

For your reference

Press [MENU] on the main unit to access the SETUP menu while stopped (unless a DVD-RAM is loaded).

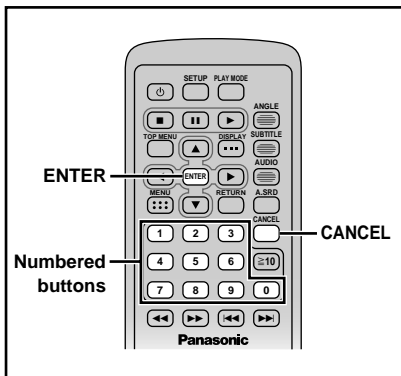

Entering a password

Remote control only

DVD-V

The password screen is shown when you select levels 0 to 7.

- Input a 4-digit password with the numbered buttons and press [ENTER].
 - If you enter a wrong number, press [CANCEL] to erase it before you press [ENTER].
 - The lock symbol appears closed to show the rating is locked.
 - Do not forget your password.**
- Press [ENTER] to confirm the 4 digits.

Now, when you insert a DVD-Video that exceeds the ratings limit you set, a message appears on the screen. Follow the on-screen instructions.

Digital output

DVD-V

Change these settings when you have connected digital equipment.

PCM Down Conversion

Select how to output audio with a sampling frequency of 96 kHz.

Select "Yes" if the equipment you connect cannot process signals with a sampling frequency of 96 kHz.

- Select "No" if you use analogue connection, irrespective of the type of equipment.

No (Factory preset):

Output as 96 kHz. There is no output if the disc has copy protection. Select "Yes" in this case.

Yes:

Converted to 48 kHz for output.

Dolby Digital and DTS Digital Surround

Bitstream (Factory preset for Dolby Digital):

Select if the equipment can decode the signal.

PCM (Factory preset for DTS Digital Surround):
Select if the equipment cannot decode the signal.

IMPORTANT

If the equipment cannot decode the signal, the setting must be changed to PCM. If not, signals the equipment cannot process will be output, causing high levels of noise which can damage your hearing and the speakers.

Enjoying more powerful sound

This model can play Dolby Digital and DTS, but only in two channels. You must connect a unit with a Dolby Digital or DTS decoder to enjoy surround sound.

Note

- The equipment connections described are examples.
- Peripheral equipment and optional cables sold separately unless otherwise indicated.
- Before connection, turn off all equipment and read the appropriate operating instructions.

A Digital connection

To enjoy multi-channel surround sound

Connect an amplifier with a built-in decoder or a decoder-amplifier combination.

- Change the settings in "Digital output" (⇒ page 28).

Note

You cannot use DTS Digital Surround decoders not suited to DVD.

To enjoy stereo or Dolby Pro Logic

Connect a digital amplifier or system component.

- Change the settings in "Digital output" (⇒ page 28).

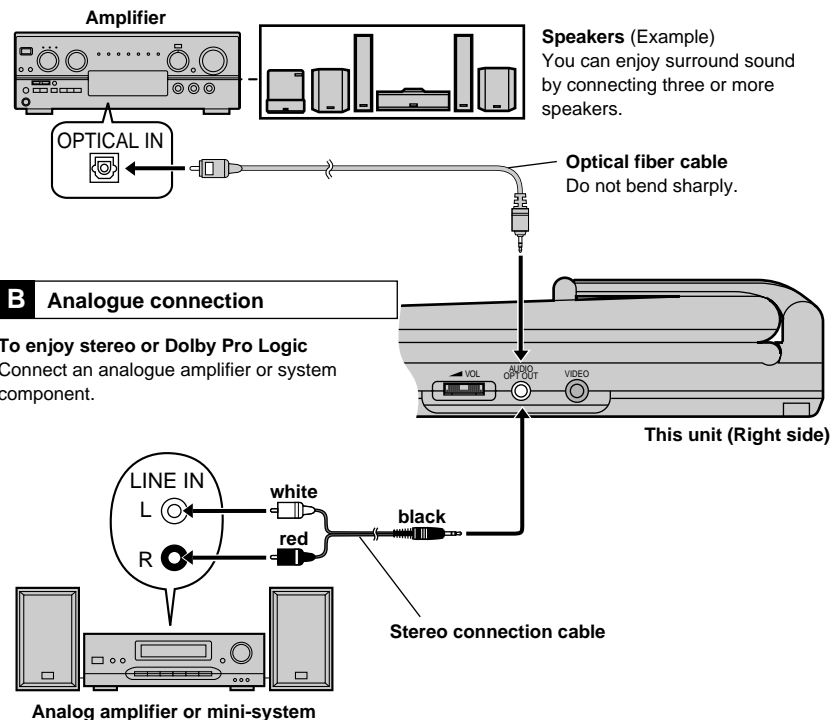

Using this unit with a television

Connection

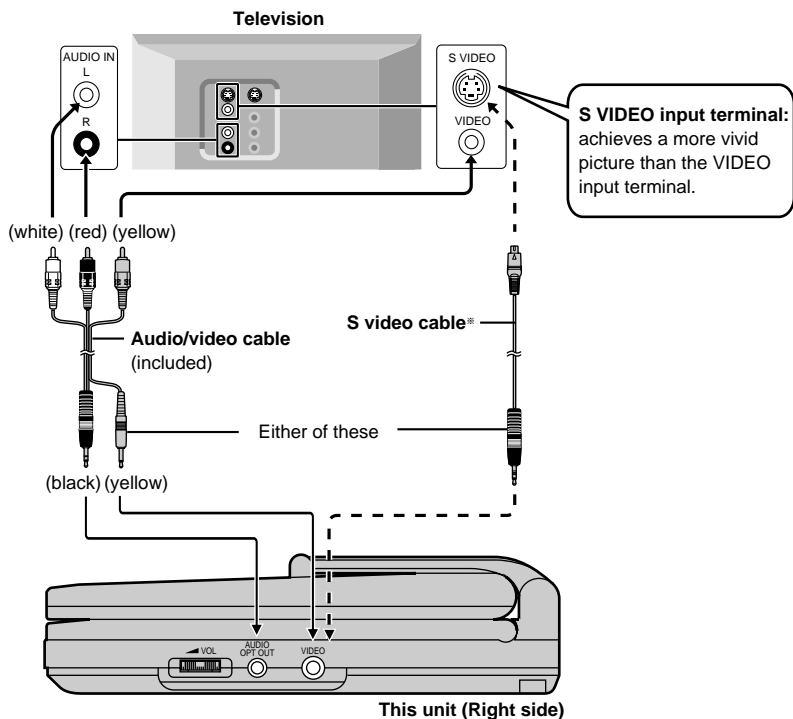

*S video cable is not included
Available from Panasonic dealers. Part number: **RFX4139**

Note

- The unit's speaker does not have magnetic shielding. Do not place the unit near televisions, personal computers or other devices easily influenced by magnetism.
- Volume may be lower when playing DVDs than when playing other discs or during TV broadcasts. If you turn the volume up, reduce it again so that a sudden increase in output does not occur.

Do not connect the player through your video cassette recorder
The picture may not be played back correctly due to the copy guard.

Selecting TV screen type

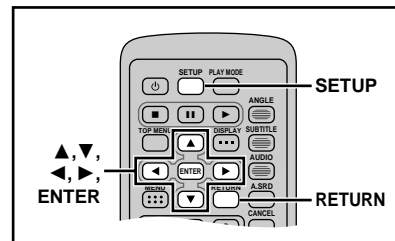

Preparations

Turn on your television and switch the video input mode on the television to suit the connection for the unit.

1 Press [SETUP] to show the menus.

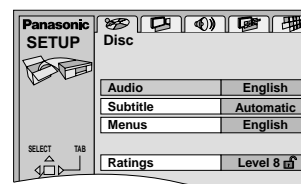

2 Press [◀, ▶] to select the Video tab.

3 Press [▲, ▼] to select "TV Aspect" and press [ENTER].

4 Press [▲, ▼] to select the item and press [ENTER].

•4:3 Pan & Scan

Regular television (to view 16:9 software in the pan and scan style).

•4:3 Letterbox

Regular television (to view 16:9 software in the letterbox style).

•16:9 (factory preset)

Wide-screen television.

Use the television's screen modes to change the way the picture is shown.



5 Press [SETUP] to end the settings.

To return to the previous menu

Press [RETURN].

Note

- Press [MENU] on the main unit to access the SETUP menus while stopped (unless a DVD-RAM is loaded).
- 16:9 software prohibited from being shown in the pan and scan style will appear in the letterbox style despite the setting here.

Recording to digital recording equipment or cassette tapes

•Digital recording

You can record the digital signal directly to digital recording equipment. Connect the recording equipment with an optical fiber cable (⇒ **A** page 29).

Note

•With DVD, the following conditions must be met: ㉑ the disc doesn't have protection preventing digital recording, and ㉒ the recording equipment can handle signals with a sampling frequency of 48 kHz.

•You cannot record MP3.

When recording DVDs, make the following settings.

ADVANCED SURROUND: OFF (⇒ page 17)

PCM Down Conversion: Yes (⇒ page 28)

Dolby Digital: PCM (⇒ page 28)

DTS Digital Surround: PCM (⇒ page 28)

•Analogue recording

You can record to a cassette deck or other recording equipment. Connect the recording equipment with a stereo connection cable (⇒ **B** page 29). There are no limitations on recording analogue signals as there are with digital signals.

Using headphones

Preparations

Turn down the volume before connection, and then adjust the level.

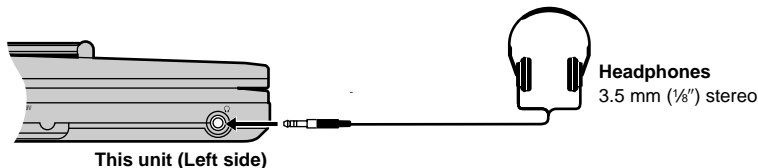

Note

When headphones are connected, no sound will be output from the unit's speaker.

Manufactured under license from Digital Theater Systems, Inc. US Pat. No. 5,451,942, 5,956,674, 5,974,380, 5,978,762 and other world-wide patents issued and pending. "DTS" and "DTS Digital Surround" are registered trademarks of Digital Theater Systems, Inc. © 1996, 2000 Digital Theater Systems, Inc. All rights reserved.

Bitstream

This is the digital form of multiple channel audio data (e.g., 5.1 channel) before it is decoded into its various channels.

Decoder

A decoder restores the coded audio signals on DVDs to normal. This is called decoding.

Dolby Digital

This is a method of coding digital signals developed by Dolby Laboratories. Apart from stereo (2-channel) audio, these signals can also be multi-channel audio. A large amount of audio information can be recorded on the disc using this method.

Dolby Pro Logic

A surround system where a 4-channel audio track is recorded as 2 channels and then is restored to 4 channels for play. The surround channel is monaural and can reproduce up to 7 kHz.

DTS (Digital Theater Systems)

This surround system is used in many movie theaters around the world. There is good separation between the channels, so realistic sound effects are possible.

Dynamic range

Dynamic range is the difference between the lowest level of sound that can be heard above the noise of the equipment and the highest level of sound before distortion occurs.

Frame still and field still

A still is shown when you pause a moving picture. A frame still is made up of 2 alternating fields, so the picture may appear blurred, but overall quality is high.

A field still is not blurred, but it has only half the information of a frame still so picture quality is lower.

I/P/B

MPEG 2, the video compression standard adopted for use with DVD-Video, codes frames using these 3 picture types.

I: Intra coded picture

This picture has the best quality and is the best to use when adjusting the picture.

P: Predictive coded picture

This picture is calculated based on past I or P-pictures.

B: Bidirectionally-predictive coded picture

This picture is calculated by comparing past and future I and P-pictures so it has the lowest volume of information.

Linear PCM (pulse code modulation)

These are uncompressed digital signals, similar to those found on CDs.

Playback control (PBC)

If a Video CD has playback control, you can select scenes and information with menus.

Manufactured under license from Dolby Laboratories. "Dolby", "Pro Logic" and the double-D symbol are trademarks of Dolby Laboratories.

Apparatus Claims of U.S. Patent Nos. 4,631,603, 4,577,216, and 4,819,098, licensed for limited viewing uses only.

This product incorporates copyright protection technology that is protected by method claims of certain U.S. patents and other intellectual property rights owned by Macrovision Corporation and other rights owners. Use of this copyright protection technology must be authorized by Macrovision Corporation, and is intended for home and other limited viewing uses only unless otherwise authorized by Macrovision Corporation. Reverse engineering or disassembly is prohibited.

Troubleshooting Guide

Before requesting service, make the below checks. If you are in doubt about some of the check points, or if the remedies indicated in the chart do not solve the problem:

In the U.S.A., contact the Panasonic Customer Call Center at 1-800-211-7262, or e-mail consumerproducts@panasonic.com, or web site (<http://www.panasonic.com>).
In Canada, contact Panasonic Canada Inc. Customer Care Centre at 1-800-561-5505, web site (www.panasonic.ca), or an authorized Servicentre close to you.

Reference pages are shown as black circled numbers ⑩.

Problem	Solution
No power.	Check connections to the AC adaptor or battery pack. ⑩ ⑪ You cannot turn on the unit with the remote control if the unit is powered by the battery pack.
Unit turns off automatically. Unit doesn't work when powered by battery.	The unit turns off after it has been stopped for about 15 minutes (5 minutes when the unit is powered by the battery pack) to conserve power. Turn the unit on again. The unit and battery pack have protection circuitry that activate if they become too hot or too cold. They will not work if this occurs. Use the unit and battery pack between 5 °C (41 °F) and 35 °C (95 °F).
Cannot charge or the [CHG] indicator fails to light.	The battery pack can only be recharged when the unit is off. The charging time increases if the battery pack is warm and charging may not be possible under some circumstances. Wait for it to cool. Check connection to the AC adaptor. ⑩
No response when buttons are pressed.	Some discs prohibit certain operations. If there is no response at all, the unit may have been affected by lightning or static electricity. Try turning the unit off and on again. Alternatively, turn the unit off, disconnect the power source (AC or battery pack) reconnect the power and turn the unit on again.
Play fails to start or stops soon after starting.	Condensation may have formed in the unit. Wait 1 or 2 hours for it to clear. This unit cannot play discs other than those specified. ③ Clean the disc. ③ Ensure the disc is inserted correctly. ⑬ Check that the DVD-RAM has something recorded on it.











Problem	Solution
No operation with remote control.	Check that the battery is inserted correctly. ③ Replace the battery if it is drained. ③ Aim the remote control at the remote control signal sensor. ③
The audio soundtrack or subtitle language cannot be changed.	This function is dependent on software availability. Some DVDs require you to change the languages through menus.
Subtitles not shown.	This function is dependent on software availability. Turn the subtitles on. ⑭ Subtitles may fail to appear around the A and B points in A-B repeat, and around the points you marked to play again.
Angles cannot be changed.	This function is dependent on software availability. There may be parts of multi-angle DVDs where different angles are not recorded.
You have forgotten your ratings password.	Do the following to reset the unit to its original factory settings. While the unit is stopped, press and hold [II], [◀◀] (backward), and [▶, - ON] on the main unit for about 3 seconds until the message "Initialized" disappears from the LCD, then turn the unit off.
You want to reset the unit to the factory settings.	
There is a lot of noise.	Separate the unit from mobile phones.
No sound from the unit's speaker.	The speaker is off if the LCD is closed or headphones are connected. Turn up the volume. ⑮
No sound from other speakers.	Check all connections and settings. ⑲, ⑲, ⑳ Check input mode of the other equipment.
Distorted sound.	ADVANCED SURROUND may cause distortion with some discs. Turn ADVANCED SURROUND off if this occurs. ⑰

Problem	Solution
The LCD is dark.	Adjust the brightness. ⑫
The picture is disrupted during fast forward and rewind.	Some disruption is normal.
No picture on the LCD	Select a picture mode other than "OFF" (no picture). ⑫
Picture doesn't appear on the television (or the size of the picture seems wrong).	Check connections. ⑩
	Check that the television is on.
	Check that the input mode on the television is correct.
	Check the settings in "Video—TV Aspect". ⑪
LCD pixels turn black or radiate different colors.	The LCD is constructed with precision technology so 99.99 % of the pixels are active, but of the remaining of 0.01 %, there are pixels that may be black or emit light constantly. This phenomenon is not a malfunction.

[⏻] and [CHG] indicators

The [⏻] indicator flashes rapidly.	The unit has malfunctioned. Consult your dealer.
The [⏻] indicator flashes slowly.	The unit is on and the LCD is closed or the display mode is set to "OFF" (no picture). Turn the unit off when you have finished. ⑫
The [CHG] indicator flashes rapidly.	There is a problem with the battery pack. Turn the unit on and check the message on the LCD. ⑭
The [CHG] indicator flashes slowly.	Battery pack charge is low. The unit will turn off automatically after a few minutes. ①

Displays

On-Screen Menu Icons are cut off or are not displayed at all.	Use [▲, ▼] while the rightmost icon is highlighted to move them down. ⑫
No On-Screen display.	Go to the Display menu in the SETUP screen, and select "On" for "On-Screen Messages". ⑫
"Check the disc." appears on the LCD.	Clean the disc. ⑨
 ERROR     stands for a number.	<p>" ERROR 01": A problem has occurred with the battery pack. Consult your dealer.</p> <p>" ERROR 02": The battery pack has been recharging for 12 hours but has failed to recharging for some reason. Recharge again.</p> <p>" ERROR 03": You are recharging in a location that is too hot or too cold. Recharge at normal temperature.</p>
H   stands for a number.	Trouble has occurred. The number appearing after H depends on the problem. Turn the unit off and on again. Alternatively, turn the unit off, disconnect the power source (AC or battery pack) reconnect the power and turn the unit on again. If the service numbers fail to clear, note the service number and contact a qualified service person.

Note

The following do not indicate malfunction.

- Sound from the AC adaptor during recharging.
- The battery pack warms up after recharging or during use.

Maintenance

■ To clean this unit, wipe with a soft, dry cloth.

- Use eyeglass cleaner to remove stubborn dirt from the LCD.
- Never use alcohol, paint thinner or benzine to clean this unit.
- Before using chemically treated cloth, read the instructions that came with the cloth carefully.

■ Maintenance of the lens

- Remove dust carefully with an air blower for camera lenses (optional).
Recommended product:
Lens cleaner kit (SZZP1038C)
(Available from Panasonic dealers.)
- Be careful not to touch the lens with your fingers.

Limited Warranty (ONLY FOR U.S.A.)

Panasonic Consumer Electronics Company,
Division of Matsushita Electric Corporation
of America

One Panasonic Way Secaucus, New Jersey
07094

Panasonic Sales Company, Division of
Matsushita Electric of Puerto Rico, Inc.

Ave. 65 de Infantería, Km. 9.5
San Gabriel Industrial Park, Carolina, Puerto
Rico 00985

Panasonic DVD Player/Recorder Limited Warranty

Limited Warranty Coverage

If your product does not work properly because of a defect in materials or workmanship, Panasonic Consumer Electronics Company or Panasonic Sales Company (collectively referred to as "the warrantor") will, for the length of the period indicated on the chart below, which starts with the date of original purchase ("warranty period"), at its option either (a) repair your product with new or refurbished parts, or (b) replace it with a new or a refurbished product. The decision to repair or replace will be made by the warrantor.

Product or Part Name	Parts	Labor
DVD Player	One (1) Year	Ninety (90) Days
DVD Recorder	One (1) Year	One (1) Year
Rechargeable Batteries, DVD-RAM Disc (in exchange for defective item)	Ten (10) Days	Not Applicable

During the "Labor" warranty period there will be no charge for labor. During the "Parts" warranty period, there will be no charge for parts. You must carry-in or mail-in your product during the warranty period. If non-rechargeable batteries are included, they are not warranted. This warranty only applies to products purchased and serviced in the United States or Puerto Rico. This warranty is extended only to the original purchaser of a new product which was not sold "as is". A purchase receipt or other proof of the original purchase date is required for warranty service.

Carry-In or Mail-In Service

For Carry-In or Mail-In Service in the United States call 1-800-211-PANA (7262) or visit Panasonic Web Site: <http://www.panasonic.com>

For assistance in Puerto Rico call Panasonic Sales Company (787)-750-4300 or fax (787)-768-2910.

Limited Warranty Limits And Exclusions

This warranty ONLY COVERS failures due to defects in materials or workmanship, and DOES NOT COVER normal wear and tear or cosmetic damage. The warranty ALSO DOES NOT COVER damages which occurred in shipment, or failures which are caused by products not supplied by the warrantor, or failures which result from accidents, misuse, abuse, neglect, mishandling, misapplication, alteration, faulty installation, set-up adjustments, misadjustment of consumer controls, improper maintenance, power line surge, lightning damage, modification, or commercial use (such as in a hotel, office, restaurant, or other business), rental use of the product, service by anyone other than a Factory Servicenter or other Authorized Servicer, or damage that is attributable to acts of God.

THERE ARE NO EXPRESS WARRANTIES EXCEPT AS LISTED UNDER "LIMITED WARRANTY COVERAGE". THE WARRANTOR IS NOT LIABLE FOR INCIDENTAL OR CONSEQUENTIAL DAMAGES RESULTING FROM THE USE OF THIS PRODUCT, OR ARISING OUT OF ANY BREACH OF THIS WARRANTY. (As examples, this excludes damages for lost time, travel to and from the servicer, loss of media or images, data or other recorded content. The items listed are not exclusive, but are for illustration only.) **ALL EXPRESS AND IMPLIED WARRANTIES, INCLUDING THE WARRANTY OF MERCHANTABILITY, ARE LIMITED TO THE PERIOD OF THE LIMITED WARRANTY.**

Some states do not allow the exclusion or limitation of incidental or consequential damages, or limitations on how long an implied warranty lasts, so the exclusions may not apply to you.

This warranty gives you specific legal rights and you may also have other rights which vary from state to state. If a problem with this product develops during or after the warranty period, you may contact your dealer or Servicenter. If the problem is not handled to your satisfaction, then write to the warrantor's Consumer Affairs Department at the addresses listed for the warrantor.

PARTS AND SERVICE WHICH ARE NOT COVERED BY THIS LIMITED WARRANTY ARE YOUR RESPONSIBILITY.

Customer Services Directory (ONLY FOR U.S.A.)

For Product Information, Operating Assistance, Literature Request, Dealer Locations, and all Customer Service inquiries please contact:
**1-800-211-PANA (7262), Monday-Friday 9 am-9 pm;
Saturday-Sunday 9 am-7 pm, EST.**

Web Site: <http://www.panasonic.com>
You can purchase parts, accessories or locate your nearest servicenter by visiting our Web Site.

Accessory Purchases:

1-800-332-5368 (Customer Orders Only)

Panasonic Services Company 20421 84th Avenue South, Kent, WA 98032

(6 am to 5 pm Monday-Friday; 6 am to 10:30 am Saturday; PST)

(Visa, MasterCard, Discover Card, American Express, Check)

Service in Puerto Rico
Matsushita Electric of Puerto Rico, Inc. Panasonic Sales Company/Factory Servicenter:
Ave. 65 de Infantería, Km. 9.5, San Gabriel Industrial Park, Carolina, Puerto Rico 00985
Phone (787) 750-4300 Fax (787) 768-2910

The model number and serial number of this product can be found on either the back or the bottom of the unit. Please note them in the space provided below and keep for future reference.

MODEL NUMBER _____ DVD-LV50 _____
SERIAL NUMBER _____

User memo:

DATE OF PURCHASE _____
DEALER NAME _____
DEALER ADDRESS _____

TELEPHONE NUMBER _____

Product Service

- 1. Damage requiring service**—The unit should be serviced by qualified service personnel if:
 - (a) The AC power supply cord or AC adaptor has been damaged; or
 - (b) Objects or liquids have gotten into the unit; or
 - (c) The unit has been exposed to rain; or
 - (d) The unit does not operate normally or exhibits a marked change in performance; or
 - (e) The unit has been dropped or the cabinet damaged.
- 2. Servicing**—Do not attempt to service the unit beyond that described in these operating instructions. Refer all other servicing to authorized servicing personnel.
- 3. Replacement parts**—When parts need replacing ensure the servicer uses parts specified by the manufacturer or parts that have the same characteristics as the original parts. Unauthorized substitutes may result in fire, electric shock, or other hazards.
- 4. Safety check**—After repairs or service, ask the servicer to perform safety checks to confirm that the unit is in proper working condition.

Product information

For product information or assistance with product operation:

In the U.S.A., contact the Panasonic Customer Call Center at 1-800-211-7262, or e-mail consumerproducts@panasonic.com, or web site (<http://www.panasonic.com>).

In Canada, contact Panasonic Canada Inc. Customer Care Centre at 1-800-561-5505, web site (www.panasonic.ca), or an authorized Servicentre closest to you.

Language code list

6566: Abkhazian	1704: Fiji	2768: Lingala	3837: Singhalese
6565: Afar	7073: Finnish	7684: Lithuanian	8375: Slovak
6570: Afrikaans	7082: French	7775: Macedonian	8376: Slovenian
8381: Albanian	7089: Frisian	7771: Malagasy	8379: Somali
6577: Ameharic	7176: Galician	7783: Malay	6983: Spanish
6582: Arabic	7565: Georgian	7776: Malayalam	8385: Sundanese
7289: Armenian	6869: German	7784: Maltese	8387: Swahili
6583: Assamese	6976: Greek	7773: Maori	8386: Swedish
6588: Aymara	7576: Greenlandic	7782: Marathi	8476: Tagalog
6590: Azerbaijani	7178: Guarani	7779: Moldavian	8471: Tajik
6665: Bashkir	7185: Gujarati	7778: Mongolian	8465: Tamil
6985: Basque	7265: Hausa	7865: Nauru	8484: Tatar
6678: Bengali;	7387: Hebrew	7869: Nepali	8469: Telugu
Bangla	7273: Hindi	7879: Norwegian	8472: Thai
6890: Bhutani	7285: Hungarian	7982: Oriya	6679: Tibetan
6672: Bihari	7383: Icelandic	8083: Pashto, Pushto	8473: Tigrinya
6682: Breton	7378: Indonesian	7065: Persian	8479: Tonga
6671: Bulgarian	7365: Interlingua	8076: Polish	8482: Turkish
7789: Burmese	7165: Irish	8084: Portuguese	8475: Turkmen
6669: Byelorussian	7384: Italian	8065: Punjabi	8487: Twi
7577: Cambodian	7465: Japanese	8185: Quechua	8575: Ukrainian
6765: Catalan	7487: Javanese	8277: Rhaeto-	8582: Urdu
9072: Chinese	7578: Kannada	Romance	8590: Uzbek
6779: Corsican	7583: Kashmiri	8279: Romanian	8673: Vietnamese
7282: Croatian	7575: Kazakh	8285: Russian	8679: Volapük
6783: Czech	7589: Kirghiz	8377: Samoan	6789: Welsh
8865: Danish	7579: Korean	8365: Sanskrit	8779: Wolof
7876: Dutch	7585: Kurdish	7168: Scots Gaelic	8872: Xhosa
6978: English	7679: Laotian	8382: Serbian	7473: Yiddish
6979: Esperanto	7665: Latin	8372: Serbo-Croatian	8979: Yoruba
6984: Estonian	7686: Latvian,	8378: Shona	9085: Zulu
7079: Faroese	Lettish	8368: Sindhi	

Specifications

Operating temperature range:

+5 to +35 °C (+41 to +95 °F)

Operating humidity range:

5–90 % RH (no condensation)

Discs played: DVD-RAM (DVD-VR compatible)

DVD-Video
Compact disc [CD-DA
(CD-TEXT compatible), Video CD]
CD-R/CD-RW
[CD-DA (CD-TEXT compatible),
Video CD, MP3 formatted discs]
DVD-R (DVD-Video compatible)

Signal system:

NTSC

LCD screen: 5" α-Si, TFT wide-screen LCD

Video output:

Output level: 1 Vp-p (75 Ω)
Output terminal: Mini-jack
Number of terminals: 1 system

S-video output:

Y output level: 1 Vp-p (75 Ω)
C output level: 0.286 Vp-p (75 Ω)
Output terminal: Mini-jack
Number of terminals: 1 system
(also used for video output)

Audio output:

Output level: 1.5 Vrms (1 kHz, 0 dB, 10 kΩ)
Output terminal: Stereo mini-jack
Number of terminals: 1 system

Audio performance:

- (1) Frequency response:
 - DVD (linear audio):
4 Hz–22 kHz (48 kHz sampling)
4 Hz–44 kHz (96 kHz sampling)
 - CD audio: 4 Hz–20 kHz
- (2) S/N ratio:
 - CD audio: 115 dB
- (3) Dynamic range:
 - DVD (linear audio): 98 dB
 - CD audio: 97 dB
- (4) Total harmonic distortion:
 - CD audio: 0.008 %

Digital audio output:

Optical digital output: Mini optical terminal
Number of terminals: 1 system
(also used for audio output)

Pickup:

Wave length: 658 nm/790 nm
Laser power: CLASS II/CLASS I

Power supply: DC 9 V (DC IN terminal)/
DC 7.2 V (Exclusive battery terminal)

Power consumption: 10 W (Unit only: 8 W)
Recharge mode 12 W
(when using included AC adaptor)

AC adaptor

Power source: AC 100–240 V, 50/60 Hz
Power consumption: 20 W
DC output: 9 V, 1400 mA

Battery pack CGR-H603 (lithium ion)

Voltage: 7.2 V
Capacity: 2000 mAh
Dimensions: 144 (W)×140 (D)×32.5* (H) mm
[5¹/₂" (W)×5¹/₂" (D)×1¹/₂" (H)]
(excluding protrusions)
*28.7 mm (1¹/₈") at lowest point

Mass: 566 g (19.96 oz.)

Note

Specifications are subject to change without notice.
Mass and dimensions are approximate.

Power consumption in standby mode: 0.9 W
(when using included AC adaptor)

Panasonic Consumer Electronics Company, Division of Matsushita Electric Corporation of America

One Panasonic Way Secaucus, New Jersey 07094

<http://www.panasonic.com>

Panasonic Sales Company, Division of Matsushita Electric of Puerto Rico, Inc. ("PSC")
Ave. 65 de Infantería, Km. 9.5 San Gabriel Industrial Park, Carolina, Puerto Rico 00985

Panasonic Canada Inc.

5770 Ambler Drive, Mississauga, Ontario L4W 2T3

www.panasonic.ca

© 2002 Matsushita Electric Industrial Co., Ltd.

Printed in Japan