

How do I connect a TV to a Blu-Ray Player?

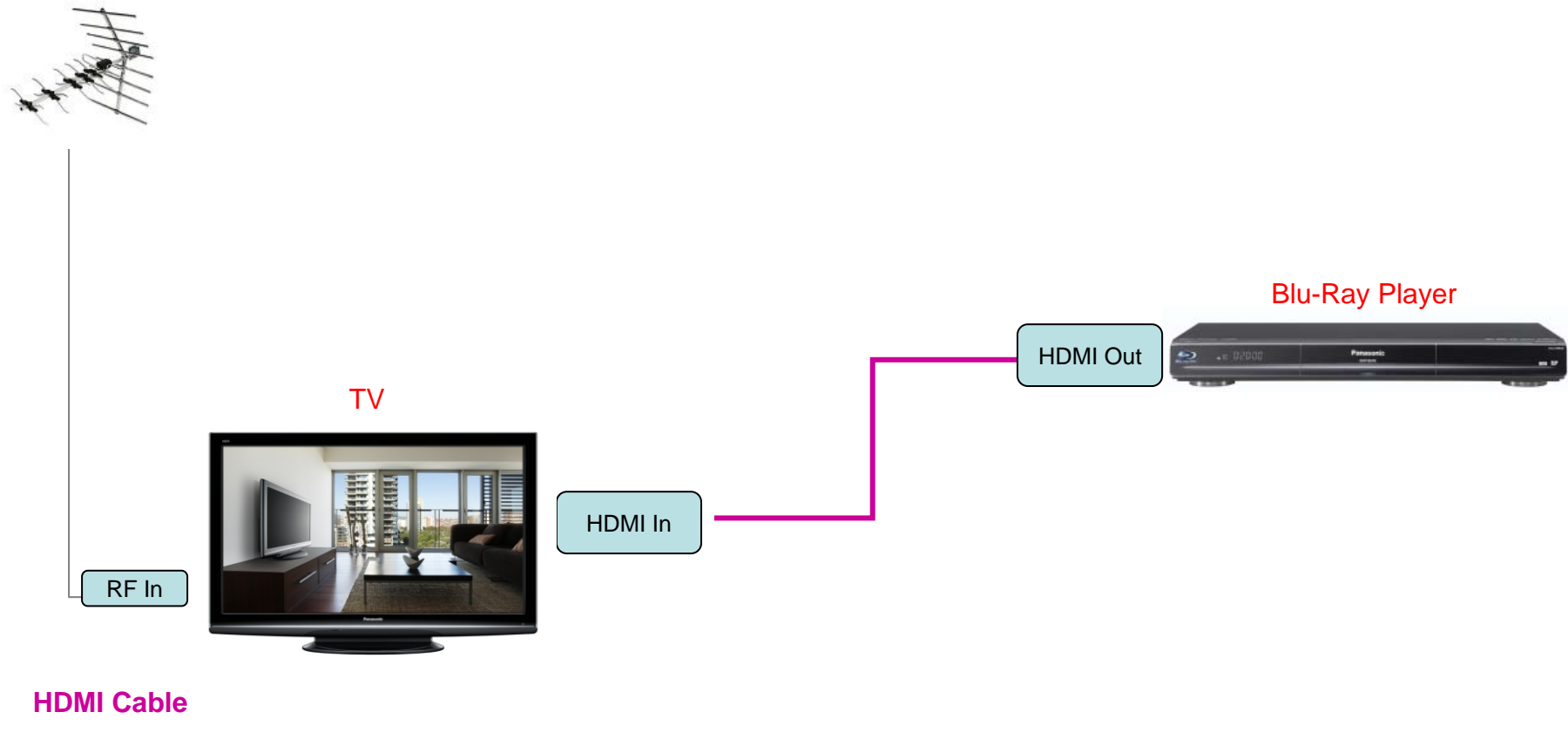

* Connect a HDMI cable from the HDMI output on the Blu-ray Player to the Television's HDMI input.

How do I connect a TV, Blu-Ray Player and a Home Cinema?

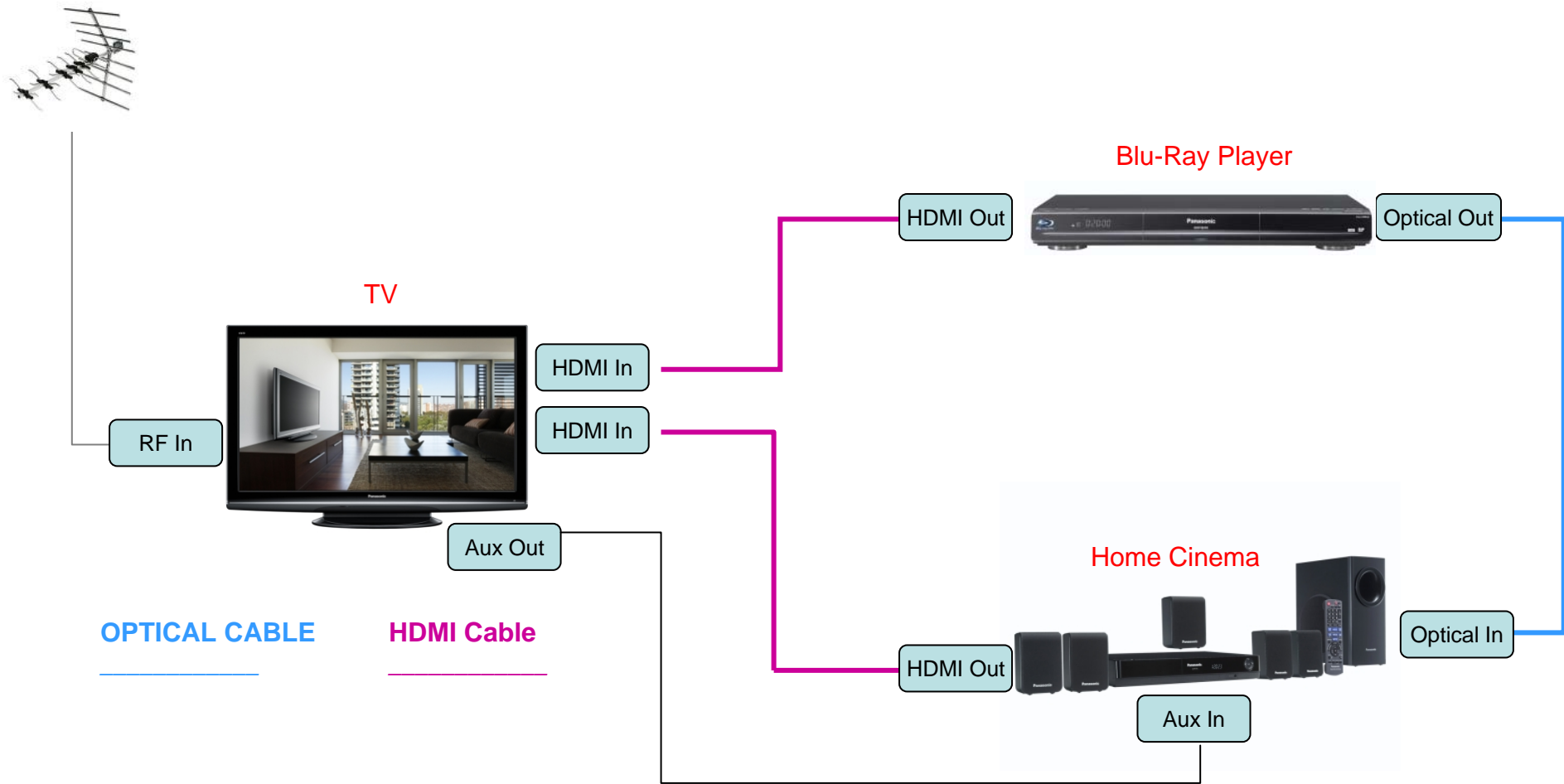

- 1, Connect an HDMI cable from the Blu-ray Players HDMI output to the TV's HDMI input 1.
- 2, Connect an HDMI Cable from the Home Cinema's HDMI output to the TV's HDMI input 2.
- 3, Connect an Optical cable from the Blu-Ray Optical output to the Home Cinemas optical input.
- 4, Connect phono leads (RCA) from the Auxiliary output on the TV to the Auxiliary input on the Home Cinema.

How do I connect a TV, SKY-HD, Blu-Ray Player and a Home Cinema?

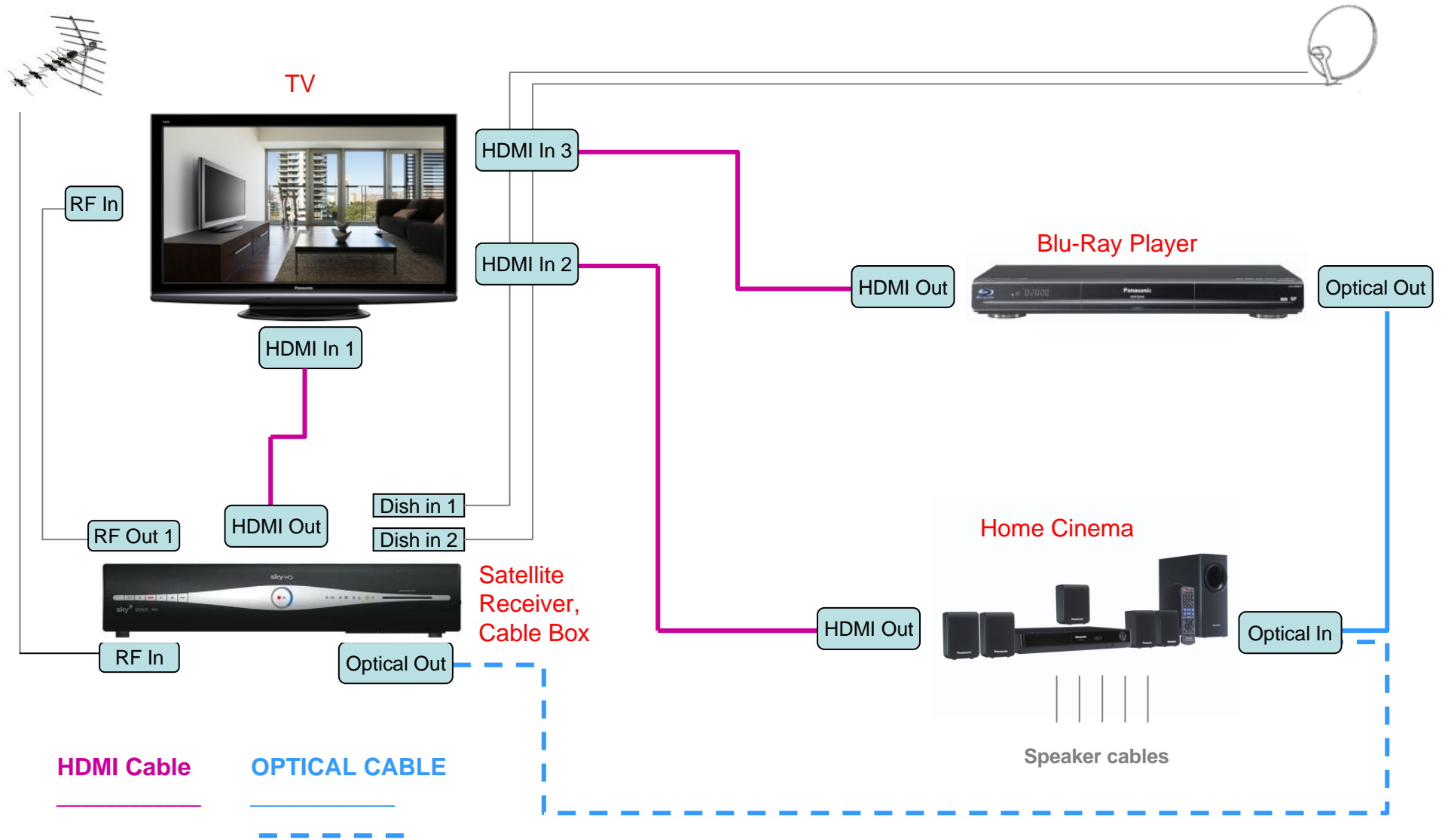

How do I connect a TV, SKY-HD, Blu-Ray Player and a AV receiver?

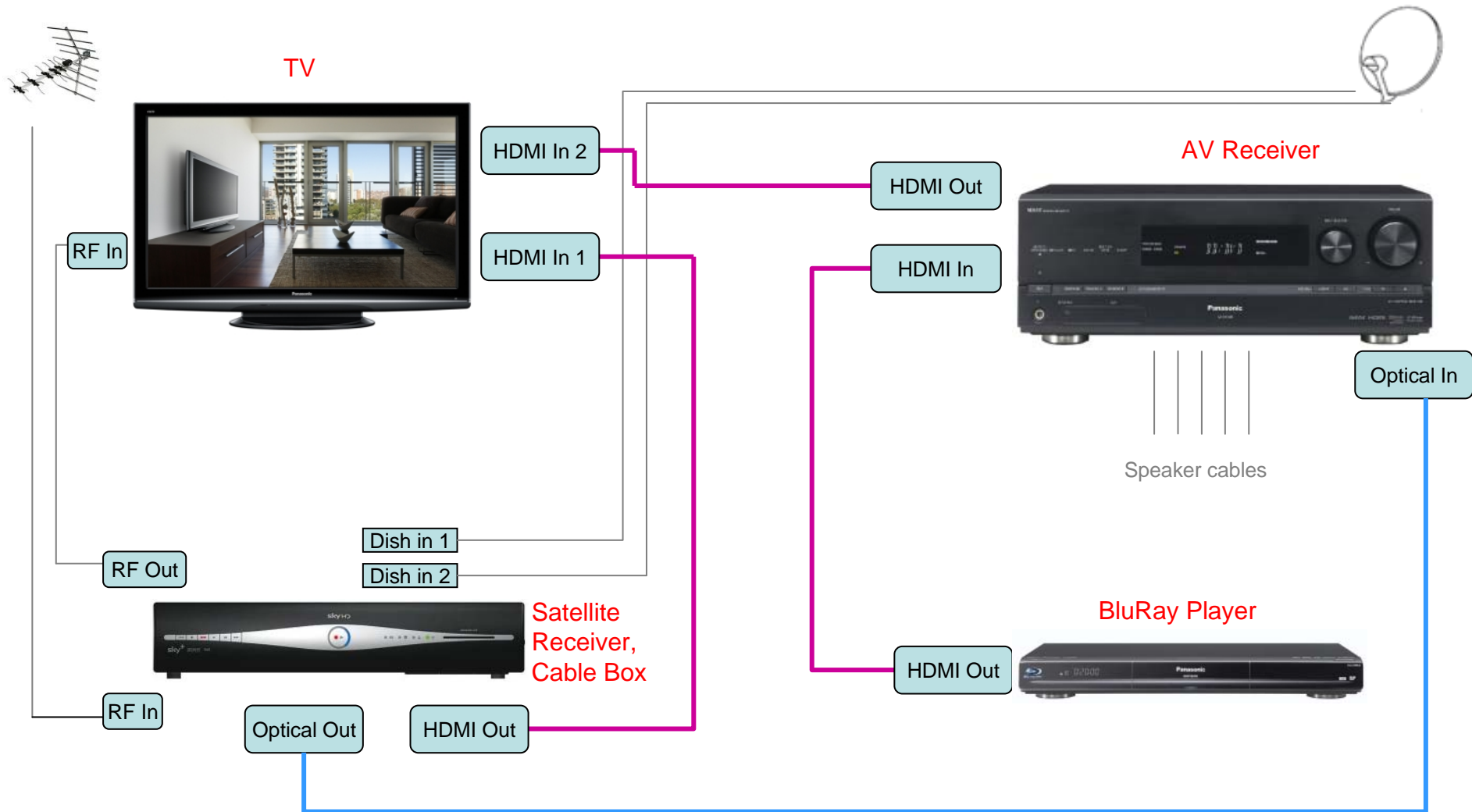

HDMI Cable

OPTICAL CABLE

How do I connect a TV and a Blu-ray Recorder?

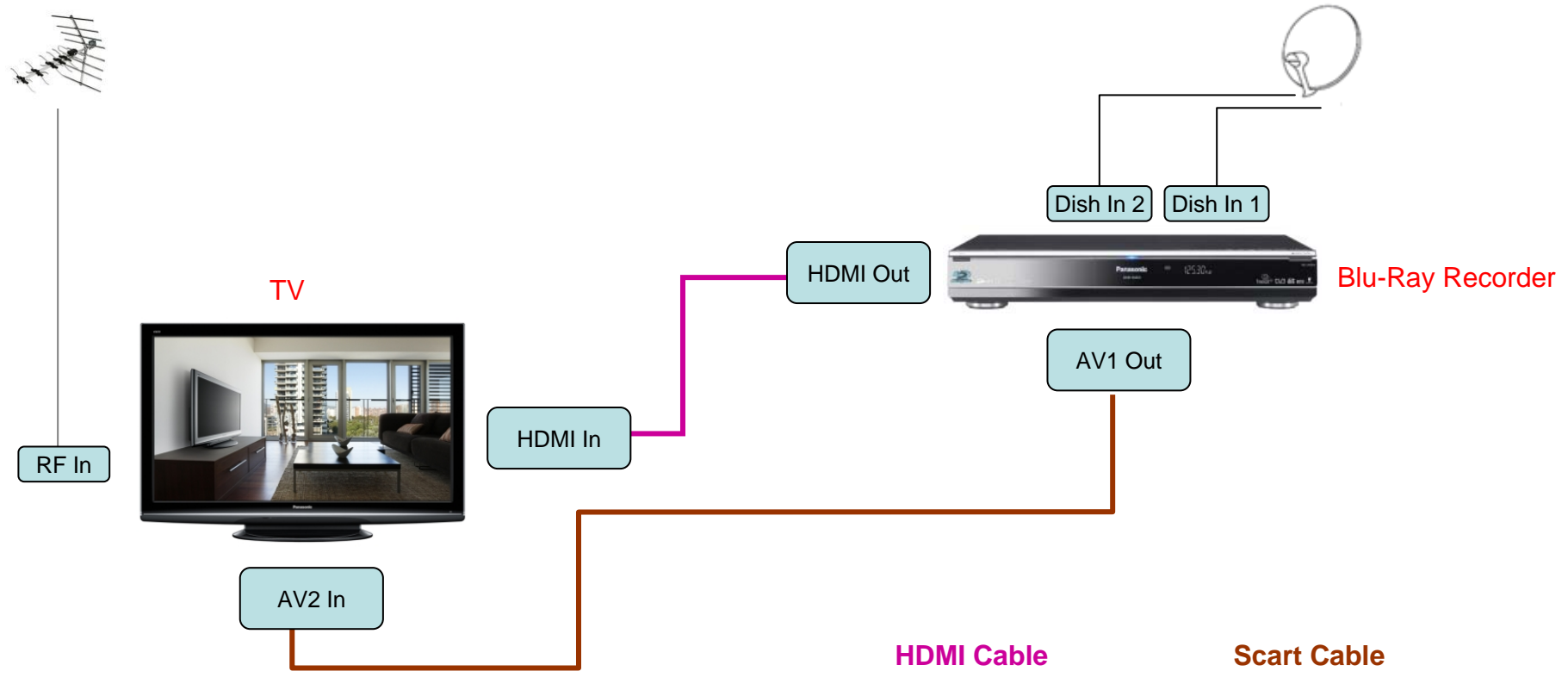

Connect a HDMI cable from the HDMI output on the Blu-Ray Recorder to the Television's HDMI input.
* For additional Q-Link features - Connect a Scart cable from the AV1 Out of the Blu-Ray Recorder to the AV2 input on the TV
*** If you do not have HDMI on the TV, use a Scart lead.

How do I connect a TV, Blu-Ray Recorder and a Home Cinema?

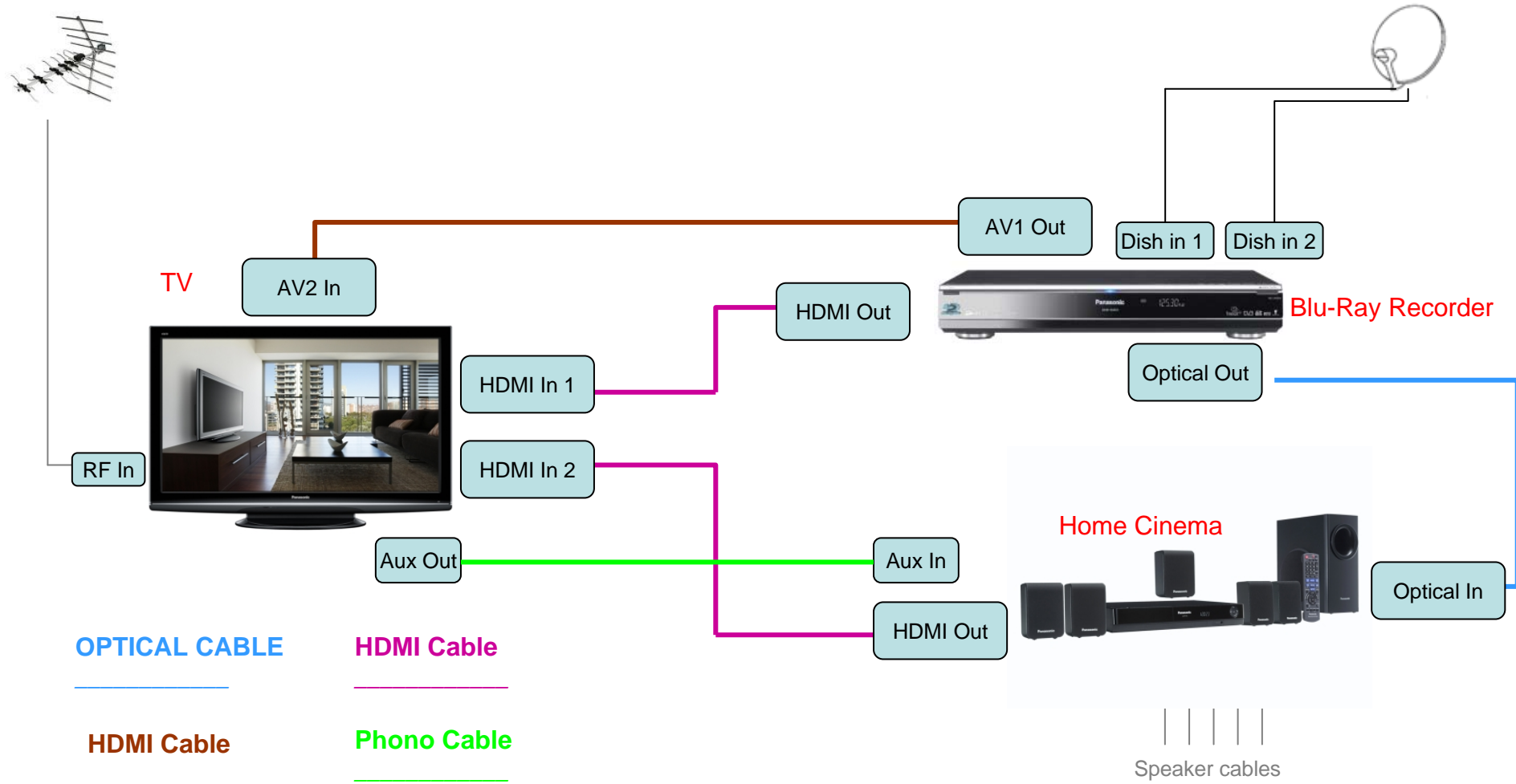

- 1, Connect an HDMI Cable from the Blu-Ray Recorder's HDMI output to the TV's HDMI input 1
- 2, Connect an HDMI Cable from the Home Cinema's HDMI Output to the TV's HDMI input 2
- 3, Connect a Scart cable from the AV1 Output of the Blu-Ray Recorder to the AV2 input on the TV; this could be used instead of an HDMI Cable or in addition to the HDMI for use with **Q-link**
- 4, Connect Phono Cables from the Auxiliary out on the TV to the Auxiliary in on the Home Cinema

How do I connect a TV, SKY-HD and a Blu-Ray Recorder?

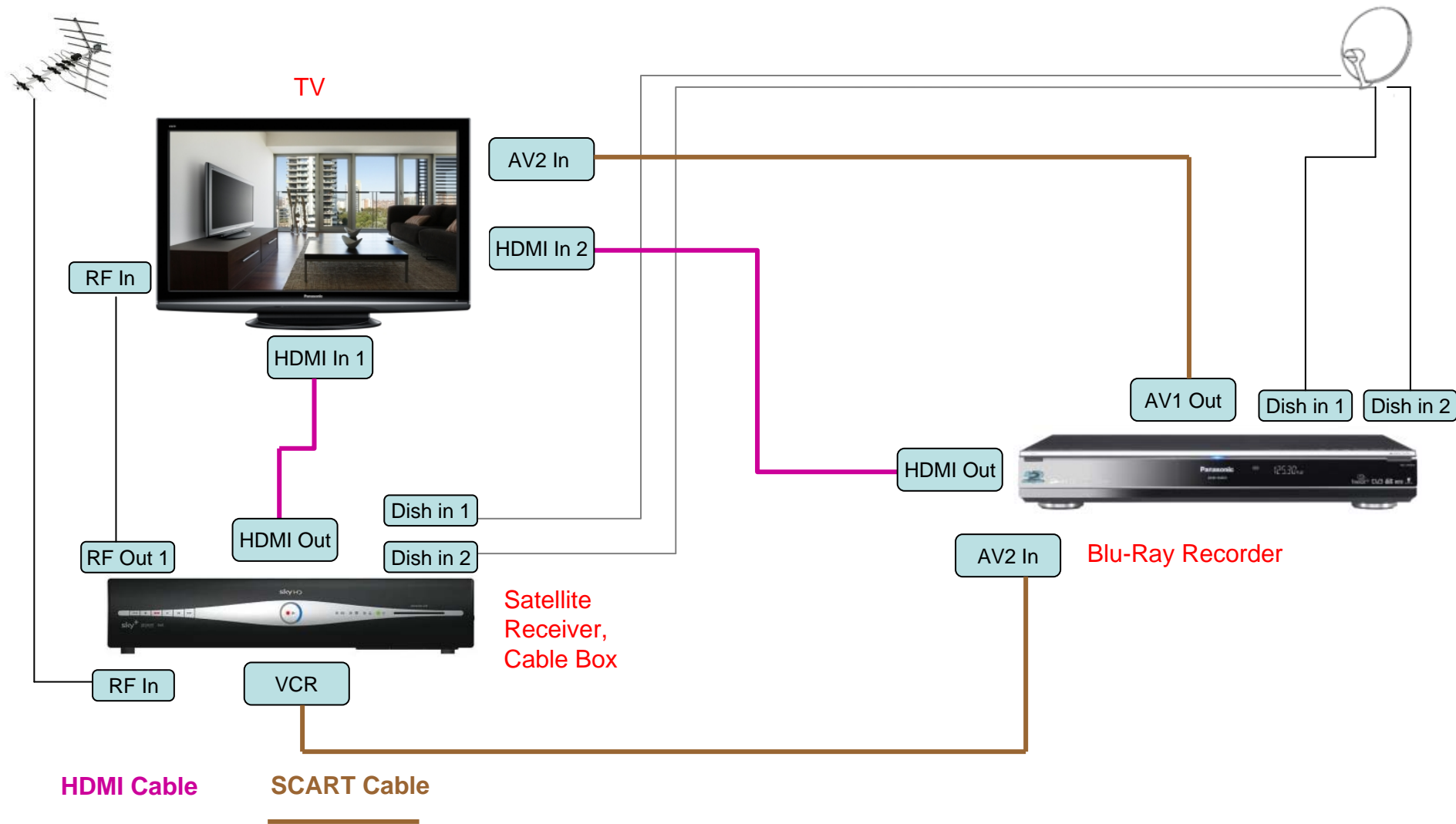

How do I connect a TV, SKY-HD, Blu-Ray Recorder and a Home Cinema?

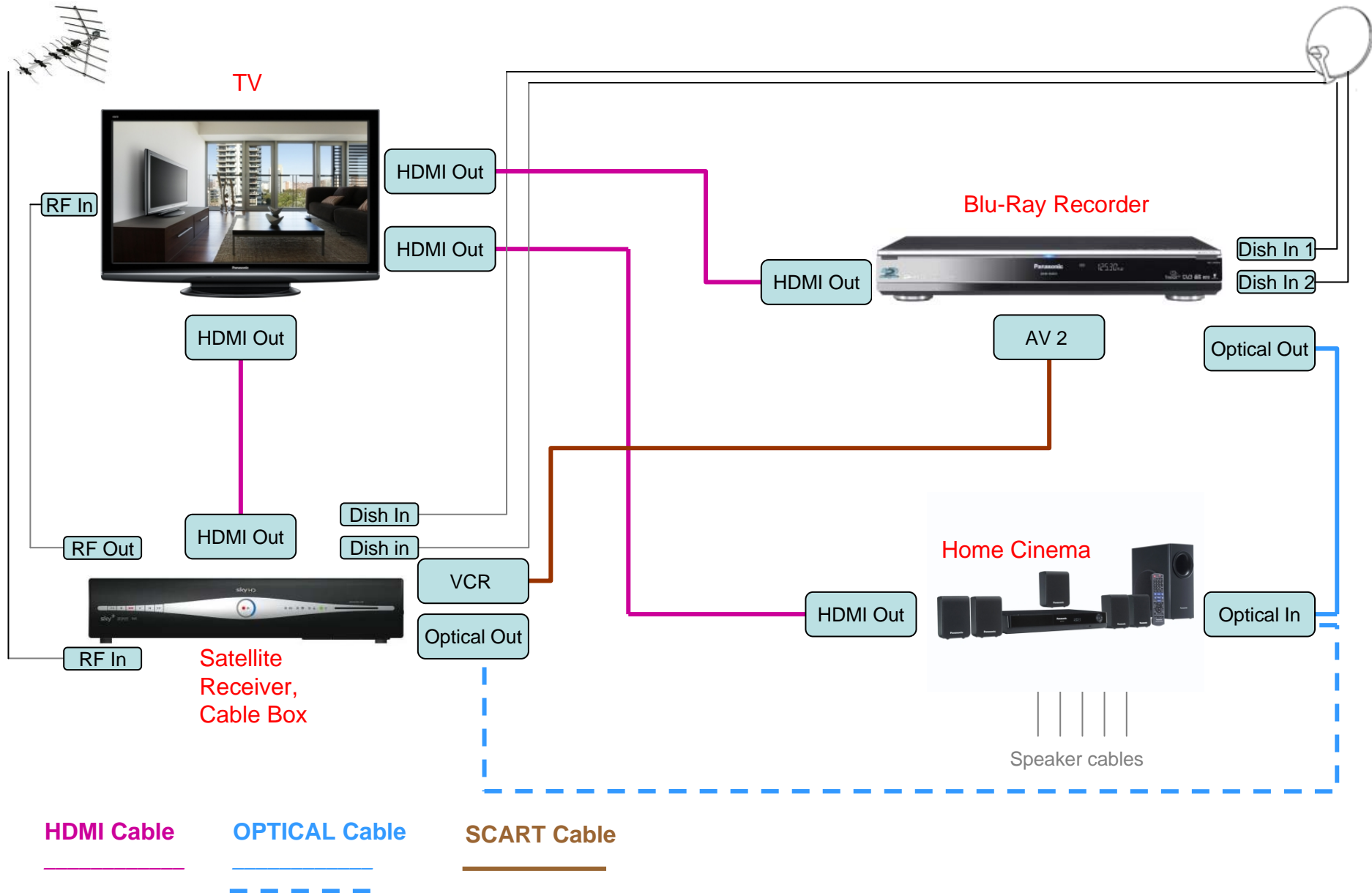

Connection diagram for a TV, SKY-HD, Blu-Ray Recorder and a AV receiver

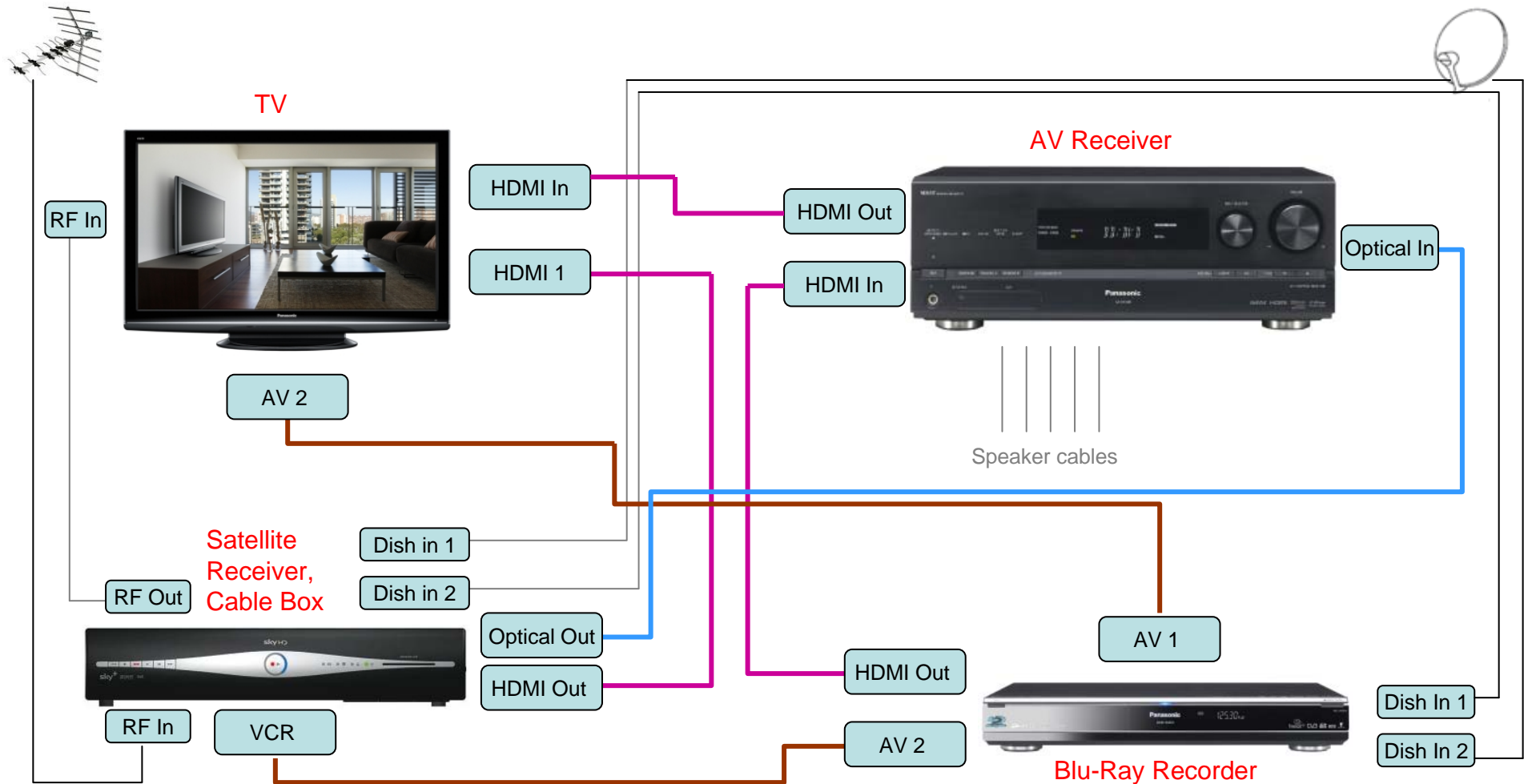

HDMI Cable

OPTICAL CABLE

Scart Cable

How do I connect a TV and a DVD recorder?

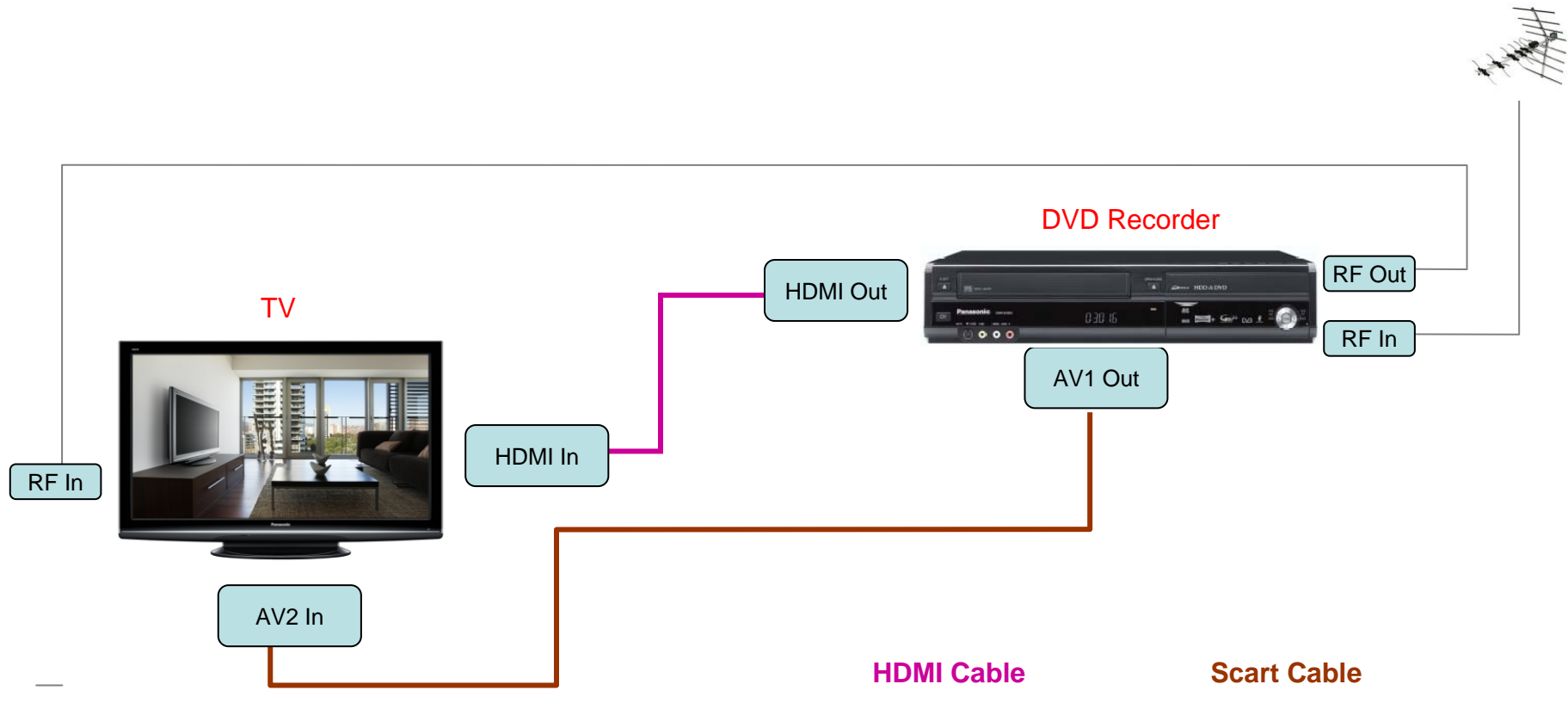

- Connect an HDMI cable from the HDMI output on the DVD Recorder to the Television's HDMI input.
- * For additional Q-Link features - Connect a Scart cable from the AV1 Out of the DVD Recorder to the AV2 input on the TV.
- *** If you do not have HDMI on either the TV or DVD Recorder connect via Scart lead.

How do I connect a TV, DVD recorder and a Home Cinema?

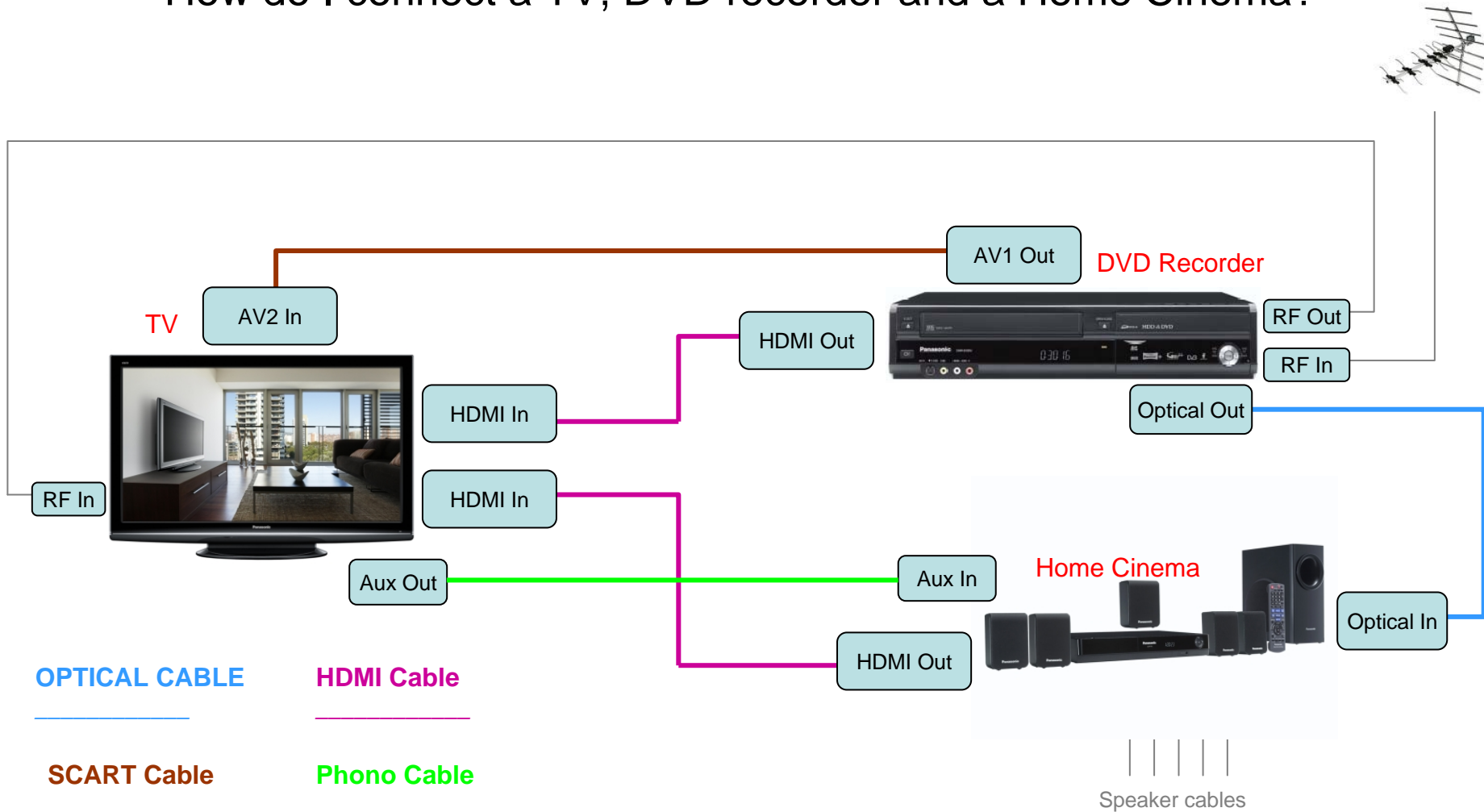

- 1, Connect an HDMI Cable from the DVD Recorder's HDMI output to the TV's HDMI input 1
- 2, Connect an HDMI Cable from the Home Cinema's HDMI Output to the TV's HDMI input 2
- 3, Connect a Scart cable from the AV1 Output of the DVD to the AV2 input on the TV, this could be used instead of an HDMI Cable or with one for use with **Q-link**
- 4, Connect an Optical Cable from the DVD Recorder's Optical Out to the Home Cinema's Optical In
- 5, Connect Phono cables from the Auxiliary out on the TV to the Auxiliary in on the Home Cinema.

How do I connect a TV, SKY-HD, DVD Recorder and an AV receiver (Optical connection)?

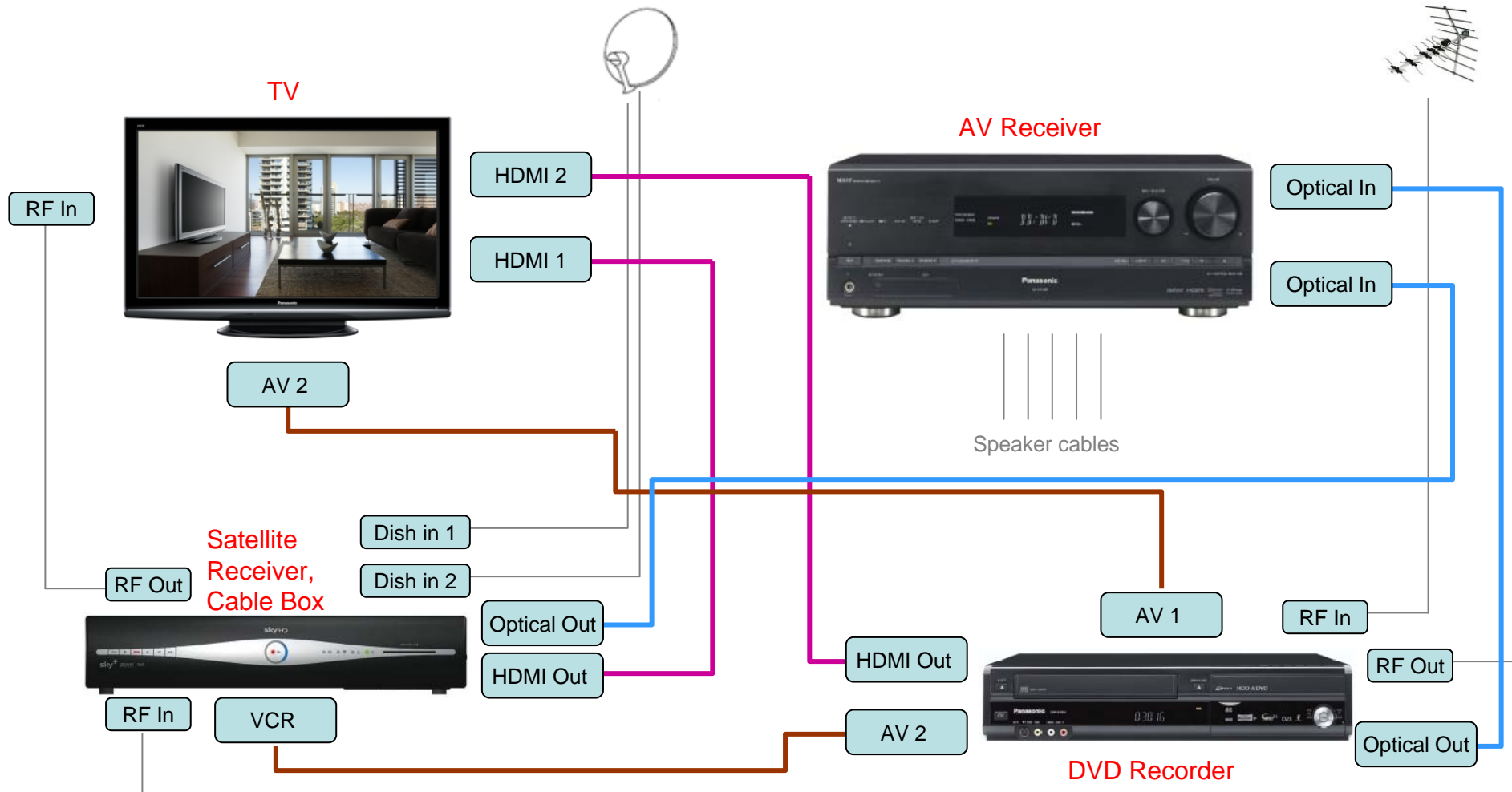

HDMI Cable

OPTICAL CABLE

SCART Cable

How do I connect a TV, SKY-HD, DVD Recorder and an AV receiver?

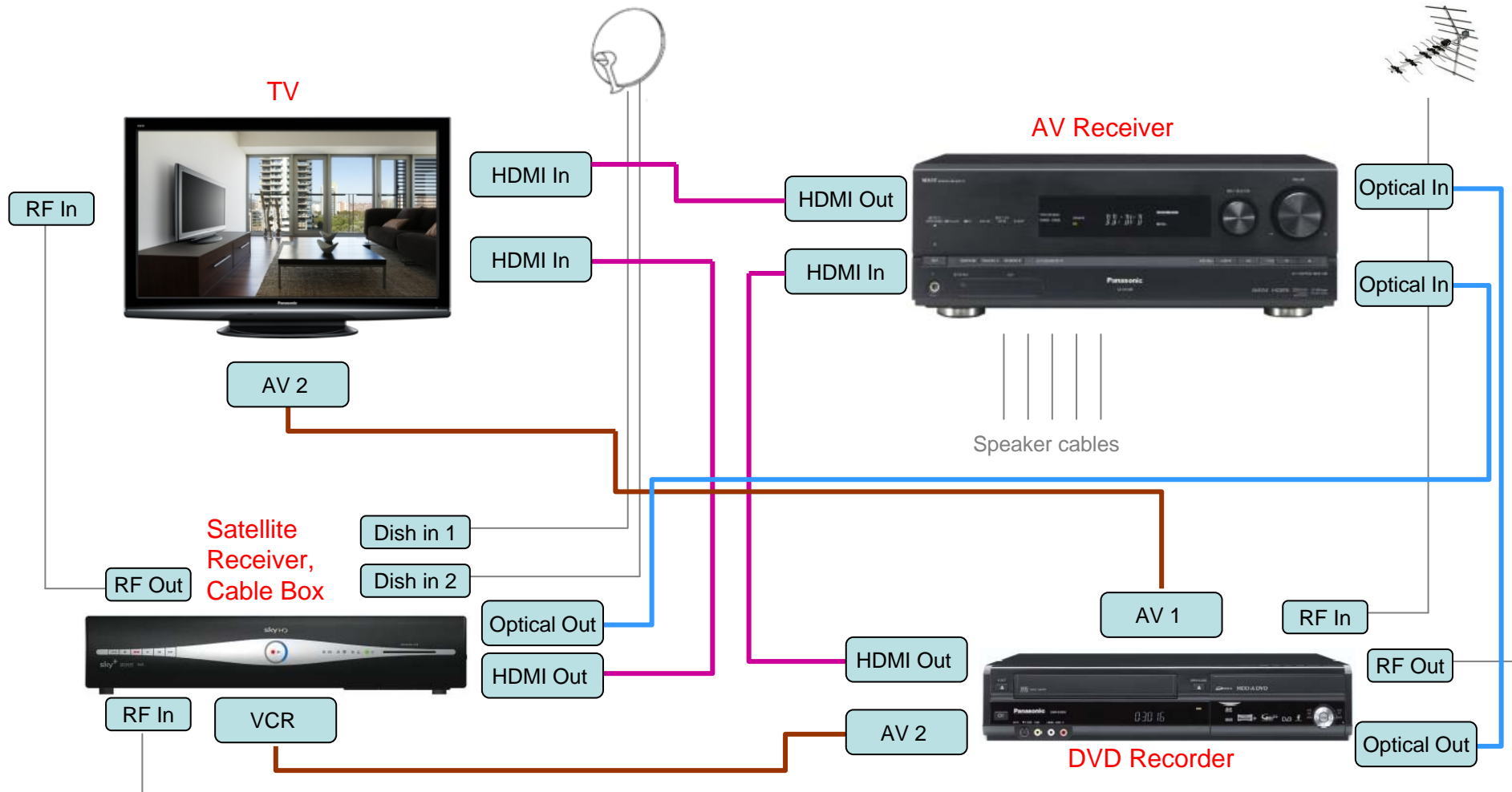

HDMI Cable

OPTICAL CABLE

SCART Cable

How do I connect a TV, SKY-HD and a DVD Recorder?

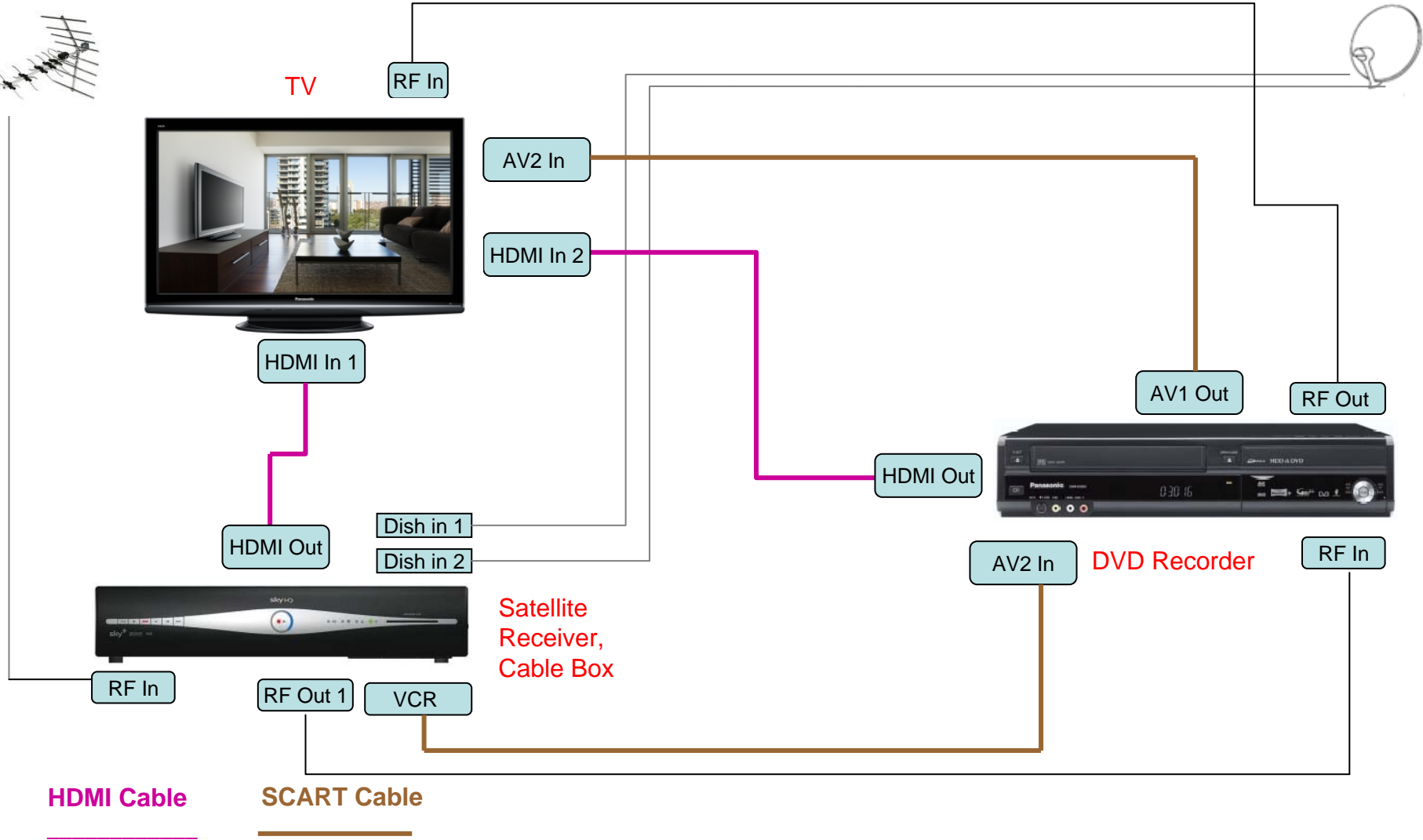

How do I connect a TV, SKY-HD, DVD Recorder and a Home Cinema?

