



Panasonic®

Operating Instructions Plasma Television

Model No. **TX-P37C10B**
TX-P42C10B
TX-P50C10B

VIERA

VIERA
Link

 **VIERA**
IMAGE VIEWER

 **DVB**®

 **GUIDEplus+**
GEMSTAR

 **OWNER I.D.**

 **SD**
HD

HD
ready

HDMI™
HIGH-DEFINITION MULTIMEDIA INTERFACE

Please read these instructions before operating your set and retain them for future reference.
The images shown in this manual are for illustrative purposes only.

U.K. Standard

English



TQB0E0823

Features

■ Receives DVB digital terrestrial broadcasts

Select the programme or set Timer Programming easily by using TV Guide. (p. 18 - 20)

Register and instantly call up favourite channels with Favourites Edit. (p. 37)

- DVB - Digital Video Broadcasting

■ VIERA TOOLS-Display special feature icons for easy accessibility (p. 14)

VIERA TOOLS is the easy way to access the special features with the VIERA TOOLS button.

■ HD ready

High Definition signals are supported by HDMI and Component Video inputs.

■ Sharp pictures with HDMI connection (p. 61)

Enjoy high-definition digital picture and high-quality sound by using an HDMI cable.

- This TV incorporates HDMI™ (Version 1.3a with x.v.Colour™) technology.

■ GUIDE Plus+ (p. 18)

This TV supports Gemstar-TV Guide sent from the GUIDE Plus+ system.

■ Owner ID (p. 42)

Owner ID is an anti-theft function. Entering the PIN number and owner's personal information will help the Police to determine the owner.

■ SDHC Card

This TV supports SDHC Card. SDHC is a high storage capacity card (more than 4 GB).

■ SD Card viewer - VIERA IMAGE VIEWER (p. 48 and p. 49)

Enjoy your photos recorded in SD Card on the TV screen.

■ Links up and controls the connected equipment with "Q-Link" and "VIERA Link" (p. 50 - 57)

Easy recording and playback, create home theatre without complicated settings, etc.

■ Supports Audio Description signal (p. 16 and p. 31)

This function can add an additional sound track to describe events on-screen (narration) and aids understanding and enjoyment, particularly for visually-impaired viewers.

You can switch Audio Description service Auto or Off, and adjust the volume of the description sound track.



digital tick

The digital tick logo indicates that a digital tuner is built-in.



Freeview

Freeview is the way to enjoy digital TV for free. There are up to 48 digital TV channels.

Digital Switchover for Terrestrial broadcasts

Starting in late 2007 and ending in 2012, TV services in the UK will go completely digital, TV region by TV region.

If you have any questions, please call Digital UK on **08456 50 50 50**

or visit **www.digitaluk.co.uk**

Digital Switchover will cover a period of several weeks. When it starts you will lose all Analogue TV channels and some Digital TV channels will be missing.

You will need to retune your TV each time this happens to recover your digital channels.

- To retune your TV → "Auto Setup" in "DVB Tuning Menu"-DVB mode (p. 34)

Users of cable or satellite boxes should still retune the TV to continue to receive Freeview channels via their aerial. (Your Analogue channel for viewing Cable or Satellite services will change to a new position.)

- Due to the digital reception technologies involved, quality of the digital signals may be relatively low in some cases, despite good reception of analogue channels.



VIERA TOUGH PANEL

A front panel increases the durability of the plasma display. This protects against accidental impacts to the screen surface, and also makes cleaning easier.



100Hz Double Scan

100Hz Double Scan is a function of this TV that reduces large area flicker.



2,000,000:1 Dynamic Contrast

A wide contrast ratio will deliver pictures with a deep black level and a brighter white level for greater image depth.



0.001 msec Panel Response Time

Extremely fast response time to minimise picture lag.



V-Audio

Utilises Panasonic's advanced digital amplification technology.



Lead-free display

All VIERA plasma display panels are lead-free. This reduces the impact on the environment when recycling or disposing of them in the future.



Up to 100,000 hours Plasma Panel Lifetime

The Plasma display panel used in the 2009 VIERA TV range is rated for up to 100,000 hours.*

*This measurement is based on the time taken for the brightness of the panel to reduce to half of it's maximum level. The time taken to reach this level may vary depending on the image content and the environment where the TV is used. Image retention and malfunctions are not taken into account.

Turn your living room into a home theatre!

Enjoy rich multi-media

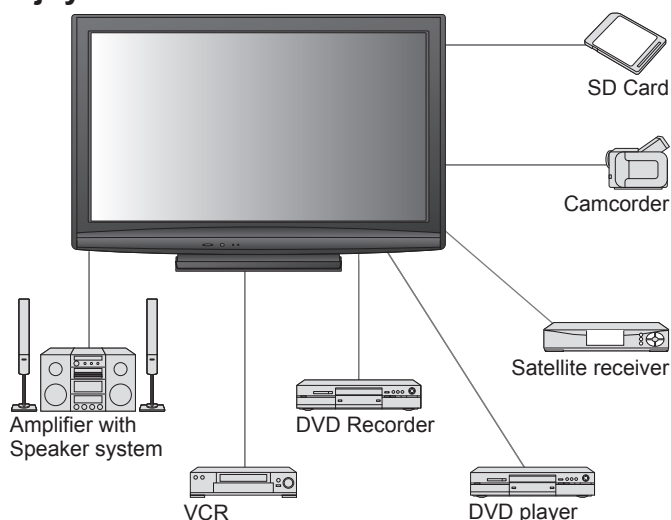

Contents

Be Sure to Read

- Safety Precautions 4
(Warning & Caution)
- Notes 5
- Maintenance 5

Quick Start Guide

- Accessories / Options 6
- Identifying Controls 8
- Basic Connection 10
- Auto Setup 12

Enjoy your TV!

Basic Features

- How to Use VIERA TOOLS 14
- Watching TV 15
- Using TV Guide 18
- Viewing Teletext 21
- Watching External inputs 24
- How to Use Menu Functions 26
(picture, sound quality, etc.)

Advanced Features

- Retuning from Setup Menu 34
- Tuning and Editing Channels (DVB) 36
- Tuning and Editing Channels (Analogue) 38
- Child lock 40
- Shipping Condition 41
- Owner ID 42
- Input Labels 43
- Advanced Settings (DVB) 44
- Recording Controls 46
- Viewing from SD Card 48
(VIERA IMAGE VIEWER)
- Link Functions 50
(Q-Link / VIERA Link)
- External Equipment 58

FAQs, etc.

- Technical Information 60
- FAQs 64
- On screen messages 66
- Glossary 69
- Index 69
- Licence 70
- Specifications 71

Safety Precautions

Warning & Caution

Handling the mains plug and lead

- Ensure that the mains plug is easily accessible at all times. The On / Off switch on this model does not fully disconnect the TV from the mains supply. Remove the mains plug from the wall socket when the TV is not used for a prolonged period of time.
- Ensure the earth pin on the mains plug is securely connected to prevent electrical shock.
 - An apparatus with CLASS I construction shall be connected to a mains socket outlet with a protective earthing connection.
- Do not use any mains lead other than that provided with this TV. (This may cause fire or electrical shock.)

Do not remove the cover

- Do not remove the rear cover as live parts are accessible when it is removed. There are no user serviceable parts inside.

Do not expose your ears to excessive volume from the headphones

- Irreversible damage can be caused.

Do not expose to direct sunlight and other sources of heat

- Avoid exposing the TV to direct sunlight and other sources of heat. To prevent fire never place any type of candle or naked flame on top or near the TV.

Do not place the TV on sloped or unstable surfaces

- The TV may fall off or tip over.

Power source

- This TV is designed to operate on 220-240 V, 50 / 60 Hz AC.

**AC 220-240 V
50 / 60 Hz**

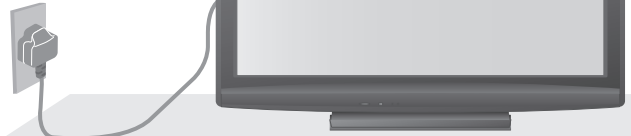

Transport only in upright position

- Transporting the TV with its display panel facing upright or downward may cause damage to the internal circuitry.

The TV is heavy. Handle by 2 or more people. Support as shown to avoid injury by the TV tipping or falling.

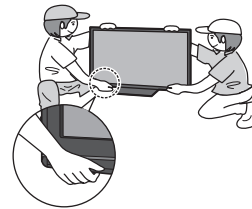



Do not allow children to handle SD Card

- As with a small object, SD Card can be swallowed by young children. Please remove SD Card immediately after use.

IMPORTANT: THE MOULDED MAINS PLUG

FOR YOUR SAFETY, PLEASE READ THE FOLLOWING TEXT CAREFULLY.

This TV is supplied with a moulded three pin mains plug for your safety and convenience. A 10 amp fuse is fitted in this mains plug. Shall the fuse need to be replaced, please ensure that the replacement fuse has a rating of 10 amps and that it is approved by ASTA or BSI to BS1362.

Check for the ASTA mark  or the BSI mark  on the body of the fuse.

If the mains plug contains a removable fuse cover, you must ensure that it is refitted when the fuse is replaced.

If you lose the fuse cover the mains plug must not be used until a replacement cover is obtained.

A replacement fuse cover may be purchased from your local Panasonic dealer.

Do not cut off the mains plug.

Do not use any other type of mains lead except the one supplied with this TV.

The supplied mains lead and moulded plug are designed to be used with this TV to avoid interference and for your safety.

If the socket outlet in your home is not suitable, get it changed by a qualified electrician.

If the plug or mains lead becomes damaged, purchase a replacement from an authorized dealer.

WARNING: – THIS TV MUST BE EARTHED.

How to replace the fuse.

Open the fuse compartment with a screwdriver and replace the fuse.

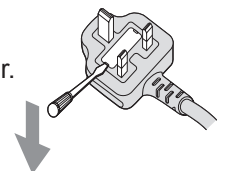

Notes

Do not expose to rain or excessive moisture

- To prevent damage which might result in electric shock or fire, do not expose this TV to rain or excessive moisture.

This TV must not be exposed to dripping or splashing water and objects filled with liquid, such as vases, must not be placed on top of or above the TV.

Do not block the rear ventilation openings

- Ventilation should not be impeded by covering the ventilation openings with items such as newspapers, tablecloths and curtains.

Allow sufficient space around the TV for radiated heat

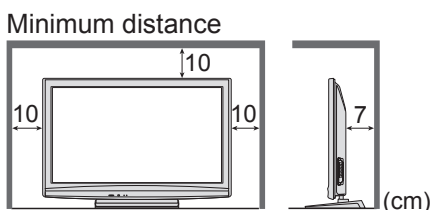

- When using the pedestal, keep the space between the bottom of the TV and the surface where the TV is set.
- In case of using Wall-hanging bracket, follow the manual of it.

Use only the dedicated pedestals / mounting equipment

- Using an unapproved pedestal or other fixtures may make the TV unstable, risking injury. Be sure to ask your local Panasonic dealer to perform setup.
- Use approved pedestals / mounts (p. 6).

Do not display a still picture for a long time

This causes the image to remain on the plasma screen ("image retention").

This is not considered a malfunction and is not covered by the warranty.

Typical still images

- Channel number and other logos
- Image displayed in 4:3 mode
- Video game
- Computer image



To prevent image retention, contrast is lowered automatically after a few minutes if no signals are sent or no operations are performed. (p. 64)

Auto power standby function

- If no signal is received and no operation is performed in Analogue TV mode for 30 minutes, the TV will automatically go to standby mode.

Keep the TV away from these types of equipment

- Electronic equipment
In particular, do not place video equipment near the TV. (Electromagnetic interference may distort images / sound.)
- Equipment with an infrared sensor
This TV also emits infrared rays. (This may affect operation of other equipment.)

Maintenance

First, remove the mains plug from the socket outlet.

Display panel

Regular care: Gently wipe the surface clean of dirt by using a soft cloth.
Major contamination: Wipe the surface clean using a soft cloth dampened with clean water or diluted neutral detergent (1 part detergent to 100 parts water). Then, using a soft dry cloth, evenly wipe the surface clean until it is dry.

Caution

- Do not tap or scratch the surface with your fingernail or other hard object.
- Take care not to subject the surface to insect repellent, solvent, thinner, or other volatile substances (this may degrade surface quality).

Cabinet, Pedestal

Regular care: Wipe the surface clean using a soft dry cloth.
Major contamination: Dampen a soft cloth with clean water or water containing a small amount of neutral detergent. Then, wring the cloth and wipe the surface clean with it. Finally, wipe the surface clean with a dry cloth.

Caution

- Take care not to subject the TV's surfaces to detergent. (A liquid inside the TV could lead to product failure.)
- Take care not to subject surfaces to insect repellent, solvent, thinner, or other volatile substances (this may deteriorate the surface by peeling the paint).
- Do not allow the cabinet and pedestal to make contact with a rubber or PVC substance for a long time.

Mains plug

Wipe the mains plug with a dry cloth at regular intervals. (Moisture and dust may lead to fire or electrical shock.)

Accessories / Options

Standard accessories

Check that you have the accessories and items shown

- Remote Control
 - N2QAYB000328



- Batteries for the Remote Control (2)
 - R6 (UM3)



- Mains Lead
 - K2CT3YY00016
 - ➔ p. 11

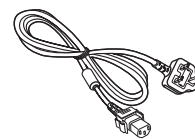

- Operating Instructions
- Pan European Guarantee Card
- CRM (Customer Relationship Management)

- Cleaning cloth
 - TXFPE01RLTB



- Pedestal
 - TBLX0096
 - TXFBL01EQUE (TX-P37C10B, TX-P42C10B)
 - TBLX0089
 - TXFBL01EQUU (TX-P50C10B)
 - ➔ p. 7

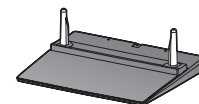

- This product contains possibly dangerous parts (such as plastic bags), that can be breathed in or swallowed by young children accidentally. Keep these parts out of reach of young children.

Optional accessories

Please contact your nearest Panasonic dealer to purchase the recommended wall-hanging bracket. For additional details, please refer to the wall-hanging bracket installation manual.

Wall-hanging bracket

- TY-WK4P1RW

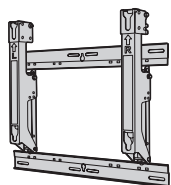

Rear of the TV

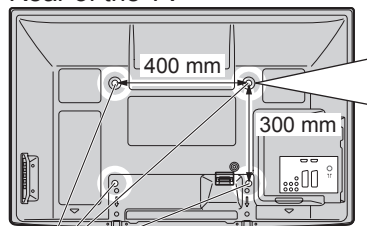

Holes for wall-hanging bracket installation

Screw for fixing the TV onto the wall-hanging bracket (not supplied with the TV)

Depth of screw:

For TX-P37C10B, please be sure to keep this length 16 mm

For TX-P42C10B and TX-P50C10B minimum 16 mm, maximum 36 mm

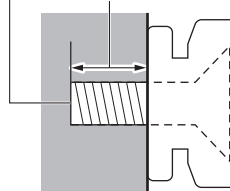

(View from the side)

Caution

- In order to maintain the unit's performance and safety, be absolutely sure to ask your dealer or a licenced contractor to secure the wall-hanging brackets.
- Carefully read the instructions accompanying optional accessories, and be absolutely sure to take steps to prevent the TV from tipping over.
- Handle the TV carefully during installation since subjecting it to impact or other forces may cause product damage.
- Take care when fixing wall brackets to the wall. Always ensure that there are no electrical cables or pipes in the wall before hanging bracket.
- When using the angled-type wall hanging bracket, please ensure that there is sufficient space for the connecting cables not to press against the wall when the TV is tilted forward.
- To prevent fall and injury, remove the TV from its fixed wall position when it is no longer in use.

Installing / removing remote's batteries

1

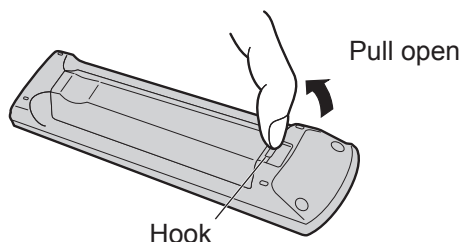

Hook

2

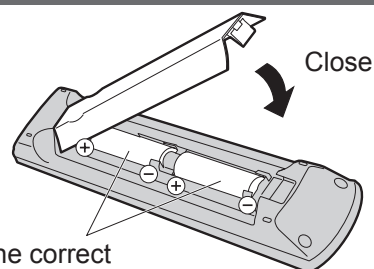

Note the correct polarity (+ or -)

Caution

- Incorrect installation may cause battery leakage and corrosion, resulting in damage to the remote control.
 - Do not mix old and new batteries.
 - Do not mix different battery types (such as alkaline and manganese batteries).
 - Do not use rechargeable (Ni-Cd) batteries.
 - Do not burn or breakup batteries.
- Batteries must not be exposed to excessive heat such as sunshine, fire or the like.

Attaching the pedestal

Warning

Do not disassemble or modify the pedestal.

- Otherwise the TV may fall over and become damaged, and personal injury may result.

Caution

Do not use any other TV and displays.

- Otherwise the TV may fall over and become damaged, and personal injury may result.

Do not use the pedestal if it becomes warped or physically damaged.

- If you use the pedestal while it is physically damaged, personal injury may result. Contact your nearest Panasonic dealer immediately.

During set-up, make sure that all screws are securely tightened.

- If insufficient care is taken to ensure screws are properly tightened during assembly, the pedestal will not be strong enough to support the TV, and it might fall over and become damaged, and personal injury may result.

Ensure that the TV does not fall over.

- If the TV is knocked or children climb onto the pedestal with the TV installed, the TV may fall over and personal injury may result.

Two or more people are required to install and remove the TV.

- If two or more people are not present, the TV may be dropped, and personal injury may result.

Ⓐ Assembly screw (4)
(silver)

- XYN5+F18FN

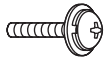

M5 × 18

Ⓑ Assembly screw (4)
(black)

- THEL061N
(TX-P37C10B)
(TX-P42C10B)
- THEL060N
(TX-P50C10B)

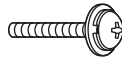

M5 × 25

Ⓒ Pole (2)

- R : TBLA3685
- L : TBLA3686
(TX-P37C10B)
(TX-P42C10B)
- R : TBLA3679
- L : TBLA3680
(TX-P50C10B)

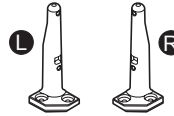

Ⓓ Base

- TBLX0096
(TX-P37C10B)
(TX-P42C10B)
- TBLX0089
(TX-P50C10B)

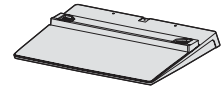

■ Assembling the pedestal

Use the four assembly screws Ⓐ to fasten the left and right poles to the base securely.

- Make sure that the screws are securely tightened.
- Forcing the assembly screws the wrong way will strip the threads.
- "L" or "R" mark is stamped on the bottom of the pole.

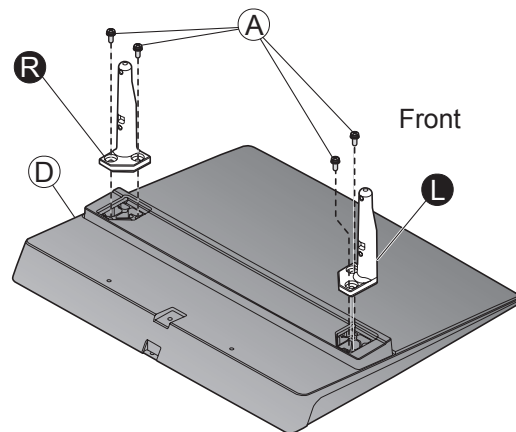

■ Securing the TV

Use the assembly screws Ⓑ to fasten securely.

- Make sure that the screws are securely tightened.
- Carry out the work on a horizontal and level surface.

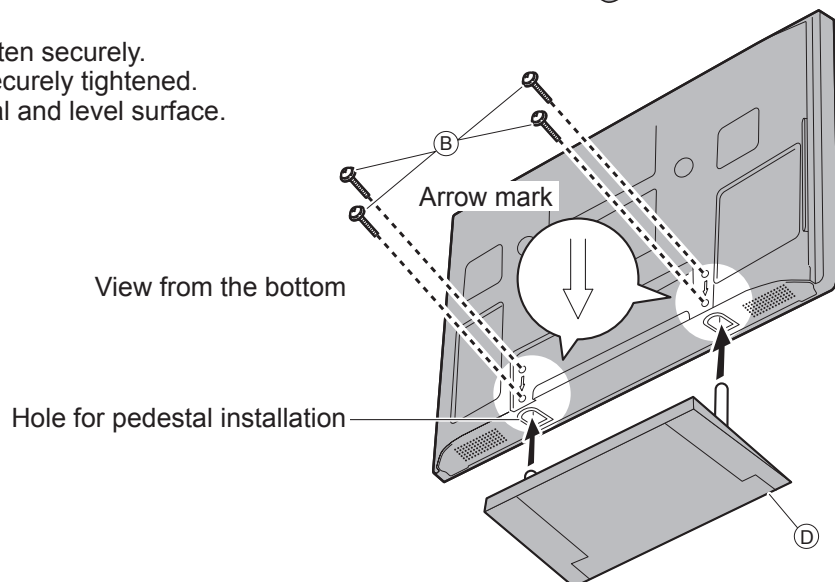

Identifying Controls

TV

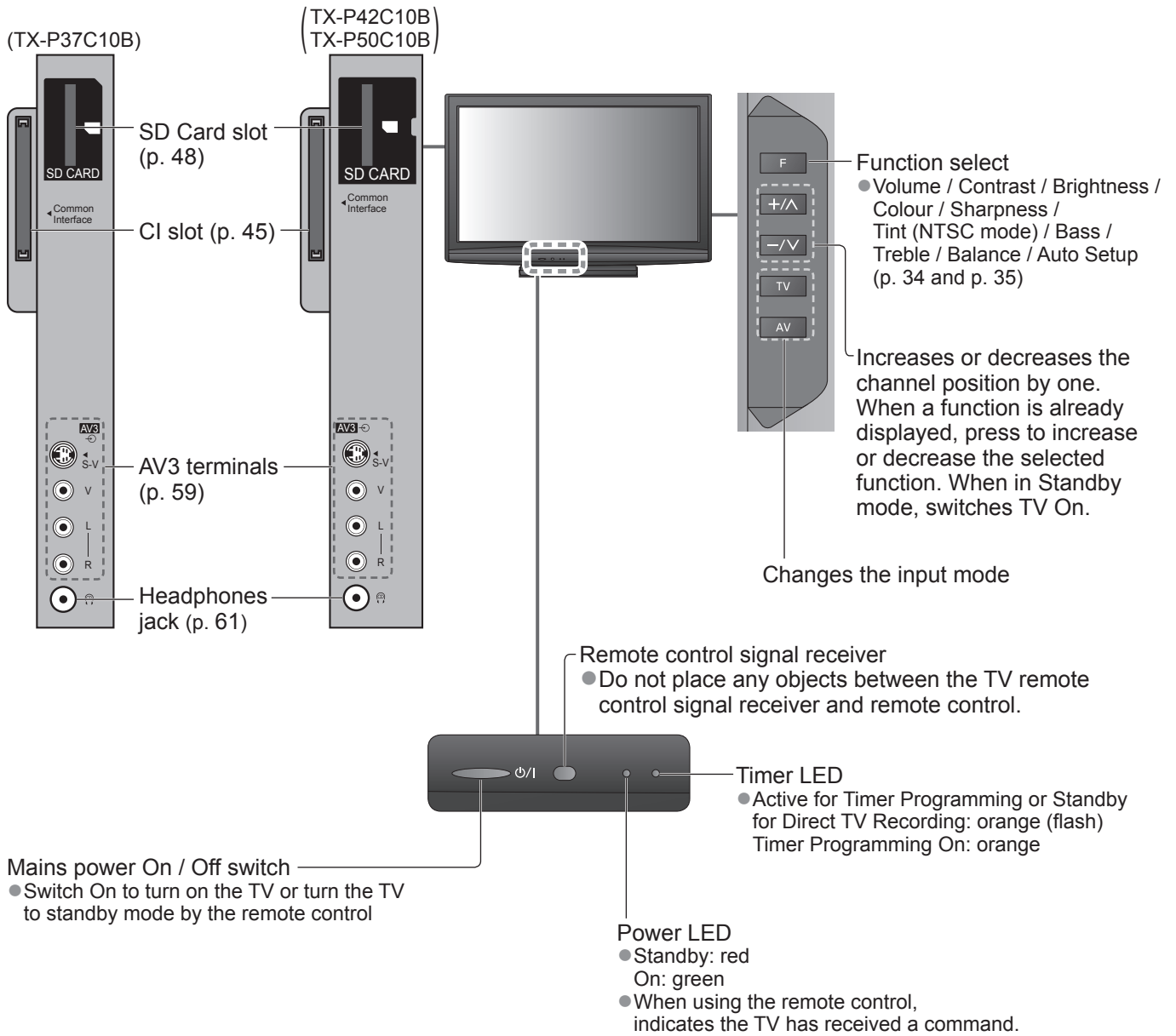

Remote Control

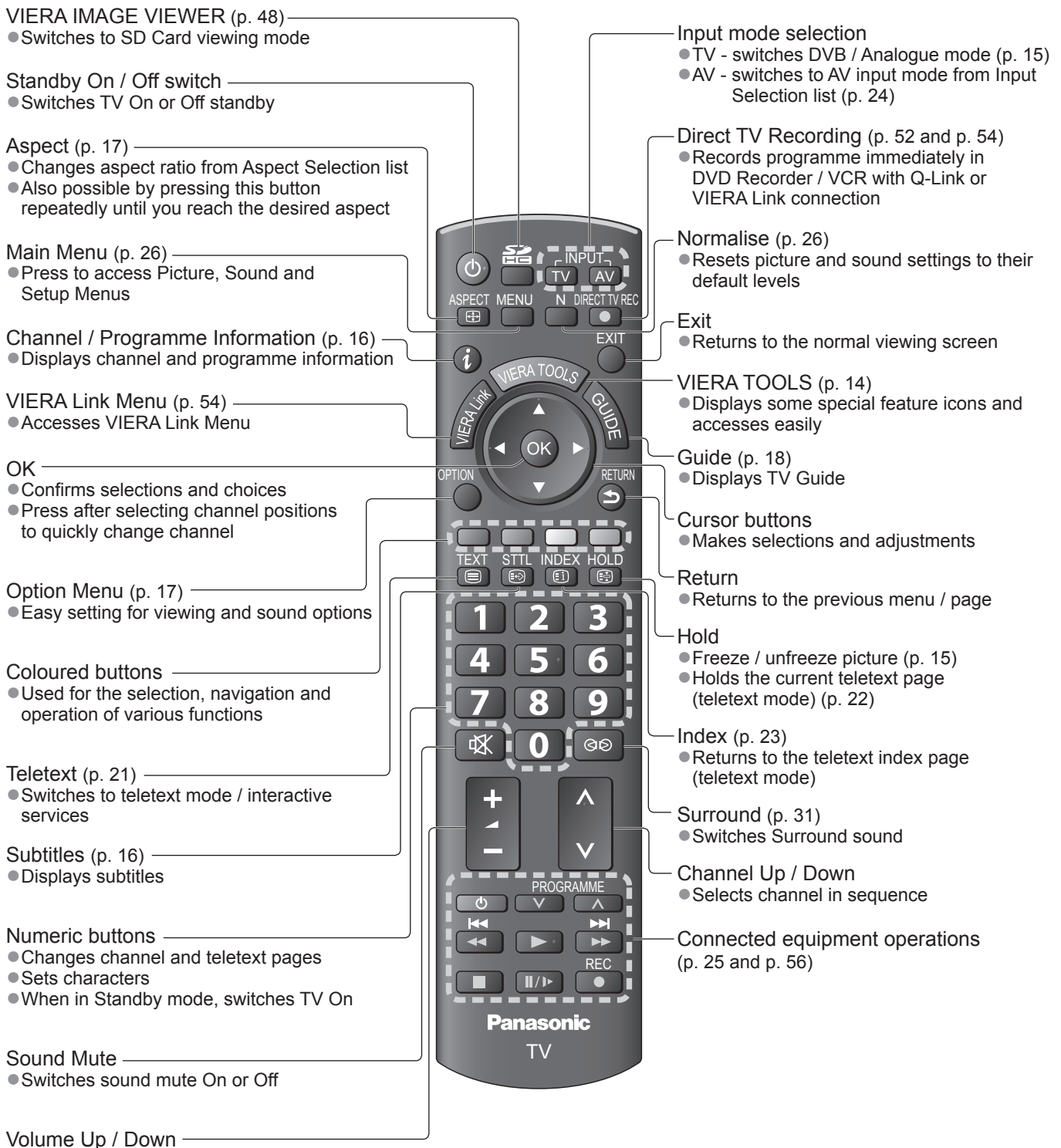

Basic Connection

External equipment and cables shown are not supplied with this TV.

Please ensure that the unit is disconnected from the mains socket before attaching or disconnecting any leads. When disconnecting the mains lead, be absolutely sure to disconnect the mains plug at the socket outlet first.

Example 1 Connecting aerial

TV only

Rear of the TV

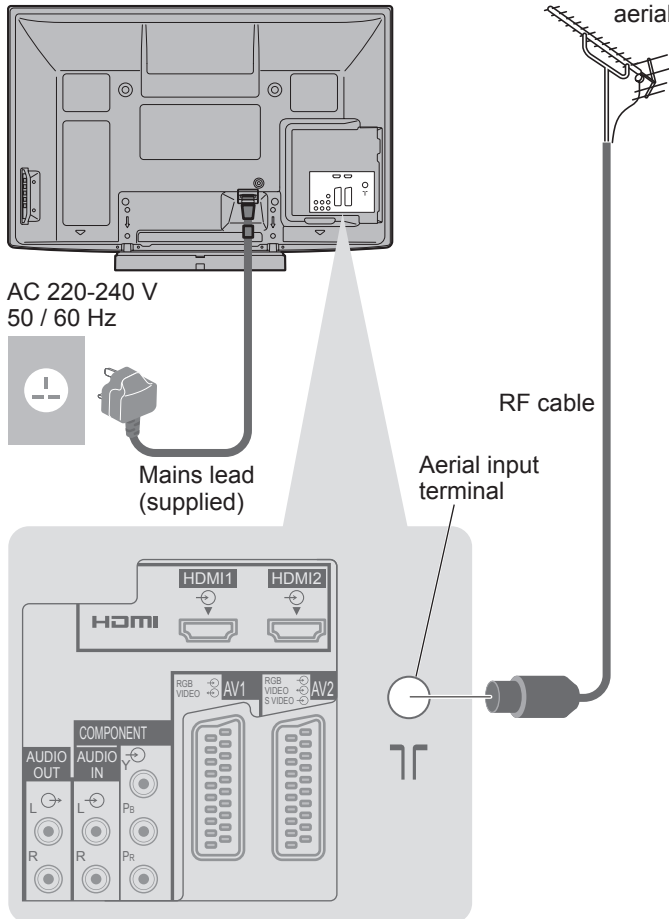

Example 2 Connecting DVD Recorder / VCR

TV, DVD Recorder or VCR

Rear of the TV

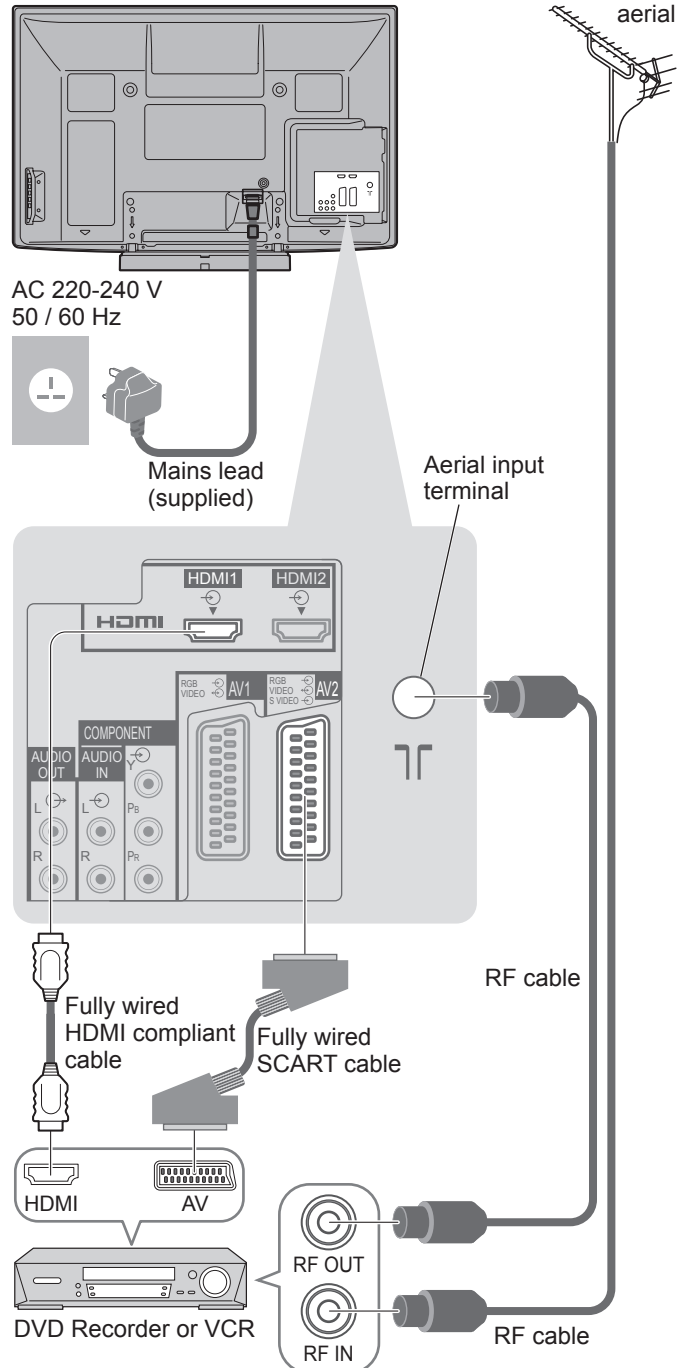

Note

- Connect to the TV's AV2 for a DVD Recorder / VCR supporting Q-Link (p. 52).
- Connect to the TV's AV1 for a Satellite receiver.
- For HDMI-compatible equipment, possible to connect to HDMI terminals (HDMI1 / HDMI2) by using HDMI cable (p. 58).
- Q-Link connection → p. 50
- VIERA Link connection → p. 50 and 51
- Read the manual of the equipment too.

Example 3 Connecting DVD Recorder / VCR and Satellite receiver

TV, DVD Recorder / VCR and Satellite

Rear of the TV

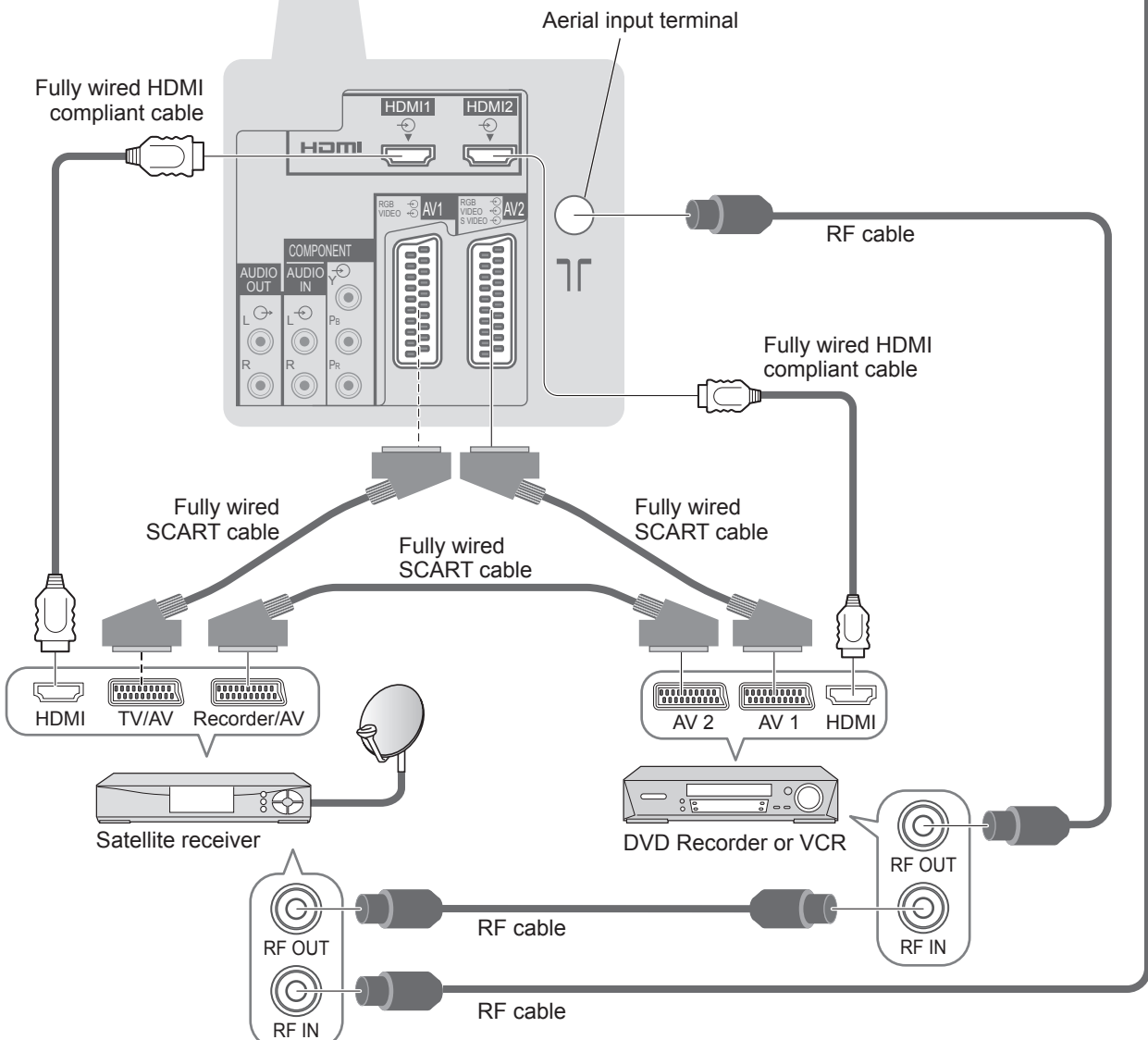
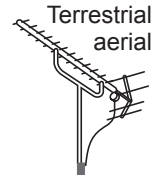
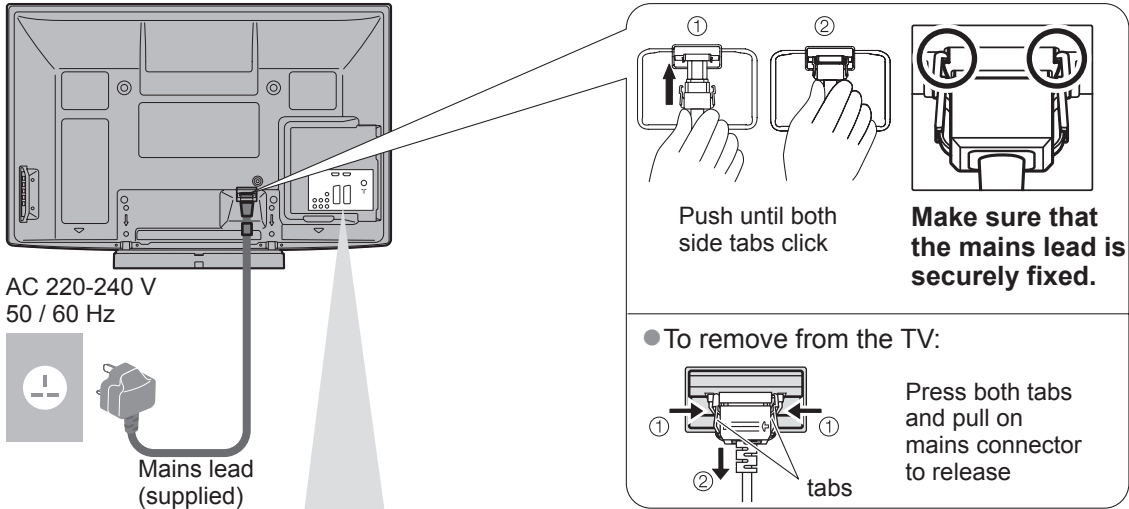

Auto Setup

Search and store TV channels automatically.

- These steps are not necessary if the setup has been completed by your local dealer.
- Please complete connections (p. 10 and p. 11) and settings (if necessary) of the connected equipment before starting Auto Setup. For details of settings for the connected equipment, read the appropriate manual.

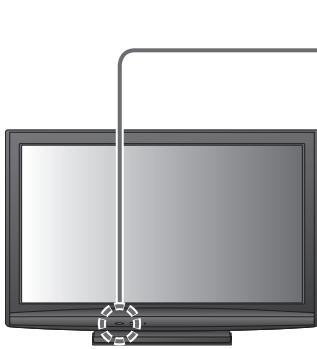

1 Plug the TV into mains socket and switch On

(Takes a few seconds to be displayed)



- Auto Setup will start to search for TV channels and store them in the numbered order as specified by the broadcasters.

Auto Setup - DVB and Analogue				
DVB Scan	CH 21	68		
Analogue Scan	CH 21	68		
This will take about 6 minutes.				
CH	Channel Name	Type	Quality	
62	CBBC Channel	Free TV	10	
62	BBC Radio Wales	Free TV	10	
62	E4	Free TV	10	
62	Cartoon Nwk	Free TV	10	
29		Analogue	-	
33	BBC1	Analogue	-	
Free TV: 4	Play TV: 0	Radio: 0	Data: 0	Analogue: 2
	Searching			

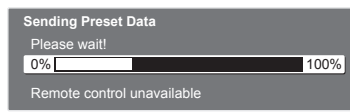

- If Q-Link, or similar technology (p. 52), compatible recorder with analogue tuner is connected, analogue channel setting is automatically downloaded to the recorder. (Digital channel setting is not downloaded.)
- If downloading has failed, you can download later through the Setup Menu.
 - ➔ "Q-Link Download" (p. 32)

2 Input Owner ID



- Please enter your own choice of PIN number, name, etc. to help the police to crack crime.
- Make a note of the PIN number in case you forget it.
 - You can skip this step and input the Owner ID later.
 - ➔ "Owner ID" (p. 42)

3 Select "Home"

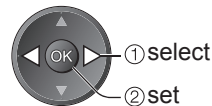
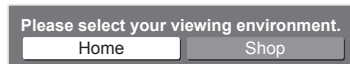

Auto Setup is now complete and your TV is ready for viewing.



- To check channel list at-a-glance
 - ➔ "Using TV Guide" (p. 18)
- To edit channels
 - ➔ "Tuning and Editing Channels" (p. 36 - 39)

Using the On Screen Displays

Many features available on this TV can be accessed via the On Screen Display menu.

■ How to use remote control



Move the cursor / select the menu item



Move the cursor / adjust levels / select from a range of options



Access the menu / store settings after adjustments have been made or options have been set



Return to the previous menu



Open the main menu



Exit the menu system and return to the normal viewing screen

■ ON SCREEN HELP Instructions box - Operation guide

(example: Owner ID)

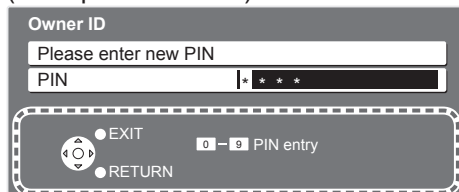

Operation guide will help you.

Note

- If tuning has failed → “Auto Setup” (p. 34 and p. 35)
- To initialize all settings → “Shipping Condition” (p. 41)
- If you turned the TV Off during Standby mode last time, the TV will be in Standby mode when you turn the TV On with Mains power On / Off switch.

■ How to input Owner ID

Enter the PIN number (4 digits)



- Enter the PIN number twice at first setting.

Select NAME / HOUSE NO / POSTCODE and access the “User input” mode

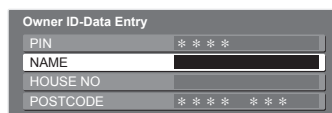

- ① select
- ② access

Set characters one by one



- ① select
- ② set

- You can set characters by using numeric buttons.
→ “Characters table for numeric buttons” (p. 63)

Return to select other items



or

Exit the menu to go to next step



■ “Shop” mode (for shop display use only)

Automatic Demo Off / On selection screen is displayed.



(This is not available in “Home” mode)

You can change the viewing environment at this stage

Select “Home”



- ① select
- ② set

Auto Setup is complete

- If you set to “Off” or “On” in Automatic Demo Off / On selection screen, the TV will be in “Shop” viewing environment (p. 70), and Auto Setup will be complete.
- To change viewing environment later on, you will need to initialise all settings by accessing Shipping Condition and go through Auto Setup again.
→ “Shipping Condition” (p. 41)

How to Use VIERA TOOLS

You can access some special features easily by using the VIERA TOOLS function.

- For “VIERA Link Control” and “Pause Live TV” functions to operate correctly, ensure the connections and settings are completed.
 - ➔ “Summary of Q-Link and VIERA Link features” (p. 50 and p. 51), “Preparations” (p. 53)
- After connection, turn the equipment on and then switch the TV on.

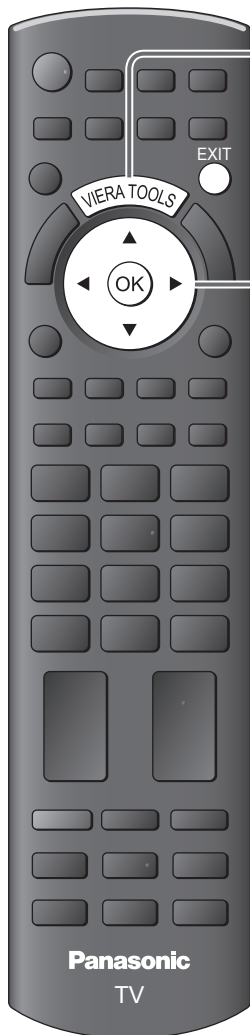

1 Display icons of the feature



2 Select a feature

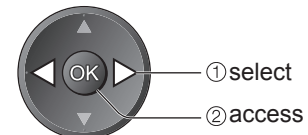

3 Follow the operations of each feature

- VIERA Link Control ➔ “VIERA Link Control” (p. 56)



When more than two pieces of compatible equipment are connected a selection screen will be displayed. Please select the correct description and access.

- Pause Live TV ➔ “Pause Live TV” (p. 55)



- Slideshow ➔ “Slideshow” (p. 49)



Slideshow will use all of the photos on the SD Card.

- Photos ➔ “Photo View” (p. 48)



■ To return to TV



Watching TV



1 Turn power on
(Press for about 1 second)



- Mains power On / Off switch should be On. (p. 8)

2 Select DVB or Analogue



- Also possible by pressing the TV button on the side panel of the TV. (p. 8)

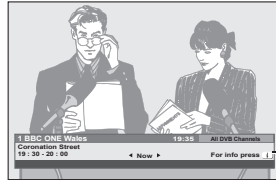

Information banner appears whenever you select a channel

- For details → p. 16

3 Select a channel

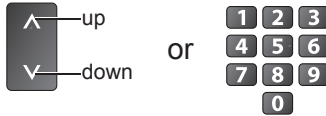

DVB channel position numbers run from 1 onwards.
Analogue channel position numbers run in the ranges 0 - 99.

- To select a two or three-digit channel position number, e.g. 39
→ **3** → **9**

Volume

Panasonic TV

Note

- To watch pay-TV
→ "Common Interface" (p. 45)

Select a channel using Information banner (p. 16)
Possible to confirm the channel name and programme before changing channels. Display Information banner if it is not displayed

While the banner is displayed, select the channel

- Possible to set display timeout in "Banner Display Timeout" (p. 33).

Select a channel using TV Guide (p. 18)
Possible to confirm the TV Guide (EPG) before changing channels. Display TV Guide

Select the programme now on the air

Select "View" (DVB mode)

Other useful functions

Hold

Freeze / unfreeze picture



Watching TV

Other useful functions

Display subtitles

DVB mode

Display / hide subtitles (if available)

- To change the language for DVB (if available) → "Preferred Subtitles" (p. 33)



Analogue mode

Display subtitles

- To hide subtitles →



Note

- This is the same as switching to Analogue teletext service and selecting "P888" (subtitle service). (p. 23)
- You cannot change the channel when this function is active.

Display Information banner

Display Information banner

- Also appears when changing a channel

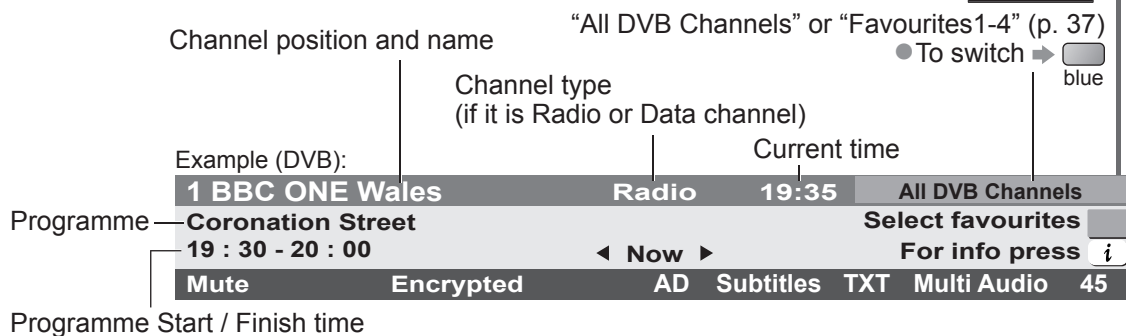

Example (Analogue):



Channel number

- To confirm another tuned channel name →
- To watch the channel listed in the banner →
- Information on the next programme (DVB) →
- To hide →
- Extra information → (press again to hide the banner)
- To set display timeout → "Banner Display Timeout" (p. 33)

Features available / Message meanings

- Mute**
Sound mute On
- Bad signal**
Poor TV signal quality
- Encrypted**
Scrambled programme
- AD**
Audio Description service available
 - This function can aid visually-impaired viewers by adding an additional audio track to describe events on-screen.
 - For settings → p. 31
- Subtitles**
Subtitle service available
- TXT**
Teletext service available
- Multi Audio**
Multiple audio available
- Stereo, Mono, NICAM**
Audio mode
- 1 - 90**
Off Timer remaining time
 - For settings → p. 17

- "AD", "Subtitles", "TXT", "Multi Audio" indications are displayed as available on particular programmes, but may not be available for all individual programmes being broadcast. Display the extra information to confirm availability of these functions.

Example:



■ Other useful functions

Aspect

Change the aspect ratio (image size)



Enjoy viewing the image at its optimum size and aspect. Normally programmes have the Aspect Control Signal (Widescreen signal, etc.), and the TV will choose the aspect ratio automatically according to the Aspect Control Signal (p. 60).

■ If you would like to change the aspect ratio manually

Display Aspect Selection list

While the list is displayed, select the mode

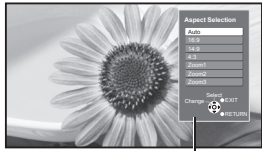

Aspect Selection list

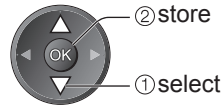

- To change the mode using the ASPECT button only
 → ASPECT (Press repeatedly until you reach the desired mode)

Auto



The best ratio is chosen and the image expanded to fill the screen. For details → p. 60

16:9



Directly displays the image at 16:9 without distortion (anamorphic).

4:3



Displays the image at the standard 4:3 without distortion.

Zoom2



Displays a 16:9 letterbox (anamorphic) image full-screen without distortion.

14:9



Displays the image at the standard 14:9 without distortion.

Zoom1



Displays a 16:9 letterbox or 4:3 image without distortion.

Zoom3



Displays a 2.35:1 letterbox (anamorphic) image full-screen without distortion. At 16:9, displays the image at its maximum (with slight enlargement).

Note

- Not available when the subtitle function is active.
- Not available in teletext service.
- Aspect mode can be memorized separately for SD (Standard definition) and HD (High definition) signals.

Display the selectable settings for the current programme

Check or change the current programme status instantly



- To change

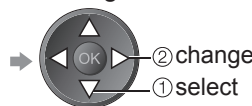

Multi Audio (DVB mode)

Allows you to select between alternative language for sound tracks (if available)

Subtitle Language (DVB mode)

Allows you to select the language in which subtitles should appear (if available)

NICAM (Analogue mode)

→ Sound Menu (p. 31)

Volume Correction

Adjusts volume of individual channel or input mode

Audio Description (DVB mode)

Set to "Auto" if the programme has Audio Description service, then you will hear an additional audio track to describe events on-screen

- To adjust the volume for Audio Description
 → "Audio Description Menu" (p. 31)

Note

- Also possible to change the settings in Menu list (p. 30 - 33).

Off Timer

Turn the TV off automatically after a fixed period

Display the menu



Select "Setup"

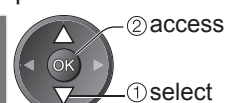

Select "Off Timer" and set the time

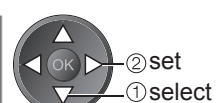
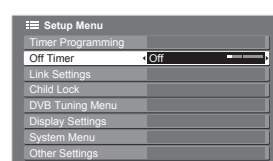

- To cancel → Set to "Off" or turn the TV off.
- To display the remaining time → Information banner (p. 16)

Note

- When the remaining time is within 3 minutes, the remaining time will flash on the screen.

Using TV Guide

TV Guide—Electronic Programme Guide (EPG) provides an on-screen listing of the programmes currently broadcast and the forthcoming broadcasts over the next seven days (depending on the broadcasters).

- This TV supports the GUIDE Plus+ system.
- The Gemstar branding partner will supply the rating informations in the programme information and the recommended group in the Prog.Type list.
- Analogue channels will be listed after DVB channels but there will be no programme listings. “D” means DVB channel and “A” means Analogue channel
- When this TV is turned on for the first time, or the TV is switched off for more than a week, it may take some time before the TV Guide is completely shown.

1 Select DVB or Analogue

2 View TV Guide

- To change the layout (Landscape / Portrait) view “Landscape” to see many channels view “Portrait” to see one channel at a time

Example: TV Guide: Landscape

1 BBC ONE	20:00 - 20:30	DIY SOS : We open in the Balt...
D 1 BBC ONE	Eastender	DIY SOS
D 7 BBC THREE	Hot Wars	The Bill
D 14 E4	Emmerdal	Coronation Street
D 70 BBC FOUR	10 O'clock News BBC	Pepsi Char.
D 72 BBC 2W	Panorama	Spring watch
D 105 BBC1	I'm A Celebrity	Pop Idol
D 718 BBC Radi	Rugby	15 To 1

Example: TV Guide: Portrait

19:30-20:00	Eastender
20:00-20:30	DIY SOS
20:30-21:00	The Bill
21:00-22:00	Red Cap
22:30-23:00	Live Junction
23:00-23:30	POP 100
23:00-00:00	Rugby

■ To the previous day (DVB mode)



■ To the next day (DVB mode)



■ To view a channel list of the selected type (DVB mode)



Prog.Type	All Types
All Types	Movie
News and Factual	...
...	...

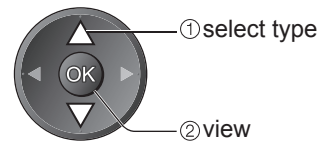

■ To return to TV



■ To view a channel list of the selected category



Category	All Channels
All Channels	All DVB Channels
All Analogue Channels	Free DVB Channels
TV/Data DVB Channels	Favourites1
Favourites1	Favourites2
Favourites2	Favourites3
Favourites3	Favourites4

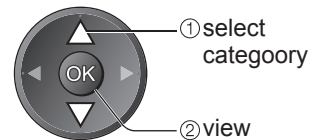

To list favourite channels
→ p. 37

■ **Other useful functions** (Operate whilst viewing TV Guide)

View advertisement

Enter your postcode when using this function for the first time

➔ "Postcode" in "GUIDE Plus+ Settings" (p. 33)

If you have already entered your postcode in "Auto Setup" - when first using the TV (p. 12), you do not have to enter again.

If you enter an incorrect postcode for your area, or no postcodes are entered, advertisement may not be displayed correctly.

Display advertisement information

OPTION



- To display the latest advertisement, you will need to update the information.
To update the information continuously, the TV must be left in Standby mode at night.

■ **To change advertisements**



■ **To return to TV Guide**



Note

- Some advertisements are for future programmes.
In this case it is possible to use the Guide link recording function (p. 20).
- The advertisements displayed on the TV Guide are sent from the GUIDE Plus+ system so that they cannot be deleted manually or will not be lost even when the TV is turned Off with Mains power On / Off switch.

Watch the programme

Select the current programme or channel

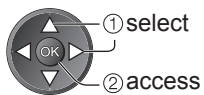

Select "View" (DVB mode)

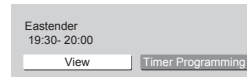

- Timer Programming
➔ see below



(TV screen)

View details of the programme (DVB mode)

Select the programme



View details



Details

■ **To return to the start page**



Timer Programming (DVB mode)

Select the forthcoming programme to output to external recorder

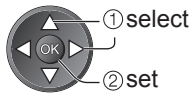

Timer Programming							Wed 15/10/08 18:50	
No.	Channel Name	Date	Start	End	min.	STTL		
D-1	BBC1	17/10 FR	18:00	20:00	120	OFF		
0	<TIMER>							
D-3	TV4	18/10 SA	21:30	22:30	60	OFF		
	Freshly Squeezed Extra							
...								
...								

(Timer Programming screen)

Timer LED will turn on if Timer Programming is set.

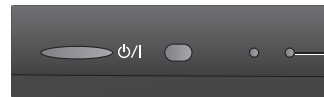

Timer LED

- Orange Timer LED (Blinking during timer active)

■ **To check / change / cancel a Timer Programming event**

➔ "Timer Programming" (p. 47)

■ **To return to TV Guide**



Note

- While recording, you cannot watch any other channels except the one being recorded.
- When recording programmes, you must make the proper settings on the recorder connected to the TV.
If a compatible recorder with Q-Link or similar technologies is connected to the TV (p. 52) and the "Link Settings" (p. 32) are completed, no setting of the recorder is required.
Also read the manual of the recorder.
- If you select the current programme, a screen asking you to confirm whether you wish to watch or record it will appear. Select "Timer Programming" to record from the time you finish the Timer Programming setting.

Using TV Guide

Other useful functions (Operate whilst viewing TV Guide)

Guide link recording (Timer Programming from the TV Guide signal)

Guide link recording is a timer programme controlled by information from the TV Guide.

Programme start and end times may be changed by broadcasters and sent to the TV for timer programme to follow the change.

Split Programme is a programme which is interrupted by one or more other programmes.

Both of the above are subject to signals being sent by broadcasters.

Select the forthcoming programme to output to external recorder

“Guide” is displayed if the timer is set from the TV Guide

No.	Channel Name	Date	Start	End	min.	S.TTL
D 1	BBC1	17/10 FR	18:00	20:00	120	OFF
D 1	BBC1	18/10 SA	21:30	22:30	60	OFF
D 3	ITV1	18/10 SA	22:30	23:30	60	OFF

“S/P” is displayed if the timer is set from the TV Guide and the programme is a Split Programme

“G” will be displayed in the TV Guide if Timer Programming is set.

Time	18:30	19:00	19:30	19:55
1	BBC1	Eastender	EMV SOS	Holiday News
2	BBC1	Hot Wars	Holiday Program	
3	ITV1	Emmerdale	Coronation Street	The Bill
4	BBC FOUR	10 O'clock News BBC	Pepsi Char	Good bye
5	BBC TWO	Panorama	Spring watch	Coast
6	BBC	Fun A Celebrity	Prop Med	News
7	BBC Radio	Rugby	15 To 1	The Bill

(Timer Programming screen)

To check / change / cancel a Guide link recording event

➔ “Timer Programming” (p. 47)

- If you edit the start time or end time of Guide link recording more than 10 minutes after setting to record, it will no longer be performed as Guide link recording. The recording will be performed according to the time setting in Timer Programming.

To return to TV Guide ➔

Note

- Not available in Analogue mode.
- Whilst making Split Programme recording, it is not possible to record any other programmes between the interrupted programmes.
- The Split Programme recording does not work if the separated parts are broadcast on differing channels.

Viewing Teletext

You can enjoy news, weather forecasts and subtitles, etc. (depending on the broadcaster)

- The availability of teletext services for a programme is indicated by "TXT" in the information banner.

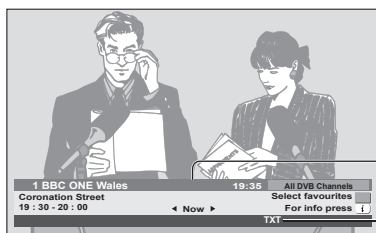

Information banner (p. 16)

Displayed if programme has teletext service

DVB teletext (MHEG)

DVB teletext services

DVB teletext services differ greatly from analogue teletext.

When you switch to a digital teletext service, the images you see can contain graphics and text, laid out and controlled in a manner decided by the broadcaster.

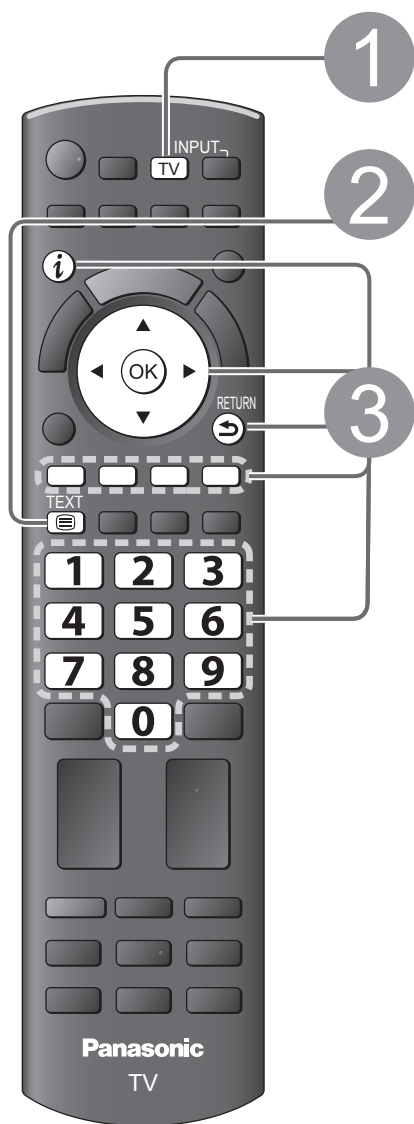

1 Select DVB



- DVB programmes have digital teletext services (MHEG).

2 Switch to Teletext

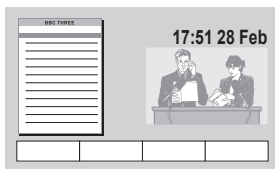

How to use

In all cases, it is possible to navigate the pages using buttons on the remote control, but because the commands available must apply to all manufacturers of digital equipment, some on screen commands may not correspond exactly to the remote control buttons.

For example:

- When "select" or "go" is displayed →

- When "◀", "▶", "▲", "▼" symbol is displayed →

- When the key words are displayed on colour bar →

- When options with numbers are displayed →

- When "i" is displayed → (information)

- To return to TV →

Note

- As soon as you switch to a digital channel with links to a teletext service, software is downloaded in the background to enable the teletext function. This means that when switching to a digital channel, you should wait for approximately 5 seconds before pressing the TEXT button - this will allow the software to download. If you press the TEXT button before download is complete, there will be a short delay before the text screen is displayed.
- While navigating digital teletext, you will find there is a short delay when moving between pages while the page downloads. There is often a prompt shown somewhere on the page (for example "Loading") to let you know that this is happening.

Viewing Teletext

Analogue teletext

Analogue teletext services

Analogue teletext services are the text information provided by the broadcasters. The features may vary depending on the broadcasters.

What is FASTEXT mode?

In FASTEXT mode, four differently coloured subjects are situated at the bottom of the screen. To access more information about one of these subjects, press the appropriately coloured button. This facility enables fast access to information on the subjects shown.

What is List mode?

In List mode, four differently coloured page numbers are situated at the bottom of the screen. Each of these numbers can be altered and stored in the TV's memory. ("Store frequently viewed pages", p. 23)

■ **To change mode** → "Teletext" in the Setup Menu (p. 33)



1 Select Analogue
TV

2 Switch to Teletext
TEXT
● Displays the index page (content varies depending on the broadcasters)

3 Select the page
1 2 3
4 5 6
7 8 9
0
or
up
OK
down
OR
red green yellow blue
(Corresponds to the colour bar)

Sub page number
Current page number
Time / date
TELETEXT INFORMATION
Colour bar

■ **To adjust contrast** → MENU (Press twice) → OK

■ **To return to TV** → EXIT

As the blue bar is displayed

Reveal hidden data

Reveal hidden words e.g. quiz page answers

MENU → red ● To rehide → red

HOLD

Stop automatic updating

(If you wish to hold the current page without updating)

HOLD ● To resume → HOLD

FULL / TOP / BOTTOM

MENU → green

(TOP)
P100
Broadcast
(Expand the TOP half)

(BOTTOM)
(Expand the BOTTOM half)

Normal (FULL)
P100
Broadcast

INDEX

Return to the main index page



Subtitle

View a favourite page stored



- Factory setting is "P888" (subtitle service) on the blue button (List mode).

View in multi window

Watch TV and Teletext in two windows at once



- Operations can be made only in Teletext screen.
- Each time pressed: Teletext → TV and Teletext



Store frequently viewed pages

Store frequently viewed pages in the colour bar

(List mode only)

As page is displayed



Corresponding coloured button



OK press and hold

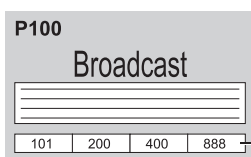

- If you wish to use Subtitles, do not change number on blue button.

The number changes to white.

■ To change stored pages

Enter new page number



Coloured button you want to change



OK press and hold

View sub page

View sub page (Only when teletext is more than one page)



<<01|02|03 04 05— Appears at top of the screen

■ To view specific sub page



blue



Enter the 4-digit number

example: P6

0 0 0 6

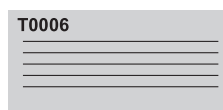

- Sub pages:

The number of sub pages varies depending on the broadcasters (up to 79 pages). It may take some time for searching, during which time you can watch TV.

Watch TV while waiting for update

View the TV picture while searching for a teletext page

Teletext automatically updates itself when new information becomes available.



yellow



Changes to TV screen temporarily

Appears when updating is completed

View the updated page

yellow

- The news page provides a function that indicates arrival of latest news ("News Flash").

Watching External inputs

Connect the external equipment (VCRs, DVD equipment, etc.) and you can watch through the input.

● To connect the equipment → p. 10, 11 and p. 58

The Remote Control is capable of operating some functions of selected external equipment.

1 Turn the TV on

- **When connecting with SCART as example 2 or 3** (p. 10 and p. 11)
 - Receives input signals automatically when playback starts
 - Input signals are automatically identified by the SCART (pin 8) terminal.
 - This function is also available for HDMI connections (p. 58).
- **If input mode is not switched automatically**
 - Perform ② and ③
 - Check the setup of the equipment.

2 Display the Input select menu

AV

3 Select the input mode connected to the equipment

- You can also select the input using the AV button on the remote control or the side panel of the TV. Press the button repeatedly until the desired input is selected.
- In order to switch between AV2/AV3 and AV2S/AV3S, move the indicator by pressing left and right cursor button.
- You can label or skip each input mode → “Input Labels” (p. 43) Skipped inputs will not be displayed when the AV button is pressed.

4 View

Displays the selected mode

■ **To return to TV**

→ TV

Note

- If the external equipment has an aspect adjustment function, set to “16:9”.
- For details, see the manual of the equipment or ask your local dealer.









Screen display

Terminal	AV1	AV2	AV3	COMPONENT	HDMI1	HDMI2
Manual input (default setting in "Input Labels")	AV1 AV1-RGB	AV2 AV2-S-Video AV2-RGB	AV3 AV3-S-Video	COMPONENT	HDMI1	HDMI2
Auto input (EC mode or VIERA Link)	EC/AV1 EC/AV1-RGB	EC/AV2 EC/AV2-S-Video EC/AV2-RGB	—	—	EC/HDMI1 ● Applicable for EC mode and VIERA Link	EC/HDMI2 ● Applicable for VIERA Link

- If the above information is permanently displayed on the top left of the screen, press the **i** button to clear.

Operating the equipment with the TV remote control



The equipment connected to the TV can be directly operated with the below buttons of this TV remote control.

	Standby Set to Standby mode / Turn on
	Play Playback videocassette / DVD
	Stop Stop the operations
	Rewind / Skip / Search VCR: Rewind, view the picture rapidly in reverse DVD: Skip to the previous track or title Press and hold to search backward
	Fast-forward / Skip / Search VCR: Fast-forward, view the picture rapidly forward DVD: Skip to the next track or title Press and hold to search forward
	Pause Pause / Resume DVD: Press and hold to play at slow speed
	Channel Up / Down Select channel
	Record Start recording

■ How to change the code for the type of the equipment

Each type of the Panasonic equipment has its own remote control code.
Please change the code according to the equipment you want to operate.
If you operate the connected equipment in VIERA Link (p. 56), select the code "73".

Press and hold  during the following operations

Enter the appropriate code,  → Press 

Type of the equipment	Code
DVD Recorder, DVD Player	70 (default)
Player theatre, Blu-ray Disc theatre	71
VCR	72
The equipment using in VIERA Link → "VIERA Link Control" (p. 56)	73

Note

- Confirm if the remote control works correctly after changing the code.
- The codes may be reset to default values if batteries are replaced.
- Some operations may not be possible on some equipment models.

How to Use Menu Functions

Various menus allow you to make settings for the picture, sound, and other functions.

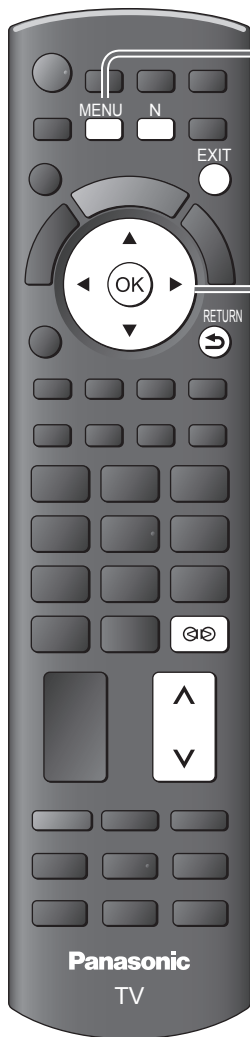

1 Display the menu
MENU ● Displays the functions that can be set (varies according to the input signal)

2 Select the menu
Picture
 Sound
 Setup
 (example: Picture Menu)

② access
 ① select

3 Select the item
Viewing Mode Dynamic
 Contrast
 Brightness
 Colour
 Sharpness
 Tint
 Colour Balance Warm
 Colour Management Off
 Eco Mode Off
 (example: Picture Menu)

select

4 Adjust or select
Viewing Mode Dynamic
Contrast
 Brightness
 Colour
 Sharpness
 Tint
 Colour Balance Warm
 Colour Management Off
 P-NR Off
 (example: Picture Menu)

① change
 ② store or access (Required by some functions)

■ **To return to TV at any time**



■ **To return to the previous screen**



■ **To change menu pages**

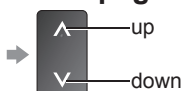

■ **Choose from among alternatives**

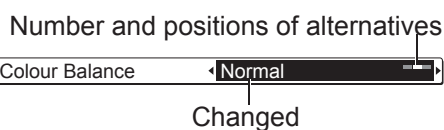

■ **Adjust using the slide bar**



■ **Go to the next screen**

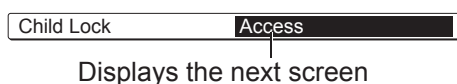

■ **Enter characters by free input menu**

You can enter names or numbers freely for some items.



Set characters one by one

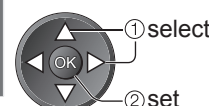

Store



- You can set characters by using numeric buttons.
 ➔ "Characters table for numeric buttons" (p. 63)

■ **To reset the settings**

- To reset the picture settings only
 ➔ "Reset to Defaults" in the Picture Menu (p. 30)
- To reset the sound settings only
 ➔ "Reset to Defaults" in the Sound Menu (p. 31)
- To reset the picture and sound settings together
 ➔ **N** (Also volume level and aspect mode are reset)
- To initialize all settings
 ➔ "Shipping Condition" in the Setup Menu (p. 41)

■ Overview (Picture, Sound)

● How to operate → p. 26

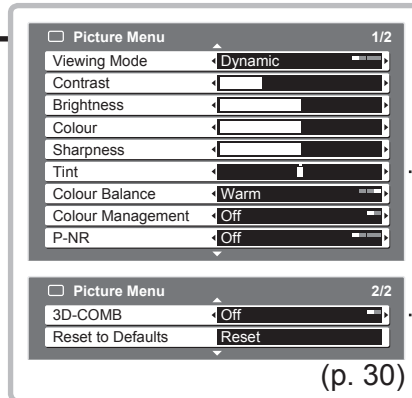
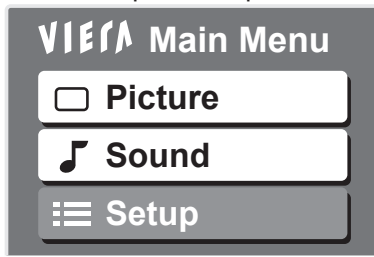

Available in NTSC

Available in NTSC / PAL

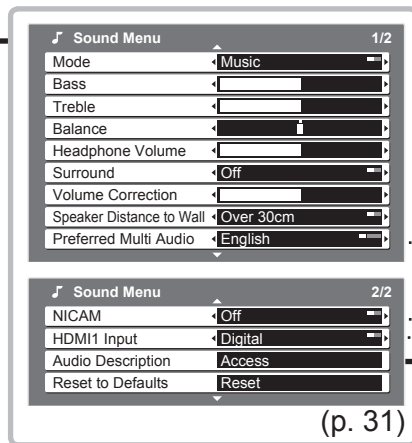

Available in DVB

Available in Analogue

Available in HDMI

Available in DVB

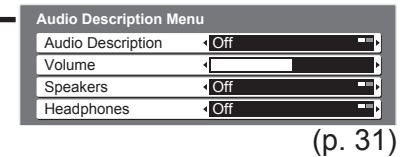

How to Use Menu Functions

Overview (Setup)

How to operate → p. 26

VIERA Main Menu

- Picture
- Sound
- Setup**

Setup Menu

- Timer Programming Access
- Off Timer Off
- Link Settings Access
- Child Lock Access
- DVB Tuning Menu Access
- Analogue Tuning Menu Access
- Display Settings Access
- System Menu Access
- Other Settings Access

(p. 32 and p. 33)

Timer Programming Wed 15/10/08 18:50

No.	Channel Name	Date	Start	End	min.	STTL
0	<TIMER>	17/10 FR	18:00	20:00	120	Off
1	BBC1 Holiday News	18/10 SA	21:30	22:30	60	Off
2	ITV1 Freshly Squeezed Extra	18/10 SA	22:30	23:30	60	Off

(p. 47)

Link Settings

- VIERA Link On
- Q-Link AV2
- AV2 out TV
- Standby Power Save On
- Intelligent Auto Standby On (No reminder)
- Q-Link Download Access

(p. 32)

Child Lock-PIN Entry

Please enter new PIN

PIN * * * *

(p. 40)

Available in DVB

Other Settings

- Guide Plus+ Settings Access
- Power on Preference TV
- Power on Channel List Last
- Power Save Off
- Picture Overscan On

(p. 33)

GUIDE Plus+ Settings Menu

- Postcode Access
- System Information Access

(p. 33)

Enter Postcode

Postcode

A B C D E F G H I J K L M N O P Q R S T
U V W X Y Z 0 1 2 3 4 5 6 7 8 9

(p. 33)

Available in DVB

DVB Tuning Menu

- Favourites Edit Access
- Channel List Access
- Auto Setup Access
- Manual Tuning Access
- Update Channel List Access
- New Channel Message On
- Signal Condition Access

(p. 34 and p. 36)

Available in Analogue

Analogue Tuning Menu

- Channel List Access
- Auto Setup Access
- Manual Tuning Access

(p. 35 and p. 38)

Display Settings

- Teletext FASTEXT
- Preferred Subtitles English
- Side Panel Off
- Input Labels Access
- Banner Display Timeout 3 seconds
- Playing Time Display On

(p. 33)

Available in Analogue

Available in DVB

Input Labels

- AV1 DVD
- AV2/S AV2/S
- AV3/S AV3/S
- COMPONENT COMPONENT
- HDMI1 HDMI1
- HDMI2 HDMI2
- DVB DVB
- Analogue Analogue

(p. 43)

System Menu

- Shipping Condition Access
- Owner ID Access
- Common Interface Access
- System Update Access
- Software Licence Access
- System Information Access

(p. 33)

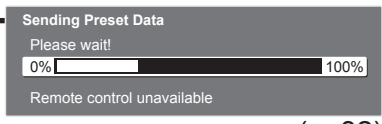

(p. 32)

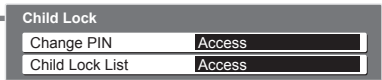

(p. 40)

Child Lock List - TV and AV

Name	Input	Type	Lock
4 BBC ONE Wales	DVB	Free TV	🔒
7 BBC THREE	DVB	Free TV	
14 E4	DVB	Free TV	
VCR	Analogue	Analogue	
1 BBC1	Analogue	Analogue	
2 *****	Analogue	Analogue	🔒
AV1	External	AV	
AV2/S	External	AV	

(p. 40)

DVB Favourites Editor

All DVB Channels	Favourites1
1 BBC ONE Wales	
7 BBC THREE	
14 E4	
70 CBBC Channel	
72 Cartoon Nwk	
105 BBCi	
719 BBC Radio Wales	
720 BBC Radio Cymru	

(p. 37)

DVB Channel List

70 CBBC Channel	🔍
72 Cartoon Nwk	🔍
105 BBCi	
719 BBC Radio Wales	
720 BBC Radio Cymru	
1 BBC ONE Wales	
7 BBC THREE	🔍

(p. 37)

DVB Auto Setup

Progress: CH 21 68

This will take about 3 minutes.

CH	Channel Name	Type	Quality
62	CBBC Channel	Free TV	10
62	BBC Radio Wales	Free TV	10
62	E4	Free TV	10
62	Cartoon Nwk	Free TV	10

Free TV: 4 Pay TV: 0 Radio: 0 Data: 0
Searching

(p. 34)

DVB Manual Tuning

Frequency: CH(21) 424 MHz

Signal Quality: 0 10

Signal Strength: 0 10

No.	Channel Name	Type	New

Free TV: 0 Pay TV: 0 Radio: 0 Data: 0
Stopped

(p. 37)

DVB Update Channel List

Progress: CH 21 68

This will take about 3 minutes.

CH	Channel Name	Type	Quality

Free TV: 0 Pay TV: 0 Radio: 0 Data: 0
Searching

(p. 36)

DVB Signal Condition

Channel Name: 1 BBC ONE Wales

Signal Quality: 0 10

Signal Strength: 0 10

Network Name: Wenvoe

Parameter: [CH62] 802 MHz

(p. 36)

Analogue Channel List

1 BBC1	🔍
2 *****	
3 *****	
4	
5	
6	
7	

(p. 39)

Analogue Manual Tuning

1 BBC1 CH33

Manual Tuning 21 68

(p. 39)

Analogue Auto Setup

Scan: CH 21 68

This will take about 3 minutes.

CH	Channel Name
29	
30	

Analogue: 2 Searching

(p. 35)

Shipping Condition

All tuning data will be erased
Are you sure?
Are you sure?

(p. 41)

Owner ID

Please enter PIN for access

PIN: * * * *

(p. 42)

Available in DVB

Common Interface

Slot 1: Module inserted

(p. 45)

System Update

Auto Update Search in Standby: On

System Update Search Now: Access

(p. 45)

How to Use Menu Functions

■ Menu list

Menu	Item	Adjustments / Configurations (alternatives)
Picture	Viewing Mode	<p>Selects four different screen settings (Dynamic / Normal / Cinema / Game) In each Viewing Mode setting, Contrast, Brightness, Colour, Sharpness, Tint, Colour Balance, Colour Management, Eco Mode and 3D-COMB can be adjusted and stored to suit your particular viewing requirement (e.g., you may require different settings for viewing sports, films, news etc.)</p> <ul style="list-style-type: none"> ● Set for each input signal ● Changes will be stored automatically <p>Dynamic : Provides enhanced picture contrast and sharpness when viewing in a bright room Normal : Recommended for viewing under normal ambient room lighting conditions Cinema : For watching movies in a darkened room producing a cinema-like picture Game : Fast response signal specifically to provide suitable images for playing games</p> <ul style="list-style-type: none"> ● Not valid on TV mode ● A continuous record of time spent using Game mode can be displayed in the top right of the screen. <ul style="list-style-type: none"> ➔ "Playing Time Display" (p. 33)
	Contrast, Brightness, Colour, Sharpness	Increases or decreases the levels of these options according to your personal preference
	Tint	<p>With an NTSC signal source connected to the TV, the picture hue can be adjusted to suit your taste</p> <ul style="list-style-type: none"> ● For NTSC signal reception only
	Colour Balance	Allows you to set the overall colour tone of the picture (Cool / Normal / Warm)
	Colour Management	Automatically adjusts colours to vivid ones (Off / On)
	P-NR	<p>Picture Noise Reduction Automatically reduces unwanted picture noise and flicker noise in the contoured parts of a picture (Off / Min / Mid / Max)</p>
	3D-COMB	<p>Occasionally, whilst viewing still or slow moving pictures, colour patterning may be seen Set to "On" to display sharper and more accurate colours (Off / On)</p> <ul style="list-style-type: none"> ● For PAL or NTSC signal reception only ● Not valid on RGB, S-Video, Component, HDMI and SD Card
	Reset to Defaults	Press the OK button to reset the present Picture Viewing Mode to the default settings

■ Menu list

Menu	Item	Adjustments / Configurations (alternatives)
Sound	Mode	Select two different sound settings (Music / Speech) In each Sound Mode setting, Bass and Treble can be adjusted and stored to suit your particular sound requirement ● Changes to any settings in a mode will affect all signal sources ● Sound quality can be improved
	Bass	Increases or decreases level to enhance or minimise lower, deeper sound output
	Treble	Increases or decreases level to enhance or minimise sharper, higher sound output
	Balance	Adjusts volume level of right and left speakers
	Headphone Volume	Adjusts the volume of the headphones
	Surround	Surround sound settings (Off / V-Audio) Provides a dynamic enhancer of width to simulate improved spatial effects ● Switching is also possible by the Surround button on the remote control (p. 9).
	Volume Correction	Adjusts the volume of individual channel or input mode
	Speaker Distance to Wall	Adjusts the low frequency sound (Over 30cm / Up to 30cm) ● If the back space between the TV and wall is over 30 cm, "Over 30cm" is recommended. ● If the back space between the TV and wall is within 30 cm, "Up to 30cm" is recommended.
	Preferred Multi Audio	Selects the preferred language for DVB channel multi audio (depending on the broadcaster)
	NICAM	NICAM (Near Instantaneous Companded Audio Multiplex) A format for digital sound over television Reproduces stereo sound (Off / On) ● Off if reception is poor (FM monaural sound) ● Analogue mode only
HDMI1 Input	Select to fit the input signal (Digital / Analogue) (p. 61) Digital : HDMI cable connection Analogue : HDMI-DVI adapter cable connection ● HDMI input mode only ● HDMI2 terminal is for digital signal only ● No setting for HDMI2 available	
Audio Description Menu	Audio Description	Useful for visually-impaired viewers (Off / Auto) Set to "Auto" to activate the description sound track if available ● The availability of audio description sound track is indicated by "AD" in the information banner (p. 16). ● DVB mode only
	Volume	Adjusts the volume for Audio Description ● DVB mode only
	Speakers	Set to "On" to activate the description sound track from TV speakers (Off / On) ● DVB mode only
	Headphones	Set to "On" to activate the description sound track from headphones (Off / On) ● DVB mode only
Reset to Defaults		Press the OK button to reset the present Sound Mode to the default settings ● Effective to Bass, Treble, Balance, Headphone Volume and Surround

- A different menu will be displayed while SD Card is used. (p. 48 and p. 49)
- Only available items can be selected.

How to Use Menu Functions

■ Menu list

Menu	Item	Adjustments / Configurations (alternatives)	
Setup	Timer Programming	Records forthcoming channels (p. 47)	
	Off Timer	Sets the time the TV automatically turns Off (Off / 15 / 30 / 45 / 60 / 75 / 90 minutes)	
	Link Settings	VIERA Link	Sets to use VIERA Link functions (Off / On) (p. 53)
		Q-Link	Selects which AV terminal is to be used for data communication between this TV and a compatible recorder (AV1 / AV2) (p. 52) ● Select the connected terminal to the recorder even it is not compatible with Q-Link.
		AV1 / AV2 out	Chooses the signal to be transmitted from the TV to Q-Link (TV / AV1 / AV2 / AV3 / Monitor) ● Monitor: Image displayed on screen ● Component and HDMI signals cannot be outputted.
		Standby Power Save	Controls the power consumption in Standby mode of the connected equipment to reduce the consumption (Off / On) (p. 54) ● This function is available when "VIERA Link" is set to "On".
		Intelligent Auto Standby	Makes non-watched or non-used connected equipment go into Standby mode to reduce the power consumption (Off / On (With reminder) / On (No reminder)) (p. 54) ● This function is available when "VIERA Link" is set to "On".
		Q-Link Download	Downloads analogue channel information to a Q-Link compatible equipment connected to the TV
	Child Lock	Locks a channel / AV input to prevent access to it (p. 40)	
	DVB Tuning Menu	Favourites Edit	Creates list of favourite DVB channels (p. 37)
		Channel List	Skips the unwanted DVB channels or edits DVB channels (p. 37)
		Auto Setup	Automatically sets the DVB channels received in the area (p. 34)
		Manual Tuning	Sets the DVB channels manually (p. 37)
		Update Channel List	Updates DVB Channel List with keeping your settings (p. 36)
		New Channel Message	Selects whether to give a notification message when a new DVB channel is found (p. 36)
		Signal Condition	Checks the DVB signal condition (p. 36)
	Analogue Tuning Menu	Channel List	Skips the unwanted Analogue channels or edits Analogue channels (p. 39)
		Auto Setup	Automatically sets the Analogue channels received in the area (p. 35)
		Manual Tuning	Sets the Analogue channels manually (p. 39)

■ Menu list

Menu	Item	Adjustments / Configurations (alternatives)	
Display Settings	Teletext	Analogue teletext display mode (FASTEXT / List) (p. 22)	
	Preferred Subtitles	Selects the preferred language for digital channel subtitles (depending on the broadcaster) ● To display subtitles → p. 16	
	Side Panel	Increases the brightness of the side panel (Off / Low / Mid / High) ● The recommended setting is “High” to prevent panel “image retention”.	
	Input Labels	Labels or skips each input terminal (p. 43)	
	Banner Display Timeout	Sets how long the Information banner (p. 16) stays on screen (0 (No display) / 1 / 2 / 3 / 4 / 5 / 6 / 7 / 8 / 9 / 10 seconds)	
	Playing Time Display	Set to “On” to display a continuous record of time spent using Game mode (Off / On) ● This function is available when “Game” is selected in “Viewing Mode” (p. 30).	
System Menu	Shipping Condition	Resets all settings, for example, when moving house (p. 41)	
	Owner ID	Inputs the owner ID (p. 42)	
	Common Interface	Uses include to watch pay-TV (p. 45)	
	System Update	Downloads new software to TV (p. 45)	
	Software Licence	Displays the software licence information	
	System Information	Displays the system information of this TV	
Other Settings	GUIDE Plus+ Settings	Postcode	Sets your postcode to display advertisements in the GUIDE Plus+ system (p. 19)
		System Information	Displays the system information of the GUIDE Plus+ system
	Power on Preference	Automatically selects the input when the TV is turned on (TV / AV) Set to “TV” to view picture from TV tuner. Set to “AV” to view input from an external equipment connected to a SCART terminal, e.g. satellite receiver. ● The external equipment must be switched on and sending a control signal for automatic switching at power on to occur.	
	Power on Channel List	Automatically selects All Channels or Favourites list in the Information banner (p. 16) when the TV is turned on (All Channel List / Last) Set to “All Channel List” to display all the channels. Set to “Last” to display the one you selected last time.	
	Power Save	Reduces brightness of picture to economise on power consumption (Off / On)	
	Picture Overscan	Selects the screen area displaying the image (Off / On) On : Enlarged the image to hide the edge of the image. Off : Displayed the image in the original size. ● Set to “On” if noise is generated on the edge of the screen. ● This function is available when aspect is set to Auto (16:9 signal only) or 16:9. ● This function can be memorized separately for SD (Standard definition) and HD (High definition) signals.	

- A different menu will be displayed while SD Card is used. (p. 48 and p. 49)
- Only available items can be selected.
- If “Demo Settings” item is displayed in the Setup Menu, the TV is in “Shop” viewing environment. To return to “Home” viewing environment initialise all settings by accessing Shipping Condition.
→ “Shipping Condition” (p. 41)

Retuning from Setup Menu

Auto Setup retunes all channels automatically.

DVB channels

Automatically retune all DVB channels received in the area.

- Only DVB channels are retuned in DVB mode.
- All the previous tuning settings are erased.
- If a Child Lock PIN number (p. 40) has been set, it must be entered.

1 Select DVB
TV

2 Display the menu
MENU

3 Select "Setup"

4 Select "DVB Tuning Menu"

5 Select "Auto Setup"

6 Start Auto Setup

For Auto Setup, using the buttons on the side panel of the TV (p. 8)

- ① Press repeatedly until "Auto Setup" appears
F
- ② Access "Auto Setup"
TV
- ③ Start "Auto Setup"
TV

● To return to TV → F

DVB Auto Setup
 All DVB tuning data will be erased OK

DVB Auto Setup
 Progress CH 21 68
 This will take about 3 minutes.

Ch1	Channel Name	Type	Quality
62	CBBC Channel	Free TV	10
62	BBC Radio Wales	Free TV	10
62	E4	Free TV	10
62	Cartoon Nwk	Free TV	10

Free TV: 4 Pay TV: 0 Radio: 0 Data: 0
Searching

Settings are made automatically

When the operation is completed, the channel at channel position "1" will be displayed.

Note

- If tuning has not been done completely → "Manual Tuning" (p. 37)

Analogue channels

Automatically retune all Analogue channels received in the area.

- Only Analogue channels are retuned in Analogue mode.
- All the previous tuning settings are erased.
- If a Child Lock PIN number (p. 40) has been set, it must be entered.

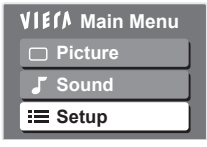
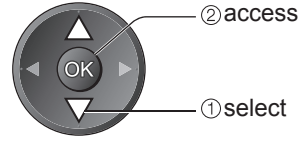
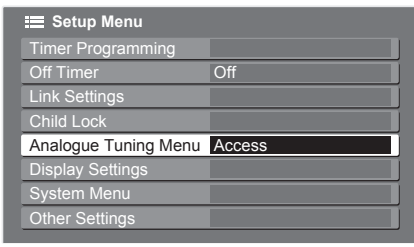
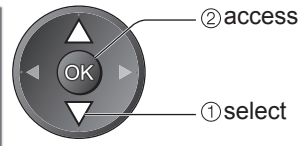
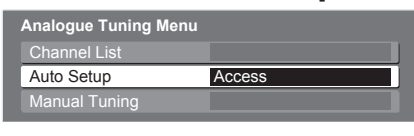
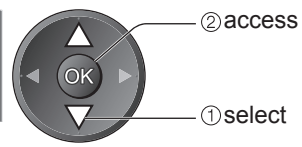
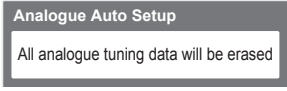
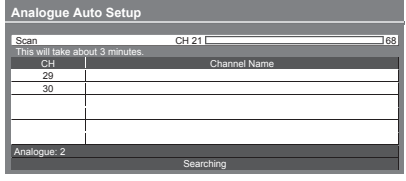

- 1 Select Analogue**
TV
- 2 Display the menu**
MENU
- 3 Select "Setup"**

- 4 Select "Analogue Tuning Menu"**

- 5 Select "Auto Setup"**

- 6 Start Auto Setup**

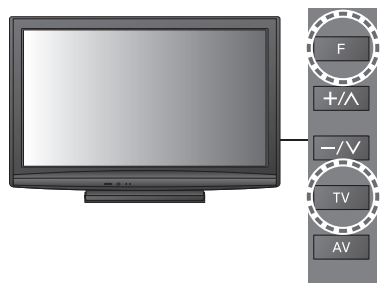

Settings are made automatically

■ To return to TV
EXIT
→

■ For Auto Setup, using the buttons on the side panel of the TV (p. 8)

- ① Press repeatedly until "Auto Setup" appears
F
- ② Access "Auto Setup"
TV
- ③ Start "Auto Setup"
TV



● To return to TV → F

● The analogue settings are downloaded to a Q-Link compatible equipment connected to the TV in Analogue mode.

When the operation is completed, the channel at channel position "1" will be displayed.

Note

- If tuning has not been done completely
→ "Manual Tuning" (p. 39)

Tuning and Editing Channels

(DVB)

You can retune channels or make your favourite channel lists, skip unwanted channels, etc.



1 Select DVB



2 Display the menu



3 Select "Setup"

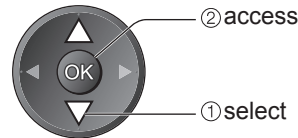
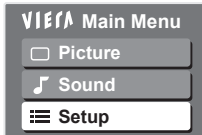

4 Select "DVB Tuning Menu"

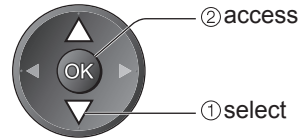
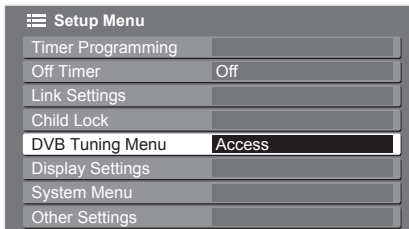

5 Select one of the following functions

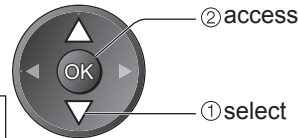
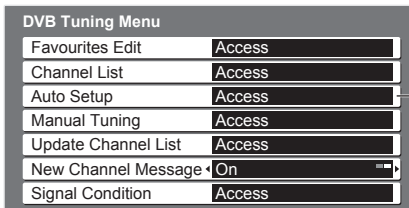

→ "Retuning from Setup Menu" (p. 34)

■ To return to TV



6 Set

Update DVB channel automatically **Update Channel List**

You can add new channels, delete removed channels, update channel name and position automatically to Channel List.



- Channel List is updated with keeping your settings in Favourites Edit, Channel List, Child Lock, Timer Programming, etc.

Display a notification message **New Channel Message**

Selects whether to give a notification message when a new DVB channel is found. (Off / On)



- Selecting OK will perform "Update Channel List".

Check DVB signal **Signal Condition**

Selects a channel and checks the DVB signal condition.

- To change the channel →

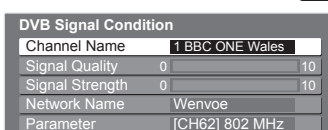

A good Signal Strength is not an indication of suitable signal for DVB reception. Please use the Signal Quality indicator as follows:

Signal Quality:

- Green bar → Good
- Yellow bar → Poor
- Red bar → Bad (Check the Terrestrial aerial)

List favourite DVB channels **Favourites Edit**

Create your favourite channel lists from various broadcasters (up to 4: Favourites1 to 4). The DVB Favourites lists are available for switching in the Information banner (p. 16) and from "Category" in the TV Guide (p. 18).

① Select a channel to list

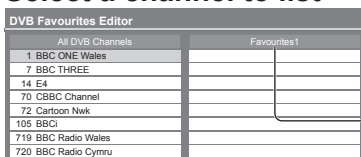

To display other Favourites → green

② Add it to the Favourites list

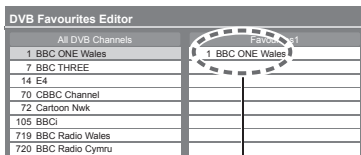

To add all channels to the list → yellow

A channel is added

Note

Channel position numbers (known as logical channel numbers) can be swapped in Channel List.

To edit Favourites list



Select the field of Favourites to edit and:

To delete the channel → OK

To delete all channels → yellow

To name the Favourites → red

Set characters one by one



Store RETURN

You can set characters by using numeric buttons.
→ "Characters table for numeric buttons" (p. 63)

To move the channel → green

Select the new position → Confirm

green

③ Store



Skip unwanted DVB channels, Edit DVB Channels **Channel List**

You can hide unwanted DVB channels. The hidden channels cannot be displayed except in this function. Use this function to skip unwanted channels.

Select a channel and reveal / hide

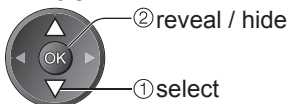

: reveal
 : hide (skip)

To reveal all channels → yellow

To edit channels

You can also edit each channel in Channel List.



Select a channel to edit and:

To retune each channel (Manual Tuning) → red (see below)

To swap the channel position → green

Enter the new position number



Store green

Channel position

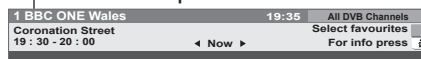

Set DVB channel manually **Manual Tuning**

Normally use "Auto Setup" or "Update Channel List" to retune DVB channels. If tuning has not been done completely or for adjusting the direction of the aerial, use this function.

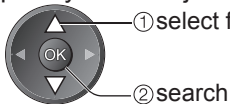
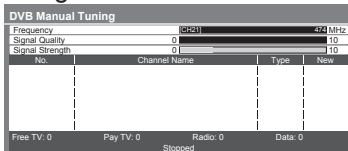

All channels found will be added to the Channel List.

Tuning and Editing Channels

(Analogue)

You can retune channels or skip unwanted channels, edit channels etc.



1 Select Analogue
TV

2 Display the menu
MENU

3 Select "Setup"
Main Menu
Picture
Sound
Setup

4 Select "Analogue Tuning Menu"
Setup Menu
Timer Programming
Off Timer Off
Link Settings
Child Lock
Analogue Tuning Menu Access
Display Settings
System Menu
Other Settings

5 Select one of the following functions
Analogue Tuning Menu
Channel List Access
Auto Setup Access
Manual Tuning Access

■ To return to TV
EXIT

➔ "Retuning from Setup Menu" (p. 35)

6 Set

② access
① select

② access
① select

② access
① select

Skip unwanted Analogue channels, Edit Analogue channels Channel List

You can hide unwanted Analogue channels.
The hidden channels cannot be displayed except in this function. Use this function to skip unwanted channels.

Select a channel and reveal / hide

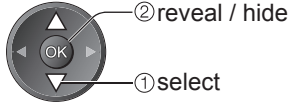
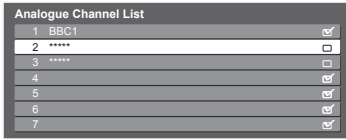

: reveal
 : hide (skip)

● To reveal all channels
→ yellow

To edit channels

You can also edit each channel in Channel List.



Select a channel to edit and:

● To retune each channel (Manual Tuning) → red (see below)

● To move the channel position → green → Select the new position → green

● To rename the channel name → blue → Set characters one by one

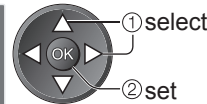
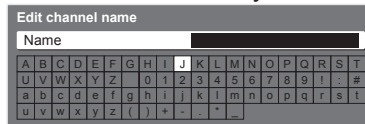

Store
RETURN

(maximum: five characters)

- You can set characters by using numeric buttons.
→ "Characters table for numeric buttons" (p. 63)

Note

- If a VCR is connected only with the RF cable, edit "VCR".

Set Analogue channel manually Manual Tuning

Set Analogue channel manually after Auto Setup.

- If a VCR is connected only with the RF cable, select channel position "0".



Select the channel position



Select the channel



Search and store

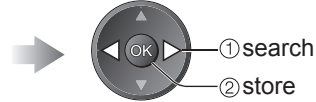

Child Lock

You can lock specific channels / AV input terminals and control who watches them. When the locked channel / input is selected, a message appears; by entering the PIN number, you can watch it.

1 Display the menu
MENU

2 Select "Setup"

 ② access
① select

3 Select "Child Lock"

 ② access
① select

4 Set
EXIT

Control channel audience **Child Lock**

① Enter the PIN number (4 digits)

Child Lock-PIN Entry
Please enter new PIN
PIN

- Enter the PIN number twice at first setting.
- Make a note of the PIN number in case you forget it.

② Select "Child Lock List"

Child Lock
Change PIN
Child Lock List

② access
① select

③ Select the channel / input to be locked

Name	Input	Type	Lock
4 BBC ONE Wales	DVB	Free TV	🔒
7 BBC THREE	DVB	Free TV	🔒
14 E4	DVB	Free TV	🔒
VCR	Analogue	Analogue	🔒
1 BBC1	Analogue	Analogue	🔒
2 ****	Analogue	Analogue	🔒
AV1	External	AV	🔒
AV2/S	External	AV	🔒

② lock
① select

Appears when the channel / input is locked

- To cancel → Select the locked channel / input → OK
- To jump to the top of the next input → red
- To lock all → green
- To cancel all locks → yellow

■ To change the PIN number Select "Change PIN"

Child Lock
Change PIN
Child Lock List

② access
① select

Enter a new PIN number twice



Note

- Setting "Shipping Condition" (p. 41) erases the PIN number and all settings.

Shipping Condition

Resets the TV to its original condition, i.e. no channels tuned in.
All settings other than "Owner ID" are reset (channels, picture, sound settings, etc.).

- 1 Display the menu**
MENU
- 2 Select "Setup"**
Main Menu
Picture
Sound
Setup
- 3 Select "System Menu"**
Setup Menu
Timer Programming
Off Timer Off
Link Settings
Child Lock
DVB Tuning Menu
Display Settings
System Menu Access
Other Settings
- 4 Select "Shipping Condition"**
System Menu
Shipping Condition Access
Owner ID
Common Interface
System Update
Software Licence
System Information
- 5 Set**

■ To return to TV



Restore Settings Shipping Condition

① Check the message and initialise

Shipping Condition

All tuning data will be erased
Are you sure?
Are you sure?

Confirm

EXIT
RETURN

(confirm)
 (confirm)
 (start Shipping Condition)

② Follow the on-screen instructions

**Reset to Factory Shipping Condition
Completed.**

Please switch off TV.

● "Auto Setup" will automatically start when Mains power On / Off switch is next turned On. (p. 12)

■ **To retune TV channels only, e.g. after moving house**
 ➔ "Retuning from Setup Menu" (p. 34 and p. 35)

Owner ID

Entry of the PIN number and personal information (your name, address and postcode). In the unfortunate event of theft it will help the Police to determine the owner.



1 Display the menu



2 Select "Setup"

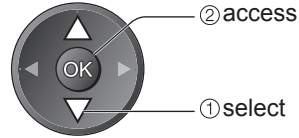

3 Select "System Menu"

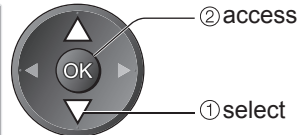
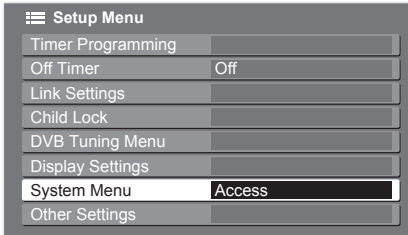

4 Select "Owner ID"

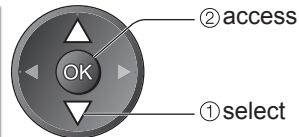
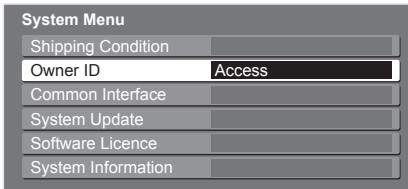

■ To return to TV



5 Set

Input owner ID

1 Enter the PIN number (4 digits)



- Enter the PIN number twice at first setting.
- Make a note of the PIN number in case you forget it.

2 Enter your name, address, and postcode, in that order

Select NAME / HOUSE NO / POSTCODE



Set characters one by one

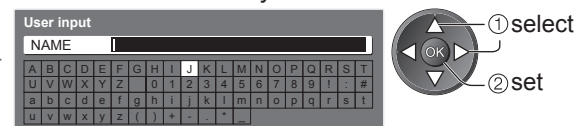

- You can set characters by using numeric buttons.
- ➔ "Characters table for numeric buttons" (p. 63)

Return to select other items or Exit the menu

■ To check the personal information stored

Hold down for about 6 sec.

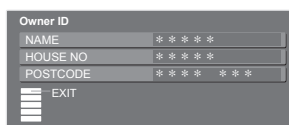

- The PIN number is not displayed.

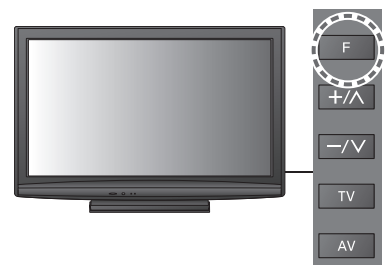

■ To change the PIN number

Select "PIN"



Enter a new PIN number twice



Input Labels

For easier identification and selection of the input mode, you can label each input mode or skip terminal that is not connected to any equipment.

- To select the input mode → p. 24



1 Display the menu

MENU

2 Select "Setup"

VIEW Main Menu

- Picture
- Sound
- Setup

② access

① select

3 Select "Display Settings"

Setup Menu

- Timer Programming
- Off Timer Off
- Link Settings
- Child Lock
- DVB Tuning Menu
- Display Settings Access
- System Menu
- Other Settings

② access

① select

4 Select "Input Labels"

Display Settings

- Preferred Subtitles English
- Side Panel Off
- Input Labels Access
- Banner Display Timeout 3 seconds
- Playing Time Display On

② access

① select

■ To return to TV

EXIT

5 Select a input terminal and set

Input Labels

- AV1 DVD
- AV2/S AV2/S
- AV3/S AV3/S
- COMPONENT COMPONENT
- HDMI1 HDMI1
- HDMI2 HDMI2
- DVB DVB
- Analogue Analogue

② set

① select

The labels you set will be displayed in "Input Selection" menu (p. 24) or banner.

- If "Skip" is selected, you cannot select the mode.

■ User input

You can name each input mode freely.

Select "User input"

Set characters one by one

① select

② access

User input

Name

A	B	C	D	E	F	G	H	I	J	K	L	M	N	O	P	Q	R	S	T
U	V	W	X	Y	Z	0	1	2	3	4	5	6	7	8	9	.	#		
a	b	c	d	e	f	g	h	i	j	k	l	m	n	o	p	q	r	s	t
u	v	w	x	y	z	()	+ -	* /											

① select

② set

Store

RETURN

(maximum: ten characters)

- You can set characters by using numeric buttons.
- ➔ "Characters table for numeric buttons" (p. 63)

Advanced Settings (DVB)

Advanced Settings provide various DVB features.



1 Select DVB
TV

2 Display the menu
MENU

3 Select "Setup"
Main Menu
Picture
Sound
Setup

4 Select "System Menu"
Setup Menu
Timer Programming
Off Timer Off
Link Settings
Child Lock
DVB Tuning Menu
Display Settings
System Menu Access
Other Settings

5 Select one of the following functions
System Menu
Shipping Condition
Owner ID
Common Interface Access
System Update Access
Software Licence
System Information

6 Set

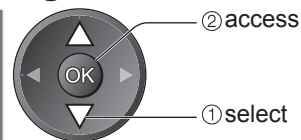
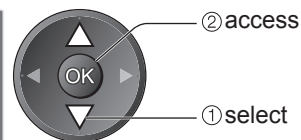
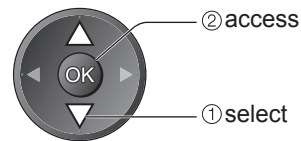

■ To return to TV
EXIT

Pay-TV Common Interface

The Common Interface Module menu provides access to software contained on Common Interface (CI) Modules.

This TV receiver works only Pay TV modules complying with CI standard.

- This function is not available for BSkyB's Sky channels.

Caution

- Turn Off Mains power On / Off switch whenever inserting or removing the CI module.
- If a view card and a card reader come as a set, first insert the card reader, then insert the view card into the card reader.
- Insert the module in the correct direction.

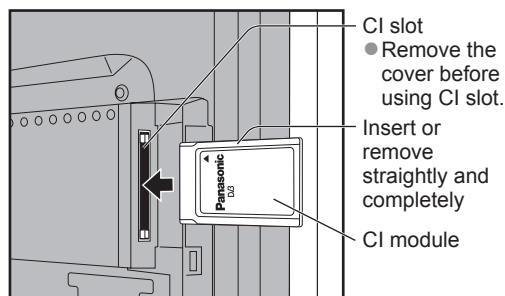

Side of the TV

① Insert the CI module (optional)

- The features that appear on screen are dependent on the contents of the selected CI module.
- Normally pay-TV channels will appear without ② and ③. If pay-TV channel does not appear, perform ② and ③.
- For more details, see the manual of the CI module, or check with the broadcaster.

② Access "Common Interface"



③ Follow the on screen operation guide

- For example: select, go → On-screen operation guide may not correspond to the remote control buttons.
- Coloured characters →

Update TV's software system System Update

Download new software to TV.

- For details → p. 60

If System Update is performed, the software will be updated (it may change TV functions). If you do not wish to do so, set "Auto Update Search in Standby" to "Off".

Select "Auto Update Search in Standby" and then set "On" or "Off"

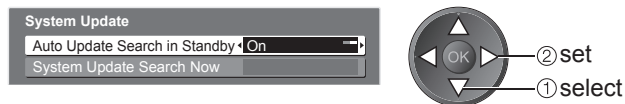

- On: Automatically performs a search in standby and downloads an update, if any software updates are available

■ To update immediately

Select "System Update Search Now"

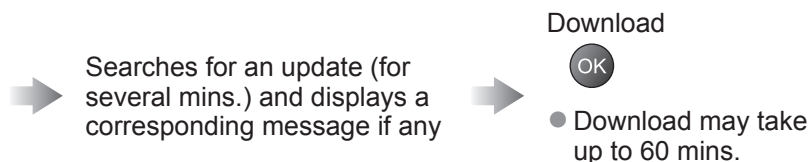
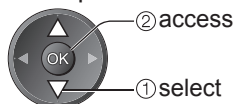

Recording Controls

Timer Programming from Menu

The Timer programming menu allows you to choose programmes that you wish to record. At the correct time, the TV will switch on and tune to the correct channel (even if the TV is in Standby mode).

TV Guide may also be used to set timer programming. (p. 19)

- If the recorder is compatible with Q-Link or similar technologies (p. 52), and setup / connection are done completely (p. 50 and p. 52), you do not need to programme the recorder – the TV will control the recording progress.
- If the recorder is not compatible with Q-Link or similar technologies, set “Q-Link” in the Setup Menu (p. 32) to the connected terminal (AV1 or AV2), and make timer programming of the recorder (Read the manual of the recorder).
- Recording is possible in composite video via SCART only - including HD content.
- While recording, you cannot watch any other channels except the one being recorded.

- 1 Select the mode you want to set a recording**
TV
- 2 Display the menu**
MENU
- 3 Select “Setup”**

VIEW Main Menu
Picture
Sound
Setup
- 4 Select “Timer Programming”**

Setup Menu
Timer Programming Access
Off Timer Off
Link Settings
Child Lock
DVB Tuning Menu
Display Settings
System Menu
Other Settings
- 5 Set**

■ To return to TV
 EXIT →

■ To stop recording
 GUIDE → EXIT

Caution

- The TV must either be On or in standby.
- For preparations of a recorder, read the manual of the recorder.
- No other channel can be selected during recording.
- It may not be possible to record an encrypted programme (which is copy-protected).

Set timer programming details Timer Programming

① Start making the settings



② Repeat the operations as below, and set items in the order of ① to ⑤

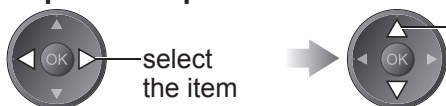

● ①, ③ and ④ can also be entered with numeric buttons.



D: DVB
A: Analogue
(you cannot change TV mode within the menu)

Timer recording
Records according to the time setting
Guide: Guide link recording
Records according to the TV Guide signal (p. 20)
S/P: Split Programme (p. 20)

Displayed if the timer programming events are overlapped

Timer Programming		Wed 15/10/08 18:50				
No.	Channel Name	Date	Start	End	min.	STTL
D 7	BBC THREE <TIMER>	17/10 FR	17:00	18:30	90	Off
D 1	BBC1 Holiday News	18/10 FR	18:00	20:00	120	Off
D 3	ITV1 Freshly Squeezed Extra	18/10 SA	21:30	22:30	60	Off

⑤ Subtitles (Off / Auto)

● Recording time (automatic display)

Current timer programming event

① Channel name

④ Ending time

② Date

③ Starting time

one day ahead

● Daily SU-SA: Sunday to Saturday

● Daily MO-SA: Monday to Saturday

● Daily MO-FR: Monday to Friday

● Weekly SA/FR/TH/WE/TU/MO/SU:
Same time on the same day every week

daily or weekly
(press repeatedly)

③ Store



■ To change a timer programming event

➔ Select the programme to be changed

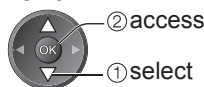

➔ Correct as necessary (as above)

■ To cancel a timer programming event

➔ Select the programme to be deleted



■ To cancel a timer programming event temporarily

➔ Select the programme to be cancelled



● Each time pressed:
cancel ↔ stop cancelling

■ To view details of the programming

➔ Select the programme to be viewed



● Press again to return to Timer Programming menu.

■ Guide link recording (Timer Programming from the TV Guide signal) ➔ p. 20

● Not available in Analogue. mode.

Guide link recording is a timer programme controlled by information from the TV Guide.

Programme start and end times may be changed by broadcasters and sent to the TV for timer programme to follow the change.

Split Programme is a programme which is interrupted by one or more programmes.

Both of the above are subject to signals being sent by broadcasters.

■ Direct TV Recording ➔ p. 52 and p. 54

You can record the current programme to DVD Recorder / VCR immediately using Q-Link or VIERA Link.

Note

- Check that the Timer LED (Orange) is lit. If not, timer programmes are not active or not stored.
- "!" will identify any timer programming events that have been set and overlap. If this occurs then the first timer programming event will start and finish as programmed. The next timer programming event can then start.
- 2 mins. before the starting time, a reminder message appears.

(To remove the message ➔ OK; To cancel the programming ➔ EXIT)

- A Timer Programming event will automatically change to the desired channel 10 seconds before the start time.
- To stop Timer Programming event directly prior to the start time, it is necessary to stop the recorder manually.
- Timer Programming will be performed even if the TV is in Pause Live TV recording (p. 55). In this case, Pause Live TV recording will be cancelled.

Viewing from SD Card

(VIERA IMAGE VIEWER)

Still images recorded by digital cameras will be displayed.

- During the operation, sound signal is output from AV1, AV2 and AUDIO OUT terminals. But no video signals are output.
- "Date" shows the date on which the recording was made by the digital camera or digital video camera. The file without record of the date is shown "***/**/*****".
- For details on SD Cards → p. 62

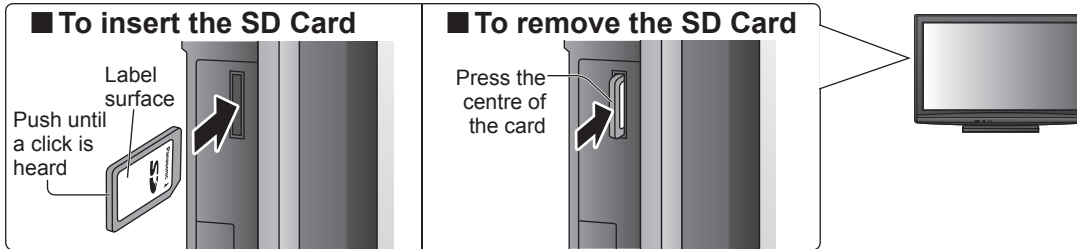

1

Insert the SD Card

Signal output from all AV terminals will be disabled during SD card view.
Press OK to proceed.
Press EXIT to return to TV viewing.

- Warning message for output signal is displayed.

2

Select "Photo View"



- You can also start slideshow directly by using VIERA TOOLS → "How to Use VIERA TOOLS" (p. 14)

3

Select the folder to display the thumbnail

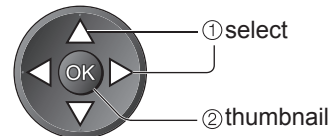
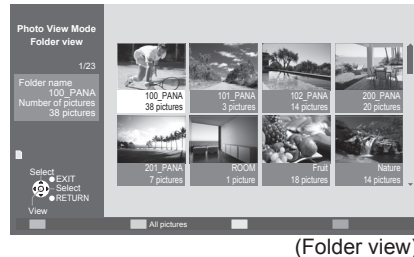

- The files which are not into a folder will be collected to the folder named "I".

4

Select the file from the thumbnail to be viewed

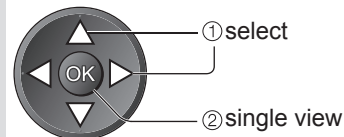
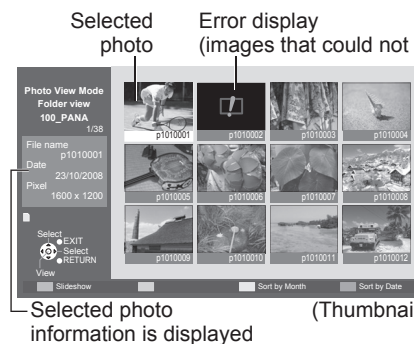

- Slideshow → p. 49

To return to TV



To return to the previous screen

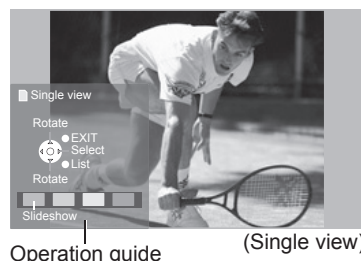

Displayed one at a time

- To display / hide the operation guide

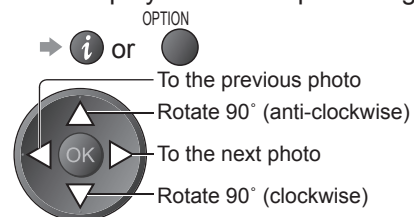

- To return to thumbnail → RETURN

Slideshow

Start Slideshow (operate in step 4)

Select the photo for the first view

Start Slideshow



red



To pause →

To return to single view → green

Note

- Slideshow is done within the thumbnail.
- You can also start slideshow directly by using VIERA TOOLS → “How to Use VIERA TOOLS” (p. 14)

Slideshow settings (operate in Photo View Mode)

Display the menu



Select “Viewing Setup”

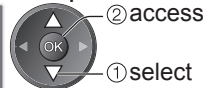
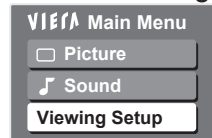

② access

① select

Select the items and set

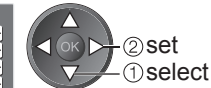
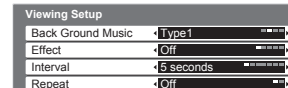

② set

① select

• Other Items → p. 30 and p. 31

Menu	Item	Adjustments / Configurations (alternatives)
Viewing Setup	Back Ground Music	Selects the back ground music during the slideshow (Off / Type1 / Type2 / Type3)
	Interval	Selects slideshow interval (5 / 10 / 15 / 30 / 60 / 90 / 120 seconds)
	Repeat	Slideshow repeat (Off / On)

To display all the photos

Display the thumbnail of all the photos in SD Card.

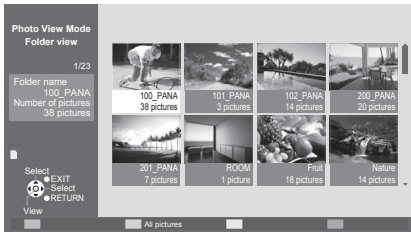

(Folder view)

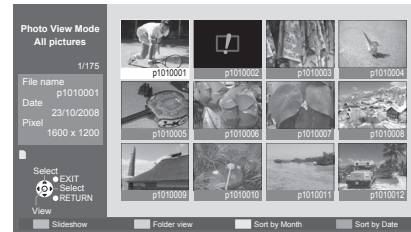

(Thumbnail - All pictures)



① select

② single view

To sort by date or month recorded

Display the list of groups sorted by the same date or the same month.

- The group of the photos without record of the date is shown as “Unknown”.



(Thumbnail)



yellow



green

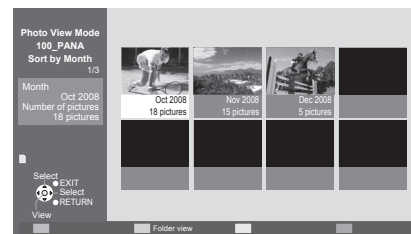

(Sort by Month)

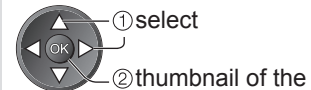

① select

② thumbnail of the selected group



blue



green



(Sort by Date)



① select

② thumbnail of the selected group

Link Functions (Q-Link VIERA Link)

Q-Link connects the TV and DVD Recorder / VCR, and enables easy recording, playback, etc. (p. 52)
 VIERA Link (HDAVI Control™) connects the TV and the equipment with VIERA Link function, and enables easy control, convenient recording, playback, energy saving, creating home theatre, etc., without complicated setting. (p. 53 - 59)

You can use Q-Link and VIERA Link functions together.

- This TV supports "HDAVI Control 4" function. But available features are depending on the connected equipment's version of HDAVI Control. Please refer to the manual of the equipment to confirm the version.

Summary of Q-Link and VIERA Link features

■ Q-Link (SCART connection only)

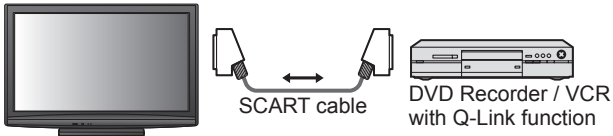
Features	Connected equipment DVD Recorder / VCR with Q-Link function	Connection
Analogue channel download	○	 <p>● Use fully wired SCART cable. ● Connect the DVD Recorder / VCR supporting Q-Link to the TV's AV1 or AV2 terminal via a SCART cable.</p>
Easy playback	○	
Power on link	○	
Power off link	○	
Direct TV Recording	○	

■ VIERA Link (HDMI connection only)

Features	Connected equipment DIGA Recorder with VIERA Link function	DVD Player / Blu-ray Disc Player with VIERA Link function	HD Video Camera / LUMIX Camera with VIERA Link function
Analogue channel download	—	—	—
Easy playback	○	○	○
Power on link	○	○	○
Power off link	○	○	○
Reduce unnecessary power consumption in standby	○*3	○*3	—
Auto standby for unnecessary equipment	○*3	○*3	—
Pause Live TV programme	○*3 ○*4	—	—
Direct TV Recording	○*3	—	—
Control the menu of the connected equipment by VIERA remote control	○*1	○*1	○*1
Speaker control	—	—	—

Connection

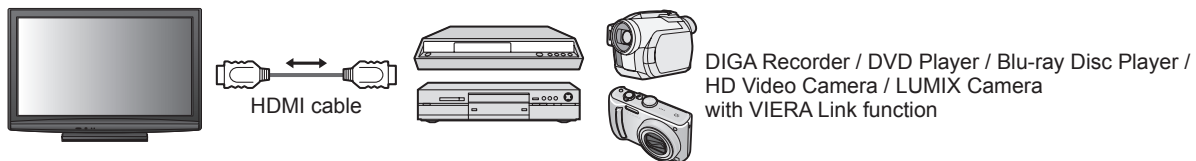

- Use fully wired HDMI compliant cable.
- Connect the equipment supporting VIERA Link to the TV's HDMI1 or HDMI2 terminal via an HDMI cable.
- About HDMI cable for connecting Panasonic HD Video Camera or LUMIX Camera, read the manual of the equipment.

■ VIERA Link (HDMI and SCART connections)

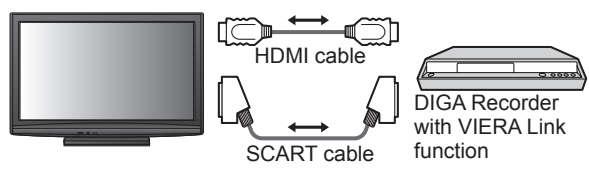
Features	Connected equipment DIGA Recorder with VIERA Link function	Connection
Analogue channel download	○	 <p>● Use fully wired HDMI compliant cable. ● Connect the equipment supporting VIERA Link to the TV's HDMI1 or HDMI2 terminal via an HDMI cable. ● Use fully wired SCART cable. ● Connect the equipment supporting VIERA Link to the TV's AV1 or AV2 terminal via a SCART cable.</p>
Easy playback	○	
Power on link	○	
Power off link	○	
Reduce unnecessary power consumption in standby	○*3	
Auto standby for unnecessary equipment	○*3	
Pause Live TV programme	○*2 ○*4	
Direct TV Recording	○*2	
Control the menu of the connected equipment by VIERA remote control	○*1	
Speaker control	—	

■ VIERA Link (HDMI and Audio out connections)

Features	Connected equipment	Player theatre with VIERA Link function	Blu-ray Disc theatre with VIERA Link function	Amplifier with VIERA Link function
Analogue channel download		—	—	—
Easy playback		○*5	○*5	—
Power on link		○	○	—
Power off link		○	○	○
Reduce unnecessary power consumption in standby		—	○*3	—
Auto standby for unnecessary equipment		○*3 *6	○*3 *6	○*3
Pause Live TV programme		—	—	—
Direct TV Recording		—	—	—
Control the menu of the connected equipment by VIERA remote control		○*1	○*1	—
Speaker control		○	○	○

Connection

● To use Player theatre / Blu-ray Disc theatre:

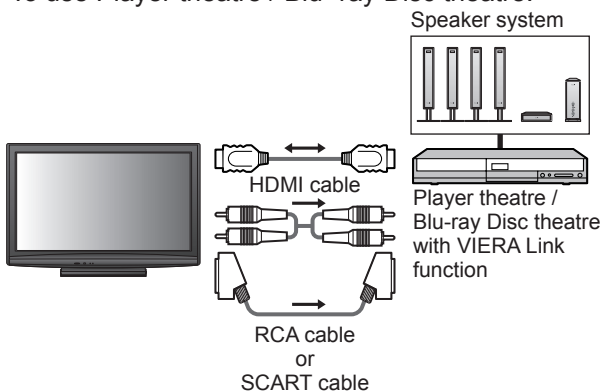

● To use Amplifier:

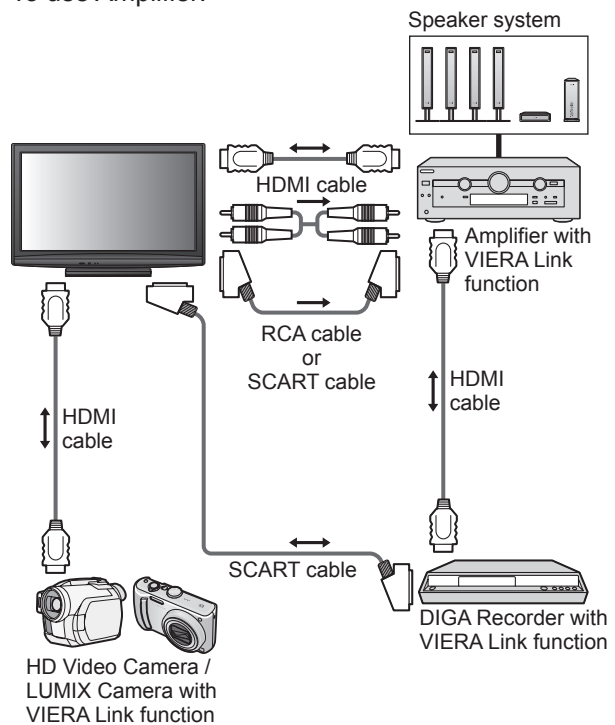

- Use fully wired HDMI compliant cable.
- Connect the equipment supporting VIERA Link to the TV's HDMI2 terminal via an HDMI cable.
- Use fully wired SCART cable.
- Connect the equipment supporting VIERA Link to the TV's AV1 or AV2 terminal via a SCART cable.
- Use RCA cable or SCART cable for audio output from the TV.

*1: Available with the equipment which has "HDAVI Control 2 or later" function.

*2: Available with the equipment which has "HDAVI Control 3 or later" function.

*3: Available with the equipment which has "HDAVI Control 4" function.

*4: Available with DIGA Recorder which has HDD.

*5: while playingback a disc

*6: except for watching a disc

Note

- VIERA Link features may be available even with other manufacturers' equipment supporting HDMI CEC.

Link Functions (Q-Link VIERA Link)

Q-Link

■ Preparations

- Connect the DVD Recorder / VCR with the following logos:
“Q-Link”, “NEXTVIEWLINK”, “DATA LOGIC”, “Easy Link”, “Megalogic” or “SMARTLINK”
- Q-Link connection → p. 50
- Use fully wired SCART cable.
- Set up the DVD Recorder / VCR. Read the manual of the recorder.
- Q-Link terminal setup in the Setup Menu → “Q-Link” (p. 32), “AV1 / AV2 out” (p. 32)
- Download Analogue channel setting → “Analogue channel download” (see below)

■ Features available

Analogue channel download

Analogue channel setting can be downloaded to the recorder with analogue tuner. Digital channel setting is not downloaded.

- To download Analogue channel setting → “Q-Link Download” (p. 32) or “Auto Setup” in Analogue mode (p. 35) or “Auto Setup” - when first using the TV (p. 12)

Direct TV Recording - What you see is What you record

Recording the current programme in DVD Recorder / VCR immediately.



- Available conditions:

Picture source	Mode	Recording from
Analogue	TV	TV monitor out
	AV	Recorder's tuner
DVB	TV	TV monitor out
AV (watching recorder's tuner)	AV	Recorder's tuner
AV (watching recorder's external input)	AV	Recorder's external input
AV (watching TV's external input)	AV	TV monitor out

- When Direct TV Recording is performed, the recorder is automatically turned on if it is in Standby mode.
- Changing channel or turning off the TV is available while the recorder is recording from its own tuner.
- Changing channel is not available while the recorder is recording from the TV tuner.

■ To stop recording

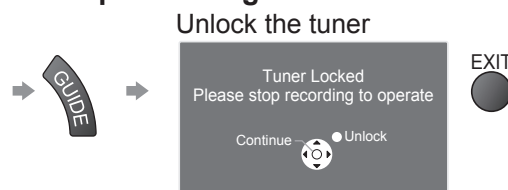

Power on link and Easy playback

When DVD Recorder / VCR starts playback or direct navigator / function menu for the equipment are activated, the TV is turned on and input mode is switched automatically so that you can view the content. (Only when the TV is in Standby mode.)

Power off link

When TV is set to Standby mode, the recorder is also automatically set to Standby. (Only when the videocassette or disc is not active.)

- This function will work even if the TV enters standby mode automatically by Off Timer function or auto power standby function.

- “DATA LOGIC” (a trademark of Metz Corporation)
- “Easy Link” (a trademark of Philips Corporation)

- “Megalogic” (a trademark of Grundig Corporation)
- “SMARTLINK” (a trademark of Sony Corporation)

Note

- Some recorders are not applicable. Read the manual of the recorder.

VIERA Link “HDAVI Control™”*

*Enjoy additional HDMI Inter-Operability with Panasonic products which have “HDAVI Control” function. This TV supports “HDAVI Control 4” function.

Connections to the equipment (DIGA Recorder, HD Video Camera, Player theatre, Amplifier, etc.) with HDMI and SCART cables allow you to interface them automatically (p. 50 and p. 51).

These features are limited to models incorporating “HDAVI Control” and “VIERA Link”.

- Some functions are not available depending on the equipment’s version of HDAVI Control. Please confirm the connected equipment’s version of HDAVI Control.
- VIERA Link “HDAVI Control”, based on the control functions provided by HDMI which is an industry standard known as HDMI CEC (Consumer Electronics Control), is a unique function that we have developed and added. As such, its operation with other manufacturers’ equipment that supports HDMI CEC cannot be guaranteed.
- Please refer to individual manuals for other manufacturers’ equipment supporting VIERA Link function.
- About applicable Panasonic equipment, consult your local Panasonic dealer or refer to the URL: www.panasonic.co.uk

■ Preparations

- Connect the equipment supporting VIERA Link.
- VIERA Link connection → p. 50 and p. 51
- Use fully wired HDMI compliant cable. Non-HDMI-compliant cables cannot be utilized.
Recommended Panasonic’s HDMI cable part number:
 - RP-CDHG10 (1.0 m)
 - RP-CDHG15 (1.5 m)
 - RP-CDHG20 (2.0 m)
 - RP-CDHG30 (3.0 m)
 - RP-CDHG50 (5.0 m)
- Use fully wired SCART cable.
- Set up the connected equipment. Read the manual of the equipment.
- For optimal recording, the settings of the recorder may need to be changed. For details, read the manual of the recorder.
- Download Analogue channel setting → “Analogue channel download” (see below)
- Set VIERA Link On in the Setup Menu → “VIERA Link” (p. 32)
- Set up the TV
 - **After connection, turn the equipment on and then switch the TV on.**
Select the input mode to HDMI1 or HDMI2 (p. 24), and make sure that an image is displayed correctly.
This setup should be done each time when the following conditions occur:
 - for the first time
 - when adding or reconnecting equipment
 - when changing setup

■ Features available

Analogue channel download

Analogue channel setting can be downloaded to the recorder with analogue tuner. Digital channel setting is not downloaded.

- To download Analogue channel setting → “Q-Link Download” (p. 32) or “Auto Setup” in Analogue mode (p. 35) or “Auto Setup” - when first using the TV (p. 12)

Easy playback

Automatic Input switching - When the connected equipment is operated, input mode is switched automatically. When it is stopped operating, input mode is returned.

Power on link

When the connected equipment starts playback or direct navigator / function menu for the equipment are activated, the TV is automatically turned on. (Only when the TV is in Standby mode.)

Power off link

When the TV is set to Standby mode, the connected equipment is also automatically set to Standby.

- This function will work even if the TV enters standby mode automatically by Off Timer function or auto power standby function.

Link Functions (Q-Link VIERA Link)

■ Features available

Reduce unnecessary power consumption in standby **Standby Power Save**

Set Standby Power Save “On” in the Setup Menu to use this function

→ “Standby Power Save” (p. 32)

The power consumption in Standby mode of the connected equipment is controlled higher or lower in synchronization with the TV On / Off state to reduce the consumption.

When the TV is set to Standby mode, the connected equipment is automatically set to Standby and the power consumption in Standby mode of the connected equipment is automatically minimized.

When the TV is turned on, the connected equipment is still in Standby mode, but the power consumption is increased to make startup time early.

- This function is effective if the connected equipment can change the power consumption in Standby mode and is set to higher consumption.

Auto standby for unnecessary equipment **Intelligent Auto Standby**

Set Intelligent Auto Standby “On (With reminder)” or “On (No reminder)” in the Setup Menu to use this function

→ “Intelligent Auto Standby” (p. 32)

When the TV is On, non-watched or non-used connected equipment goes into Standby mode automatically to reduce the power consumption. For example, when the input mode is switched from HDMI, when Speaker Selection is changed to “TV” (except for watching a disc).

- If you select “On (With reminder)”, the on screen message will be displayed to be noticed before working this function.
- This function may not work properly depending on the connected equipment. If required, set to “Off”.

■ Features available (Using VIERA Link Menu)

Direct TV Recording - What you see is What you record **Direct TV Rec**

Recording the current programme in DIGA Recorder immediately.

- If you connect a variety of recorders including other manufacturers' recorders at the same time, please connect DIGA Recorder to the TV's lower HDMI terminal number. For example, if you use HDMI1 and HDMI2 for two recorders, in this case connect DIGA Recorder to HDMI1.
- If you cannot operate, check the settings and the equipment
 - “Summary of Q-Link and VIERA Link features” (p. 50 and p. 51), “Preparations” (p. 53)
- Changing channel or turning off the TV is available while the recorder is recording from its own tuner.
- Changing channel is not available while the recorder is recording from the TV tuner.

1 Display “VIERA Link Menu”

2 Select “Direct TV Rec” and start recording

VIERA Link Menu

Pause Live TV	
Direct TV Rec	Start
VIERA Link Control	Recorder
Speaker Selection	Home Cinema

● You can also start recording directly →

■ To stop recording
Select “Stop” in “Direct TV Rec” and access

VIERA Link Menu

Pause Live TV	
Direct TV Rec	Stop
VIERA Link Control	Recorder
Speaker Selection	Home Cinema

● You can also stop recording directly.
Unlock the tuner

→ →

■ Features available (Using VIERA Link Menu)

Pause Live TV programme **Pause Live TV**

You can pause the live TV programme and resume later.

Live TV programme will be recorded on HDD of the connected DIGA Recorder.

- This function is available with DIGA Recorder which has HDD.
- If you connect a variety of recorders including other manufacturers' recorders at the same time, please connect DIGA Recorder which has HDD to the TV's lower HDMI terminal number. For example, if you use HDMI1 and HDMI2 for two recorders, in this case connect DIGA Recorder which has HDD to HDMI1.
- If you cannot operate, check the settings and the equipment
 - ➔ "Summary of Q-Link and VIERA Link features" (p. 50 and p. 51), "Preparations" (p. 53)

Access and pause the live TV programme



1 Display "VIERA Link Menu"



2 Select "Pause Live TV" and pause

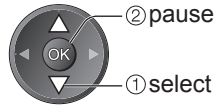
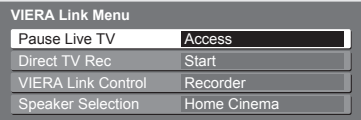

The TV picture will be paused.

- You can also pause directly by using VIERA TOOLS
 - ➔ "How to Use VIERA TOOLS" (p. 14)
- Live TV programme is recorded on HDD from where it was paused.
- If the paused TV picture disappears after a few minutes
 - ➔ **OPTION** (the paused picture will be restored)
- Follow the operation guide to operate Pause Live TV function.

■ To operate Pause Live TV

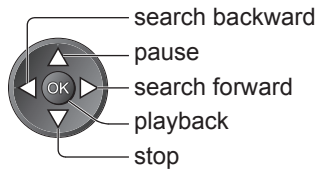

- Operations may be different depending on the recorder. In this case, follow the operation guide or read the manual of the recorder.

- If you stop playback, the recorded programme will be deleted from HDD.

■ To return to Live TV

(stop playback of Pause Live TV / cancel pause)

Select "Yes"

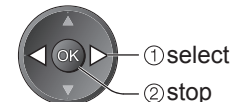
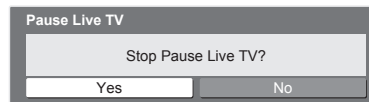

- If you stop playback or cancel pause, the recorded programme will be deleted from HDD.

Link Functions (Q-Link VIERA Link)

■ Features available (Using VIERA Link Menu)

Control the menu of the connected equipment by VIERA remote control

VIERA Link Control

You can control some functions of the connected equipment with this TV remote control (point the remote control at the TV's signal receiver).

- If you cannot operate, check the settings and the equipment
 - ➔ "Summary of Q-Link and VIERA Link features" (p. 50 and p. 51), "Preparations" (p. 53)
- For details of the operations for the connected equipment, read the manual of the equipment.

Access and operate the menu of the equipment

1 Display "VIERA Link Menu"

2 Select "VIERA Link Control"

3 Select the equipment you want to access
The type of the connected equipment is displayed. Select the type of the equipment and access.

■ If multiple recorders or players are connected

You can connect up to three recorders or players at the same time.

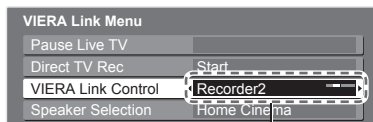

Recorder1-2 / Player1-2

The number is given from the TV's lower HDMI terminal number connected to the same type equipment. For example, two recorders to HDMI1 and HDMI2, in this case the recorder connected to HDMI1 is displayed as "Recorder1", and the recorder connected to HDMI2 is displayed as "Recorder2".

■ If you access non-VIERA Link equipment

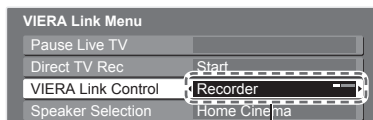

The type of the connected equipment is displayed. You can access the menu of the equipment. But you cannot operate it. Use its own remote control to operate the equipment.

Display "VIERA Link Menu"

Select "VIERA Link Control"

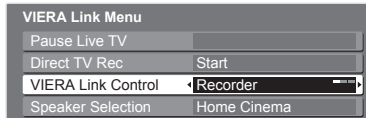

Select the equipment you want to access

The type of the connected equipment is displayed. Select the type of the equipment and access.

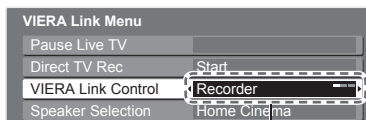

Recorder / Player / Home Cinema / Video Camera / LUMIX / Other

- You can also access directly by using VIERA TOOLS
 - ➔ "How to Use VIERA TOOLS" (p. 14)
- "Home Cinema" means Player theatre, Blu-ray Disc theatre or Recorder theatre.
- "Other" means Tuner set top box.

The menu of the accessed equipment
(Input mode will be changed automatically)

4 Operate the menu of the equipment
Available VIERA remote control buttons:
(depending on the connected equipment)



① **Set the code of the remote control to "73"**

➔ "How to change the code for the type of the equipment" (p. 25)

② **Follow the operation guide**

- To display the operation guide ➔ OPTION
- If other manufacturers' equipment is accessed, Setup / Contents Selection menu may be displayed.

- When the key words are displayed on colour bar



Note

- Some operations may not be available depending on the equipment. In this case use its own remote control to operate the equipment.

■ Features available (Using VIERA Link Menu)

Speaker control **Speaker Selection**

You can control the theatre speaker with this TV remote control (point the remote control at the TV's signal receiver).

- If you cannot operate, check the settings and the equipment
 - ➔ "Summary of Q-Link and VIERA Link features" (p. 50 and p. 51), "Preparations" (p. 53)

Access and control the speaker volume



- 1
- 2
- 3

Display "VIERA Link Menu"



Select "Speaker Selection"

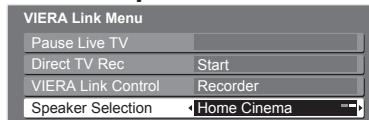

Set to "Home Cinema" or "TV"



■ Home Cinema

Player theatre, Blu-ray Disc theatre or Amplifier will be automatically turned on if it is in Standby mode and the sound is from theatre speakers connected to the equipment.

- Volume up / down

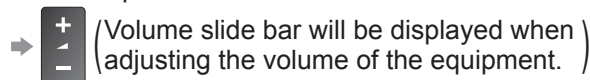

- Mute ➔

- The sound of TV speakers is mute.
- When the equipment is turned off, TV speakers will be active.

■ TV

TV speakers are active.

Note

- To enjoy the sound from the DIGA Recorder in multi-channel sound, connect an HDMI cable from the DIGA Recorder to the Amplifier (p. 51).

Note



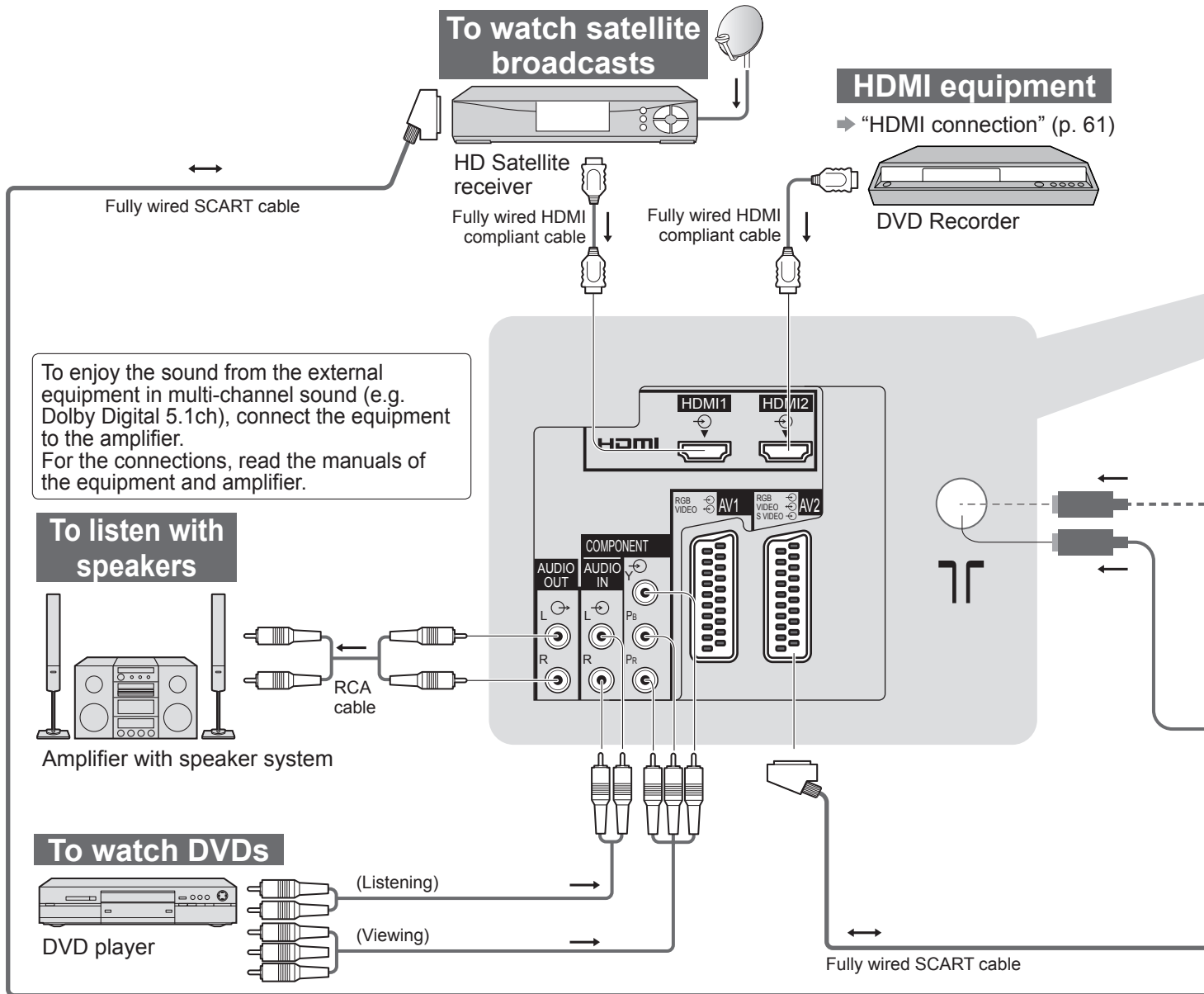

- These functions may not work properly depending on the connected equipment.
- Image or sound may not be available for the first few seconds when Input mode is switched.
- Easy playback may be available by using the remote control for Player theatre, Blu-ray Disc theatre or Amplifier. Read the manual of the equipment.
- "HDAVI Control 4" is the newest standard (current as of December, 2008) for HDAVI Control compatible equipment. This standard is compatible with conventional HDAVI equipment.
- To confirm this TV's version of HDAVI Control ➔ "System Information" (p. 33)

External Equipment

These diagrams show our recommendations for connection of your TV to various pieces of equipment. For other connections, consult the instructions for each piece of equipment, the table below, and the specifications (p. 71).



Types of connectable equipment to each terminal

Terminal	AV1	AV2	AV3 (Side panel of TV)	 S-V  V  L  R
Recording / Playback (equipment)				
To record / playback videocassettes / DVDs (VCR / DVD recorder)	○	○		
To watch DVDs (DVD player)	○	○	○	
To watch camcorder images (Video camera)	○	○	○	
To watch satellite broadcasts (Set top box)	○	○	○	
To play games (Game equipment)	○	○	○	
To use amplifier with speaker system				
Q-Link	○	○		
VIERA Link	○ (with HDMI)	○ (with HDMI)		
Direct TV Recording	○	○		

Rear of the TV

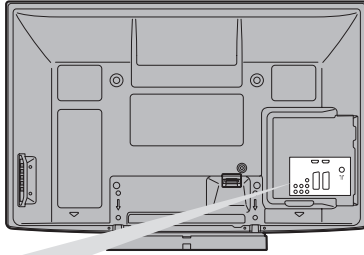

Terrestrial aerial



To record / playback

DVD Recorder / VCR

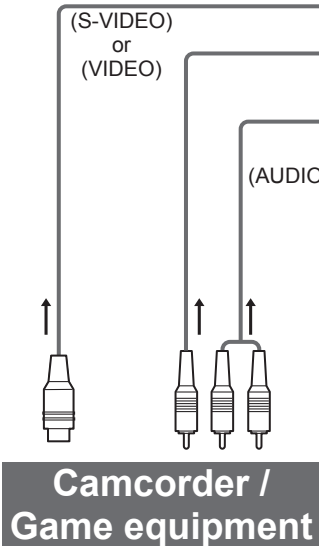

Camcorder / Game equipment

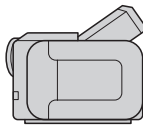

Headphones

To adjust volume
 → "Headphone Volume" in the Sound Menu (p. 31)



COMPONENT	AUDIO OUT	HDMI	
		1	2
○		○	○
		○	○
		○	○
	○		
		○	○
		○	○

Technical Information

Auto Aspect

The optimum size and aspect can be chosen automatically, and you can enjoy finer images. (p. 17)

■ Aspect Control Signal

“WIDE” will appear in the top left of the screen if a Widescreen signal (WSS) or a Control signal through SCART / HDMI terminal is found.

The aspect will switch to the appropriate 16:9 or 14:9 widescreen ratio.

This function will work in any aspect mode.

Input terminal	Input signal format	Aspect Control Signal	
		Widescreen signal (WSS)	Control signal through SCART (pin8) / HDMI terminal
RF	DVB	○	
	PAL I	○	
	PAL 525/60 6.0 MHz	—	
	M.NTSC 6.0 MHz	—	
AV1 (Composite) AV2 (Composite or S-Video) AV3	PAL	○	○
	PAL 525/60	—	○
	M.NTSC	—	○
	NTSC	—	○
COMPONENT	525 (480) / 60i	—	
	525 (480) / 60p	—	
	625 (576) / 50i	○	
	625 (576) / 50p	○	
	750 (720) / 60p	—	
	750 (720) / 50p	—	
	1,125 (1,080) / 60i	—	
	1,125 (1,080) / 50i	—	
HDMI1 HDMI2	525 (480) / 60i	—	○
	525 (480) / 60p	—	○
	625 (576) / 50i	—	○
	625 (576) / 50p	—	○
	750 (720) / 60p	—	○
	750 (720) / 50p	—	○
	1,125 (1,080) / 60i	—	○
	1,125 (1,080) / 50i	—	○
	1,125 (1,080) / 60p	—	○
	1,125 (1,080) / 50p	—	○
	1,125 (1,080) / 24p	—	○

■ Auto mode

Auto mode determines the best aspect ratio to fill the screen. It does this using a four step process (WSS, Control signal through SCART / HDMI terminal, Letterbox detection, or Justify to fill the screen) to determine. This process may take several minutes, depending on the darkness of the image.

Letterbox detection: If black bands at the top and bottom of the screen are detected, Auto mode chooses the best ratio and expands the image to fill the screen.

If no aspect signals are detected, Auto mode enhances the image for optimum viewing pleasure.

Note

- The ratio varies depending on the programme, etc. If the ratio is out of the standard 16:9, black bands at the top and bottom of the screen may appear.
- If the screen size looks unusual when a widescreen-recorded programme is played back on a VCR, adjust the tracking of the VCR. Read the manual of the VCR.

Updating the TV software

From time to time, a new version of software may become available for download to enhance the performance or operations of the TV.

■ To download from a notification banner

A notification banner will appear when you search for a new version software by using the “System Update Search Now” function (p. 45).

A notification banner will appear when one of the BBC channels is tuned if a new available software is found.

To start downloading press the OK button, this may take up to 60 minutes to complete.

To ignore the new software press the EXIT button.

You can update later automatically when the TV is in Standby mode

➔ “To download any new software automatically” (see below)

If you do not wish to update, set “Auto Update Search in Standby” to “Off”, but the notification banner will keep appearing during the period of new software availability, usually 2 to 3 days.

■ To download any new software automatically

Ensure that the “Auto Update Search in Standby” function in the System Update menu is set to “On” (p. 45).

The TV will then download new software automatically at night if it is left in standby without any timer programming in progress.

Found new software version ***,
Press OK to start update (may take 40 mins)
or Press EXIT to ignore
and you can update when TV is in standby.

Note

- During software download and update, DO NOT switch Off the TV.

HDMI connection

HDMI (high-definition multimedia interface) is the world's first complete digital consumer AV interface complying with a non-compression standard.

HDMI allows you to enjoy high-definition digital images and high-quality sound by connecting the TV and the equipment.

HDMI-compatible equipment (*1) with an HDMI or DVI output terminal, such as a set top box or a DVD player, can be connected to the HDMI terminal using an HDMI compliant (fully wired) cable.

About connections, see "External Equipment" (p. 58).

■Applicable HDMI features

- Input audio signal : 2ch Linear PCM (sampling frequencies - 48 kHz, 44.1 kHz, 32 kHz)
- Input video signal : 480i, 480p, 576i, 576p, 720p, 1080i and 1080p
 - ➔ "Input signal that can be displayed" (p. 62)
 - Match the output setting of the digital equipment.
- Input PC signal : ➔ "Input signal that can be displayed" (p. 62)
 - Match the output setting of the PC.
- VIERA Link (HDAVI Control 4) : ➔ "VIERA Link" (p. 53)
- x.v.Colour™

■DVI connection

If the external equipment has only a DVI output, connect to the HDMI1 terminal via a DVI to HDMI adapter cable (*2).

When the DVI to HDMI adapter cable is used, connect the audio cable to the audio input terminal (HDMI1: use COMPONENT-AUDIO terminals).

Note

- Audio settings can be made on the "HDMI1 Input" in the Sound Menu. (p. 31)
- HDMI2 terminal is for digital audio signal only.
- If the connected equipment has an aspect adjustment function, set the aspect ratio to "16:9".
- These HDMI connectors are "type A".
- These HDMI connectors are compatible with HDCP (High-Bandwidth Digital Content Protection) copyright protection.
- An equipment having no digital output terminal may be connected to the input terminal of either "COMPONENT", "S-VIDEO", or "VIDEO" to receive analogue signals.
- This TV incorporates HDMI™ (Version 1.3a with x.v.Colour™) technology.

(*1): The HDMI logo is displayed on HDMI-compliant equipment.

(*2): Enquire at your local digital equipment retailer shop.

SCART, S-VIDEO and HDMI terminal information

■AV1 SCART terminal

(RGB, VIDEO, Q-Link)

Suitable inputs for AV1 include RGB (Red / Green / Blue).

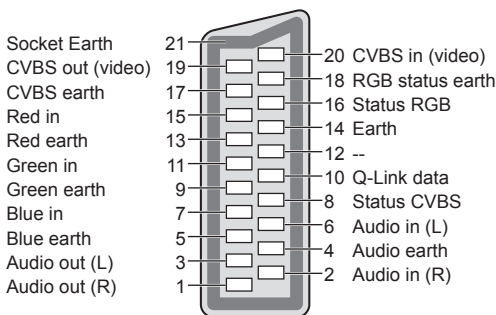

■AV2 SCART terminal

(RGB, VIDEO, S-VIDEO, Q-Link)

AV2 - Pins 15 and 20 are dependent on AV2 S-VHS / VIDEO switching.

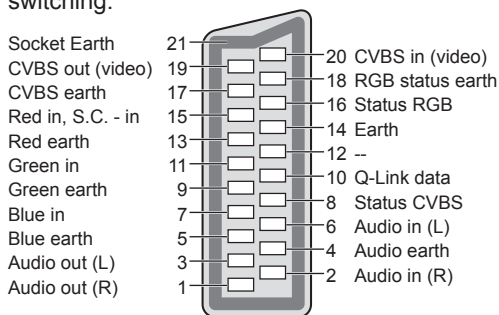

■AV3 S-VIDEO 4 pin terminal



■HDMI terminal

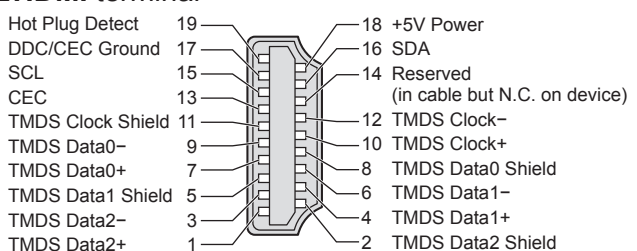

Technical Information

Input signal that can be displayed

COMPONENT (Y, P_B, P_R), HDMI

* Mark: Applicable input signal

Signal name	COMPONENT	HDMI
525 (480) / 60i	*	*
525 (480) / 60p	*	*
625 (576) / 50i	*	*
625 (576) / 50p	*	*
750 (720) / 60p	*	*
750 (720) / 50p	*	*
1,125 (1,080) / 60i	*	*
1,125 (1,080) / 50i	*	*
1,125 (1,080) / 60p		*
1,125 (1,080) / 50p		*
1,125 (1,080) / 24p		*

PC (from HDMI terminal)

Applicable input signal for PC is basically compatible to HDMI standard timing.

Signal name	Horizontal frequency (kHz)	Vertical frequency (Hz)
640 × 480 @60 Hz	31.47	60.00
750 (720) / 60p	45.00	60.00
1,125 (1,080) / 60p	67.50	60.00

Note

- Signals other than above may not be displayed properly.
- The above signals are reformatted for optimal viewing on your display.
- PC signal is magnified or compressed for display, so that it may not be possible to show fine detail with sufficient clarity.

SD Card

■ Cautions in handling SD Card

- Do not remove the card while the TV is accessing data (this can damage card or TV).
- Do not touch the pins on the back of the card.
- Do not subject the card to a high pressure or impact.
- Insert the card in the correct direction (otherwise, card may be damaged).
- Electrical interference, static electricity, or erroneous operation may damage the data or card.
- Back up the recorded data at regular intervals in case of deteriorated or damaged data or erratic operation of the TV. (Panasonic is not liable for any deterioration or damage of recorded data.)

■ Data format for Card browsing

Still images recorded with digital still cameras compatible with JPEG files of DCF* and EXIF standards

Data format - Baseline JPEG (Sub-sampling 4:4:4, 4:2:2 or 4:2:0)

Max. number of files - 9,999

Image resolution - 160 × 120 to 10,000,000

- Compliant card type (maximum capacity): SDHC Card (32 GB), SD Card (2 GB), miniSD Card (2 GB) (requiring miniSD adapter)
- If miniSD Card is used, insert / remove it together with the adapter.
- Check the latest information on the card type at the following website. (English only)

<http://panasonic.co.jp/pavc/global/cs/>

*DCF (Design rule for camera file system): Unified standard established by Japan Electronics and Information Technology Industries Association (JEITA).

Note

- Format the card with the recording equipment.
- The picture may not appear correctly on this TV depending on the recording equipment used.
- Display may take some time when there are many files and folders.
- This function cannot display Motion JPEG and still image not DCF formatted (i.e. TIFF, BMP).
- A data modified with a PC may not be displayed.
- Images imported from a PC must be compatible with EXIF (Exchangeable Image File) 2.0, 2.1, and 2.2.
- Partly degraded files might be displayed at a reduced resolution.
- All ".JPG" extension datas in the card will be read in Photo View Mode.
- The folder and file names may be different depending on the digital camera used.
- Do not use two-byte characters or other special codes.
- The card may become unusable with this TV if the file or folder names are changed.

Characters table for numeric buttons

You can enter characters by using numeric buttons for free input items.

Press the numeric button repeatedly until you reach the desired character.

- 1** **2** **3** ● The character is set automatically if you leave for one second.
- 4** **5** **6** ● You can also set the character by pressing the OK button or other numeric buttons within one second.
- 7** **8** **9**
- 0**



Characters table:

Numeric buttons	The number of times to press										
	1	2	3	4	5	6	7	8	9	10	11
1	.	1	!	:	#	+	-	*	_	()
2	a	b	c	2	A	B	C				
3	d	e	f	3	D	E	F				
4	g	h	i	4	G	H	I				
5	j	k	l	5	J	K	L				
6	m	n	o	6	M	N	O				
7	p	q	r	s	7	P	Q	R	S		
8	t	u	v	8	T	U	V				
9	w	x	y	z	9	W	X	Y	Z		
0	Space	0									

FAQs

Before requesting service or assistance, please follow these simple guides to resolve the problem. If the problem still persists, please contact your local Panasonic dealer or Panasonic Customer Care Centre for assistance. For details → p. 72

White spots or shadow images (noise)

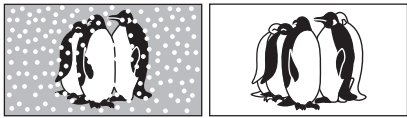

- Check the position, direction, and connection of the aerial.

Neither image nor sound is produced

- Is the TV in AV mode?
- Check the correct AV input mode is selected.
- Check the mains lead is plugged into the socket outlet.
- Has the TV been turned On?
- Check Picture Menu (p. 30) and volume.
- Check all required SCART cables and connections are firmly in place.

Auto aspect

- Auto aspect is designed to provide you with the best ratio to fill the screen. (p. 60)
- Press the ASPECT button if you would like to change the aspect ratio manually (p. 17).

S-Video / black and white picture

- Check that the output of the external equipment matches the input of the TV. If the output of the external equipment is set to S-Video, the TV must also be set to S-Video (p. 24).

No programmes shown on TV Guide

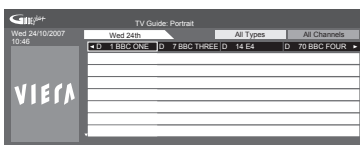

- Reset channels. (p. 34)
- Check the digital transmitter.
- Adjust the direction of the aerial to another transmitter installed nearby.
- Check the analogue broadcast. If the image quality is poor, check the aerial and consult your nearest dealer.

An error message appears

- Follow the message's instructions.
- If the problem persists, contact the authorized Service Centre.



Remains channel number, input mode, etc. on the TV screen -i.e. EC/AV1

- Press the **i** button to clear these. Press again to redisplay.

Q-Link function does not work

- Confirm SCART cable and connection. Also set "AV1 / AV2 out" in the Setup Menu (p. 32).

"VIERA Link" function does not work and an error message appears

- Confirm the connection. (p. 50 and p. 51)
- Turn the connected equipment on and then switch the TV on. (p. 53)

Recording does not start immediately

- Check the settings of the recorder. For details, read the manual of the recorder.
- Timer Programming might be performed.

Permanently lit spots on screen

- Due to production process involved in this technology this may result in some pixels which are permanently lit or unlit. This is not a malfunction.

Contrast is reduced

- Contrast is lowered in the following conditions without any user operation for a few minutes:
 - no signal in DVB or AV mode
 - selected locked channel
 - selected invalid channel
 - selected radio channel
 - displayed menu
 - digital teletext (no video contents)
 - Thumbnail or still picture in SD Card mode

	Problem	Actions
Screen	Chaotic image, noisy	<ul style="list-style-type: none"> ● Set "P-NR" in the Picture Menu (to remove noise). (p. 30) ● Check nearby electrical products (fluorescent lamp, DECT phones, mobile phones, microwave, etc.).
	No image can be displayed	<ul style="list-style-type: none"> ● Is "Colour" or "Contrast" in the Picture Menu set to the minimum? (p. 30) ● Please also refer to "Neither image nor sound is produced" (p. 64).
	Blurry or distorted image (no sound or low volume)	<ul style="list-style-type: none"> ● Reset channels. (p. 34 and p. 35) ● Please also refer to "Neither image nor sound is produced" (p. 64).
	Unusual image is displayed	<ul style="list-style-type: none"> ● Turn the TV Off with Mains power On / Off switch, then turn it On again. ● If the problem persists, perform "Shipping Condition" (p. 41).
Sound	No sound is produced	<ul style="list-style-type: none"> ● Is "Sound mute" active? (p. 9) ● Is the volume set to the minimum? ● Please also refer to "Neither image nor sound is produced" (p. 64).
	Sound level is low or sound is distorted	<ul style="list-style-type: none"> ● Sound signal reception may be deteriorated. ● Set "NICAM" (p. 31) in the Sound Menu to "Off". (Analogue only) ● Please also refer to "Neither image nor sound is produced" (p. 64).
Digital Channel	<ul style="list-style-type: none"> ● Due to the digital reception technologies involved, quality of the digital signals may be relatively low in some cases, despite good reception of analogue channels. 	
	Interference or frozen / disappearing image	<ul style="list-style-type: none"> ● Check "Signal Condition". (p. 36) If "Signal Quality" or "Signal Strength" are displayed in red, the signal is weak. ● Check aerial. ● Check your postcode area is able to receive the Freeview channels at www.freeview.co.uk ● Digital signals may be relatively low to prevent interference with analogue signals for the period of Digital Switchover. Check the plan of Digital Switchover at www.digitaluk.co.uk ● Weather conditions will affect signal reception (heavy rain, snow, etc.), in particular in poor reception areas. Even during good weather the high pressure can cause poor reception of some channels. ● Turn the TV off with the Mains power On / Off switch, then turn it On again. ● Reset channels. (p. 34 and p. 35)
	Some channels cannot be tuned	<ul style="list-style-type: none"> ● Check the aerial.
	Cannot find a channel you have previously watched	<ul style="list-style-type: none"> ● The channel may broadcast for part of the day. ● Check the channel in the TV Guide. (p. 18) ● Channel position numbers may be changed by broadcasters. ● Reset channels. (p. 34 and p. 35)
HDMI	Sound is unusual	<ul style="list-style-type: none"> ● Set the sound setting of the connected equipment to "2ch L.PCM". ● Check the "HDMI1 Input" setting in the Sound Menu. (p. 31) ● If digital sound connection has a problem, select analogue sound connection. (p. 61)
	Pictures from external equipment are unusual when the equipment is connected via HDMI	<ul style="list-style-type: none"> ● Check the HDMI cable is connected properly. (p. 58) ● Turn the connected equipment on and then switch the TV on. (p. 55) ● Check an input signal from the equipment. (p. 62) ● Use an equipment compliant with EIA/CEA-861/861B.
Other	The TV does not switch On	<ul style="list-style-type: none"> ● Press and hold the standby On / Off switch on the remote control for about 1 second if Power LED is red. ● Check the mains lead is plugged into the socket outlet. ● The fuse in the mains plug may have blown. Replace it with one of an identical rating (p. 4).
	The TV goes into "Standby mode"	<ul style="list-style-type: none"> ● Off Timer function is activated. ● The TV enters "Standby mode" about 30 mins. after analogue broadcasting ends.
	The remote control does not work or is intermittent	<ul style="list-style-type: none"> ● Are the batteries installed correctly? (p. 6) ● Has the TV been switched On? ● The batteries may be running low. Replace them. ● Point the remote control directly at the front of the TV (within a 30 degree angle of the front of the TV). ● Situate the TV away from sunshine or other sources of bright light not to shine on the TV's remote control signal receiver.

On screen messages

Message	Meaning / Action
All tuning data will be erased	<ul style="list-style-type: none"> • "Shipping Condition" will erase all tuning data (p. 41).
Are you sure ?	<ul style="list-style-type: none"> • Confirm correct operation.
Are you sure you want to delete this timer ? Press OK to delete timer Press RETURN to return	<ul style="list-style-type: none"> • Confirm correct operation.
Bad signal	<ul style="list-style-type: none"> • The signal is weak. Check the aerial is plugged in properly. It may be necessary to have an aerial installer check the signal and aerial alignment. • Reset channels. (p. 34 and p. 35)
Child Lock is active ! Press OK to enter PIN.	<ul style="list-style-type: none"> • The selected channel is locked in Child Lock (p. 40). You must enter the PIN number before the channel will be displayed.
Feature not available	<ul style="list-style-type: none"> • It is not possible to record from COMPONENT or HDMI. Connect the recorder to the TV using a fully wired SCART cable for recording from the TV tuner. • Confirm Q-Link or VIERA Link settings (p. 50 - 53).
Found new software version ***. Press OK to start update (may take 40 mins) or Press EXIT to ignore and you can update when TV is in standby.	<ul style="list-style-type: none"> • There is a new software available.
Invalid operation - Please check settings and connections.	<ul style="list-style-type: none"> • Check the Q-Link or VIERA Link connection and setting (p. 50 - 53).
Invalid system time. Please exit !	<ul style="list-style-type: none"> • Cannot get the time information. Check the connection of the RF cable.
Max. number of Timers already set !	<ul style="list-style-type: none"> • The maximum number of timer programming events is 15.
New channels found! Press OK to update channel list Press EXIT to ignore.	<ul style="list-style-type: none"> • There may be new channels available. • This message will appear each time a change is made by the broadcasters. This message can be deactivated by setting "New Channel Message" to Off in "DVB Tuning Menu". Selecting OK will perform "Update Channel List".
No channel found. Please check aerial or local signal availability. Press OK to start Auto Setup.	<ul style="list-style-type: none"> • Please follow the message. If it is still failed, consult your local Panasonic dealer.

Message	Meaning / Action
No module inserted	▶ ● Check the CI module inserted completely (p. 45).
No recording - Check media	▶ ● The tape or disc may be “write protected”, missing or damaged.
No recording - Already recording	▶ ● The equipment may already be recording.
No recording - Unknown reason	▶ ● The recording may not be performed. Check the equipment. ● Disc or tape may be full.
No service	▶ ● The broadcaster has stopped the service. Check the channel in TV Guide. (p. 18)
No signal	▶ ● The TV cannot detect the signal. Check the connection of the RF cable.
PIN incorrect!	▶ ● The PIN number you entered is wrong.
Please check settings and connections on HDMI devices.	▶ ● Communication error in VIERA Link function (p. 53).
Please wait.	▶ ● A function is in progress.
Recording this channel now	▶ ● The recorder is recording the programme from its own tuner. You can turn the TV off and leave the equipment recording in the normal way.
Reset to Factory Shipping Condition Completed. Please switch off TV.	▶ ● “Auto Setup” will automatically start when Mains power On / Off switch is next turned On. (p. 12)
Sending Preset Data Please wait!	▶ ● Q-Link or VIERA Link channel download is in progress.
Software successfully updated. Press EXIT to continue.	▶ ● The software updating is finished.
Software update failed. Please try again later. Press EXIT to continue.	▶ ● Perform “System Update Search Now” in System Update (p. 45). If this is still unsuccessful, there may not be any new software available.

On screen messages

Message	Meaning / Action
This timer will not follow the TV Guide information Press OK to continue, RETURN to restore original timer	<ul style="list-style-type: none"> ● If you edit the start time or end time of Guide link recording more than 10 minutes, it will no longer be performed as Guide link recording. The recording will be performed according to the time setting.
Timer already expired !	<ul style="list-style-type: none"> ● Starting time in Timer Programming is already past. Set correctly (p. 47).
Timer Event Due to Start DVB 1: BBC1 has been programmed for recording at **:***	<ul style="list-style-type: none"> ● This message will appear 2 minutes before timer programming event due to start.
Timer incorrect !	<ul style="list-style-type: none"> ● Set Start and End times in Timer Programming correctly (p. 47).
Timer overlap Press OK to keep, RETURN to edit	<ul style="list-style-type: none"> ● Timer programming events are overlapped. If you press the OK button, the first timer programming event will start and finish, the next timer programming event can then start.
Tuner Locked Please stop recording to operate	<ul style="list-style-type: none"> ● If you want to unlock, cancel Direct TV Recording (p. 52 and p. 54) or Timer Programming (p. 47).
Unable to download, please check equipment	<ul style="list-style-type: none"> ● The tape or disc is active. Stop the equipment and try again.
■ SD Card	
Cannot read file	<ul style="list-style-type: none"> ● The file is broken or unreadable. ● The TV does not support the format. (For the applicable formats and data ➔ p. 62)
No SD card inserted	<ul style="list-style-type: none"> ● Confirm SD Card is inserted correctly.
No valid file to play	<ul style="list-style-type: none"> ● The card has no data.
Over 9999 pictures found. (max. is 9999)	<ul style="list-style-type: none"> ● Maximum valid number of photos is 9,999.

Glossary

- **DVB**
Digital Video Broadcasting
- **DVD**
Digital Versatile Disc
- **DVI**
Digital Visual Interface
- **EPG**
Electronic Programme Guide
- **HDMI**
High-Definition Multimedia Interface
- **NTSC**
National Television System Committee
One of the television signals used in USA, etc.
- **RF**
Radio Frequency - Signal received from terrestrial aerial
- **RGB / S-Video / Video**
Choose between these three video formats depending on personal preference and equipment requirement (RGB - Red, Green and Blue)
- **SCART**
21 pin connection used for video, audio and switching signals (Also known as Euro SCART and Peritel)
- **Shop viewing environment**
Shop viewing environment is the demonstration mode to explain main features of this TV in an easy understandable way. This mode will work if you select "Shop" in "Auto Setup" (p. 12).
- **VCR**
Video Cassette Recorder

Index

- A** Accessories 6
 - Analogue Tuning Menu 35, 38
 - Aspect 17, 62
 - Audio Description 17, 31
 - Auto Setup 12, 34, 35
 - AV1 / AV2 out 32, 52
- B** Banner Display Timeout 33
- C** Category list 18
 - Channel List 37, 39
 - Child Lock 40
 - CI module 45
 - COMPONENT 58, 62
 - Connection 10, 11, 50, 51, 58
- D** Direct TV Recording 52, 54
 - DVB Tuning Menu 34, 36
 - DVI 61
 - DVDs 10, 11, 24, 25
- E** EPG 18
 - External equipment 10, 11, 24, 58
 - External input 24
- F** FAQs 64, 65
 - Favourites Edit 37
 - Free input menu 26
- G** Guide link recording 20
 - GUIDE Plus+ Settings 33
- H** HDMI 61, 62
 - Hold 15, 22
 - Home Cinema 51, 57
- I** Information banner 16
 - Input Labels 48
 - Input signal 62
- L** Licence 70
- M** Mains Lead 11
 - Mains power On / Off switch 8, 12
 - Maintenance 5
 - Manual Tuning 37, 39
 - Menu Functions 26-33
 - Mode 31
 - Multi Audio 17
- N** New Channel Message 36
 - NICAM 31
 - Normalisation 9, 26
 - NTSC 27, 71
- O** Off Timer 17, 32
 - Optional accessories 6
 - Owner ID 12, 42
- P** PAL 71
 - Pedestal 7
 - Photo View 48
 - Picture Overscan 33
 - PIN number 13, 40, 42
 - Playing Time Display 33
 - P-NR 30
 - Power LED 8
- Q** Q-Link 32, 50, 52
 - Q-Link Download 12, 32
 - Quick Start Guide 6-13
- R** Remote control 6, 9
 - Reset to Defaults 30, 31
 - RGB 71
- S** Sales and Support Information 72
 - Satellite receiver 11, 24, 58
 - SCART 10, 50, 61
 - SD Card 48, 62
 - Shipping Condition 41
 - Signal Condition 36
 - Slideshow 49
 - Specifications 71
 - Split Programme 20
 - Subtitles 16, 23
 - S-Video 59, 61
 - System Update 45, 60
- T** Teletext 21-23
 - Timer LED 8, 19, 47
 - Timer Programming 46
 - TV Guide 18-20
 - TV speaker 57
 - Type list 18
- U** Update Channel List 36
 - Update the software 45, 60
- V** V-Audio 31
 - VCR 10, 11, 24, 25, 59
 - VIERA Link 50, 51, 53-57
 - Viewing Mode 30
 - Volume Correction 31
- W** WSS 60
- Z** Zoom 16

Licence

Even if no special notation has been made of company or product trademarks, these trademarks have been fully respected.

- DVB is a trademark of the DVB Digital Video Broadcasting Project (1991 to 1996).
- SDHC Logo is a trademark.
- HDMI, the HDMI Logo and High-Definition Multimedia Interface are trademarks or registered trademarks of HDMI Licensing LLC.
- HDAVI Control™ is a trademark of Panasonic Corporation.
- x.v.Colour™ is a trademark.
- GUIDE Plus+ is (1) a registered trademark or trademark of, (2) manufactured under license from and (3) subject of various international patents and patent applications owned by, or licensed to, Gemstar-TV Guide International, Inc. and/or its related affiliates.

Specifications

		TX-P37C10B	TX-P42C10B	TX-P50C10B	
Power Source		AC 220-240 V, 50 / 60 Hz			
Power Consumption		230 W	245 W	350 W	
Power Consumption in Standby mode		0.7 W (Without monitor out recording) 15 W (With monitor out recording)		0.5 W (Without monitor out recording) 15 W (With monitor out recording)	
Display panel	Aspect Ratio	16:9			
	Visible screen size	94 cm (diagonal) 819 mm (W) × 457 mm (H)	106 cm (diagonal) 921 mm (W) × 518 mm (H)	127 cm (diagonal) 1,106 mm (W) × 622 mm (H)	
	Number of pixels	737,280 (1,024 (W) × 720 (H)) [3,072 × 720 dots]	786,432 (1,024 (W) × 768 (H)) [3,072 × 768 dots]	1,049,088 (1,366 (W) × 768 (H)) [4,098 × 768 dots]	
Sound	Speaker	160 mm × 40 mm × 2 pcs, 6 Ω			
	Audio Output	20 W (10 W + 10 W), 10% THD			
	Headphones	M3 (3.5 mm) stereo mini Jack × 1			
Receiving Systems / Band name		PAL I : UHF E21-68 PAL 525/60 : Playback of NTSC tape from some PAL Video recorders (VCR) or NTSC disc playback from DVD player and recorder. DVB-T : Digital terrestrial services via UHF aerial input. M.NTSC : Playback from M.NTSC Video recorders (VCR). NTSC (AV input only) : Playback from NTSC Video recorders (VCR).			
Aerial - Rear		UHF			
Operating Conditions		Temperature : 0 °C - 35 °C Humidity : 20 % - 80 % RH (non-condensing)			
Connection Terminals	AV1 (Scart terminal)	21 Pin terminal (Audio/Video in, Audio/Video out, RGB in, Q-Link)			
	AV2 (Scart terminal)	21 Pin terminal (Audio/Video in, Audio/Video out, RGB in, S-Video in, Q-Link)			
	AV3	VIDEO	RCA PIN Type × 1	1.0 V[p-p] (75 Ω)	
		S-VIDEO	Mini DIN 4-pin	Y:1.0 V[p-p] (75 Ω)	C:0.286 V[p-p] (75 Ω)
		AUDIO L - R	RCA PIN Type × 2	0.5 V[rms]	
	COMPONENT	VIDEO	Y PB, PR	1.0 V[p-p] (including synchronization) ±0.35 V[p-p]	
		AUDIO L - R	RCA PIN Type × 2	0.5 V[rms]	
	Others	HDMI1 / 2	TYPE A Connectors HDMI™ (Version 1.3a with x.v.Colour™) ● This TV supports "HDAVI Control 4" function.		
Card slot		SD Card slot × 1			
Output	AUDIO L - R	RCA PIN Type × 2	0.5 V[rms] (high impedance)		
Dimensions (W × H × D)		929 mm × 644 mm × 327 mm (With Pedestal) 929 mm × 596 mm × 100 mm (TV only)	1,029 mm × 709 mm × 327 mm (With Pedestal) 1,029 mm × 661 mm × 100 mm (TV only)	1,218 mm × 822 mm × 387 mm (With Pedestal) 1,218 mm × 769 mm × 100 mm (TV only)	
Mass		24.0 kg Net (With Pedestal) 22.0 kg Net (TV only)	28.0 kg Net (With Pedestal) 26.0 kg Net (TV only)	36.0 kg Net (With Pedestal) 34.0 kg Net (TV only)	

Note

- Design and Specifications are subject to change without notice. Mass and Dimensions shown are approximate.
- This equipment complies with the EMC standards listed below.
EN55013, EN61000-3-2, EN61000-3-3, EN55020.
- Pedestal: ST-42RF1WG / ST-50RF1WG (For safety approval)

Information for Users on Collection and Disposal of Old Equipment and used Batteries



These symbols on the products, packaging, and/or accompanying documents mean that used electrical and electronic products and batteries should not be mixed with general household waste. For proper treatment, recovery and recycling of old products and used batteries, please take them to applicable collection points, in accordance with your national legislation and the Directives 2002/96/EC and 2006/66/EC.

By disposing of these products and batteries correctly, you will help to save valuable resources and prevent any potential negative effects on human health and the environment which could otherwise arise from inappropriate waste handling.

For more information about collection and recycling of old products and batteries, please contact your local municipality, your waste disposal service or the point of sale where you purchased the items.

Penalties may be applicable for incorrect disposal of this waste, in accordance with national legislation.



For business users in the European Union

If you wish to discard electrical and electronic equipment, please contact your dealer or supplier for further information.

[Information on Disposal in other Countries outside the European Union]

These symbols are only valid in the European Union. If you wish to discard these items, please contact your local authorities or dealer and ask for the correct method of disposal.



Note for the battery symbol (bottom two symbol examples):

This symbol might be used in combination with a chemical symbol. In this case it complies with the requirement set by the Directive for the chemical involved.

Cd

Sales and Support Information

Customer Care Centre

- For customers within the UK: **0844 844 3852**
- For customers within the Republic of Ireland: **01 289 8333**
- Visit our website for product information **www.panasonic.co.uk**
- E-mail: **customer.care@panasonic.co.uk**

Direct Sales at Panasonic UK

- For customers: **0844 844 3856**
- Order accessory and consumable items for your product with ease and confidence by phoning our Customer Care Centre Monday – Thursday 9:00am – 5:30pm, Friday 9:30am – 5:30pm (Excluding public holidays).
- Or go on line through our Internet Accessory ordering application at **www.panasonic.co.uk**.
- Most major credit and debit cards accepted.
- All enquiries transactions and distribution facilities are provided directly by Panasonic UK Ltd.
- It couldn't be simpler!
- Also available through our Internet is direct shopping for a wide range of finished products, take a browse on our website for further details.

Interested in purchasing an extended guarantee?

Please call 0870 240 6284 or visit www.panasonic.co.uk/guarantee.

GEMSTAR-TV GUIDE INTERNATIONAL, INC. AND/OR ITS RELATED AFFILIATES ARE NOT IN ANY WAY LIABLE FOR THE ACCURACY OF THE PROGRAM SCHEDULE INFORMATION PROVIDED BY THE GUIDE PLUS+ SYSTEM. IN NO EVENT SHALL GEMSTAR-TV GUIDE INTERNATIONAL, INC. AND/OR ITS RELATED AFFILIATES BE LIABLE FOR ANY AMOUNTS REPRESENTING LOSS OF PROFITS, LOSS OF BUSINESS, OR INDIRECT, SPECIAL, OR CONSEQUENTIAL DAMAGES IN CONNECTION WITH THE PROVISION OR USE OF ANY INFORMATION, EQUIPMENT, OR SERVICES RELATING TO THE GUIDE PLUS+ SYSTEM.

<http://www.europe.guideplus.com/>



Trade Mark of the DVB Digital Video Broadcasting Project (1991 to 1996)
TX-P37C10B Declaration of Conformity No. 6185, 5 December 2008
TX-P42C10B Declaration of Conformity No. 6184, 5 December 2008
TX-P50C10B Declaration of Conformity No. 6183, 5 December 2008

Customer's Record

The model number and serial number of this product may be found on its rear panel. You should note this serial number in the space provided below and retain this book, plus your purchase receipt, as a permanent record of your purchase to aid in identification in the event of theft or loss, and for Warranty Service purposes.

Model Number

Serial Number

Panasonic (U. K.) Ltd.

Willoughby Road, Bracknell, Berks RG12 8FP

Web Site : <http://www.panasonic.net>

© Panasonic Corporation 2009

Printed in Czech Republic