

Panasonic®

Operating Instructions Plasma Television

Model No. **TH-50PX60B**

VIERA

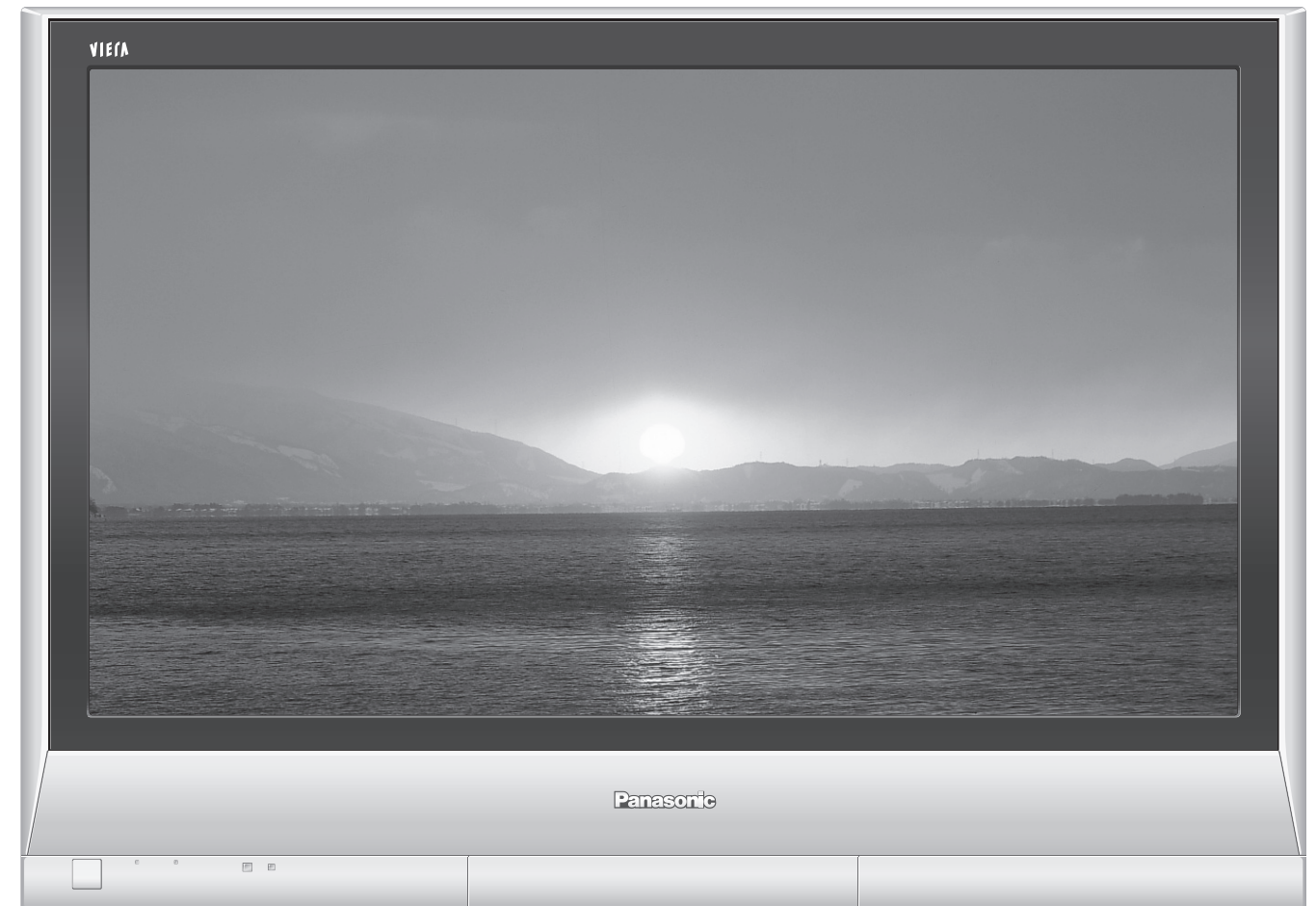

Information on Disposal for Users of Waste Electrical & Electronic Equipment (private households)



This symbol on the products and/or accompanying documents means that used electrical and electronic products should not be mixed with general household waste.

For proper treatment, recovery and recycling, please take these products to designated collection points, where they will be accepted on a free of charge basis. Alternatively, in some countries you may be able to return your products to your local retailer upon the purchase of an equivalent new product.

Disposing of this product correctly will help to save valuable resources and prevent any potential negative effects on human health and the environment which could otherwise arise from inappropriate waste handling. Please contact your local authority for further details of your nearest designated collection point. Penalties may be applicable for incorrect disposal of this waste, in accordance with national legislation.

For business users in the European Union

If you wish to discard electrical and electronic equipment, please contact your dealer or supplier for further information.

Information on Disposal in other Countries outside the European Union

This symbol is only valid in the European Union.

If you wish to discard this product, please contact your local authorities or dealer and ask for the correct method of disposal.

Licence

- Trademark Credits**
- DVB is a trademark of the DVB Digital Video Broadcasting Project (1991 to 1996).
 - VGA is a trademark of International Business Machines Corporation.
 - Macintosh is a registered trademark of Apple Computer, USA.
 - S-VGA is a registered trademark of the Video Electronics Standard Association. Even if no special notation has been made of company or product trademarks, these trademarks have been fully respected.
 - HDMI, the HDMI Logo and High-Definition Multimedia Interface are trademarks or registered trademarks of HDMI Licensing LLC.
 - HDAVI Control™ is a trademark of Matsushita Electric Industrial Co., Ltd.



Trade Mark of the DVB Digital Video Broadcasting Project (1991 to 1996)
TH-50PX60B Declaration of Conformity No 3983, 19th January 2006

Sales and Support Information

Customer Care Centre

- For customers within the UK : **08705 357357**
- For customers within the Republic of Ireland: **01 289 8333**
- Visit our website for product information **www.panasonic.co.uk**
- E-mail: **customer.care@panasonic.co.uk**

Direct Sales at Panasonic UK

- Order accessory and consumable items for your product with ease and confidence by phoning our Customer Care Centre Monday – Thursday 9:00am – 5:30pm, Friday 9:30am – 5:30pm (Excluding public holidays).
- Or go on line through our Internet Accessory ordering application at **www.panasonic.co.uk**.
- Most major credit and debit cards accepted.
- All enquiries transactions and distribution facilities are provided directly by Panasonic UK Ltd.
- It couldn't be simpler!
- Also available through our Internet is direct shopping for a wide range of finished products, take a browse on our website for further details.

Interested in purchasing an extended guarantee?

Please call 0870 240 6284 or visit www.panasonic.co.uk/guarantee.

Customer's Record

The model number and serial number of this product may be found on its rear panel. You should note this serial number in the space provided below and retain this book, plus your purchase receipt, as a permanent record of your purchase to aid in identification in the event of theft or loss, and for Warranty Service purposes.

Model Number _____ Serial Number _____

Panasonic (U. K.) Ltd.

Willoughby Road, Bracknell, Berks RG12 8FP Web Site : <http://www.panasonic-europe.com>

© 2006 Matsushita Electric Industrial Co., Ltd. All Rights Reserved.

Printed in Czech Republic

U.K. Standard

English

Please read these instructions before operating your set and retain them for future reference.
The images shown in this manual are for illustrative purposes only.



TQB0E0317

Turn your living room into a home theatre!

Experience an amazing level of multi-media excitement

■ **Receive terrestrial digital services using an integrated (Digital Video Broadcasting) tuner**

(Display DVB programmes with TV Guide (p. 12) / Timer recording (p. 34) / Register and instantly call up favourite programmes with Profile Edit (p. 26))

■ **Sharp pictures with HDMI terminal**

■ **Control DVD recorder / VCR via TV with Q-Link connection (p. 36)**

■ **Create home theatre and DVD recorder link-ups with "Control with HDMI" without complicated settings!**

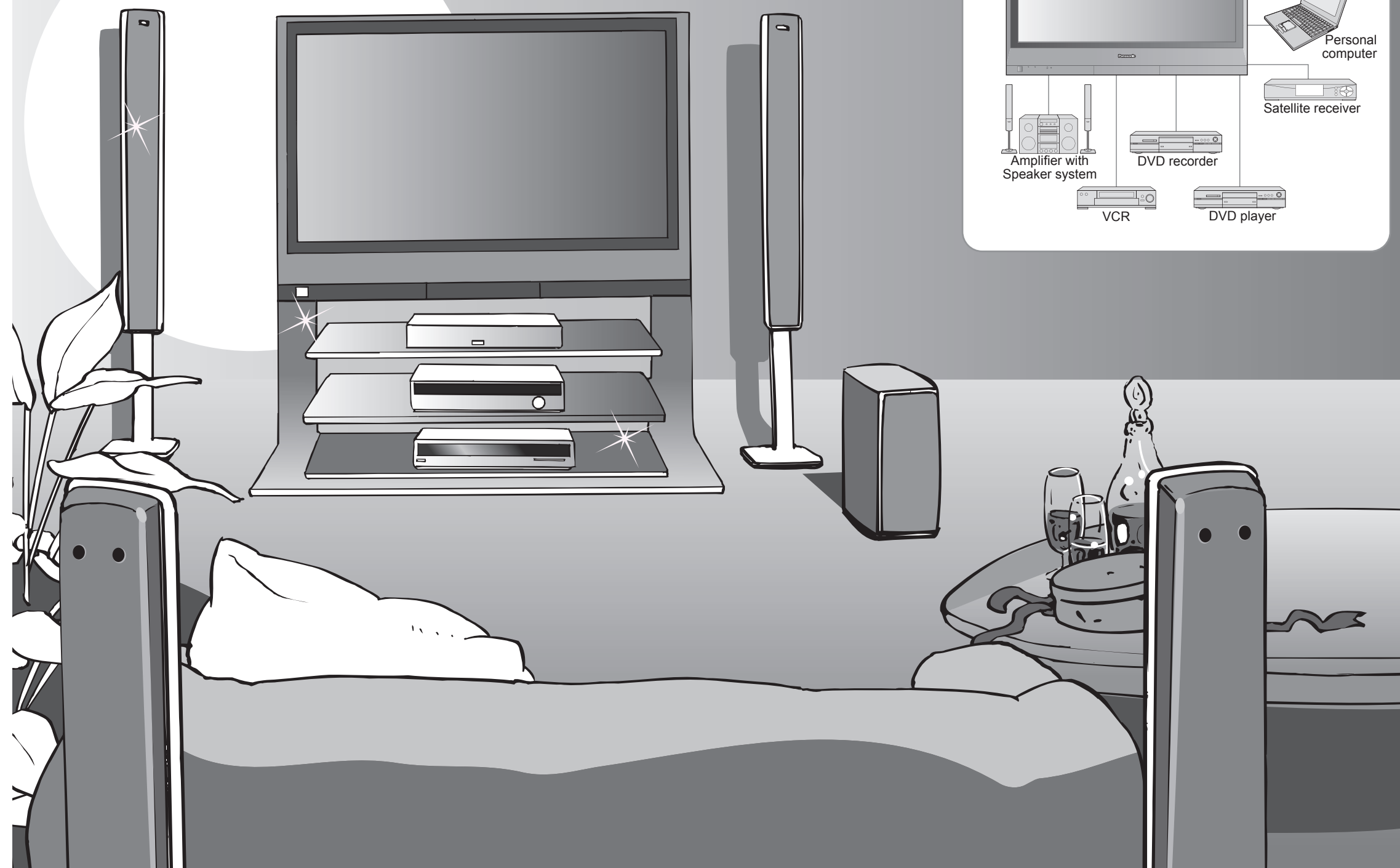

Enjoy rich multi-media

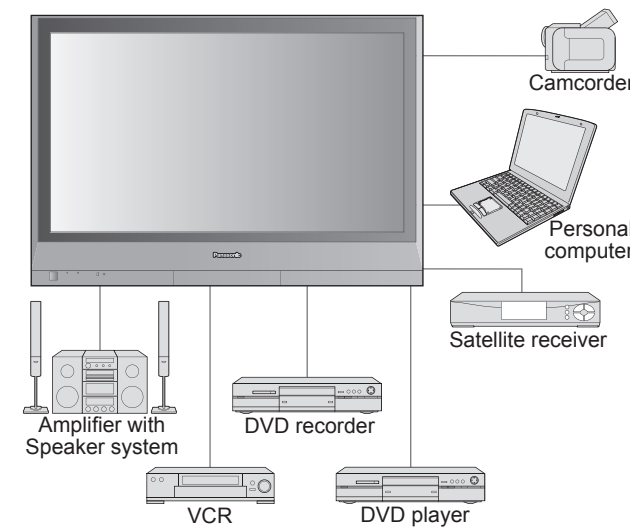

Contents

Be Sure to Read

- Safety Precautions 4
(Warning & Caution)
- Notes 5
- Maintenance 5

Quick Start Guide

- Accessories/Options 6
- Identifying Controls 7
- Basic Connection 8
- Auto Setup 10

Enjoy your TV!

Basic Features

- Watching TV 11
- Using TV Guide (DVB) 12
- Viewing Teletext 14
- Watching VCR, DVD and Satellites 17

Advanced Features

- How to Use Menu Functions 18
(picture, sound quality, etc.)
- DVB Settings (DVB) 24
(pay-TV, subtitles, etc.)
- Profile Edit / Child Lock (DVB) 26
- DVB Tuning Menu (DVB) 28
- Displaying PC Screen on TV 29
- Editing and Setting Channels (Analogue) 30
- Restore Settings 32
- Owner ID 33
- Recording Controls 34
- Q-Link Functions 36
- HDMI Functions 37
- External Equipment 40

FAQs, etc.

- Technical Information 42
- FAQs 44
- On screen messages 46
- Index 47
- Specifications 47
- Licence 48

Safety Precautions

Warning & Caution

Handling the mains plug

- Ensure that the mains plug is easily accessible at all times. The On/Off switch on this model does not fully disconnect the TV from the mains supply. Remove the mains plug from the wall socket when the TV set is not used for a prolonged period of time.
- Ensure the grounding pin on the mains plug is securely connected to prevent electrical shock.
 - An apparatus with CLASS I construction shall be connected to a mains socket outlet with a protective earthing connection.

Note

- If the set is not switched off when the TV station stops transmitting, it will automatically go to standby mode after 30 minutes. This function will operate only in Analogue TV mode.

Power source

- This TV set is designed to operate on 220-240V, 50 / 60 Hz AC.



AC 220-240 V
50 / 60 Hz

Do not expose to direct sunlight and other sources of heat

- Avoid exposing the TV set to direct sunlight and other sources of heat. To prevent fire never place any type of candle or naked flame on top or near the TV set.

IMPORTANT: THE MOULDED MAINS PLUG

FOR YOUR SAFETY, PLEASE READ THE FOLLOWING TEXT CAREFULLY.

This appliance is supplied with a moulded three pin mains plug for your safety and convenience. A 5 amp fuse is fitted in this mains plug. Shall the fuse need to be replaced, please ensure that the replacement fuse has a rating of 5 amps and that it is approved by ASTA or BSI to BS1362.

Check for the ASTA mark  or the BSI mark  on the body of the fuse.

If the mains plug contains a removable fuse cover, you must ensure that it is refitted when the fuse is replaced.

If you lose the fuse cover the mains plug must not be used until a replacement cover is obtained.

A replacement fuse cover may be purchased from your local Panasonic Dealer.

If the fitted moulded mains plug is unsuitable for the socket outlet in your home, then the fuse shall be removed and the mains plug cut off and disposed of safely. There is a danger of severe electrical shock if the cut off mains plug is inserted into any 13 amp socket.

If a new mains plug is to be fitted, please observe the wiring code as shown below.

If in any doubt, please consult a qualified electrician.

WARNING: – THIS APPARATUS MUST BE EARTHED.

IMPORTANT: – The wires in this mains lead are coloured in accordance with the following code: –
Green-and-Yellow: Earth Blue: Neutral Brown: Live

As the colours of the wire in the mains lead of this appliance may not correspond with the coloured markings identifying the terminals in your mains plug, proceed as follows.

The wire which is coloured GREEN-AND-YELLOW must be connected to the terminal in the mains plug which is marked with the letter E or by the Earth symbol  or coloured GREEN or GREEN-AND-YELLOW.

The wire which is coloured BLUE must be connected to the terminal in the mains plug which is marked with the letter N or coloured BLACK.

The wire which is coloured BROWN must be connected to the terminal in the mains plug which is marked with the letter L or coloured RED.

How to replace the fuse.

Open the fuse compartment with a screwdriver and replace the fuse.

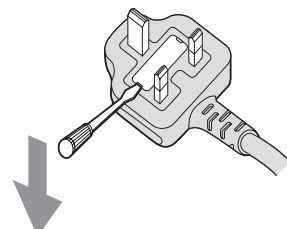

Do not remove the cover

- Do not remove the rear cover as live parts are accessible when it is removed. There are no user serviceable parts inside.

Do not expose to rain or excessive moisture

- To prevent damage which might result in electric shock or fire, do not expose this TV set to rain or excessive moisture. This TV must not be exposed to dripping or splashing water and objects filled with liquid, such as vases, must not be placed on top of or above the TV.

Do not block the rear ventilation openings

- Ventilation should not be impeded by covering the ventilation openings with items such as newspapers, tablecloths and curtains.

Allow sufficient space around the unit for radiated heat

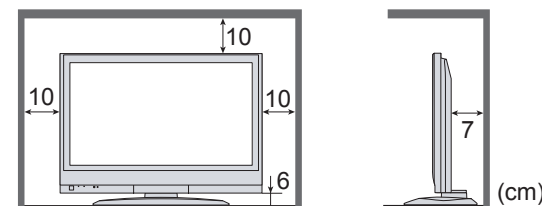

Do not place the TV on sloped or unstable surfaces

- The TV may fall off or tip over.

Use only the dedicated stands / mounting equipment

- Using an unauthorized stand or other fixtures may make the unit shaky, risking injury. Be sure to ask your local Panasonic dealer to perform setup.
- Use optional stands / mounts (p. 6).

Cabinet and display panel care

- Remove the mains plug from the wall socket. The cabinet and display panel can be cleaned with a soft cloth moistened with mild detergent and water. Do not use solutions containing benzol or petroleum. TV sets can produce static electricity, care must be taken whenever touching the TV screen.

Notes

Do not display a still picture for a long time

This causes the image to remain on the plasma screen ("after-image"). This is not considered a malfunction and is not covered by the warranty.

Typical still images

- Channel number and other logos
- Image displayed in 4:3 mode
- Video game
- Computer image



To prevent after-image, the screen saver is automatically activated after a few minutes if no signals are sent or no operations are performed. (p. 44)

Keep the unit away from these equipment

- Electronic equipment
In particular, do not place video equipment near the unit (electromagnetic interference may distort images / sound).
- Equipment with an infrared sensor
This TV also emits infrared rays (this may affect operation of other equipment).

Maintenance

First, remove the mains plug from the socket outlet.

Display panel

Daily care: Gently wipe the surface clean of dirt by using a soft cloth. Major contamination: Wipe the surface clean using a soft cloth dampened with clean water or water containing a small amount of neutral detergent. Then, using a soft dry cloth, evenly wipe the surface clean until it is dry.

Caution

- The surface of the display panel has been specially treated and may be easily damaged. Do not tap or scratch the surface with your fingernail or other hard object.
- Use care not to subject the surface to insect repellent, solvent, thinner, or other volatile substances (this may degrade surface quality).

Cabinet

Daily care: Wipe the surface clean using a soft dry cloth. Major contamination: Dampen a soft cloth with clean water or water containing a small amount of neutral detergent. Then, wring the cloth and wipe the surface clean with it. Finally, wipe the surface clean with a dry cloth.

Caution

- Use care not to subject the TV unit's surfaces to detergent. (A liquid inside the TV unit could lead to product failure.)
- Use care not to subject surfaces to insect repellent, solvent, thinner, or other volatile substances (this may deteriorate the surface by peeling the paint).
- Do not allow the cabinet to make contact with a rubber or PVC substance for a long time.

Mains plug

Wipe the mains plug with a dry cloth at regular intervals. (Moisture and dust may lead to fire or electrical shock.)

Accessories/Options

Standard accessories

- Remote Control Transmitter
- EUR7651080



Check that you have the accessories and items shown

- Batteries for the Remote Control Transmitter (2)
- R6 (UM3)

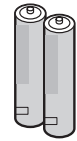

- Operating Instructions
- Pan European Guarantee Card
- 1 Year Guarantee Registration
- CRM (Customer Relationship Management)

- Clamper (2)
- TMME258

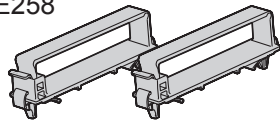

- Mains Lead
- K2CT3DH00018

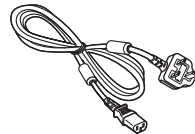

- Ferrite core
- J0KF0000018

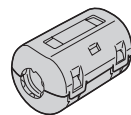

Installing remote's batteries

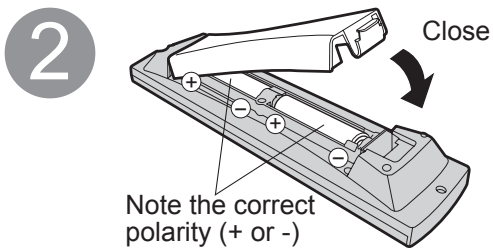
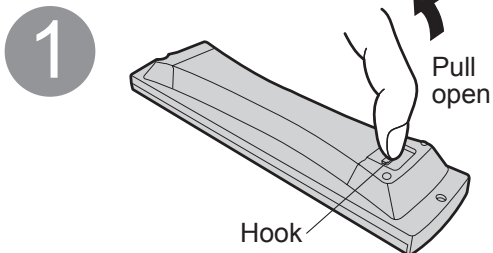

Caution

- Incorrect installation may cause battery leakage and corrosion, resulting in damage to the remote control unit.
- Do not mix old and new batteries.
- Do not mix different battery types (such as alkaline and manganese batteries).
- Do not use rechargeable (Ni-Cd) batteries.
- Do not burn or breakup batteries.

Attaching the cable clampers

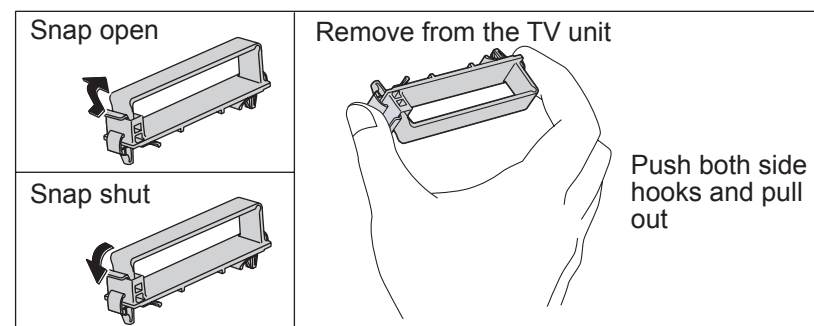
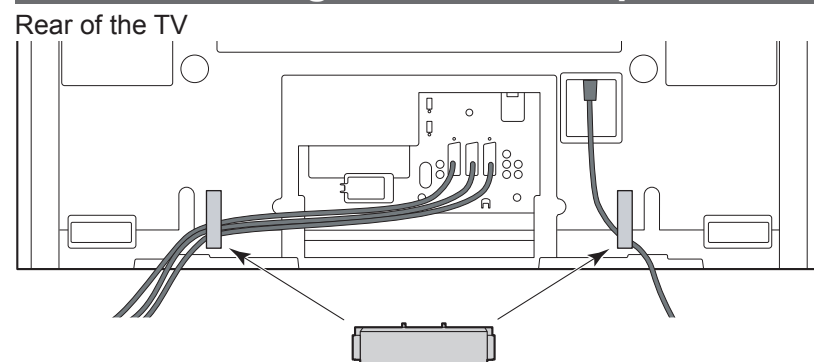

- Do not bundle the RF cable and mains lead together (could cause distorted image).
- Fix cables with clampers as necessary.
- When using the optional accessory, follow the option's assembly manual to fix cables.

Optional accessories

- Pedestal
- TY-ST50P600W

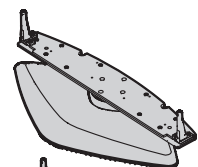

- Plasma TV stand
- TY-S50PX60W

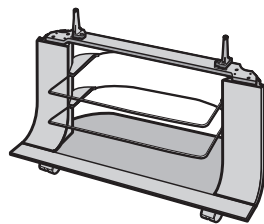

- Wall-hanging bracket (vertical)
- TY-WK42PV3W

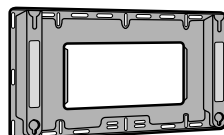

- (angle)
- TY-WK42PR2W

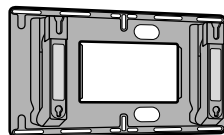

Caution

- In order to maintain the unit's performance and safety, be absolutely sure to ask your dealer or a licenced contractor to secure the wall-hanging brackets.
- Carefully read the instructions accompanying the plasma TV stand or pedestal, and be absolutely sure to take steps to prevent the TV from tipping over.
- Handle the TV carefully during installation since subjecting it to impact or other forces may cause product damage.

Identifying Controls

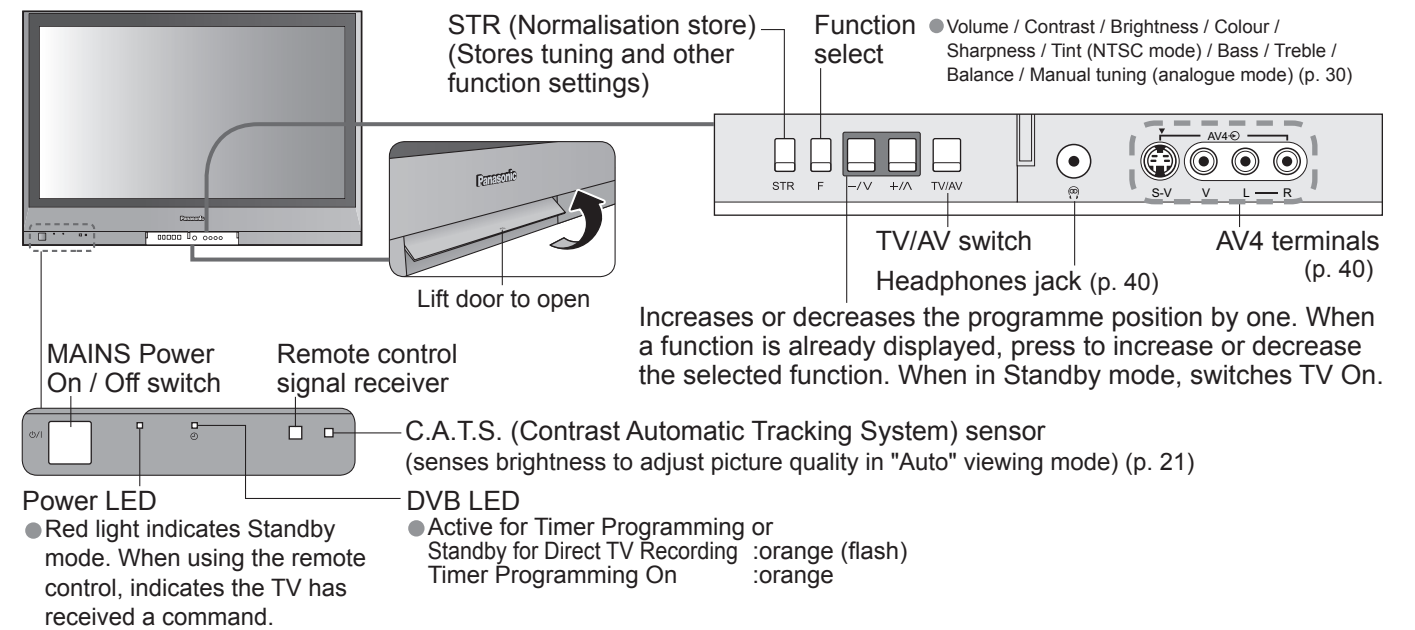

OK button to confirm selections and choices. Press after selecting programme positions 1 - 99 (0 - 9 in Analogue mode) to avoid delay.

Standby On / Off switch (Switches TV On or Off standby)

TV Guide (p. 12)

MENU Press to access the Picture, Sound and Setup menus (p. 20 and p. 22)

Teletext (p. 14)

Subtitles (p. 11) (To view subtitles)

Programme / channel change buttons (0-9) and Teletext page buttons. (p. 11 and p. 14) When in Standby mode, switches TV On.

Direct channel access Use together with numeric buttons to access analogue TV channels by entering UHF broadcast channel number. (p. 11)

Selects programmes in sequence

Normalises (p. 20) (Resets all settings to their default levels)

Changes picture aspect ratio (p. 11)

Switches DVB (digital broadcasting) / Analogue mode (p. 11)

DIRECT TV Recording To immediately record programme in VCR / DVD recorder with Q-Link connection (p. 36)

Switch between viewing TV or AV input. (p. 17)

Cursor buttons to make selections and adjustments

EXIT (Returns to TV screen)

Coloured buttons used for the selection, navigation and operation of various functions.

Still Picture (p. 11)

Teletext Index (p. 16)

Programme Information (p. 11)

Volume

Sound mute On / Off

VCR / DVD operations (p. 17)

ASPECT

REC VCR DVD

PROGRAMME

Panasonic IDTV

Basic Connection

External equipment and cables shown are not supplied with this TV.
Please ensure that the TV is disconnected from the mains socket before attaching or disconnecting any leads.

Ex. 1 Connecting aerial (TV only)

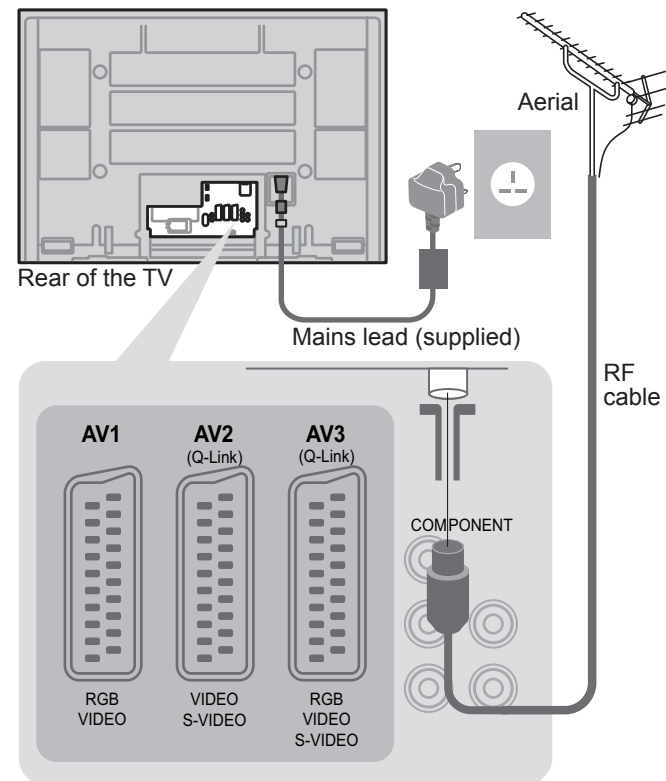

Ex. 2 Connecting DVD Recorder (VCR) (TV, DVD Recorder and VCR)

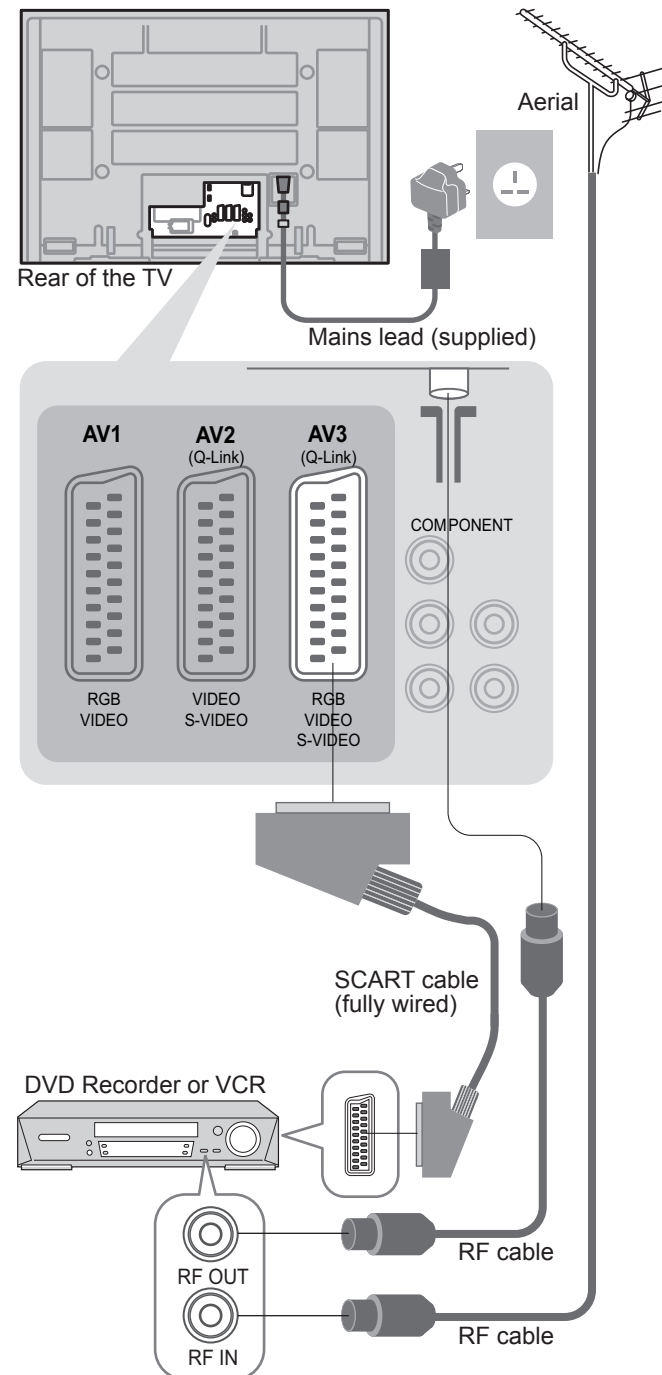

Ex. 3 Connecting DVD Recorder (VCR) and Satellite receiver (TV, DVD Recorder, VCR and satellite)

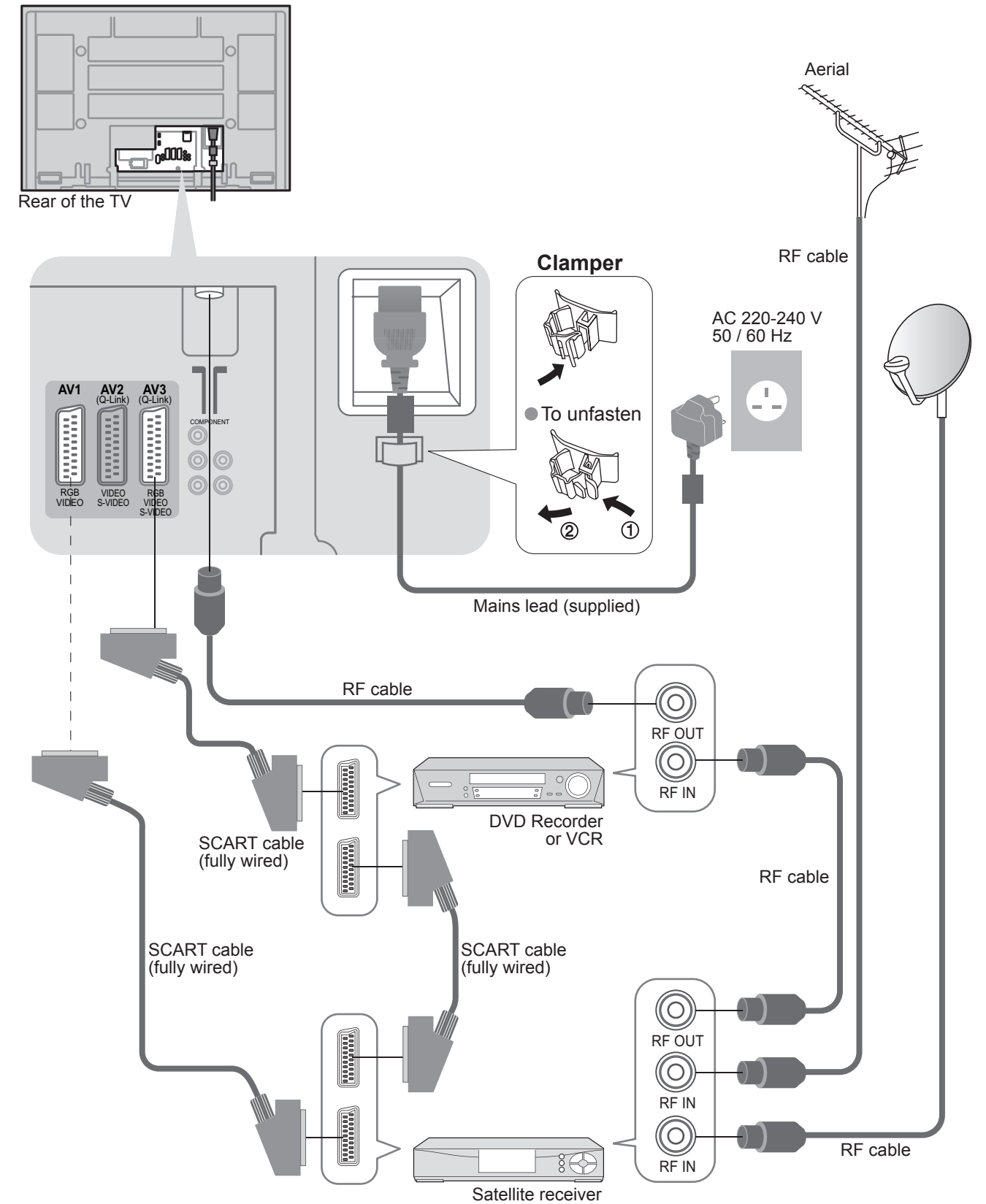

Note

- Connect to AV3 for a DVD Recorder / VCR supporting Q-Link (p. 36).
 - Connect to AV1 for a Satellite receiver.
 - If connecting the TV and Satellite receiver with SCART cable, you can watch satellite broadcast by RGB input signal.
- SCART: 21 pin connection used for video, audio and switching signals (Also known as Euro SCART and Peritel)
- RF: Radio Frequency - Signal received from terrestrial aerial.
- RGB / S-Video / Video: Choose between these three video formats depending on personal preference and equipment requirement. (RGB - Red, Green and Blue)
- VCR: Video Cassette Recorder

Auto Setup

Search and store TV channels automatically. These steps are not necessary if the setup has been completed by your local dealer.

1 Plug the TV into mains socket and switch On (Takes a few seconds to be displayed)

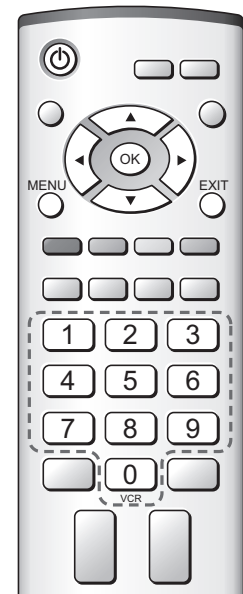
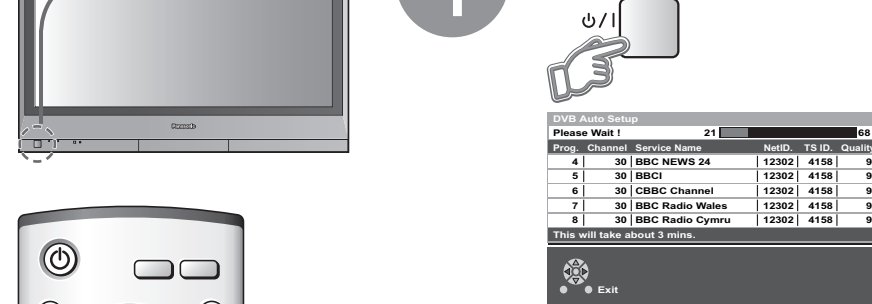

- You can now use the remote control to turn On the unit or turn the unit to standby mode. (Power LED: On)

- Auto Setup will start to search for TV channels and store them.

- The sorted programme order depends upon the TV signal, the broadcasting system and reception conditions.

- If a compatible recording equipment with Q-Link or similar technologies (p. 36) is connected, analogue channel information is automatically downloaded to the equipment.

2 When inputting owner ID

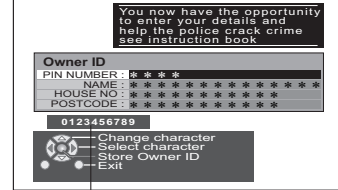

Following the on-screen operation guide, enter your own choice of PIN number, name, etc.

- For detailed procedures → "Owner ID" (p. 33)
- Make a note of the PIN number in case you forget it.

Usable characters and numbers

When inputting owner ID later



- If you input the ID later → "Owner ID" (p. 33)

Auto Setup is now complete and your TV is ready for viewing.



- To check programme list at-a-glance → TV Guide (DVB) (p. 12) → Programme Guide (Analogue) (p. 13)
- To edit analogue channels → "Programme edit" (p. 31)

Watching TV

1 Turn power on (Press for about 1 second)

2 Select DVB (Digital Video Broadcasting) or Analogue

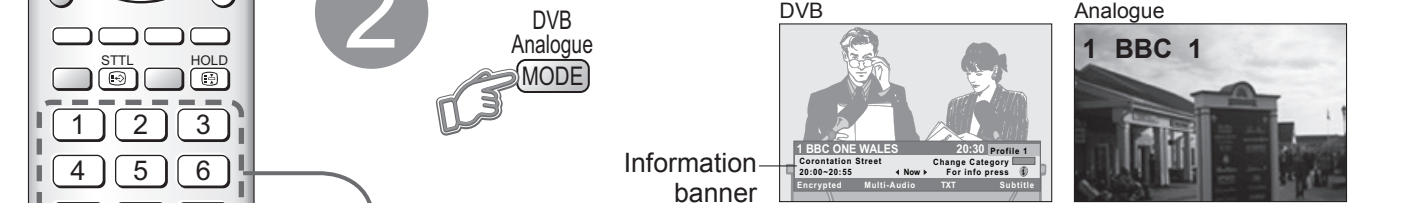

3 Select a channel

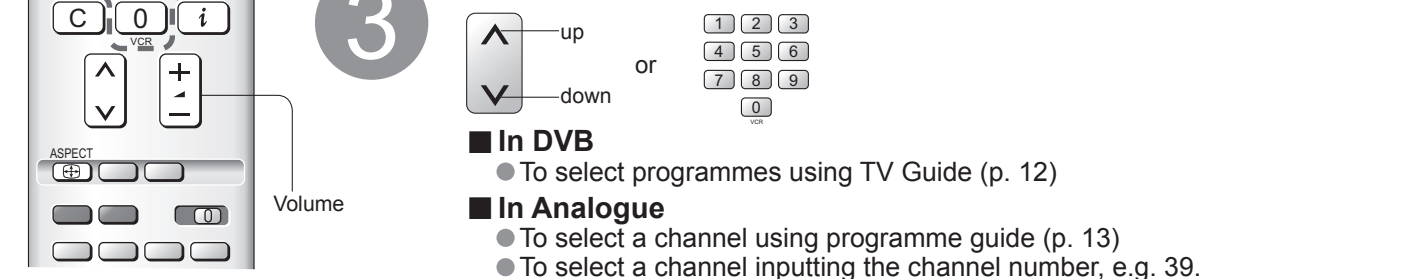

- In DVB**
 - To select programmes using TV Guide (p. 12)
- In Analogue**
 - To select a channel using programme guide (p. 13)
 - To select a channel inputting the channel number, e.g. 39. → C → 3 → 9

Other useful functions (Operate after 3)

Hold	Freeze / unfreeze picture	HOLD	
Display subtitles	Display / hide subtitles (if available)	STTL	
Display information banner	Display programme information	i	
Change aspect ratio	Change the aspect ratio	ASPECT	

- Note**
- If tuning and downloading data have failed, perform "Auto Setup" (p. 31).
 - If you turned the TV Off during Standby mode last time, the TV will be in Standby mode when you turn the TV On with MAINS power On / Off switch.

Many features available on this TV can be accessed via the On Screen Display menu.

How to use remote control

- MENU: used to open the main menus and to return to the previous menu
- Directional arrows: used to move the cursor and select menus
- Directional arrows: used to access menus, adjust levels or to select from a range of options
- OK: used to store settings after adjustments have been made or options have been set
- EXIT: used to exit the menu system and return to the normal viewing screen

ON SCREEN HELP Instructions box (example: Owner ID)

You now have the opportunity to enter your details and help the police crack crime see instruction book

Owner ID
PIN NUMBER: * * * *
NAME: * * * * *
HOUSE NO: * * * * *
POSTCODE: * * * * *

0123456789

Change character
Select character
Store Owner ID
Exit

On-screen operation guide will help you.

Using TV Guide (DVB mode)

TV Guide—Electronic Programme Guide (EPG) provides an on-screen listing of programmes currently broadcast and future broadcasts over the next seven days (depending on the broadcaster).

1 DVB Analogue MODE

2 GUIDE

If in Analogue mode
Select DVB

View TV Guide (landscape or portrait)
View "Portrait" to see one channel at a time
View "Landscape" to see many channels

Programme Current date and time (TV Guide start page)

DVB TV Guide: Landscape Thu 05/08/04 18:50				
Fri 6th	Category	Prog. type		
All Services All Types				
20:00-20:30	DIY SOS: We open in the Battersdys			
Time: 19:30	20:00	20:30	21:00	21:30
1 BBC1	Eastender	DIY SOS	The Bill	Red Cap
2 BBC2	Hot Wars	Holiday Program So		
21 ITV1	Emmerdal.	Coronation Street	The Bill	
44 Channel4	10 O' clock News BBC	Pepsi Char.	Good bye	Hell
122 five	Panorama	Sex And The City	Terminator	
142 ITV2	I'm A Celebrity	Pop Idol	News	The
144 SC4	Rugby	15 To1	The Bill	

TV Guide date
TV Guide time
Channel

Landscape (Displays by broadcaster)

Change display mode
Select channel
Select Programme
Timer Programming
Exit

Page up
Page down

-24 Hr +24 Hr Category Prog. type

To change the layout
→ GUIDE
(Landscape / Portrait)

To return to TV
→ EXIT

To previous day
→ red

To next day
→ green

To view a programme list of the selected category
→ yellow

To view a programme list of the selected type
→ blue

Portrait (Displays by broadcaster)

DVB TV Guide: Portrait Wed 12/05/04 10:46				
Wed 12th	Category	Prog. type		
All Services All Types				
1 BBC1	2 BBC2	44 Channel4	444 SC4	
19:30-20:00	Eastender			
20:00-20:30	DIY SOS			
20:30-21:00	The Bill			
21:00-22:00	Red Cap			
22:00-22:30	Live junction			
22:30-23:00	POP 100			
23:00-23:10	Cinema info			
23:10-00:00	Sports			

Change display mode
Select channel
Select Programme
Timer Programming
Exit

Page up
Page down

+24 Hr Category Prog. type

To list favourite channels (p. 27)
① select category
② view

Category	All Services			
All Services				
Free TV				
Pay TV				
Radio				
Information				
Profile 1				
Profile 2				
Profile 3				
Profile 4				

To list favourite channels (p. 27)
① select type
② view

Prog. type	All Types			
All Types				
Movies				
News				
Entertainment				
Sport				
Children's				
Education				
Lifestyle				
Drama				

Other useful functions (Operate after 2)

View details of the programme
select → Details → i

Watch the programme
① select → (TV screen)
② watch

Timer programming to record
① select → (Timer Programming screen)
② set

To return to the start page
→ i

To return to TV Guide
→ MENU

To check / change / cancel a timer programming event
→ "Timer Programming" (p. 34)

DVB LED
● Orange DVB LED (Rapid blinking during recording)

Note

- When this TV unit is turned on for the first time, or the unit is switched off for more than a week, it may take some time before the TV Guide is completely shown.
- When recording programmes, you must make the proper settings on the external recording equipment connected to the unit. If a compatible recording equipment with Q-Link or similar technologies is connected to the unit (p. 8) and the "Q-Link" settings (p. 23) are completed, no setting of the equipment is required.
- Also read the manual of the recording equipment.

In Analogue – Analogue Programme Guide (Analogue mode)

The Analogue Programme Guide shows channel list only. (No programme info in Analogue mode)

① If in DVB mode
Select Analogue



② View a channel list



③ Select the channel and watch

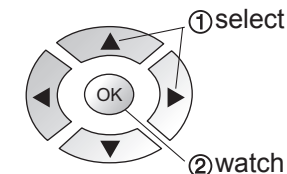

(Analogue mode)

Prog.	Name	Chan.	Prog.	Name	Chan.
VCR :		CH21	13		--
1	BBC1	CH44	14		--
2	BBC2	CH51	15		--
3	ITV	CH41	16		--
4	S4C	CH47	17		--
5		CH23	18		--
6		CH26	19		--
7		CH58	20		--
8			21		--
9			22		--
10			23		--
11			24		--
12					--

To change pages



Viewing Teletext

You can enjoy news, weather forecasts and subtitles, etc. (depending on the broadcaster)

DVB (digital broadcasting) mode

DVB teletext services

DVB teletext services differ greatly from analogue teletext. When you switch to a DVB teletext service, the images you see can contain graphics and text, laid out and controlled in a manner decided by the broadcaster.

- You can check if the programme has teletext information.

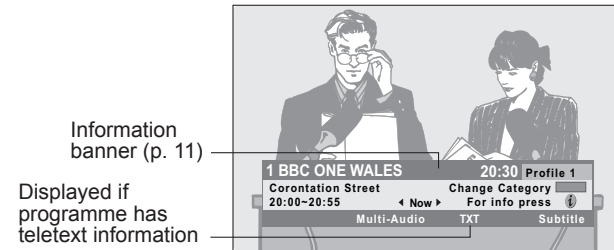

Information banner (p. 11)
Displayed if programme has teletext information

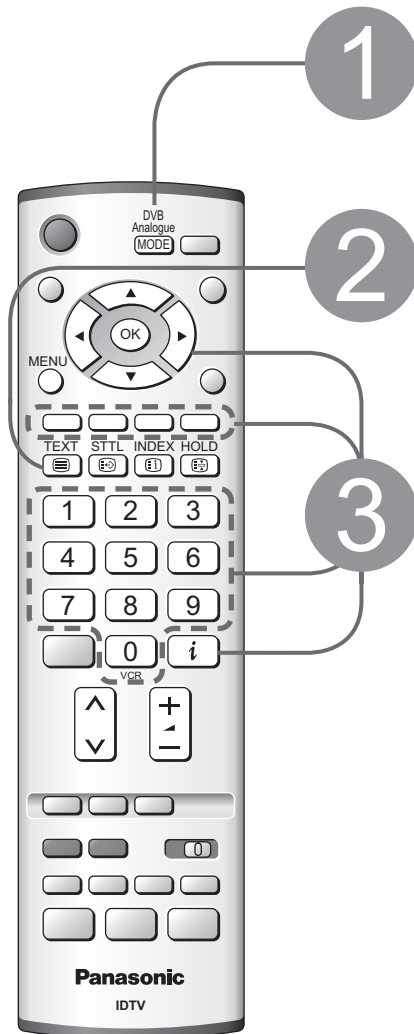

1 If in Analogue mode
Select DVB



2 **Switch to Teletext**

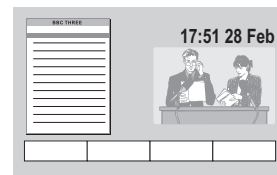

- If cannot be switched to Teletext, set Subtitles OFF. (p. 11)

How to use

In all cases, it is possible to navigate the pages using buttons on the remote control, but because the commands available must apply to all manufacturers of DVB equipment, some on screen commands may not correspond exactly to the remote control buttons. For example:

- When "select" or "go" is displayed →
- When "◀", "▶", "▲", "▼" symbol is displayed →
- When the key words are displayed on colour bar →
- When options with numbers are displayed →
- When "i" is displayed → (information)

■ **To return to TV** →

Note

- As soon as you switch to a DVB channel with links to a teletext service, software is downloaded in the background to enable the teletext function. This means that when switching to a DVB channel, you should wait for approximately 5 seconds before pressing the TEXT button - this will allow the software to download. If you press the TEXT button before download is complete, there will be a short delay before the text screen is displayed.
- While navigating DVB teletext, you will find there is a short delay when moving between pages while the page downloads. There is often a prompt shown somewhere on the page (for example "Loading") to let you know that this is happening.

■ **To change the channel**



Analogue mode

What is FASTEXT mode (default)?

In FASTEXT mode, four differently coloured subjects are situated at the bottom of the screen. To access more information about one of these subjects, press the appropriately coloured button. This facility enables fast access to information on the subjects shown.

What is List mode?

In List mode, four differently coloured page numbers are situated at the bottom of the screen. Each of these numbers can be altered and stored in the TV's memory. ("Store Frequently viewed pages", p. 16)

■ **To change mode** → "Teletext" in Setup menu (p. 23)

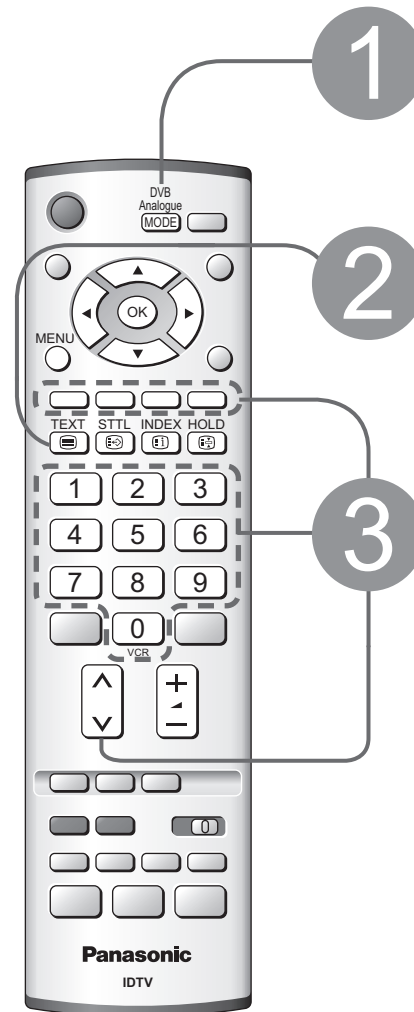

1 If in DVB mode
Select Analogue



2 **Switch to Teletext**



- Displays the index page (content varies depending on the broadcasters)

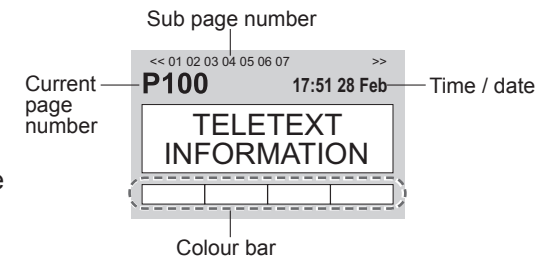

3 **Select the page**

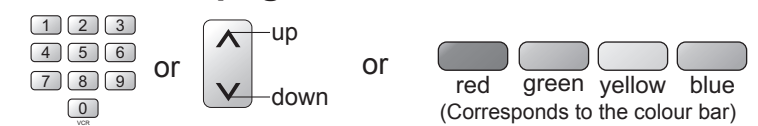

■ **To adjust contrast** → (Press twice) →

■ **To return to TV** → (Press twice)
● Press once to have picture and text. Press again to return to TV.

Using Analogue teletext

Reveal hidden data	Reveal hidden words e.g. quiz page answers MENU → ● Re-hide →
FULL / TOP / BOTTOM	MENU → (Expand the BOTTOM half)

(Continued)

Viewing Teletext (Continued)

Analogue mode

Using Analogue teletext (Continued)

HOLD	If you wish to hold the current page without updating Stop automatic updating HOLD ■ To resume → HOLD
INDEX	Return to the main index page INDEX ● FASTEXT mode only
Subtitles	View subtitles by pressing STTL button STTL ● Factory setting is "P888" (subtitle service) on blue button.
View in multi window	Watch TV and Teletext in two windows at once TEXT ● Operations can be made only in Teletext screen. ● Each time pressed: Teletext → TV and Teletext ← TV ←
Store frequently viewed pages	Store frequently viewed pages (only on first 25 channels on Programme Guide) in the colour bar (List mode only) As page is displayed → press and hold ● If you wish to use Subtitles, do not change number on blue button. ● To change stored pages Enter new page number → → press and hold The number changes to white.
View sub page	View sub page (Only when teletext is more than one page) → Appears at top of the screen ● To view specific sub page MENU → → Enter the 4-digit number example: P6 → → press and hold ● Sub pages: The number of sub pages varies depending on the broadcasters (up to 79 pages). It may take some time for searching, during which time you can watch TV.
Watch TV while waiting for update	View the TV picture while searching for a teletext page Teletext automatically updates itself when new information becomes available. Changes to TV screen temporarily MENU → → Appears when updating is completed → → View the updated page (You cannot change the channel.) ● The news page provides a function that indicates arrival of latest news ("News Flash").

Watching VCR, DVD and Satellites

The Remote Control is capable of operating some functions of selected Panasonic VCRs and DVD (Digital Versatile Disc) equipment.
Connect the Satellite receiver and you can watch satellite broadcasts.
To connect the equipment (p. 8 and p. 9)

- Turn the TV on**
 ■ When connecting with SCART as example 2 or 3 (p. 8 and p. 9)
 → Receives input signals automatically when playback starts or satellite receiver is switched on
 ● Input signals are automatically identified by the SCART (pin 8) terminal.
 ● This function will be available for HDMI connection too (p. 37).
 ■ If input mode is not switched automatically
 → Perform 2 and 3
 ● Dependant on DVD/VCR setup
- Select the external input**
 TV/AV
 (AV mode screen)

Terminal	AV1	AV2	AV3	AV4	Component	PC	HDMI1	HDMI2
Manual input selection	AV1	AV2 AV2S (S-video input)	AV3 AV3S (S-video input)	AV4 AV4S (S-video input)	Component	PC	HDMI1	HDMI2
Auto input selection	EC1/RGB AV1/RGB (RGB input)	EC2	EC3/RGB AV3/RGB (RGB input)	—	—	—	EC/ HDMI1	HDMI2
- Select the connector connected to the equipment**
 Displays the selected connector
 AV2 → → HDMI1
 → → → → → →
 AV1 AV2/ S-video AV3/ S-video AV4/ Component/ HDMI1/ S-video PC HDMI2
 ● example: AV1 → → → → (twice)
 ● When colour bar disappears → Press any coloured buttons
 ● You can also select the connector using the TV/AV button on the front panel of the TV. Press the button repeatedly until you reach the connector to view.
Note
 ● If the external equipment has an aspect adjustment function, set to "16:9".
 ● For details, see the manual of the equipment or ask your local dealer.
 ● HDMI (p. 37)

■ To return to TV
 TV/AV

Some Panasonic VCR and DVD equipment connected to the TV unit can be directly operated with the remote control.

	VCR / DVD switch Select VCR / DVD		Fast-forward / Skip / Search VCR: Fast-forward, view the picture rapidly forward DVD: Skip to the next track or title Press and hold to search forward
	Standby Set to Standby mode / Turn on		Pause Pause / Restart DVD: Press and hold to play at slow speed
	Play Playback videocassette / DVD		Programme Up / Down Select programme
	Stop Stop the operations		Record Start recording
	Rewind / Skip / Search VCR: Rewind, view the picture rapidly in reverse DVD: Skip to the previous track or title Press and hold to search backward		

How to Use Menu Functions

● How to operate (p. 20 and p. 22)

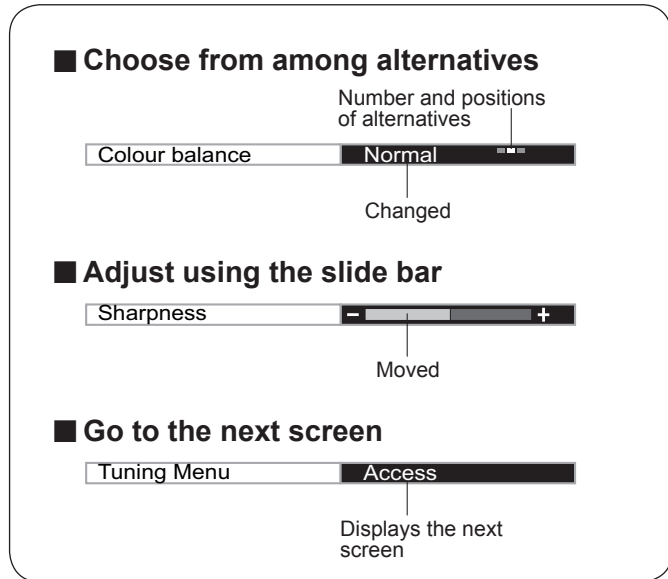
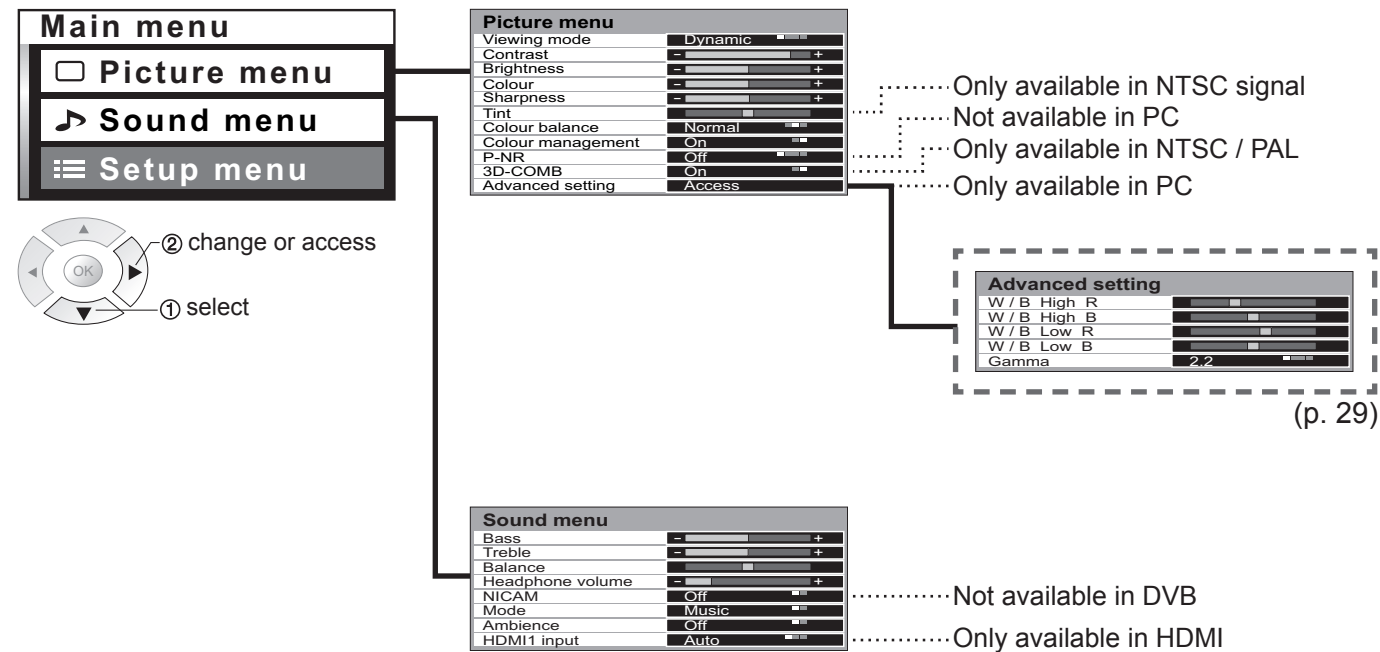

NTSC (National Television System Committee): One of television signal used in USA, etc.
 HD signal: High-definition signal

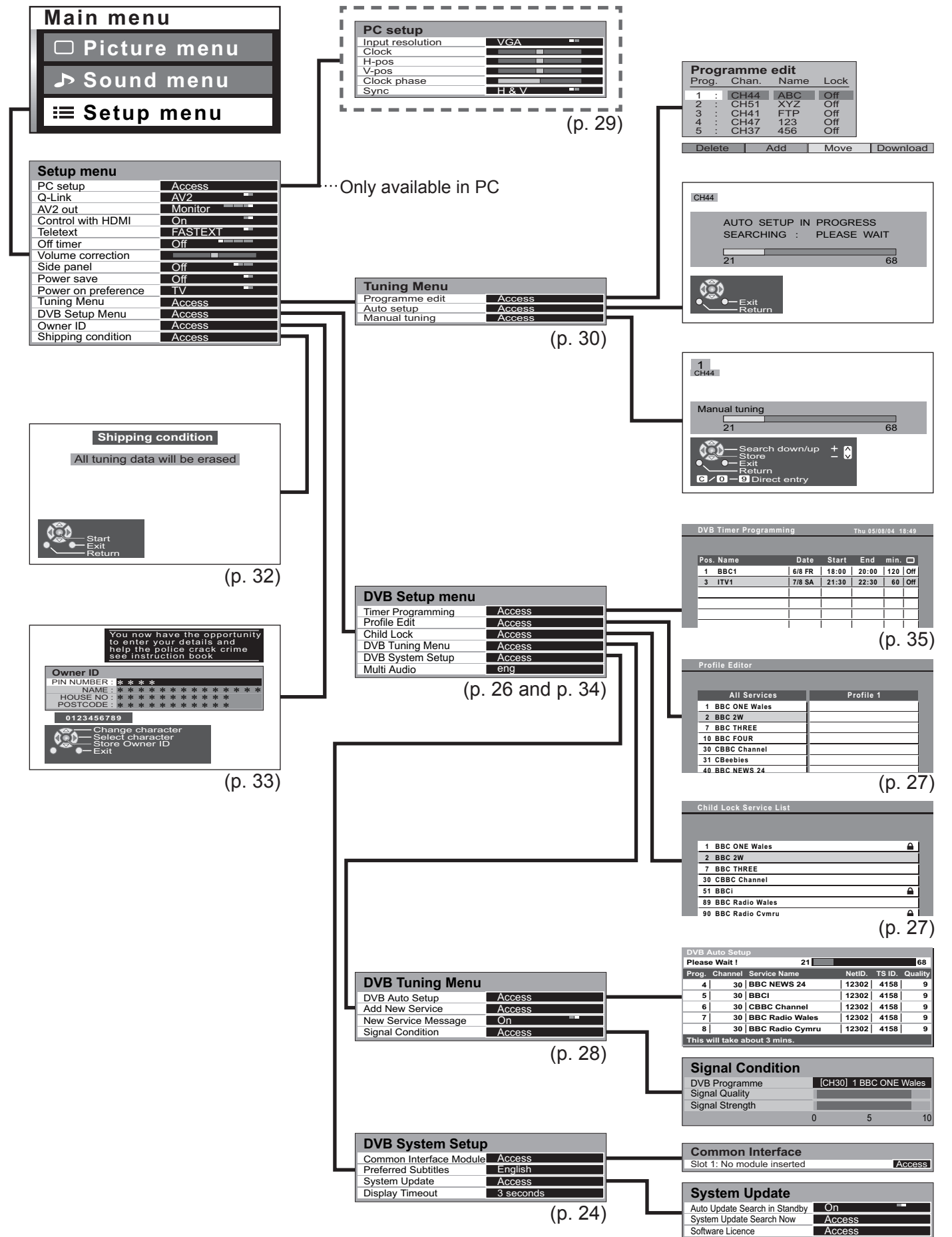

● How to Use Menu Functions (picture, sound quality, etc.)

Advanced

How to Use Menu Functions

Various menus allow you to make settings for the picture, sound, and other functions.

● Setup menu (p. 22)

1 Display menu
 MENU ● Displays the functions that can be set (varies according to the input signal)

2 Select the menu
 Main menu
 □ Picture menu
 ▶ Sound menu
 ≡ Setup menu
 (example: Picture menu)

3 Select the item
 Picture menu
 Viewing mode: Dynamic
 Contrast: [bar]
 Brightness: [bar]
 Colour: [bar]
 Sharpness: [bar]
 Tint: [bar]
 Colour balance: Normal
 Colour management: On
 P-NR: Off
 3D-COMB: On
 (example: Picture menu)

4 Adjust or select
 Picture menu
 Viewing mode: Dynamic
 Contrast: [bar] +
 Brightness: [bar] +
 Colour: [bar] +
 Sharpness: [bar] +
 Tint: [bar]
 Colour balance: Normal
 Colour management: On
 P-NR: Off
 3D-COMB: On
 (example: Picture menu)

■ To return to TV at any time



■ To return to the previous screen



Note

- To initialize all settings
 ▶ "Shipping condition" (p. 32).

■ Choose from among alternatives

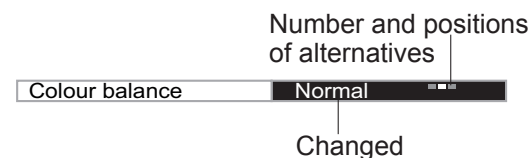

■ Adjust using the slide bar



■ To reset the setting



- Resets each Viewing mode (Dynamic / Normal / Cinema) to the default settings.
 P-NR in Picture menu is reset to off.
- Aspect mode is also reset to Auto aspect.

■ Menu list

Menu	Item	Adjustments / Configurations (alternatives)	
Picture menu	Viewing mode	Selects four different screen settings (Dynamic / Normal / Cinema / Auto) In each Viewing mode setting, Contrast, Brightness, Colour, Sharpness, Tint (in NTSC only), Colour balance, Colour management and 3D-COMB can be adjusted and stored to suit your particular viewing requirement (e.g., you may require different settings for viewing sports, films, news etc.) Changes to any settings in a viewing mode will affect all signal sources: RF, AV1, AV2, AV3, AV4, Component, PC and HDMI Changes will be stored automatically. By analysing and processing the incoming picture, all four modes feature automatic enhancement	
	Adjust by each viewing mode	Contrast Brightness Colour Sharpness	Increases or decreases the levels of these options according to your personal preference
		Tint	With an NTSC signal source connected to the TV, the picture hue can be adjusted to suit your taste
		Colour balance	Allows you to set the overall colour tone of the picture (Cool / Normal / Warm)
		Colour management	Automatically adjusts colours to vivid ones (Off / On)
		P-NR	Picture Noise Reduction Automatically reduces unwanted picture noise (Off / Min / Mid / Max) ● Not valid on PC signal
3D-COMB	Occasionally, whilst viewing still or slow moving pictures, colour patterning may be seen Set to On to display sharper and more accurate colours (Off / On) ● For PAL or NTSC signal reception only ● Not valid on RGB, S-Video, components, PC and HDMI ● Analogue mode only		
Sound menu	Bass	Increases or decreases level to enhance or minimise lower, deeper sound output	
	Treble	Increases or decreases level to enhance or minimise sharper, higher sound output	
	Balance	Adjusts volume level of right and left speakers	
	Headphone volume	Adjusts the volume of the headphones	
	NICAM	NICAM (Near Instantaneous Companded Audio Multiplex) A format for digital sound over television Reproduces stereo sound (Off / On) ● Off if reception is poor (FM monaural sound) ● Analogue mode only	
	Mode	Sound quality can be improved when watching music scene or drama (Music / Speech)	
	Ambience	Provides a dynamic enhancer to simulate improved spatial effects (Off / On)	
	HDMI1 input	Select to fit the input signal (Auto / Digital / Analogue) (p. 37) Auto : Automatic detection of digital or analogue sound source Digital : HDMI cable connection Analogue : HDMI-DVI adapter cable connection ● HDMI input mode only ● HDMI2 terminal is for digital signal only ● No setting for HDMI2 available	

- A different menu will be displayed while PC is used. (p. 29)
- In AV mode, the Sound menu gives a reduced number of options.

How to Use Menu Functions

● Picture menu, Sound menu (p. 20)

1 Display menu
 MENU ● Displays the functions that can be set (varies according to the input signal)

2 Select "Setup menu"
Main menu
 □ Picture menu
 ▶ Sound menu
 ≡ Setup menu
 ① select
 ② access

3 Select the item
Setup menu
 Q-Link AV2
 AV2 out Monitor
 Control with HDMI On
 Teletext FASTEXT
 Off timer Off
 Side panel Off
 Power save Off
 Power on preference TV
 Tuning Menu
 Owner ID
 Shipping condition
 select

4 Adjust or select
 ① change or access
 ② store (Required by some functions)

■ To return to TV at any time



■ To return to the previous screen



Note

- To initialize all settings
 → "Shipping condition" (p. 32).

■ Choose from among alternatives

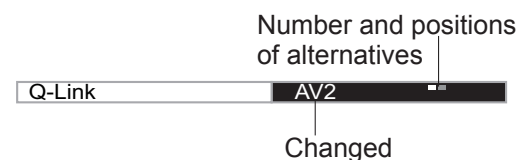

■ Go to the next screen

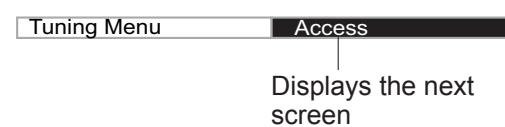

■ Menu list

Menu	Item	Adjustments / Configurations (alternatives)
Setup menu	Q-Link	Selects which AV terminal is to be used for data communication between this TV and a compatible recording equipment (AV2 / AV3) (p. 36)
	AV2/AV3 out	Chooses the signal to be transmitted from the TV to Q-Link (Analogue / DVB / AV1 / AV2 / AV3 / AV4 / Monitor) ● Monitor: Image displayed on screen ● Component, PC and HDMI signals cannot be outputted
	Control with HDMI	Control with HDMI function (Off / On) (p. 38)
	Teletext	Analogue teletext display mode (FASTEXT / List) (p. 14)
	Off timer	Sets the time the unit automatically turns Off. (Off / 15 / 30 / 45 / 60 / 75 / 90) (minutes)
	Volume correction	Adjusts volume for AV, PC and HDMI mode
	Side panel	Increases the brightness of the side panel (Off / Low / Mid / High) ● The recommended setting is "High" to prevent panel "after-image"
	Power save	Reduces brightness of picture to economise on power consumption (Off / On)
	Power on preference	Set to "TV" to view picture from TV tuner. Set to "AV" to view input from an external equipment connected to a SCART terminal, e.g. satellite receiver (TV / AV) ● The external equipment must be switched on and sending a control signal for automatic switching at power on to occur
	Tuning Menu	Edits or sets channels (Analogue) (p. 30)
DVB Setup Menu	Timer Programming	Records future programmes (p. 34)
	Profile Edit	Creates list of favourite programmes (p. 27)
	Child Lock	Locks a DVB programme channel to prevent access to it (p. 27)
	DVB Tuning Menu	Auto Setup, Add New Service, New Service Message, Signal Condition (p. 28)
	DVB System Setup	Common Interface Module, Preferred Subtitles, System Update, Display Timeout (p. 24)
	Multi Audio	Chooses the sub voice for watching DVB (Alternatives vary depending on the broadcaster)
	Owner ID	Inputs the owner ID (p. 33)
	Shipping condition	Resets all settings, for example, when moving (p. 32)

- A different menu will be displayed while PC is used. (p. 29)
- In AV mode, the Setup menu gives a reduced number of options.

DVB Settings (DVB mode)

The "DVB Setup Menu" provides access to various advanced features.

- 1** If in Analogue mode
Select DVB
DVB Analogue (MODE)
- 2** **Display the menu**
MENU
- 3** **Select "Setup menu"**
Main menu
Picture menu
Sound menu
Setup menu
- 4** **Select "DVB Setup Menu"**
Setup menu
Q-Link AV2
AV2 out Monitor
Control with HDMI On
Off timer Off
Side panel Off
Power save Off
Power on preference TV
DVB Setup Menu Access
Owner ID
Shipping condition
- 5** **Select "DVB System Setup"**
DVB Setup menu
Timer Programming
Profile Edit
Child Lock
DVB Tuning Menu
DVB System Setup Access
Multi Audio eng
- 6** **Select a function and set**
- 7** **Store**
OK

■ To return to TV
EXIT

● If you exit after ⑥, the setting is not stored after turning off the unit.

The Common Interface Module menu provides access to software contained on Common Interface (CI) Modules.

① **Insert the CI module (optional)** (Rear of the TV)

Caution

- Turn Off MAINS power On / Off switch whenever inserting or removing the CI module.
- If a view card and a card reader come as a set, first insert the card reader, then insert the view card into the card reader.
- Do not insert the module up side down.

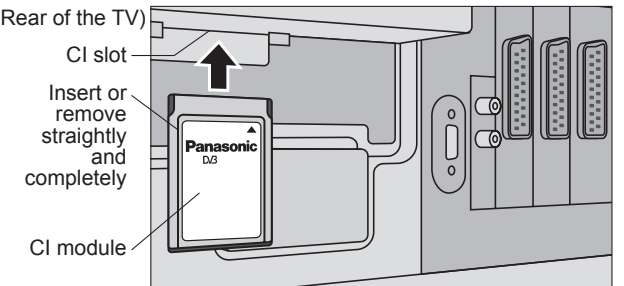

- The features that appear on screen are dependent on the contents of the selected CI module.
- For more details, see the manual of the CI module, or check with the broadcaster.

Pay-TV

Common Interface Module

- Normally pay-TV services will appear without ② and ③. If pay-TV services does not appear, perform ② and ③.

② **Select "Common Interface Module"**

DVB System Setup	
Common Interface Module	Access
Preferred Subtitles	English
System Update	
Display Timeout	3 seconds



③ **Follow the on-screen instructions**

example: select, go → OK



- On-screen operation guide may not correspond to the remote control buttons.

Language of subtitles

Preferred Subtitles

Select "Preferred Subtitles" and set the language

DVB System Setup	
Common Interface Module	Access
Preferred Subtitles	English
System Update	
Display Timeout	3 seconds

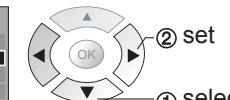

■ To display subtitles (p. 11)

Download new software to TV.

- For details (p. 42)

① **Select "System Update"**

DVB System Setup	
Common Interface Module	Access
Preferred Subtitles	English
System Update	Access
Display Timeout	3 seconds

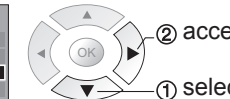

If System Update is performed, the software will be updated (it may change TV functions). If you do not wish to do so, set "Auto Update Search in Standby" to Off.

② **Select "Auto Update Search in Standby" and then select "On" or "Off"**

System Update	
Auto Update Search in Standby	On
System Update Search Now	
Software Licence	

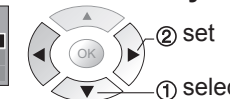

- On: Automatically performs a search in standby and downloads an update, if any

■ To update immediately

→ Select "System Update Search Now" → Searches for an update (for several min.) and displays a corresponding message if any → OK → Downloads (for about 20 min.)

■ To view software licence information

→ Select "Software Licence" → Display

Update unit's software system

System Update

Information banner display time

Display Timeout

Set how long the information banner (p. 11) stays on screen

Select "Display Timeout" and set the time

DVB System Setup	
Common Interface Module	Access
Preferred Subtitles	English
System Update	
Display Timeout	3 seconds

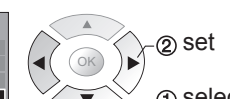

- 0 (No display) to 10 sec. in 1-sec. increments

Profile Edit / Child Lock (DVB mode)

Your favourite channels can be listed, and control channel audience.

- 1** If in Analogue mode
Select DVB
DVB Analogue MODE
- 2** Display the menu
MENU
- 3** Select "Setup menu"
Main menu
Picture menu
Sound menu
Setup menu
- 4** Select "DVB Setup Menu"
Setup menu
Q-Link AV2
AV2 out Monitor
Control with HDMI On
Off timer Off
Side panel Off
Power save Off
Power on preference TV
DVB Setup Menu Access
Owner ID
Shipping condition
- 5** Select "Profile Edit" or "Child Lock"
DVB Setup menu
Timer Programming
Profile Edit Access
Child Lock Access
DVB Tuning Menu
DVB System Setup
Multi Audio eng
- 6** How to set

■ To return to TV
EXIT

List favourite channels Profile Edit

Create your favourite channel list (Profile) from various broadcasters (up to 4: Profile 1 to 4). The list is added to "Category" in TV Guide (p. 12) and information banner (p. 11) and then easily accessed.

① Select a channel and add it to the list

To change the category → red
To display another Profile → green

A channel is added

● To add all channels to the list → blue

■ To edit Profile

Select the field of Profile to edit and:

- To name the Profile → red
- To move the channel → green → Select the new position → Confirm → OK
- To delete the channel → yellow
- To delete all channels → blue

② Store

OK — store

● Channel numbers (Known as logical channel numbers) cannot be changed, due to broadcast restrictions.

Control channel audience Child Lock

You can lock specific channels and control who watches them. (When a channel is selected, a message appears; by entering the PIN number, you can watch the channel.)

① Enter the PIN number (4 digits)

- Enter the PIN number twice at first setting.
- Make a note of the PIN number in case you forget it.

② Select "Child Lock Service List"

③ Select the channel to be locked

- To cancel → Select the locked channel → OK
- To lock all channels → yellow
- To cancel all channel locks → blue

Appears when the channel is locked

■ To change the PIN number

Select "Change PIN" in ② and enter a new PIN number twice.

Note

- Setting "Shipping condition" (p. 32) or "DVB Auto Setup" (p. 28) erases the PIN number and all settings.

DVB Tuning Menu (DVB mode)

You can re-tune all TV channels when moving house or search for new services which may have recently started broadcasting.

- 1 If in Analogue mode
Select DVB
DVB
Analogue
MODE
- 2 **Display the menu**
MENU
- 3 **Select "Setup menu"**
Main menu
Picture menu
Sound menu
Setup menu
- 4 **Select "DVB Setup Menu"**
DVB Setup menu
Timer Programming
Profile Edit
Child Lock
DVB Tuning Menu
DVB System Setup
Multi Audio
- 5 **Select "DVB Tuning Menu"**
DVB Tuning Menu
DVB Auto Setup
Add New Service
New Service Message
Signal Condition
- 6 **Select the function and access**

■ To return to TV
EXIT

● No data is stored if an Auto Setup sequence is interrupted.

Menu	Item	Adjustments / Configurations
DVB Tuning Menu	DVB Auto Setup	Automatically sets the DVB channels in the area. ● The current setting is erased. ● If a Child Lock PIN number (p. 27) has been set, it must be entered again.
	Add New Service	Adds a new DVB station. ● A new station is added to the DVB channel list, when found. ● The new station is added with the current settings saved as they are.
	New Service Message	Selects whether to give a notification message when a new DVB station is found. (On / Off) ● Selecting OK (Auto Setup) will delete current Profile and Childlock settings.
	Signal Condition	Select a channel and check the DVB signal condition. Use for adjusting the direction of the aerial. ● Green bar → Good ● Red bar → Poor (Check the aerial)

New DVB Service Found!
Press OK to start Auto Setup
Press EXIT to Ignore.
Warning! Selecting Auto Setup will delete current Profile and Childlock settings

Signal Condition

DVB Programme	[CH30] 1 BBC ONE Wales
Signal Quality	<div style="width: 100%; height: 10px; background: linear-gradient(to right, green, yellow, red);"></div>
Signal Strength	<div style="width: 100%; height: 10px; background: linear-gradient(to right, green, yellow, red);"></div>

0 5 10

Displaying PC Screen on TV

The screen of the PC connected to the unit can be displayed on the TV. You can also listen to PC sound with the audio cable connected. To connect PC (p. 40)

- 1 **Select the external input**
TV/AV
AV2
AV1 AV2/S AV3/S Next>
- 2 **Select "PC"**
yellow
(Press twice)
PC
HDMI1
<Back AV4/S C/PC HDMI1/2

■ To return to TV → TV/AV

● Corresponding signals (p. 43)
● If "H-freq." or "V-freq." is shown in red, the signals may not be supported.

■ PC menu setting (changed as desired)
● To make settings → "How to Use Menu Functions" 1 to 4 (p. 18)

Menu	Item	Adjustments / Configurations (options)	
Picture menu	Viewing mode, Contrast, Brightness, Sharpness, Colour balance (p. 21)		
	Advanced setting	W/B High R	White balance of bright red area
		W/B High B	White balance of bright blue area
		W/B Low R	White balance of dark red area
		W/B Low B	White balance of dark blue area
		Gamma	(2.0 / 2.2 / 2.5 / S Curve)
Setup menu	Input resolution	Switches to a wide view ● VGA (640 x 480 dots), WVGA (852 x 480 dots), XGA (1,024 x 768 dots), WXGA (1,366 x 768 dots) ● Options change depending on signals	
	Clock	Set to the minimum level if noise occurs	
	H-pos	Adjusts horizontal position	
	V-pos	Adjusts vertical position	
	Clock phase	Eliminates flicker and distortion ● Adjust after Clock adjustment	
	Sync	Chooses another synchronous signal if the image is distorted (H&V / On G) ● H&V : by the horizontal and vertical signals from your PC On G: by the green signal from your PC (if available)	
	Volume correction, Side panel, Power save (p. 23)		

● Sound menu (p. 20)

Editing and Setting Channels

The analogue channel settings can be changed according to your needs and reception conditions.

- 1** If in DVB mode
Select Analogue
DVB Analogue MODE
- 2** **Display the menu**
MENU
- 3** **Select "Setup menu"**
Main menu
Picture menu
Sound menu
Setup menu
- 4** **Select "Tuning Menu"**
Setup menu
Q-Link AV2
AV2 out Monitor
Control with HDMI On
Teletext FASTEXT
Off timer Off
Side panel Off
Power save Off
Power on preference TV
Tuning Menu Access
Owner ID
Shipping condition
- 5** **Select the function**
Tuning Menu
Programme edit Access
Auto setup
Manual tuning
- 6** **How to set**

■ To return to TV
EXIT

For Manual tuning, using the buttons on the front of the set ("Manual tuning" on p. 31)

- ① (Press repeatedly until "Tuning Mode" appears)
- ② or (Access "Manual tuning")
- ③ (Select programme position or channel number)
● Selected item will flash.
- ④ or (Change programme position or start searching channels)
- ⑤ (Store)
- ⑥ ③-⑤ (Repeat)

■ To return to TV
F

Programme position (flash)
Channel number (flash)
Channel (Manual tuning screen)

(Analogue mode)

Edit the analogue programme position settings

① Select the channel to edit

Prog.	Chan.	Name	Lock
1	CH44	ABC	Off
2	CH51	XYZ	Off
3	CH41	FTP	Off
4	CH47	123	Off
5	CH37	456	Off

Cursor select

② Edit

- To delete → red
→ After confirming, press red
- To add → green
→ After confirming, press green
- To move → yellow
→ Select new position → yellow
- To download channel information to a Q-Link compatible equipment connected to the unit
→ blue → Automatically transmitted (for a few sec.)
● For details (p. 36)

③ Store
OK

Programme edit

- Delete
- Add
- Move
- Change name
- Lock
- Download to equipment

Name
Channel 3: FTP

To change the name of the broadcaster displayed when selecting channels

Prog.	Chan.	Name	Lock
1	CH44	XYZ	Off
2	CH51	XYZ	Off
3	CH41	FTP	Off
4	CH47	123	Off
5	CH37	456	Off

Select the "Name" field
Select the character
Repeat
To next character

Usable characters
ABCDEFGHIJKLMN OPQRST
UVWXYZ+-, 0123456789

To lock

Prog.	Chan.	Name	Lock
1	CH44	ABC	Off
2	CH51	XYZ	Off
3	CH41	FTP	Off
4	CH47	123	Off
5	CH37	456	Off

Select the "Lock" field
Select "On" ("Off" to unlock)

● You cannot select the channel with numeric buttons or the "C" button when locked.

Set automatically

Auto setup

Automatically set the channels received in the area

① Start Auto setup

start OK

Settings are made automatically

● The settings are downloaded to a Q-Link compatible equipment connected to the unit.
● All previous settings are erased.
● When the operation is completed, the broadcast of programme number "1" will appear.

Set manually

Manual tuning

To freely change settings after Auto setup

① Select the programme position and search through the channel

Programme position Channel

Manual tuning
21 68

search OK

② Store

③ Repeat ① and ②

Note

● If a VCR is connected with only the RF cable, select programme position "0".

Restore Settings

Resets the TV to its original condition, i.e. no channels tuned in. All settings other than "Owner ID" (channels, picture, sound quality, etc.) are reset.

1 Display the menu
MENU

2 Select "Setup menu"
Main menu
 Picture menu
 Sound menu
 Setup menu

3 Select "Shipping condition"
Setup menu
 Q-Link AV2
 AV2 out Monitor
 Control with HDMI On
 Teletext FASTEXT
 Off timer Off
 Side panel Off
 Power save Off
 Power on preference TV
 Tuning Menu
 Owner ID
 Shipping condition Access

4 How to set
EXIT

Restore Settings

Shipping condition

1 Check the message and initialise

Shipping condition
All tuning data will be erased

set

2 Follow the on-screen instructions

- "Auto Setup" will automatically start when MAINS power On / Off switch is next turned On. (p. 10)

To re-tune TV channels only, e.g. after moving house

- DVB: "DVB Auto Setup" (p. 28)
- Analogue: "Auto setup" (p. 31)

Owner ID

Entry of the security code (PIN number) and "personal information" (your name, address and post code). In the unfortunate event of theft it will help the Police to determine the owner. If you have skipped the Owner ID input in "Auto Setup" (p. 10), and input it later, start from 1. If you input the Owner ID in "Auto Setup" (p. 10), perform 4.

1 Display the menu
MENU

2 Select "Setup menu"
Main menu
 Picture menu
 Sound menu
 Setup menu

3 Select "Owner ID"
Setup menu
 Q-Link AV2
 AV2 out Monitor
 Control with HDMI On
 Teletext FASTEXT
 Off timer Off
 Side panel Off
 Power save Off
 Power on preference TV
 Tuning Menu
 Owner ID Access
 Shipping condition

4 How to set
EXIT

Input owner ID

Owner ID

1 Enter the 4-digit PIN number of your choice

You now have the opportunity to enter your details and help the police crack crime see instruction book

Owner ID
 PIN NUMBER : * * * *
 NAME : * * * * *
 HOUSE NO : * * * * *
 POSTCODE : * * * * *
 0123456789

Characters Entry field

To change the stored information
Enter the PIN number → OK

0 - 9

● Make a note of the PIN number in case you forget it.

2 Enter your name, address, and post code, in that order

Select the entry field
 Select character
 To next character

3 Store
OK — store (Press twice)

To check the "personal information" stored
 Hold down for about 6 sec.
 F
 Displays the information on the screen (for several sec.)
 The PIN number is not displayed.

Recording Controls

Timer Programming (DVB mode) from Menu

The Timer programming menu allows you to choose programmes that you wish to record. At the correct time, the DVB system will switch on and tune to the correct station (even if the TV is in Standby mode). If the recording equipment is compatible with Q-Link or similar technologies (p. 36) and connected to the TV's AV3 terminal using a SCART cable (p. 40), you do not need to programme the device – the DVB system will control the recording process. TV Guide may also be used to set timer programmes. (p. 12)

- 1** If in Analogue mode **Select DVB**
DVB Analogue MODE
- 2** **Display the menu**
MENU
- 3** **Select "Setup menu"**
Main menu
Picture menu
Sound menu
Setup menu
- 4** **Select "DVB Setup Menu"**
Setup menu
Q-Link AV2
AV2 out Monitor
Control with HDMI On
Off timer Off
Side panel Off
Power save Off
Power on preference TV
DVB Setup Menu Access
Owner ID
Shipping condition
- 5** **Select "Timer Programming"**
DVB Setup menu
Timer Programming Access
Profile Edit
Child Lock
DVB Tuning Menu
DVB System Setup
Multi Audio eng
- 6** **How to set the details**
- 7** **Store**

■ **To return to TV**
EXIT

■ **To stop recording**
GUIDE → EXIT

Caution

- The TV must either be On or in standby.
- For preparations of a recording equipment, read the manual of equipment.

① Start making the settings (OK) → start

② Repeat the operations as below, and set items in the order of ① to ⑤

select the item → set

● ①, ③ and ④ can also be entered with numeric buttons.

Set timer programming details

Pos.	Name	Date	Start	End	min.	
1	BBC1	6/8 FR	18:00	20:00	120	Off
3	ITV1	7/8 SA	21:30	22:30	60	Off

Previous timer programming event
Current timer programming event

① Channel
② Date
③ Starting time
④ Ending time
⑤ Subtitles (Off / Auto)

- Recording time (automatic display)
- one day ahead
- daily or weekly (press repeatedly)
- Daily SU-SA: Sunday to Saturday
- Daily MO-SA: Monday to Saturday
- Daily MO-FR: Monday to Friday
- Weekly SA/FR/TH/WE/TU/MO/SU: Same time on the same day every week

■ **To change a timer programming event**

- ➔ Select the programme to be changed using (OK) and press (OK)
- ➔ Correct as necessary (as above)

■ **To cancel a timer programming event**

- ➔ Select the programme to be deleted using (OK) and press (red)

TV Guide–Electronic Programme Guide (EPG)–Timer Recording

- ① Operate ① and ② in p. 12** (mode and Guide switches)
 - There are two styles of display for TV Guide (Landscape / Portrait)
- ② Select the programme to be broadcast**

(Timer Programming screen)

● Orange DVB LED (Rapid blinking during recording)

■ **To check / change / cancel a timer programming event** → "Timer Programming" (p. 35)

Direct TV recording:

You can record the current programme to DVD Recorder or VCR immediately. (p. 36)

Note

- A message will appear if you try to programme a timer event which overlaps an already programmed event.
- 2 min. before the starting time: a reminder message appears. (To remove the message → OK button; To cancel the programming → EXIT button)
- 10 sec. before the starting time: in DVB mode, the unit automatically selects the programmed channel.
- Cancelling the programming may not be valid immediately before the starting time. In this case, directly operate the recording equipment to cancel recording.
- Please set the Starting time more than 2 minutes interval from the present time. If you want to record, use Direct TV recording (p. 36).

Caution

- No other DVB channel can be selected during recording. However you can watch analogue channels.
- It may not be possible to record an encrypted programme (which is copy-protected).

Q-Link Functions

Q-Link connects the TV unit and VCR / DVD recorder, enables easy recording and playback.

Condition

- Use the VCR / DVD recorder with the following logos: "Q-Link", "NEXTVIEWLINK", "DATA LOGIC", "Easy Link", "Megalogic", or "SMARTLINK"
- Connect the equipment to this unit's AV2 or AV3 terminal via a "fully-wired" SCART cable. (p. 40)
- Q-Link terminal setup in Setup menu (Q-Link, AV2/AV3 out). (p. 23)

Download analogue channel settings

- Perform Auto setup. (p. 31)
When first using this unit, see "Auto Setup". (p. 10)
- Perform download to the equipment. (p. 31)

Features available

Some recording equipments are not applicable. Read the manuals of the equipment.

What you see is What you record

Direct TV Recording:

Recording the current programme in VCR / DVD recorder immediately.



- When Direct TV Recording is performed, the recording equipment is automatically turned on if it is in Standby mode.
- The recording equipment is recording from its own tuner. You can turn the TV off during recording (Analogue only).
- If, during recording from an AV source, you turn the TV off or change input / programmes, the recording will be stopped.
- When Direct TV Recording is performed while watching DVB channel, the DVB programme position is locked and no other DVB channel can be selected. However you can watch analogue channels.

To change DVB channel, stop recording



Information / Message

Recording information or if recording is not possible, a message is displayed. (Only when the programme number is "0" or "AV mode" for some equipment.)

Power on link and Easy playback

When VCR or DVD recorder starts playback or direct navigator or function menu are activated, the TV is turned on and input mode is switched automatically so that you can view the content. (Only when TV is in Standby mode.)

Power off link

When TV is set to Standby mode, the recording equipment is also automatically set to Standby. (Only when the videocassette or DVD is not active.)

- "DATA LOGIC" (a trademark of Metz Corporation)
 - "Easy Link" (a trademark of Philips Corporation)
- Read the manuals of the equipment too.

- "Megalogic" (a trademark of Grundig Corporation)
- "SMARTLINK" (a trademark of Sony Corporation)

HDMI Functions

HDMI connection

HDMI (high-definition multimedia interface) allows you to enjoy high-definition digital images and high-quality sound by connecting the TV unit and the equipment.

HDMI-compatible equipment (*1) with an HDMI or DVI output terminal, such as a set top box or a DVD player, can be connected to the HDMI terminal using an HDMI compliant (fully wired) cable.

About connections, see "External Equipment" (p. 40).

Note

- HDMI is the world's first complete digital consumer AV interface complying with a non-compression standard.
- If the external equipment has only a DVI output, connect to the HDMI1 terminal via a DVI to HDMI adapter cable (*2).
- When the DVI to HDMI adapter cable is used, connect the audio cable to the audio input terminal.
- Audio settings can be made on the "HDMI1 input" menu screen. (p. 21)
- Applicable audio signal sampling frequencies (2ch L.PCM): 48 kHz, 44.1 kHz, 32 kHz
- HDMI2 terminal is for digital audio signal only.
- Use with a PC is not assumed.
- If the connected equipment has an aspect adjustment function, set the aspect ratio to "16:9".
- These HDMI connectors are "type A".
- An equipment having no digital output terminal may be connected to the input terminal of either "Component", "S-VIDEO", or "Video" to receive analogue signals.
- The HDMI input terminal can be used with only the following image signals: 480i, 480p, 576i, 576p, 720p and 1080i. Match the output setting of the digital equipment.
- For details of the applicable HDMI signals, see p. 43.

- (*1): The HDMI logo is displayed on HDMI-compliant equipment.
- (*2): Enquire at your local digital equipment retailer shop.

Summary of Control functions

Function	Connections	HDMI and SCART	SCART (Q-Link) only	HDMI only
Easy playback		○	○	○
Direct TV Recording		○ (Not when viewing HDMI input)	○	-
Theatre speaker		○	-	○
Power on link		○	○	○
Power off link		○	○	○
Analogue TV tuning download		○	○	-

HDMI Functions (Continued)

Control with HDMI "HDAVI Control"™*

*Enjoy additional HDMI Inter-Operability with Panasonic products which have "HDAVI Control" function. HDMI connections to some Panasonic equipment (Panasonic DVD Recorder DIGA, Panasonic Player theatre, Panasonic Amplifier, etc.) allow you to enjoy easy playback or home theatre.

About connections, see "External Equipment" (p. 40). Read the manuals of the equipment too.

This function needs an HDMI compliant (fully wired) cable.

Non-HDMI-compliant cables cannot be utilized.

Consult your local Panasonic dealer or refer to the URL for applicable equipment: www.panasonic.co.uk

Preparations

(For the first time / When adding new equipment, reconnecting equipment or changing setup)

After connection turn the equipment on and then switch the TV unit on.

Select the input mode to HDMI1 or HDMI2 (p. 17), and make sure that an image is displayed correctly.

1 Display the menu
MENU

2 Select "Setup menu"
Main menu
 ◀ Home theatre
 □ Picture menu
 ▶ Sound menu
 ≡ Setup menu
 ②access
 ①select

● Displayed when Amplifier or Player theatre is connected. This may be displayed after disconnecting the equipment. In this case, set "Control with HDMI" in Setup menu to "Off", then set to "On" again.

3 Select "Control with HDMI"
Setup menu
 Q-Link AV2
 AV2 out Monitor
 Control with HDMI On
 Off timer Off
 Side panel Off
 Power save Off
 Power on preference TV
 DVB Setup Menu
 Owner ID
 Shipping condition
 select

4 Select "On" (default is On)
select

■ **To return to TV**
EXIT

- It is recommended that you use Panasonic's HDMI cable.
Recommended part number:
RP-CDHG15 (1.5 m)
RP-CDHG30 (3.0 m)
RP-CDHG50 (5.0 m)

<h3>Easy playback</h3>	<p>Automatic Input switching-When the connected Panasonic equipment is operated, input mode is switched automatically. When it is stopped operating, input mode is returned.</p>
<h3>Theatre speaker</h3>	<p>You can control the theatre speaker with TV's remote control. This function is available when Panasonic Amplifier or Player theatre is connected.</p> <p>① Display the menu → MENU</p> <p>② Select "Home theatre" or "TV speaker"</p> <p>Main menu ▶ Home theatre □ Picture menu ▶ Sound menu ≡ Setup menu</p> <p>②access ①select</p> <p>■ Home theatre: Adjustment for equipment (automatically turned on if it is in Standby mode) Volume up / down → + - Mute → MUTE</p> <p>■ TV speaker: TV speakers are active.</p> <p>● When selecting "Home theatre", the sound of TV speakers is mute. ● When the equipment is turned off, TV speakers will be active.</p>
<h3>Power on link</h3>	<p>When the connected Panasonic equipment starts playback or direct navigator or function menu are activated, the TV is automatically turned on. (Only when TV is in Standby mode.)</p>
<h3>Power off link</h3>	<p>When TV is set to Standby mode, the connected Panasonic equipment is also automatically set to Standby.</p>

- Note**
- Setup the equipment to enable this function. Read the manual of the equipment.
 - This function may not work normally depending on the equipment condition.
 - This function may not work normally when Panasonic Player theatre is connected.
 - The equipment can be operated by TV's remote control with this function on even if TV is in Standby mode.
 - Image or sound may not be available for the first few seconds when the playback starts.
 - Image or sound may not be available for the first few seconds when Input mode is switched.
 - Volume function will be displayed when adjusting the volume of the equipment.
 - Easy playback is also available by using the remote control for Amplifier. Read the manuals of Amplifier.

External Equipment

These diagrams show our recommendations for how to connect the TV unit to your various equipment. For other connections, consult the instructions for each piece of equipment, the table below, and the specifications (p. 47).

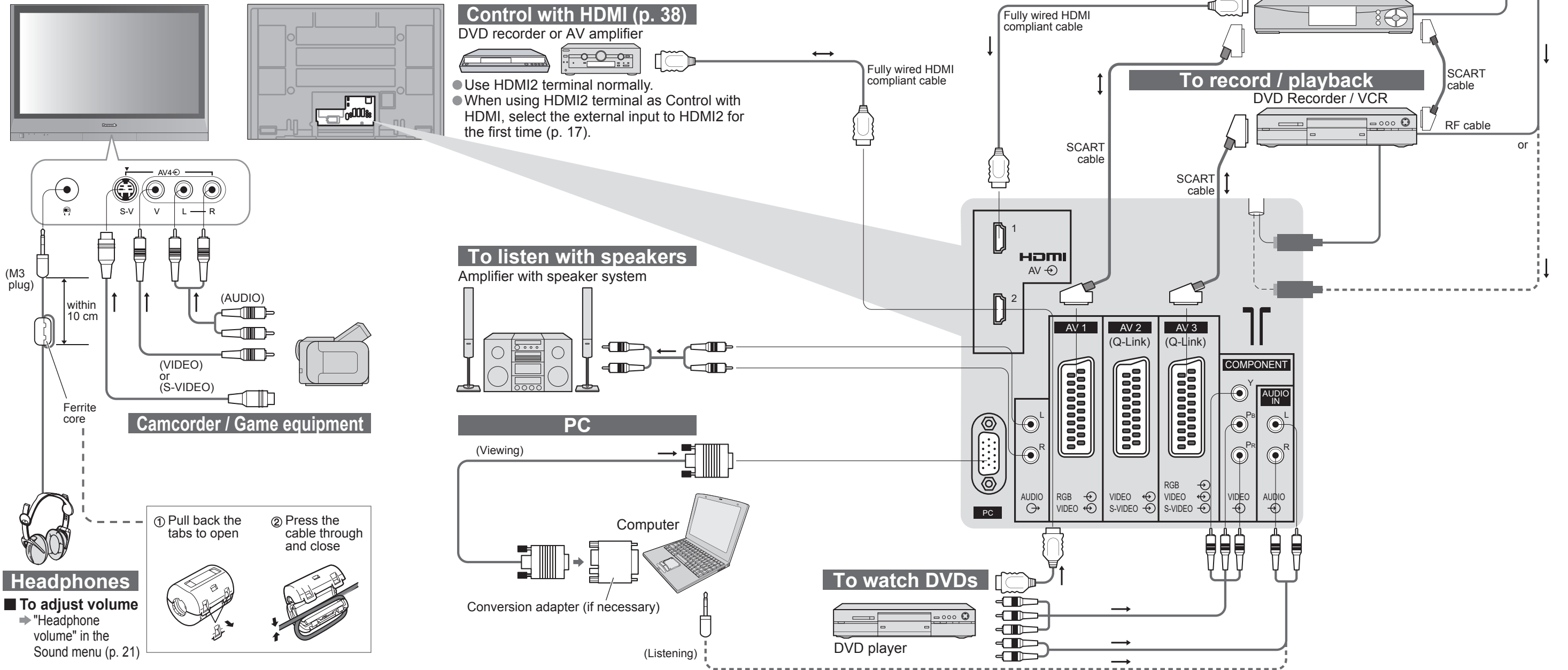

Control with HDMI (p. 38)

DVD recorder or AV amplifier

- Use HDMI2 terminal normally.
- When using HDMI2 terminal as Control with HDMI, select the external input to HDMI2 for the first time (p. 17).

To listen with speakers

Amplifier with speaker system

PC

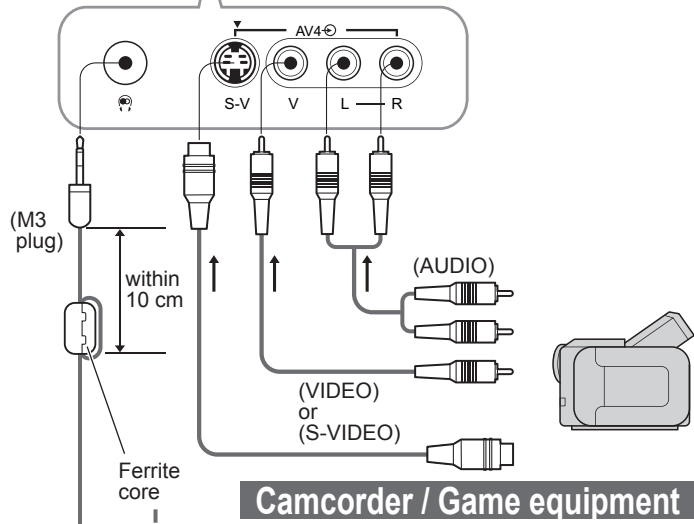
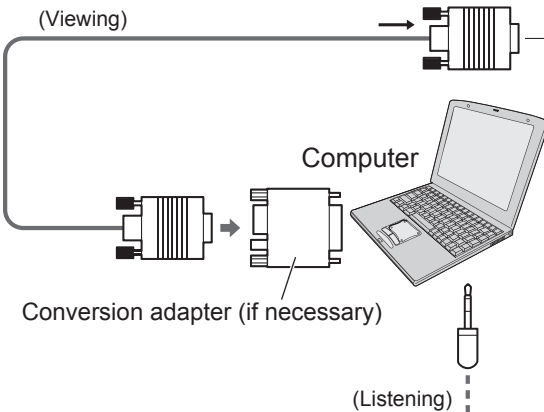

Headphones

- To adjust volume
- "Headphone volume" in the Sound menu (p. 21)

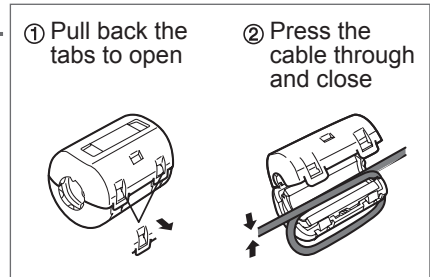

Types of connectable equipment to each connector

Connector	AV1	AV2	AV3	AV4	COMPO	HDMI	
	(Front of TV)	Y Pb Pr	1	2			
Recording / Playback (equipment)							
■ To record / playback videocassettes / DVDs (VCR / DVD recorder)	○	○	○				
■ To watch DVDs (DVD player)	○	○	○	○	○	○	○
■ To watch camcorder images (Video camera)	○	○	○	○			
■ To watch satellite broadcasts (Set top box)	○		○	○		○	
■ To play games (Game equipment)	○		○	○			
■ Q-Link		○	○				
■ Direct TV Recording		○	○				
■ Control with HDMI						○	○

PC connection

A PC may be connected to this TV unit so that the PC screen is displayed and sound is heard from the TV.

- PC signals that can be inputted: Horizontal scanning frequency 31 to 69 kHz; vertical scanning frequency 59 to 86 Hz (more than 1,024 signal lines could result in incorrect display of the image).
- A PC adapter is not necessary for the DOS/V-compliant D-sub 15-pin connector.

Note

- Some PC models cannot be connected to this TV unit.
- For details of the applicable PC signals, see p. 43.

● Max. display resolution

Aspect	4:3	1,024 × 768 dots
16:9		1,366 × 768 dots

D-sub 15-pin connector signal

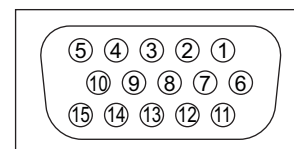

Pin No.	Signal Name	Pin No.	Signal Name	Pin No.	Signal Name
①	R	⑥	GND (Ground)	⑪	NC (not connected)
②	G	⑦	GND (Ground)	⑫	NC (not connected)
③	B	⑧	GND (Ground)	⑬	HD/SYNC
④	NC (not connected)	⑨	NC (not connected)	⑭	VD
⑤	GND (Ground)	⑩	GND (Ground)	⑮	NC (not connected)

Technical Information

Aspect Ratio

The optimum size and aspect can be chosen, and you can enjoy finer images. (p. 11)

■ **Auto aspect:** Auto aspect determines the best aspect ratio to use to fill your screen. It does this using a four step process to determine if the picture being viewed is a widescreen picture.

If Auto aspect detects a widescreen signal it switches into the appropriate 16:9 or 14:9 widescreen mode. If Auto aspect does not detect a widescreen signal then this advanced TV set enhances the picture for optimum viewing pleasure.

The text shown on the screen indicates how Auto aspect determined which ratio to use:

"WIDE" appears in the top left of the screen if a widescreen identification signal (WSS) is found or a signal found through a SCART terminal. Auto aspect switches to the appropriate 16:9 or 14:9 widescreen ratio. This function will also work in any aspect mode. "Auto aspect" appears in the top left of the screen if black stripes above and below the picture are detected. Auto aspect chooses the best ratio and expands the picture to fill the screen. This process can take several minutes, depending on the darkness of the picture.

Signal name	Aspect modes							Aspect Control Signal											
	Auto aspect	16:9	14:9	4:3	Zoom1	Zoom2	Zoom3	Widescreen signal (WSS)				Control signal through SCART (pin 8) or HDMI terminal							
								TV	AV1	AV2	AV3	AV4	Component	AV1	AV2	AV3	HDMI 1	HDMI 2	
TV/AV1/AV2/AV3/AV4	PAL	○	○	○	○	○	○	○	○	○	○	○	○	○	○	○	○	○	○
	PAL 525/60	○	○	○	○	○	○	○	○	○	○	○	○	○	○	○	○	○	○
	DVB	○	○	○	○	○	○	○	○	○	○	○	○	○	○	○	○	○	○
	M.NTSC	○	○	○	○	○	○	○	○	○	○	○	○	○	○	○	○	○	○
	NTSC(AV input only)	○	○	○	○	○	○	○	○	○	○	○	○	○	○	○	○	○	○
Component/HDMI	SD	525(480)/60i	○	○	○	○	○	○	○	○	○	○	○	○	○	○	○	○	○
		525(480)/60p	○	○	○	○	○	○	○	○	○	○	○	○	○	○	○	○	○
		625(576)/50i	○	○	○	○	○	○	○	○	○	○	○	○	○	○	○	○	○
		625(576)/50p	○	○	○	○	○	○	○	○	○	○	○	○	○	○	○	○	○
		750(720)/50p	○	○	○	○	○	○	○	○	○	○	○	○	○	○	○	○	○
		750(720)/60p	○	○	○	○	○	○	○	○	○	○	○	○	○	○	○	○	○
HD		1125(1080)/50i	○	○	○	○	○	○	○	○	○	○	○	○	○	○	○	○	○
		1125(1080)/60i	○	○	○	○	○	○	○	○	○	○	○	○	○	○	○	○	○
PC input		○	○	○	○	○	○	○	○	○	○	○	○	○	○	○	○	○	○

Note

- The ratio varies depending on the programme, etc. If the ratio is greater than the standard "16:9", black bands may appear at the top and bottom of the screen.
- If the screen size looks unusual when a widescreen-recorded programme is played back on a VCR, adjust the tracking of the VCR. (See the VCR manual.)
- Aspect mode can be memorized for SD (Standard definition) and HD (High definition) signals separately.
- To select the ratio manually: (Only "16:9" or "4:3" in PC mode)

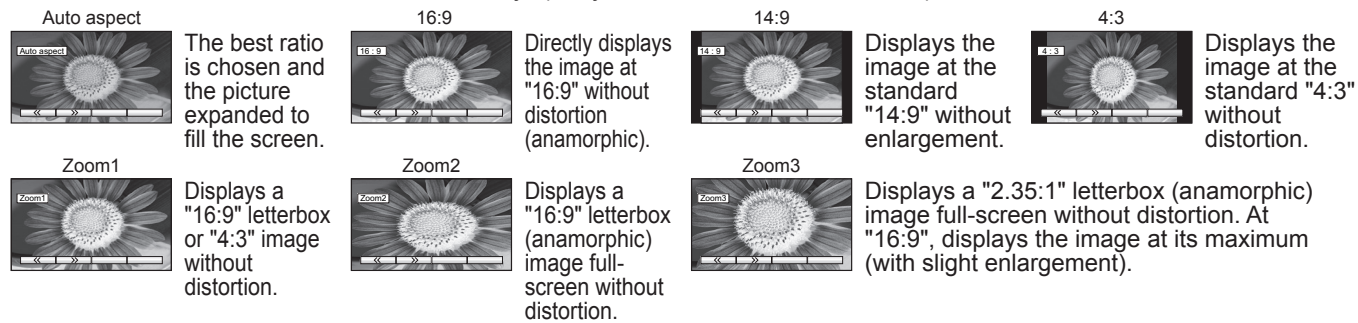

Updating the DVB software

From time to time, a new version of software for DVB mode may become available for download to enhance performance or operations of the TV.

A notification banner will appear when you tune to one of the BBC channels, or you can search for a new version software by using the "System Update Search Now" function (p. 25).

To start downloading press "OK", this may take up to 20 minutes to complete.

To ignore the new software press "EXIT", but this banner will keep appearing during the period of new software availability, usually 2 to 3 days.

To download any new software automatically, ensure that the "Auto Update Search in Standby" function in the System Update menu is set to "On" (p. 25).

The TV will then download new software automatically at night if it is left in standby without any timer programme in progress.

Note

- During software download and update, DO NOT switch off the TV.

SCART, S-VIDEO and HDMI terminal information

AV1 SCART terminal (RGB, VIDEO)

Suitable inputs for AV1 include RGB (Red / Green / Blue).

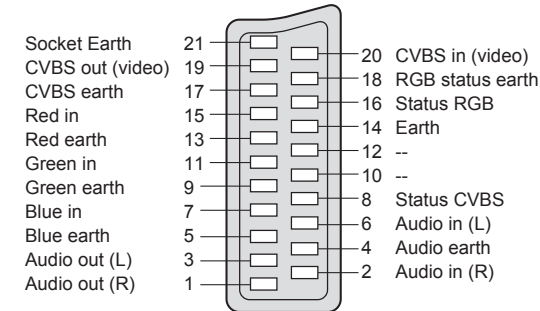

AV3 SCART terminal (RGB, VIDEO, S-VIDEO, Q-Link)

AV3 - Pins 15 and 20 are dependent on AV3 S-VHS / VIDEO switching.

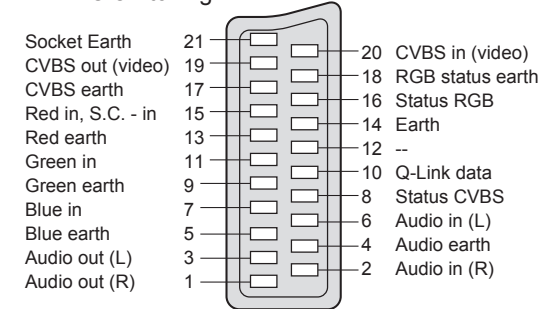

AV2 SCART terminal (VIDEO, S-VIDEO, Q-Link)

AV2 - Pins 15 and 20 are dependent on AV2 S-VHS / VIDEO switching.

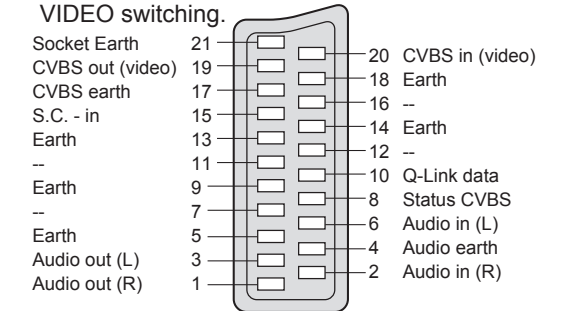

AV4 S-VIDEO 4 pin terminal

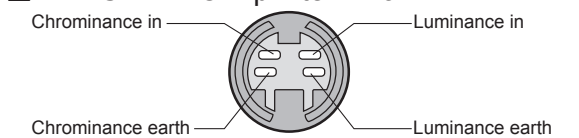

HDMI terminal

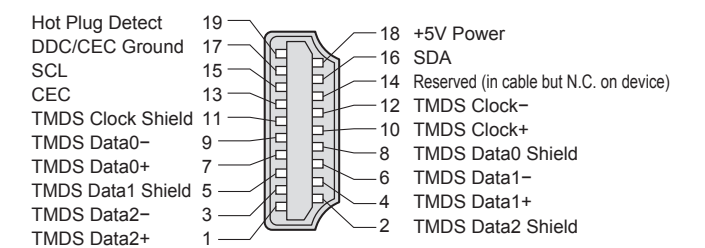

Input signal that can be displayed

* Mark: Applicable input signal for Component (Y, Pb, Pr), HDMI and PC (D-sub 15P)

Signal name	Horizontal frequency (kHz)	Vertical frequency (Hz)	Component	HDMI	PC
525 (480) / 60i	15.73	59.94	*	*	
525 (480) / 60p	31.47	59.94	*	*	
625 (576) / 50i	15.63	50.00	*	*	
625 (576) / 50p	31.25	50.00	*	*	
750 (720) / 60p	45.00	60.00	*	*	
750 (720) / 50p	37.50	50.00	*	*	
1,125 (1,080) / 60i	33.75	60.00	*	*	
1,125 (1,080) / 50i	28.13	50.00	*	*	
640 × 400 @70 Hz	31.46	70.07			*
640 × 480 @60 Hz	31.47	59.94			*
640 × 480 @75 Hz	37.50	75.00			*
800 × 600 @60 Hz	37.88	60.32			*
800 × 600 @75 Hz	46.88	75.00			*
800 × 600 @85 Hz	53.67	85.06			*
1,024 × 768 @60 Hz	48.36	60.00			*
1,024 × 768 @70 Hz	56.48	70.07			*
1,024 × 768 @75 Hz	60.02	75.03			*
1,024 × 768 @85 Hz	68.68	85.00			*
1,280 × 1,024 @60 Hz	63.98	60.02			*
Macintosh13" (640 × 480)	35.00	66.67			*
Macintosh16" (832 × 624)	49.72	74.54			*
Macintosh21" (1,152 × 870)	68.68	75.06			*

Note

- Signals other than above may not be displayed properly.
- The above signals are reformatted for optimal viewing on your display.

FAQs

Before requesting service or assistance, please follow these simple guides to resolve the problem. If problem still persists, please contact your local Panasonic dealer or Panasonic Customer Care Centre for assistance. For details (p. 48)

White spots or shadow images (noise)

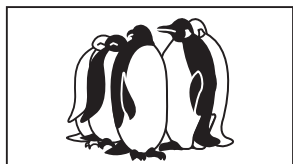

- Check the position, direction, and connection of the aerial.

Neither image nor sound is produced

- Is the unit in "AV mode"?
- Is the mains lead plugged into the socket outlet?
- Is the TV unit turned On?
- Check Picture menu (p. 20) and volume.
- Check all required SCART cables and connections are firmly in place.

Auto aspect

- Auto aspect is designed to provide you with the best aspect ratio to use to fill your screen. For user control please see p. 42.

S-Video / black and white picture

- Using TV/AV button please confirm your selection is S-Video i.e. AV2/S-Video or AV3/S-Video (p. 17).

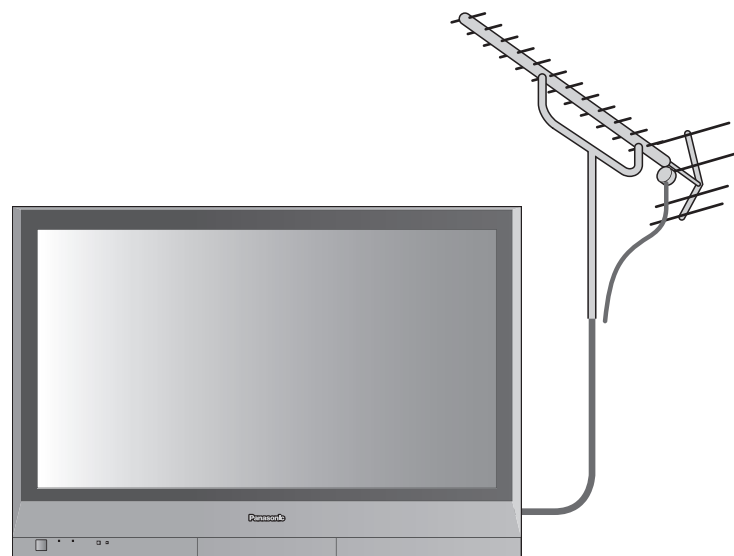

No programmes shown on TV Guide

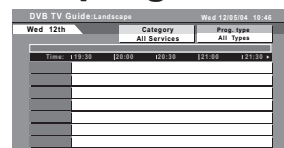

- Check the DVB transmitter.
 - Adjust the direction of the aerial to another transmitter installed nearby.
 - Check the analogue broadcast.
- If the image quality is poor, check the aerial and consult your nearest dealer.

On Screen messages - i.e. AV1/EC1

- You can simply clear these by pressing . Press again to redisplay.

Direct TV record / Q-Link functions not recording

- Please confirm SCART cable and connection. Also please set "AV2/AV3 out" in the Setup menu (p. 22).

Problem	Actions
Screen VIERA logo appears at the four corners of the screen	<ul style="list-style-type: none"> ● The function to prevent after-image (p. 5) is activated. (Not a faulty symptom) ● The screen saver is activated when the following conditions without any user operation for a few minutes: <ul style="list-style-type: none"> ● no signal in DVB or AV mode ● selected locked channel ● Contrast is lowered when the following conditions without any user operation for a few minutes: <ul style="list-style-type: none"> ● selected radio channel ● displayed menu (except Tuning menu, Owner ID and Shipping condition) ● selected invalid or bad signal channel
Contrast is reduced	<ul style="list-style-type: none"> ● Due to production process involved in this technology this may result in some pixels which are permanently lit or unlit. This is not a malfunction.
Permanently lit spots on screen	

Problem	Actions
Screen Chaotic image, noisy	<ul style="list-style-type: none"> ● Set "P-NR" in the Picture menu (to remove noise). (p. 21) ● Check nearby electrical products (car, motorcycle, fluorescent lamp).
No image can be displayed	<ul style="list-style-type: none"> ● Is "Colour" or "Contrast" in the Picture menu set to the minimum? (p. 21)
Blurry or distorted image (no sound or low volume)	<ul style="list-style-type: none"> ● Reset channels. (p. 28 and p. 30)
Sound No sound is produced	<ul style="list-style-type: none"> ● Is "Sound Mute" active? (p. 7) ● Is the volume set to the minimum?
Sound level is low or sound is distorted	<ul style="list-style-type: none"> ● Sound signal reception may be deteriorated. ● Set "NICAM" (p. 20) in the Sound menu to "Off". (Analogue only)
Whirling sound is heard	<ul style="list-style-type: none"> ● The sound is from built-in cooling fan (not a sign of faulty operation).
DVB Interference or frozen / disappearing image in DVB	<ul style="list-style-type: none"> ● Due to the digital reception technologies involved, quality of the DTV signals may be relatively low in some cases, despite good reception of analogue programmes. ● Check "Signal Condition". (p. 28) ● If "Signal Quality" or "Signal Strength" are displayed in red, check aerial. ● If problem persists, consult your local Panasonic dealer. ● Use the remote control to turn Off the TV unit, then turn it On again.
HDMI Sound is unusual	<ul style="list-style-type: none"> ● Set the sound setting of the connected equipment to "2ch L.PCM". ● Check the "HDMI1 input" setting in the Sound menu. (p. 21) ● If digital sound connection has a problem, select analogue sound connection. (p. 21)
Pictures from external equipment are unusual when the equipment is connected via HDMI	<ul style="list-style-type: none"> ● Is the HDMI cable connected properly? (p. 40) ● Turn Off the TV unit and equipment, then turn them On again. ● Check an input signal from the equipment. (p. 43) ● Use an equipment compliant with EIA/CEA-861/861B.
"Control with HDMI" function does not work	<ul style="list-style-type: none"> ● Switch the TV unit on again with the equipment on. ● Set "Control with HDMI" to "Off", then set to "On" again. (p. 38)
Other TV unit goes into "Standby mode"	<ul style="list-style-type: none"> ● The sleep function is activated. ● The TV unit enters "Standby mode" about 30 min. after broadcasting ends.
The remote control does not work	<ul style="list-style-type: none"> ● Are the batteries installed correctly? (p. 6) ● Has the TV unit been switched On?

On screen messages

On screen messages	Actions / Meanings
All tuning data will be erased	● "Shipping condition" will erase all tuning data.
Are you sure ?	● Make sure the operation is with your desire.
Are you sure you want to delete this timer ? Press OK to delete timer Press Exit to return	● Make sure the deleting programme event is with your desire.
Bad Signal	● The signal is weak. Check the aerial.
DOWNLOAD IN PROGRESS PLEASE WAIT	● Q-Link channel download is in progress.
DVB Tuner Locked This programme is locked for recording	● If you want to unlock, cancel Direct TV Recording (p. 36) or Timer Programming (p. 34).
Feature not available	● Check the Q-Link connection and setting (p. 36). ● The impossible source (Component / HDMI / PC) to be record.
Incorrect PIN Number	● The PIN number you entered is wrong.
Invalid DVB Channel	● Invalid DVB channel is selected.
Invalid system time. Please exit !	● Cannot get the time information. Check the connection of the RF cable.
Max number of Timer already set !	● Maximum timer programming event is 8.
New DVB Service Found! Press OK start Auto Setup Press EXIT to Ignore. Warning! Selecting Auto Setup will delete current Profile and Childlock settings	● There is a new DVB station.
New version 1.90 found. Do you really want to update the software and reboot the system ? Press OK to download the new version Press EXIT to Ignore	● There is a new software available.
No DVB Service found	● No DVB signal can be found in Auto Setup.
No module inserted	● Check the CI module inserted completely (p. 25).
No recording -Check Tape or Disc	● The tape or disc may be "write protected", missing or damaged. The equipment may already be recording.
No recording - UNKNOWN REASON	● The recording cannot be done by any reason. Check the equipment. ● Disc or tape may be full.
No Service	● The station stops the services.
No Signal	● Check the connection of the RF cable.
Please check aerial or local DVB service availability. Press OK to start Auto Setup	● Please follow the message. If it is still failed, consult your local Panasonic dealer.
Please check settings and connections on HDMI devices.	● Communication error in Control with HDMI function (p. 38).
No stations found Please insert the aerial	● No analogue signal can be found in Auto setup.
Please wait.	● A function is in progress.
Recording in progress	● The recording equipment is recording the programme signal from its own tuner. You can turn the TV off and leave the equipment recording in the normal way.
Recording stopped - TV source changed	● Direct TV recording (analogue mode) will stop if channel or input source is changed.
Software successfully updated Press EXIT to continue	● The software updating is finished.
Software Update failed. Please try again later. Press EXIT to continue	● Perform "System Update Search Now" in System Update (p. 25). If it is still failed, there may not be the new software.
This service is locked! Press OK to enter PIN	● The selected channel is locked in Child Lock (p. 27).
Timer already expired !	● Starting time in Timer Programming is already past. Set correctly (p. 35).
Timer Event Due to Start 1: BBC1 has been Programmed for recording at 20:00	● This message will appear 2 minutes before timer programming event due to start.
Timer incorrect !	● Set Starting and Ending times in Timer Programming correctly (p. 35).
Timer overlap!	● The timer programme events are overlapped. Cannot record other channel at the same time. Check the Starting and Ending times in Timer Programming (p. 35).
Unable to download, Check Equipment	● The tape or disc is active. Stop the equipment and try again.
WARNING All analogue tuning data will be erased	● Auto setup will be erased all present analogue tuning data (p. 31).
WARNING All digital tuning data will be erased	● DVB Auto Setup will be erased all present DVB tuning data (p. 28).

Index

A Accessories 6	DVI 37	NICAM 21	Satellite receiver · 9, 17, 40
Add New Service · 28	DVDs 17	Normalise 7, 20	SCART 8, 43
Ambience 21	E External equipment	NTSC 18, 47	Shipping condition 32
Aspect 11, 42 8, 40	O Off timer 23	Signal Condition · 28
Auto Setup · 10, 28, 31	External input 17, 29	On / Off switch · 7, 11	Specifications 47
AV2/AV3 out · 23, 36	F FAQs 44-45	Optional accessories · 6	Subtitles 11, 16
C Category list 12	Front door 7	Owner ID 10, 33	S-video 8, 43
Child Lock 27	H HDMI 37-39	P PAL 47	System Update · 25, 42
CI module 25	Hold 11, 16	PC 29, 41	T Teletext 14-16
Clamper 6, 9	Home theatre 38	PIN number · 10, 27, 33	Timer programming · 13, 34
Component 43	I Information banner 11	P-NR 21	TV Guide 12, 13
Connection 8, 40	Input signal 43	Power LED 7, 10	TV speaker 39
Control with HDMI · 38, 40	L Licence 48	Profile Edit 27	Type list 12
D Direct TV Recording · 36	Lock 31	Programme edit 31	U Update the software · 25, 42
Display Timeout 25	M Mains Lead 6, 8	Q Q-Link 36	V Videos 8, 17
Download to equipment	Maintenance 5	Quick Start Guide · 6-10	Viewing mode 21
..... 10, 31	Manual tuning · 30, 31	R Remote control · 6, 7	W WSS 42
D-sub 15-pin 41	Menu Functions · 18-23	RGB 8	Z Zoom 11, 42
DVB Auto Setup · 28	N New Service Message · 28	S Sales and Support Information	
DVB LED 7, 13	 48	
DVB settings 24			
DVB Tuning Menu · 28			

Specifications

		TH-50PX60B		
Power panel	Source / Average	AC 220-240 V, 50 / 60 Hz / 377 W		
	Standby condition	0.3 W (Without DVB recording) / 20 W (With DVB recording)		
Display	Drive method	AC type		
	Ratio	16:9 (Aspect Ratio) / Max 10000:1 (Contrast Ratio)		
	Visible screen size (No. of pixels)	127 cmV 1,106 mm (W) × 622 mm (H) × 1,269 mm (diagonal) 1,049,088 (1,366 (W) × 768 (H)) [4,098 × 768 dots]		
Speaker / Output	12 cm × 6 cm × 2 pcs, 8 Ω / 20 W (10 W + 10 W)			
Headphones	M3 (3.5 mm) Jack × 1			
PC signals	VGA, SVGA, XGA SXGA ... (compressed)	Horizontal scanning frequency 31 - 69 kHz Vertical scanning frequency 59 - 86 Hz		
Receiving Systems / Band name	PAL I : UHF E21-68. PAL 525/60 : Playback of NTSC tape from some PAL Video recorders (VCR) or NTSC disc playback from DVD player and recorder.	DVB : Digital terrestrial services via UHF aerial input. M.NTSC : Playback from M.NTSC Video recorders (VCR). NTSC (AV input only): Playback from NTSC Video recorders (VCR).		
Aerial - Rear	UHF			
Operating Conditions	Temperature : 0 °C - 40 °C	Humidity : 20 % - 80 % RH (non-condensing)		
Connection Terminals	AV1 (Scart terminal)	21 Pin terminal (Audio/Video in, Audio/Video out, RGB in)		
	AV2 (Scart terminal)	21 Pin terminal (Audio/Video in, Audio/Video out, S-Video in, Q-Link)		
	AV3 (Scart terminal)	21 Pin terminal (Audio/Video in, Audio/Video out, RGB in, S-Video in, Q-Link)		
	AV4	VIDEO	RCA PIN Type × 1	1.0 V[p-p] (75 Ω)
		S-VIDEO	Mini DIN 4-pin	Y:1.0 V[p-p] (75 Ω) C:0.286 V[p-p] (75 Ω)
	Others	AUDIO L - R	RCA PIN Type × 2	0.5 V[rms]
		COMPONENT	Y 1.0 V[p-p] (including synchronization) PB, PR ±0.35 V[p-p]	
	HDMI1/2	TYPE A Connectors		
		PC	HIGH-DENSITY D-SUB 15PIN	R,G,B/0.7 V[p-p] (75 Ω) HD, VD/TTL Level 2.0 - 5.0 V[p-p] (high impedance)
	Output	AUDIO L - R	RCA PIN Type × 2	0.5 V[rms]
AUDIO L - R		RCA PIN Type × 2	0.5 V[rms] (high impedance)	
Dimensions (W × H × D)	1,210 mm × 818 mm × 95 mm			
Weight	40.0 kg Net			

Note

- Design and Specifications are subject to change without notice. Weight and Dimensions shown are approximate.
- This equipment complies with the EMC standards listed below.
EN55013, EN61000-3-2, EN61000-3-3, EN55020, EN55022, EN55024.