

Register your products and get support at  
[www.philips.com/welcome](http://www.philips.com/welcome)

32PHH5129/79  
42PFH5129/79  
50PFH5129/79

---

User manual

**PHILIPS**

# Contents

<b>1. Important</b>	<b>1</b>	<b>5. Connect Devices</b>	<b>14</b>
Safety	1	Connect to PC	15
Care	2		
Legal	2	<b>6. Product Information</b>	<b>16</b>
Sustainability	4	Display Resolution Supported	16
		Multimedia	17
<b>2. Product Introduction</b>	<b>4</b>	Tuner/Receiver/Transmitter	17
Control Panel	4	Remote Control	17
Remote Control	5	Power Supply	17
Use the Remote Control	6	TV Mounting Bracket	17
		Specification	18
<b>3. Use the TV</b>	<b>6</b>		
Switch to Standby Mode	6	<b>7. Trouble Shooting</b>	<b>18</b>
Switch the Channel	7	Common Troubles	18
View Connected Devices	8	Channel Troubles	19
Adjust the Volume	8	Image Troubles	19
		Audio Troubles	19
<b>4. General Operating Instructions</b>	<b>9</b>	HDMI Connection	20
Signal Source Selection	9	Computer Connection	20
Other Functions	9	Contact Us	20
CHANNEL	9		
PICTURE	10		
SOUND	11		
TIME	11		
OPTION	12		
LOCK	12		
USB Media Function	13		

# 1. Important

---

## Safety

---

### Precautions

Read and understand all instructions before you use your TV. If damage is caused by failure to follow the instructions, the warranty does not apply.

#### Risk of electric shock or fire!

Never expose the TV to rain or water. Never place liquid containers, such as vases, near the TV. If liquids are spilled on or into the TV, disconnect the TV from the power outlet immediately. Contact your local consumer care to have the TV checked before use.

- Never place the TV, remote control or batteries near naked flames or other heat sources, including direct sunlight. To prevent the spread of fire, keep candles or other flames away from the TV, remote control and batteries at all times.



- Never insert objects into the ventilation slots or other openings on the TV.
- Never expose the remote control or batteries to rain, water or excessive heat.
- Avoid force coming onto power plugs. Ensure that the power plug is fully inserted into the power socket. Loose power plugs can cause arcing or fire.
- When the TV is swivelled, ensure that no strain is exerted on the power cord. Strain on the power cord can loosen connections and cause arcing.

- To disconnect the TV from the mains power, the power plug of the TV must be disconnected. When disconnecting the power, always pull the power plug, never the cord. Ensure that you have full access to the power plug, power cord and outlet socket at all times.

#### Risk of damage to the TV!

- Two people are required to lift and carry a TV that weighs more than 25kg or 55lbs.
- When stand mounting the TV, use only the supplied stand. Secure the stand to the TV tightly. Place the TV on a flat, level surface that can support the combined weight of the TV and the stand.
- When wall mounting the TV, use only a wall mount that can support the weight of the TV. Secure the wall mount to a wall that can support the combined weight of the TV and wall mount. TP Vision bears no responsibility for improper wall mounting that results in accident, injury or damage.
- If you need to store the TV, disassemble the stand from the TV. Never lay the TV on its back with the stand installed.
- Before you connect the TV to the power outlet, ensure that the power voltage matches the value printed on the back of the TV. Never connect the TV to the power outlet if the voltage is different.
- Parts of this product may be made of glass. Handle with care to avoid injury and damage.

#### Risk of injury to children!

Follow these precautions to prevent the TV from toppling over and causing injury to children:

- Never place the TV on a surface covered by a cloth or other material that can be pulled away.
- Ensure that no part of the TV hangs over the edge of the surface.

- Never place the TV on tall furniture, such as a bookcase, without anchoring both the furniture and TV to the wall or a suitable support.
- Educate children about the dangers of climbing on furniture to reach the TV.

#### **Risk of overheating!**

- Never install the TV in a confined space. Always leave a space of at least 4 inches or 10 cm around the TV for ventilation. Ensure that curtains or other objects never cover the ventilation slots on the TV.

#### **Risk of injury, fire or power cord damage!**

- Never place the TV or any objects on the power cord.
- Disconnect the TV from the socket and aerial before lightning storms. During lightning storms, never touch any part of the TV, power cord or aerial cable.

#### **Risk of hearing damage!**

- Avoid using earphones or headphones at high volumes or for prolonged periods of time.

#### **Low temperatures**

- If the TV is transported in temperatures below 5°C or 41°F, unpack the TV and wait until the TV temperature matches room temperature before connecting the TV to the power outlet.

---

## Care

---

### Screen

- Risk of damage to the TV screen! Never touch, push, rub or strike the screen with any object.

- Unplug the TV before cleaning.
- Clean the TV and frame with a soft damp cloth and wipe gently. Never use substances such as alcohol, chemicals or household cleaners on the TV.
- To avoid deformations and colour fading, wipe off water drops as soon as possible.
- Avoid stationary images as much as possible. Stationary images are images that remain onscreen for extended periods of time. Stationary images include onscreen menus, black bars, time displays, etc. If you must use stationary images, reduce screen contrast and brightness to avoid screen damage.

---

### Placement tips

- Position the TV where light does not shine directly on the screen.
- The ideal viewing distance of this TV is three times its diagonal screen size. For example, if the diagonal screen size of the TV is 81 cm / 32", the ideal viewing distance is ~2.5 m / ~92" from the front of the screen.
- While seated, your eyes should be level with the centre of the screen.

---

## Legal

---

### Notice

2014 © TP Vision Netherlands B.V. All rights reserved.

This product was brought to the market by TP Vision Netherlands B.V. or one of its affiliates, hereinafter referred to as TP Vision, which is the manufacturer of the product. TP Vision is the warrantor in relation to the TV with which this booklet was packaged. Philips and the Philips Shield Emblem are registered trademarks of Koninklijke Philips N.V.

Specifications are subject to change without notice. TP Vision reserves the right to change products at any time without being obliged to adjust earlier supplies accordingly.

The written material packaged with the TV and the manual stored in the memory of the TV or downloaded from the Philips website are believed to be adequate for the intended use of the system. If the product is used for purposes other than those specified herein, TP Vision cannot guarantee the proper functioning and the safety of the product.

TP Vision cannot be held responsible for any errors in the content of this document nor for any problems as a result of the content of this document. Errors reported to TP Vision will be amended and published on the Philips support website as soon as possible.

### Terms of warranty

- The terms of warranty can be downloaded from the Philips support website. Never attempt to repair the TV yourself due to risk of injury, damage to the TV or voiding of warranty!
- Use the TV and accessories only as intended by the manufacturer.
- The caution sign printed on the back of the TV indicates risk of electric shock. Never remove the TV cover. Always contact Philips TV Consumer Care for service or repairs.
- Any operation expressly prohibited in this manual, or any adjustments and assembly procedures not recommended or authorised in this manual, shall void the warranty.

### Pixel characteristics

This LCD/LED product has a high number of colour pixels. Although it has effective pixels of 99.999% or more, black dots or bright points of light (red, green or blue) may appear constantly on the screen. This is a structural property of the display (within common industry standards) and is not a malfunction.

### CE compliance

This product is in compliance with the essential requirements and other relevant provisions of Directives 2006/95/EC (Low Voltage), 2004/108/EC (EMC) and 2011/65/EU (ROHS).



### Compliance with EMF

TP Vision manufactures and sells many products targeted at consumers, which, like any electronic apparatus, in general have the ability to emit and receive electromagnetic signals.

One of TP Vision's leading Business Principles is to take all necessary health and safety measures for the products, to comply with all applicable legal requirements and to stay well within the Electro Magnetic Field (EMF) standards applicable at the time of producing the products.

TP Vision is committed to developing, producing and marketing products that cause no adverse health effects. TP Vision confirms that, as long as its products are handled properly for their intended use, they are safe to use according to scientific evidence available today.

Philips and TP Vision play an active role in the development of international EMF and safety standards, enabling the anticipation of further developments in standardisation for early integration in the products.

---

### Trademarks and copyrights

Windows Media is either a registered trademark or trademark of Microsoft Corporation in the United States and/or



The terms HDMI and HDMI High-Definition Multimedia Interface and the HDMI Logo are trademarks or registered trademarks of HDMI Licensing LLC in the United States and other countries.

---

## Sustainability

---

### Recycling

Your product is designed and manufactured with high quality materials and components, which can be recycled and reused.



When this crossed-out wheeled bin symbol is attached to a product it means that the product is covered by the European Directive 2002/96/EC. Please inform yourself about the local separate collection system for electrical and electronic products.



Please act according to your local rules and do not dispose of your old products with your normal household waste. Correct disposal of your old product helps to prevent potential negative consequences for the environment and human health.

Your product contains batteries covered by the European Directive 2006/66/EC, which cannot be disposed of with normal household waste. Please inform yourself about the local rules on separate collection of batteries because correct disposal helps to prevent negative consequences for the environment and human health.



---

## 2. Product Introduction

Thanks for purchasing a Philips TV!  
To get the best technical support from Philips, please register your TV on the following website:  
[www.philips.com/welcome](http://www.philips.com/welcome).

---

### Control Panel

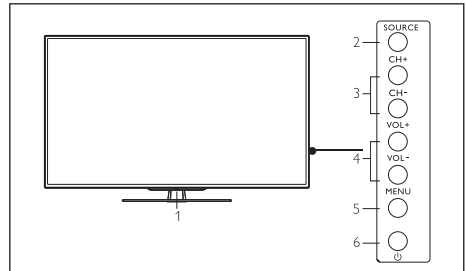

1. Indicator/Remote Control Sensor
2. Source : display the list of signal sources.
3. CH +/- : switch to the previous/next channel.
4. VoL +/- : increase/reduce the volume.
5. Menu : turn on/off the main menu.
6. : turn on/off the TV; to cut off power supply, please unplug the power cable.

## Remote Control

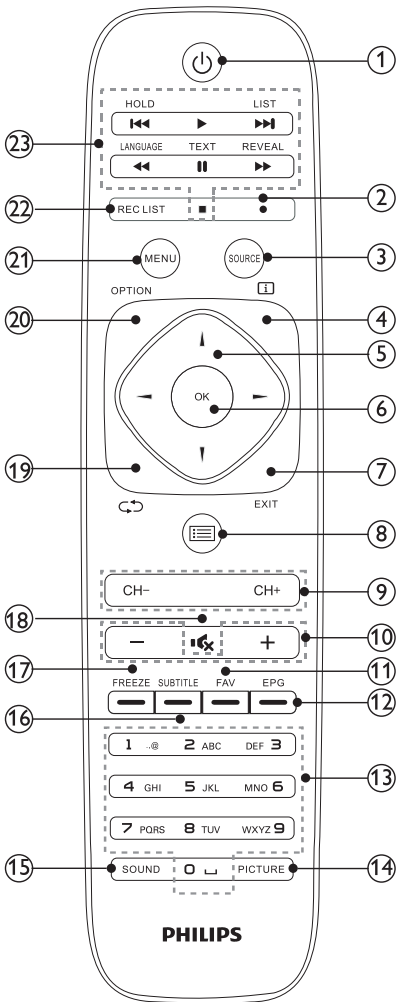

- ① **Standby/Power on**
- Switches the TV to standby if it is on.
  - Powers on the TV if it is in standby.
- ② • Red point  
Record programme key.

- ③ **Source**  
Select an input source for the TV.
- ④ **i**  
Display the program information when available.
- ⑤ **▲▼◀▶** Navigation keys
- In menu mode: navigate the menu.
- ⑥ **OK**
- In menu mode: confirm the input or selection
- ⑦ **EXIT**  
Press this button to exit menu.
- ⑧ **☰**  
Look through channel list
- ⑨ **CH+/-**  
Switch to the previous/next channel in TV mode.
- ⑩ **+/-**  
Increase/reduce the volume.
- ⑪ **FAV**  
Favorite channels

- ⑫ **EPG**  
Gives instant access to TV program guide
- ⑬ **Numeric keys (0~9)**  
Select a channel or value.
- ⑭ **PICTURE**  
Switch to the preset image mode.
- ⑮ **SOUND**  
Switch to the preset audio mode.
- ⑯ **SUBTITLE**  
Teletext green key or display subtitle message, when current channel has subtitle option.
- ⑰ **FREEZE**  
Picture freeze on/off or special functional key of menu.
- ⑱ **Mute**  
Mute or unmute the sound.
- ⑲ **Return**  
Return to the previous channel.
- ⑳ **OPTION**  
Access the options related to the current activity.
- ㉑ **Menu**  
Turn on /off the menu.
- ㉒ **REC LIST**  
Reveal Record programme list

㉓ **HOLD** / **LIST** / **LANGUAGE** / **TEXT** / **REVEAL** /  
  
 For teletext operation or USB operation

---

## Use the Remote Control

When using the remote control, please aim the remote control transmitter at the remote sensor on the TV. Make sure no obstacles stay between the remote control and TV.

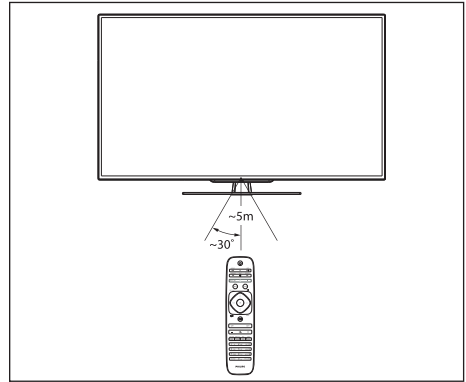

## 3. Use the TV

The basic operations are described in this section.

---

## Switch to Standby Mode

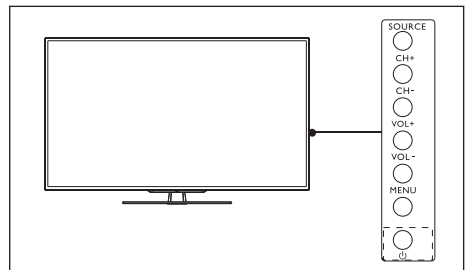



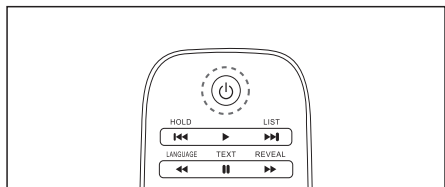

## Switch the TV on

- If the indicator is not lit, please plug the power cord into the power socket.
- press the  (Power/Standby) key on the remote control or the power key on the side panel of the TV.

## Switch TV to standby

- Press the  (Power/Standby) key on the remote control.



Tips:

- The TV still consumes a little power in standby mode. If you will not use the TV for long, please unplug the TV's power cord.

## Switch the Channel

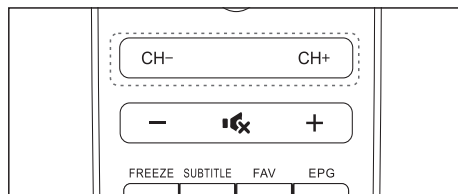
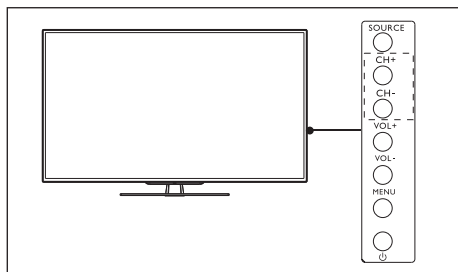

- Press the **CH+/-** key on the remote control or **CH+/-** key on the side panel of the TV.
- Choose a channel using the numeric keys on the remote control.

---

## View Connected Devices



Note:

- Please turn on the external device connected to the TV before selecting the signal source.

Use the Source Key

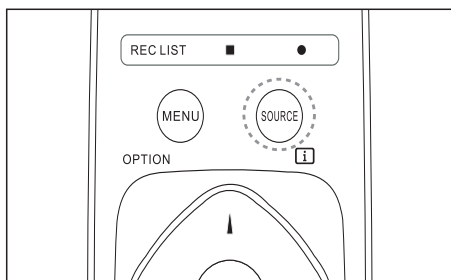

1. Press the **Source** key.  
↳ The list of signal sources appears.
2. Press **▲▼** to choose a device.
3. Press the **OK** key to select it.  
↳ The TV is switched to the selected signal source.

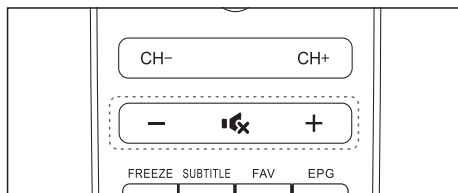

Increase or reduce the volume:

- Press the **+/-** key on the side panel of the TV or on the remote control.

Mute or unmute the sound:

- Press the **🔇** key to disable audio output.
- Press the **🔇** key again to unmute the sound output.

---

## Adjust the Volume

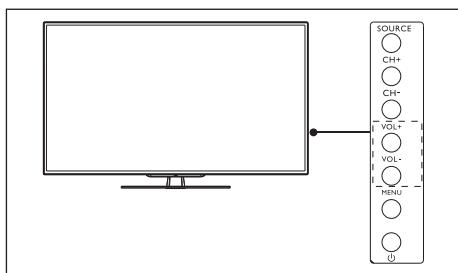

## 4. General Operating Instructions

### Signal Source Selection



Press "SOURCE" key either on the remote control or on the panel. "Input Source" will be displayed on the screen. Then press "↑/↓" key on remote control or "CH+/CH-" key on the panel to select the signal source.

Press "OK" key on the remote control and the TV will switch the current signal source to the source which you select.

### Other Functions

Access the TV Menu

You can enter the menu to set up the channel, change settings on image and sound and access other functions

- Press the Menu key.
- The menu is displayed.

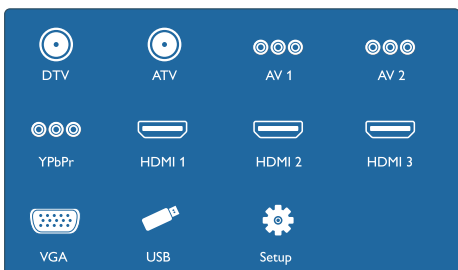

- **Setup**  
change the image, sound and other settings.
- **Change the Language**  
You can change the menu language.
- **Change the menu language:**
  1. Press the Menu key.
  2. Select [Setup] → [Options] → [Menu Language], and then press "→" to enter.
  3. Select a language.
- **Change the Image and Sound Settings**  
You can use the predefined image and sound settings or change the settings manually.

#### ☰ Note

- When watching the TV or a connected device, you can press the "PICTURE" key or "SOUND" key to enter the image and sound settings directly.

### CHANNEL

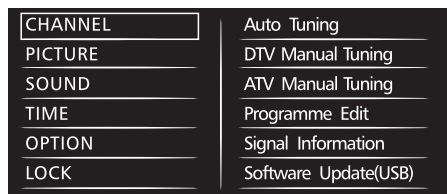

Set up the Channels

When you make TV settings for the first time, you need to select a menu language and search for TV channels.

## ● AUTO tuning

Step 1: Select a menu language

1. Press the Menu key.
2. Select [Setup] → [OPTION] → [OSD Language] and then press "→" key.
3. Select your desired language.

Step 2: Channel auto scan

1. Press the Menu key.
2. Select [Setup] → [CHANNEL] → [Auto tuning] and then press "→" key.
3. Press the OK key to start the auto scan.

## ● DTV manual setting channels

Confirm the input signal is digital TV before searching

1. Press [CHANNEL] → [DTV Manual Tuning]
2. Choose your [color system], [sound system]
3. Press "↑/↓" button to search.

## ● ATV manual setting channels

Confirm the input signal is analog TV before searching.

1. Press [CHANNEL] → [ATV Manual Tuning]
2. Choose your [color system], [sound system]
3. Press "↑/↓" button to search.

## ● Programme Edit

1. Press the Menu key.
2. Select [Setup] → [CHANNEL] → [Programme Edit].
3. Press "↑/↓" to select a channel and press to select [Delete], [Move], [Favorite], [Skip].

## ● Software Update (USB)

Open or close software update function by pressing "OK" key.

## PICTURE

CHANNEL	Picture Mode
PICTURE	Contrast
SOUND	Brightness
TIME	Color
OPTION	Tint
LOCK	Sharpness
	Color Temperature
	Picture Format
	Noise Reduction

### ● Picture Mode:

You can use the predefined image settings. Select one of the following options (Dynamic, Standard, Soft, User).

### ● Contrast:

adjust the backlight and increase the difference in backlight intensity between the bright area and dark area.

### ● Brightness:

Adjust brightness and blackness of whole picture.

### ● Color:

Adjust the color of whole picture.

### ● Tint:

Adjust the tint of whole picture.

### ● Sharpness:

Adjust the sharpness of whole picture.

### ● Color temperature:

Select Color Temperature.

### ● Picture format:

You can select from the image formats.

Note: Some of the image formats may not be available for some signal sources.

### ● Noise reduction:

filter and reduce the noise in the image.

## SOUND

CHANNEL	Sound Mode
PICTURE	Bass
SOUND	Treble
TIME	Balance
OPTION	Auto Volume
LOCK	Surround Sound
	Digital Audio Out

- **Sound mode:**  
You can use the predefined sound settings. Select one of the following options (Standard, Music, Movie, Sports, User).
- **Bass:**  
Adjust bass value.
- **Treble:**  
Adjust the treble.
- **Balance:**  
Adjust balance of left or right sound
- **Auto volume:**  
suppress sudden change in volume when switching the channel.
- **Surround sound:**  
Press "→" key to enter into Surround Sound submenu. Press "↑/↓" key to select surround sound mode: Off, Surround.
- **Digital Audio Out:**  
Press "→" key to select "PCM" or "Auto".

## TIME

CHANNEL	Clock
PICTURE	Off Time
SOUND	On Time
TIME	Sleep Timer
OPTION	Time Zone
LOCK	

- **Clock:**  
When in DTV input source, The clock will be synchronized with TV programme .
- **Off Time:**  
Press "→" key to enter into Off Time submenu. Press "↑/↓" key to select Off Time, Hour and Minute, then press "←/→" key to adjust value to set the off timers that the TV will switch off automatically at the time you select.  

 Note

  - You can set Hour and Minute only the Off Time is not under "Off" Mode.
- **On Time:**  
Press "→" key to enter into On Time submenu. Press "↑/↓" key to select On Time, Hour and Minute, DTV, channel, Volume, then press "←/→" to adjust value to set the on timer that the TV will switch on automatically and tune to the mode of your choice at the time you select.
- **Sleep timer:**  
Press "OK" key to enter into Sleep Time submenu. Press "↑/↓" key to select sleep time: Off, 10min, 20min, 30min, 60min, 90min, 120min, 180min, 240min.
- **Time zone:**  
Press "→" key to enter into Time Zone submenu. Press "↑/↓/←/→" key to select your time zone.

## OPTION

CHANNEL	OSD Language
PICTURE	Hearing Impaired
SOUND	Country
TIME	PVR file System
OPTION	Restore User Default
LOCK	Blue Screen

- **OSD language:**  
Press "→" key to Enter into OSD languages submenu. Press "↑/↓"key to select language which you wish. Press "MENU" key to return previous menu.
- **Hearing Impaired:**  
Press "→" key to select "On" or "Off".
- **Country:**  
Displays the country you selected before performing Auto Tuning function
- **PVR File System:**  
Can set the burning function of TV programs (such as burning time, speed and so on)
- **Restore User Default:**  
The screen display "Are you sure?" by pressing "OK" key .You can press "←" key to resume the factory setting or press "→" key to cancel current operation.
- **Blue Screen:**  
Press "→" key to select "On" or "Off".  
Open or close Blue Screen function.

## LOCK

CHANNEL	Lock System
PICTURE	Set Password
SOUND	Block Program
TIME	Parental Guidance
OPTION	
LOCK	

- **Lock System:**  
Press "↑/↓" key to select "On" or "Off", Block program option can work when it is on state.
  - **Set Password:**  
Press "→" key, then a dialogue box of "Set Password" appears on the screen. Press the numerical key to input old password, and input new password twice to complete the password change and return to last menu.
-  Note

  - Please make sure you remember your new password after changing.
- **Block Program:**  
Press "→" key, then a "Block Program" menu shows on the screen. Press "↑/↓" key to select the channel that you'd like to lock, and then press the green key to lock or unlock, finally press "MENU" key to exit menu operation.
  - **Parental Guidance:**  
Parents can set the watching permissions of related channels according to actual situation, to prevent their children watching unfavorable channels.

## USB Media Function

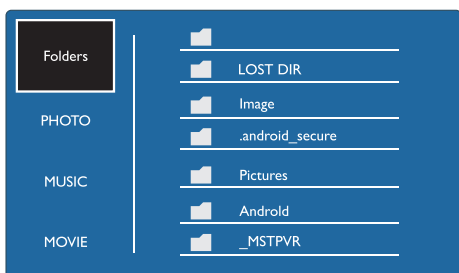

### Play USB Media

Video formats supported by USB:

- Storage device: USB storage (support FAT or FAT32 USB storage devices only).
- Multimedia files:
  - Image :JPEG
  - Audio :MP3
  - Video :MPEG 2/MPEG 4,H.264

#### Note

- Philips gives no guarantee to the compatibility with USB storage devices, and shall not be liable for any data corruption or loss caused by connecting such device to the TV.

### View Photos or Play Music and Video Files from USB Storage Device

1. Turn on the TV.
2. Insert the USB storage device to the USB port on the side of the TV.
3. Press the Menu key.

4. Select [Browse USB] and then press the OK key.

Select the USB device you've inserted and then press the OK key.

↳ Enter the USB browser.

### View Photos

1. Select [Photo] on the USB browser and then press the OK Key.
2. Select a photo or folder and then press the OK key. The photo will be auto played in full screen. |

### Listen to Music

1. Select [Music] on the USB browser and then Press the OK Key.
2. Select a song or album and then press the OK key to play it.

### Watch Videos

1. Select [Video] on the USB browser and then press the OK key.
2. Select a video and then press the OK key to play it.
3. Use the following keys to control the video playing:
  - OK : play/pause.
  - ◀/▶ : search forward or backward.

## 5. Connect Devices

You can connect devices with different interfaces to this TV .

 Note

You can connect the device to TV via interfaces of different type.

### ① Audio & Video Input of PC

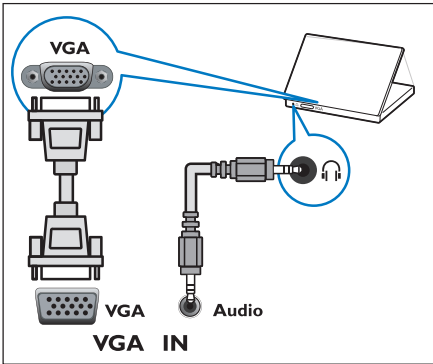

② YPbPr In/AV2 Input (Video 2 /Y Pb Pr Audio L/Audio R) You can connect to analog audio & video input from analog /digital devices like DVD players or game station.

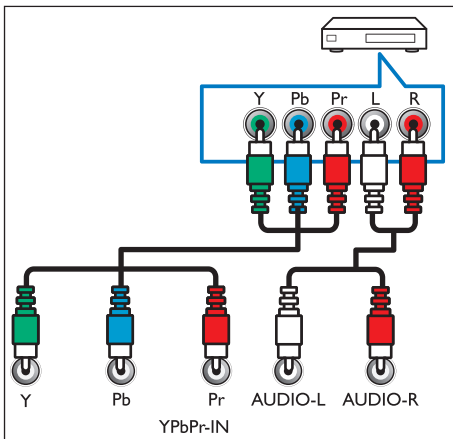

 Note

Video 2 shares the same input interface with the component Y signal, and the audio of the video 2 shares the same input interface with the component audio.

### ③ AV Input

Composite video input of analog devices like a VCR .

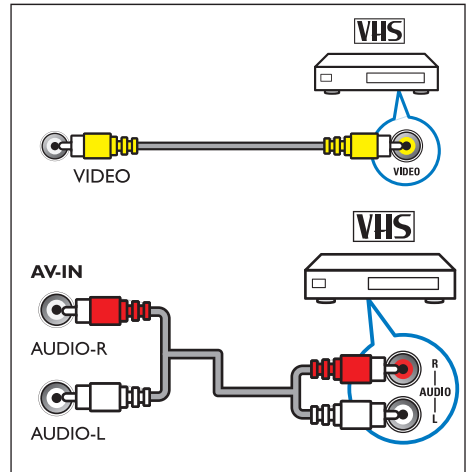

### ④ HDMI(MHL)

Digital audio and video input of HD digital devices like a Blu-ray player.

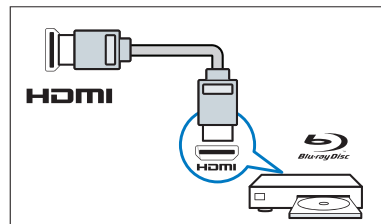

Simply connect your MHL-enabled mobile device to your TV via the MHL cable/ adapter. Everything on the mobile device will then be mirrored onto the larger TV display.



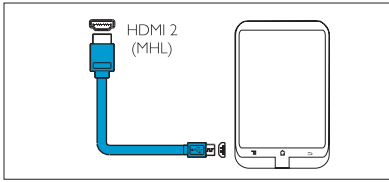

**Note**

When connected to equipment with MHL function, please select HDMI2 as input signal source. (The mobile devices must support MHL function.)

⑤ AV-OUT

Composite video output of analog devices like a VCR.

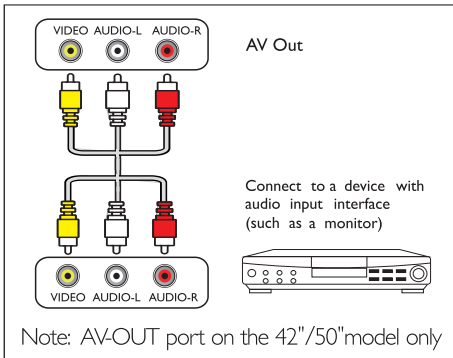

⑥ USB

Connect to USB storage device.

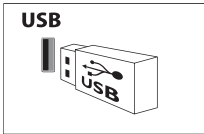

⑦ Headset

Stereo audio output to headset

**Note**

When you insert the headset, the TV speakers will be muted automatically.

⑧ Antenna/cable TV

Signal input from antenna, cable or satellite.

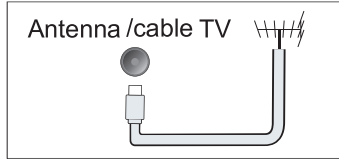

⑨ Digital Audio Out

Connect to the audio amplifier with Digital Audio interface.

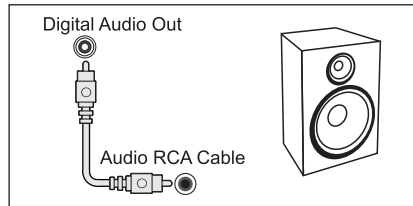

**Connect to PC**

Connect the TV to a PC.

- Select a supported resolution.
- Connect to the PC via one of the following interfaces:

**Note**

- An extra audio cable is needed when connecting via DVI or VGA.

• HDMI Cable

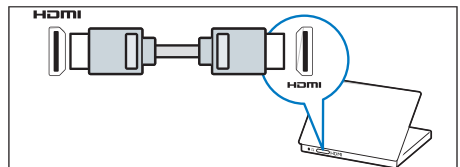

- DVI-HDMI Cable

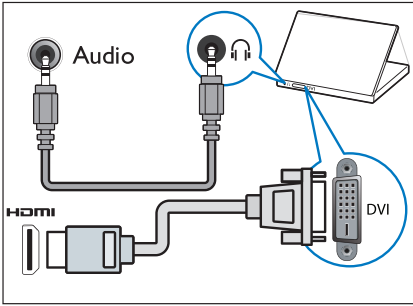

- HDMI Cable and HDMI-DVI Adaptor

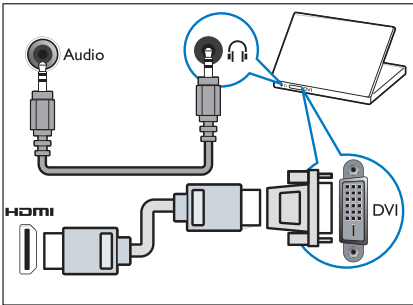

- VGA Cable

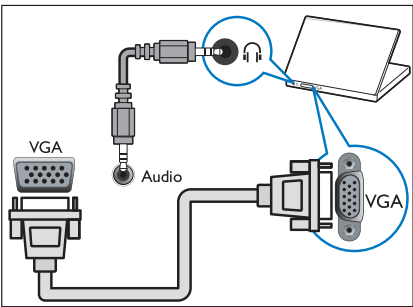

## 6. Product Information

The product information is subject to change without prior notice. For detailed product information, please refer to [www.philips.com/support](http://www.philips.com/support).

### Display Resolution Supported

PC Format

(32")

- Resolution- Refresh Rate:
- 720 × 400 70Hz
- 640 × 480 60Hz
- 800 × 600 60Hz
- 1024 × 768 60Hz
- 1360 × 768 60Hz

(42"/50")

- Resolution- Refresh Rate:
- 640 × 480 60Hz
- 800 × 600 60Hz
- 1024 × 768 60Hz
- 1360 × 768 60Hz
- 1600 × 900 60Hz
- 1920 × 1080 60Hz

Video Format

- Resolution-Refresh Rate:
- 480i -60Hz
- 480p -60Hz
- 576i -50Hz
- 576p -50Hz
- 720p -50Hz, 60Hz
- 1080i -50Hz, 60Hz
- 1080p -50Hz, 60Hz

---

## Multimedia

- Storage Devices Supported: USB storage (only support FAT or FAT 32 USB storage devices.)
- Multimedia Files Supported:
  - Image :JPEG
  - Audio :MP3
  - Video :MPEG 2/MPEG 4,H.264

---

## Tuner/Receiver/Transmitter

- Antenna Input: 75ohm coaxial(IEC75) Compatible system
  - ATV: PAL D/K,I,B/G, SECAM D/K,B/G,L
  - DTV:DVB-T

---

## Remote Control

- Battery: 2×AAA

---

## Power Supply

- Main Power Supply: 100-240V~, 50/60Hz
- Standby Energy Consumption : ≤0.5W
- Environment Temperature: 5- 40°C
- Power Consumption :  
32":55W  
42":98W  
50":130W

---

## TV Mounting Bracket

Please purchase the Phillips TV mounting bracket or equivalents compatible with VESA standard to install your TV.

Keep a minimum clearance behind the TV of 2.2 inch(5.5cm) to prevent damage to the cables and sockets.



### Warning

Please install the TV mounting bracket according to the user instructions supplied with it. Koninklijke Philips Electronics N.V shall not be liable for any accident, personal injury or loss caused by improper installation.

Screen Size (Inch)	Dot pitch (mm)	Mounting Screw
32	100×100	4×M4
42	300×200	4×M6
50	400×300	4×M6

---

## Specification

The design and specification is subject to change without prior notice as the product will be updated constantly.

32"

- Excluding TV base
  - Size ( W × H × D ) :  
732 × 432 × 71mm
  - Weight: 5.5kg
- Including TV base
  - Size ( W × H × D ) :  
732 × 482 × 220 (mm)
  - Weight: 6.0kg

42"

- Excluding TV base
  - Size ( W × H × D ) :  
963 × 559 × 71mm
  - Weight: 10.5kg
- Including TV base
  - Size ( W × H × D ) :  
963 × 618 × 235 (mm)
  - Weight: 13.0kg

50"

- Excluding TV base
  - Size ( W × H × D ) :  
1127 × 650 × 71mm
  - Weight: 15.0kg
- Including TV base
  - Size ( W × H × D ) :  
1127 × 709 × 260 (mm)
  - Weight: 18.0kg

## 7. Trouble Shooting

In case of trouble, before you ask for services, please conduct simple troubleshooting as below.

---

### Common Troubles

#### Power - on failure:

- Unplug the power cord from the socket . Reconnect it after one minute.
- Check if the mains lead is connected firmly.

#### Abnormal operation of remote control:

- Check if the battery electrodes (+/-) in the remote control are proper.
- If the battery gets exhausted or leaks, replace it.
- Clean the remote control and the TV sensor.

#### Standby indicator light flashes:

- Unplug the power cord from the socket , and reconnect it when the TV cools down.  
If this trouble still exists, please contact with the Philips customer service.

## Menu displayed in foreign language :

- Set the menu to your desired language.

## When the TV is starting or switched to standby mode, it makes squeak sound :

- No operation is needed. This is normal when the TV cools down or gets preheating.

## Channel Troubles

---

### Image Troubles

#### No image after powering on the TV:

- Check if the antenna has been connected properly.
- Check if a proper device is selected as the signal source.

#### Sound without Image:

- Check if the image setting is correct.

#### Poor signal receiving may be caused by improper antenna connection.

- Check if the antenna has been connected with the TV properly.
- The receiving quality may be affected by loudspeakers, audio device without grounding, neon light, high-rise buildings, and other massive

objects. If possible, please try to change the antenna direction or keep the said devices away from the TV to improve the receiving quality.

- In case of poor receiving quality in only one channel, please make a fine tuning for this channel.

#### Poor image quality for devices connected:

- Check if the device is properly connected.
- Check if the image setting is correct.

#### Image Size does not fit the Screen:

- Try to use another aspect ratio for image.

#### Improper image position :

- The image signal from certain devices may not fit the screen. Please check the signal output of the device.

---

## Audio Troubles

### Image without sound :



Notice

- If no audio signal can be detected, the TV will disable the audio output automatically, which doesn't mean trouble.

- Check if all cables are connected properly.
- Check if the volume is set to 0.
- Check if the sound is muted.

### **Image with poor sound quality:**

- Check if the sound setting is correct.

### **Only one speaker works:**

- Check if the Sound Balance is set to Middle.

---

## **HDMI Connection**

Trouble in HDMI Devices:

- Please notice that HDCP support may cause delay to display the content of HDMI devices.
- If the TV doesn't identify the HDMI device and display no image, please try to switch the signal source to another device, and then switch back.
- In case of intermittent sound, please check if the output setting of the HDMI device is correct.
- If you use a HDMI-DVI adaptor or a HDMI-DVI cable, please check if the additional audio cable has been connected to AUDIO port (only for the mini-jack).

---

## **Computer Connection**

Unstable Display on TV

- Check the resolution and refresh rate is supported by your PC.
- Set the TV image format to Uncompressed.

---

## **Contact Us**

If you cannot solve the troubles, please refer to [www.philips.com/support](http://www.philips.com/support) for the FAQs. If it doesn't help either, please contact with your local Philips customer service center.



### **Warning**

- DO NOT try to maintain the TV by yourself. It may result in serious personal injury, irretrievable damage to the TV, and void the warranty.



### **Notice**

- Before you contact the Philips service center, please take notes of your TV model and serial number printed on the back housing of the TV and on the package.



All registered and unregistered trademarks are the property of their respective owners. Specifications are subject to change without notice.

Philips and the Philips' shield emblem are registered trademarks of Koninklijke Philips Electronics N.V. and are used under license from Koninklijke Philips Electronics N.V.

2014© TP Vision Netherlands B.V. All rights reserved.