



MARQUE: MOULINEX

REFERENCE: 0X464810

CODIC: 4217853



NOTICE



Optimo 33L

FR

NL

DE

EN

ES

IT

PT

RU

KK

UK



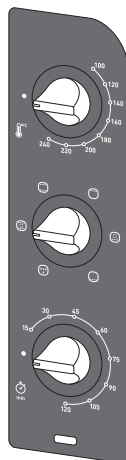
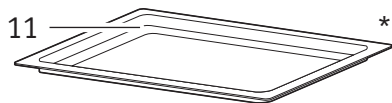
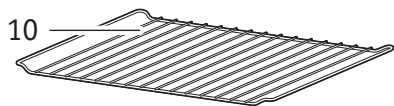
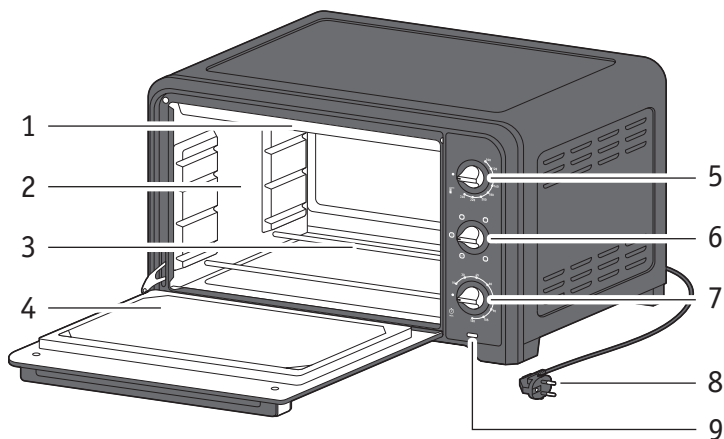

* selon modèle - afhankelijk van het model - je nach Modell - depending on the model - según el modelo - in base al modello -
 consoante o modelo - В зависимости от модели - үлгіге байланысты - залежно від моделі

DESCRIPTION

- 1 Résistance supérieure
- 2 Parois aluminium
- 3 Résistance inférieure
- 4 Porte double parois
- 5 Bouton de réglage température
- 6 Bouton des fonctions
- 7 Bouton de minuterie
- 8 Cordon d'alimentation
- 9 Voyant de fonctionnement
- 10 Grille réversible
- 11 Plat lèche-frite*

BESCHRIJVING

- 1 Bovenste verwarmingselement
- 2 Aluminium wanden
- 3 Onderste verwarmingselement
- 4 Dubbelwandige deur
- 5 Regelbare thermostaatknop
- 6 Functieknop
- 7 Timerknop
- 8 Snoer
- 9 Aan/uit-controlelampje
- 10 Omkeerbaar grillrooster
- 11 Ovenschaal*

BESCHREIBUNG

- 1 Oberes Heizelement
- 2 Aluminiumwände
- 3 Unteres Heizelement
- 4 Doppelwandige Tür
- 5 Temperaturregler
- 6 Funktionsknopf
- 7 Timer-Knopf
- 8 Netzkabel
- 9 Betriebskontrollleuchte
- 10 Umkehrbarer Grillrost
- 11 Backblech*

DESCRIPTION

- 1 Top heating element
- 2 Aluminium walls
- 3 Bottom heating element
- 4 Double-wall door
- 5 Temperature control button
- 6 Functions button
- 7 Timer button
- 8 Power cord
- 9 Power indicator light
- 10 Reversible grill rack
- 11 Food tray*

DESCRIPCIÓN

- 1 Resistencia superior
- 2 Paredes aluminio
- 3 Resistencia inferior
- 4 Puerta de doble cristal
- 5 Botón de ajuste de temperatura
- 6 Botón de funciones
- 7 Botón de temporizador
- 8 Cable de alimentación
- 9 Indicador de funcionamiento
- 10 Parrilla de grill reversible
- 11 Bandeja de comida*

* selon modèle - afhankelijk van het model - je nach Modell - depending on the model - según el modelo - in base al modello - consoante o modelo - В зависимости от модели - үлгіге байланысты - залежно від моделі

DESCRIZIONE

- 1 Elemento riscaldante superiore
- 2 Pareti in alluminio
- 3 Elemento riscaldante inferiore
- 4 Porta a doppia parete
- 5 Pulsante di regolazione della temperatura
- 6 Pulsante funzioni
- 7 Pulsante timer
- 8 Cavo di alimentazione
- 9 Spia di alimentazione
- 10 Griglia di cottura reversibile
- 11 Vassoio degli alimenti*

DESCRIÇÃO

- 1 Resistência superior
- 2 Paredes alumínio
- 3 Resistência inferior
- 4 Porta de parede dupla
- 5 Botão deregulação da temperatura
- 6 Botão das funções
- 7 Botão temporizador
- 8 Cabo de alimentação
- 9 Luz piloto de funcionamento
- 10 Grelha reversível
- 11 Tabuleiro*

ОПИСАНИЕ

- 1 Верхний нагревательный элемент
- 2 Алюминиевые стенки
- 3 Нижний нагревательный элемент
- 4 Двухслойная дверца
- 5 Кнопка контроля температуры
- 6 Кнопка выбора функций
- 7 Кнопка таймера
- 8 Кабель питания
- 9 Индикатор питания
- 10 Двухсторонняя решетка для гриля
- 11 Противень*

СИПАТТАМА

- 1 Жогарғы қыздыру элементі
- 2 Алюминий қабырғалар
- 3 Төменгі қыздыру элементі
- 4 Қос қабырғалы есік
- 5 Температураны басқару түймесі
- 6 Функциялар түймесі
- 7 Таймер түймесі
- 8 Қуат сымы
- 9 Қуат индикаторының шамы
- 10 Аударуға болатын гриль сәресі
- 11 Тамақ науасы*

ОПИС

- 1 Верхній нагрівальний елемент
- 2 Алюмінієві стінки
- 3 Нижній нагрівальний елемент
- 4 Дверцята з подвійними стінками
- 5 Кнопка регулювання температури
- 6 Кнопка вибору функцій
- 7 Кнопка таймера
- 8 Шнур живлення
- 9 Світловий індикатор живлення
- 10 Двостороння решітка для гриля
- 11 Піднос*

* selon modèle - afhankelijk van het model - je nach Modell - depending on the model - según el modelo - in base al modello - consoante o modelo - В зависимости от модели - үлгіге байланысты - залежно від моделі

1

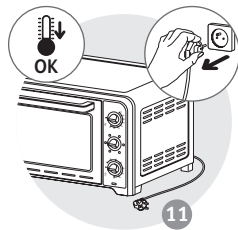
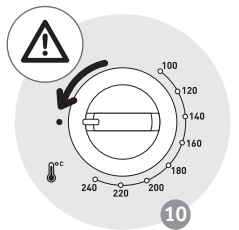
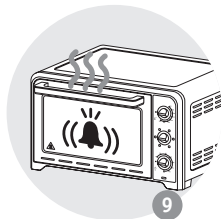
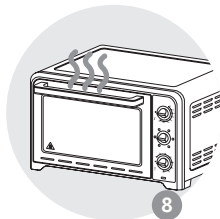
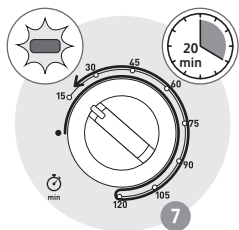
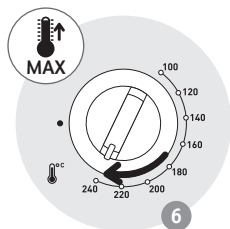
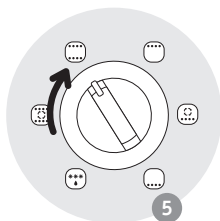
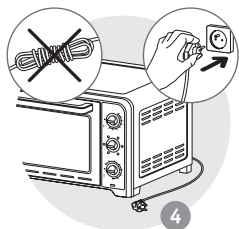
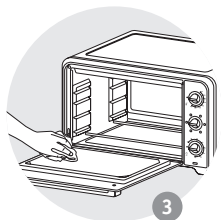
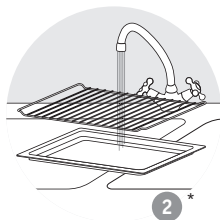
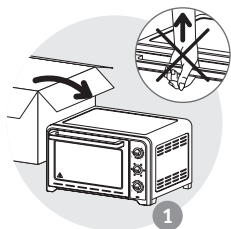

* selon modèle
afhankelijk van het model
je nach Modell
depending on the model
según el modelo
in base al modelo
consoante o modelo
В зависимости от модели
үлгіге байланысты
залежно від моделі

5

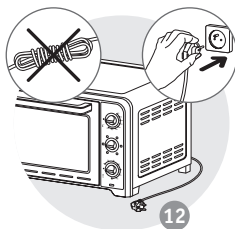

12

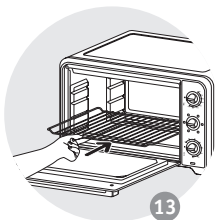

13

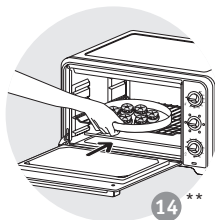

14 **

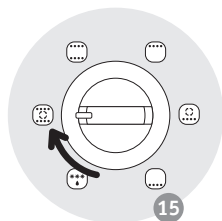

15

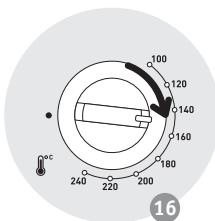

16

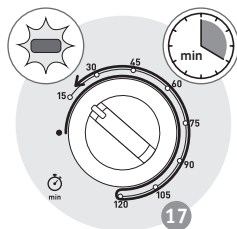

17

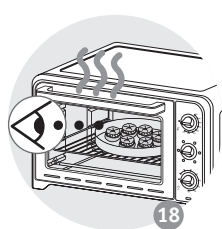

18

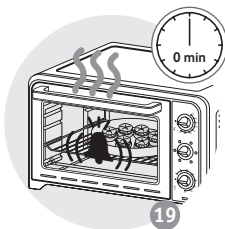

19

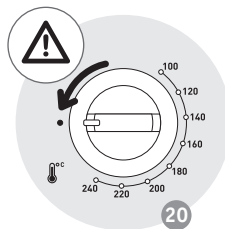

20

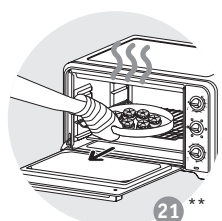

21 **

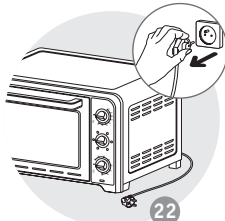

22

** Plat non fourni avec l'appareil
 Schaaf niet bij het apparaat inbegrepen
 Platte nicht im Lieferumfang inbegriffen
 The dish is not supplied with the appliance
 El plato no es suministrado con el aparato
 Piatto non fornito con l'apparecchio
 Travessa não fornecida com o aparelho
 Блюдо не входит в комплект
 Құрылғымен бірге тәелке
 қамтамасыз етілмейді
 Блюдо не входит в комплект
 поставки приладу

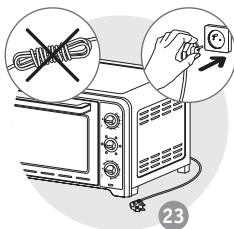

23

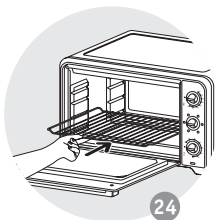

24

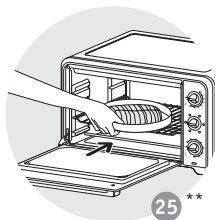

25 **

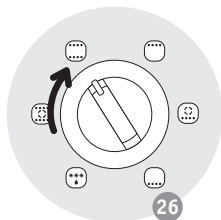

26

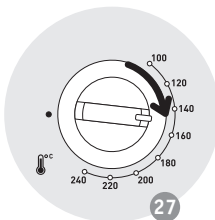

27

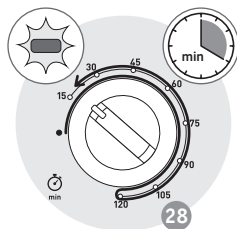

28

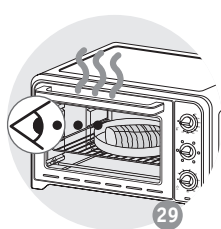

29

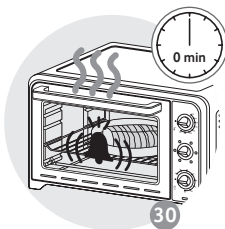

30

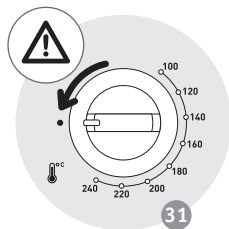

31

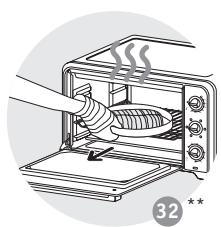

32 **

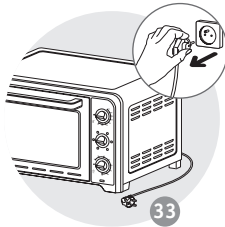

33

** Plat non fourni avec l'appareil
 Schaal niet bij het apparaat inbegrepen
 Platte nicht im Lieferumfang inbegriffen
 The dish is not supplied with the appliance
 El plato no es suministrado con el aparato
 Piatto non fornito con l'apparecchio
 Travessa não fornecida com o aparelho
 Блюдо не входит в комплект
 Құрылғымен бірге тәрелке
 қамтамасыз етілмейді
 Блюдо не входит в комплект
 поставки приладу

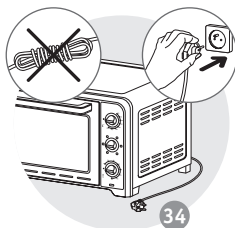

34

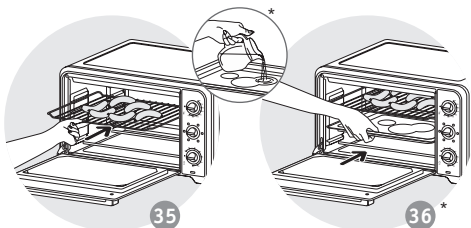

35

36*

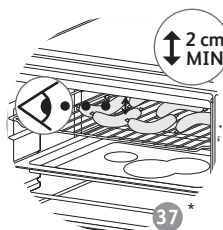

37*

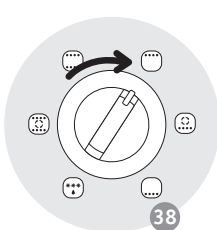

38

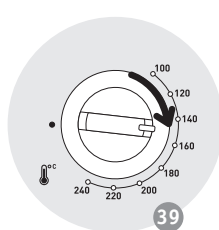

39

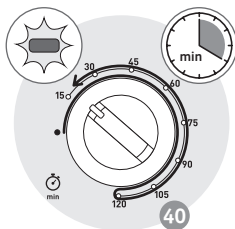

40

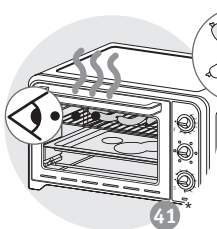

41*

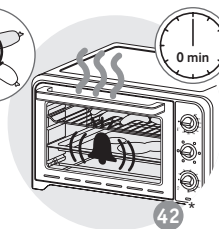

42*

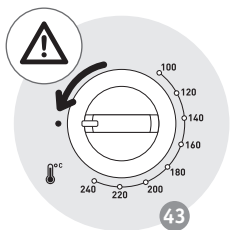

43

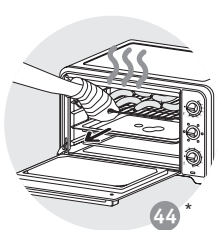

44*

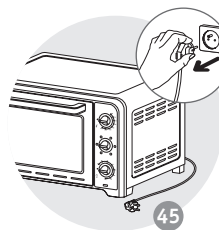

45

* selon modèle - afhankelijk van het model - je nach Modell - depending on the model - según el modelo - in base al modello - consoante o modelo - В зависимости от модели - улігіе байланысты - залежно від моделі

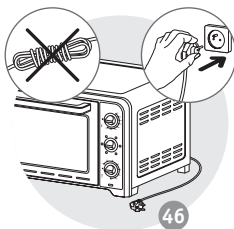

46

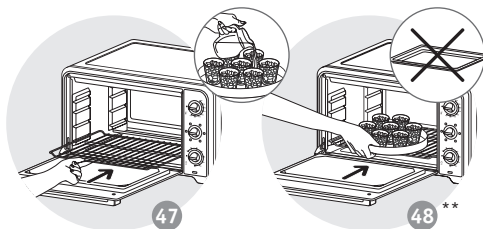

47

48 **

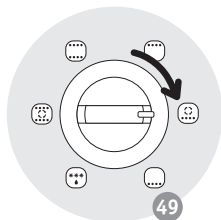

49

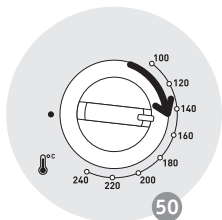

50

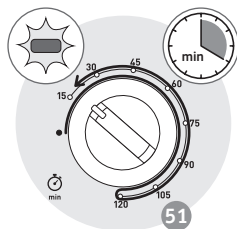

51

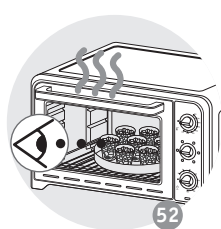

52

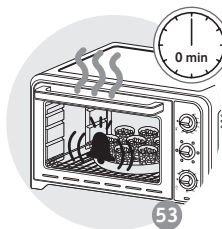

53

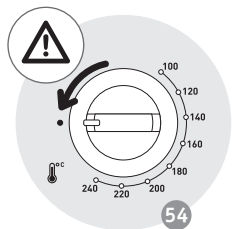

54

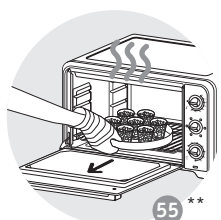

55 **

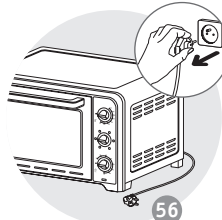

56

** Plat non fourni avec l'appareil
 Schaaf niet bij het apparaat inbegrepen
 Platte nicht im Lieferumfang inbegriffen
 The dish is not supplied with the appliance
 El plato no es suministrado con el aparato
 Piatto non fornito con l'apparecchio
 Travessa não fornecida com o aparelho
 Блюда не входят в комплект
 Құрылғымен бірге тәрелке
 қамтамасыз етілмейді
 Блюда не входят в комплект
 поставки приладу

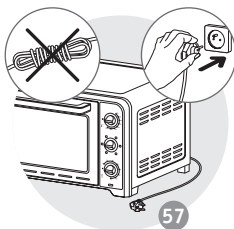

57

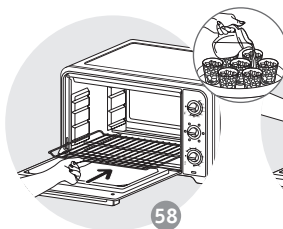

58

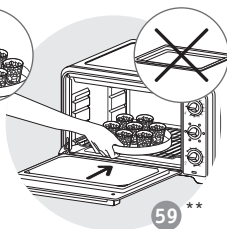

59 **

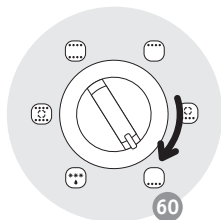

60

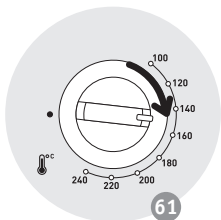

61

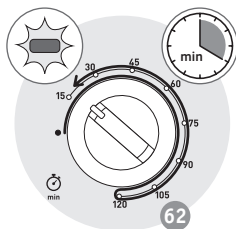

62

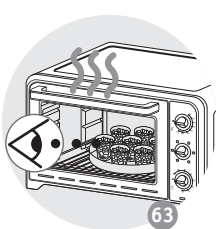

63

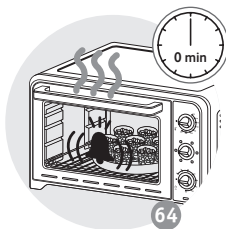

64

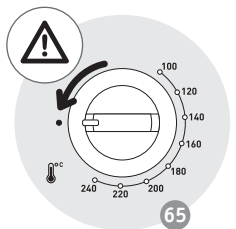

65

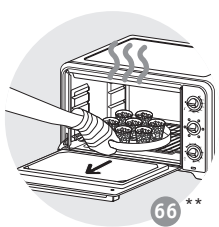

66 **

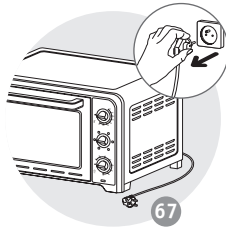

67

** Plat non fourni avec l'appareil.
 Schaaf niet bij het apparaat inbegrepen.
 Platte nicht im Lieferumfang inbegriffen.
 The dish is not supplied with the appliance.
 El plato no es suministrado con el aparato.
 Piatto non fornito con l'apparecchio.
 Travessa não fornecida com o aparelho.
 Блюдо не входит в комплект.
 Құрылғымен бірге тәелке қамтамасыз етілмейді.
 Блюдо не входит в комплект поставки приладу.

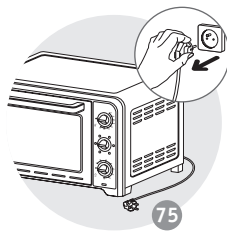
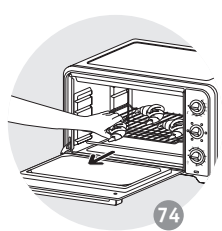
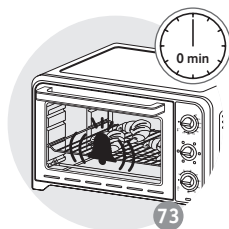
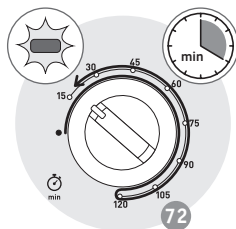
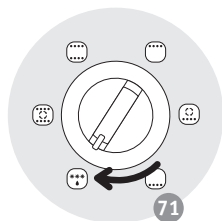
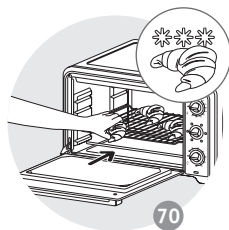
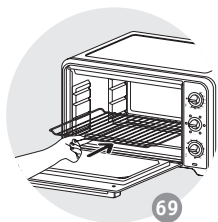
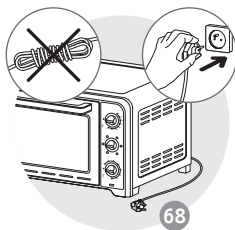

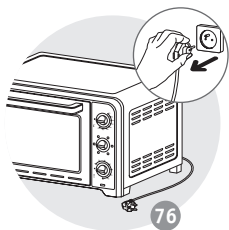

76

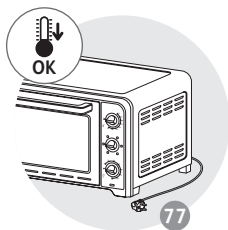

77

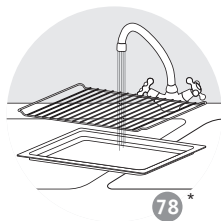

78*

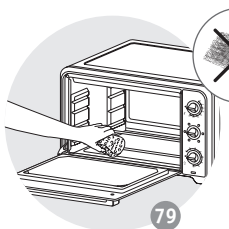

79

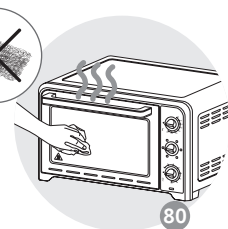

80

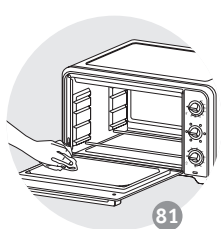

81

* selon modèle - afhankelijk van het model - je nach Modell - depending on the model - según el modelo - in base al modello -
 consoante o modelo - В зависимости от модели - үлгіге байланысты - залежно від моделі



	x4			10mins	240	18
	870g			10mins	230	56
	750g			10mins	240	40
	500g			-	240	57
	1000g			-	240	78
	x4			-	240	22
	x8			-	240	15
	350g			10mins	210	15
				10mins	240	40
	350g			10mins	240	15
				-	240	26
				10mins	200	42
				10mins	200	22
				10mins	200	35
	x6			10mins	150	10
	x6			10mins	200	18
				10mins	230	55
				10mins	240	25

