

Digital Satellite Receiver

Your Digital Partner for Life



Technomate

Your Digital Partner for Life

Eley Estate Nobel Road
Edmonton London N18 3AY

Tel. +44-(0)208-884-0701, 0545

Fax. +44-(0)208-884-0275

info@technomate.com / www.technomate.com

Technomate

Your Digital Partner for Life

User's Manual

TM-1600 2CI

Super

TM-1500 CI+

Super

TM-1000 CI

Super

TM-1000 D

Super

TM-1000 D+











Super

Digital Satellite Receiver

CONAX EMBEDDED RECEIVER



**Table of Contents**

	INTRODUCTION	2
	Overview Main Features	
	EASY INSTALLATION GUIDE	3
	SAFETY INFORMATION	6
	CHECK POINTS BEFORE USE	8
	Accessories Satellite Dish	
	CONTROLS/FUNCTIONS	9
	Front Panel Rear Panel Remote control	
	EQUIPMENT CONNECTION	13
	Connection With Antenna/ TV Set/ A/V System	
	OPERATION	14
	Getting Started System Settings Edit Channels EPG (Electronic Programme Guide) Games System Information Common Interface	
	HOW TO DOWNLOAD SOFTWARE FROM PC	33
	TROUBLE SHOOTING	35
	SPECIFICATIONS	36
	BRIEF USER'S GUIDE IN FRENCH	39

**Disposal of Old Electrical & Electronic Equipment (Applicable in the European Union and other European countries with separate collection systems)**

This symbol on the product or on its packaging indicates that this product shall not be treated as household waste. Instead it shall be handed over to the applicable collection point for the recycling of electrical and electronic equipment. By ensuring this product is disposed of correctly, you will help prevent potential negative consequences for the environment and human health, which could otherwise be caused by inappropriate waste handling of this product. The recycling of materials will help to conserve natural resources.

For more detailed information about recycling of this product, please contact your local city office, your household waste disposal service or the shop where you purchased the product.



INTRODUCTION

OVERVIEW

This satellite receiver is designed for using both free-to-air and encrypted channel reception. Enjoy the rich choice of more than 5,000 different channels, broadcasting a large range of culture, sports, cinema, news, events, etc. This receiver is a technical masterpiece, assembled with the highest qualified electronic parts.

MAIN FEATURES

- ▶ CONAX Embedded
- ▶ Supports DVB Common Interface Standard (VIACCESS, ASTON/ SECA/ MediaGuard, Irdeto, Conax, CryptoWorks, BetaCrypt and etc) * Only available on TM-1000 CI/ TM-1500 CI+/ TM-1600 2CI
- ▶ Direct key function inside the menus by remote.
- ▶ Multi picture display 9 picture on screen.
- ▶ Video games with stereo sounds.
- ▶ Digital audio 5.1 coaxial digital out put (S/PDIF)
- ▶ Zoom function.
- ▶ Auto navigation system for much easier motorised setting select as many satellite you want then auto navigate.
- ▶ On screen motor moving display and satellite locking system.
- ▶ Unique Special Tuner.
- ▶ Advanced and very easy to use Blind Search.
- ▶ Fast channel change less then 1 second.
- ▶ High sensitivity tuner for very weak signal for small dishes
- ▶ 2-45 MSPS with freq range 950MHz to 2150Mhz
- ▶ DISEqC 1.2 and USALS motorised function
- ▶ Fast auto programming and user friendly setup
- ▶ Channel sorting by alphabetical and FTA/ Scrambled/ TP Group/ ALL /A-Z
- ▶ Fully automatic scan & store of TV & radio channels of up to 70 selected satellites using DISEqC 1.2 or USALS Motor- 4 satellites using DISEqC switch, 2 satellites using (for Mono block LNB)
- ▶ 5,000 channels TV or RADIO programmable
- ▶ Color control (Contrast, Brightness, Color)
- ▶ Channel search option by All, FTA, Network, TP, TV ONLY
- ▶ RF modulator (CH 21---CH 69 PAL G, I, K, M) 100 ? 240V AC 50/60 Hz SMPS main PSU
- ▶ Supports universal, single, single S and C band wide band LNB
- ▶ 1 LNB Input (F-Type), IF signal loop through 2 SCART, TV (CVBS / RGB)
- ▶ RS-232 port for PC connections and software upgrade
- ▶ Digital audio output (S/PDIF) on RCA
- ▶ LNB short circuit protection incorporated
- ▶ 4 Digit LED front panel display
- ▶ Supports multi TV standards PAL G, I, K, M & NTSC M Screen formats 4:3 and 16:9
- ▶ 256 colour GUI (Graphical User Interface)
- ▶ SCPC & MCPC receivable from C/Ku band satellites
- ▶ Fully MPEG-2 digital & DVB-S compliant
- ▶ On screen multi language support
- ▶ Built in Teletext function
- ▶ Support for Teletext Subtitles
- ▶ Support for DVB Subtitles
- ▶ Support for multiple language broadcasts
- ▶ EPG access for now, next and 7 days for on screen channel information
- ▶ 1 year, 8 event VCR timer facility
- ▶ Parental control facility by channel and menu locks sat locks
- ▶ Displays on screen message for antenna movement using DISEqC positioner.
- ▶ Multi favourite groups with facility to rename and categorize each group.



EASY INSTALLATION GUIDE

PART 1 Using the Preinstalled Satellite & Channel List

The receiver is preinstalled with 25 Satellites and 1500 default Channels and is fully configured. No settings need to be changed.

After turning ON the receiver, select a language. You will be taken to the Viewing mode. Press the **SAT** button on the Remote and select a Satellite. To bring up the Channel List, press the **OK** button on the remote.

To delete unwanted Satellites- press the **MENU** button on the remote and go to Installation. Press **OK** and OK on Satellite Setup. Press OK again and a Satellite List will appear. To delete a Satellite, press the **BLUE** () button on the remote.

How to Motorise 25 Satellites & 1500 Channels with USALS in 60secs

The receiver is preinstalled with 25 Satellites and 1500 default Channels, and is also fully configured. No settings need to be changed.

Press the **MENU** button on the remote. Press **OK** on Installation. Go to Motorised Setting and press **OK**. Go to the Third line (DISEqC Motor) and use the **Left/Right** arrow buttons on the remote to select **USALS**. Then go to Position Setting and press **OK**. Then go to Longitude and Latitude and enter the coordinates of where you live (London's Longitude is 000.1 West; South of UK's Latitude is 51.5 North). Press the **EXIT** button on the remote. Go to **GOTO** and press **OK**. Wait until the Signal Quality is more than 40% in the progress bar. When a Satellite is found, then all the selected 25 Satellites are fully configured for a Motorised system.

If the Signal Quality is below 40%, then the settings are incorrect and the Longitude needs to be adjusted, for example: 000.2, 000.3, 000.4, 5/6/7/8/9 **West** or **East**. The Latitude may also need to be adjusted. If you still have not got a signal, then the external installation (dish, etc) needs to be adjusted.

How to Setup a DISEqC 1.2 Motorised System

Press the **MENU** button on the remote and go to Installation and press **OK**. Go to Motorised Setting and press **OK**. Press **OK** again to open the satellite list. Select a satellite from the list and press **OK**. Go to the Third line (DISEqC Motor) and use the **Left/Right** buttons on the remote to select DISEqC 1.2. Go to Move and press and hold the **Left/Right** buttons on the remote until you get a Signal Quality of more than 40%. Go to Save and press **OK**. Press the **RED** () button on the remote to Scan. To scan extra satellites, repeat the above.

PART 2 New Installation from start (NO Satellites/Channels)

How to do a Factory Reset to Delete the Preinstalled Satellites and Channels

If you want to start the receiver without the preinstalled Satellites and Channels, press the **MENU** button on the remote and go to System Settings and press the **OK** button. Go to Factory Reset, press **OK** and enter 0000. Then select Factory Reset. Press **OK** and select Yes.

How to Install a New Satellite (Fixed Non-Motorised System)

Press the **MENU** button on the remote and press the **OK** button on Installation. Press **OK** on Satellite Setup and **OK** again to display a Satellite List. To add a Satellite, press the **YELLOW** () button on the remote. Press the **EXIT** button on the remote to exit the list.

When the Quality Bar is at its highest level, press the **RED** () button on the remote to Scan the Satellite. To view a channel, press the **OK** button in the Viewing Mode (clear screen) and select any channel. To view \$ (Scrambled) channels, a CAM (Decoder) and a viewing card are required.

How to Setup a Monoblock or DiSEqC Switch (up to 4 LNBs / Dishes)

Press the **MENU** button on the remote and press the **OK** button on Installation. Press **OK** on Satellite Setup and **OK** again to display a Satellite List. Select a Satellite (e.g. Hotbird 13E and Astra 19.2E) and press the **YELLOW** button on the remote for each Satellite to Save. Press the **EXIT** button on the remote to exit the list.

Go to DiSEqC Switching and select a Satellite (e.g. Hotbird 13E as Number 1 and Astra 19.2E as Number 2). When the Quality Bar is at its highest level for each Satellite, press the **RED** () button on the remote to Scan. To view a channel, press the **OK** button in the Viewing Mode (clear screen) and select any channel. To view \$ (Scrambled) channels, a CAM (Decoder) and a viewing card are required.

If the above installation was not successful, change the DiSEqC Switching number, e.g. Hotbird 13E as Number 2 and Astra 19E as Number 1.

How to Setup a DiSEqC 1.2 Motorised System

Press the **MENU** button on the remote and press the **OK** button on Installation. Press **OK** on Satellite Setup and **OK** again to display a Satellite List. Select a Satellite (e.g. Hotbird 13E and Astra 19.2E) and press the **YELLOW** button on the remote for each Satellite to Save. Press the **EXIT** button on the remote to exit the list.

Press the **EXIT** button again. Press **OK** on Motorised Setting. Press **OK** again to display a Satellite List. Select a Satellite and press **OK**. Go to the Third line (DiSEqC Motor) and use the **Left/Right** buttons on the remote to select **DiSEqC 1.2**. Go to Move and press and hold the **Left/Right** buttons on the remote until you get a Signal Quality of more than 40%. Go to Save and press **OK**. Press the **RED** button on the remote to Scan. Repeat the above for more satellites.

How to Setup a USALS Motorised System

Press the **MENU** button on the remote and press the **OK** button on Installation. Press **OK** on Satellite Setup and **OK** again to display a Satellite List. Select a Satellite (e.g. Hotbird 13E and Astra 19.2E) and press the **YELLOW** () button on the remote for each Satellite to Save. Press the **EXIT** button on the remote to exit the list.

Press the **EXIT** button again. Go to Motorised Setting and press **OK**. Go to the Third line (DiSEqC Motor) and use the **Left/Right** arrow buttons on the remote to select **USALS**. Then go to Position Setting and press **OK**. Then go to Longitude and Latitude and enter the coordinates of where you live (London's Longitude is 000.1 West; South of UK's Latitude is 51.5 North). Press the **EXIT** button on the remote. Go to **GOTO** and press **OK**. Wait until the Signal Quality is more than 40% in the progress bar. Press the **RED** () button on the remote to Scan.

If the Signal Quality is below 40%, then the settings are incorrect and the Longitude needs to be adjusted, for example: 000.2, 000.3, 000.4, 5/6/7/8/9 West or East. The Latitude may also need to be adjusted. If you still have not got a signal, then the external installation (dish, etc) needs to be adjusted.

How to restore default channels

Press **MENU** button on the remote. Go to **Factory Reset**, then go to **Restore default channels**. Press **OK** button on the remote, and input password and wait. It will retrieve default channels.

Active Transponders

For Technomate Motorized Systems

No.	Satellite Name	Degree	Frequency	Symbol Rate	Polarity
1	PAS 45 IR	45.0° W	11510	26694	H
2	TELESTAR 11	37.5° W	11494	19500	H
3	HISPASAT	30.0° W	11811	27500	H
4	NSS803-K	21.5° W	11605	40000	H
5	INTEL 901	18.0° W	11673	28571	H
6	TELESTAR 12	15.0° W	11124	18386	H
7	ATLANTIC 81	12.5° W	11132	03255	H
8	EXPRESS 3A	11.0° W	11464	04340	V
9	TELECOM 2D	8.0° W	12747	02894	H
10	NILESAT 101	7.0° W	11747	27500	V
11	ATLANTICBIRD 3	5.0° W	12543	27500	H
12	THOR 707 -2/3	1.0° W	11229	24500	H
13	SIRIUS 2	5.0° E	11766	27500	H
14	EUTEL W3	7.0° E	11263	27500	H
15	EUTEL W1	10.0° E	11526	30000	V
16	HOTBIRD	13.0° E	10892	27500	H
17	EUTEL W2	16.0° E	11304	30000	V
18	ASTRA 1	19.2° E	12692	22000	H
19	ASTRA 3A	23.5° E	11634	27500	H
20	ARABSAT 2A	26.0° E	11958	27500	H
21	ASTRA 2	28.2° E	11469	27500	H
22	EUTEL W4	36.0° E	12698	04340	H
23	HALLAS SAT	39.0° E	12524	29000	H
24	TURKSAT 1C	42.0° E	12652	22500	H
25	EUROSTAR 1	45.0° E	11500	04340	V



SAFETY INFORMATION

Be sure to read the user's manual before starting the operation of the unit.

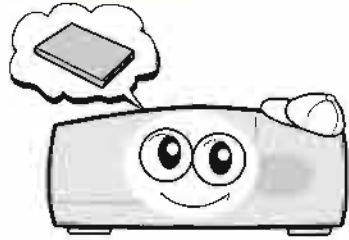

Never open the cover. It is very dangerous to touch the inside of the unit due to the possibility of an electric shock.



When you do not use this unit for a long time, make sure that the power cord is pulled out from the outlet. Also do not use a damaged power cord as it may cause fire or electric shock.

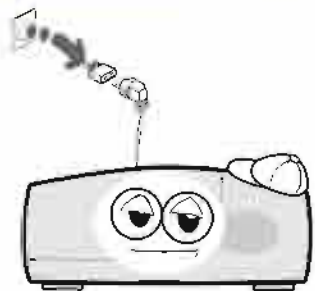

Do not touch the power cord with wet hands as it may cause electric shock.

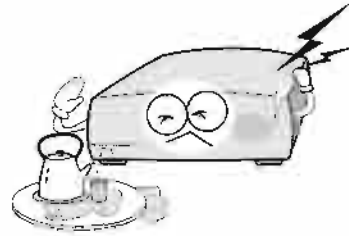

Place the unit in a well ventilated and no-heat environment.

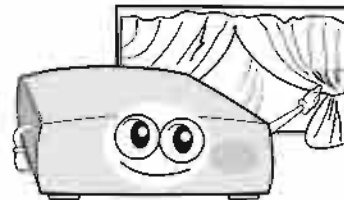

A professional installation is required. If reception is interrupted, contact your local service centre.

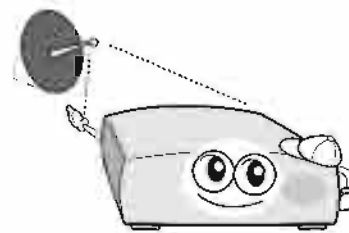

Place the unit horizontally. An uneven placement may cause the unit to be damaged.

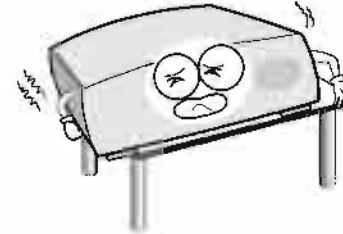

Do not leave the unit near water.

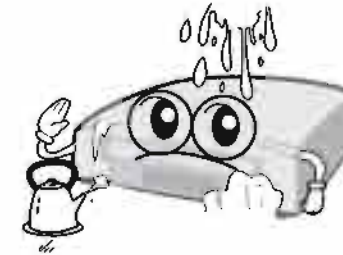

Do not install the unit :
 • Where it is subject to vibrations.
 • Where it is exposed to direct sunlight.
 • Where there is humidity.
 • Where the temperature is too high or too low.
 • Where there is no ventilation.

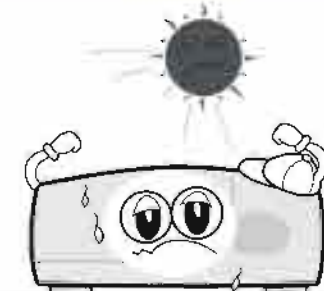

Do not put heavy items such as a TV on the unit. This may damage the unit.

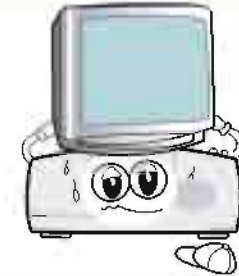

Do not put water containing items such as vase on the unit.

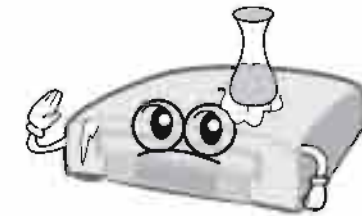

Moving the unit to a hot area from a cold one will cause condensation. Do not operate the unit for one or two hours or until it has dried completely.

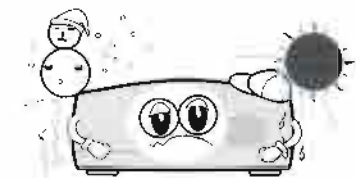

CHECK POINTS BEFORE USE

ACCESSORIES

User's manual : 1

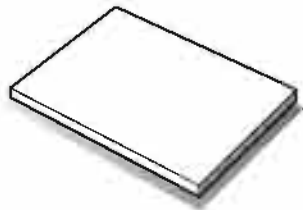

Remote control : 1



Batteries (AAA type) : 2

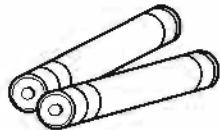

Power cord : 1

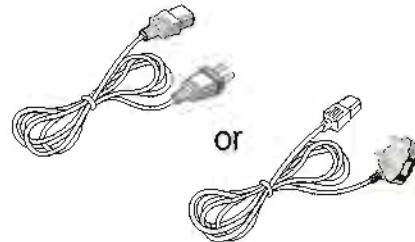

If any accessories listed above are missing, contact the sales representative where you purchased this unit.

SATELLITE DISH

Your dish should be properly installed and azimuth and elevation must be precisely set up. This unit is working with DiSEqC 1.2 on a compatible antenna positioner. Ask your dealer for more information.

CONTROLS/ FUNCTIONS

FRONT PANEL



1. Standby/Power on indication light :

Red on **stand-by** mode and no light on **power-on** mode.

2. Remote command indication light :

By pressing any remote button, this light will flash at the same time.

3. Power :

To switch the receiver in **stand-by** mode or in **power-on** mode.

4. CH. (▲/▼) :

To change channel or cursor position on the application screen.

* *TM-1000 D: FTA. If you want to view scrambled channels, you need to use TM-1000 CI/ TM-1500 CI+/ TM-1600 2CI with a original card and CAM (Conditional Access Module)*

* *TM-1000 D+ : FTA and one card reader*

* *TM-1000CI: One CI slot to view scrambled channels. You need original card and CAM (Conditional Access Module)*

* *TM-1600 2CI: 2CI slots as above but with extra CI slot for using 2 cams at the same time.*

* *TM-1500 CI+: One CI slot and one card reader.*

REAR PANEL

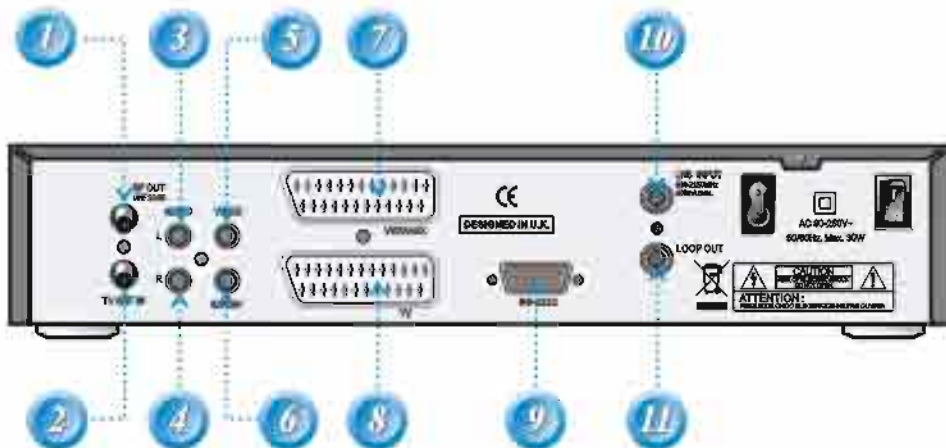

No.	Name	Connector	Function
1	RF OUT UHF 21-69	IEC 169-2 male	Output to TV
2	TV ANT IN	IEC 169-2 female	Input from terrestrial antenna
3	AUDIO L	RCA cinch	Left audio output
4	AUDIO R	RCA cinch	Right audio output
5	VIDEO	RCA cinch	Composite video output
6	S/PDIF	RCA cinch	Digital audio output
7	VCR/AUX	SCART	SCART CVBS Video Output CVBS, RGB Input Audio Output
8	TV SCART	SCART	CVBS, RGB Output Audio Output
9	RS-232C	DB-9	Low speed serial port
10	LNB INPUT	IEC 169-24 female	IF input from LNB to digital tuner
11	LOOP OUT	IEC 169-24 female	IF loop-through output from digital tuner

* Note : Some models are different and TV input could be on the top or bottom scart. Please look before connection.

REMOTE CONTROL



1. **POWER:** To turn the receiver On/Off
2. **MUTE:** To turn the sound On/Off
3. **TV/SAT:** To switch between the satellite input and UHF/VHF antenna input
4. **SLEEP:** To adjust sleep timer
5. **Numeric Keys (0-9):**
To Control the numerical operation and channel numbers directly
6. **TV/RADIO:**
To switch between TV and Radio
7. **Sort:** To sort channel list
8. **A-Z:** To sort channel list
9. **EPG (Electronic Program Guide):**
To show the TV/Radio program guide or to move to the previous pages
10. **LANGUAGE:**
To show multilingual audio channel
11. **FAV:** To show favorite list in the favorite group or to move to the next pages
12. **MENU:** To display main menu
13. **EXIT:** To Exit from the present menu and moves to the previous menu
14. **SAT:** To show satellite list
15. **BACK/RCL:**
To go to previous channel/menu

○ REMOTE CONTROL



- 16. ◀/▶: To increase/ decrease channel volume. To move left/ right in the menus
- 17. 👁/👁: To change channel up/ down. To move up/ down in the menus
- 18. OK: To show channel list. To confirm selection in the menus
- 19. COLOR: To control brightness, contrast, color of a picture
- 20. INFO: To show the information of the current program
- 21. TEXT: To shows the digital Teletext
- 22. UHF: To adjust UHF channel
- 23. EDIT: To go to Edit Channels menu
- 24. PAUSE: To pause live TV. Press this key again to return to live TV
- 25. Subtitle: To show multilingual subtitle
- 26. [Grid Icon]: To display multi picture
- 27. POS: To show the DiSEqC motor view control
- 28. Color Buttons (Red, Green, Yellow, Blue): To use special functions in the menus

EQUIPMENT CONNECTION

○ CONNECTION WITH ANTENNA/ TV SET/ A/V SYSTEM

1. Connect the TV antenna to TV ANT IN.
2. Connect the RF-IN of TV to RF-OUT.
3. Connect the Video and Audio of TV to the Video and Audio. Connect Red and White connector to Audio R and Audio L, and Yellow into Video port respectively.
4. Connect your satellite dish.

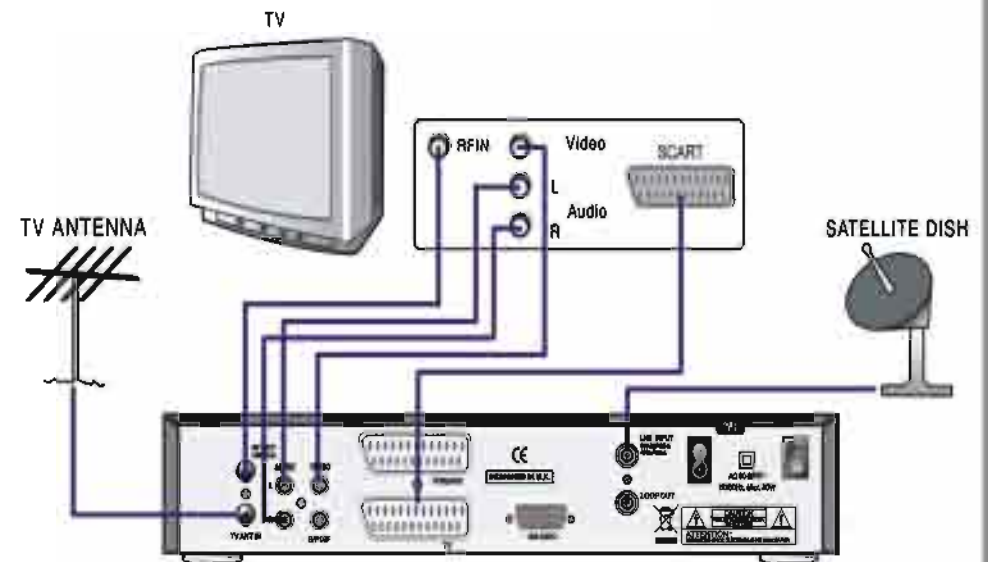

* Note : In some receivers TV scart is at the top or bottom of the rear of the receiver please follow the Writing of the TV then connect your scart cable for viewing.

OPERATION

GETTING STARTED

Turn your receiver power on and proceed with system setup as follows:

Menu Language Setting



1. Turn on your TV and receiver.
2. The language selection menu will be displayed, select a language and press the **OK** button on.





Satellite Setup

1. Press the **MENU** button on the remote to display the main menu.
2. Use **◀/▶** and **▲/▼** button on the remote to move in the menu.
3. Select **Satellite Setup**, the **Satellite Setup** menu will appear.



4. Select each menu you want to edit/ change



- **Satellite:** Select any satellite by pressing **◀/▶** buttons on the remote.
- **Sat Degree:** Edit satellite degree
- **LNB Power:** Select LNB power **ON/OFF/13V/18V**
- **LNB Type:** Select your LNB Type **Single / Universal / OCS**
- **LNB Freq:** Select LNB oscillator frequency.
- **22KHz:** Select **ON/ OFF** of 0/22 KHz
- **DISEqC Switching:** Select DISEqC box type **1/ 2/ 3/ 4**

5. **Scan:** Press **Red** () button on the remote to begin satellite search.
6. **Rename:** Press **Green** () button on the remote to rename the selected satellite.
7. **Auto Navigation:** Press **Green** () button on the remote to begin auto navigation.
8. **Save:** Press **Yellow** () button on the remote to save the selected satellite.
9. **Delete:** Press **Blue** () button on the remote to de select the selected satellite.

Motorized Setting

1. Press the **MENU** button on the remote to display the main menu.
2. Use the **◀/▶** and **▲/▼** buttons on the remote to move in the menu.
3. Select **Motorized Setting**, the **Motorized Setting** menu will appear.



4. Select each menu you want to edit / change.
 - **Satellite:** Select any satellite by pressing **◀/▶** buttons on the remote.
 - **Transponder:** Displays the current TP value of the selected satellite.
 - **DISEqC Motor:** Select DISEqC Motor type **OFF/1.2/USALS**.
 - **Save:** Press **OK** button on the remote to save.
5. **Scan:** Press **Red** () button on the remote to begin satellite search.
6. **Auto Navigation:** Press **Green** () button the remote to begin auto navigation

DISEqC 1.2 Setup

1. Select DISEqC 1.2 on **DISEqC Motor**, the the DISEqC 1.2 menu will appear.



- **Satellite:** Select any satellite by pressing ◀/▶ buttons.
- **Transponder:** Displays the current TP value of the selected satellite.
- **DISEqC Motor:** Select DISEqC 1.2
- **Move:** Move the dish position to west/east by pressing ◀/▶ buttons.
- **Move Fine:** Move the dish position 1 step at a time to west/ east by pressing ◀/▶ buttons.
- **Limit Setting:** Set limit by pressing OK button on the remote.
 - **Delete Limit:** Delete east and west limit.
 - **Goto Reference:** Move the dish to the 0 position.
 - **Set East Limit:** Edit & Save east limit by pressing ◀/▶ or OK buttons.
 - **Set West Limit:** Edit & Save west limit by pressing ◀/▶ or OK buttons.
- **Go To:** Go to the position of the saved satellite.
- **Save:** Save the current setting of DISEqC 1.2 system.



2. **Scan:** Press **Red** () button on the remote to begin satellite search.

3. **Auto Navigation:** Press **Green** () button on the remote to begin auto navigation.

USALS System Setup

1. Select USALS on **DISEqC Motor**, the **USALS** menu will appear.

- **Satellite:** Select any satellite by pressing ◀/▶ buttons.
- **Transponder:** Displays the current TP value of the selected satellite.
- **DISEqC Motor:** Select DISEqC Motor **USALS**.
- **Move:** Move the dish position to West/East by pressing ◀/▶ buttons.
- **Limit Setting:** Select Limit Setting by pressing OK button.
 - **Delete Limit:** Delete limit by pressing OK button.
 - **Goto Reference:** Goto reference by pressing OK button.
 - **Set East Limit:** Edit & Save east limit by pressing ◀/▶ or OK buttons.
 - **Set West Limit:** Edit & Save west limit by pressing ◀/▶ or OK buttons.
- **Sat Degree:** Displays the current degree of the selected satellite.
Edit degree by pressing ◀/▶ buttons and numeric buttons.
- **Position Setting:** Select position setting by pressing OK button.
 - **Goto Reference:** Move the dish to the 0 position.
 - **Antenna Longitude:** Edit antenna longitude by pressing ◀/▶ buttons and numeric buttons.
 - **Antenna Latitude:** Edit antenna latitude by pressing ◀/▶ buttons and numeric buttons.
- **Go To:** Save the current setting of USALS System.



2. **Scan:** Press **Red** () button on the remote to begin satellite search.

3. **Auto Navigation:** Press **Green** () button the remote to begin auto navigation

* Note: When you change each parameter, you need to know exact parameter of the LNB to modify L.O(local oscillator) frequency.

DISEqC Motor View Control

1. Select **DISEqC 1.2** or **USALS** in the **Motorized Setting** menu.

2. In the viewing mode, Press **POS** button on the remote to display **DISEqC Motor View Control**.

3. Press ◀/▶ buttons on the remote to move **DISEqC Motor** to get the best signal.



Auto Navigation

All the available channels/satellites can be searched in this menu. Select the satellite and save before **Auto Search**.



1. Press the **MENU** button on the remote to display the main menu.

2. Use the ◀/▶ and ▲/▼ buttons to move in the menu.

3. Select **Auto Navigation**, **Auto Navigation** menu will appear.

4. Select the satellites you want to search by pressing the **OK** button on the remote. You can select more satellites by pressing the ◀/▶ button and **OK** button on the remote.

- **Search Type:** Select the type of channel search you want by pressing ◀/▶ buttons on the remote.
 - **All:** To search all the Free To Air and scrambled channels, TV & Radlo channels.
 - **Free:** To search Free To Air channels only.
 - **TV:** To search TV channels only.
- **Network Search:** Select Network Search **ON/ OFF** to find more transponders through NIT Search.



- **Scan:** Begin channel search of the selected satellite.

5. **Auto Navigation:** Press **Red** () button on the remote.

6. **Auto Navigation Blind Search:**

Press **Green** () button on the remote to begin channel search of all of the satellite in the satellite list.

** Note: Make sure that the signal level of the selected satellites is high by the signal quality bar. If the signal quality is lower than 50%, go back to Satellite Setup and check LNB, DiSEqC Switching, etc.*

Blind Search

Provides easier and thorough channel search option to users

1. Press the **MENU** button on the remote to display the main menu.

2. Use the **◀/▶** and **▲/▼** buttons to move in the menu.

3. Select **Blind Search**, the **Blind Search** menu will appear.

4. Select the satellites you want to search by pressing **OK** button on the remote. You can select more satellites by pressing **◀/▶** button and then the **OK** button on the remote.

- **Satellite List:** Select satellite that you want to search.
- **Polarization:** Select **Vertical/ Horizontal/ All**.
- **Scan Mode:** Select **Fast/ Detail**.
- **Scan:** Begin channel search of the selected satellite.

5. **Auto Navigation Blind Search:**

Press **Red** () button on the remote to begin blind search of all of the satellite in the satellite list.



Advance Search

To edit and search channels on newly launched satellites or not preprogrammed satellites in the list.

1. Press the **MENU** button to display the main menu.

2. Use **◀/▶** and **▲/▼** buttons to move in the menu.

3. Select **Advance Search**, the **Advance Search** menu will appear.

4. Select each menu you want to edit/ change.

- **Satellite:** Select a satellite by pressing **◀/▶** buttons on the remote.
- **Transponder:** Displays the current Transponder list of the selected satellite.
- **Symbol Rate:** Displays the current symbol rate list of the selected transponder.
- **Polarization:** Select **Horizontal/ Vertical**.
- **Search Type:** Select **All Channel/ FTA Only/ TV Only**.
- **Network Search:** Select **Network Search ON/ OFF**.

5. **Scan:** Press **Red** () button on the remote to begin satellite search.

6. **Add TP:** Press **Green** () button on the remote to add new transponders by using numeric buttons **0~9** and **◀/▶** buttons on the remote.

7. **Delete TP:** Press **Yellow** () button on the remote to delete transponders.



PID Search

Edit the information of the current transponder PID/ Audio PID/ PCR PID and search the satellite.

1. Press the **MENU** button on the remote to display the main menu.

2. Use **◀/▶** and **▲/▼** buttons on the remote to move in the menu.

3. Select **PID Search**, then the **PID Search** menu will be displayed.



- **Satellite:** Select a transponder which you want to search.
- **Transponder:** Displays the Transponders of the selected satellite.
- **Symbol Rate:** Displays the current symbol rate list of the selected transponder.
- **Polarization:** Select Vertical/ Horizontal.
- **Video PID/ Audio PID/ PCR PID:** Select and edit by using numeric buttons 0~9 and ◀/▶ buttons on the remote.

4. **Scan:** Press **Red** () button on the remote to begin PID Search.
5. **Add TP:** Press **Green** () button on the remote to edit transponder by using numeric buttons 0~9 and ◀/▶ buttons on the remote.
6. **Delete TP:** Press **Yellow** () button on the remote to delete the selected transponder.

** Note: Setup is now completed. If you cannot see the programme after finishing these procedures, please contact your local dealer.*

Channel Selection

- ▶ If you know the channel number, enter the channel number by using numeric buttons on the remote and wait 2 seconds until the channel changes.
- ▶ If you know the channel name, press **OK** button on the remote, then the channel list will be displayed. Select the channel you want to watch by using ▲/▼, **OK** buttons on the remote.



1. In the right side of screen, detailed information of the selected channel is displayed. (Satellite Name, TP and Channel Name)
2. You can navigate between channels with these buttons.
 - ▲/▼ : Moves up/ down
 - ◀/▶ or ⏪/⏩ : Moves page up / page down.
 - **RED** (): Displays all channels in current satellite.
 - **GREEN** (): Displays channels sorted by alphabetical order.
 - **YELLOW** (): Displays channels sorted by transponder.
 - **BLUE** (): Displays channels sorted by FTA/ FTA + Scrambled/ CAS.

3. When the selection bar is positioned on the channel you want to see, press **OK** on the remote.

Other Functions of the Remote Control

▶ Volume Control

1. While you are watching a program me, press ◀/▶ buttons on the remote to control volume.
2. Press the **MUTE** button to turn off the sound of the program me. Press **MUTE** button again to turn the sound On.

▶ Channel Information

Displays the information of a program me by pressing **INFO** button on the remote.

▶ TV/ SAT Switching

Changes the signal reception path to RF modulator.

- TV Mode: TV ANT INPUT signal will show. (Front panel will display **TV**)
- VCR Mode: VCR SCART INPUT signal will be shown. (Front panel will display **VCR**)
- SAT Mode: Satellite signal will be out through RF. (Front panel will display channel number)

▶ TV/ RADIO Switching

Switch TV channel to Radio channel or vice versa.

▶ Back

Return to the previous channel/menu.

▶ Subtitle/ Audio

You can adjust the subtitle and audio status of the current channel.

Press **AUDIO/ SUBTITLE** buttons on the remote, then the subtitle and audio related menu will be displayed.

- Audio Mode: Stereo → Mono-Left → Mono- Right.
- Audio Track: All tracks available in this program.

** Note: These subtitle and audio parameters are available only when the receiving channel supports these functions.*

▶ Teletext

Teletext Service is a text data service from a service provider.

It is available only if the satellite broadcasts this service.

▶ SAT

Press the **SAT** button on the remote and select a satellite in the **Satellite List**.

▶ FAV

Press **FAV** button on the remote to display a favorite channel list in the favorite group.

▶ Multi-Picture Display

Press the **Yellow** () button on the remote to display multi picture mode. You can select the numbers of multi-pictures. e.g. 1x2, 2x2, 2x3, 3x3.

** Note: This option is not available on TM-1600 2CI*



► **COLOR Adjustment**

Press the **COLOR** button on the remote to select Color Adjustment menu.
By using the ◀/▶ buttons on the remote, you can adjust the brightness, contrast and the color of picture.

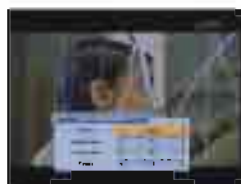

◆ **SYSTEM SETTINGS**

Time Setting

This sub-menu allows you to set your local time, wake up time, wake up channel and sleep time.

- **GMT Usage:** If you turn it ON, local time is determined by adjusting the differences from GMT (Greenwich Meantime), according to your location.
- **Current Date:** If GMT Usage is ON, this date is determined by GMT. If GMT Usage is OFF, you can modify this by pressing the **OK** button on the remote. If you set OFF, the receiver doesn't refer to GMT. Local time is determined by adjusting current date and current time.
- **Current Time:** If GMT Usage is ON, this time is determined by GMT. If GMT Usage is OFF, you can modify this by pressing any **NUMERIC** button.
- **Local Offset:** If GMT Usage is ON, the Local time is GMT time + Local Offset.
- **Wake Up Mode:** You can set the cycle of the wake up mode **Off/Once/Daily**.
- **Wake Up Time:** You can set wake up time by pressing any **NUMERIC** button.
- **Wake Up Channel:** You can set wake up channel by pressing the **OK** button on the remote.
- **Sleep Mode:** You can set the cycle of the sleep mode: **Off/Once/Daily**.
- **Sleep Time:** You can set a sleep time by pressing any **NUMERIC** button.



A/V Output Setting

This sub-menu allows you to set the audio/video output setting.

- **Audio Language:** Default audio language of the channels
- **Subtitle Language:** Default language of subtitle.
- **Video Format:** Video output format **AUTO/PAL/NTSC**.
- **Output Select:** TV SCART output format **CVBS/RGB**.
- **Screen Format:** TV aspect ratio **16:9 / 4:3 Letter-Box / 4:3 Pan Scan**.
- **RF Type:** If you set PAL in video format, this receiver supports **PAL B/G, PAL I, PAL D/K** among PAL standards.
- **PAL B/G, PAL I, PAL D/K** among PAL standards.



- **RF Channel:** Set the channel to display the audio and video signal on your TV 21~69. If you select 40, receiver will show channel 40 on your TV.
- **SPDIF:** If you turn it **ON**, digital audio output is enabled.

OSD Setting

This sub-menu allows you to set the menu language, OSD transparency, Information and volume timeout.

- **Menu Language:** Select the desired language of the menu.
- **Transparency:** Select OSD transparency of the menu. (1% ~ 100%)
- **Information Timeout:** Select the display duration of the information banner **1 sec / 2 sec / 3 sec / 5 sec / 10 sec**.
- **Volume Timeout:** Select the display duration of the volume box **1 sec / 2 sec / 3 sec / 5 sec / 10 sec**.
- **Moving Display Message:** Turn the DiSeqC moving message **ON/OFF**.



Password Setting

This sub-menu allows you to change the password option to access or lock menu entry and to change password.

- **Receiver Lock:** If you turn it ON, you will be asked to enter PIN code when power on.
- **Install Lock:** If you turn it ON, you will be asked to enter PIN code when you go to **Installation** menus.
- **Edit Channels Lock:** If you turn it ON, you will be asked to enter PIN code when you go to **Edit Channels** in the main menu.
- **Lock Channel Confirm:** If you turn it ON, you will be asked to enter PIN code when you switch to a locked channel.
- **Age Limit:** Prevents children or unauthorized people from watching the specific programs. (Free / 8 above / 12 above / 15 above / 18 above)
- **Current Password:** Enter current password to change password.
- **New Password:** Enter the new password you want to change.
- **Verify Password:** Enter new password to confirm.



* Note : The default password is 0000.



Factory Reset

This sub-menu allows you to restore the factory setting if the users encounters a problem after changing any settings.

- **Delete Radio Channels :**
Erase all radio channels.
- **Delete Scramble Channels:**
Erase all scramble channels.
- **Delete All Channels:**
Erase all channels and restore default setting.
- **Factory Reset:**
Erase all channels and restore factory default setting.
- **Restore Default Channels:**
Restores 25 satellites and approx 1500 channels pre-tuned.



Data Transfer

This sub-menu allows you to transfer the software of a receiver to another receiver.



- **Firmware:**
Transfer the firmware of a receiver to another receiver.
- **Channel Data:**
Transfer the channel data of a receiver to another receiver.
- **Games:**
Transfer the game data of a receiver to another receiver.
- **All:** Transfer all data (Firmware + Channel Data + Games) to another receiver.

EDIT CHANNELS

Set Favorites

This sub-menu allows you to set up favorite name and favorite lists. You can choose TV or Radio channels by pressing the **TV/RADIO** button. Supports is for 8 favorite groups.

1. Press the **MENU** button on the remote to display the main menu.
2. Use **◀/▶** and **▲/▼** button on the remote to move in the menu.
3. Select **Set Favorites**, **Select Favorite Group** will appear.
4. Select a favorite group by pressing the **◀/▶** and **OK** buttons on the remote. The TV/ Radio channel list will appear. If you want to edit the favorite group name, press the **RED** button on the remote. A virtual keyboard will appear.
5. Set favorite channels by pressing the **◀/▶** and **OK** buttons on the remote. The selected channels will have a heart symbol on the right. Press the **OK** button on the remote again to remove the channel from a favorite group.
6. Press the **EXIT** button on the remote to return to the previous menu.

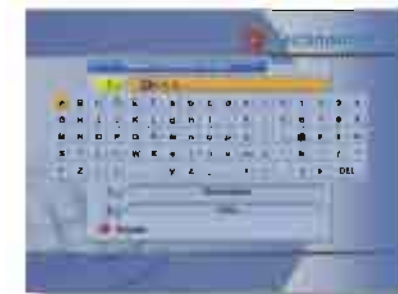

Rename CH/ Edit PIDs

This sub-menu allows you to rename the channels and input user PID. You can switch between TV or Radio channels by pressing the **TV/RADIO** button on the remote.

1. Select **Rename CH/ Edit Pids**, the **Rename CH/ Edit PIDs** menu will appear.
2. Press the **OK** button on the channel that you want to edit.
3. Press the **OK** button on **Edit Name** to rename a channel. A virtual keyboard will appear. Rename a channel by using the **◀/▶**, **▲/▼**, and **OK** buttons on the remote. Press the **EXIT** button on the remote to exit.
4. You can edit a PID by using **NUMERIC** buttons on the remote.

**Note: The VIDEO PID, AUDIO PID and PCR PID are very important for optimal satellite signal reception.*



Move Channels

This sub-menu allows you to move a channel in the list. You can switch between TV or Radio channels by pressing the **TV/RADIO** button.



1. Press the **OK** button on **Move Channels**, the **Move Channels** menu will appear.
2. Press the **OK** button to select the channel that you want to move, then arrow buttons will appear.
3. Use any **NUMERIC** buttons on the remote to move the selected channel or press **▲/▼**, **OK** buttons to move a channel.
4. Press the **EXIT** button on the remote to return to the previous menu.

Lock Channels

This sub-menu allows you to lock channels. Once the channel is locked, every time you want to watch the channel, you will have to enter the password.



** Note: If you set Lock Channel Confirm OFF, you will not be asked to enter a password even if a channel is locked.*

1. Press the **OK** button on **Lock Channels**, the **Lock Channels** menu will appear.
2. Press the **OK** button to select the channel that you want to lock. A lock symbol will appear next to the channel's name.
3. Press the **OK** button again to unlock a channel. The lock symbol will disappear.
4. Press the **EXIT** button on the remote to return to the previous menu.

Skip Channels

This sub-menu allows you to skip channels. Once a channel is skipped, every time you try to change the channel using **◀/▶** in the viewing mode, this channel will be skipped.

** Note: If you try to change the channel using NUMERIC button in viewing mode, you can watch this channel.*



1. Press the **OK** button on **Skip Channels**, the **Skip Channels** menu will appear.
2. Press the **OK** button on the remote to select the channel that you want to skip. A skip symbol will appear.
3. Press the **OK** button on the remote again to cancel skip. The skip symbol will disappear.
4. Press the **EXIT** button on the remote to return to the previous menu.

Delete Channels

This sub-menu allows you to delete channels.

** Note: If you delete a channel, you cannot watch this channel until you do a channel search again.*

1. Press the **OK** button on **Delete Channels**, the **Delete Channels** menu will appear.
2. Press the **OK** button to select the channel that you want to delete. A symbol will appear.
3. Press the **OK** button again to cancel delete. The delete symbol will disappear.
4. Press the **INFO** button to delete all channels in the current list. You will be asked to enter a password.
5. Press the **EXIT** button to return to the previous menu.



EPG (ELECTRONIC PROGRAMME GUIDE)

EPG (Electronic Programme Guide)

This sub-menu allows you to view the electronic programme guide (if available).

1. Press the **EPG** button on the remote, the **EPG** menu will appear.
2. Press the **◀/▶** to go to the previous/next **EPG**.
3. Press the **◀/▶** or **⊙/⊙** buttons to change the channel.
4. Press the **OK** button on right side of screen (Program List) and the selected programme will be reserved in the **Timer** menu. Repeat for more programmes.
5. Press the **TV/ Radio** button on the remote to view **TV/RADIO** channel list.
6. Press the **SAT/FAV** button on the remote to view the **SAT/FAV** list.
7. Press the **RED** () button on the remote, the **Timer** menu will appear.



Timer

This sub-menu allows you to set the on/off time of your receiver.



1. Press the **RED** () button in the **EPG** menu, the **Timer** menu will appear.
2. Press the **▲/▼** buttons to move to other menus.
3. Press the **◀/▶** buttons to change the selection.

- **Timer No. 1-8:** Select the timer that you want to modify.
- **State:** Select the timer: **Off/Once/Daily/Weekly**.
- **Date:** Press the **OK** button to select the date. A virtual calendar will appear.
- **Start Time:** Enter the time by using the **NUMERIC** buttons on the remote for your receiver to turn On.
- **End Time:** Enter the time by using the **NUMERIC** buttons on the remote for your receiver to turn OFF.
- **Channel:** To view the channel list, press **OK** button on the remote.

TM
Your Digital Partner for Life

GAMES

Tetris



1. Press the **OK** button on **Tetris**, the game will load.
2. Select a skill by using the **▲/▼** buttons on the remote.
3. Press the **OK** button to start a game or press the **EXIT** button to return to the previous menu.



4. Press the **OK** button to rotate the block.
5. Press the **◀/▶** button to move the block.
6. Press the **▼** button to drop the block.
7. In the top right window, you can see the next block.
8. Press the **EXIT** button to quit a game.

Sokoban

To play Sokoban, you have to push the balls into their correct positions. The balls can only be pushed, not pulled. You have to be careful not to push them into a corner where you cannot get them out again. You can only push one ball at a time.

1. Press the **OK** button on **Sokoban**, the Game will load.
2. Select a skill by using the **▲/▼** buttons on the remote.
3. Press the **OK** button to start a game or press the **EXIT** button to return to the previous menu.
4. Press the **▲/▼** or **◀/▶** buttons to move.



5. Press the **RED** () button to undo previous move. You can only undo a step once at a time.
6. Press the **GREEN** button to restart the game.
7. Press the **YELLOW** () / **BLUE** () buttons to jump to the previous/ next level. You can jump between completed levels.
8. Press the **EXIT** button to quit a game.

Snake

1. Press the **OK** button on **Snake**, the game will load.
2. You can select a skill using the **▲/▼** buttons on the remote.
3. Press the **OK** button to start a game or press the **EXIT** button the remote to return to the previous menu.
4. Press the **▲/▼** or **◀/▶** buttons to move.
5. If the snake takes **BLUE** blocks on the screen, the length will increase.
6. If the snake takes **RED** blocks on the screen, the length will decrease.
7. If the snake takes **BLACK** blocks, the game will end.
8. Press the **EXIT** button to quit a game.



SYSTEM INFORMATION

You can check the current information about your receiver, such as the receiver model name, software version, hardware version, manufacturing date, etc.



** Note: This information is necessary when you want to download a new software or you need to repair the receiver.*

COMMON INTERFACE MODELS ONLY

CAM Initializing

To watch scrambled channels, you will need a Conditional Access Module (CAM) and a Smart card which is specific to that CAM from the service provider (broadcaster).

** Note: Without a CAM and a smart card, you can watch only Free-to-Air programmes.*



1. Insert a CAM into a CAM slot in the receiver and a Smart card into the CAM.
2. The message: **CAM Initializing** will appear.
3. Once the message has disappeared, you can select the channel to watch.

Status of the CAM

1. Go to **Common Interface**. Press **OK** on the CAM to see further information of the CAM.
2. Proceed with further instructions displayed on the screen, then you can check further details depending on the CAM in use.



** Note: Further detailed information is not mentioned in this manual since the information depends on the type of CAM.*

HOW TO DOWNLOAD SOFTWARE FROM PC TO RECEIVER

1. Connect the null model cable to the RS-232C connection on the back of the receiver and to your PC
2. Download the latest version of the TM Loader from the Technomate web site (www.technomate.com)
3. Download the latest software (.STB) of your receiver. Ensure that the model number of the software is the same as the receiver you have.
4. Click on **Browse** in the TM Loader.
5. Select the file from where you saved it when you downloaded it from the Technomate website.
6. Turn ON the satellite receiver.
7. Click on **Connect** on TM Loader and then click **Start** to begin the software download
8. The downloading status is displayed.
9. Once it displays 100% Finished (wait until it has completed erasing), the software download has finished.
10. When it completes the writing of the new software, disconnect the cable between the receiver and the PC. A Factory Reset is required.
11. Go to System Information on the main menu and make sure that you have correct software version.



Note: How to download/ upload Channels

If you want to download/ upload Channels, Click on **Channels** in the TM loader, then select Download/ Upload

* Downloading Channels PC to TM-1000 Super Series

1. Click on **Download**, and then Click on **Browse** in the TM Loader.
2. Select the file from where you saved it.
3. Turn on the satellite receiver.
4. Click on **Connect** in the TM Loader and then click on **Start** to begin downloading Channels PC to TM-1000 Super Series.
5. Once it displays 100% finished, the Channel downloading has finished.

* Downloading Channels TM-1000 Super Series to PC

1. Click on **Upload**, and then Click on **Browse** in the TM Loader.
2. Select the file and folder where you want to save in your PC.
3. Turn on the satellite receiver.
4. Click on **Connect** in the TM Loader and then click on **Start** to begin uploading Channels TM-1000 Super Series to PC.
5. Once it displays 100% finished, the Channel uploading has finished..

** You can upload/ download default channels maximum 1,500 TV & Radio channels. If you want to add more than 1500 channels, you will have to do a channel search/scan.*



TROUBLE SHOOTING

There may be various reasons for the abnormal operation of a set-top box. If it does not work properly, check it according to the procedures shown in the table below.

Problem	Possible Causes	Suggested Remedy
LED on front panel does not turn ON	A/C power cord disconnected.	Connect power cord properly into the power socket.
No picture or sound	Wrong connection of the video/audio output to TV Input terminal.	Connect power cord properly into the power socket.
	Wrong connection of satellite dish/antenna cable.	Connect the dish/antenna cable correctly.
	Satellite dish/antenna is aimed a the wrong direction.	Check the cable connections, LNB and other equipment connected between the LNB and the receiver or adjust the dish/antenna.
	No signal or weak signal. Wrong setting of channel information in MENU screen.	As above. Type the setting value correctly.
Black-and-white screen or V-Hold	Your TV mode is different from satellite broadcasting mode.	Use TV of the same mode. Use the NITSC/PAL converter connected to a receiver and a TV.
Remote controller does not work	Battery exhausted.	Change the batteries.
	Fluorescent light interfering with the remote controller.	Switch off the light.
	Remote controller is incorrectly aimed. Remote type is not properly selected.	Aim the remote control at the receiver. Go to password and press 0000 then go to the bottom of page and change the remote type to type 1 or type 2.



Questions & Answers

The receiver is on but I cannot get any Menu on the screen?

- 1) Check if the scart or the RF lead is connected,
- 2) Check the A/V settings on your television is correct,
- 3) Scart cable or RF cable could be faulty therefore replace if in doubt.

The receiver is on but I cannot get any Menu on the screen?

- 1) Check if the scart or the RF lead is connected,
- 2) Check the A/V settings on your television is correct,
- 3) Scart cable or RF cable could be faulty therefore replace if in doubt.

How do I tune the RF output of the receiver to my television?

- 1) Your receiver's RF output has been Defaulted to PAL I and channel frequency 40, Apply the tuning setup application of your television.

I get the message 'no signal' displayed?

- 1) Check if the LNB cable is inserted into the IF INPUT,
- 2) Check if the LNB setup menu is correctly set.
- 3) Your satellite Dish may be out of alignment or your LNB may be faulty.
- 4) Go to Easy intallatin guide and start fresh,
- 5) contact your dealer / installer.

I cannot access a particular channel I require?

- 1) You need to check the following :
 - 1) Check if you a correct transponder.
Go to advance search ,Turn on the Network Search, press red button to tune.
 - 2) Make sure you have correct PID numbers.
b) if above dose not help go to
www.lyngsat.com
www.kingofsat.net/en/prefs.php
Please contact your Supplier for further assistance.

How can I find out what software version I have?

- 1) Press Menu on the remote,Go to sytem information press ok , Full information is displayed

I have lost my personal Lock Code setting, what do I do?

- 1) For security reason, please contact your dealer.



SPECIFICATIONS

System capabilities	Fully BVB compliant	
LNB/Tuner Input	Connector	IEC169-24, female
	Frequency range	950MHz~2150MHz
	Signal level	-65dBm~-25dBm
	LNB supply	14/18V, max 400mA
	LNB switch control	22KHz
	DISEqC	Ver1.0/1.1/1.2/USALS Compatible
Demodulafor	Front end	QPSK
	Symbol rate	2Mps~45Mps
	SCPC and MCPC Capable	
	Spectral Inversion	Auto conversion
System resource	Processor	32bit processor(80MHz)
	SDRAM	8Mbyte
	FLASH	2Mbyte
	EEPROM	32kbyte
Video decoder	MPEG2	Main Profile@Main Level
	Data Rate	Up to 15M bits/s
	Resolution	720*576,720*480
	Video format	NTSC,PAL
	Aspect Ratio	4:3, 16:9
Teletext	DVB compliant	
MPEG Audio	MPEG 1 layer 1&2	
	Type	Mono, Dual mono, Stereo, Joint Stereo
	Sampling rates	32, 44.1 and 48KHz
Serial data interface	Connector	9 pin D-sub male, Max1 15Kbps
Remote control	Code	NEC-IR
	Operating condifion	Up to 7 Meter
Power supply	Power consumption	Max 30W
	Supply voltage	90V~250V
	Supply frequency	50Hz~60Hz
Rear panel connectors	TV SCART	Video out(CVBS,RGB) Audio out
	VCR SCART	Video out(CVBS) Video In(CVBS,RGB) Audio out
	VIDEO	1X RCA/Cinch
	AUDIO L/R	2X RCA/Cinch
	S/PDIF	1X RCA/Cinch
	Serial data	9Pin D-sub
	Digital tuner Input	IEC169-24
	Loop-through Digital tuner	IEC169-24
	Terrestrial ant Input	IEC169-2
	RF modulator output	IEC169-2
RF modulator PAL G/I/K TV Type	Connector	IEC 169-2, female/male
	Frequency	470~860MHz
	Output channel number	21~69
Physical Specifcation	Size (W x H x D)	260 x 54 x 232 mm
	Weight (Net)	1.8 Kgs

Extra Remote



Remote Type 2



Remote Type 1

In certain models, this remote has been used. To make sure this remote will function correctly, go to password and press 0000, then go to bottom of the page and change the remote type according to the remote you have.

Optional Add-Ons

- **Card Reader**
(compatible with: TM-1000 D Super, TM-1000 CI Super & TM-1600 2CI Super)

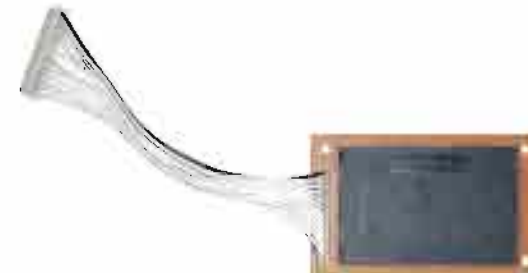

Turn your receiver to a Conax embedded in less than 5 minutes by installing this card reader ask your supplier for more details.

- **Black Housing Kit (Front Panel & Metal Case)**



Change the colour of receiver housing to black color in 5 minutes

Technomate

Your Digital Partner for Life

User's Manual

TM-1600 2CI
Super

TM-1500 CI+
Super







TM-1000 CI
Super

TM-1000 D
Super

TM-1000 D+
Super

Digital Satellite Receiver
CONAX EMBEDDED RECEIVER



	INTRODUCTION	43
	CONSIGNES ELEMENTAIRES DE SECURITE	43
	POINTS DE CONTRÔLE AVANT L'EMPLOI	45
	CONTRÔLES/FUNCTIONS	46
	EQUIPMENT CONNEXION	50
	OPERATION	50
	EN CAS DE PROBLEME	61



INTRODUCTION

Nous vous remercions de nous avoir fait confiance pour l'acquisition de votre Terminal Numérique. Nous espérons qu'il vous donnera entière satisfaction durant de nombreuses années.

Ce produit étant un appareil de haute technologie, il est nécessaire d'en prendre soin et de respecter les consignes élémentaires de sécurité que nous vous communiquons ci-dessous.



CONSIGNES ELEMENTAIRES DE SECURITE

- ✓ Avant de commencer toute opération, bien lire le manuel.
- ✓ Ne pas toucher le câble d'alimentation avec les mains humides, il pourrait causer un choc électrique.
- ✓ Ne jamais ouvrir le récepteur. Ne pas toucher l'intérieur du récepteur, ceci peut causer un choc électrique.
- ✓ Laisser libres tous les orifices de ventilation du récepteur.
- ✓ Ne surchargez pas une prise murale, un cordon prolongateur ou un adaptateur car cela pourrait entraîner un incendie ou un choc électrique.
- ✓ L'installation par un personnel qualifié est recommandée. Si la réception est interrompue, contactez votre centre de service local.
- ✓ Installez le récepteur horizontalement. Une installation non conforme peut endommager le système.
- ✓ Ne pas déposer un objet lourd comme une télévision sur le récepteur. Cela peut endommager le récepteur.
- ✓ Le récepteur ne doit pas être exposé à des gouttes ou à des éclaboussures.
- ✓ Aucun objet contenant du liquide, comme une vase, ne doit être placé sur l'appareil.

✓ Ne pas installer le récepteur :

- A un endroit sujet à des vibrations.
- A la lumière du soleil directe.
- A l'humidité.
- A une température trop haute ou trop basse.
- ou il n'y a aucune ventilation.

✓ Déplacer le récepteur d'un endroit chaud à un endroit froid provoquera de la condensation. N'allumez pas le récepteur durant une ou deux heures, jusqu'à qu'il soit complètement sec.



POINTS DE CONTRÔLE AVANT L'EMPLOI

• Accessoires

- ▶ Manuel d'utilisation
- ▶ Télécommande
- ▶ Piles (type AAA)

Si certains accessoires énumérés ci-dessus sont perdus, entrez en contact avec votre représentant afin d'en obtenir de nouveaux.

• Antenne parabolique

Votre antenne devrait être installée et orientée correctement et l'élévation doit être ajustée avec précision.

Ce récepteur est conçu pour être compatible avec DISEqC 1.2.
Demandez à votre revendeur pour plus d'informations.

 Your Digital Partner for Life





CONTRÔLES/FONCTIONS

• Panneau Frontal



1. Mise en veille / Mode fonctionnement
Voyant rouge = mode veille
Pas de voyant = mode fonctionnement.
2. Témoin de la télécommande = infrarouge
3. Mise en veille
Appuyez sur ce bouton pour alterner entre les modes fonctionnement et veille.
4. CH. (▲/▼)
Permet de naviguer dans les services vers le haut et vers le bas.

• Panneau Arrière

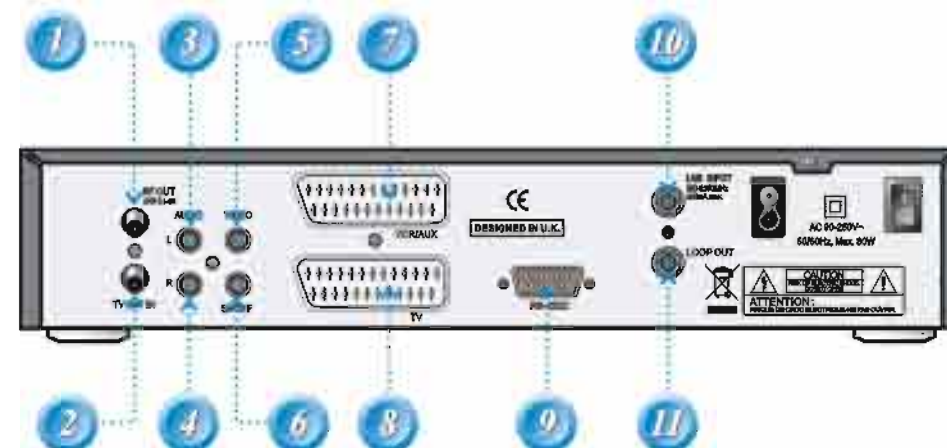

N	Nom	Connecteur	Fonction
1	RF OUT UHF 21-69	IEC 169-2 male	Sortie antenne terrestre à raccorder au téléviseur
2	TV ANT IN	IEC 169-2 male	Entrée d'antenne terrestre
3	AUDIO L	RCA cinch	Sortie audio L
4	AUDIO R	RCA cinch	Sortie audio R
5	VIDEO	RCA cinch	Sortie vidéo composite
6	S/PDIF	RCA cinch	Sortie audio digitale
7	VCR/AUX	SCART	
8	TV SCART	SCART	Sortie CVBS, RGB Sortie audio
9	RS-232C	DB-9	
10	LNB INPUT	IEC 169-24 femelle	
11	LOOP OUT	IEC 169-24 femelle	

• Télécommande



1. **POWER** : mise en fonction / mise en veille du récepteur
2. **MUTE** : coupure temporaire du son
3. **TV/SAT** : appuyez sur cette touche pour alterner entre TV et Sat
4. **SLEEP** : Réglage de l'horloge pour la mise en veille
5. **Touches numériques (0-9)**
6. **TV/RADIO** : appuyez sur cette touche pour alterner entre les modes TV et Radio
7. **SORT** : Choisir Mode Liste Des Chaînes
8. **A-Z** : Choisir Mode Liste Des Chaînes Par Ordre Alphabétique
9. **EPG** : la touche Electronic Programme Guide <Guide Electronique de programme> affiche le guide des programmes TV/Radio
10. **LANGUAGE** : affiche l'audio multilingue
11. **FAV** : Affiche la liste des chaînes préférées
12. **MENU** : Affiche sur l'écran le menu principal
13. **EXIT** : Permet de sortir d'une page - écran, et permet de retourner au menu et à l'écran précédente.
14. **SAT** : affiche la liste satellite
15. **BACK/RCL** : cette touche permet de retourner vers la chaîne précédente.

• Télécommande



16. **◀/▶** : Cette touche permet d'augmenter ou de baisser le volume et de déplacer à gauche ou à droite dans le menu.
17. **▲/▼** : Cette touche permet de déplacer la barre en surbrillance servant à la sélection d'options sur les menus. Il est également utilisé pour sélectionner la chaîne suivante ou précédente.
18. **OK** : Affiche la liste de chaînes. Confirme la sélection des éléments sur les menus.
19. **COLOR** : Réglage de la luminosité, contraste, couleur de l'image
20. **INFO** : Cette touche permet d'afficher à l'écran la boîte d'information sur les programmes.
21. **TEXT** : Affiche le système télétexte numérique
22. **UHF** : cette touche permet de régler le menu UHF
23. **EDIT** : Afficher le menu éditer chaînes
24. **PAUSE**
25. **SUBTITLE** : pour montrer le sous-titre multilingue
26. **PIP** : Afficher plusieurs image sur l'écran
27. **POS** : Afficher le Menu de Réglage Par Moteur DiSEqC
28. **Touches colorées (rouge, verte, jaune, bleue)** : à utiliser dans le menu pour des fonctions spéciales.



EQUIPMENT CONNEXION

• Raccordement avec le système A/V/ antenne / TV set

1. Raccordez TV ant IN de l'appareil à l'antenne TV.
2. Raccordez RF out de l'appareil au RF-IN de la TV.
3. Raccordez vidéo et Audio de l'appareil au TV et Vidéo de la TV.
Raccordez le connecteur rouge et blanc à audio R et audio L, et le jaune dans le port vidéo respectivement.
4. Raccordez votre antenne satellite.



OPERATION

• Démarrage

Démarrez le récepteur en appuyant sur Power et procédez à l'installation du système comme suit :

Installation du menu langue

1. Allumez votre récepteur et TV.
2. Le menu langage apparaîtra.
Sélectionnez la langue et appuyez sur la touche OK de la télécommande pour procéder.

Installation Satellite

1. Appuyez sur la touche menu de la télécommande pour faire apparaître le menu
2. Utilisez les touches ◀/▶ et ▲/▼ de la télécommande pour se déplacer dans le menu.
3. Sélectionnez Satellite Setup = installation satellite, alors le menu installation satellite s'affichera à l'écran.

Installation Satellite

4. Sélectionnez chaque menu que vous voulez éditer / changer.
 - **Satellite** : sélectionnez le satellite souhaité à l'aide des touches ◀/▶ de la télécommande.
 - **Degré de l'antenne**:
 - **LNB Power** : A l'aide des touches sélectionnez sur ON/OFF/13V/18V.
 - **LNB Type** : Sélectionnez votre type de LNB sur soit Single/Universal/OCS.
 - **Fréquence LNB** :
 - **22KHz** : Sélectionnez sur ON/OFF ou 0/22 KHz.
 - **Diseqc** :
5. **Scan** : appuyez sur la touche rouge de la télécommande pour commencer les recherches satellite.
6. **Rename= renommer** : Appuyez sur la touche verte de la télécommande pour renommer le satellite sélectionné.
7. **Save= sauvegarder** : Appuyez sur la touche jaune de la télécommande pour sauvegarder.
8. **Delete= supprimer** : Appuyez sur la touche bleue de la télécommande pour supprimer le satellite sélectionné.

Installation motorisée

Appuyez sur la touche MENU de la télécommande pour afficher le menu principal

1. Appuyez sur la touche MENU de la télécommande pour afficher le menu principal
2. Utilisez les touches ◀/▶ et ▲/▼ de la télécommande pour déplacer dans le menu.
3. Sélectionnez installation motorisée, la fenêtre suivante apparaîtra.
4. Sélectionnez chaque menu que vous voulez éditer ou changer.
 - **Satellite** : Sélectionnez le satellite souhaité à l'aide des touches ◀/▶ de la télécommande.
 - **Transpondeur** : Montre la valeur courante de transpondeur du satellite choisi.
 - **DISEqC Motor** : A l'aide des touches, sélectionnez OFF 1.2 USALS.
 - **Sauvegarder** : appuyez sur la touche OK de la télécommande pour sauvegarder.
5. Appuyez sur la touche rouge de la télécommande pour commencer les recherches.
6. Appuyez sur la touche verte de la télécommande pour renommer les satellites.

Recherche avancée

1. Appuyez sur la touche menu pour faire apparaître le menu principal.

2. Utilisez les touches ◀/▶ et ▲/▼ pour sélectionner dans le menu.

3. Sélectionnez recherche avancée, ensuite la fenêtre suivante apparaîtra.



4. Sélectionnez chaque menu que vous voulez éditer ou changer.

- **Satellite** : A l'aide des touches ◀/▶ de la télécommande sélectionnez le satellite souhaité.
- **Transpondeur** : Montre la liste courante de transpondeur du satellite choisi.
- **Symbole rate** : Montre la liste courante de symbole rate du satellite choisi.
- **Polarisation** : Sélectionnez Horizontal ou Verticale
- **Type de recherche** : Sélectionnez toutes les chaînes ou seulement FTA ou seulement TV
- **Recherche Network** : Sélectionnez Network recherche sur ON ou OFF.

5. **Scan** : Appuyez sur la touche rouge de la télécommande pour commencer les recherches satellite.

6. **Add TP** : Appuyez sur la touche « verte » de la télécommande pour ajouter un nouveau transpondeur à l'aide des touches numériques 0-9 et les touches ◀/▶ de la télécommande.

7. **Delete TP** : Appuyez sur la touche jaune de la télécommande pour supprimer le transpondeur.

Recherche PID



1. Appuyez sur la touche MENU de la télécommande pour afficher le menu principal.

2. Utilisez les touches de la télécommande pour déplacer dans le menu.

3. Sélectionnez PID recherche, ensuite la fenêtre suivante apparaîtra.

- **Satellite** : sélectionnez un transpondeur dans lequel vous souhaitez faire des recherches.
- **Transpondeur** : il montre le transpondeur d'un satellite sélectionné.
- **Symbol Rate** : il montre la liste courante de symbole rate du satellite choisi
- **Polarisation** : sélectionnez Vertical ou Horizontal.
- **Video PID / Audio PID / PCR PID** : sélectionnez et éditez à l'aide des touches numériques 0-9 de la télécommande.
- **Add TP** : appuyez sur la touche verte de la télécommande pour éditer le transpondeur à l'aide des touches numériques 0-9 et des touches ◀/▶ de la télécommande.
- **Delete TP** : appuyez sur la touche jaune de la télécommande pour supprimer le transpondeur sélectionné.

Sélection de programme

Vous pouvez changer le programme courant par un autre programme.

► Dans le cas où vous voulez sélectionner une chaîne au hasard sans savoir le nom de celle-ci, vous pouvez naviguer entre les chaînes jusqu'à ce que vous trouviez ce que vous souhaitez.

► Si vous connaissez le numéro de chaîne souhaitée, entrez le numéro et attendez 2 secondes jusqu'à ce que la chaîne change.

► Si vous connaissez le nom de la chaîne souhaitée, appuyez sur OK et la liste de chaîne apparaîtra.



1. Dans l'écran droit, l'information détaillée de la chaîne sélectionnée apparaîtra.

2. Vous pouvez naviguer entre les chaînes avec ces touches:

- ▲/▼ : Déplacer vers le haut et vers le bas
- ◀/▶ : Déplacer de page en page
- **Rouge** : Affichera toutes les chaînes
- **Vert** : Affichera toutes les sortes de chaînes par ordre alphabétique
- **Jaune** : Affichera toutes les chaînes par transpondeur
- **Bleu** : Affichera

3. Lorsque la chaîne souhaitée est sur surbrillance, appuyez sur OK pour confirmer.

Autre Fonction de la télécommande

► Contrôle du volume

1. Lorsque vous regardez un programme, à l'aide des touches ◀/▶ vous pouvez contrôler le volume.

2. Lorsque c'est nécessaire, appuyez sur la touche Mute pour couper le son. Appuyez à nouveau sur la touche mute pour remettre le son.

► Information

L'information à propos d'un programme apparaîtra en utilisant la touche INFO de la télécommande.

● EDIT CHANNELS

Installation des chaînes favorites

Ce sous-menu vous permet d'installer le nom préféré et les listes préférées comme vous le souhaitez.

En utilisant la touche TV/Radio, vous pouvez alterner entre les modes TV et Radio. Il soutient 8 groupes favoris.

1. Appuyez sur la touche OK de pour installation favorite, ensuite « select Favorite Group » = « sélection de groupe favoris » apparaîtra.



2. Sélectionnez un groupe favoris en utilisant les touches ◀/▶ et OK de la télécommande, la liste de chaînes TV Radio apparaîtra. Si vous voulez changer le nom du groupe favoris, appuyez sur la touche Rouge et le tableau s'affichera.

3. Réglez les chaînes préférées en utilisant les touches ◀/▶ et OK de la télécommande. Appuyez à nouveau sur la touche Ok de la télécommande pour enlever le groupe favoris.

4. Appuyez sur la touche Exit de la télécommande pour retourner au menu principal.

Renommer ch / edit pids

Ce sous-menu vous permet de renommer les chaînes et entrer l'utilisateur PID. En utilisant la touche TV/Radio, vous pouvez alterner entre les modes Tv / Radio. Vous pouvez changer la liste de chaîne en utilisant les touches SAT/FAV de la télécommande.



1. Appuyez sur la touche OK pour renommer Ch / Edit Pids, le menu suivant apparaîtra.

2. Appuyez sur la touche Ok pour la chaîne que vous voulez éditer.

3. Appuyez sur la touche OK pour renommer une chaîne, le tableau suivant s'affichera. Renommer une chaîne en utilisant les touches ▲/▼ et ◀/▶, OK de la télécommande. Appuyez sur la touche Exit de la télécommande pour quitter.

4. Vous pouvez éditer en utilisant les touches numériques de télécommande.

Déplacer les chaînes

Vous pouvez changer la liste de chaînes en utilisant la touche GROUP



1. appuyez sur Ok pour déplacer les chaînes. Le menu suivant apparaîtra.

2. appuyez sur Ok pour sélectionnez la chaîne que vous voulez changer.

3. Appuyez sur les touches numériques pour déplacer la chaîne sélectionnée ou appuyez sur les touches ▲/▼, OK pour déplacer une chaîne.

4. Appuyez sur la touche Exit de la télécommande pour retourner au menu précédent.

Chaîne verrouillée

Ce sous-menu vous permet de verrouiller les chaînes. Une fois que la chaîne est verrouillée, lorsque vous essayez de la regarder ; vous devez entrer le mot de passe. En utilisant les touches TV/Radio vous pouvez alterner entre les modes TV ou Radio. En utilisant les touches SAT/FAV vous pouvez changer la liste de chaîne.

*** Note :** si vous placez sur OFF la chaîne qui est verrouillée, alors vous ne devez plus entrer le mot de passe même si une chaîne est verrouillée.

1. Appuyez sur la touche OK pour la chaîne verrouillée. Le menu suivant apparaîtra.
2. Appuyez sur la touche Ok pour sélectionner la chaîne que vous voulez verrouiller. L'icône « verrouillé » s'affichera.
3. Appuyez à nouveau sur la touche OK pour déverrouiller une chaîne. L'icône « verrouillé » disparaîtra.
4. Appuyez sur la touche Exit = quitter de la télécommande pour revenir au menu précédent.



Suppression de chaînes

Ce sous-menu vous permet de supprimer les chaînes. En utilisant les touches TV/Radio, vous pouvez alterner entre les modes TV/Radio. Vous pouvez changer le groupe de liste de chaîne à l'aide de la touche GROUP.

*** Note :** Attention ! Si vous supprimer une chaîne, vous ne pourrez la regarder que si vous la recherchez à nouveau.



1. Appuyez sur OK pour « Suppression de chaîne ». Le menu suivant s'affichera.
2. Appuyez sur la touche OK pour sélectionner la chaîne que vous souhaitez supprimer. L'icône « suppression » s'affichera.
3. Appuyez à nouveau sur la touche OK pour confirmer. L'icône « suppression » disparaîtra.
4. Appuyez sur la touche INFO pour supprimer toutes les chaînes de la liste courante. Vous serez invité à entrer le mot de passe.
5. Appuyez sur la touche Exit = Quitter pour revenir au menu précédent.

• EPG (Electronic Program Guide)

EPG (le guide électronique des programmes)

Ce sous-menu vous permet de visualiser le guide électronique des programmes si il est disponible.

1. Appuyez sur la touche EPG de la télécommande, le menu Guide Électronique des programmes s'affichera.
2. Appuyez sur ◀/▶ pour voir le guide électronique des programmes précédent ou suivant.
3. Appuyez sur les touches ◀/▶ ou ▶▶/◀◀ pour vous faire passer verticalement d'une chaîne à l'autre.
4. Appuyez sur la touche Ok sur côté droit de l'écran (liste de programme) et le programme sélectionné sera réservé dans le menu Timer. Vous pouvez sélectionner autant de programmes que vous souhaitez.
5. Sélectionnez Programme TV/Radio à l'aide des touches TV/Radio de la télécommande.
6. Sélectionnez SAT, liste Favori à l'aide des touches SAT, FAV de la télécommande.
7. Appuyez sur la touche Rouge de la télécommande, le menu Timer s'affichera.



Menu Minuterie

Ce sous-menu vous permet de programmer la mise en veille de votre récepteur.

1. Appuyez sur la touche rouge dans le menu guide, le menu Timer s'affichera.
2. Appuyez sur les touches ◀/▶ pour déplacer à d'autre menu.
3. Appuyez sur les touches ◀/▶ pour changer la sélection.

• Interface commune

CAM (modules d'accès conditionnel)

Pour regarder les chaînes cryptées, vous avez besoin de modules d'accès conditionnel (CAM) et/ou une carte à puce d'abonnement.

** Note : sans le module d'accès conditionnel et/ou la carte à puce, vous ne pouvez regarder que les services libre d'accès.*

1. Insérez le module d'accès conditionnel dans l'une de fente du récepteur et une carte Smart dans le module.
2. Le message de « CAM Initializing » s'affichera à l'écran.
3. Après ce message, vous pouvez sélectionner la chaîne souhaitée.



EN CAS DE PROBLEME

PROBLEME	SOLUTION
Pas d'affichage sur le panneau avant	Vérifiez que le câble d'alimentation. Branchez le câble d'alimentation correctement.
Aucune image Aucun son	Vérifiez que le port de sortie vidéo est correctement branché à la TV. Vérifiez la position du parabole. Vérifiez la connexion du parabole. Vérifiez le signal (aucun signal ou mauvais signal).
La télécommande ne fonctionne plus	Vérifiez et remplacez les batteries.