

# IP-95

## Motherboard Socket 775

*Intel Core 2 Duo*  
*Intel Pentium D*  
*Intel Pentium 4*  
*Intel Celeron D*  
*Intel Celeron*

VIA P4M890 / VT8237R Plus

FSB1066

DDR2 533  
or DDR 400

PCI Express

2x SATA 1.5Gb/s

5.1 Channel AC97 Audio

**IP-95**

User's Manual

English + Multilingual QIG

1<sup>st</sup> Edition, October 2006

**Copyright and Warranty Notice**

The information in this document is subject to change without notice and does not represent a commitment on part of the vendor, who assumes no liability or responsibility for any errors that may appear in this manual.

No warranty or representation, either expressed or implied, is made with respect to the quality, accuracy or fitness for any particular part of this document. In no event shall the manufacturer be liable for direct, indirect, special, incidental or consequential damages arising from any defect or error in this manual or product.

Product names appearing in this manual are for identification purpose only and trademarks and product names or brand names appearing in this document are the property of their respective owners.

This document contains materials protected under International Copyright Laws. All rights reserved. No part of this manual may be reproduced, transmitted or transcribed without the expressed written permission of the manufacturer and authors of this manual.

If you do not properly set the motherboard settings, causing the motherboard to malfunction or fail, we cannot guarantee any responsibility.

# Contents

---

<b>1. Hardware Setup .....</b>	<b>1-1</b>
1.1 Specifications .....	1-1
1.2 Motherboard Layout.....	1-2
1.3 Choosing a Computer Chassis.....	1-3
1.4 Installing Motherboard.....	1-3
1.5 Checking Jumper Settings .....	1-4
1.5.1 CMOS Memory Clearing Header and Backup Battery .....	1-4
1.6 Connecting Chassis Components.....	1-6
1.6.1 ATX Power Connectors .....	1-6
1.6.2 Front Panel Switches & Indicators Headers.....	1-7
1.6.3 FAN Power Connectors .....	1-8
1.6.4 Chassis Speaker Connector .....	1-9
1.7 Installing Hardware.....	1-10
1.7.1 CPU Socket .....	1-10
1.7.2 DDR2/DDR Memory Slots.....	1-12
1.8 Connecting Peripheral Devices .....	1-13
1.8.1 Floppy and IDE Disk Drive Connectors .....	1-13
1.8.2 Serial ATA Connectors .....	1-14
1.8.3 Additional USB 2.0 Port Headers.....	1-15
1.8.4 Internal Audio Connectors.....	1-15
1.8.5 Front Panel Audio Connection Header .....	1-16
1.8.6 PCI and PCI Express X16, X1 Slots .....	1-17
1.9 Connecting Rear Panel I/O Devices .....	1-18
<b>2. BIOS Setup.....</b>	<b>2-1</b>
<b>3. Driver &amp; Utility .....</b>	<b>3-1</b>
<b>4. Multilingual Quick Installation Guide .....</b>	<b>4-3</b>
4.1 繁體中文 .....	4-3
4.1.1 規格 .....	4-3
4.1.2 快速安裝指南 .....	4-4
4.2 簡體中文 .....	4-7
4.2.1 規格 .....	4-7
4.2.2 快速安裝指南 .....	4-8
<b>5. Appendix .....</b>	<b>5-1</b>
5.1 Troubleshooting (How to Get Technical Support?).....	5-1
5.1.1 Q & A.....	5-1
5.1.2 Technical Support Form .....	5-4
5.1.3 Contact Information .....	5-5



# 1. Hardware Setup

## 1.1 Specifications

---

### CPU

- LGA775 socket for Intel Core 2 Duo / Pentium D / Pentium 4 / Celeron D / Celeron processor with 1066MHz FSB
- Supports Intel Hyper-Threading Technology

---

### Chipset

- VIA P4M890 / VT8237R Plus

---

### Memory

- Supports DDR2 533 or DDR 400 Un-buffered Non-ECC memory
- 2x 184-pin DIMM slots (2.5V), supports DDR 400 memory up to 2GB
- 2x 240-pin DIMM slots (1.8V), supports DDR2 533 memory up to 4GB

---

### Graphics

- Integrated VIA UniChrome Pro 2D/3D Graphics & Video Controller

---

### LAN

- Onboard 10/100M PCI controller

---

### Audio

- Onboard 5.1 CH AC97 Audio CODEC

---

### Serial ATA

- 2x SATA 1.5Gb/s

---

### Expansion Slots

- 1x PCI-E X16 slot
- 1x PCI-E X1 slot
- 2x PCI slots

---

### Internal I/O Connectors

- 1x Floppy port
- 2x ATA 133 IDE connectors
- 2x SATA 1.5Gb/s connectors
- 2x USB 2.0 headers
- 1x FP-Audio header
- 1x CD-In connector

---

### Rear Panel I/O

- 1x PS/2 Keyboard connector
- 1x PS/2 Mouse connector
- 1x COM port
- 1x LPT port
- 1x VGA connector
- 4x USB 2.0 connectors
- 1x RJ-45 LAN connector
- 1x 5.1CH Audio Connector

---

### RoHS

- 100% Lead-free process and RoHS compliant

---

### Miscellaneous

- Micro ATX form factor (244mm x 244mm)

※ Specifications and information contained herein are subject to change without notice.

# 1.2 Motherboard Layout

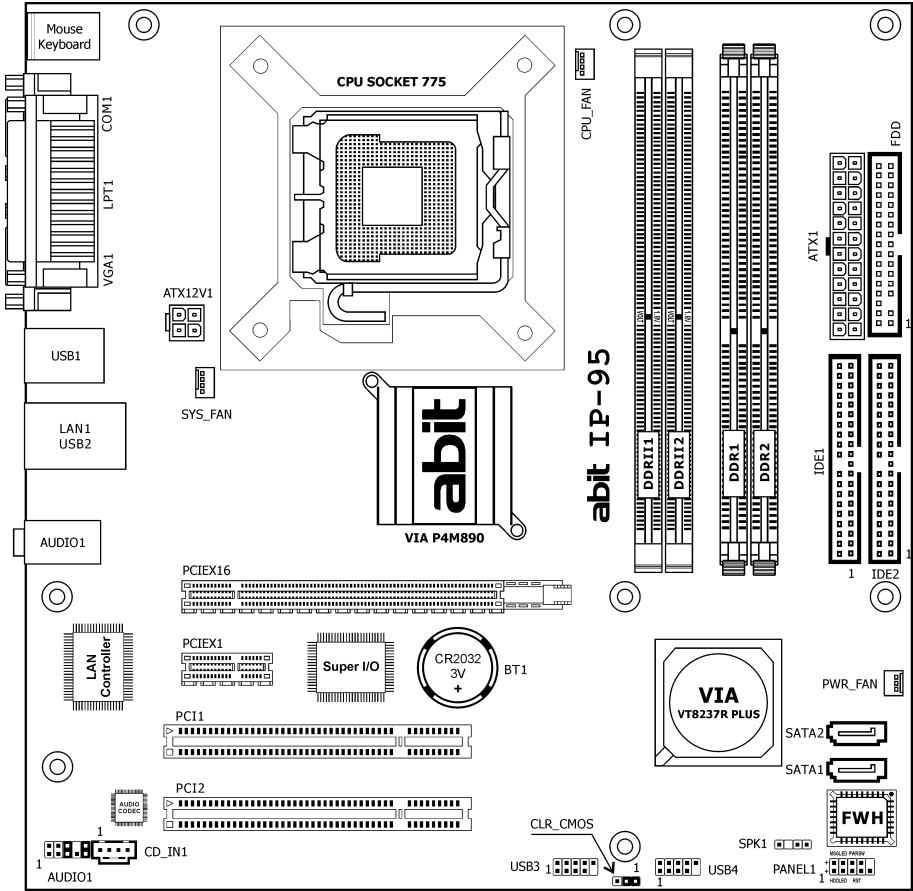

### 1.3 Choosing a Computer Chassis

- Choose a chassis big enough to install this motherboard.
- As some features for this motherboard are implemented by cabling connectors on the motherboard to indicators and switches or buttons on the chassis, make sure your chassis supports all the features required.
- If there is possibility of adopting some more hard drives, make sure your chassis has sufficient power and space for them.
- Most chassis have alternatives for I/O shield located at the rear panel. Make sure the I/O shield of the chassis matches the I/O port configuration of this motherboard. You can find an I/O shield specifically designed for this motherboard in its package.

### 1.4 Installing Motherboard

Most computer chassis have a base with many mounting holes to allow the motherboard to be securely attached, and at the same time, prevent the system from short circuits. There are two ways to attach the motherboard to the chassis base: (1) with studs, or (2) with spacers.

Basically, the best way to attach the board is with studs. Only if you are unable to do this should you attach the board with spacers. Line

up the holes on the board with the mounting holes on the chassis. If the holes line up and there are screw holes, you can attach the board with studs. If the holes line up and there are only slots, you can only attach with spacers. Take the tip of the spacers and insert them into the slots. After doing this to all the slots, you can slide the board into position aligned with slots. After the board has been positioned, check to make sure everything is OK before putting the chassis back on.

- ※ **Always power off the computer and unplug the AC power cord before adding or removing any peripheral or component. Failing to do so may cause severe damage to your motherboard and/or peripherals. Plug in the AC power cord only after you have carefully checked everything.**

**To install this motherboard:**

1. Locate all the screw holes on the motherboard and the chassis base.
  2. Place all the studs or spacers needed on the chassis base and have them tightened.
  3. Face the motherboard's I/O ports toward the chassis's rear panel.
  4. Line up all the motherboard's screw holes with those studs or spacers on the chassis.
  5. Install the motherboard with screws and have them tightened.
- ※ **To prevent shorting the PCB circuit, please REMOVE the metal studs or spacers if they are already fastened on the chassis base and are without mounting-holes on the motherboard to align with.**

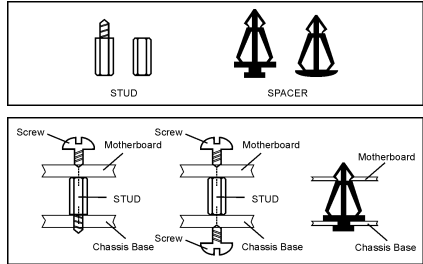

Face the chassis's rear panel.

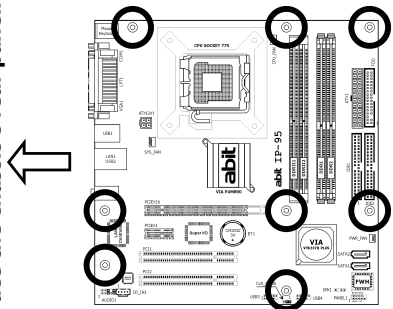

# 1.5 Checking Jumper Settings

- For a 2-pin jumper, plug the jumper cap on both pins will make it CLOSE (SHORT). Remove the jumper cap, or plug it on either pin (reserved for future use) will leave it at OPEN position.

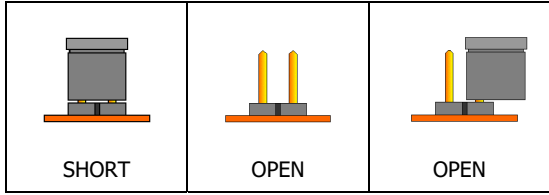

- For 3-pin jumper, pin 1~2 or pin 2~3 can be shorted by plugging the jumper cap in.

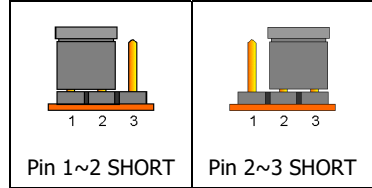

## 1.5.1 CMOS Memory Clearing Header and Backup Battery

The time to clear the CMOS memory occurs when (a) the CMOS data becomes corrupted, (b) you forgot the supervisor or user password preset in the BIOS menu, (c) you are unable to boot-up the system because the CPU ratio/clock was incorrectly set in the BIOS menu, or (d) whenever there is modification on the CPU or memory modules.

This header uses a jumper cap to clear the CMOS memory and have it reconfigured to the default values stored in BIOS.

- Pins 1 and 2 shorted (Default):** Normal operation.
- Pins 2 and 3 shorted:** Clear CMOS memory.

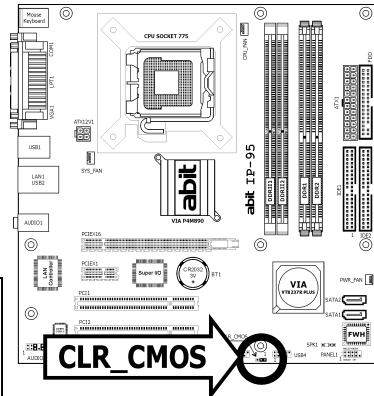
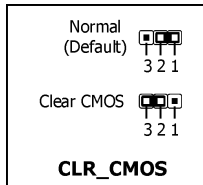

### To clear the CMOS memory and load in the default values:

- Power off the system.
- Set pin 2 and pin 3 shorted by the jumper cap. Wait for a few seconds. Set the jumper cap back to its default settings --- pin 1 and pin 2 shorted.
- Power on the system.
- For incorrect CPU ratio/clock settings in the BIOS, press <Del> key to enter the BIOS setup menu right after powering on system.
- Set the CPU operating speed back to its default or an appropriate value.
- Save and exit the BIOS setup menu.



### CMOS Backup Battery:

An onboard battery saves the CMOS memory to keep the BIOS information stays on even after disconnected your system with power source. Nevertheless, this backup battery exhausts after some five years. Once the error message like “**CMOS BATTERY HAS FAILED**” or “**CMOS checksum error**” displays on monitor, this backup battery is no longer functional and has to be renewed.

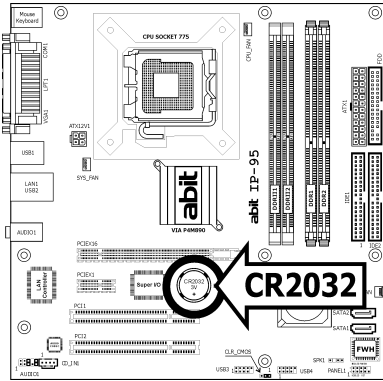

### To renew the backup battery:

1. Power off the system and disconnect with AC power source.
2. Remove the exhausted battery.
3. Insert a new CR2032 or equivalent battery. Pay attention to its polarity. The “+” side is its positive polarity.
4. Connect AC power source and power on the system.
5. Enter the BIOS setup menu. Reconfigure the setup parameters if necessary.

### CAUTION:

- ※ **Danger of explosion may arise if the battery is incorrectly renewed.**
- ※ **Renew only with the same or equivalent type recommended by the battery manufacturer.**
- ※ **Dispose of used batteries according to the battery manufacturer’s instructions.**

# 1.6 Connecting Chassis Components

## 1.6.1 ATX Power Connectors

These connectors provide the connection from an ATX power supply. As the plugs from the power supply fit in only one orientation, find the correct one and push firmly down into these connectors.

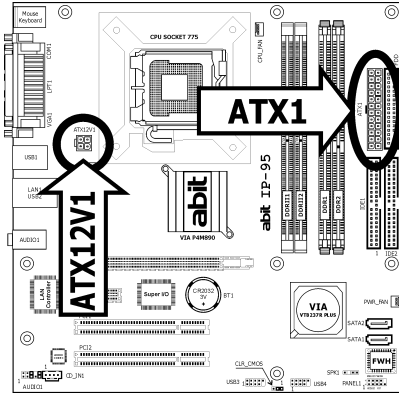

### ATX 24-Pin Power Connector:

The power supply with 20-pin or 24-pin cables can both be connected to this 24-pin connector. Connect from pin-1 for either type. However, a 20-pin power supply may cause the system unstable or even unbootable for the sake of insufficient electricity. A minimum power of 300W or higher is recommended.

### ATX 12V 4-Pin Power Connector:

This connector supplies power to CPU. The system will not start without connecting power to this one.

## 1.6.2 Front Panel Switches & Indicators Headers

This header is used for connecting switches and LED indicators on the chassis front panel.

Watch the power LED pin position and orientation. The mark "+" align to the pin in the figure below stands for positive polarity for the LED connection. Please pay attention when connecting these headers. A wrong orientation will only cause the LED not lighting, but a wrong connection of the switches could cause system malfunction.

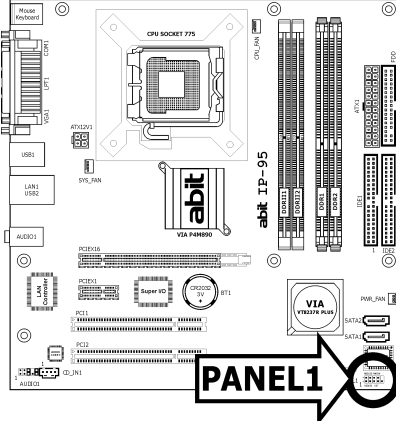

MSGLED PWRSW		HDDLED RST	
Pin	Definition	Pin	Definition
1	HD LED +	2	Message LED +
3	HD LED -	4	Message LED -
5	RESET	6	Power Switch
7	RESET	8	Power Switch
9	Reserved		

### 1.6.3 FAN Power Connectors

These connectors each provide power to the cooling fans installed in your system.

- **CPU\_FAN:** CPU Fan Power Connector
  - **SYS\_FAN:** System Fan Power Connector
  - **PWR\_FAN:** Auxiliary Fan Power Connector
- ※ **These fan connectors are not jumpers. DO NOT place jumper caps on these connectors.**

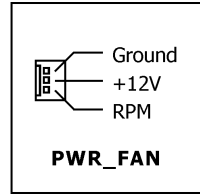
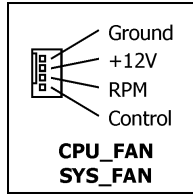
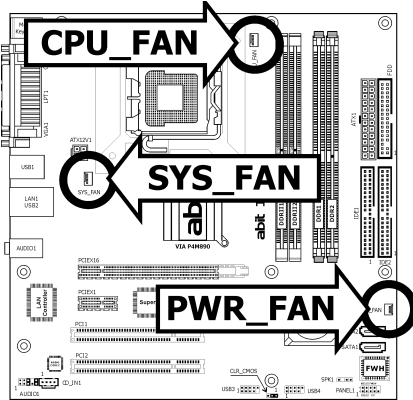

## 1.6.4 Chassis Speaker Connector

This header provides the connection to chassis speaker.

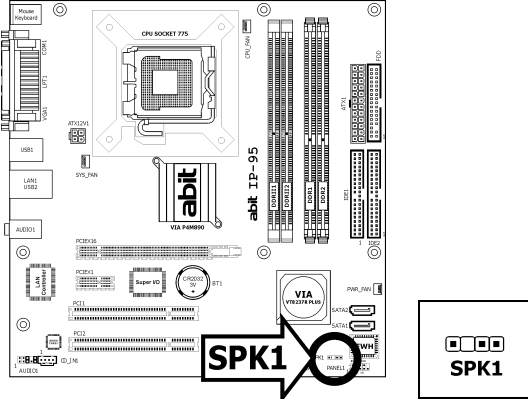

## 1.7 Installing Hardware

- ❌ **DO NOT** scratch the motherboard when installing hardware. An accidentally scratch of a tiny surface-mount component may seriously damage the motherboard.
- ❌ In order to protect the contact pins, please pay attention to these notices:
  1. A maximum 20 cycles of CPU installation is recommended.
  2. Never touch the contact pins with fingers or any object.
  3. Always put on the cap when the CPU is not in use.

### 1.7.1 CPU Socket 775

- ❌ The installation procedures vary with different types of CPU fan-and-heatsink assembly. The one shown here is served for demo only. For detailed information on how to install the one you bought, refer to its installation guidelines.

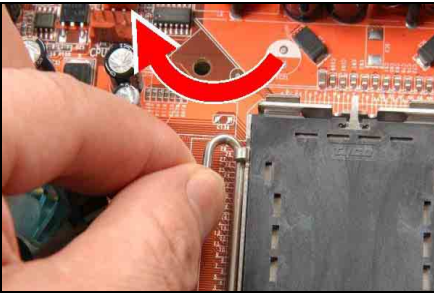

1. Place the board so as to let the lever-hook of the socket is on your left side. Use your left thumb and forefinger to hold the lever hook, pull it away from the retention tab. Rotate the lever to fully open position.

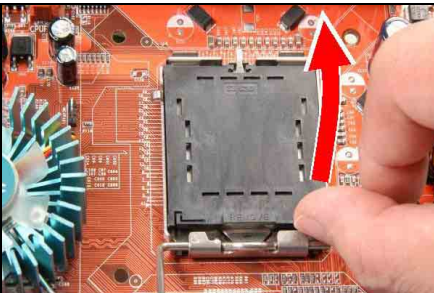

2. Use your right-thumb to raise the load plate. Lift it up to fully open position.

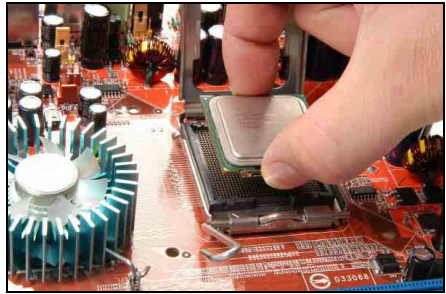

3. Use your right thumb and forefinger to grasp the CPU package. Be sure to grasp on the edge of the substrate, and face the Pin-1 indicator toward the bottom-left side. Aim at the socket and place the CPU package vertical down into the socket.

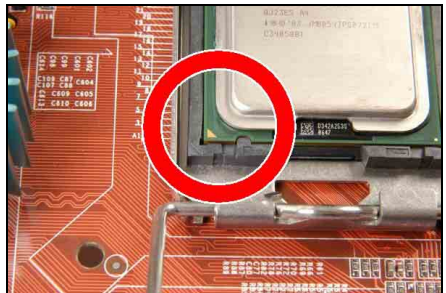

4. Visually inspect if the CPU is seated well into the socket. The alignment key must be located in the notch of package.

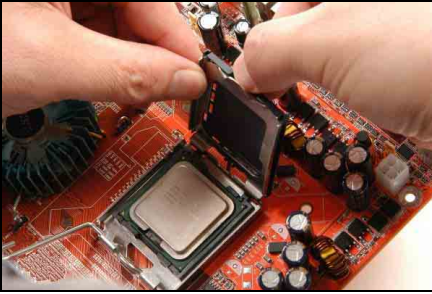

5. Use your left hand to hold the load plate, and use your right thumb to peel the cap off.

**The cap plays an important role in protecting contact pins. In order to prevent bent pin, PUT ON the cap after operation or testing.**



6. Lower the plate onto the CPU package. Engage the load lever while gently pressing down the load plate.



7. Secure the lever with the hook under retention tab.



8. Place the heatsink and fan assembly onto the socket. Align the four fasteners toward the four mounting holes on the motherboard.

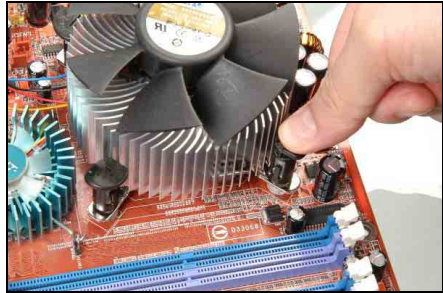

9. Press each of the four fasteners down into the mounting holes. Rotate the fastener clock-wise to lock the heatsink and fan assembly into position.

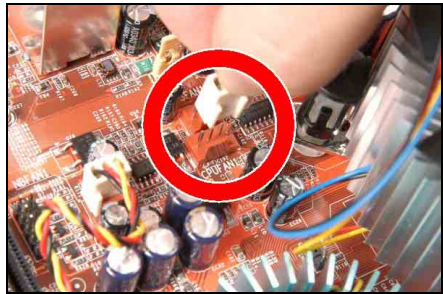

10. Attach the four-pin power plug from the heatsink and fan assembly to the CPU FAN connector.

※ **A higher fan speed will be helpful for better airflow and heat-dissipation. Nevertheless, stay alert to touch any heatsink since the high temperature generated by the working system is still possible.**

## 1.7.2 DDR2/DDR Memory Slots

This motherboard supports two DDR or two DDR2 DIMMs. Note that DDR & DDR2 cannot be both applied at the same time. Apply either DDR or DDR2 memory modules only!

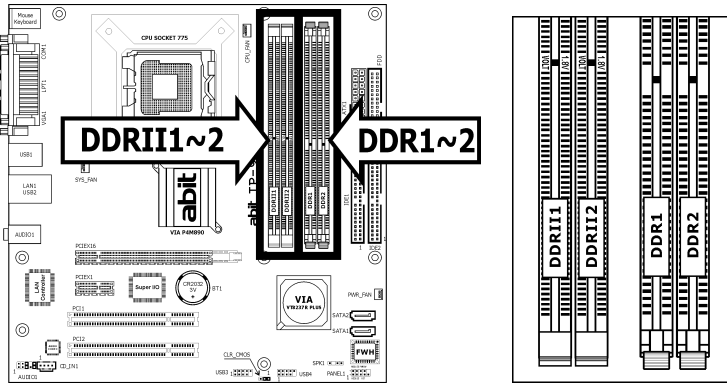

- ✳ **Usually there is no hardware or BIOS setup required after adding or removing memory modules, but you will have to clear the CMOS memory first if any memory module related problem occurs.**

### To install system memory:

1. Power off the computer and unplug the AC power cord before installing or removing memory modules.
  2. Locate the DIMM slot on the board.
  3. Hold two edges of the DIMM module carefully, keep away from touching its connectors.
  4. Align the notch key on the module with the rib on the slot.
  5. Firmly press the module into the slots until the ejector tabs at both sides of the slot automatically snap into the mounting notch. Do not force the DIMM module in with extra force as the DIMM module only fits in one direction.
  6. To remove the DIMM modules, push the two ejector tabs on the slot outward simultaneously, and then pull out the DIMM module.
- ✳ **Static electricity can damage the electronic components of the computer or optional boards. Before starting these procedures, ensure that you are discharged of static electricity by touching a grounded metal object briefly.**

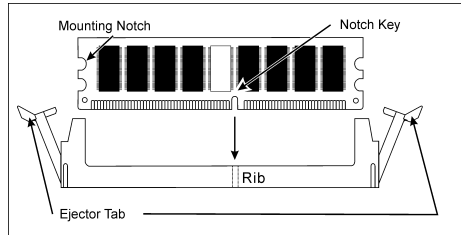



# 1.8 Connecting Peripheral Devices

## 1.8.1 Floppy and IDE Disk Drive Connectors

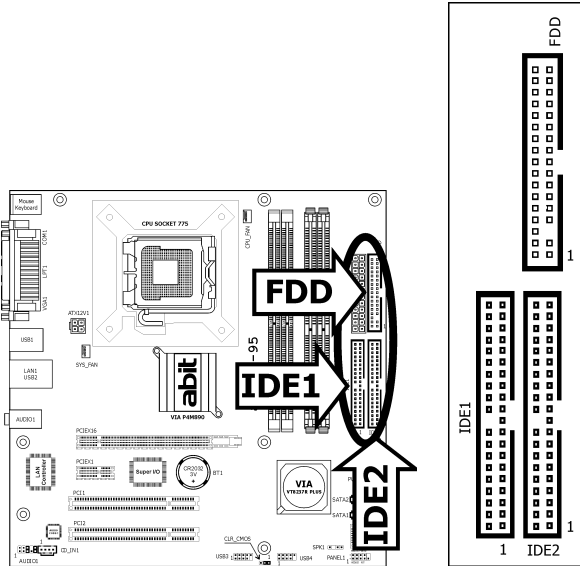

The FDC1 connector connects up to two floppy drives with a 34-wire, 2-connector floppy cable. Connect the single end at the longer length of ribbon cable to the FDC1 on the board, the two connectors on the other end to the floppy disk drives connector. Generally you need only one floppy disk drive in your system.

- ✘ **The red line on the ribbon cable must be aligned with pin-1 on both the FDC1 port and the floppy connector.**

Each of the IDE port connects up to two IDE drives at Ultra ATA/100 mode by one 40-pin, 80-conductor, and 3-connector Ultra ATA/66 ribbon cables.

Connect the single end (blue connector) at the longer length of ribbon cable to the IDE port of this board, the other two ends (gray and black connector) at the shorter length of the ribbon cable to the connectors of your hard drives.

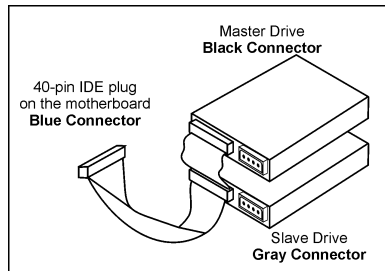

- ✘ **Make sure to configure the "Master" and "Slave" relation before connecting two drives by one single ribbon cable. The red line on the ribbon cable must be aligned with pin-1 on both the IDE port and the hard-drive connector.**

## 1.8.2 Serial ATA Connectors

Each SATA connector serves as one single channel to connect one SATA device by SATA cable.

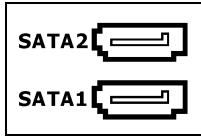
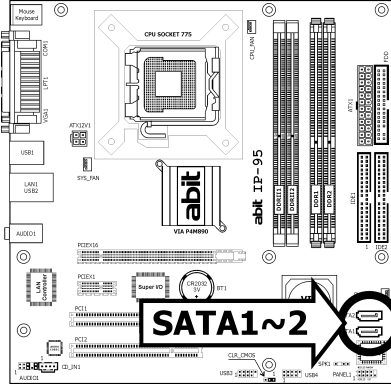

### To connect SATA device:

1. Attach either end of the signal cable to the SATA connector on motherboard. Attach the other end to SATA device.
2. Attach the SATA power cable to the SATA device and connect the other end from the power supply.

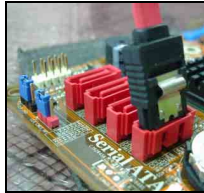

※ **The motherboard in this illustration is served for DEMO only, may not be the same type or model as the one described in this user's manual.**

### 1.8.3 Additional USB 2.0 Port Headers

Each header supports 2x additional USB 2.0 ports by connecting bracket or cable to the rear I/O panel or the front-mounted USB ports of your chassis.

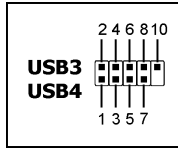
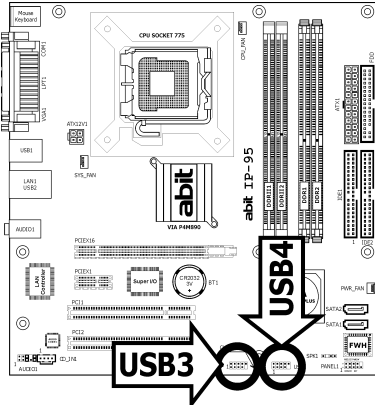

Pin	Pin Assignment	Pin	Pin Assignment
1	VCC	2	VCC
3	Data0 -	4	Data1 -
5	Data0 +	6	Data1 +
7	Ground	8	Ground
		10	NC

※ Make sure the connecting cable bears the same pin assignment.

### 1.8.4 Internal Audio Connectors

This connector connects to the audio output of internal CD-ROM drive or add-on card.

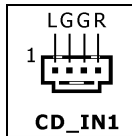
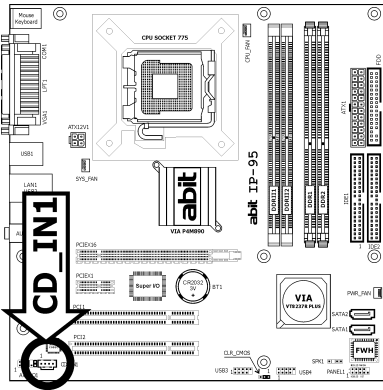

## 1.8.5 Front Panel Audio Connection Header

This header provides the connection to audio connector at front panel.

- To use the audio connector at front panel, remove all the jumpers on this header, and then connect to front panel by the extension cable provided with the chassis.
- To use the audio connector at rear panel, disconnect the extension cable, attach the jumpers back at pin 5-6, and pin 9-10 (default setting).

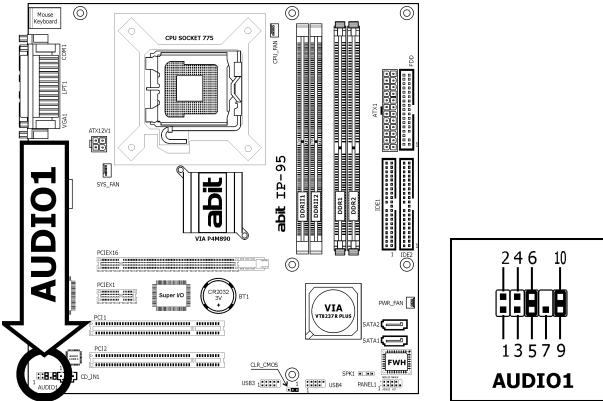

Pin	Signal Name	Function
1	AUD_MIC	Front Panel Microphone input signal
2	AUD_GND	Ground used by Analog Audio Circuits
3	AUD_MIC_BIAS	Microphone Power
4	AUD_VCC Filtered	+5V used by Analog Audio Circuits
5	AUD_F_R	Right Channel audio signal to Front Panel
6	AUD_RET_R	Right Channel Audio signal to Return from Front Panel
7	REVD	Reserved
8	Key	No Pin
9	AUD_F_L	Left Channel Audio signal to Front Panel
10	AUD_RET_L	Left Channel Audio signal to Return from Front Panel

### 1.8.6 PCI and PCI Express X16, X1 Slots

Install PCI Express X16 graphics card into slot "PCIEX16".

Install PCI Express X1 card into slot "PCIEX1".

Install PCI cards into slots "PCI1" and/or "PCI2".

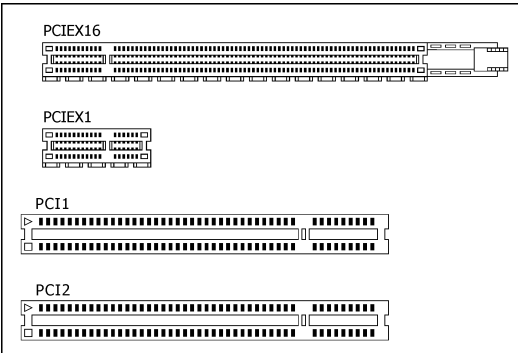
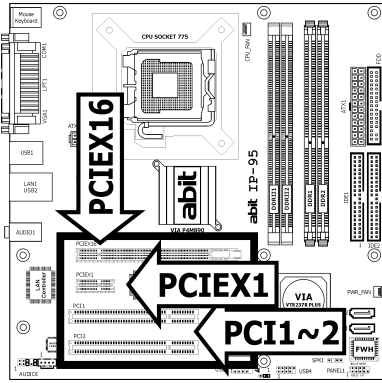

## 1.9 Connecting Rear Panel I/O Devices

The rear I/O part of this motherboard provides the following I/O ports:

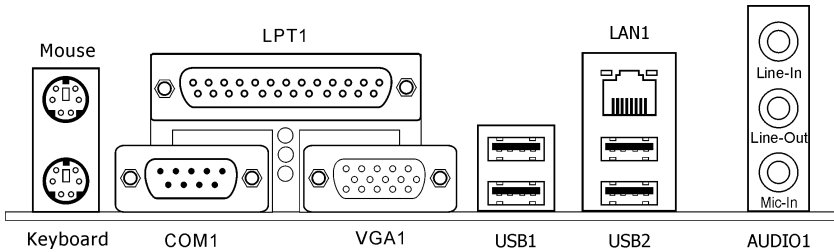

- **Mouse:** Connects to PS/2 mouse.
- **Keyboard:** Connects to PS/2 keyboard.
- **LPT1:** Connects to printer or other devices that support this communication protocol.
- **COM1:** Connects to external modem, mouse or other devices that support this communication protocol.
- **VGA1:** Connects to monitor input.
- **LAN1:** Connects to Local Area Network.
- **USB1/USB2:** Connects to USB devices such as scanner, digital speakers, monitor, mouse, keyboard, hub, digital camera, joystick etc.
- **AUDIO1:**
  - Line In:** Connects to the line out from external audio sources.
  - Line Out:** Connects to the front left and front right channel in the 5.1-channel or regular 2-channel audio system.
  - Mic In:** Connects to the plug from external microphone.

## 2. BIOS Setup

This motherboard provides a programmable EEPROM so that you can update the BIOS utility. The BIOS (Basic Input/Output System) is a program that deals with the basic level of communication between processor and peripherals. Use the BIOS Setup program only when installing motherboard, reconfiguring system, or prompted to "Run Setup". This chapter explains the Setup Utility of BIOS utility.

After powering up the system, the BIOS message appears on the screen, the memory count begins, and then the following message appears on the screen:

### PRESS DEL TO ENTER SETUP

If this message disappears before you respond, restart the system by pressing <Ctrl> + <Alt> + <Del> keys, or by pressing the Reset button on computer chassis. Only when these two methods fail should you restart the system by powering it off and then back on.

After pressing <Del> key, the main menu screen appears.

CMOS Setup Utility - Copyright (C) 1985-2005, American Megatrends, Inc.	
<ul style="list-style-type: none"><li>▶ Standard CMOS Setup</li><li>▶ Advanced Setup</li><li>▶ Features Setup</li><li>▶ Power Management Setup</li><li>▶ PCI/PnP and Play Setup</li><li>▶ BIOS Security Features</li></ul>	<ul style="list-style-type: none"><li>▶ CPU PnP Setup</li><li>▶ Hardware Monitor</li><li>Load Optimal Defaults</li><li>Save Changes and Exit</li><li>Discard Changes and Exit</li></ul>
↑↓→←:Move    Enter:Select    +/-/:Value    F10:Save    EXC:Exit F1:General Help    F9:Optimized Settings	
Standard CMOS setup for changing time, date, hard disk type, etc. V02.59 (C) Copyright 1985-2005, American Megatrends, Inc.	

- ※ In order to increase system stability and performance, our engineering staff is constantly improving the BIOS menu. The BIOS setup screens and descriptions illustrated in this manual are for your reference only, and may not completely match with what you see on your screen.





### 3. Driver & Utility

The "Driver & Utility CD" that came packed with this motherboard contains drivers, utilities and software applications required for its basic and advanced features.

Place the "Driver & Utility CD" into the CD-ROM drive in your system. The following installation auto-run screen appears. If not, browse the root directory of the CD-ROM via the File Manager, and double click the "AUTORUN" file.

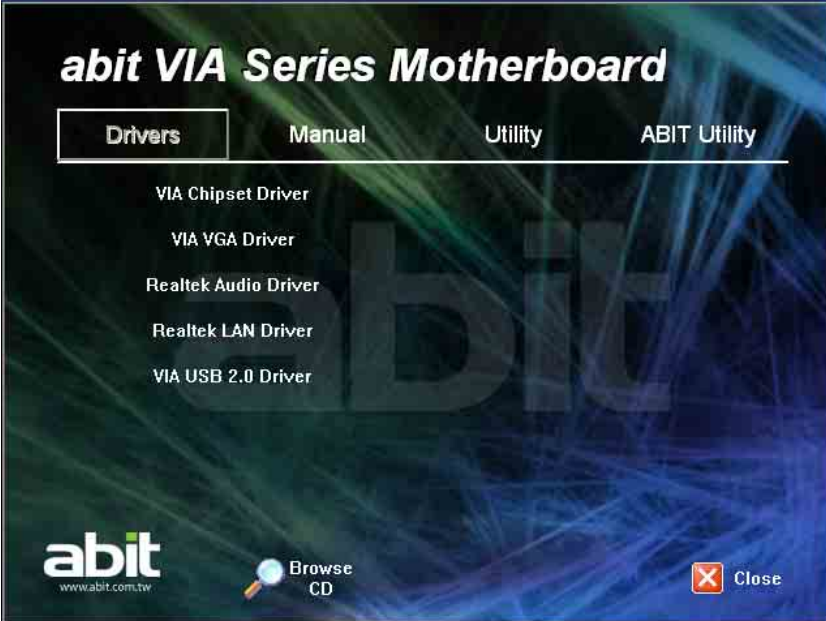

- **[Drivers]:** Click to enter the driver installation menu.
- **[Manual]:** Click to enter the user's manual menu.
- **[Utility]:** Click to enter the utilities installation menu.
- **[ABIT Utility]:** Click to enter the installation menu of utilities exclusively developed by ABIT.
- **[ Browse CD ] Browse CD:** Click to browse the contents of this "Driver & Utility CD".
- **[ Close ] Close:** Click to exit this installation menu.



# 4. Multilingual Quick Installation Guide

## 4.1 繁體中文

### 4.1.1 規格

#### 處理器

- 支援具備 1066MHz 前端匯流排的 Intel Core 2 Duo / Pentium D / Pentium 4 / Celeron D / Celeron 處理器
- 支援 Intel Hyper-Threading 技術

#### 晶片組

- VIA P4M890 / VT8237R Plus

#### 記憶體

- 支援 DDR2 533 或 DDR 400 無緩衝非 ECC 記憶體
- 2 條 184 針腳 DIMM 插槽 (2.5V)，支援 DDR 400 記憶體最大 2GB 記憶體容量
- 2 條 240 針腳 DIMM 插槽 (1.8V)，支援 DDR2 533 記憶體最大 4GB 記憶體容量

#### 圖形埠

- 整合 VIA UniChrome Pro 2D/3D 圖形與影像控制器

#### 網路

- 內建 10/100M PCI 網路控制器

#### 音效

- 內建 5.1 聲道 AC97 音效

#### Serial ATA

- 2 個 SATA 1.5Gb/s

#### 擴充插槽

- 1 個 PCI-E X16 插槽
- 1 個 PCI-E X1 插槽
- 2 個 PCI 插槽

#### 內部輸入/輸出接頭

- 1 個軟碟埠
- 2 個 ATA 133 IDE 接頭
- 2 個 SATA 1.5Gb/s 接頭
- 2 個 USB 2.0 接頭
- 1 個 FP-Audio 接頭
- 1 個 CD-In 接頭

#### 後面板輸入/輸出接頭

- 1 個 PS/2 鍵盤接頭
- 1 個 PS/2 滑鼠接頭
- 1 個 COM 連接埠
- 1 個 LPT 連接埠
- 1 個 VGA 連接埠
- 4 個 USB 2.0 接頭
- 1 個 RJ-45 網路接頭
- 1 個 5.1 聲道音效接頭

#### RoHS

- 100%無鉛製程符合 RoHS 規範

#### 其他

- Micro ATX 主機板規格 (244mm x 244mm)

※ 本手冊的規格與資訊若有變動，恕不另行通知。

## 4.1.2 快速安裝指南

本「快速安裝指南」僅包含安裝 **abit** 主機板時所需的基本硬體資訊。詳細的操作方式，請參閱完整的手冊版本。

### 硬體安裝注意事項

- 安裝機板或變換任何設定之前，請先關閉電源並拔掉電源插頭。
- 從抗靜電袋中取出機板前，請先戴上靜電安全手環，以確保自己已確實接地。
- 請握住機板的邊緣。請勿接觸機板上的任何元件。
- 請勿接觸模組及 IC 晶片
- 請將機板置於已接地的抗靜電平面上，或置於隨附的抗靜電袋。

### 將機板安裝至機殼內

本主機板的電腦機殼應符合以下條件：

- 與本主機板的規格相容。
- 機殼上的指示燈及開關支援主機板上的連接線插座。
- 能提供足夠的電力及空間，以容納所有您想安裝的磁碟機。
- 背面的 I/O 必須配合主機板上的 I/O 連接埠及擴充插槽。

要將主機板安裝至機殼，您應該：

- 將 I/O 連接埠的內部面向機殼的後面。
- 將螺絲孔置於主機板與機殼的底座。
- 將所需的銅柱或塑膠腳座置於機殼底座並鎖緊。
- 將主機板上所有的螺絲孔與機殼上的銅柱或塑膠腳座對齊。
- 將螺絲孔鎖緊。

**要避免造成 PCB 電路短路，請「移除」已安裝在機殼底座上，及本主機板上沒有安裝孔可對齊的的金屬銅柱及腳柱。**

### 清除 CMOS 跳線

這個跳線是用來清除 CMOS 記憶體以便重新設定 BIOS 的內容。如果 BIOS 設定有誤導致主機板無法運作，您可能需要清除 CMOS 記憶體。

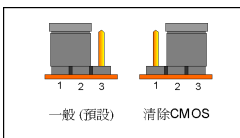

若要清除 CMOS 記憶體，拔除主機板上所有的電源線，將跳線連接到標有「清除 CMOS」的設定數秒鐘，然後再將跳線插回「一般」設定。插回所有電源並重新啟動電源時，BIOS 內容將重新設定成預設值。

### 連接機板元件

#### ATX 電源供應器：[ATXPWR1]、[ATX12V1]

- 將標準 ATX 電源供應器連接至 2x12 針腳的 [ATXPWR1] 插座。
- 將輔助電源連接至 2x2 針腳的 [ATX12V1] 插座。

#### 風扇插座：

- [CPUFAN1]：CPU 冷卻風扇插座。
- [SYSFAN1]：系統冷卻風扇插座。
- [AUXFAN1]：輔助冷卻風扇插座。
- [NBFAN1]：北橋冷卻風扇插座。

**這些風扇插座並不是跳線。請勿將跳線置於這些插座上。**

#### 前面板插座：[FPPIO1]

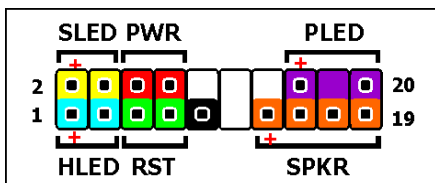

- [HLED]：連接至硬碟 LED 連接線。
- [RST]：連接至重新啟動開關連接線。
- [SPKR]：連接至系統喇叭連接線。
- [SLED]：連接至暫停 LED 連接線。
- [PWR]：連接至電源開關連接線。
- [PLED]：連接至電源 LED 連接線。

#### 前面板音效接頭：[FP-AUDIO1]

本接頭提供前面板 HD (高品質) 音效連接。若要連接 AC'97 音效編碼，您必須在連接到前面板模組之前仔細確認接頭的針腳配置。如果配置錯誤可能導致主機板故障或損毀。

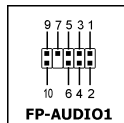

**請勿將前面板模組上標示為「Ground」與「USB VCC」的纜線連接到此接頭上標示為「AVCC」的第 4 針腳。**

針腳	針腳定義 (HD AUDIO)	針腳	針腳定義 (AC'97 AUDIO)
1	MIC2 L	1	MIC In
2	AGND	2	GND
3	MIC2 R	3	MIC Power
4	AVCC	4	NC
5	FRO-R	5	Line Out (R)
6	MIC2_JD	6	NC
7	F_IO_SEN	7	NC
9	FRO-L	9	Line Out (L)
10	LINE2_JD	10	NC

## 附加的 USB 連接埠接頭：[FP-USB1]、[FP-USB2]

除了位於 I/O 面板上的內建 USB 接頭外，您可透過帶有支架的延長線，連接這些各有兩個附加 USB 連接埠的接頭。

針腳	針腳定義	針腳	接腳定義
1	VCC	2	VCC
3	負資料通道 0	4	負資料通道 1
5	正資料通道 0	6	正資料通道 1
7	接地	8	接地
		10	不連接

## 附加的 IEEE1394 連接埠接頭：[FP-1394-1]、[FP-1394-2]

除了位於 I/O 面板上的內建 IEEE1394 接頭外，您可透過帶有支架的延長線，連接這些各有一個附加 IEEE1394 連接埠的接頭。

針腳	針腳定義	針腳	針腳定義
1	TPA0 +	2	TPA0 -
3	接地	4	接地
5	TPB0 +	6	TPB0 -
7	+12V	8	+12V
		10	接地

## 內部音源連接頭：[CD1]、[AUX1]

這個連接頭可選擇內部光碟機或附加卡的音源輸出。



## 安裝 CPU 和散熱片配件

由於市面上有多種中央處理器 (Central Processing Unit, CPU) 和專用的散熱片可供選擇，而安裝方式也各有不同，請確實遵循所購買產品包裝中隨附的安裝指示。CPU 是一種精密的電子裝置，運作時會散發大量的熱能。請務必小心處理。

將散熱片安裝到處理器上以後，請將散熱風扇的電源連接到主機板上的 [CPUFAN1] 插座。

## 安裝記憶體模組

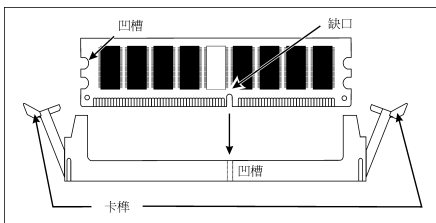

靜電可能會損壞電腦或選購機板的電子元件。請在開始上述操作程序之前，先短暫觸摸接地的金屬物件，以排除靜電。

## 連接儲存裝置

### 連接軟碟機：[FDC1]

### 連接 IDE 硬碟：[IDE1]、[IDE2]

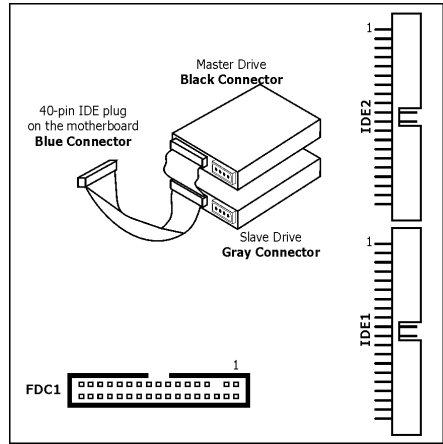

### 連接序列 ATA 硬碟機：[SATA1] ~ [SATA4]

這些插座提供透過序列 ATA 連接線，每個通道連接一台序列 ATA 裝置。

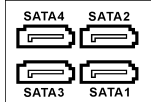

## 背面板線路連接

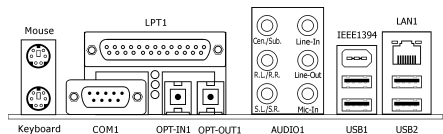

- **Mouse**：連接 PS/2 滑鼠。
- **Keyboard**：連接 PS/2 鍵盤。
- **LPT1**：連接印表機或其他支援平行通訊協定的裝置。
- **COM1**：連接外接數據機、滑鼠或其他支援序列通訊協定的裝置。
- **OPT-IN1**：本插座提供透過光纖連接到數位多媒體裝置的 S/PDIF 輸入。
- **OPT-OUT1**：本插座提供透過光纖連接到數位多媒體裝置的 S/PDIF 輸出。
- **AUDIO1**：7.1 聲道音效輸入/輸出連接。
- **IEEE1394**：連接 IEEE1394 通訊協定裝置。
- **LAN1**：連接區域網路。
- **USB1/USB2**：連接 USB 裝置，例如掃描器、數位喇叭、顯示器、滑鼠、鍵盤、集線器、數位相機或搖桿等。



## 4.2 简体中文

### 4.2.1 规格

---

#### 处理器

- 支持具备 1066MHz 前端总线的 Intel Core 2 Duo / Pentium D / Pentium 4 / Celeron D / Celeron 处理器
- 支持 Intel 超线程技术

---

#### 芯片组

- VIA P4M890 / VT8237R Plus

---

#### 内存

- 支持 DDR2 533 或 DDR 400 无缓冲非 ECC 内存
- 2 条 184 针脚 DIMM 插槽 (2.5V) 支持 DDR 400 内存最大 2GB 内存容量
- 2 条 240 针脚 DIMM 插槽 (1.8V) 支持 DDR2 533 内存最大 4GB 内存容量

---

#### 图形端口

- 整合 VIA UniChrome Pro 2D/3D 图形与影像控制器

---

#### 网络

- 内建 10/100M PCI 网络控制器

---

#### 音效

- 支持 5.1 声道 AC97 音效

---

#### 串行 ATA

- 2 个 SATA 1.5Gb/s

---

#### 扩充插槽

- 1 个 PCI-E X16 插槽
- 1 个 PCI-E X1 插槽
- 2 个 PCI 插槽

---

#### 内部输入/输出接头

- 1 个软盘端口
- 2 个 ATA 133 IDE 接头
- 2 个 SATA 1.5Gb/s 接头
- 2 个 USB 2.0 接头
- 1 个 FP-Audio 接头
- 1 个 CD-In 接头

---

#### 后面板输入/输出接头

- 1 个 PS/2 键盘接头
- 1 个 PS/2 鼠标接头
- 1 个 COM 连接埠
- 1 个 LPT 连接埠
- 1 个 VGA 连接埠
- 4 个 USB 2.0 接头
- 1 个 RJ-45 网络接头
- 1 个 5.1 声道音效接头

---

#### RoHS

- 100% 无铅制程符合 RoHS 规范

---

#### 其它

- Micro ATX 主机板规格 (244mm x 244mm)

※ 本手册的规格与信息若有变动，恕不另行通知。

## 4.2.2 快速安装指南

本“快速安装指南”仅包含基本的硬件信息，供您在安装 abit 主板时进行参考。如需了解高级操作，请参阅其详细指南。

### 硬件设置注意事项

- 在安装主板或更改任何设置前，务必关闭电源并从交流插座上拔掉电源线。
- 从防静电袋中取出主板前，应戴上静电安全腕带以使您正确接地。
- 用手拿着主板的边缘。不要触摸主板上的任何元件。
- 不要触摸模块触点和 IC 芯片。
- 将主板放在接地的防静电表面上或者放在主板附带的防静电袋中。

### 将主板安装到底盘上

此主板的计算机机箱应符合下列条件：

- 支持此主板的外形尺寸。
- 支持主板上的所有线缆连接器，能够连接到底盘上的指示灯和开关。
- 能够为您要安装的所有驱动装置提供充足的电源和空间。
- 底盘后面板上的 I/O 模板与主板上的 I/O 端口和扩展槽匹配。

要将主板安装到底盘上，您应该：

- 使 I/O 端口一侧朝向底盘的后部。
- 在主板和底盘上找到螺丝孔。
- 将所有销钉或柱杆放到底盘上，然后拧紧它们。
- 将底盘上的销钉或柱杆对准主板上的螺丝孔。
- 利用这些螺丝孔将主板固定在底盘上。

**如果底盘上已经安装了金属销钉或柱杆，并且在主板上没有它们的安装孔，为防止 PCB 短路，请“取下”这些金属销钉或柱杆。**

### CMOS 清除跳线

此跳线用于清除 CMOS 存储器以重置 BIOS 内容。当 BIOS 设置不正确并导致主板无法工作时，应清除 CMOS 存储器。

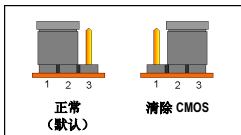

要清除 CMOS 存储器，请断开主板上的所有电源线，将跳线帽插到“清除 CMOS”位置上几秒钟，然后将跳线帽插回“正常”位置。重新接通所有电源并启动后，BIOS 内容将恢复成默认配置。

### 连接底盘元件

#### ATX 电源：[ATXPWR1]，[ATX12V1]

- 将标准的 ATX 电源连接到 2x12 针脚的 [ATXPWR1] 连接器。
- 将自备电源连接到 2x2 针脚的 [ATX12V1] 连接器。

#### 风扇连接器：

- [CPUFAN1]：CPU 冷却风扇连接器。
- [SYSFAN1]：系统冷却风扇连接器。
- [AUXFAN1]：辅助冷却风扇连接器。
- [NBFAN1]：北桥冷却风扇连接器。

**这些风扇连接器不是跳线。不要将跳线帽插到这些连接器上。**

#### 前面板连接器：[FPIO1]

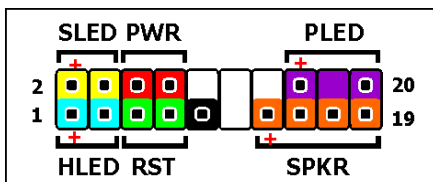

- [HLED]：连接 HDD LED 电缆。
- [RST]：连接复位开关电缆。
- [SPKR]：连接系统扬声器电缆。
- [SLED]：连接挂起 LED 电缆。
- [PWR]：连接电源开关电缆。
- [PLED]：连接电源 LED 电缆。

#### 前面板音频接头：[FP-AUDIO1]

本接头提供前面板 HD（高品质）音效连接。若要连接 AC'97 音效编码，您必须在连接到前面板模块之前仔细确认接头的针脚配置。如果配置错误可能导致主板故障或损毁。

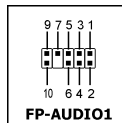

**请勿将前面板模块上标示为**

**“Ground”与“USB VCC”的缆线连接到此接头上标示为“AVCC”的第 4 针脚。**

针脚	针脚定义 (HD AUDIO)	针脚	针脚定义 (AC'97 AUDIO)
1	MIC2 L	1	MIC In
2	AGND	2	GND
3	MIC2 R	3	MIC Power
4	AVCC	4	NC
5	FRO-R	5	Line Out (R)
6	MIC2_JD	6	NC
7	F_IO_SEN	7	NC
9	FRO-L	9	Line Out (L)
10	LINE2_JD	10	NC



## 附加的 USB 端口接头: [FP-USB1]、[FP-USB2]

除了位于 I/O 面板上的板载 USB 连接器外, 这些接头可以通过带线卡的延长电缆分别提供两个附加的 USB 端口连接。

	针脚	针脚定义	针脚	针脚定义
	1	VCC	2	VCC
	3	负数据通道 0	4	负数据通道 1
	5	正数据通道 0	6	正数据通道 1
	7	接地	8	接地
			10	无连接

## 附加的 IEEE1394 端口接头: [FP-1394-1]、[FP-1394-2]

除了位于 I/O 面板上的板载 IEEE1394 连接器外, 这些接头可以通过带线卡的延长电缆分别提供一个附加的 IEEE1394 端口连接。

	针脚	针脚定义	针脚	针脚定义
	1	TPA0 +	2	TPA0 -
	3	接地	4	接地
	5	TPB0 +	6	TPB0 -
	7	+12V	8	+12V
			10	接地

## 内部音频连接器: [CD1]、[AUX1]

此连接器用于从内部 CD-ROM 驱动器或扩展卡的音频输出中选择音频。



## 安装 CPU 和过热降温装置

可供选择的中央处理单元 (CPU) 及其过热降温装置有很多种, 每一种的安装方式都不相同, 因此请严格按照产品包装中的安装说明进行操作。CPU 是一种精密的电子元件, 工作时会产生大量热量。操作时, 务请小心谨慎。

将过热降温装置安装到处理器上后, 把 CPU 冷却风扇的电源连接到主板上的 [CPUFAN1] 连接器。

## 安装内存模块

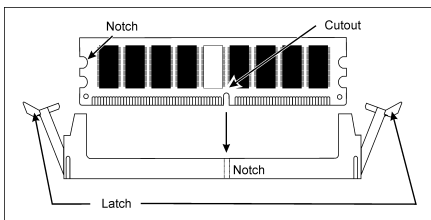

静电可能会损坏计算机或板卡选项件上的电子元件。在开始上述操作之前, 请触摸一下接地的金属物品, 以确保释放身上的静电。

## 连接存储设备

### 连接软盘驱动器: [FDC1]

### 连接 IDE 硬盘驱动器: [IDE1]、[IDE2]

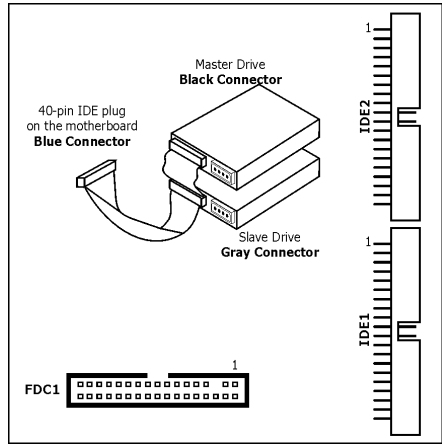

### 连接串行 ATA 硬盘驱动器: [SATA1] ~ [SATA4]

这些连接器的作用在于利用串行 ATA 电缆在每个通道上连接一个串行 ATA 设备。

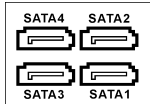

## 后面板连接

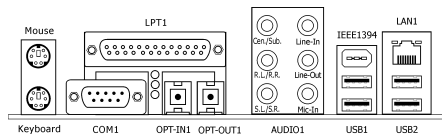

- **Mouse:** 连接 PS/2 鼠标。
- **Keyboard:** 连接 PS/2 键盘。
- **LPT1:** 连接打印机或其它支持并行通信协议的设备。
- **COM1:** 连接外部调制解调器、鼠标或支持串行通信协议的其它设备。
- **OPT-IN1:** 此连接器通过光纤提供 S/PDIF 输入连接, 用于连接数码多媒体设备。
- **OPT-OUT1:** 此连接器通过光纤提供 S/PDIF 输出连接, 用于连接数码多媒体设备。
- **AUDIO1:** 7.1 声道音效输入/输出连接。
- **IEEE1394:** 连接支持 IEEE1394 协议的设备。
- **LAN1:** 连接到局域网。
- **USB1/USB2:** 连接 USB 设备, 如扫描仪、数码扬声器、监视器、鼠标、键盘、集线器、数码相机、操纵杆等。



# 5. Appendix

## 5.1 Troubleshooting (How to Get Technical Support?)

### 5.1.1 Q & A

**Q: Do I need to clear the CMOS before I use a new motherboard to assemble my new computer system?**

A: Yes, we highly recommend that you clear the CMOS before installing a new motherboard. Please move the CMOS jumper from its default 1-2 position to 2-3 for a few seconds, and then back. When you boot up your system for the first time, follow the instructions in the user's manual to load the optimized defaults.

**Q: If my system hangs when I update the BIOS or set the wrong CPU parameters, what should I do?**

A: Whenever you update the BIOS or if the system hangs due to wrong CPU parameters setting, always clear CMOS jumper before booting up again.

**Q: Why does the system fail to boot up again right after a mechanical power-off?**

A: Please keep a 30-second interval between each mechanical power On/Off.

**Q: Why does the system fail to boot up and nothing displays on the screen after I did some over-clocking or non-standard settings inside the BIOS?**

A: It should not cause hardware or permanent damage to motherboard when BIOS settings were changed from default to over-clocking or non-standard status.

We suggest the following three troubleshooting methods to discharge CMOS data, recover the hardware default status, and then making the motherboard work again. There is no need to bother returning the motherboard to where you bought it from or go through an RMA process.

**Step 1.** Switch off the power supply unit and then switch it on again after one minute. If there is no power-switch on the power supply unit, disconnect its power cord for one minute and then reconnect.

Press and hold the <Insert> key on the keyboard, and press the power-on button to boot up system. If it works, release the <Insert> key and hit <Del> key to enter the BIOS setup page to apply the correct settings.

If the situation remains the same, repeat the procedures in Step 1 for three times, or try Step 2.

**Step 2.** Switch off the power supply unit or disconnect the power cord. Open the chassis cover. Locate the CCMOS jumper near the button battery. Change the jumper position from default 1-2 to 2-3 for one minute to discharge the CMOS data, and then put it back to default 1-2 position.

Close the chassis and switch on the power supply unit or plug in the power cord. Press the power-on button to boot up system. If it works, hit <Del> key to enter the BIOS setup page to do the correct settings.

If the situation remains the same, try Step 3.

**Step 3.** The same procedure as Step 2, but while discharging the CMOS data, pull out the ATX power connectors from motherboard and remove the button battery during CMOS discharge.

**Q: How to get a quick response for my request on technical support?**

A: Please carry out a simple troubleshooting before sending “**Technical Support Form**”:

**System boot-up fails after the system had been assembled:**

Check the motherboard’s supporting specifications first to see if all the key components attached in your system can meet.

To do so, you may:

- Remove all the unnecessary add-on devices (except the CPU, VGA card, DRAM, and Power Supply), and then reboot.
- If the trouble still exists, try another VGA card of different brand/model to see if the system will start.
- If the trouble still exists, try another memory module of different brand/model.
- If the trouble still exists, try another CPU and Power Supply.

If the system runs successfully, shut it down and start re-installing the interface cards and devices that were previously installed in the system. Re-install and start the system one at a time until the system won’t start.

**Malfunction in the OS:**

If the system hangs after resuming from S3 or some testing program, if the CPU cannot be recognized properly, if the display resolution mixed, or if a certain program cannot be executed, etc, you may:

- Upgrade the motherboard’s latest BIOS version.
- Upgrade the add-on device’s latest driver version.
- Check if there is any conflict in the “Control Panel/System Properties”.

**Q: How to fill in the “Technical Support Form”?**

A: To fill in this “**Technical Support Form**”, please refer to the following instructions:

- **Region:** Type in your country name.
- **E-mail:** Type in your contact E-mail information.
- **First name:** Type in your first name.
- **Last name:** Type in your last name.
- **Subject:** Type in the model name and the problem of your motherboard.  
Example 1: AA8XE and SCSI 29160 malfunction  
Example 2: AA8XE boot fails, POST code AF  
Example 3: AA8XE (system hang when S3 resume)
- **Motherboard:** Type in the model name and revision number of your motherboard.  
Example: AA8XE REV: 1.00
- **BIOS Version:** Type in the BIOS version of your motherboard. (You can find it on the screen during the POST sequence.)
- **CPU:** Type in the brand name and the speed (MHz) of your CPU. (Illustrate the over-clocking status if you had done so.)  
Example: Intel 650 3.4GHz (OC FSB=220MHz)
- **Memory brand:** Type in the brand and model name of your memory module.  
Example: Memory brand: Kingston (KVR533D2N4/1G)
- **Memory size:** Type in the size of your memory module.  
Example: 512M\* 4PCS

- **Memory configuration:** Type in the memory configuration in BIOS setting.  
Example: Memory Timing: 2.5-3-3-7 @533MHz
- **Graphics information:** Note Graphics card's brand, model and driver version
- **Graphics card:** Type in the brand and model name of your graphics card.  
Example: ATI RADEON X850 XT PE
- **Graphics driver version:** Type in the driver version of your graphics card  
Example: Catalyst 5.12V
- **Power supply maker:** Type in the brand and model name of your power supply unit.
- **Power supply wattage:** Type in the power wattage of your power supply unit.
- **Storage devices:** Type in the brand and specifications of your HDD drive and quantity. Specify if it was inserted on IDE (Master or Slave) or SATA ports, including the RAID allocation status.  
Example 1: WD Caviar WD600 60GB (on IDE2 master), Maxtor DiamondMax 10 SATA 300GB (on SATA 3)  
Example 2: Maxtor DiamondMax 10 SATA 300GB \*2 (on SATA 3, SATA 4 RAID 1)
- **Optical devices:** Type in the brand and specifications of your optical drives and quantity. Specify if it was inserted on IDE (Master or Slave) or SATA ports.
- **Other devices:** Indicate which add-on cards or USB devices that you *absolutely sure* are related to the problem. If you cannot identify the problem's origin, indicate all the add-on cards or USB devices inserted on your system.  
Example: AHA 29160 (on PCI 2), Sandisk Cruzer mini 256MB USB Flash-disk.
- **Operating system:** Indicate which OS and language version  
Example: Microsoft Windows XP SP2, English version  
Example: Microsoft Media Center Edition 2005, Korean version
- **Problem description:** Describe the problem of your system configuration. Indicate the steps to duplicate problem if possible.

See the next page for a blank Technical Support Form, or visit our website to fill in the form on line (<http://www.abit.com.tw/page/en/contact/technical.php>).

**Q. Is the motherboard dead? Do I need to return it to where I bought from or go through an RMA process?**

- A: After you had gone through the troubleshooting procedures, yet the problem still exists, or you find an evident damage on the motherboard. Please contact our RMA center.  
([http://www2.abit.com.tw/page/en/contact/index.php?pFUN\\_KEY=18000&pTITLE\\_IMG](http://www2.abit.com.tw/page/en/contact/index.php?pFUN_KEY=18000&pTITLE_IMG))

## 5.1.2 Technical Support Form

Region:	
E-mail:	
First name:	
Last Name:	
Subject:	
Motherboard:	
BIOS Version:	
CPU:	
Memory brand:	
Memory size:	
Memory configuration:	
Graphics card:	
Graphics driver version:	
Power supply maker:	
Power supply wattage:	
Storage devices:	
Optical devices:	
Other devices:	
Operating system:	
Problem description:	



## 5.1.3 Contact Information

---

### Taiwan Head Office

#### Universal ABIT Co., Ltd.

No. 323, Yang Guang St., NeiHu,  
Taipei, 114, Taiwan

Tel: 886-2-8751-3380

Fax: 886-2-8751-3381

Sales: [sales@abit.com.tw](mailto:sales@abit.com.tw)

Marketing: [market@abit.com.tw](mailto:market@abit.com.tw)

---

### North America, South America

#### Universal ABIT (USA) Corporation

2901 Bayview Drive,  
Fremont, CA 94538, U.S.A.

Tel: 1-510-623-0500

Fax: 1-510-623-1092

Website: <http://www.abit-usa.com>

Latin America: [ventas@abit-usa.com](mailto:ventas@abit-usa.com)

**RMA Center:** <http://rma.abit-usa.com>

---

### UK, Ireland

#### Universal ABIT UK Corporation

Unit 3, 24-26 Boulton Road, Stevenage,  
Herts SG1 4QX, UK

Tel: 44-1438-228888

Fax: 44-1438-226333

for technical support:

[technical@abitcomputer.co.uk](mailto:technical@abitcomputer.co.uk)

for RMA no direct technical support:

[returns@abitcomputer.co.uk](mailto:returns@abitcomputer.co.uk)

Tel: 44-1438-362088

---

**Germany and Benelux** (Belgium,  
Netherlands, Luxembourg), **France, Italy,  
Spain, Portugal, Greece, Denmark,  
Norway, Sweden, Finland, Switzerland**

#### Universal ABIT NL B.V.

Jan van Riebeeckweg 15, 5928LG,  
Venlo, The Netherlands

Tel: 31-77-3204428

Fax: 31-77-3204420

---

**Austria, Czech, Romania, Bulgaria,  
Slovakia, Croatia, Bosnia, Serbia,  
Macedonia, Slovenia**

#### Universal ABIT Austria Computer GmbH

Schmalbachstrasse 5, A-2201 Gerasdorf /  
Wien, Austria

Tel: 43-1-7346709

Fax: 43-1-7346713

Contact: [office@abit-austria.at](mailto:office@abit-austria.at)

Website: <http://www.abit-austria.at>

---

### Shanghai

#### Universal ABIT (Shanghai) Co. Ltd.

FL 19 Xuhui Yuan BLOG NO.1089  
ZhongShan s 2 RD, ShangHai 200030  
The People's Republic of China

Tel: (86-21) 54102211

Fax: (86-21) 54104791

Website: <http://www.abit.com.cn>

---

### Poland

#### Universal ABIT Poland (Rep. office)

Strzegomska 310/2, 54-432 Wroclaw

Tel: +48-71-718-12-39

Fax: +48-71-718-12-38

Contact: Grzegorz Morgiel

---

### Turkey

#### Universal ABIT Turkey (Rep. office)

Tel: 90 532 211 6860

---

**abit**

**UNIVERSAL ABIT Co., Ltd.**

<http://www.abit.com.tw>