

# Dreambox DM 500-S/C/T



## Bedienungsanleitung

Digitaler Satellitenempfänger zum Empfang von freien und verschlüsselten DVB-Programmen.

Kommunikations-Schnittstelle  
Smartcard Leser  
Linux OS

## User Manual

Digital satellite receiver for free and encrypted Digital Video Broadcasting (DVB).

Communication-Port  
Smartcard Reader  
Linux OS



## 1. Table of contents

1. Table of contents .....	- 2 -
2. Views .....	- 4 -
3. Explanation front panel .....	- 5 -
4. Explanation rear panel .....	- 5 -
5. Safety instructions .....	- 7 -
6. Shut down .....	- 8 -
7. Additional safety instructions .....	- 8 -
8. Disposal instructions .....	- 9 -
9. Packaging contents .....	- 10 -
10. Installation .....	- 10 -
11. Remote control .....	- 11 -
12. Important notes about operation .....	- 12 -
13. Remote control buttons .....	- 13 -
14. Turning your Dreambox on and off .....	- 15 -
15. Sleptimer .....	- 16 -
16. Main OSD Menu .....	- 16 -
17. Infobar .....	- 18 -
17.1 Infobar – EPG .....	- 19 -
17.2 Infobar – Sub Services .....	- 21 -
17.3 Infobar – Audio tracks .....	- 22 -
17.4 Infobar – Plugins .....	- 22 -
18. Setting OSD language .....	- 23 -
19. Setting the time zone .....	- 24 -
19.1 Manual time correction .....	- 26 -
20. Signal strength (Adjusting your antenna, DM 500-T) .....	- 27 -
20.1 Disable 5V (DM 500-T) .....	- 28 -
20.2 Automatic transponder scan (DM 500-T) .....	- 29 -
20.3 Manual transponder scan (DM 500-T) .....	- 31 -
21. Automatic transponder scan (DM 500-C) .....	- 32 -
21.1 Manual transponder scan (DM 500-C) .....	- 34 -
22. Satfinder (Adjusting your dish, DM 500-S) .....	- 35 -
23. Satellite configuration .....	- 36 -
23.1 one single satellite – direct connection .....	- 37 -
23.2 2 satellites via Toneburst .....	- 38 -
23.3 2 satellites via 22kHz (Highband only) .....	- 39 -
23.4 2 satellites via DiSEqC A/B .....	- 40 -
23.5 4 satellites via DiSEqC OPT A/B .....	- 41 -
23.6 Many satellites via DiSEqC Rotor .....	- 42 -
24. Motor setup .....	- 45 -
25. Example table for the DiSEqC 1.2 Rotor (SG21000) .....	- 46 -
26. Automatic transponder scan (DM 500-S) .....	- 47 -
27. Automatic multisat scan (DM 500-S) .....	- 50 -
28. Manual transponder scan (DM 500-S) .....	- 54 -
29. Edit a transponder (DM 500-S) .....	- 55 -
30. Service organizing – Adding a new Bouquet .....	- 58 -
30.1 Service organizing – Adding services to an existing Bouquet .....	- 60 -
30.2 Service organizing – Editing a Bouquet .....	- 62 -
31. Parental lock and Setup lock .....	- 64 -
31.1 Activating the parental lock .....	- 65 -
31.2 Deactivating the parental lock .....	- 67 -
31.3 Activating the setup lock .....	- 68 -
31.4 Deactivating the setup lock .....	- 70 -
32. Locking a service .....	- 71 -
33. Unlocking a service .....	- 72 -
34. Audio/Video settings .....	- 73 -
35. Keyboard .....	- 75 -

36. OSD settings .....	- 76 -
36.1 Skin Setup .....	- 78 -
36.2 Available Skins .....	- 79 -
36.3 Setting the teletext (TuxText) position .....	- 80 -
37. Teletext (TuxText) .....	- 82 -
38. Expert setup .....	- 84 -
38.1 Communications setup (Setting up LAN, NFS shares) .....	- 86 -
38.2 Ngrab – Streaming setup .....	- 89 -
38.3 Manual software update .....	- 90 -
38.4 Remote control setup .....	- 91 -
38.5 Reset to factory defaults .....	- 92 -
39. Timer .....	- 93 -
40. Information – Streaminformation .....	- 94 -
41. Information – About .....	- 95 -
42. Technical data .....	- 96 -
43. Contact & support information .....	- 98 -
44. Warranty card .....	- 99 -
45. Copyright notes .....	- 100 -
46. GNU General Public License .....	- 101 -

**Note:**                   The Dreambox DM 500 carries the CE-sign and fulfills all requirements form the EU.  
                                  Version: November 2005.  
                                  Software: Release 1.09  
                                  Subject to change without prior notification.

## 2. Views

### Front panel

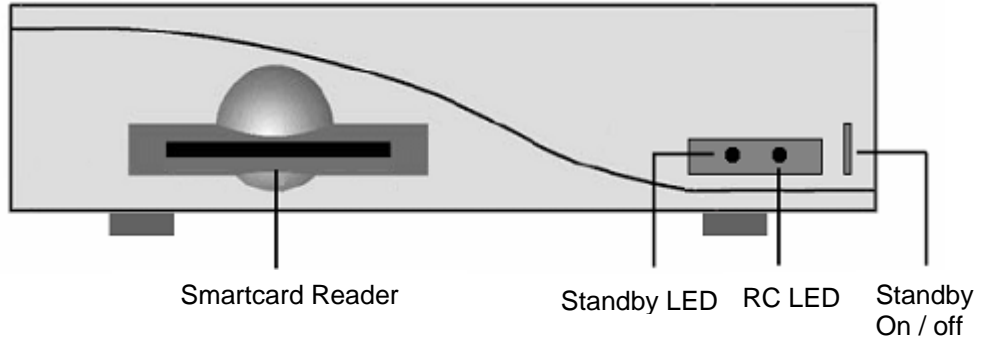

### Rear panel DM 500-C/T

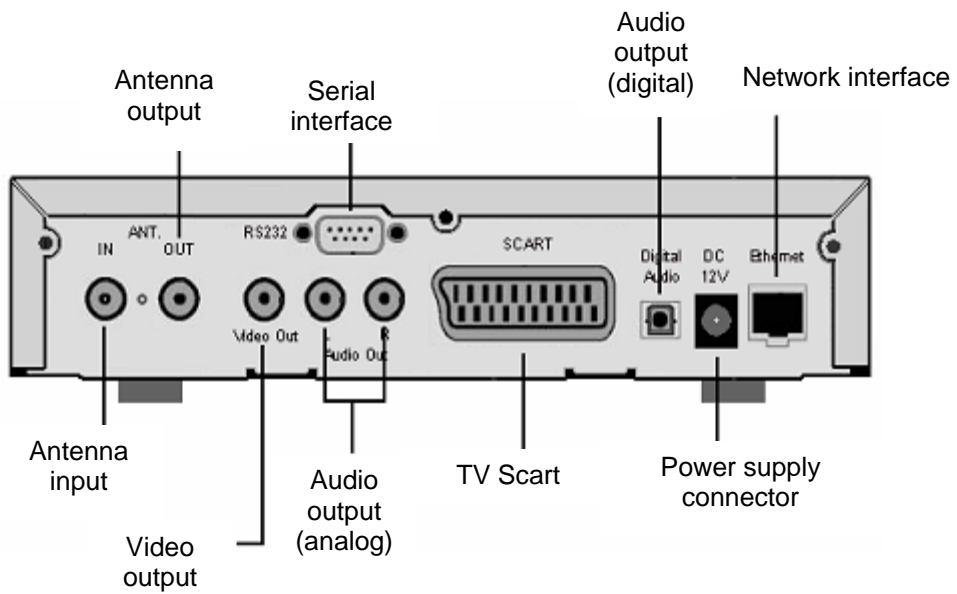

### Rear panel DM 500-S

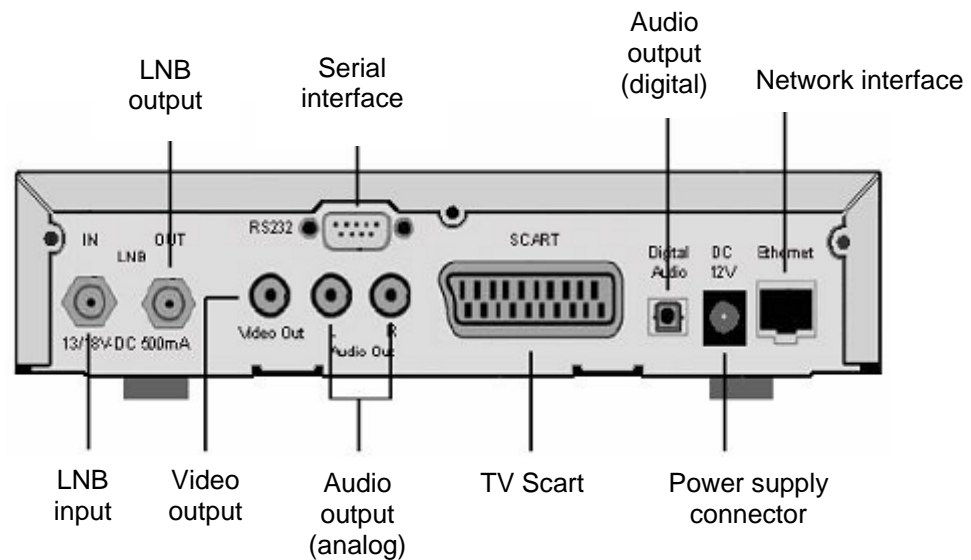

### **3. Explanation front panel**

#### **3.1 Smartcard Reader**

Insert your Dreamcrypt Smartcard with the golden chip facing down and forward into the Smartcard reader. Dreamcrypt is a registered trademark of Dream-Multimedia.

#### **3.2 Standby LED**

The Standby LED lights up red if the Dreambox is in standby mode. It lights up green if the Dreambox is powered on.

#### **3.3 Remote Control (RC) Led**

The remote control LED lights up every time the Dreambox receives a signal from the remote control.

#### **3.4 Standby on/off**

The Standby on/off button toggles between standby mode and powered on mode.

### **4. Explanation rear panel**

#### **4.1 Antenna input (DM 500-C/T)**

Connect your antenna cable here.

#### **4.2 Antenna output (DM 500-C/T)**

You can optionally connect your TV or VCR here.

#### **4.3 LNB input (DM 500-S)**

Connect the coaxial cable from your LNB here.

#### **4.4 LNB output (DM 500-S)**

You can connect an analogue/digital receiver here. Remember to shutdown your Dreambox completely in order for the receiver to work.

#### **4.5 Video output (FBAS)**

You can optionally connect your Dreambox to a TV using a RCA/Chinch cable. (Composite)

#### **4.6 Audio output - analog (Cinch)**

Connect your Dreambox with a RCA/Cinch cable to your HiFi-Amplifier (e.g. AUX In or Tape In ports).

#### **4.7 Serial interface (RS232C, Sub-D, 9-pin)**

The Serial Port is used to update the operating system. Please connect a serial null modem cable here.

#### **4.8 TV Scart**

Connect your TV or beamer to your Dreambox using a Scart cable.

#### **4.9 Audio output - digital (Toslink)**

You can connect your Dreambox with an optical (Toslink) cable to your HiFi-Amplifier or DSP. The AC3 signal is also available at this port in case the selected channel transmits Dolby Digital signals.

#### **4.10 Power supply connector**

Plug the power cable of the power supply that came with your Dreambox into power outlet. Connect your power supply to your Dreambox. You must not connect the power plug of the power supply to anything other than a socket that supplies 230V/50Hz.

#### **4.11 Network interface (Ethernet 10/100Mbit, RJ45)**

The Communication Port is an Ethernet port. It is used to communicate with your Dreambox via HTTP, FTP, NFS, Telnet and Samba. This port is also used to update the operating system of your Dreambox. Please use a regular patch cable to connect your Dreambox to your LAN.

## 5. Safety Instructions

**Please read the safety instructions completely and carefully, before using the Dreambox. The Manufacturer takes no responsibility for incorrect handling of the Dreambox.**

- Allow enough space around the Dreambox for sufficient ventilation.
- Do not cover the Dreambox's ventilation openings with items such as newspapers, tablecloths, curtains etc.
- Do not expose the Dreambox to dripping or splashing liquids.
- Do not place open flame sources, such as lit candles, on the Dreambox.
- Do not place any containers with liquid, such as vases, on the Dreambox.
- Do not connect or modify cables while the Dreambox is connected to the power.
- Do not remove the cover. Risk of electric shock!



- Do not put any metal things into the slots or ventilation openings.
- Please note that the only way to isolate the Dreambox completely from the main power supply is to unplug the main power cable!

### **WARNING!**

**Modifications and changes to the Dreambox lead to loss of warranty.  
We recommend the installation of a hard disk by your local dealer.  
Unskilled installation of a hard disk leads to loss of warranty.**

## 6. Shut Down

- In case your Dreambox is in use for a longer period of time disconnect the power plug from the power outlet.
- During thunder storm the unit should also be physically disconnected from the power outlet.

## 7. Additional safety instructions

- (Dis-)Connecting to a LNB:  
Turn the Dreambox off before you connect or disconnect a cable coming from a LNB.
- Connecting to a TV:  
Before connecting or disconnecting your Dreambox to a TV please turn it off.
- In case you notice any damage to the power cord or power plug immediately disconnect the unit from the power outlet.
- In case the unit was exposed to humidity immediately disconnect the unit from the power outlet.
- In case you notice any serious damage to the outer shell of the unit immediately disconnect the unit from the power outlet.
- Do not expose the Dreambox to direct sunlight, lightning or rain.
- Grounding:  
The LNB cable must be grounded.  
The grounding system must match SABS 061.
- Cleaning:  
Disconnect the mains power cord before cleaning the cover. Use a slightly damp cloth without cleaning agents
- Connect the Dreambox only to suitable sockets. Do not allow overloads to occur.



## 8. Disposal instructions

The packaging of the Dreambox only consists of reusable materials. Please recycle if possible.

This symbol on the product or on its packaging indicates that this product must not be disposed of with your other household waste. Instead, it is your responsibility to dispose of your waste equipment by handing it over to a designated collection point for the recycling of waste electrical and electronic equipment. The separate collection and recycling of your waste equipment at the time of disposal will help to conserve natural resources and ensure that it is recycled in a manner that protects human health and the environment.



For more information about where you can drop off your waste equipment for recycling, please contact your local city office, your household waste disposal service or the shop where you purchased the product.

Please note that empty batteries and electric waste is not to be put into the regular garbage.

## 9. Packaging contents

Please check the completeness of the box.

Included in box:

- 1 Dreambox DM 500
- 1 Power supply
- 1 Power cord
- 1 Remote control
- 2 Batteries (1,5V Micro / AAA / LR6)
- 1 User manual (latest release via Internet <http://www.dream-multimedia-tv.de> )

## 10. Installation

- Insert 2 AA (1,5V) batteries, taking care to observe the + and - markings indicated inside, into the remote control.
- Before using the Dreambox, please read the safety instructions.
- Connect the LNB or antenna with a coaxial cable to LNB or Antenna In at your Dreambox.
- Connect the Dreambox with a Scart cable to your television screen.
- Plug in the power cable into a 230V/50Hz power socket.
- If you are using a switchable power socket please shutdown your Dreambox into deep standby before switching off the power socket.
- If you switch on your Dreambox for the first time, you will see the setup wizard. The setup wizard will guide you through the first time installation. You will be asked for your TV standard, the regional settings and your language. Please choose and follow the instructions on the screen.
- Please note that the video format meets the factory setting CVBS (FBAS).

### 11. Remote Control

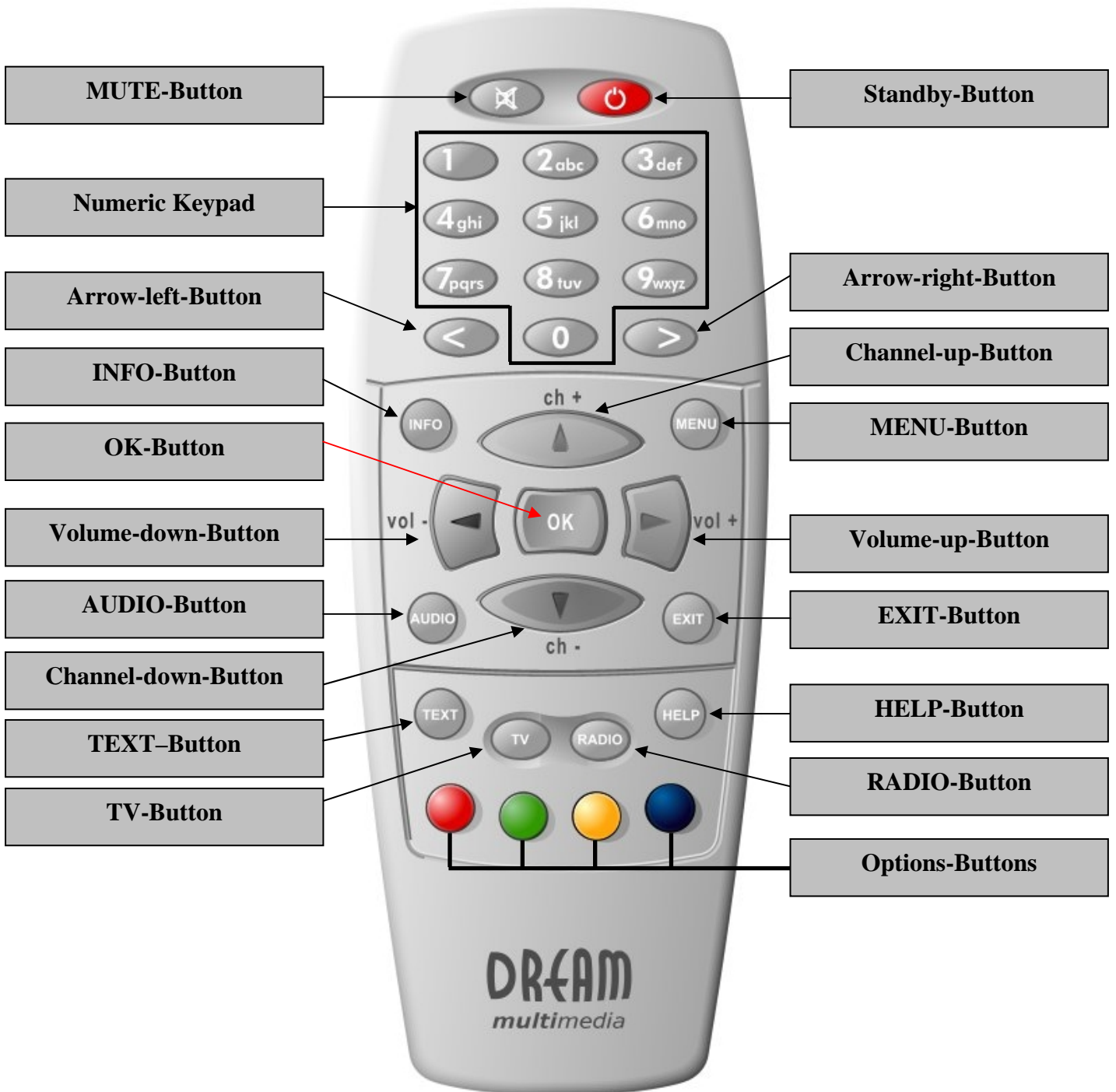

## 12. Important notes about operation

All functions of the Dreambox can be controlled via OSD-Menu (On-Screen-Display). This makes the handling of the Dreambox very easy for you. All options are indicated by four colored dots or beams (red, green, yellow, blue) in the OSD-Menu and can be started with the Option-Buttons on the Remote Control.

Depending on the chosen Menu, these options do change.



All Menus and Service lists are closed with the **EXIT-Button**.

During Menu and Channellist navigation the following buttons are used to navigate:  
**Channel-up** = up  
**Channel-down** = down  
**Volume down** = left  
**Volume up** = right

If you want to enter a Menu press the **OK-Button**.

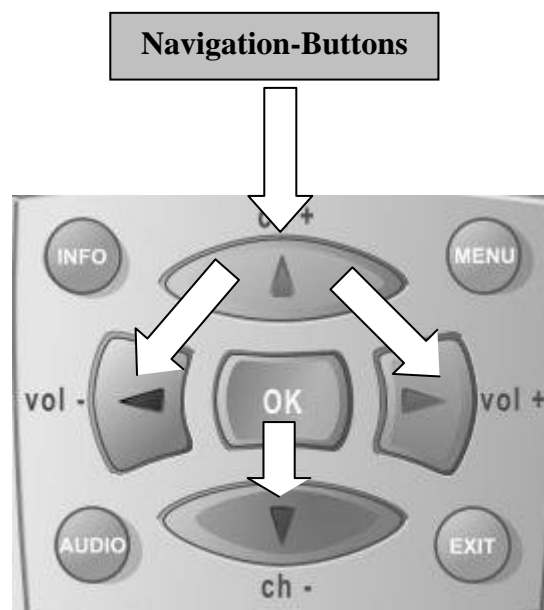

### 13. Remote Control Buttons

#### MENU-Button

If you are in TV- or RADIO-Mode, pressing this button will bring up the OSD main menu. The OSD main menu has the following options:

- (1) TV Mode
- (2) Radio Mode
- (3) File Mode
- (4) Information
- (5) Shutdown
- (6) Setup
- (7) Games
- (8) Timer



You can switch to the needed option by pressing the **Navigation-Buttons** left or right. Also see: **Important notes about operation**.

The numbers in front of each option can be used to directly access the needed function by pressing the according number on the **Numeric Keypad** of your Remote control.

If you are in the service list, pressing the **MENU-Button** brings up the service menu. The shown options may vary depending on the service list you selected.

#### Standby-Button

The **Standby-Button** switches your Dreambox on and off.  
Also see: **Turning your Dreambox on / off**.

#### Numeric Keypad

Enter a service number to directly access the option by using the **Numeric Keypad**. The service numbers are on the left side of the service list.

The **Numeric Keypad** can also be used to enter the page number in teletext mode, if you have pressed the **TEXT-Button** and activated the teletext decoder. The TV station has to submit teletext information; otherwise this feature cannot be used.

#### MUTE-Button

Pressing the **MUTE-Button** mutes the Volume. A crossed speaker symbol will appear on the TV screen. Pressing it again or pressing one of the Volume-up or down-Buttons brings back the audio.

**Arrow-left-Button****Arrow-right-Button**

These Buttons enable to jump back or forwards through the Playlist. The Playlist contains the last chosen services, which have been selected.

Once having opened the service list, you are able to jump at the Beginning or the End of the Servicelist or to the next Marker.

**INFO-Button**

If no OSD menu is visible on the screen and you are in TV or RADIO-Mode, pressing the **INFO-Button** will reveal the Infobar. Pressing it again while the Infobar still is visible will bring up the EPG information of the chosen station as long as it available.

**OK-Button**

By pressing the **OK-Button** you confirm a selection in the menu or service list navigation.

If no OSD menu is present on your screen, the service list is shown once you press the **OK-Button**.

**Channel-up-Button**

Pressing the **Channel-up-Button** takes you to the next station in your selected service list. If the menu or service list is visible this button will move the cursor up.

**Channel-down-Button**

Pressing the **Channel-down-Button** takes you to the previous station in your selected service list. If the menu or service list is visible this button will move the cursor down.

**Volume-up-Button**

Pressing the **Volume-up-Button** will turn up the volume. If the menu or service list is visible this button will move the cursor to the right.

**Volume-down-Button**

Pressing the **Volume-down-Button** will lower the volume. If the menu or service list is visible this button will move the cursor to the left.

**AUDIO-Button**

By pressing the **AUDIO-Button** you can choose the different audio tracks offered by the station. Different audio tracks are indicated by the yellow dot in the Infobar.

**EXIT-Button**

You can leave all menus and service lists by pressing the **EXIT-Button**.

**TEXT-Button**

The **TEXT-Button** activates the Teletext (TuxTxt). If you are in the stations list, pressing this button will directly take you to the FILE-Mode.

**TV-Button**

Pressing the **TV-Button** activates the TV-Mode.

**RADIO-Button**

Pressing the **RADIO-Button** activates the RADIO-Mode.

**HELP-Button**

Pressing the **HELP-Button** activates the Help menu.

**Options-Buttons**

All possible options are shown by the four colored dots/blocks (red, green, yellow, blue) and can be activated by the **Options-Buttons**.

Depending on the menu you currently are in the options will change and will be named differently.

## 14. Turning your Dreambox on and off

Use the **Standby-Button** to turn your Dreambox on and off.

To put your Dreambox into Standby-Mode either press the **Standby-Button** on your remote control or on your Dreambox.



Holding down the **Standby-Button** on your remote control for three seconds will show the Shutdown / Standby menu.

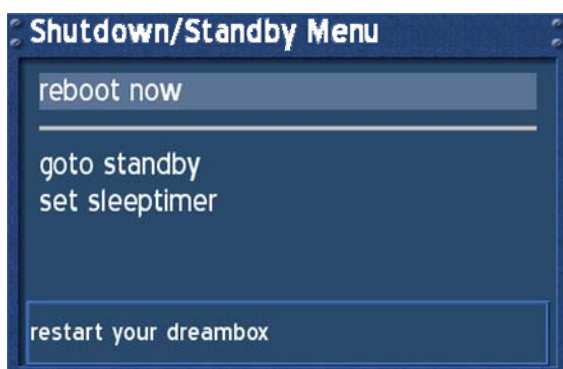

This is the Shutdown / Standby menu. Navigate to the desired option and confirm by pressing the **OK-Button**.

Reboot now:  
Your Dreambox will be rebooted.

Goto standby:  
Your Dreambox goes into standby mode.

Set sleeptimer:  
You can find an explanation in the section SleepTIMER.

## 15. Sleptimer

Press the Power-Button for at least 3 seconds, select "**set sleptimer**" to access this menu.

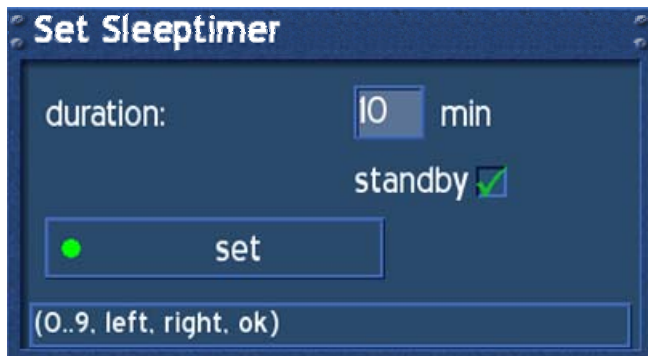

This is the sleptimer menu.

Define a maximum duration of 240 minutes. Define if the Dreambox should shutdown or should go into standby mode by setting a check into one of the checkboxes beside shutdown and standby using the **OK-Button**.

Either press the **green Options-Button** or the **OK-Button** to accept the setting.

## 16. Main OSD menu

If no OSD menu is shown on your screen you can access the main OSD menu by pressing the **Menu-Button** on your remote control.

Through the main OSD menu you can access the submenus and functions of your Dreambox. Please use the **Navigation-Buttons left and right or up and down**, depending on your main OSD menu's view, to access the desired functions and submenus. Use the **OK-Button** to activate your selection.

As an alternative you can directly access the submenu or function by pressing the corresponding number in your remote control's **Numeric Keypad**.



Selecting this symbol activates the TV mode.

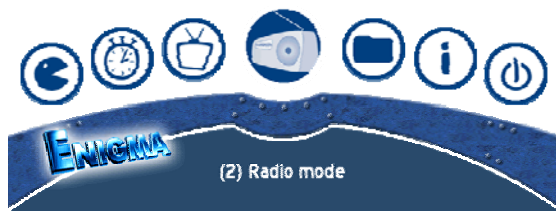

Selecting this symbol activates the Radio mode.

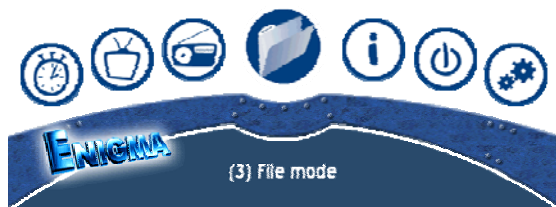

Selecting this symbol activates the file mode.



Selecting this symbol takes you to the Info menu. The Info menu supplies you with additional information about the station, signal strength and software version of your Dreambox.





Selecting this symbol takes you to the shutdown menu. Selecting the option ,Shutdown now' will turn you Dreambox off. Pressing the **Power-Button** on your remote control will turn your Dreambox on again.



Selecting this symbol takes you to the setup menu. You can change all your Dreambox's settings in the setup menu.



Selecting this symbol takes you to the games.

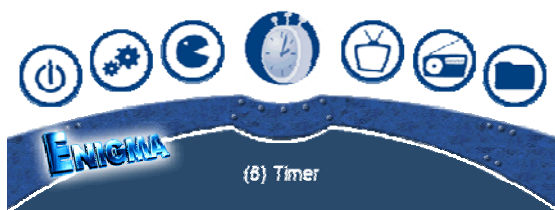

Selecting this symbol takes you to the Timer menu. All set timers can be viewed, changed and deleted here.



Through the menu options  
 (5) Setup ->  
 (3) System ->  
 (6) OSD Settings ->  
 You can choose to view the main OSD menu as a regular menu.

See section OSD Settings.

## 17. Infobar

The Infobar appears and disappears by pressing the **OK-Button** once, if no OSD menu is shown on your screen. The Infobar shows all necessary Information about the selected service.

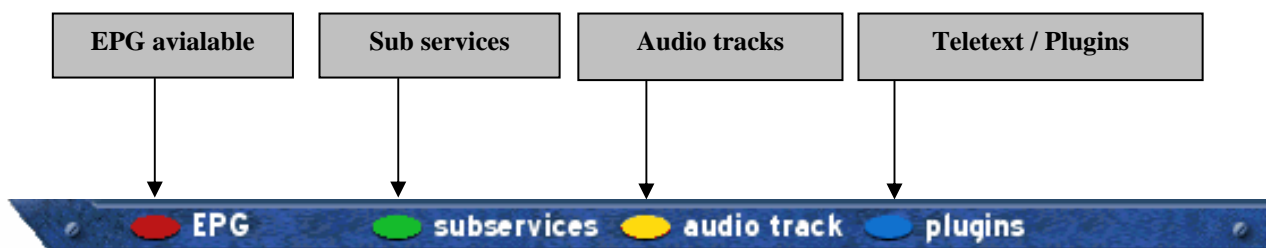
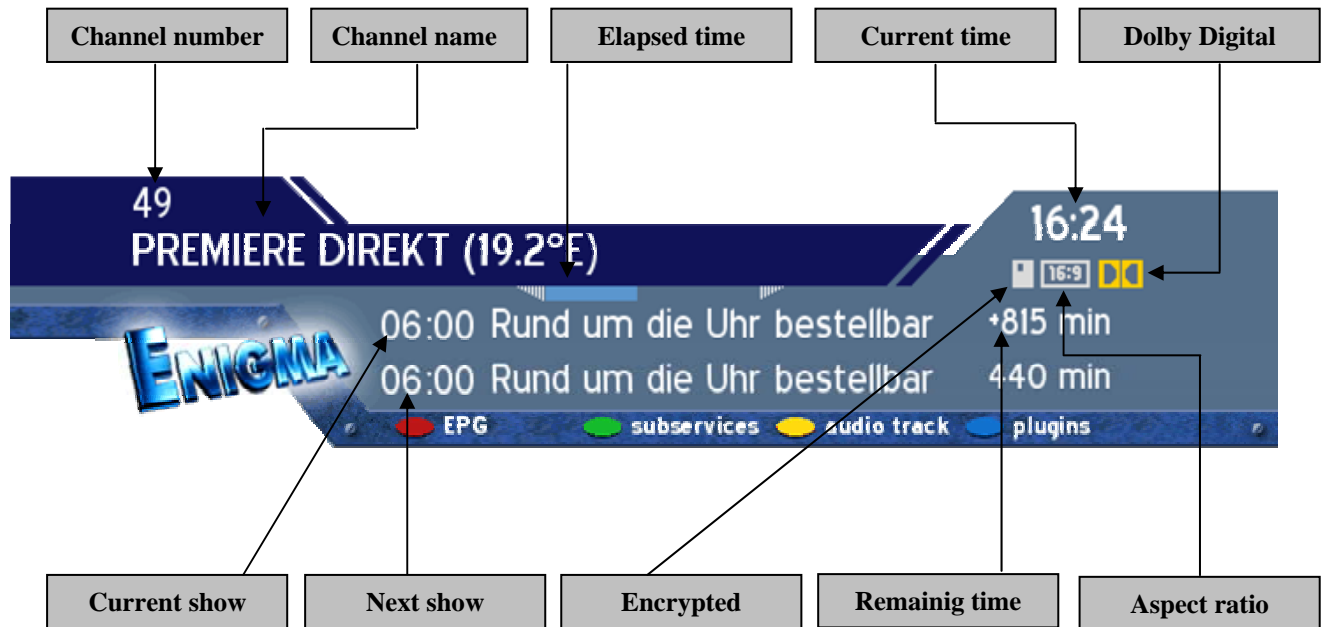

**Encrypted**

Is highlighted yellow as soon as a show is broadcasted encrypted.

**Apect ratio**

Is highlighted yellow as soon as a show is broadcasted in 16:9 aspect ratio.

**Dolby Digital**

Is highlighted yellow as soon as a show is broadcasted in Dolby Digital.

## 17.1 Infobar - EPG (Electronic Program Guide)

The red dot in the Infobar appears if the selected station transmits EPG information.



If no OSD menu is visible on your screen and you are in TV mode press the **TV-Button** to access the service list.

Press the **Info-Button** to get to the selection of the EPG style.

Or you can press the **red Options-Button** to directly access the EPG of the station without having to go through the service list.



Select „Channel EPG“ and press the **OK-Button** to activate it.



Use the **Navigation-Buttons** to navigate to the desired event and press the **OK-Button** to view additional information.

Pressing the **EXIT-Button** will quit the EPG.

The **Options-Buttons** are mapped differently in this view, press the **Help-Button** to see an explanation.



Pressing the **green Options-Button** will show the "Timer Edit" menu. Use the **Navigation-Buttons** to reach the desired option and use the **OK-Button** to open up the drop down menus.

Change the setting to fit your needs.

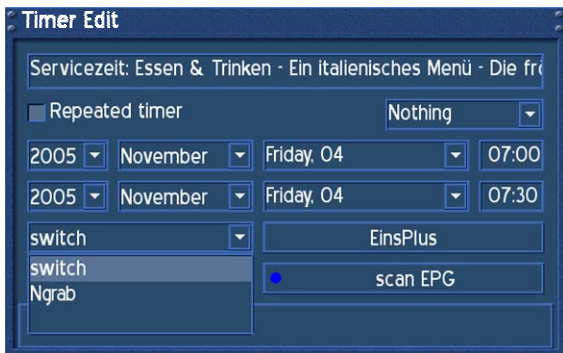

The drop down menu „Switch“ offers the same options that you can directly access from the EPG using the **colored Options-Buttons**.

„Switch“ will switch to the desired service.  
„NGrab“ will record via LAN.

Press the **green Options-Button** to save your settings.



After saving you timer event you will be taken back to the EPG.

The set timers will be symbolized with a red clock symbol for NGrab Timers and a yellow clock symbol for Switch Timers.



Press the numbers 1-6 to adjust the number of hours shown on the screen. The red line marks the current time.

If you selected Multi-EPG when you were asked for the EPG style you will see this view.

Use the **Navigation-Buttons** to navigate to the desired event. The current selection is highlighted gray. Pressing the **Info-Button** once will show additional information. Pressing the **Info-Button** again will return you to the Multi-EPG screen.

Pressing the **OK-Button** in Multi-EPG mode will directly switch to the selected service.

The **Options-Buttons** are mapped differently in this view, press the **Help-Button** to see an explanation.

Pressing the **EXIT-Button** will quit the EPG.

## 17.2 Infobar – Sub services

The green dot in the Infobar appears if the selected station transmits sub services.

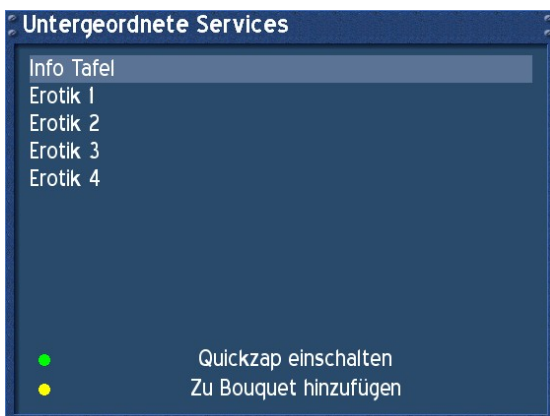

You can quit the Quickzap-Mode by either re-entering this menu and pressing the **green Options-Button** again or by accessing the service list and selecting a new service by pressing the **Navigation-Button up** or **down**.

Pressing the **green Options-Button** in TV or Radio mode will reveal the sub services menu.

Use the **Navigation-Buttons up** and **down** to move to one of the sub services. Press the **OK-Button** to select.

If you chose the option “Enable quickzap” (**green Options-Button**), you will stay in the sub services and can jump between the sub services by pressing the **Navigation-Buttons left** and **right**.

The option „Add to Bouquet“ (**yellow Options-Button**) will add the selected service to a newly created or already existing Bouquet of your choice. See section **Managing Services**.

### 17.3 Infobar – Audio tracks

The yellow dot in the Infobar appears if the selected station transmits multiple Audio tracks.

Pressing the **yellow Options-Button** in TV or Radio mode will reveal the audio menu of the service.



Use the **Navigation-Buttons up** and **down** to move to desired audio track. Press the **OK-Button** to select.

The contents of this menu will vary from service to service.

Move to the option "Stereo". Use the **Navigation-Buttons left** or **right** to choose the different audio modes, Left-Mono, Stereo, Right-Mono. Press the **OK-Button** to select.

### 17.4 Infobar - Plugins

The blue dot in the info bar is always visible.

Pressing the **blue Options-Button** in TV or Radio mode will reveal the Plugins menu.

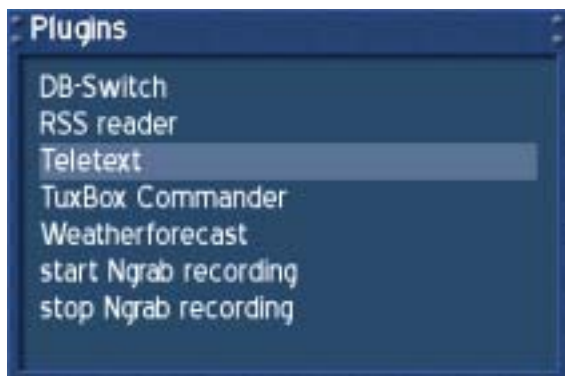

The option *Teletext - Software Decoder* will open the service's teletext.

See section **Teletext (TuxText)**.

The options „Start/Stop NGrab recording“ are still in development and therefore will not be explained in detail.



## 18. Setting OSD language

If no OSD menu is visible on your screen, press the **Menu-Button** to open the main OSD menu. Navigate to the option “Setup” and press the **OK-Button** to select.



Navigate to the option “System Settings” and press the **OK-Button**.



The “System Settings” menu will open up.

Navigate to the option “OSD Language” and press the **OK-Button**.



The “OSD Language” menu will open up.

Select your desired and language with the **Navigation-Buttons up** and **down**. Press the **OK-Button** to activate.

The **Exit-Button** will quit this menu.

## 19. Setting the time zone

If no OSD menu is visible on your screen, press the **Menu-Button** to open the main OSD menu. Navigate to the option “Setup” and press the **OK-Button** to select.



Navigate to the option “System Settings” and press the **OK-Button**.



The “System Settings” menu will open up.

Navigate to the option “Time” and press the **OK-Button**.

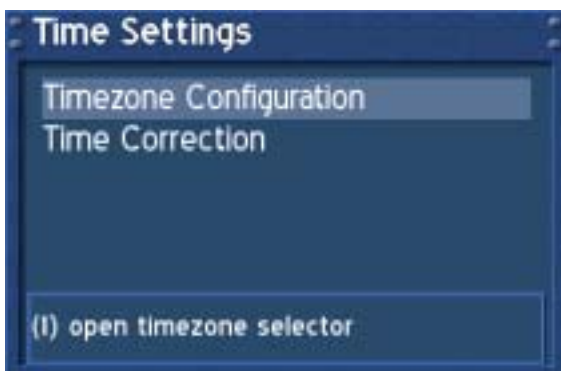

The “Time Settings” menu will open up.

You can either set your time zone or manually adjust the time of you Dreambox in this menu.

Navigate to the option “Time Zone Setup” and press the **OK-Button**.



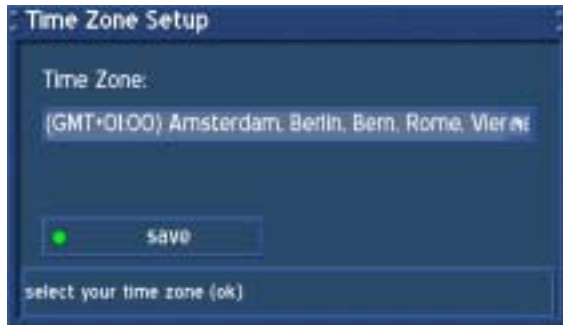

The “Time Zone Setup” menu will open up.

Press the **OK-Button** to get open the list of time zones.

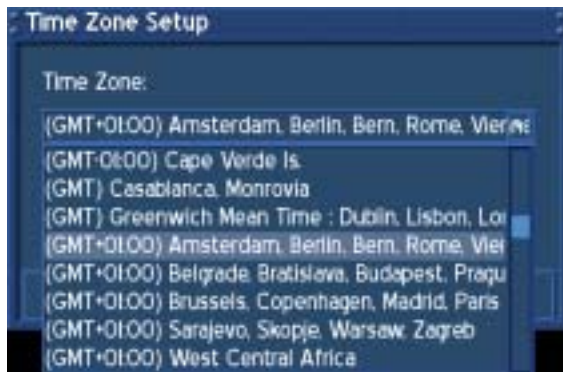

Select your desired and time zone with the **Navigation-Buttons up** and **down**. Press the **OK-Button** to activate.

The time zone list will disappear and your current selection is shown as seen in the picture above.



Navigate to the option “save” and press the **OK-Button** to save your settings. Optionally you can press the **green Options-Button** to save.

You are taken back to the “Time” menu.

## 19.1 Manual time correction

Please read the section **Setting the time zone** to learn how to get into this menu.

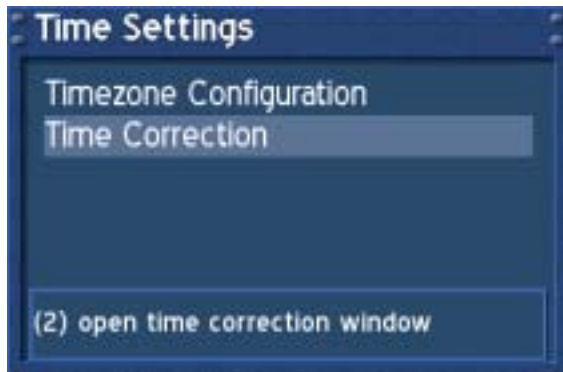

Navigate to the option "Time Correction" and press the **OK-Button**.



When entering this menu, please wait a second. The Dreambox tries to receive the current time. The Transponder Time and Date will be automatically updated. If this fails, enter the new time and date manually.

Navigate to the option "set" and press the **OK-Button** to save your settings. Optionally you can press the **green Options-Button** to save.

You are taken back to the "Time Settings" menu. Pressing the **Exit-Button** will leave this menu.

## 20. Signal strength (Adjusting your antenna, DM 500-T)

If no OSD menu is visible on your screen, press the **Menu-Button** to open the main OSD menu. Navigate to the option "Setup" and press the **OK-Button** to select.



Navigate to the option "Service Searching" and press the **OK-Button**.



Navigate to the option "Signalfind" and press the **OK-Button**.



Press the **OK-Button** to select a transponder.

Choose the region where you live in from the drop down menu „Region“ and press the OK-Button.

Move your antenna around a bit and keep an eye on the SNR and SGC values. The higher they are the better the reception is.

Pressing the **Exit-Button** will leave this menu.

## 20.1 Disable 5V (DM 500-T)

If no OSD menu is visible on your screen, press the **Menu-Button** to open the main OSD menu. Navigate to the option "Setup" and press the **OK-Button** to select.



Navigate to the option "Service Searching" and press the **OK-Button**.

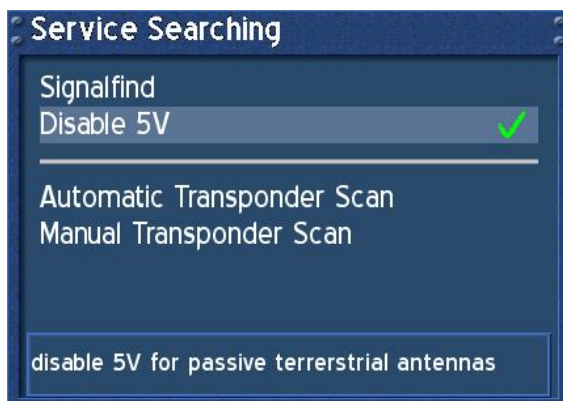

Navigate to the option "Disable 5V".

Press the **OK-Button** to set a check behind this option if you use a passive antenna.

If you connected an active antenna and want to use it without its power supply, press the **OK-Button** to remove the check behind this option.

## 20.2 Automatic transponder scan (DM 500-T)

If no OSD menu is visible on your screen, press the **Menu-Button** to open the main OSD menu. Navigate to the option “Setup” and press the **OK-Button** to select.



Navigate to the option “Service Searching” and press the **OK-Button**.



Navigate to the option “Automatic Transponder Scan” and press the **OK-Button**.



Select the region you live in the drop down menu and press the **OK-Button**.



You now should see that a valid transponder has been found and the checkboxes in front of "LOCK" and "SYNC" should be checked.

SNR:  
Signal to Noise Ratio

AGC:  
Automatic Gain Control

BER:  
Bit Error Rate (should be equals 0 if possible)

only Free:  
If you check the checkbox in front of the "only Free" option, your Dreambox will search on for FTA (non-encrypted) services.

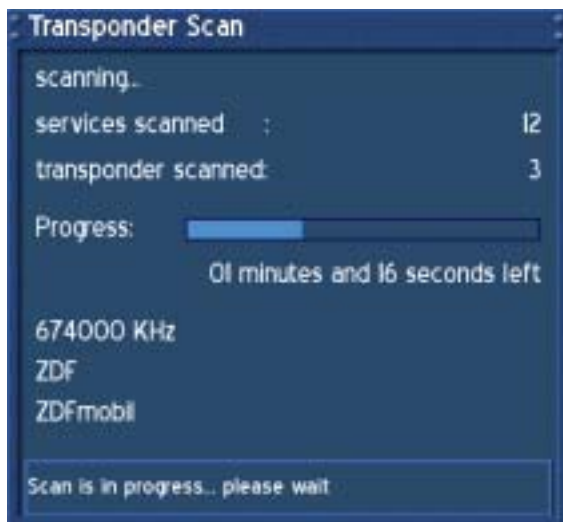

Press the **green Options-Button** to start searching.

After you started searching you will see the progress bar and the estimated remaining time.

Please wait until your Dreambox finished searching for services.

You can always abort the searching by pressing the **Exit-Button** several times.



Once your Dreambox is done searching you will see this menu on the right. A brief summary of the search is shown.

Press the **OK-Button** to close this menu.



### 20.3 Manual Transponder scan (DM 500-T)

If no OSD menu is visible on your screen, press the **Menu-Button** to open the main OSD menu. Navigate to the option "Setup" and press the **OK-Button** to select.



Navigate to the option "Service Searching" and press the **OK-Button**.



Navigate to the option "Manual Transponder Scan" and press the **OK-Button**.



Enter the desired frequency with the **Numeric Keypad** on your remote control.

Use the **Navigation-Buttons** to reach the individual options.

Press the **green Options-Button** to start the scan.

## 21. Automatic transponder scan (DM 500-C)

If no OSD menu is visible on your screen, press the **Menu-Button** to open the main OSD menu. Navigate to the option “Setup” and press the **OK-Button** to select.



Navigate to the option “Service Searching” and press the **OK-Button**.

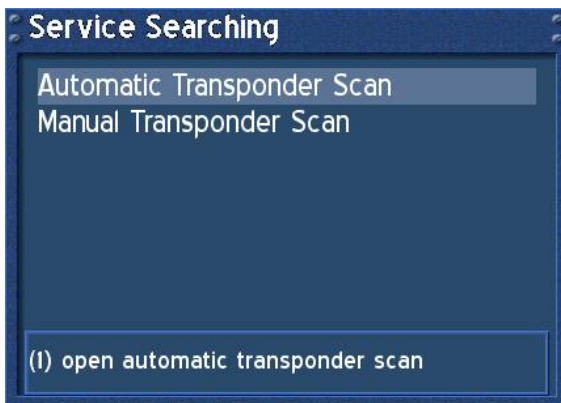

Navigate to the option “Automatic Transponder Scan” and press the **OK-Button**.



Select your cable provider in the drop down menu and press the **OK-Button**.





You now should see that a valid transponder has been found and the checkboxes in front of "LOCK" and "SYNC" should be checked.

SNR:

Signal to Noise Ratio

AGC:

Automatic Gain Control

BER:

Bit Error Rate (should be equals 0 if possible)

Only free:

If you check the checkbox in front of the "Only free" option, your Dreambox will search on for FTA (non-encrypted) services.



Press the **green Options-Button** to start searching.

After you started searching you will see the progress bar and the estimated remaining time.

Please wait until your Dreambox finished searching for services.

You can always abort the searching by pressing the **Exit-Button** several times.



Once your Dreambox is done searching you will see this menu on the right. A brief summary of the search is shown.

Press the **OK-Button** to close this menu.

## 21.1 Manual transponder scan (DM 500-C)

If no OSD menu is visible on your screen, press the **Menu-Button** to open the main OSD menu. Navigate to the option “Setup” and press the **OK-Button** to select.



Navigate to the option “Service Searching” and press the **OK-Button**.

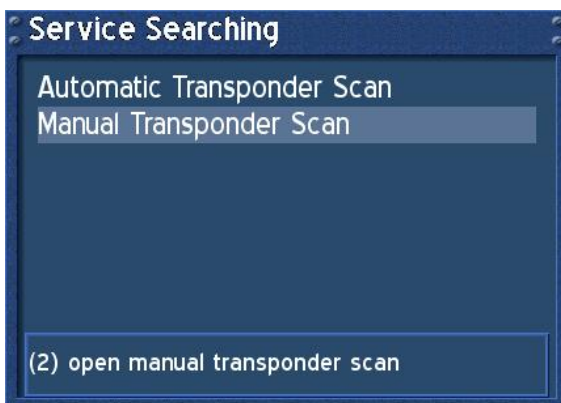

Navigate to the option “Manual Transponder Scan” and press the **OK-Button**.



Enter the desired frequency with the **Numeric Keypad** on your remote control.

Use the **Navigation-Buttons** to reach the individual options.

Press the **green Options-Button** to start the scan.

## 22. Satfinder (Adjusting your dish, DM 500-S)

If no OSD menu is visible on your screen, press the **Menu-Button** to open the main OSD menu. Navigate to the option "Setup" and press the **OK-Button** to select.



Navigate to the option "Service Searching" and press the **OK-Button**.



Navigate to the option "Satfind" and press the **OK-Button**.

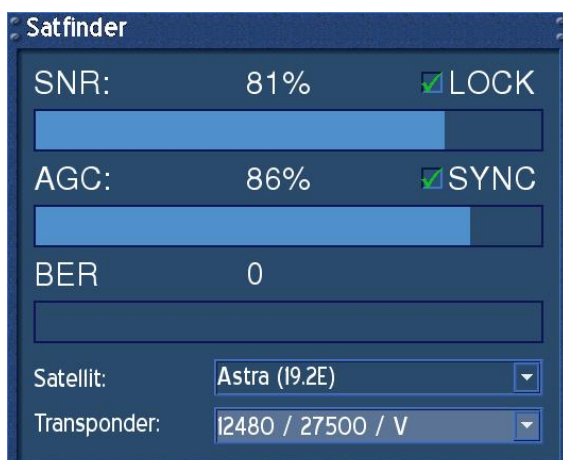

Select the satellite and transponder in the drop down menu and press the **OK-Button**.

Adjust the dish towards the desired satellite until you have a high value on the signal strength AGC and on the signal quality SNR indicator. The BER should always indicate a value of zero if the satellite is locked and synced.

### 23. Satellite configuration

If no OSD menu is visible on your screen, press the **Menu-Button** to open the main OSD menu. Navigate to the option "Setup" and press the **OK-Button** to select.



Navigate to the option "Service Searching" and press the **OK-Button**.



Navigate to the option "Satellite Configuration" and press the **OK-Button**.

## 23.1 one single satellite – direct connection

Use this type of configuration if you want to receive a single satellite with a Single Universal LNB. The coax cable is directly connected from you Dreambox to the LNB. Please read the section **Satellite configuration** to learn how to get into this menu.

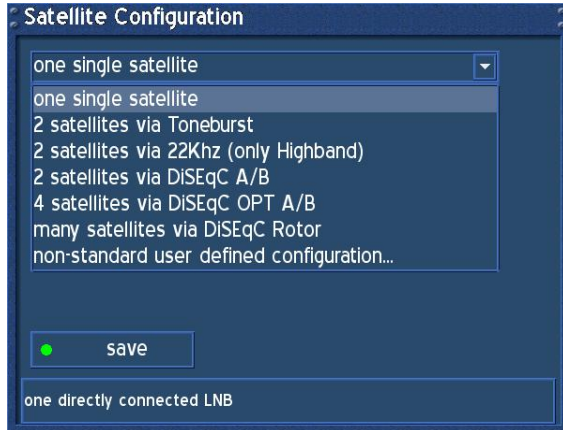

The “Satellite Configuration” menu will open up.

Choose the upper drop down menu and press the **OK-Button**.

A list of all possible configurations will show up.

Select the “one single satellite” option and press the **OK-Button**.

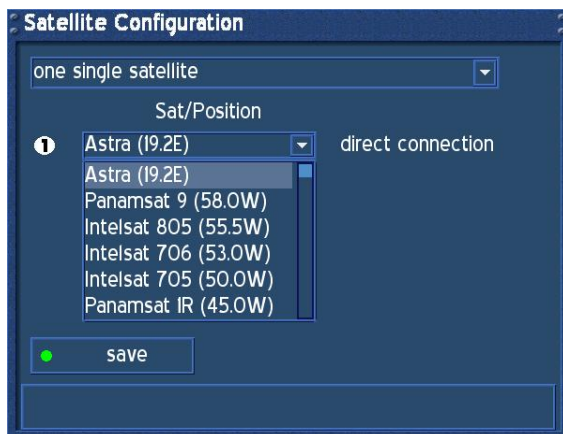

Choose the drop down menu „Sat/Position“ and press the **OK-Button**.

A list of all available satellites will show up.

Choose your desired satellite and press the **OK-Button**.

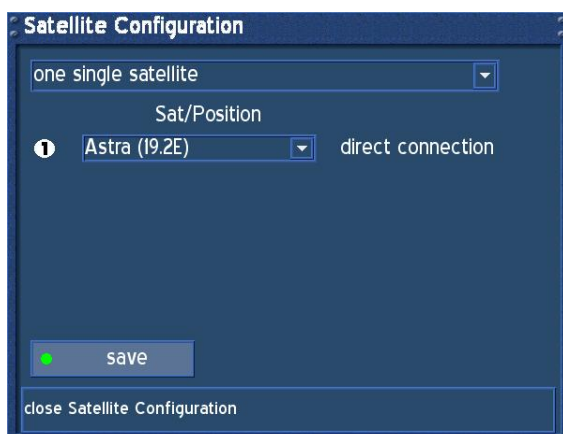

Choose “save” and press the **OK-Button**.

The configuration for “single satellite” is now done.

The menu “Transponder scan” will show up. See sections **Automatic transponder scan** or **Automatic multisat transponder scan** for details.



## 23.2 2 satellites via Toneburst

Use this type of configuration if you want to receive two satellites from one LNB each. It does not matter if you use one or two dishes to achieve this. Connect the two coax cables from the two LNBs to a so-called Toneburst switch and connect the coax cable from the Toneburst switch to your Dreambox. Please read the section **Satellite configuration** to learn how to get into this menu.

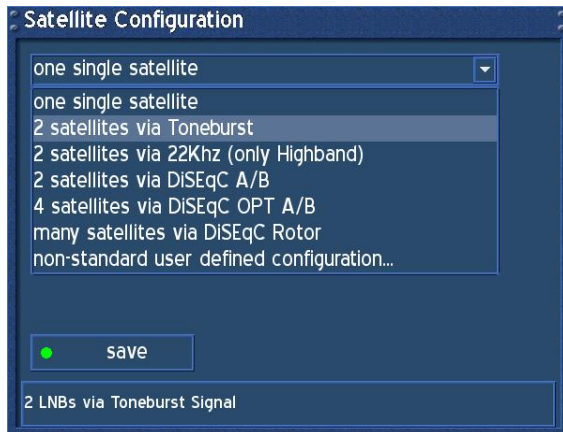

Choose the upper drop down menu and press the **OK-Button**.

A list of all possible configurations will show up.

Select the “2 satellites via Toneburst” option and press the **OK-Button**.

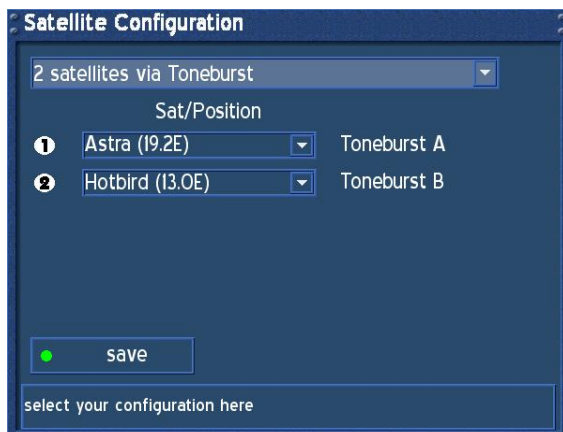

Select your desired satellites as described in the **one single satellite – direct connection** section.

Make sure you know which satellite is connected to which input on the Toneburst switch.

If you do not find any services in the transponder scan later, exchange the two satellites in this list and try again.

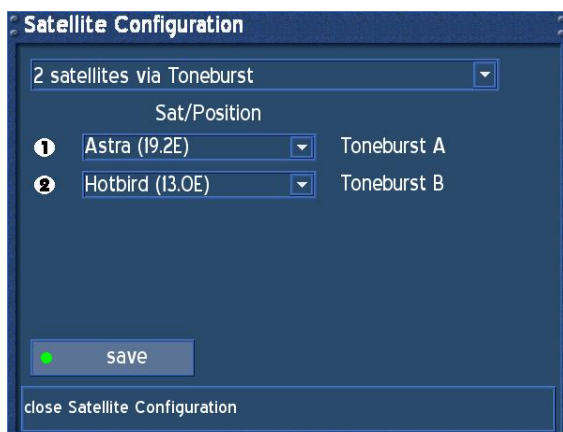

Choose “save” and press the **OK-Button**.

The configuration for “2 satellites via Toneburst” is now done.

The menu “Transponder scan” will show up. See sections **Automatic transponder scan** or **Automatic multisat transponder scan** for details.

### 23.3 2 satellites via 22KHz (Highband only)

Use this type of configuration if you want to receive two satellites from one LNB each. It does not matter if you use one or two dishes to achieve this. Connect the two coax cables from the two LNBs to a so-called 22kHz switch and connect the coax cable from the Toneburst switch to your Dreambox. Please read the section **Satellite configuration** to learn how to get into this menu.

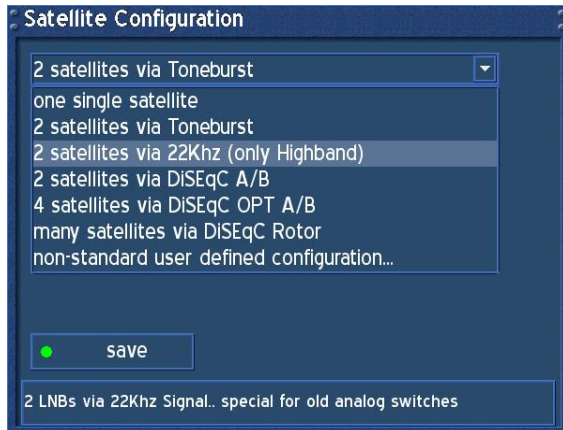

Choose the upper drop down menu and press the **OK-Button**.

A list of all possible configurations will show up.

Select the “2 satellites via 22kHz (Highband only)” option and press the **OK-Button**.

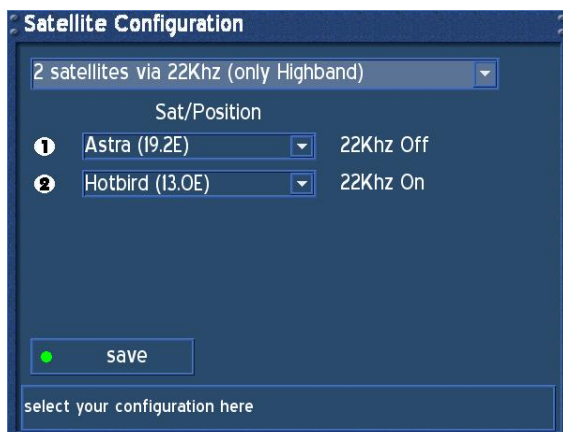

Select your desired satellites as described in the **one single satellite – direct connection** section.

Make sure you know which satellite is connected to which input on the 22kHz switch.

If you do not find any services in the transponder scan later, exchange the two satellites in this list and try again.

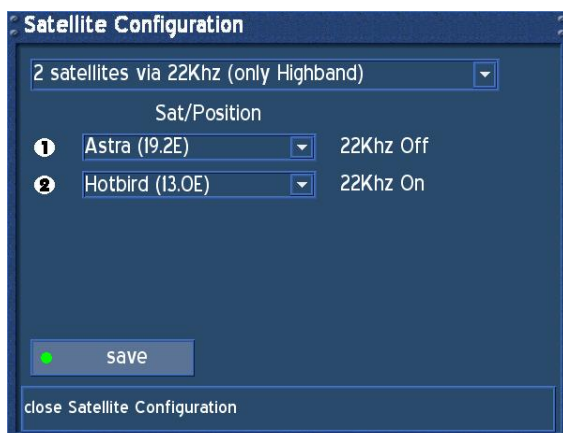

Choose “save” and press the **OK-Button**.

The configuration for “2 satellites via 22kHz (Highband only)” is now done.

The menu “Transponder scan” will show up. See sections **Automatic transponder scan** or **Automatic multisat transponder scan** for details.

## 23.4 2 satellites via DiSEqC A/B

Use this type of configuration if you want to receive two satellites from one Twin Universal or Quad Universal LNB. It does not matter if you use one or two dishes to achieve this. In this case the LNBs are connected to a so-called Multiswitch from which the signal is via coax cabled to the satellite receivers in your household. Please read the section **Satellite configuration** to learn how to get into this menu.

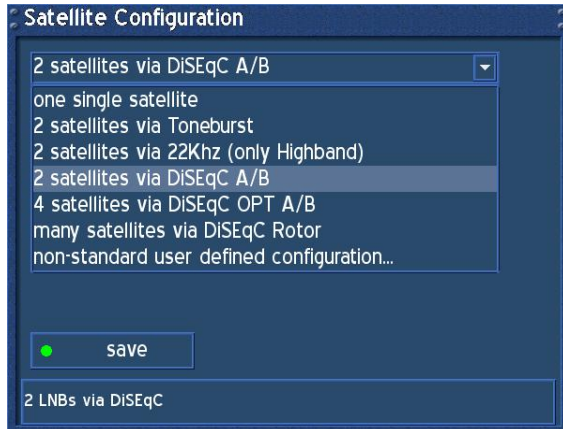

Choose the upper drop down menu and press the **OK-Button**.

A list of all possible configurations will show up.

Select the “2 satellites via DiSEqC A/B” option and press the **OK-Button**.

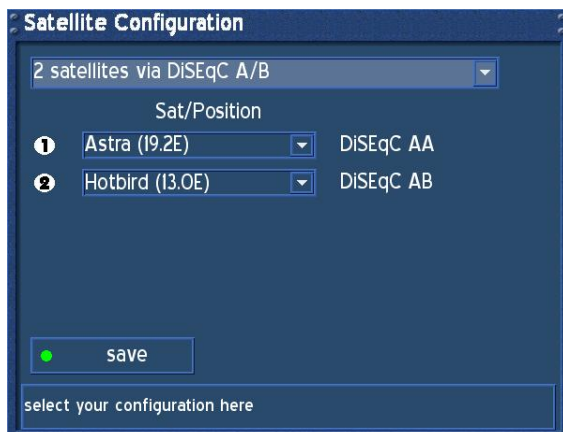

Select your desired satellites as described in the **one single satellite – direct connection** section.

Make sure you know which satellite is connected to which input.

If you do not find any services in the transponder scan later, exchange the two satellites in this list and try again.

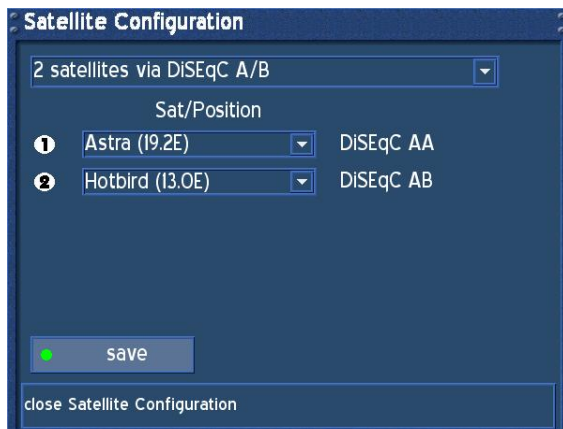

Choose “save” and press the **OK-Button**.

The configuration for “2 satellites via DiSEqC A/B” is now done.

The menu “Transponder scan” will show up. See sections **Automatic transponder scan** or **Automatic multisat transponder scan** for details.



## 23.5 4 satellites via DiSEqC OPT A/B

Use this type of configuration if you want to receive four satellites from one Twin Universal or Quad Universal LNB. It does not matter if you use one or two dishes to achieve this. In this case the LNBs are connected to a so-called Multiswitch from which the signal is via coax cabled to the satellite receivers in your household. Please read the section **Satellite configuration** to learn how to get into this menu.

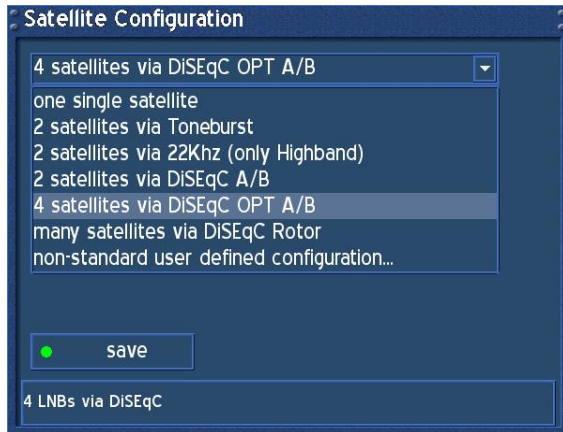

Choose the upper drop down menu and press the **OK-Button**.

A list of all possible configurations will show up.

Select the “4 satellites via DiSEqC OPT A/B” option and press the **OK-Button**.

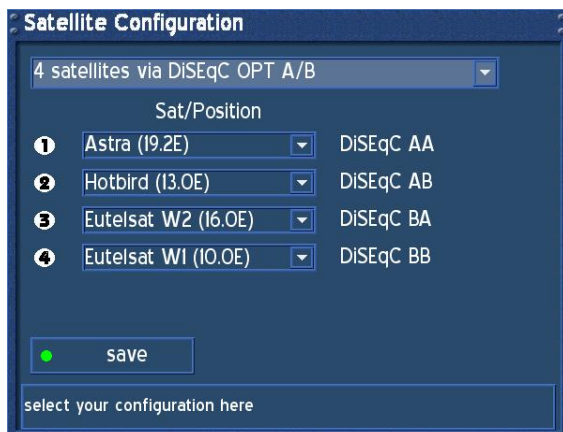

Select your desired satellites as described in the **one single satellite – direct connection** section.

Make sure you know which satellite is connected to which input.

If you do not find any services in the transponder scan later, exchange the two satellites in this list and try again.



Choose “save” and press the **OK-Button**.

The configuration for “4 satellites via DiSEqC OPT A/B” is now done.

The menu “Transponder scan” will show up. See sections **Automatic transponder scan** or **Automatic multisat transponder scan** for details.

## 23.6 Many satellites via DiSEqC Rotor

Use this type of configuration if you want to receive many satellites with a DiSEqC 1.2 Rotor or Stab from a Single Universal LNB. The coax cable is directly connected from your Dreambox to the LNB. Please read the section **Satellite configuration** to learn how to get into this menu.

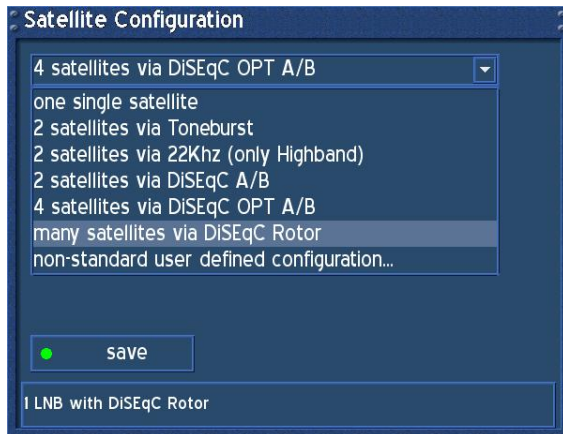

Choose the upper drop down menu and press the **OK-Button**.

A list of all possible configurations will show up.

Select the "Many satellites via DiSEqC Rotor" option and press the **OK-Button**.



Edit the list of the satellites you can and want to receive. The order does not matter in this case. The number of satellites you can receive varies depending on your Rotor or Stab.

Press the **green Options-Button** to save your settings. You will be taken back to the service searching menu.

**Hint:**

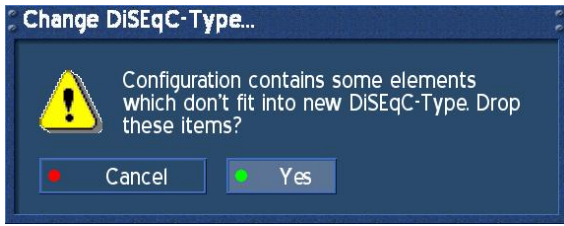

If you do not want to change the satellite position list before hand, just select the option "Single satellite – direct connection" and choose "Yes" in case you are prompted the message on the left.

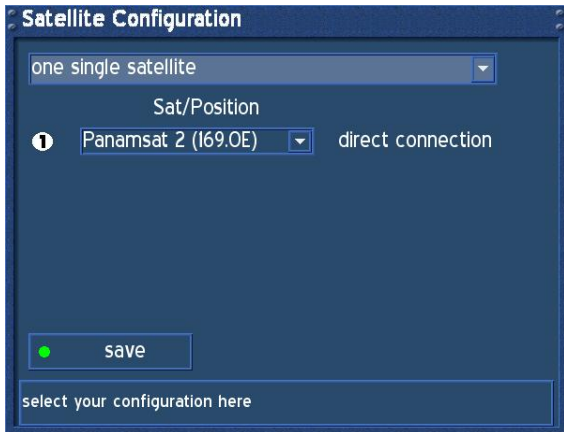

You will now see the configuration menu depicted on the right.

Choose "Non standard – user defined configuration" in the upper drop down menu. Press the **OK-Button**.

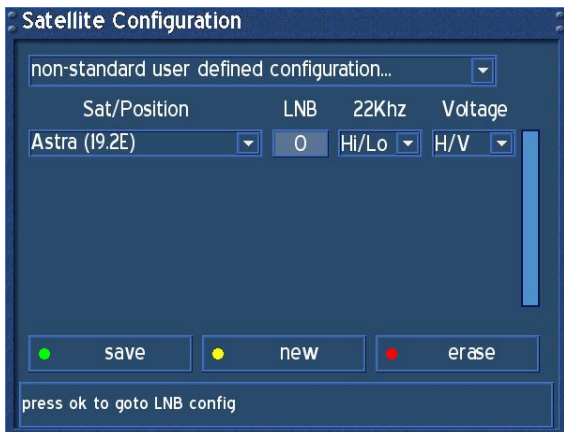

For now you will only see one satellite in the list. Please select LNB 0 and press the **OK-Button**.

Astra 19.2° Ost is preset for your convenience.

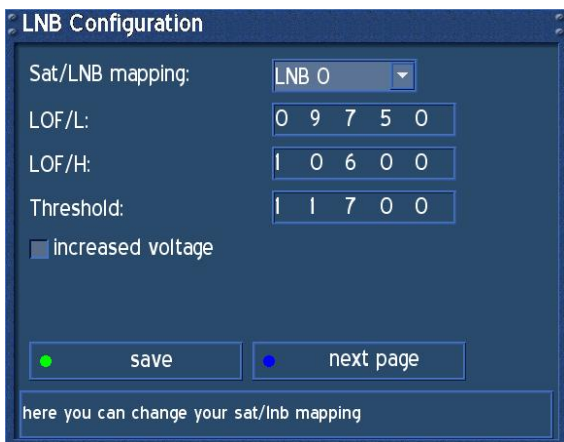

The sub menu "LNB configuration" will show up.

Please change nothing here for now. Except in cause your coax cable to the LNB has a too high damping value you can check the checkbox in front of "Higher voltage". Usually this is not necessary..

Now please press the **blue Options-Button** to get to the next sub menu.

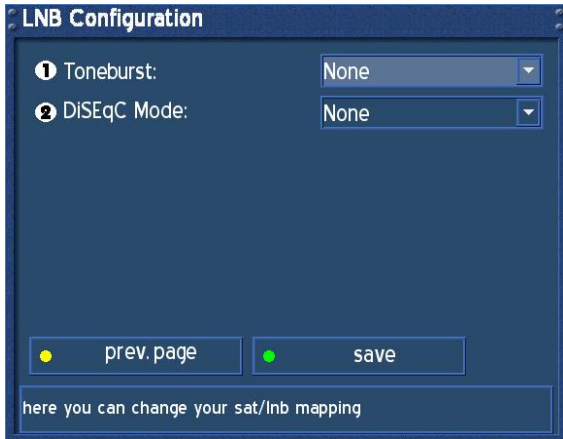

As you can see, the „DiSEqC - Mode“ is not set yet.

Please leave the “Toneburst” mode as it is.

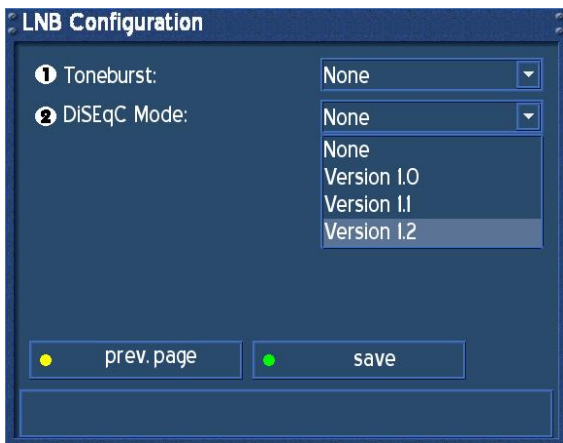

Press the number “2” on your **Numeric Keypad** and select the “DiSEqC – Mode” Version 1.2.

To save the settings press the **OK-Button**.

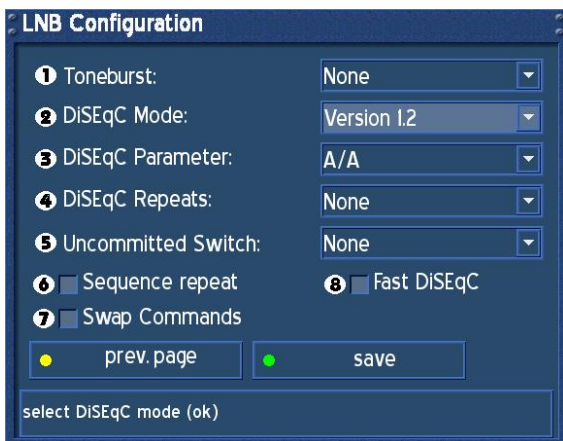

The menu will change and reveal additional options now.

There is no need to change anything here.

Press the **green Options-Button** to save the settings.

You are taken back to the “Satellite configuration” menu.

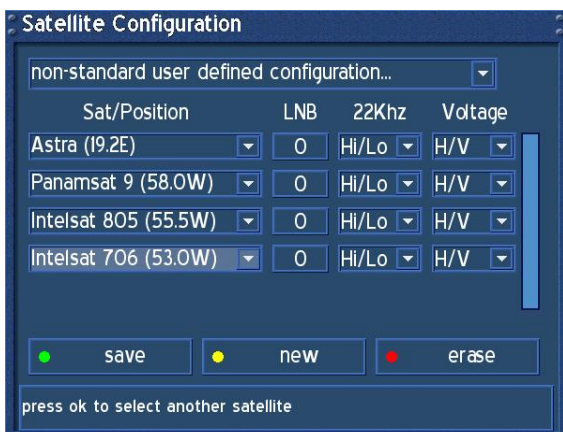

You can now use the **yellow Options-Button** to add more satellites.

Once you are done press the **green Options-Button** to save your settings.

You are now taken back to the “Transponder scan” menu.

W

## 24. Motor Setup

Use this type of configuration if you want to receive many satellites with a Rotor or Stab from a Single Universal LNB. The coax cable is directly connected from you Dreambox to the LNB. Please read the section **Satellite configuration** to learn how to get into this menu.



Choose the drop down menu „*Motor Setup*“ and press the **OK-Button**.

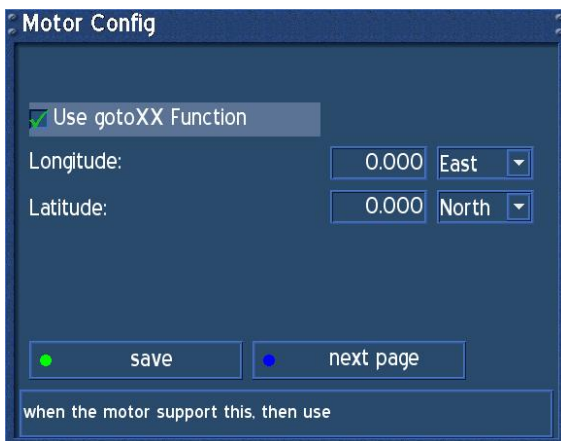

Refer to the Rotors Manual for correct values degrees/second.

Visit the Website <http://www.heavens-above.com> to figure out your geographical location. Enter the values for Longitude and Latitude and press the **green Option-Button** to save you settings.

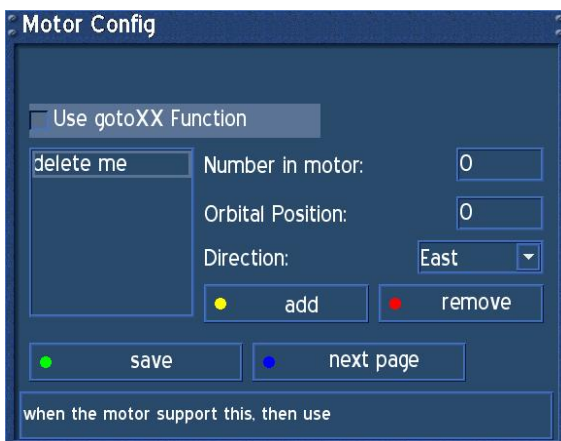

Remove the check from the checkbox in front of “Use gotoXX function” to use a DiSEqC 1.2 Rotor like the SG2100 Rotor without USALS support.

As you can see on the left, a new menu with new options will appear.



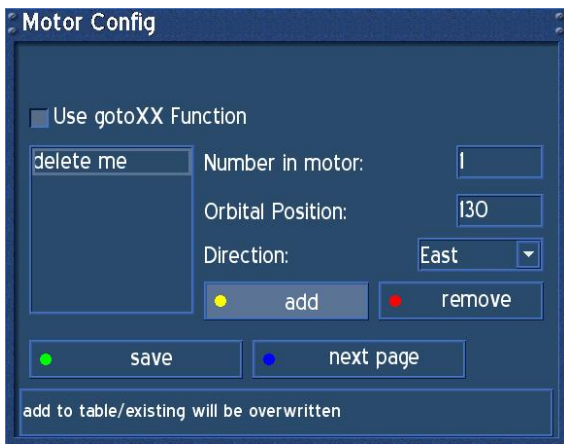

Take the list of preset satellite positions of your rotor, which can usually be found in the rotor's manual and add each satellite that you want to receive in the list in the left.

i.e.: Number 1 in the rotor is Hotbird 13° Ost

You will have to enter a 1 in the "Number in rotor" field and a 130 in the "Orbital position" field.

For a better understanding please take a look at the **Example table for the DiSEqC 1.2 Rotor (SG2100)**. It is borrowed from the original manual.

Press the **yellow Options-Button** to add the satellite to your list.

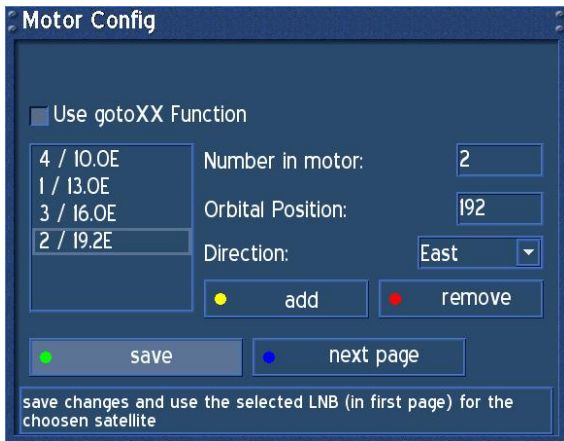

An example table of 4 satellites is depicted on the left.

**Attention:** You can later on only scan for services on satellites that you have entered in this list.

Press the **green Options-Button** to save your settings.

The menu "Transponder scan" will show up. See sections **Automatic transponder scan** or **Automatic multisat transponder scan** for details.

25. Example table for the DiSEqC 1.2 Rotor (SG2100)

Nummer in Rotor	Satellitenname	Position	Wert für Orbital Position Dreambox	Nummer in Rotor	Satellitenname	Position	Wert für Orbital Position Dreambox
1	Hotbird	13° O	130 O	14	Hispasat	30° W	300 W
2	Astra	19.2° O	192 O	15	Telstar 11	37.5° W	375 W
3	Eutelsat W2	16° O	160 O	16	Kopernikus	23.5° O	235 O
4	Eutelsat W1	10° O	100 O	17	Arabsat 2A3A	26° O	260 O
5	Eutelsat W3	7° O	70 O	18	Astra 2	28.2° O	282 O
6	Sirius 2/3	5° O	50 O	19	Eurobird	28.5° O	285 O
7	Thor 2/3	0.8° W	8 W	20	Arabsat 2B	30.5° O	305 O
8	Intelsat 707	1° W	10 W	21	Türksat 1B	31.3° O	313 O
9	Telekom 2C	5° W	50 W	22	Türksat 1C	42° O	420 O
10	Telekom 2D	8° W	80 W	23	Intelsat 601	34.5° W	345 W
11	Intelsat 705	18° W	180 W	24	Pas 3R	43° W	430 W
12	NSS 803	21.5° W	215 W	25	Amos	4° W	40 W
13	Intelsat 605	27.5° W	275 W	26	Nilsat	7° W	70 W

O = East, W = West (this table is not up to date, it is only for explanation)

## 26. Automatic transponder scan (DM 500-S)

If no OSD menu is visible on your screen, press the **Menu-Button** to open the main OSD menu. Navigate to the option “Setup” and press the **OK-Button** to select.



Navigate to the option “Service Searching” and press the **OK-Button**.



Navigate to the option “Automatic Transponder Scan” and press the **OK-Button**.

This option is primarily used for only scanning a single satellite in your list.

Please select the option “Automatic Multisat Scan” if you want to scan for services on all set satellites at once. See section **Automatic Multisat Scan** for details.

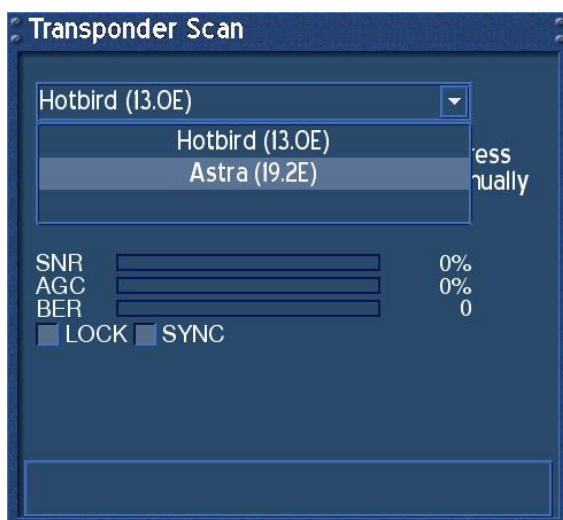

Select one of the two satellites in the drop down menu and press the **OK-Button**.

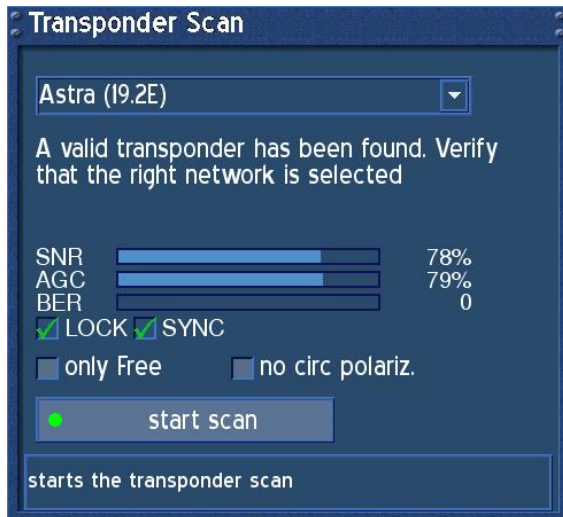

You now should see that a valid transponder has been found and the checkboxes in front of "LOCK" and "SYNC" should be checked.

SNR:

Signal to Noise Ratio

AGC:

Automatic Gain Control

BER:

Bit Error Rate (should be equals 0 if possible)

only Free:

If you check the checkbox in front of the "only Free" option, your Dreambox will search on for FTA (non-encrypted) services.

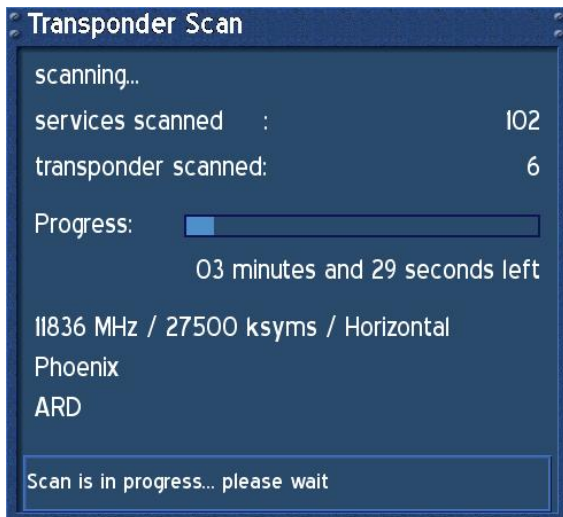

No circular polarization:

If you scan anything other than a C-Band satellite please check the checkbox.

Press the **green Options-Button** to start searching.

After you started searching you will see the progress bar and the estimated remaining time.

Please wait until your Dreambox finished searching for services.

You can always abort the searching by pressing the **Exit-Button** several times.

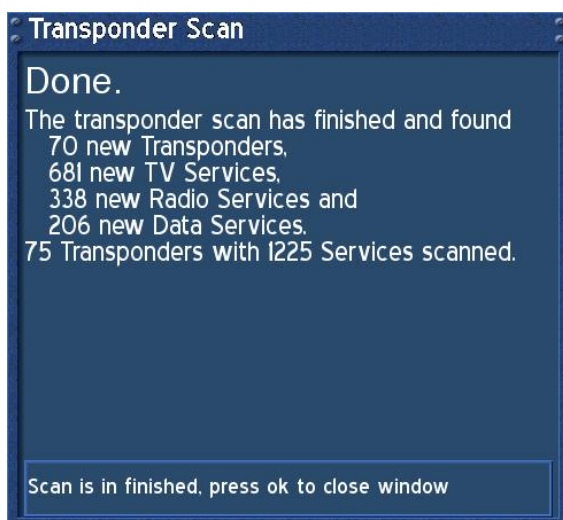

Once your Dreambox is done searching you will see this menu on the right. A brief summary of the search is shown.

Press the **OK-Button** to close this menu.



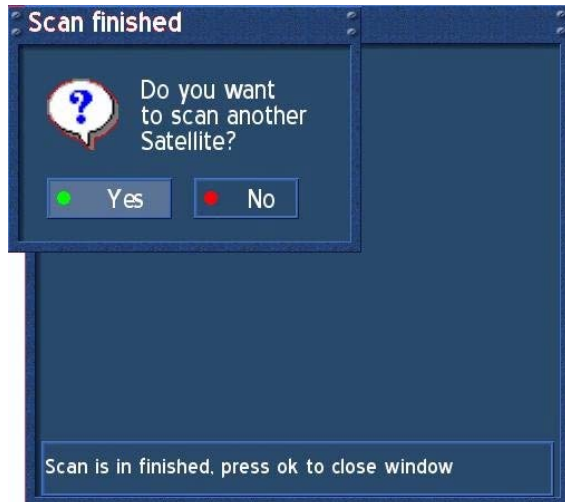

You will now be prompted if you want to scan another satellite. Press the **green Options-Button** if that is the case and you have setup another satellite in the satellite list.

Press the **red Options-Button** to end the scan.

You are taken back to the "Service searching" menu.

## 27. Automatic multisat scan (DM 500-S)

If no OSD menu is visible on your screen, press the **Menu-Button** to open the main OSD menu. Navigate to the option “Setup” and press the **OK-Button** to select.



Navigate to the option “Service Searching” and press the **OK-Button**.

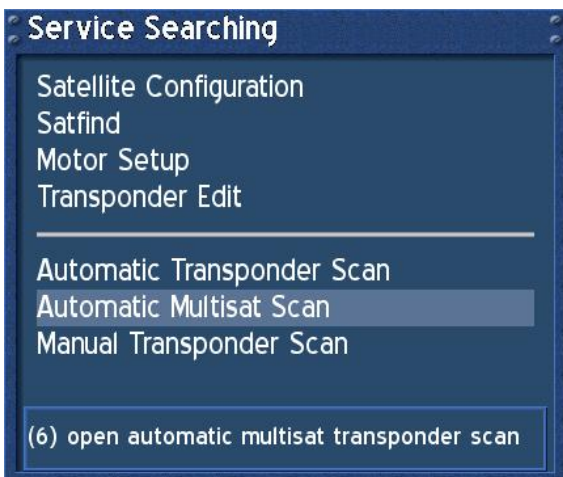

Navigate to the option “Automatic Multisat Scan” and press the **OK-Button**.

This option will scan all satellites in your satellite list without asking you if you want to scan any other satellites.

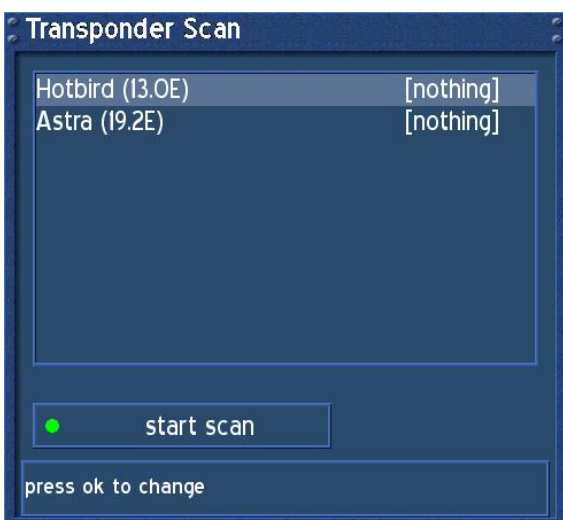

The transponder scan menu for a multisat scan will pop up.

Pressing the **OK-Button** will change the scan option of the selected satellite.

The options “nothing” means that the satellite is not scanned for any transponders.

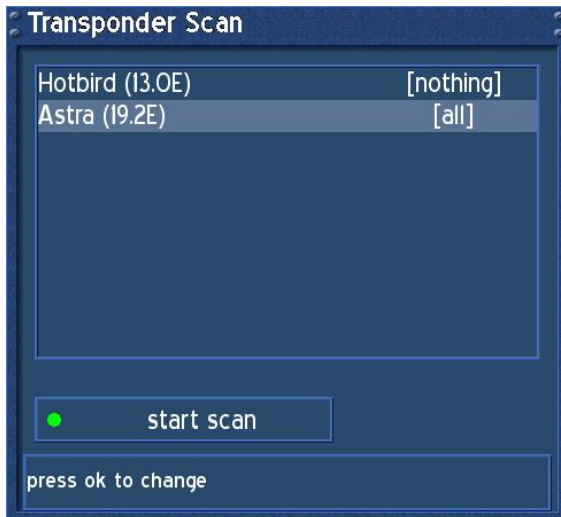

Pressing the **OK-Button** will toggle between the available scan options.

Setting the multisat scan option to “all” will scan for all available services no matter if they are free or encrypted.

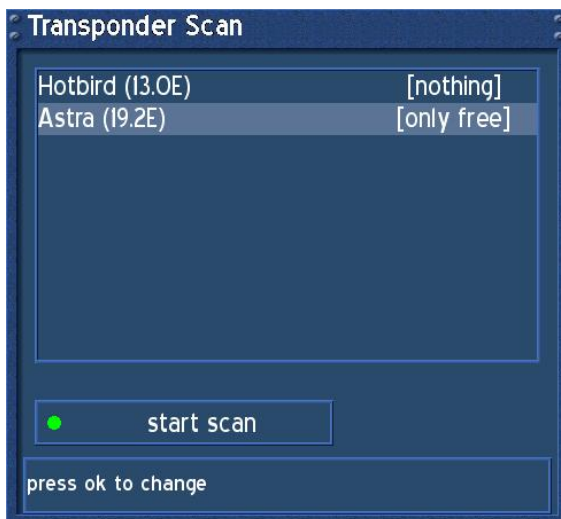

Pressing the **OK-Button** will toggle between the available scan options.

Setting the multisat scan option to “only free” will scan for all available services that are not encrypted.

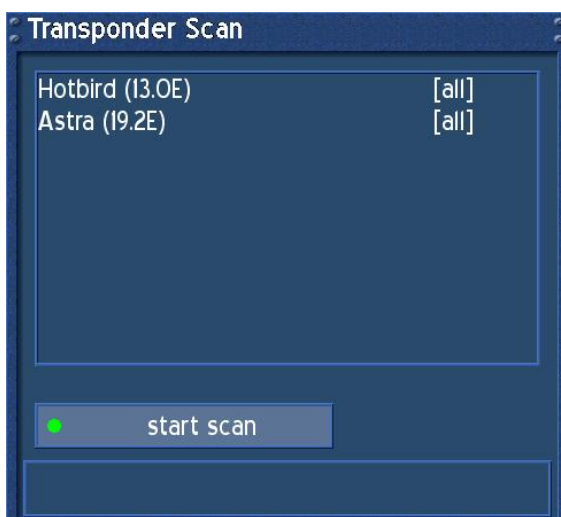

Pressing the **OK-Button** will toggle between the available scan options.

Usually the “all” option is the best choice.

Press the **green Options-Button** to start the scan.

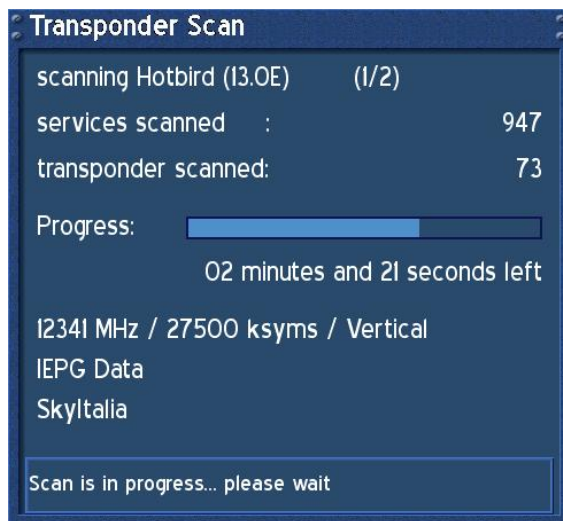

The menu for the first scanned satellite is depicted on the left.



The menu for the second scanned satellite is depicted on the left.

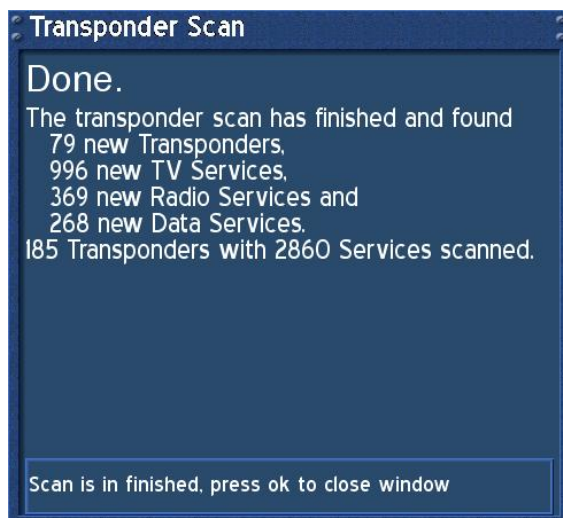

Once your Dreambox is done searching you will see this menu on the right. A brief summary of the search is shown.

Press the **OK-Button** to close this menu.

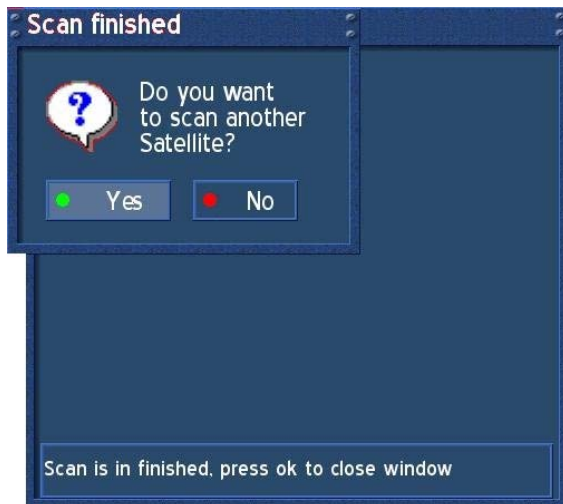

The System will now ask you, if you want to scan any other transponders.

Press the **red Options-Button** to quit the transponder scan.

You are taken back to the "Service searching" menu.

## 28. Manual transponder scan (DM 500-S)

If no OSD menu is visible on your screen, press the **Menu-Button** to open the main OSD menu. Navigate to the option "Setup" and press the **OK-Button** to select.



Navigate to the option "Service Searching" and press the **OK-Button**.



Navigate to the option "Manual Transponder Scan" and press the **OK-Button**.

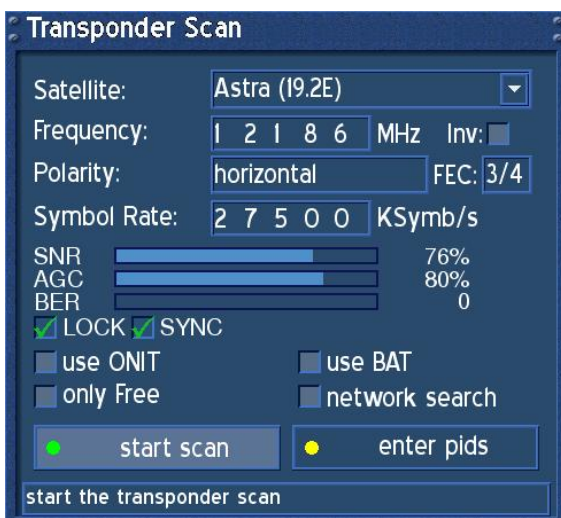

First choose the satellite you want to scan on with the **OK-Button**.

Enter the transponder frequency with the **Numeric Keypad** on your remote control.

Use the **Navigation-Buttons left and right** to switch between horizontal and vertical polarization and to change the FEC.

Enter the symbol rate with the **Numeric Keypad** on your remote control.

Press the **green Options-Button** to start the scan.



## 29. Edit a transponder (DM 500-S)

If no OSD menu is visible on your screen, press the **Menu-Button** to open the main OSD menu. Navigate to the option "Setup" and press the **OK-Button** to select.



Navigate to the option "Service Searching" and press the **OK-Button**.



Navigate to the option "Transponder Edit" and press the **OK-Button**.



This menu will let you edit the satellite and transponder lists that are used for the service scan. New transponders and satellites are usually announced in the Internet or in magazines.

Press the **red Options-Button** to delete a satellite.

Press the **green Options-Button** to add a satellite.

Press the **OK-Button** to edit a satellite entry.

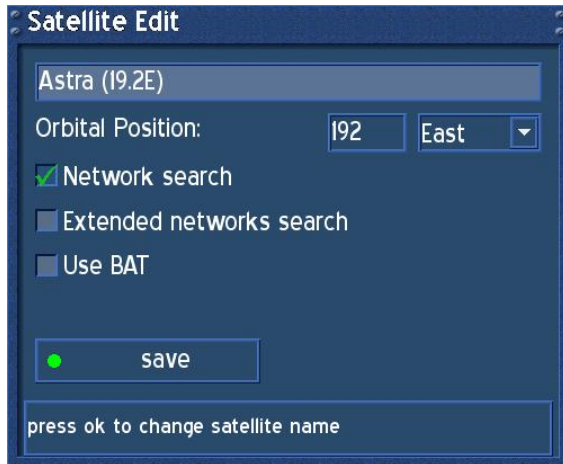

Follow the instructions in this menu. Press the **Navigation-Buttons** to reach the desired option and use the **OK-Button** to change them.

Network search:

The NIT holds the Information about the Satellites and the TV/Radio- Programs.  
(NIT = Network Information Table)

Extended network search:

Set a check to scan the NIT from other Transponders.

Use BAT:

Bouquet Tables of the Provider will be used, if available.  
(BAT = Bouquet Association Table)

Press the **green Options-Button** to save your settings.

You are taken back to the "Transponder" menu.



Navigate to the option "add" and press the **OK-Button**.



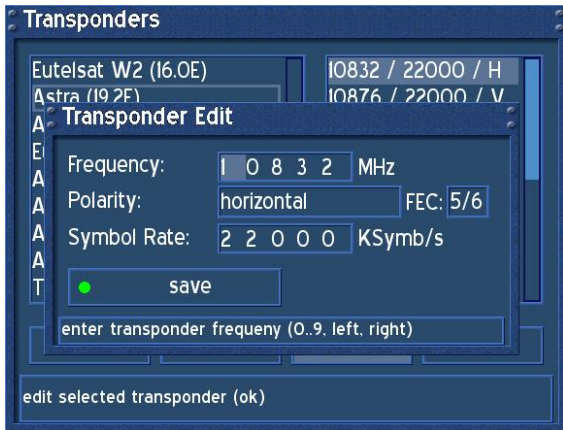

Through this menu you can a transponder to a satellite.

Using the Numeric Keypad of your remote control enter the transponder frequency and symbol rate.

Press the **green Options-Button** to save your settings.

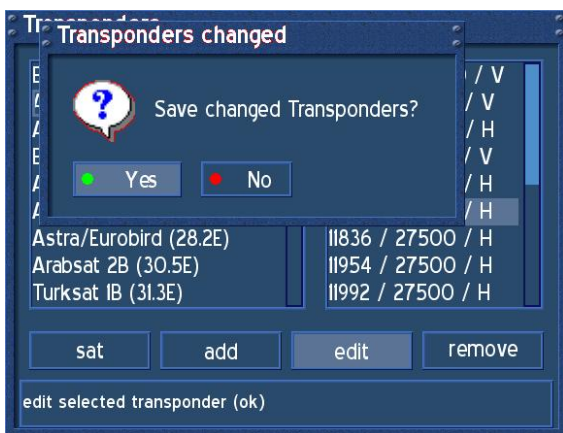

After you have made your changes to the transponder and satellite list, press the **Exit-Button** to leave the menu. You will be prompted if you want to save your changes.

Press the **green Options-Button** to save your changes.

Press the **red Options-Button** to discard your changes.

You are taken back to the "Transponder scan" menu. Start the transponder scan to find services on newly added satellites or transponders.

### 30. Service organizing – Adding a new Bouquet

If no OSD menu is visible on your screen, press the **Menu-Button** to open the main OSD menu. Navigate to the option “Setup” and press the **OK-Button** to select.



Navigate to the option “Service Organizing” and press the **OK-Button**.

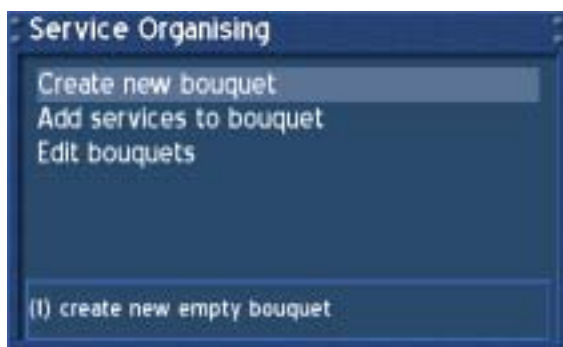

Navigate to the option “Create new bouquet” and press the **OK-Button**.

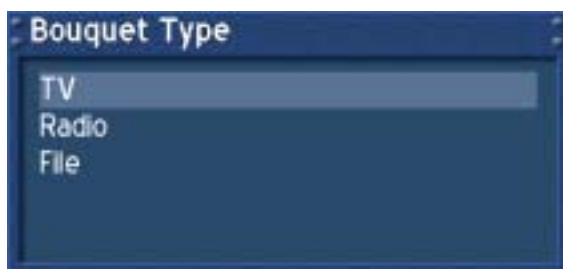

You are asked for the type of Bouquet you want to add.

In our example we add a TV Bouquet.

Press the **OK-Button**.



Using the **Numeric Keypad** on your remote control and pressing the numbers several times will let you choose the desired letters and numbers.

Pressing the **yellow Options-Button** will toggle between capital and small letters.

Pressing the **blue Options-Button** toggles between numeric and regular mode.

Pressing the **green Options-Button** adds a space.

Pressing the **red Options-Button** will act as a backspace.

Pressing the **OK-Button** will take you back to the "Service organizing" screen.

### 30.1 Service organizing – Adding services to an existing Bouquet

Please read the section **Service organizing – Adding a new Bouquet** to learn how to get into this menu.

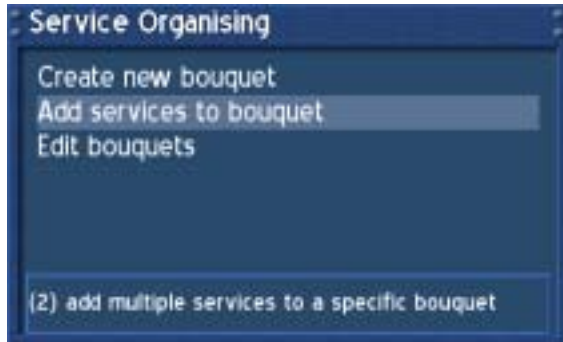

Navigate to the option “Add services to bouquet” and press the **OK-Button**.

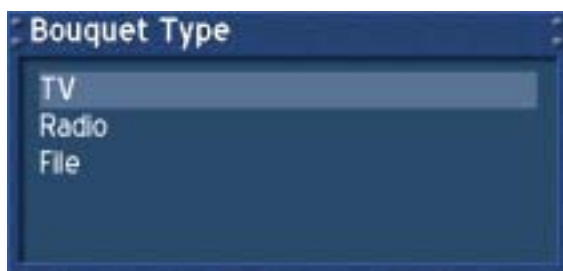

You are asked for the type of Bouquet you want to add.

In our example we add a TV Bouquet.

Press the **OK-Button**.

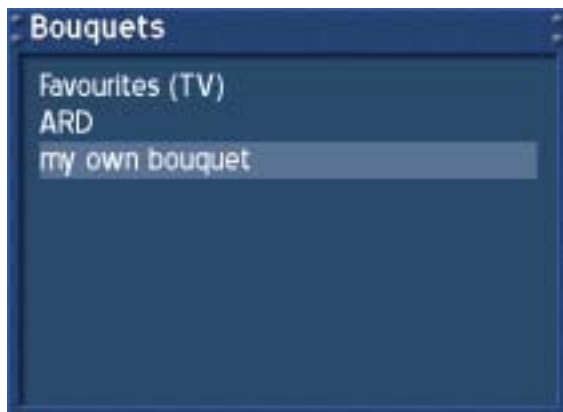

You are asked in which Bouquet to place the service.

We will use our freshly created “my new bouquet” in this example.

Press the **OK-Button**.

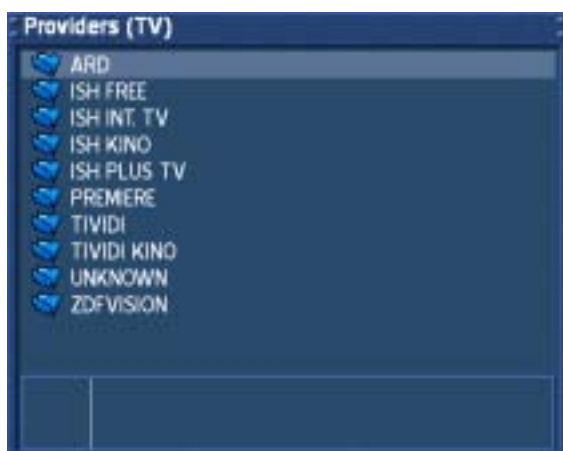

You can now choose whether to take a service from the providerlist or servicelist or the new services list.

**Note:** All services that were not found in your services list when you did an automatic transponder scan will be saved in the new services list.

We will use the providerlist in our example.

Press the **OK-Button**.

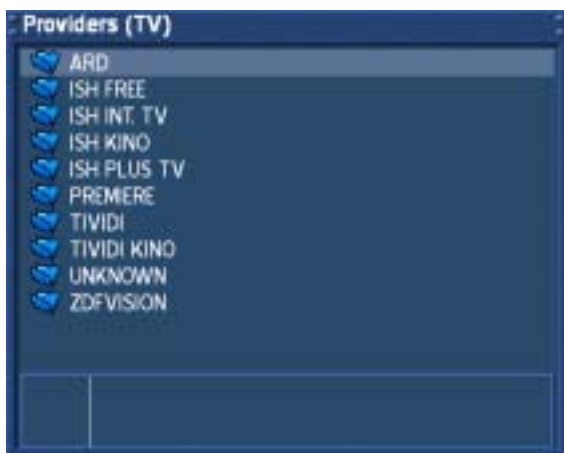

The providerlist will show up. In our example we will choose the provider "ARD".

Press the **OK-Button**.



You now see the services that are provided by "ARD".

In our example we mark the service "Phoenix" by pressing the **OK-Button**.

You can choose more than one service by selecting them and pressing the **OK-Button**. They will be highlighted in red text if selected.

Pressing the **Exit-Button** will quit your selection.

You are taken back to the "Service organizing" menu.

## 30.2 Service organizing – Editing a Bouquet

Please read the section **Service organizing – Adding a new Bouquet** to learn how to get into this menu.



Navigate to the option “Edit bouquets” and press the **OK-Button**.



In our example we will edit a TV Bouquet.

Press the **OK-Button** to edit the TV Bouquets.

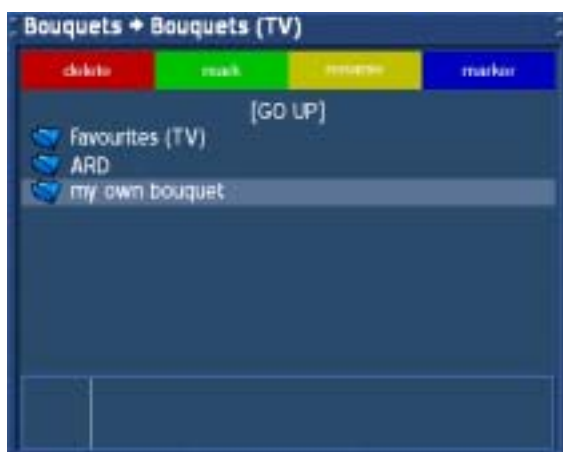

In our example we will edit our freshly created “my own bouquet” Bouquet.

Select it and press the **OK-Button**.



Pressing the **red Options-Button** will delete the service from the Bouquet.

**Attention:** This will happen without question if you really want to do it!

Pressing the **green Options-Button** will pick up the selected service and enable you to move its position in the Bouquet. Pressing the **green Options-Button** again will release the service.

Pressing the **yellow Options-Buttons** will let you rename the selected service. See section **Service organizing – Adding a new Bouquet** for details.

Pressing the **blue Options-Button** will add a marker than you can name whatever you want it to be named. See section **Service organizing – Adding a new Bouquet** for details. This allows you to divide your Bouquet list into several sections.

**The above describes procedures also apply for Radio and File Bouquets.**



### 31. Parental lock and Setup lock

If no OSD menu is visible on your screen, press the **Menu-Button** to open the main OSD menu. Navigate to the option “Setup” and press the **OK-Button** to select.



Navigate to the option “Parental lock” and press the **OK-Button**.



You can activate the parental and setup lock in this menu. It prevents anyone else from having unauthorized access to certain services, videos and MP3s. It also offers the possibility to only make certain services available to your kids.

These protection mechanisms are controlled by a four digit PIN that only is know to you.

**Attention:**

If you loose your PIN you will have to reset your Dreambox to the factory defaults in order to deactivate any locks.

### 31.1 Activating the parental lock

Please read the section **Parental lock and Setup lock** to learn how to get into this menu.



Check the checkbox in front of "Parental lock" by pressing the **OK-Button**.

The Option "Change PIN" will appear.

Navigate to the option "Change PIN" and press the **OK-Button**.

You also choose to hide all locked services from the service list by checking the checkbox in front of the "Hide locked services" option.



Enter a four digit PIN with the **Numeric Keypad** on your remote control.

**Attention:**

Entering "0000" as your PIN will deactivate any locks. Please choose a PIN that differs from "0000".



Re-enter you PIN to make sure you entered the right one.

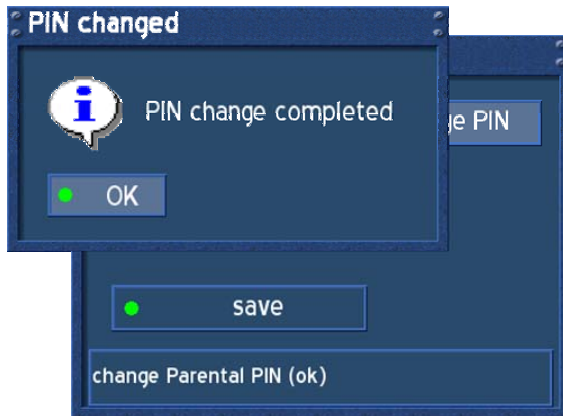

If everything went right you will be prompted that your PIN has been changed.

Press the **OK-Button**.

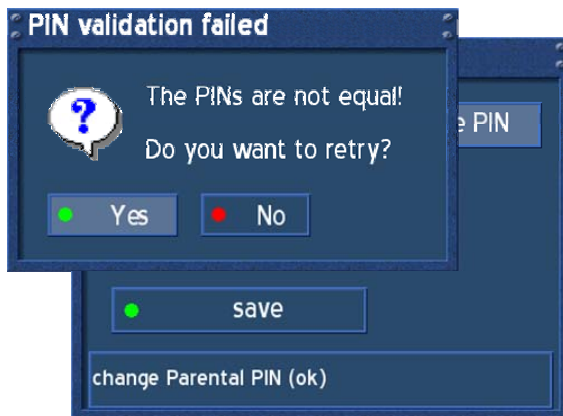

If the PIN you entered twice are not the same you will be prompted this error message.

Pressing the **green Options-Button** will let you re-enter your PIN and try again.

Pressing the **red Options-Button** will abort.

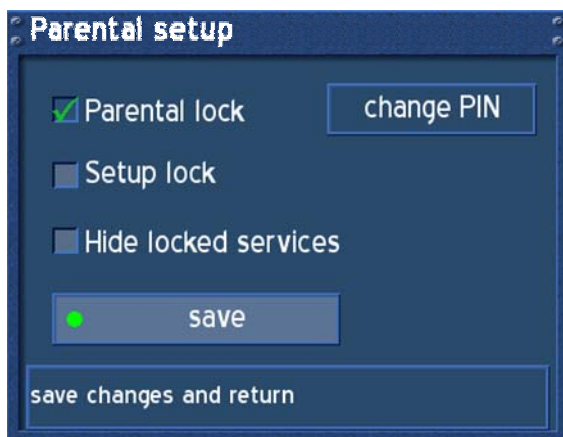

Press the **green Options-Button** to save your settings.

You will be taken back to the "Setup" menu.

## 31.2 Deactivating the parental lock

Please read the section **Parental lock and Setup lock** to learn how to get into this menu.



Uncheck the checkbox in front of "Parental lock" by pressing the **OK-Button**. You will be prompted for your current PIN.



Enter your PIN to deactivate the parental lock.



The check in front of "Parental lock" is now gone.

Press the **green Options-Button** to save your settings.

You will be taken back to the "Setup" menu.

### 31.3 Activating the setup lock

Please read the section **Parental lock and Setup lock** to learn how to get into this menu.



Check the checkbox in front of “Setup lock” by pressing the **OK-Button**.

The Option “Change PIN” will appear.

Navigate to the option “Change PIN” and press the **OK-Button**.



Enter a four digit PIN with the **Numeric Keypad** on your remote control.

**Attention:**

Entering “0000” as your PIN will deactivate any locks. Please choose a PIN that differs from “0000”.



Re-enter you PIN to make sure you entered the right one.

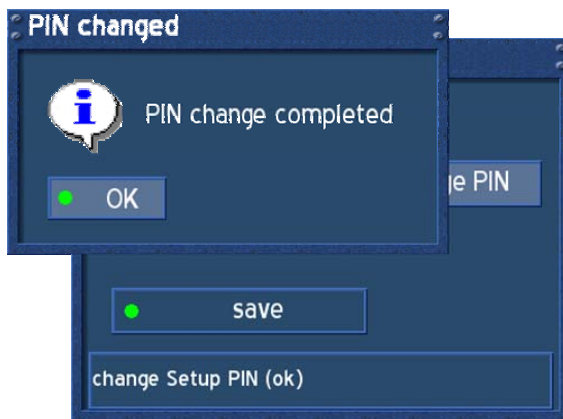

If everything went right you will be prompted that your PIN has been changed.

Press the **OK-Button**.

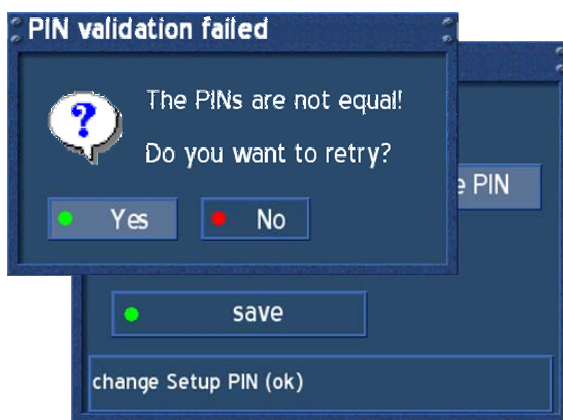

If the PIN you entered twice are not the same you will be prompted this error message.

Pressing the **green Options-Button** will let you re-enter your PIN and try again.

Pressing the **red Options-Button** will abort.

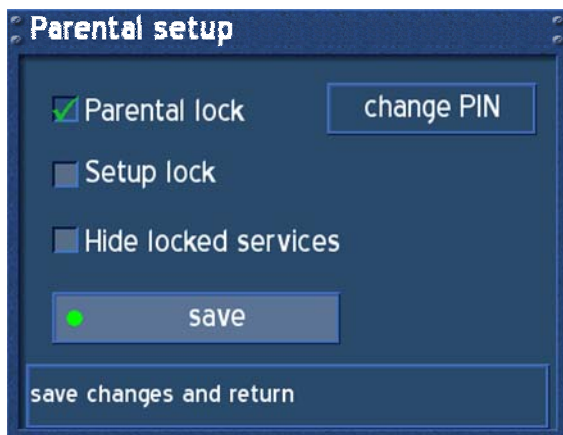

Press the **green Options-Button** to save your settings.

You will be taken back to the "Setup" menu.

### 31.4 Deactivating the setup lock

Please read the section **Parental lock and Setup lock** to learn how to get into this menu.



Uncheck the checkbox in front of "Setup lock" by pressing the **OK-Button**. You will be prompted for your current PIN.



Enter your PIN to deactivate the setup lock.

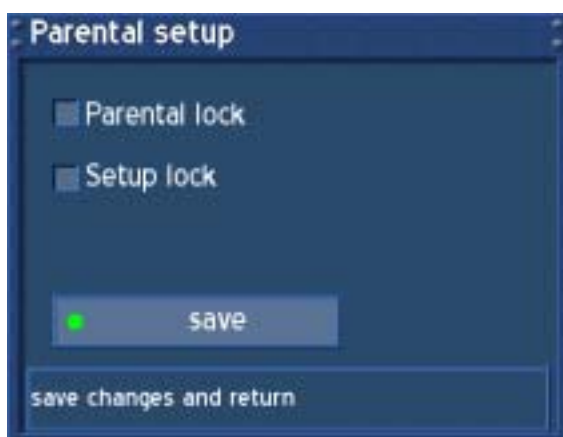

The check in front of "Setup lock" is now gone.

Press the **green Options-Button** to save your settings.

You will be taken back to the "Setup" menu.



## 32. Locking a service

Please read the section **Parental lock and Setup lock** to learn how activate the parental lock.



Press the **OK-Button** to open the service list.

Navigate to the service you want to lock and press the **Menu-Button**.

You can lock any entry of your choice in the service list. (**All services**, **Satellites**, **Providers** and **Bouquets**)

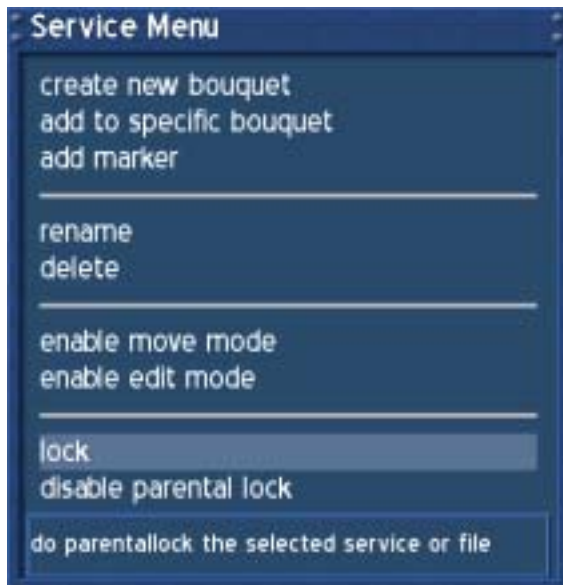

Navigate to the option "Lock" and press the **OK-Button** to lock a service.

You can also deactivate the parental lock in this menu. Navigate to the option "Parental lock" and press the **OK-Button**.

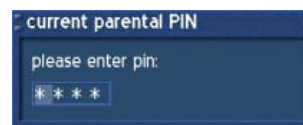

You will be prompted for your PIN.



Once you have locked a service you will see the locked symbol next to its name in the service list. You will be prompted for your PIN every time you want to access the service from now on.

### 33. Unlocking a service



Press the **OK-Button** to open the service list.

Navigate to the service you want to unlock and press the **Menu-Button**.

You can unlock any entry of your choice in the service list. (**All services**, **Satellites**, **Providers** and **Bouquets**)



Navigate to the option "Unlock" and press the **OK-Button** to unlock a service.



You will be prompted for your PIN.



Once you have unlocked a service you will see a locked symbol next to its name in the service list will disappear.

### 34. Audio/Video settings

If no OSD menu is visible on your screen, press the **Menu-Button** to open the main OSD menu. Navigate to the option "Setup" and press the **OK-Button** to select.



Navigate to the option "System" and press the **OK-Button**.



Navigate to the option "A/V settings" and press the **OK-Button**.



Use the **Navigation-Buttons left** and **right** and the **OK-Button** to change the values.

Color format:

**CVBS**(FBAS), **RGB** (Red, Green, Blue separated), **SVideo** (Color- and Brightness signal separated) and **YPbPr** (Component signal e.g. for Projectors).

Aspect ratio:

**4:3 Letterbox (Standard)**, (16:9 programs will be displayed on 4:3 TV's with black beams at top and bottom)

**4:3 Panscan** (16:9 programs will be zoomed to full high on 4:3 TV's, parts of the picture on the left and right side will cut off)

**16:9** (programs transmitted in 16:9 will be displayed automatically in 16:9, on 4:3 TV's the picture will be reduced in height)

TV System:

Choose the standard that your TV supports. **PAL; PAL + PAL60; Multinorm** and **NTSC**.

Test:

Press the **blue Options-Button** to activate the testscreen mode. Press the number 1-8 on the **Numeric Keypad** to select a testscreen. Press any other key to quit the testscreen mode.

Press the **green Options-Button** to save your settings.

You will be taken back to the "System" menu.

Disable WSS on 4:3:

Check the checkbox to disable zooming on some 16:9 TV's during 4:3 transmissions.

AC3 default output:

If a program is transmitted with an AC3 audio track (e.g. Dolby Digital), the Dreambox switches automatically to this audio track. The AC3 signal will only be available at the optical socket. The Dreambox has no built-in Dolby Digital Decoder, AC3 signals are not available on the analog socket, therefore you need an external Dolby Digital Amplifier to adjust the volume.

## 35. Keyboard

If no OSD menu is visible on your screen, press the **Menu-Button** to open the main OSD menu. Navigate to the option “Setup” and press the **OK-Button** to select.



Navigate to the option “System Settings” and press the **OK-Button**.



Navigate to the option “Keyboard Setup” and press the **OK-Button**.



Press the **OK-Button** to open the drop down menu and select your desired keyboard layout.

Press the **green Options-Button** to save your settings.

## 36. OSD settings

If no OSD menu is visible on your screen, press the **Menu-Button** to open the main OSD menu. Navigate to the option "Setup" and press the **OK-Button** to select.



Navigate to the option "System Settings" and press the **OK-Button**.



Navigate to the option "OSD settings" and press the **OK-Button**.

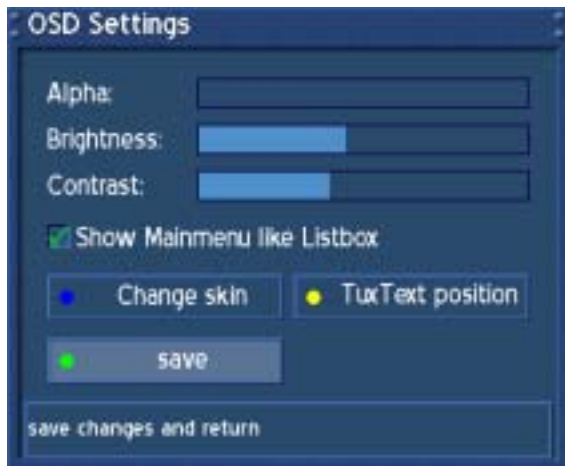

Using the **Navigation-Buttons left** and **right** you can change the transparency, brightness and contrast settings of the OSD (On Screen Display).

Alpha:

The “Alpha” option controls how strong you will see the TV picture through the OSD menu.

Brightness:

Changes the brightness of the OSD menu.

Contrast:

Changes the contrast of the OSD menu.

Show main menu as list box:

Check the checkbox if you want to view the main OSD menu like all other menus, as a list box.

Change skin:

See section **Skin Setup**

TuxText Position:

See section **Setting the Teletext position**

Press the **green Options-Button** to save your settings.

You will be taken back to the “System” menu.



## 36.1 Skin Setup

Please read the section **OSD settings** to learn how to get into this menu.



A skin changes the appearance of the OSD.

Choose the skin to your liking and press the **OK-Button** to select it.

The standard skin is Screwed Stone.

See section **Available skins** for a complete list of available skins.



To completely activate a skin Enigma has to be restarted.

Make your choice and press the **green Options-Button** to activate the skin.

Press the **red Options-Button** to discard any changes.

### 36.2 Available Skins



**Bluenigma BIG**



**Silver Metal**



**Neutrino-style**



**Screwed Stone**



**Carbon**



**BlueQT**



**Simple and Stylish**

The skin **Simple and Stylish 16:9** looks just like the **Simple and Stylish** skin. It is only optimized for a 16:9 TV screen.

### 36.3 Setting the teletext (TuxText) position

Please read the section **OSD settings** to learn how to get into this menu.

**What is TuxText?** TuxText is a Plugin (additional Software), which allows the Dreambox to decode the digital Teletext. TuxText is faster and easier to use than the regular teletext that is build in to your TV screen.

This menu is used to adjust the position of the TuxText. Maybe the clock does not appear or the text pages are not shown in the middle of the screen.

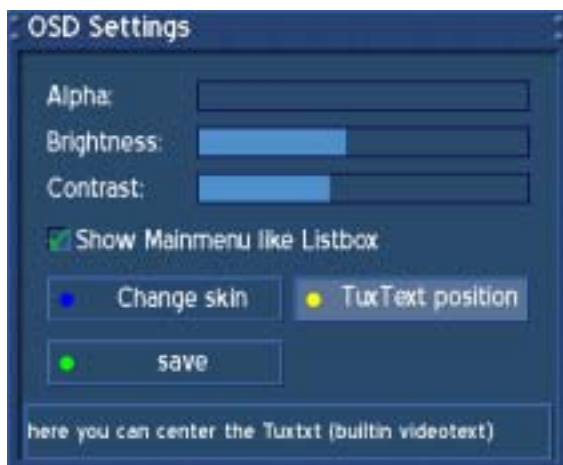

Press the yellow Options-Button to enter the TuxText position setup.

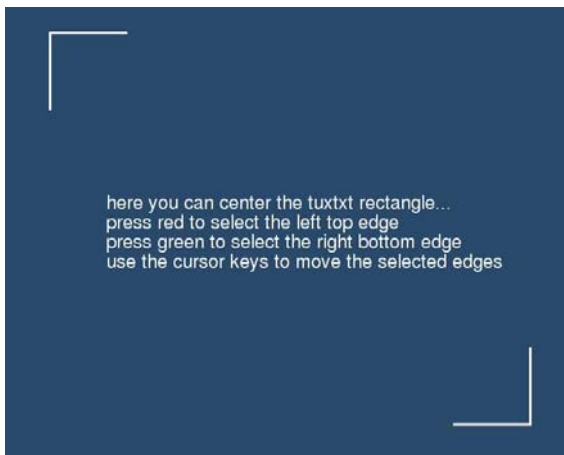

You see the blue screen as depicted on the left.

Press the **red Options-Button** to select the upper left corner.

Use the **Navigation-Buttons** to move the rectangle in the upper left corner.

Press the **green Options-Button** to select the lower right corner.

Use the **Navigation-Buttons** to move the rectangle in the lower right corner.

**Attention:**

If you don't see any rectangle, then they are out of range. Please adjust the rectangle towards the middle..

Once the positions are set press the **OK-Button** to save the settings.

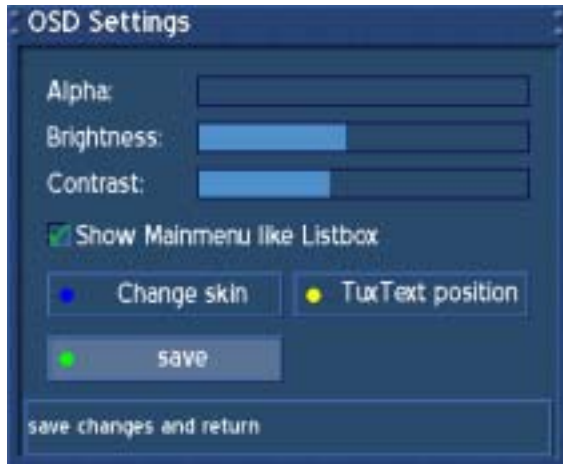

Press the **green Options-Button** to save your settings.

You will be taken back to the "System" menu.

### 37. Teletext (TuxText)

**What is TuxText?** TuxText is a Plugin (additional Software), which allows the Dreambox to decode the digital Teletext. TuxText is faster and easier to use than the regular teletext that is build in to your TV screen.

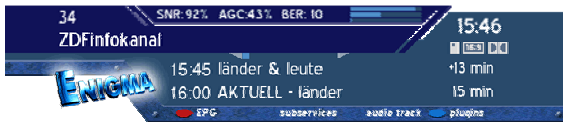

You are in the TV or Radio mode.  
Press the **TEXT-Button** to activate the Teletext.

Keep in mind that not every station submits teletext!

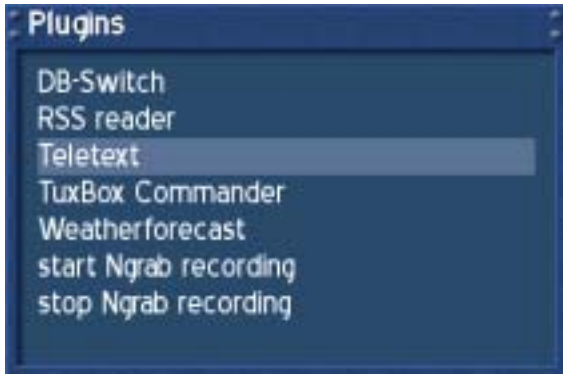

Alternative: Press the **blue Options-Button** to enter the Plugins menu.

You will see the menu depicted on the left.

Navigate to the option "Teletext" and press the **OK-Button**.

TuxText navigation:

Press the **OK-Button** to enter the interactive mode. Use the Navigation-Buttons to select a text page and press the **OK-Button** to call this site. You don't need to type in a Text page number in this mode, but it is still possible.

Press the **EXIT-Button** to exit.

Press the **Mute-Button** a couple of times to toggle between alpha-mode, invisible-mode and full mode. The alpha-mode shows the picture from the running program through the Text pages. The invisible-mode shows the complete picture from the running program without exiting the TuxText. The full-mode brings back the text page.

Press the **Volume-up-Button** to toggle between double high from the upper half, double high from the lower half and full view Text page.

Press the **Volume-down-Button** to activate or deactivate the PIG-Mode (Picture in Graphics). Same view from Text page and Program picture. (best results are show on 16:9 TV's during 4:3 transmission).

TuxText configuration menu:

If teletext page 100 is shown you can press the **MENU-Button** to enter the configuration menu of the TuxText.

You have the following options:Teletext - Selection:

Use the **Navigation-Button left** or **right** to choose another teletext provider from the current transponder and press the **OK-Button** to view.

This option is only available if there is more than one station on the current provider that transmit teletext.

Aspect ratio:**16:9 im Standard-Modus = ein/aus (16:9 during Standard-Mode = enable/disable)**

Enabling this shows the TuxText in 16:9 Aspect Ratio. Press the **OK-Button** to enable or disable this option. The default setting is disabled.

**16:9 im TextBild-Modus = ein/aus (16:9 during TextPicture-Mode = enable/disable)**

Enabling this, switches the TV to 16:9 Aspect Ratio if the PIG-Mode is activated with the **Volume-down-Button**. Press the **OK-Button** to enable or disable this option. The default setting is disabled.

**Note:**

On some older 4:3 TV's these Modes may not work. If enabled, it could happen, that your TV switches away from the VCR or A/V socket. The reason is a technical problem. The Switch signal on the Scart connector is at PIN 8 using 12 Volts. Using a 16:9 Aspect Ratio switches the PIN 8 to 6 Volts, which some older 4:3 TV's can not handle. If you are using a 4:3 TV, we suggest not to enable these modes.

Brightness:

Here you can adjust the brightness of your Teletext. Press the **Navigation-Buttons left** or **right** to adjust the brightness.

Alpha:

Here you can adjust the alpha value of your Teletext. Press the **Navigation-Buttons left** or **right** to adjust the alpha value.

National codepage:**automatische Erkennung = ein/aus (automatic detection = enable/disable)**

The national codepage detection is used to display the teletextpages with the right letters for your location. Press the **OK-Button** to enable or disable this option. The default setting is enabled. If disabled, use the **Navigation-Buttons left** or **right**, to choose your codepage.

Additional information can be found at [www.tuxtxt.net](http://www.tuxtxt.net)

## 38. Expert setup

If no OSD menu is visible on your screen, press the **Menu-Button** to open the main OSD menu. Navigate to the option "Setup" and press the **OK-Button** to select.



Navigate to the option "Expert Setup" and press the **OK-Button**.



### Serviceselector help buttons:

Press the **OK-Button** to turn the colored help buttons off. The default setting is enabled.

### Show Sat position:

Putting a check behind this option by pressing the **OK-Button** will show the sat position of the current station in the Infobar.

### Enable Fast zapping:

Pressing the **OK-Button** will remove the check behind this option. Switching stations will be a few nano seconds slower.

### Skip confirmations:

Press the **OK-Button** to put a check behind this option. No more confirmation windows will be shown. Be careful with this option. The System does not ask anymore, if you would like to see the recorded movie after stopping recording nor if you would like to really delete a movie. The default setting is disabled.





Hide error windows:

If enabled no more error messages, i.e.: service not found, will be shown.

Automatically show Infobar:

If enabled the Infobar will be shown every time a new show starts.

Show remaining Time:

If enabled the remaining time rather than the total time of the running show will be displayed in the Infobar.

Use http authentication:

If disabled you will no more need a username and password to access the web interface of your Dreambox.

Do not open serial interface:

If enabled no more debug messages will be send from Enigma to the serial interface.

Auto bouquet change:

If enabled your Dreambox will automatically jump to the next Bouquet once you have reached the last entry in a Bouquet.

Disable teletext caching:

If enabled no more background caching of teletext pages will happen.

Enable Zapping History:

If enabled you are able to switch to a different service type in the file mode.

Press the **Exit-Button** to quit this menu.

### 38.1 Communication setup (Setting up LAN, NFS shares)

Please read the section **Expert setup** to learn how to get into this menu.

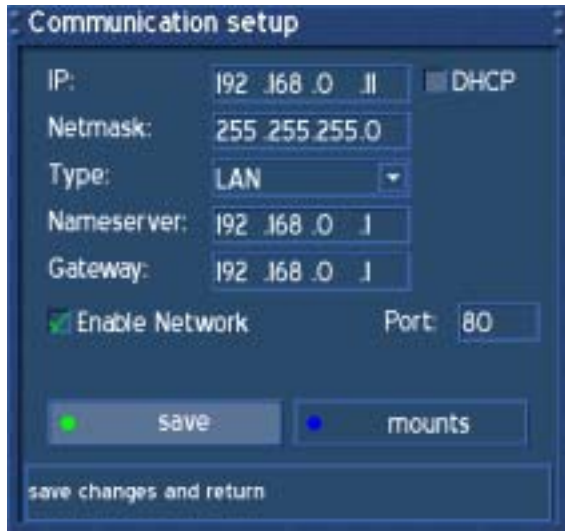

Navigate to the option "Communication setup" and press the **OK-Button**.

**Attention:**

If you are using a DHCP server in your LAN, configure the DHCP server so it does not assign the IP address used by the Dreambox. Otherwise an IP address collision is possible. Refer to the DHCP server's manual about how to configure a DHCP address pool.

Port:

Enter a port number of your choice to configure the HTTP port for the Dreambox's web interface. The default port is 80.

If the default port is set you can simply enter <http://ip-of-your-box> into the address bar of your browser to access the web interface. Otherwise you have to enter <http://ip-of-your-box:portnumber>

Use the **Navigation-Buttons** and the **Numeric Keypad** to enter or change the values.

IP:

Enter the IP address here.

DHCP:

If enabled your Dreambox will get its IP from a DHCP server. Disable this option to set a static IP address.

Netmask:

Enter the subnet mask (Usually 255.255.255.0).

Type:

**LAN** (Local Area Network); Connection to the home Network. The default setting is LAN.

**WAN/PPPoE** (Wide Area Network) / (Point-to-Point Protocol over Ethernet); Direct Connection to the Internet, (e.g. DSL Modem directly connected to the Dreambox). Please proceed to next passage for WAN settings

Nameserver:

Enter the DNS-Server's IP address here. DNS is used to translate a Domain name to an IP address.

Normally, if the Type is set to LAN, there is no need for a DNS entry. If the Dreambox is connected to the Internet over a router, enter the router's IP address Here.

Gateway:

Enter the router's IP address here, if the Dreambox is connected to the Internet over a router.

Activate network:

Setting a check enables the network. The default setting is disabled.

Press the **green Options-Button** to save your settings.



Checking the checkbox in front of the option "Automount" will automatically mount the selected NFS share at the next boot of your Dreambox.

Press the **green Options-Button** to test the mount. You will get a system message if it was successful or not.

Press the **yellow Options-Button** to save you settings.

Press the **red Options-Button** to unmount the selected NFS share.

Navigate between the 8 possible shares by using the **Navigation-Buttons left or right**.

Pressing the blue Options-Button in the "Communication setup" menu will take you to the "Mount Manager" menu. You can setup up to eight different configurations to connect your Dreambox to shared folders on your PC. Right now only NFS sharing is supported.

IP:  
IP address of the NFS server you want to access.

NFS:  
Right now only the option NFS is available. Once more share types are supported you can select the type in this drop down menu.

Dir:  
Enter the name of the NFS share on the NFS server that you want to access.

LocalDir:  
The default setting is /mnt and does not need to be changed unless you want to add more than one share. Adding more than one share requires you to create several sub directories via telnet on your Dreambox. The suggestion is to create /varmnt1 to /var/mnt8

Options:  
Either choose the option "rw" to have read and write access or choose the option "ro" to have read-only access to the NFS share.

Extra:  
You can add additional mount parameters here. You have to know what you are doing otherwise leave this setting alone.

## 38.2 NGrab - Streaming Setup

Please read the section **Expert setup** to learn how to get into this menu.

In this menu you can set the IP address and port number of the NGrab server. The server can be running on any workstation or server in the LAN or WAN.



Navigate to the option “NGrab-Streaming” and press the **OK-Button**.



Srv IP:  
Enter the IP address of the server or workstation running the NGrab software.

Srv Port:  
Enter the port number of the server or workstation running the NGrab software.

Srv MAC:  
The MAC address of the NGrab server will show once you have it running and press the **blue Options-Button**.

The MAC address is needed for the WOL (Wake On LAN) function of the server. The server needs to fully support APM (Advanced Power Management) and WOL to use this function.

Press the **green Options-Button** to save your settings.

You will be taken to the “Expert setup” menu.

### 38.3 Manual software update

Please read the section **Expert setup** to learn how to get into this menu.

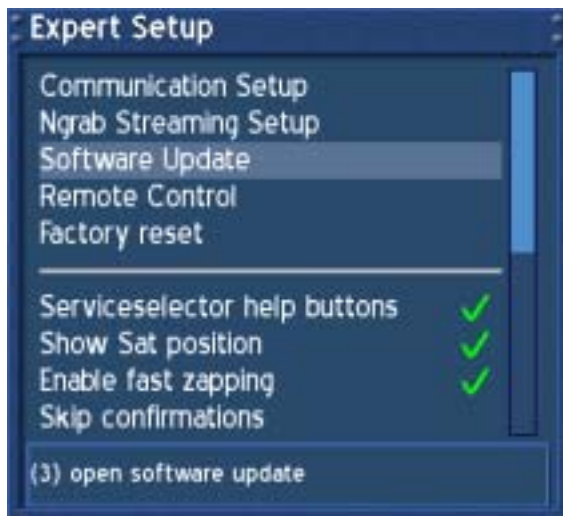

Navigate to the option "Software update" and press the **OK-Button**.



Navigate to the option "Manual update" and press the **OK-Button**.

Requirements for the manual update:

You have set an IP address and subnet mask in the "Communication setup" menu.

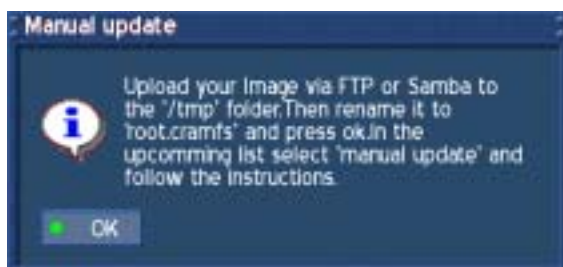

Follow the instructions on your screen.

Press the **green Options-Button** to start the update.

Follow the instructions on your screen.

## 38.4 Remote control setup

Please read the section **Expert setup** to learn how to get into this menu.



Navigate to the option "Remote control" and press the **OK-Button**.

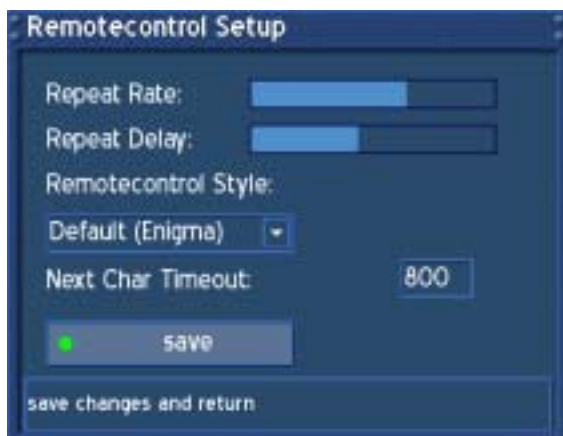

This Menu is used to customize the remote control for your needs.

Use the **Navigation-Buttons left** or **right** to adjust the Repeat Rate and the Repeat Delay.

Press the **green Options-Button** to save your settings.

You will be taken back to the "Expert" menu.



## 38.5 Reset to factory defaults

Please read the section **Expert setup** to learn how to get into this menu.



Navigate to the option "Remote control" and press the **OK-Button**.



Follow the instructions on the screen and pick your choice.

## 39. Timer

If no OSD menu is visible on your screen, press the **Menu-Button** to open the main OSD menu. Navigate to the option "Timer" and press the **OK-Button** to select.

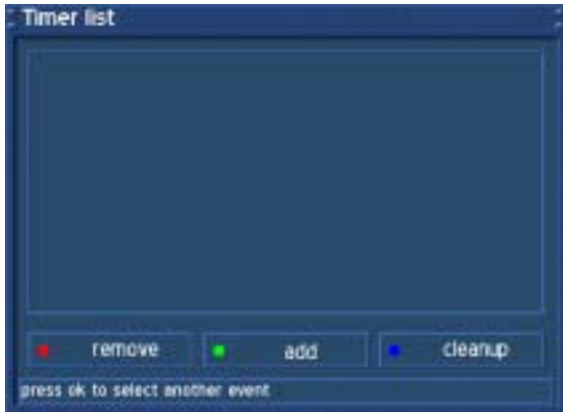

This is the timer list.

You can see a timer event that has been entered as an example.

A green checkmark in front of the timer event means that it has been successfully executed.

A red cross in front of the timer event means that it has been aborted or not executed at all.

Sleeptimer events are also shown in this list and can be edited or deleted here.

Press the blue Options-Button to clean up the timer list.

We suggest only adding timer events through the EPG. This timer list is mainly meant for management purposes.

#### 40. Information - Streaminformation

If no OSD menu is visible on your screen, press the **Menu-Button** to open the main OSD menu. Navigate to the option "Information" and press the **OK-Button** to select.



Navigate to the option "Stream information" and press the **OK-Button**.

Use the **Navigation-Buttons left and right** to switch between the three windows.

Pressing the **Exit-Button** will close this window.



This window shows detailed technical data about the current service.



This window shows information about the used and/or supported encryption types.

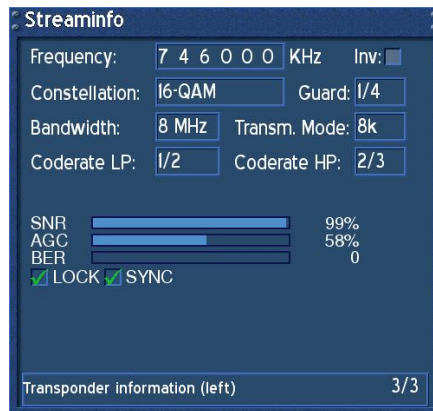
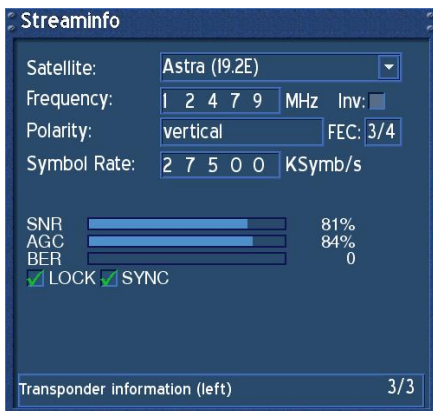

This window shows the additional technical data of the current service. The left picture shows the DM 500-S, the middle one the DM 500-T and the right one the DM 500-C

## 41. Information - About

Please read the section **Information – Streaminformation** to learn how to get into this menu.

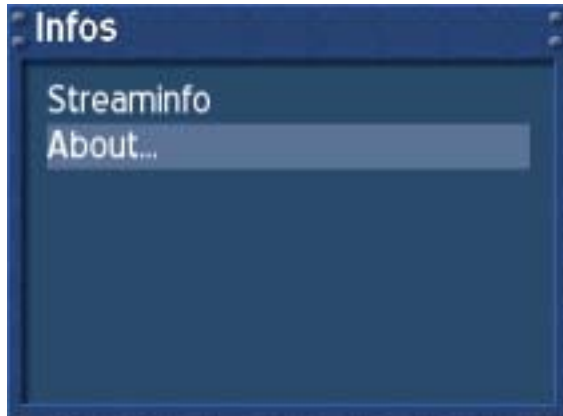

Navigate to the option "About..." and press the **OK-Button**.



This window summarizes all relevant information about the system.

Press the **green Options-Button** to close the window.

The Information „Tuner:“ depends on the type of your Dreambox DM 500:

- DM 500-S: Satellite
- DM 500-C: Cable
- DM 500-T: Terrestrial

## 42. Technical data

- 250 MHz IBM PowerPC Processor (350 MIPS)
- Linux Operating System, Open Source
- DreamCrypt CA integrated
- 1 x Smartcard-Reader
- MPEG2 Hardware decoding (DVB compliant)
- V.24 / RS232 connector
- 100Mbit voll duplex Ethernet Interface
- 2 Status-LED
- 32 MByte RAM
- Unlimited service list for TV/Radio
- Switching services in less than a second
- Fully automated service seraching / transponder scan
- Bouquet list support
- EPG-Support (electronic program guide)
- Multi language OSD with skin support
- SPDI/F optical connector AC-3
- 1 x Scart-Connector (comepletely software controlled)
- external 12V power converter
- A/V Output (Audio/Video Cinch)
- Size: 196mm x 130mm x 40mm (H x B x T)

### Video decoder:

Video Compression MPEG-2 and MPEG-1 compatible

Video Standard PAL G/ 25 Hz

Video Formats 4:3 / 16:9

Footage 16:9, automatic assimilation for 16:9 TV-Device (over Scart)

Letterbox percolating for 4:3 TV-Device

### Audio decoder:

Audio compression MPEG-1 & MPEG-2 Layer I and II

Audio Mode Dual (main/sub), Stereo

Frequency: 32 kHz, 44.1 kHz, 48 kHz, 16 kHz, 22.05 kHz, 24 kHz

### Output analog:

Output Level L/R 0,5 Vss on 600 Ohm

THD > 60 dB (1 kHz)

Crosstalk < -65 dB

### Output digital:

Output Level 0,5 Vss on 75 Ohm

Sampled Data Filtering 32 kHz, 44.1 kHz, 48 kHz

S/PDIF-Output optical (AC3)

### Output Video:

Output Level FBAS 1 Vss +/- 0.3 dB on 75 Ohm

### TV-Scart:

Output: FBAS,RGB,S-VHS over OSD selectable

### Serial Interface RS 232:

Typ RS232 bidirectional

Bitrate 115,2 kBit/s max.

Plug Connector SUB-D-9

Function Update of Firmware and Preprogramming

**Ethernet:**

100 Mbit compatible, bi-directional interface Function  
Update of Firmware and Preprogramming

**Input voltage:**

12V power converter 110-230V / 50-60Hz AC +/- 15%

**Physical specification:**

Ambient Temperature +15°C...+35°C

Humidity < 80%

Size (B x T x H): 196 mm x 130 mm x 40 mm

Weight: 500g

**DM 500-C/T specific data:****DVB-C/T Tuner:**

Frequency Range 51 .... 858 MHz

Input Impedance 75 Ohm

Symbolrate 1 .... 6.9 Mbaud/s

**DM 500-S specific data:****DVB-S-Tuner:**

Frequency Range 950 - 2150 MHz

Signal Level - 65 dBm - 25 dBm

Signal-to-Noise Level 12 dB max.

DBS-Tuner Input Connector F-Type female

Input Impedance 75 Ohm

AFC +/- 3 MHz

Demodulation Shaped QPSK

Symbolrate 2 - 45 Mbaud/s, SCPC / MCPC

Inner FEC: Rates:1/2, 2/3, 3/4, 5/6, 7/8 (DVB specification)

Demultiplexing according to ISO 13818-1

**LNB power supply:**

LNB Strom 500mA max. ; kurzschlussfest

LNB Spannung vertikal < 14V ohne Last, > 11,5V bei 400mA

LNB Spannung horizontal < 20V ohne Last, > 17,3V bei 400mA

LNB Abschaltung im Standby-Mode

**Anzahl aktiver Satellitenpositionen:**

DiSEqC 1.0/1.2 SAT POSITION / SAT OPTION

DiSEqC - Rotor-Steuerung

## 43. Contact & support information

### Headquarter & Distribution:

Dream-Multimedia  
Sales and distribution through Visoduck Discount GmbH  
Pierbusch 24-26  
44536 Lünen  
Germany

### Dealer's Hotline:

(Dealers only)

Tel.: +49 (0)180 - 368 43 98 - 000 (0,09€/min.)

Fax: +49 (0)180 - 368 43 98 - 001 (0,09€/min.)

You can reach the dealer's hotline from :

Mo - Fr. 09:00 am - 12:00 pm and 01:00 pm - 03:00 pm

### Technical Hotline:

Tel.: +49 (0)180 - 368 43 99 - 777 (0,09€/min.)

Fax: +49 (0)180 - 368 43 99 - 778 (0,09€/min.)

You can reach the technical hotline from:

Mo - Fr. 09:00 am - 12:00 pm and 01:00 pm - 03:00 pm

---

### Dealers & Pricing:

E-Mail: [info@dream-multimedia-tv.de](mailto:info@dream-multimedia-tv.de)

### Technical Support:

E-Mail: [support@dream-multimedia-tv.de](mailto:support@dream-multimedia-tv.de)

### Website:

Weblink: <http://www.dream-multimedia-tv.de>

### Support Forum:

Weblink: <http://www.dream-multimedia-tv.de/board>

### Software Support (actual images):

Weblink DM500: <http://www.dm500.de>

---



44. Warranty card



## Warranty Card

Model Type: .....

Serial. - No.: .....

MAC - No.: .....

(Serial and MAC-No. is located at the back of your Dreambox)

**Customer Address:**

Name: .....

Street:.....

Country: .....

Postcode: ..... City: .....

**Reseller Address:**

Name: .....

Street:.....

Country: .....

Postcode: ..... City:.....

Stamp: ..... Date of purchase: .....

## 45. Copyright Notes

© Dream-Multimedia 2006. All rights reserved.

This product contains files that are distributed under different licenses, especially a Open Source License, the GNU General Public License. You can find details about this

License on the next three pages. Additional notes about the source code and patches under

The GPL license can be found on the internet under this link:

<http://www.dream-multimedia-tv.de/deutsch/downloads.php>

## **46. GNU GENERAL PUBLIC LICENSE**

Version 2, June 1991

Copyright (C) 1989, 1991 Free Software Foundation, Inc.  
51 Franklin Street, Fifth Floor, Boston, MA 02110-1301, USA

Everyone is permitted to copy and distribute verbatim copies of this license document, but changing it is not allowed.

### **Preamble**

The licenses for most software are designed to take away your freedom to share and change it. By contrast, the GNU General Public License is intended to guarantee your freedom to share and change free software--to make sure the software is free for all its users. This General Public License applies to most of the Free Software Foundation's software and to any other program whose authors commit to using it. (Some other Free Software Foundation software is covered by the GNU Lesser General Public License instead.) You can apply it to your programs, too.

When we speak of free software, we are referring to freedom, not price. Our General Public Licenses are designed to make sure that you have the freedom to distribute copies of free software (and charge for this service if you wish), that you receive source code or can get it if you want it, that you can change the software or use pieces of it in new free programs; and that you know you can do these things.

To protect your rights, we need to make restrictions that forbid anyone to deny you these rights or to ask you to surrender the rights. These restrictions translate to certain responsibilities for you if you distribute copies of the software, or if you modify it.

For example, if you distribute copies of such a program, whether gratis or for a fee, you must give the recipients all the rights that you have. You must make sure that they, too, receive or can get the source code. And you must show them these terms so they know their rights.

We protect your rights with two steps: (1) copyright the software, and (2) offer you this license which gives you legal permission to copy, distribute and/or modify the software.

Also, for each author's protection and ours, we want to make certain that everyone understands that there is no warranty for this free software. If the software is modified by someone else and passed on, we want its recipients to know that what they have is not the original, so that any problems introduced by others will not reflect on the original authors' reputations.

Finally, any free program is threatened constantly by software patents. We wish to avoid the danger that redistributors of a free program will individually obtain patent licenses, in effect making the program proprietary. To prevent this, we have made it clear that any patent must be licensed for everyone's free use or not licensed at all.

The precise terms and conditions for copying, distribution and modification follow.

### **TERMS AND CONDITIONS FOR COPYING, DISTRIBUTION AND MODIFICATION**

**0.** This License applies to any program or other work which contains a notice placed by the copyright holder saying it may be distributed under the terms of this General Public License. The "Program", below, refers to any such program or work, and a "work based on the Program" means either the Program or any derivative work under copyright law: that is to say, a work containing the Program or a portion of it, either verbatim or with modifications and/or translated into another language. (Hereinafter, translation is included without limitation in the term "modification".) Each licensee is addressed as "you".

Activities other than copying, distribution and modification are not covered by this License; they are outside its scope. The act of running the Program is not restricted, and the output from the Program is covered only if its contents constitute a work based on the Program (independent of having been made by running the Program). Whether that is true depends on what the Program does.

**1.** You may copy and distribute verbatim copies of the Program's source code as you receive it, in any medium, provided that you conspicuously and appropriately publish on each copy an appropriate copyright notice and disclaimer of warranty; keep intact all the notices that refer to this License and to the absence of any warranty; and give any other recipients of the Program a copy of this License along with the Program.

You may charge a fee for the physical act of transferring a copy, and you may at your option offer warranty protection in exchange for a fee.

**2.** You may modify your copy or copies of the Program or any portion of it, thus forming a work based on the Program, and copy and distribute such modifications or work under the terms of Section 1 above, provided that you also meet all of these conditions:

- a)** You must cause the modified files to carry prominent notices stating that you changed the files and the date of any change.
- b)** You must cause any work that you distribute or publish, that in whole or in part contains or is derived from the Program or any part thereof, to be licensed as a whole at no charge to all third parties under the terms of this License.
- c)** If the modified program normally reads commands interactively when run, you must cause it, when started running for such interactive use in the most ordinary way, to print or display an announcement including an appropriate copyright notice and a notice that there is no warranty (or else, saying that you provide a warranty) and that users may redistribute the program under these conditions, and telling the user how to view a copy of this License. (Exception: if the Program itself is interactive but does not normally print such an announcement, your work based on the Program is not required to print an announcement.)

These requirements apply to the modified work as a whole. If identifiable sections of that work are not derived from the Program, and can be reasonably considered independent and separate works in themselves, then this License, and its terms, do not apply to those sections when you distribute them as separate works. But when you distribute the same sections as part of a whole which is a work based on the Program, the distribution of the whole must be on the terms of this License, whose permissions for other licensees extend to the entire whole, and thus to each and every part regardless of who wrote it.

Thus, it is not the intent of this section to claim rights or contest your rights to work written entirely by you; rather, the intent is to exercise the right to control the distribution of derivative or collective works based on the Program.

In addition, mere aggregation of another work not based on the Program with the Program (or with a work based on the Program) on a volume of a storage or distribution medium does not bring the other work under the scope of this License.

**3.** You may copy and distribute the Program (or a work based on it, under Section 2) in object code or executable form under the terms of Sections 1 and 2 above provided that you also do one of the following:

- a)** Accompany it with the complete corresponding machine-readable source code, which must be distributed under the terms of Sections 1 and 2 above on a medium customarily used for software interchange; or,
- b)** Accompany it with a written offer, valid for at least three years, to give any third party, for a charge no more than your cost of physically performing source distribution, a complete machine-readable copy of the corresponding source code, to be distributed under the terms of Sections 1 and 2 above on a medium customarily used for software interchange; or,
- c)** Accompany it with the information you received as to the offer to distribute corresponding source code. (This alternative is allowed only for non commercial distribution and only if you received the program in object code or executable form with such an offer, in accord with Subsection b above.)

The source code for a work means the preferred form of the work for making modifications to it. For an executable work, complete source code means all the source code for all modules it contains, plus any associated interface definition files, plus the scripts used to control compilation and installation of the executable. However, as a special exception, the source code distributed need not include anything that is normally distributed (in either source or binary form) with the major components (compiler, kernel, and so on) of the operating system on which the executable runs, unless that component itself accompanies the executable.

If distribution of executable or object code is made by offering access to copy from a designated place, then offering equivalent access to copy the source code from the same place counts as distribution of the source code, even though third parties are not compelled to copy the source along with the object code.

**4.** You may not copy, modify, sublicense, or distribute the Program except as expressly provided under this License. Any attempt otherwise to copy, modify, sublicense or distribute the Program is void, and will automatically terminate your rights under this License. However, parties who have received copies, or rights, from you under this License will not have their licenses terminated so long as such parties remain in full compliance.

**5.** You are not required to accept this License, since you have not signed it. However, nothing else grants you permission to modify or distribute the Program or its derivative works. These actions are prohibited by law if you do not accept this License. Therefore, by modifying or distributing the Program (or any work based on the Program), you indicate your acceptance of this License to do so, and all its terms and conditions for copying, distributing or modifying the Program or works based on it.

**6.** Each time you redistribute the Program (or any work based on the Program), the recipient automatically receives a license from the original licensor to copy, distribute or modify the Program subject to these terms and conditions. You may not impose any further restrictions on the recipients' exercise of the rights granted herein. You are not responsible for enforcing compliance by third parties to this License.

**7.** If, as a consequence of a court judgment or allegation of patent infringement or for any other reason (not limited to patent issues), conditions are imposed on you (whether by court order, agreement or otherwise) that contradict the conditions of this License, they do not excuse you from the conditions of this License. If you cannot distribute so as to satisfy simultaneously your obligations under this License and any other pertinent obligations, then as a consequence you may not distribute the Program at all. For example, if a patent license would not permit royalty-free redistribution of the Program by all those who receive copies directly or indirectly through you, then the only way you could satisfy both it and this License would be to refrain entirely from distribution of the Program.

If any portion of this section is held invalid or unenforceable under any particular circumstance, the balance of the section is intended to apply and the section as a whole is intended to apply in other circumstances.

It is not the purpose of this section to induce you to infringe any patents or other property right claims or to contest validity of any such claims; this section has the sole purpose of protecting the integrity of the free software distribution system, which is implemented by public license practices. Many people have made generous contributions to the wide range of software distributed through that system in reliance on consistent application of that system; it is up to the author/donor to decide if he or she is willing to distribute software through any other system and a licensee cannot impose that choice.

This section is intended to make thoroughly clear what is believed to be a consequence of the rest of this License.

**8.** If the distribution and/or use of the Program is restricted in certain countries either by patents or by copyrighted interfaces, the original copyright holder who places the Program under this License may add an explicit geographical distribution limitation excluding those countries, so that distribution is permitted only in or among countries not thus excluded. In such case, this License incorporates the limitation as if written in the body of this License.

**9.** The Free Software Foundation may publish revised and/or new versions of the General Public License from time to time. Such new versions will be similar in spirit to the present version, but may differ in detail to address new problems or concerns.

Each version is given a distinguishing version number. If the Program specifies a version number of this License which applies to it and "any later version", you have the option of following the terms and conditions either of that version or of any later version published by the Free Software Foundation. If the Program does not specify a version number of this License, you may choose any version ever published by the Free Software Foundation.

**10.** If you wish to incorporate parts of the Program into other free programs whose distribution conditions are different, write to the author to ask for permission. For software which is copyrighted by the Free Software Foundation, write to the Free Software Foundation; we sometimes make exceptions for this. Our decision will be guided by the two goals of preserving the free status of all derivatives of our free software and of promoting the sharing and reuse of software generally.

## **NO WARRANTY**

**11.** BECAUSE THE PROGRAM IS LICENSED FREE OF CHARGE, THERE IS NO WARRANTY FOR THE PROGRAM, TO THE EXTENT PERMITTED BY APPLICABLE LAW. EXCEPT WHEN OTHERWISE STATED IN WRITING THE COPYRIGHT HOLDERS AND/OR OTHER PARTIES PROVIDE THE PROGRAM "AS IS" WITHOUT WARRANTY OF ANY KIND, EITHER EXPRESSED OR IMPLIED, INCLUDING, BUT NOT LIMITED TO, THE IMPLIED WARRANTIES OF MERCHANTABILITY AND FITNESS FOR A PARTICULAR PURPOSE. THE ENTIRE RISK AS TO THE QUALITY AND PERFORMANCE OF THE PROGRAM IS WITH YOU. SHOULD THE PROGRAM PROVE DEFECTIVE, YOU ASSUME THE COST OF ALL NECESSARY SERVICING, REPAIR OR CORRECTION.

**12.** IN NO EVENT UNLESS REQUIRED BY APPLICABLE LAW OR AGREED TO IN WRITING WILL ANY COPYRIGHT HOLDER, OR ANY OTHER PARTY WHO MAY MODIFY AND/OR REDISTRIBUTE THE PROGRAM AS PERMITTED ABOVE, BE LIABLE TO YOU FOR DAMAGES, INCLUDING ANY GENERAL, SPECIAL, INCIDENTAL OR CONSEQUENTIAL DAMAGES ARISING OUT OF THE USE OR INABILITY TO USE THE PROGRAM (INCLUDING BUT NOT LIMITED TO LOSS OF DATA OR DATA BEING RENDERED INACCURATE OR LOSSES SUSTAINED BY YOU OR THIRD PARTIES OR A FAILURE OF THE PROGRAM TO OPERATE WITH ANY OTHER PROGRAMS), EVEN IF SUCH HOLDER OR OTHER PARTY HAS BEEN ADVISED OF THE POSSIBILITY OF SUCH DAMAGES.

## **END OF TERMS AND CONDITIONS**