

TLE(X) 0.5-4.5, TBE(X) 0.5-4.5, TOE(X) 0.5-4.5

Einbau-Anleitung • Installation instructions • Instructions de montage
Istruzioni per il montaggio • Instrucciones de instalación

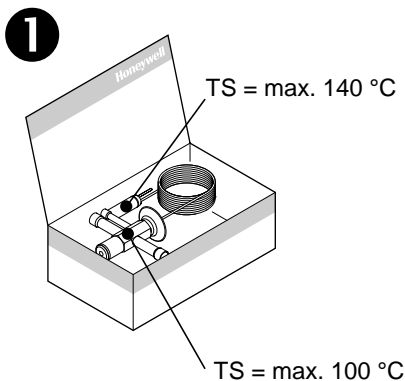

PS = max. 29 bar
P_{test} = max. 32 bar
 $\Delta t_{oh, stat} \approx 3 \text{ K}$

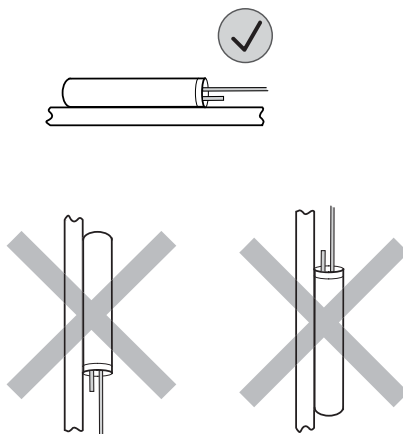
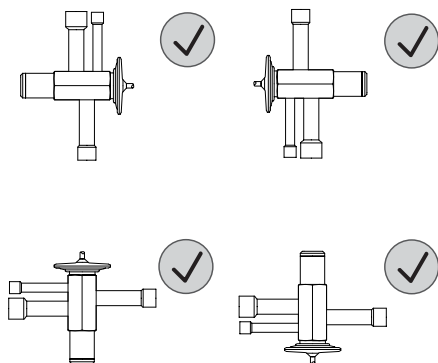
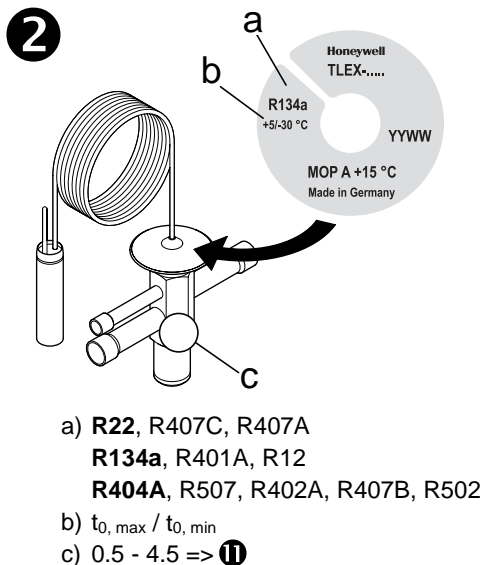

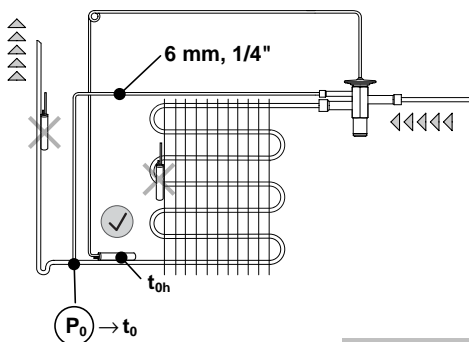
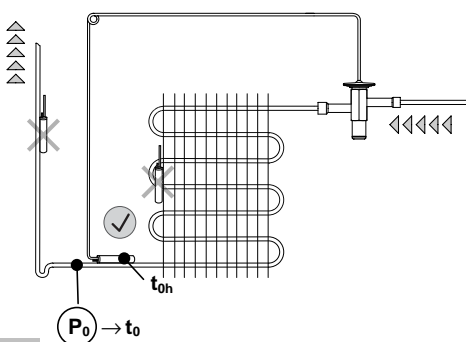
4**TLEX, TBEX, TOEX****TLE, TBE, TOE**

$$\Delta t_{0h} = t_{0h} - t_0$$

$$\Delta t_{0h} \neq \text{ok} \Rightarrow \text{Ⓢ}$$

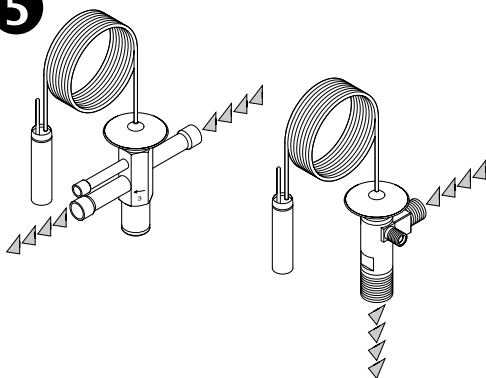
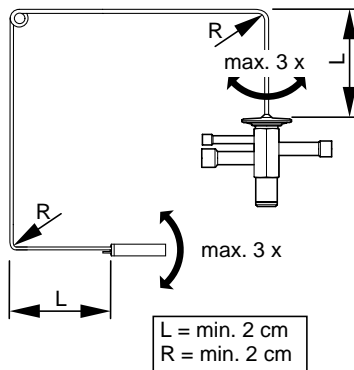
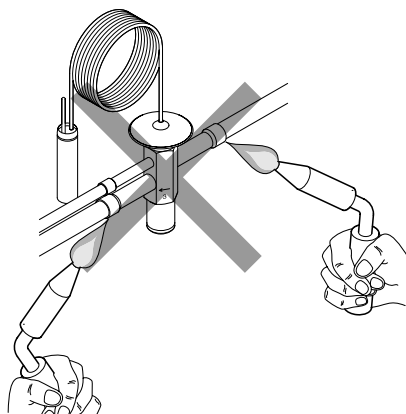
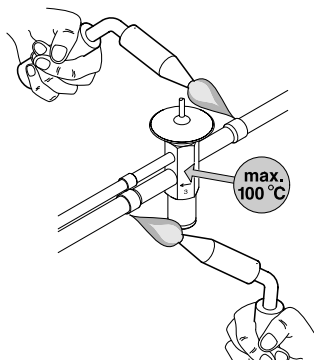
5**6****7****A.) TLE, TLEX**

7

B.) TOE(X)-D

TBE(X)-D

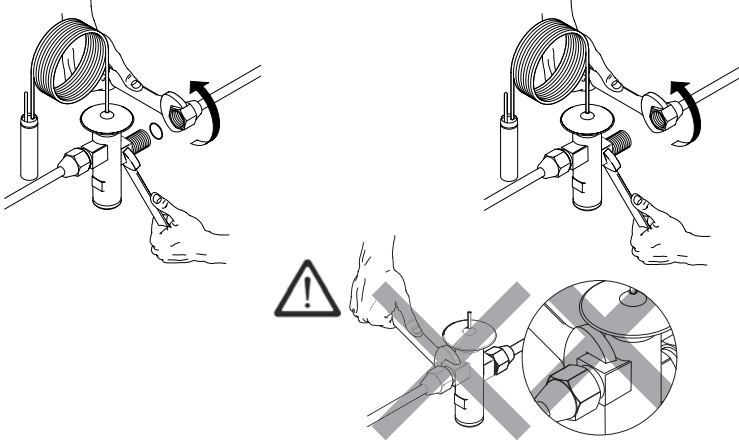

7

C.) TOEX-W (TBEX-W)

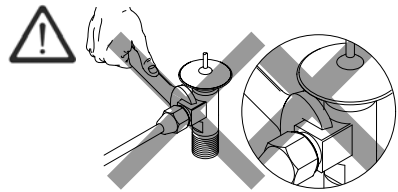
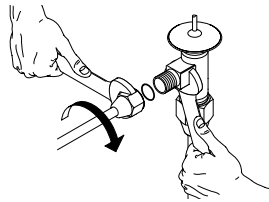
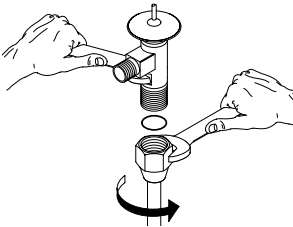

8

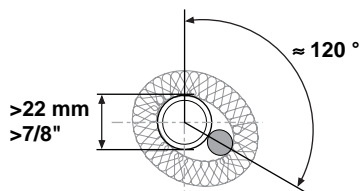
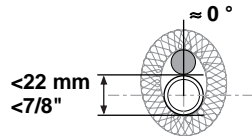
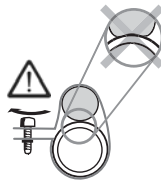
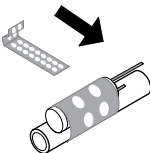
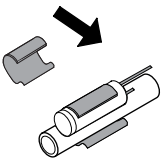

9

TLE(X), TBE(X)-D, TOE(X)-D

R22 → R407C, R407A

R134a → R401A, R12

R404A → R507, R402A, R407B, R502

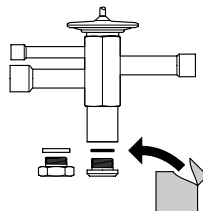
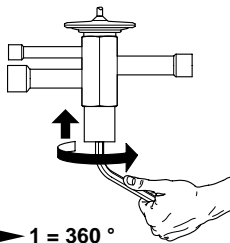
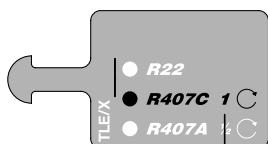
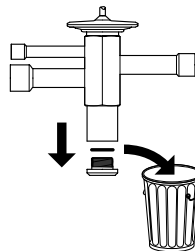
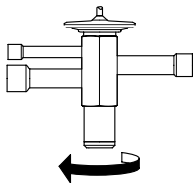

ZE-00017 = Cu-Ring
ZE-00015 = O-Ring

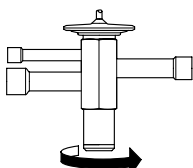

= 8 Nm

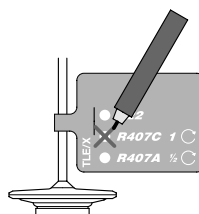

= 20 Nm

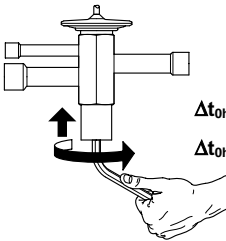
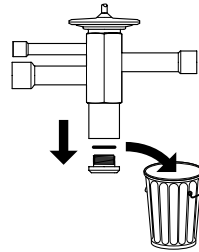
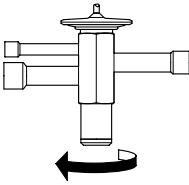

10

$\Delta t_{0h} \neq ok$



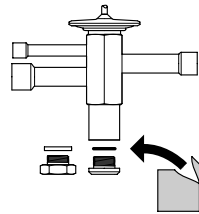

$\Delta t_{0h} \uparrow$  360° $\approx 0,25 \text{ bar}$
 $\Delta t_{0h} \downarrow$  $\approx 0,30 \text{ bar (R410A)}$
MOP +15...-20 °C

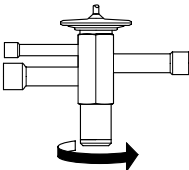

ZE-00017 = Cu-Ring
ZE-00015 = O-Ring



 = 8 Nm
 = 20 Nm



$\Delta t_{0h} \uparrow \Rightarrow \text{MOP} \downarrow$
 $\Delta t_{0h} \downarrow \Rightarrow \text{MOP} \uparrow$

11

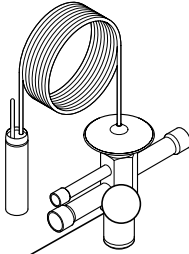

	Q ₀ [kW]										
	R22	R407C	R407A	R134a	R401A	R12	R404A	R507	R402A	R407B	R502
0.5	0.99	0.97	0.96	0.69	0.79	0.53	0.69	0.68	0.72	0.79	0.65
0.7	1.4	1.3	1.3	0.95	1.1	0.74	0.98	0.98	0.99	1.0	0.91
1.0	2.0	2.0	1.9	1.4	1.6	1.0	1.4	1.4	1.5	1.5	1.4
1.5	3.2	3.1	3.1	2.2	2.5	1.8	2.3	2.3	2.4	2.5	2.2
2.0	4.0	3.9	3.9	2.9	3.3	2.2	2.9	2.8	3.0	3.2	2.8
2.5	5.8	5.7	5.6	4.0	4.7	3.1	4.1	4.1	4.3	4.6	4.0
3.0	9.3	9.1	9.0	6.6	7.4	5.6	6.6	6.6	6.7	7.2	6.5
3.5	12.2	12.0	11.9	8.7	9.8	6.4	8.7	8.6	8.9	9.5	8.7
4.5	17.0	16.7	16.5	11.8	13.8	9.9	12.1	12.0	12.5	13.3	11.5

t₀ = +4 °C, t_c = +38 °C, Δt_{c2u} = 1 K

Honeywell

Automation and Control Solutions

Honeywell GmbH

Hardhofweg • 74821 Mosbach / Germany

Phone: +49 (0) 62 61 / 81-475

Fax: +49 (0) 62 61 / 81-461

E-Mail: Cooling.Mosbach@honeywell.com

www.honeywell-cooling.com

Manufactured for and on behalf of the
 Environment and Combustion Controls
 Division of Honeywell Technologies Sàrl,
 Ecublens, Route du Bois 37, Switzerland
 by its authorised representative Honeywell GmbH